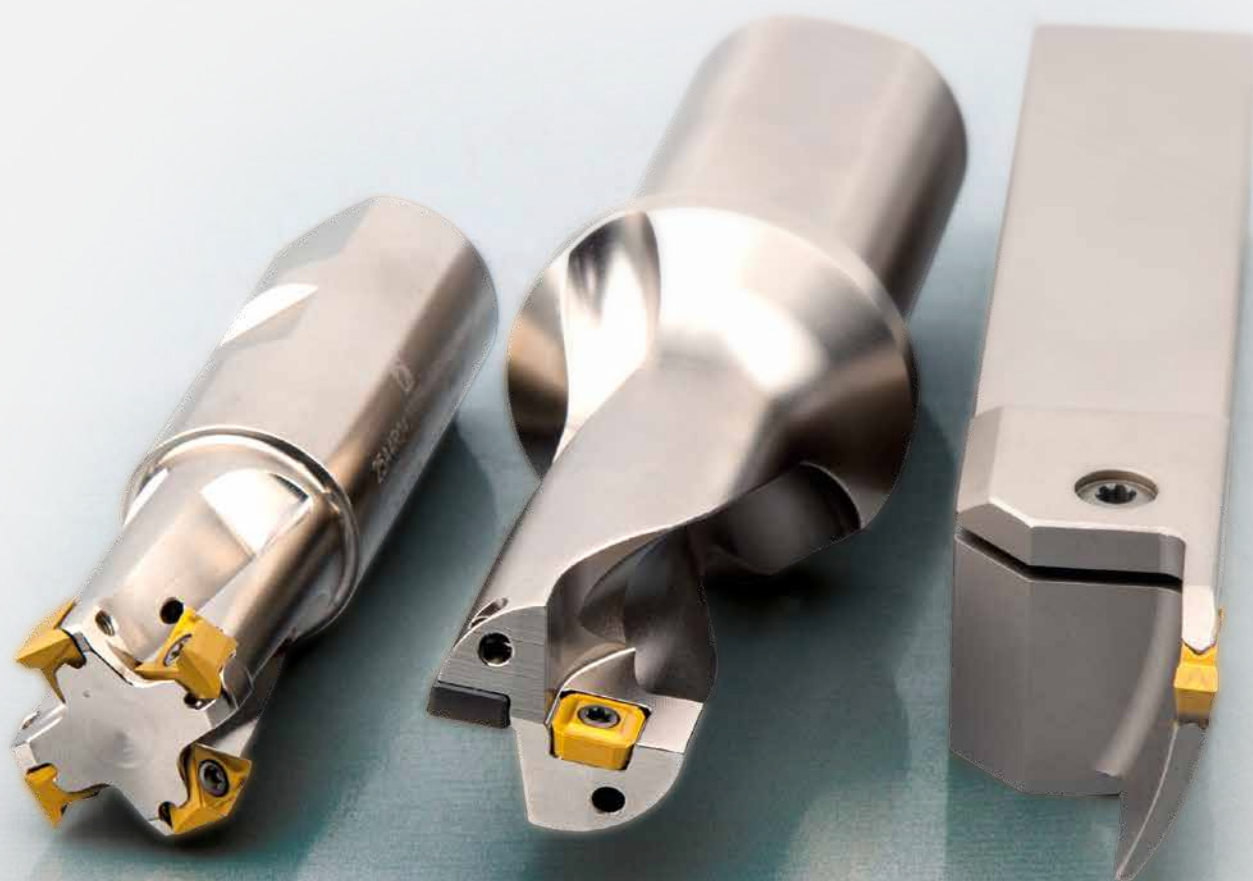


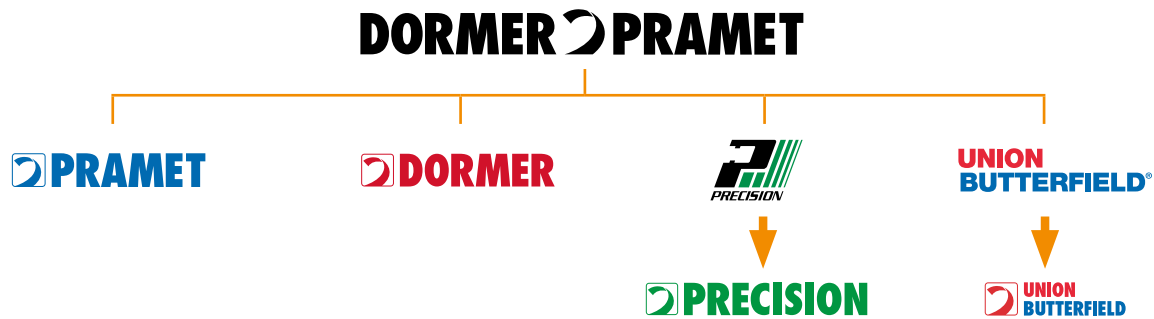
# DORMER PRAMET

CATALOG  
CATÁLOGO  
CATALOGUE



 PRAMET

## 2020 VISION: CLARITY IN BRAND ALIGNMENT



We acknowledge a unified appearance of our product logos will show that Dormer Pramet manufactures all our product brands – Precision Twist Drill, Dormer, Union Butterfield and Pramet.

In 2020, we are educating on the evolution of the Precision Twist Drill and Union Butterfield logos. Beginning in 2021, these logos will adopt the chip - our unifying symbol across the company and product brands that communicates our promise of quality manufacturing, products and logistics.

The Union Butterfield and Precision Twist Drill brands are pioneer brands for the North American marketplace. Since launching in 1885 and 1952, respectively, they represent a legacy of local support and quality tooling. Adding the chip to these logos aligns all brands visually and confirms to customers that when they add any of our tools to their shop, they add our entire team, including quality production facilities, reliable delivery and nationwide support.

## FOLLOW US!



LIKE



SHARE




TWEET




COMMENT




**TURNING  
TORNEADO  
TOURNAGE**

 T1 – T370


**MILLING  
FRESADO  
FRAISAGE**

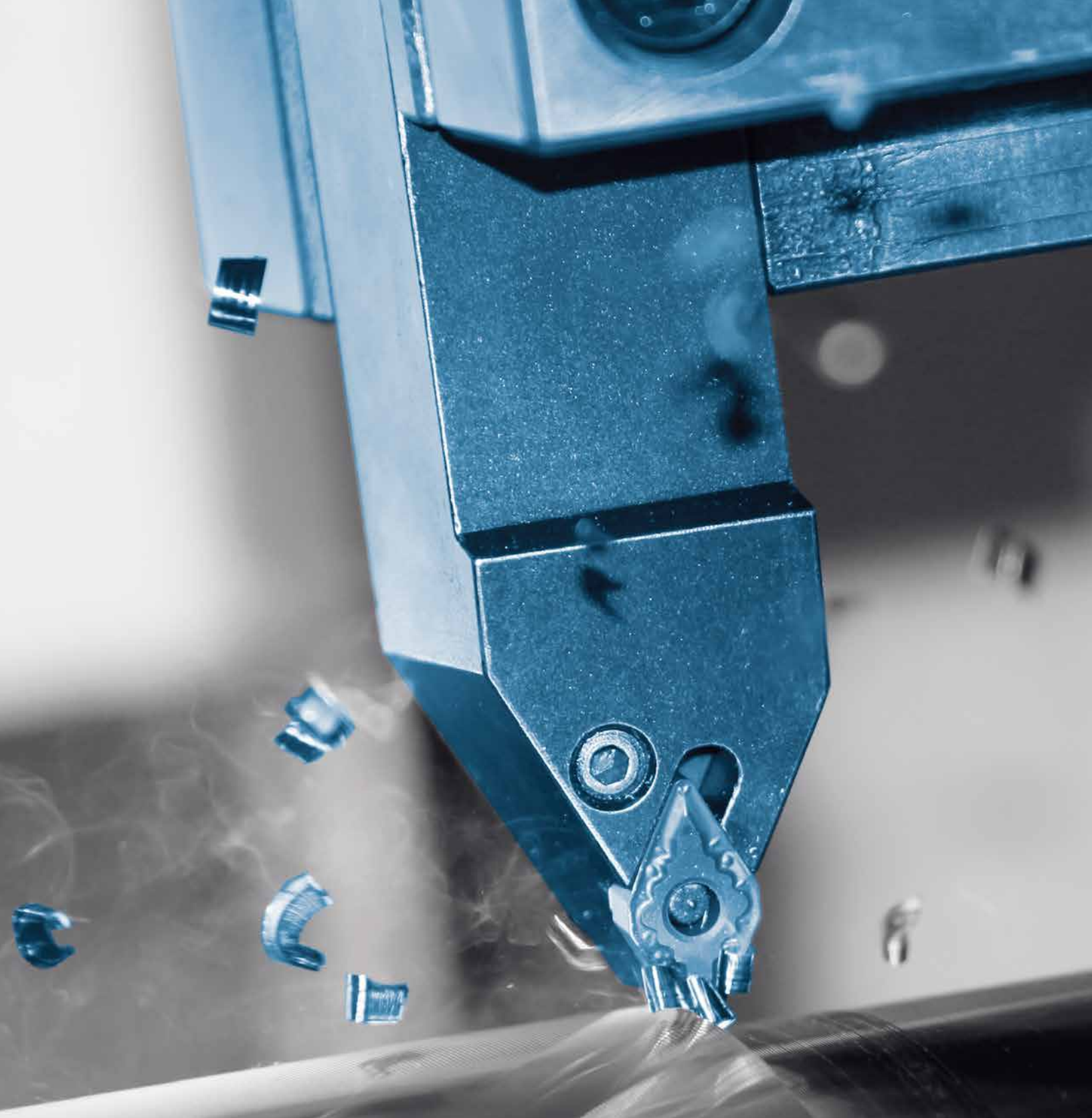
 M1 – M244

**HOLE-MAKING  
TALADRADO  
PERÇAGE – ALÉSAGE**

 D1 – D37

**WORKPIECE MATERIALS CLASSIFICATION  
CLASIFICACIÓN DE MATERIALES  
CLASSIFICATION DES MATÉRIAUX À USINER**



 X1 – X58



**TURNING  
TORNEADO  
TOURNAGE**

INSTRUCTIONS / INSTRUCCIONES INSTRUCTIONS		 T4 – T12
NAVIGATORS / NAVEGADORES NAVIGATEURS		 T13 – T35
INSERTS / PLAQUITAS PLAQUETTES	INSERTS / PLAQUITAS PLAQUETTES	 T36 – T128
	CERAMICS, CBN, PCD INSERTS / PLAQUITAS DE CERÁMICA, CBN, PCD PLAQUETTES CÉRAMIQUES, CBN, PCD	 T129 – T146
	PARTING & GROOVING INSERTS / PLAQUITAS PARA TRONZADO Y RANURADO PLAQUETTES POUR TRONÇONNAGE ET GORGES	 T147 – T155
	THREADING INSERTS / PLAQUITAS PARA ROSCADO PLAQUETTES DE FILETAGE	 T156 – T180
TOOLS / HERRAMIENTAS OUTILS	TOOLS - EXTERNAL / HERRAMIENTAS - EXTERIORES OUTILS - EXTÉRIEUR	 T181 – T213
	TOOLS - INTERNAL / HERRAMIENTAS - INTERIORES OUTILS - INTÉRIEUR	 T214 – T227
	PARTING OFF & GROOVING / TRONZADO Y RANURADO OUTILS POUR TRONÇONNAGE ET GORGES	 T228 – T248
	THREADING TOOLS / HERRAMIENTAS DE ROSCADO OUTILS DE FILETAGE	 T249 – T253
TECHNICAL INFORMATION / SECCIÓN TÉCNICA PARTIE TECHNIQUE		 T254 – T370

					
CCGT	T36	RCMT	T76	TN STACME EXT	T178
CCGW CBN	T138	RCMW	T78	TN STACME INT	T178
CCMT	T38	RCMX	T78	TN TR EXT	T174
CCMW	T43	RNGN CER	T133	TN TR INT	T175
CNGA CBN	T139	RNMG	T80	TN TR-S EXT	T175
CNGA CER	T130	SCGT	T81	TN TR-S INT	T176
CNGG	T44	SCMT	T82	TN UN EXT	T166
CNGN CER	T130	SCMW	T84	TN UN INT	T167
CNGX CER	T131	SNGA CER	T134	TN UNJ EXT	T168
CNMA	T44	SNGN CER	T134	TN W EXT	T169
CNMG	T45	SNGX CER	T135	TN W INT	T170
CNMM	T54	SNMA	T85	TN ZZ EXT	T158
CPGW PCD	T144	SNMG	T86	TN ZZ INT	T159
DCGT	T57	SNMM	T91	TNGA CBN	T142
DCGW CBN	T140	SPGN CER	T135	TNGA CER	T136
DCGW PCD	T145	SPMR	T94	TNGN CER	T136
DCMT	T58	SPU	T95	TNMA	T100
DCMW	T61	TCGT	T96	TNMG	T101
DCMW PCD	T145	TCGW CBN	T141	TNMM	T106
DNGA CBN	T140	TCMT	T97	TPGN CER	T137
DNGA CER	T131	TCMW	T99	TPMR	T107
DNGN CER	T132	TN 55° PP EXT	T171	TPU	T108
DNMA	T62	TN 55° PP INT	T172	VBGW CBN	T142
DNMG	T62	TN 60° PP EXT	T164	VBMT	T108
DNMM	T69	TN 60° PP INT	T164	VCGT	T111
ECGT	T70	TN 60°-S PP EXT	T165	VCGW	T113
ECMT	T71	TN 60°-S PP INT	T165	VCGX	T114
ECMW	T71	TN ACME EXT	T176	VCMT	T115
EPMT	T72	TN ACME INT	T177	VCMW	T116
GL. D	T148	TN BSPT EXT	T172	VCMW PCD	T146
KNUX	T72	TN BSPT INT	T173	VNGA CBN	T143
LCMF 13	T149	TN M EXT	T160	VNGA CER	T137
LCMF 16, LCMF 30	T150	TN M INT	T161	VNMG	T116
LCMF 20	T152	TN MJ EXT	T163	WCGT	T119
LCMR 13	T153	TN NPT EXT	T173	WCMT	T120
LCMR 16, LCMR 30	T153	TN NPT INT	T174	WNGA CBN	T143
LFMX	T154	TN R EXT	T157	WNGA CER	T138
RCGT	T74	TN R INT	T157	WNMA	T121
RCGX CER	T133	TN RD EXT	T179	WNMG	T121
RCMH	T75	TN RD INT	T180	WNMM	T128

			
DCKN(RL) EXT	T184	SWLC(RL) INT	T227
DCLN(RL) EXT	T185	GFK(RL) EXT	T232
DCRN(RL) EXT	T187	GFI(RL) EXT	T233
DDJN(RL) EXT	T188	GFM(RL) EXT	T234
DDPNN EXT	T189	GFIR-L AXIAL	T235
DRSNR EXT	T190	GFIL-R AXIAL	T237
DSDNN EXT	T191	GFIR-R AXIAL	T239
DSKN(RL) EXT	T192	GFIL-L AXIAL	T240
DSRN(RL) EXT	T193	GGI(RL)-90 AXIAL	T241
DSSN(RL) EXT	T195	GG.(RL) INT	T242
DTGN(RL) EXT	T196	GLS B	T231
DTJN(RL) EXT	T197	GLSF(RL) EXT	T230
DTTN(RL) EXT	T198	MS-EN	T243
DVJN(RL) EXT	T199	XLCCN 25 BS	T244
DWLN(RL) EXT	T200	XLCF(NRL) BS	T245
PRDCN EXT	T201	XLCCN B	T246
PRSC(RL) EXT	T202	XLCFN B	T247
SCLC(RL) EXT	T203	DU. D	T248
SDJC(RL) EXT	T204	SE(RL)	T250
SDPCN EXT	T205	SE(RL)-S	T251
SRDCN EXT	T206	SI(RL)	T252
SRSC(RL) EXT	T207	SI(RL)-S	T253
SSDCN EXT	T208		
STGC(RL) EXT	T209		
SVHB(C)(RL) EXT	T210		
SVJB(C)(RL) EXT	T211		
SVVB(C)N EXT	T212		
SWLC(RL) EXT	T213		
DCLN(RL) INT	T215		
DDUN(RL) INT	T216		
DTFN(RL) INT	T217		
DWLN(RL) INT	T218		
SCLC(RL) INT	T219		
SDQC(RL) INT	T220		
SDUC(RL) INT	T221		
SDUC(RL)-E INT	T222		
SDZC(RL) INT	T223		
STFC(RL) INT	T224		
SVQB(C)(RL) INT	T225		
SVUB(C)(RL) INT	T226		



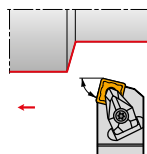
**1 DCRN(RL) EXT**

**P M K N S H 2**

**D 3**



**4**



**5**



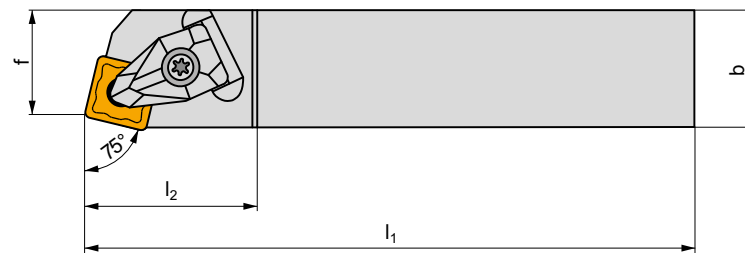
**7**



**8**



**6**



**9**

ANSI	h=h <sub>1</sub>	b	f	l <sub>1</sub>	l <sub>2</sub>	λ°	γ°	lbs	IGI	DCS	IAT
DCRNR/L 12 4B	.750	.750	.855	4.500	1.350	-6	-6	.88	IGI005	DC12	IAT001
DCRNR/L 16 4D	1.000	1.000	1.048	6.000	1.350	-6	-6	1.54	IGI005	DC12	IAT001
DCRNR/L 20 <b>10</b>	1.250	1.250	1.292	<b>11</b>	1.350	-6	-6	<b>12</b>	<b>13</b>	<b>14</b>	<b>15</b>
DCRNR/L 20 6D	1.250	1.250	1.291	6.000	1.820	-6	-6	2.76	IGI007	DC19	-
DCRNR/L 24 6D	1.500	1.500	1.697	6.000	1.820	-6	-6	4.96	IGI007	DC19	-

IGI	CN..
IGI005	CN.. 43.
IGI006	<b>16</b> CN.. 54.
IGI007	CN.. 64.

DCS	Nm	DCS	US	FLAG	
DC12	DCS 12	3.9	<b>17</b> DCS 234-01	US 2002-T15P	FLAG T15P/3.5
DC16	DCS 16	6.4	DCS 234-03	US 2007-T20P	-
DC19	DCS 19	6.4	DCS 236-01	US 2007-T20P	-

IAT	CN..	DCS
IAT001	CN.. 45.	-
IAT005	CN.. 55.	DCS 234-02
IAT001	CER CN.N 43.	DCS 12C4
IAT001	CER CN.A 43.	<b>18</b> DCS 12C2
IAT005	CER CN.N 54.	DCS 16C4
IAT005	CER CN.A 54.	DCS 16C2

Typical page with turning holder displayed - specific page details will differ.

Típica página con un portaherramientas de torneado mostrado - Los detalles específicos en cada página son diferentes.

Page typique illustrant un porte-outil de tournage - La page finale peut varier avec des détails spécifiques.

1	Designation of turning holder Designación Désignation du porte-outil
2	Material group recommendations Gupos de material Groupes de matériaux pour lesquels l'outil est indiqué
3	Clamping system of insert Sistema de fijación de la plaquita Système de fixation de la plaquette
4	Illustrative picture <sup>1)</sup> Esquema ilustrativo <sup>1)</sup> Image pour illustration <sup>1)</sup>
5	Workpiece profile Formas de pieza posibles Formes possibles de la pièce
6	Schematic drawing of tool Esquema de la herramienta Dessin schématique de l'outil
7	Achievable quality of surface Calidad superficial alcanzable État de surface pouvant être atteint
8	Character of cut/working conditions Condiciones de corte/trabajo Caractère de la coupe/conditions de travail
9	Possible applications Posibilidades tecnológicas de la herramienta Possibilités technologiques de l'outil

10	ANSI code of holder Codificación ANSI para portaherramientas Code ANSI de l'outil
11	Dimensions [in] and angles <sup>2)</sup> [°] of holder Dimensiones [in] y ángulos <sup>2)</sup> [°] de portaherramientas Dimensions [in] et angles <sup>2)</sup> [°] de l'outil
12	Weight [lbs] Peso [lbs] Poids [lbs]
13	Group of compatible inserts <sup>3)</sup> Grupo de plaquetas compatibles <sup>3)</sup> Groupe de plaquettes compatibles <sup>3)</sup>
14	Group of spare parts <sup>3), 4)</sup> Grupo de repuestos <sup>3), 4)</sup> Groupe de pièces de rechange <sup>3), 4)</sup>
15	Group of accessories <sup>3), 4)</sup> Grupo de accesorios especiales <sup>3), 4)</sup> Groupe d'accessoires spéciaux <sup>3), 4)</sup>
16	Compatible inserts Plaquetas Plaquettes compatibles
17	Spare parts Repuestos Pièces de rechange
18	Special accessories Accesorios especiales Accessoires spéciaux

<sup>1)</sup> Turning holder is primarily displayed in its right design (R)

<sup>2)</sup>  $\gamma_o$  = orthogonal rake angle (see technical pages)  
 $\lambda_s$  = inclination angle of main cutting edge (see technical pages)

<sup>3)</sup> Code of Group of compatible inserts, spare parts and special accessories is used only for purposes of this catalogue. It cannot be used for orders.

<sup>4)</sup> Spare parts and special accessories icons are designed schematically for ease of understanding. They aren't included in list of icons. Screws are, in some cases, completed with info on torque value in Nm, length of screw and size of thread.

<sup>1)</sup> L'illustration représente principalement un outil à droite (R)

<sup>2)</sup>  $\gamma_o$  = angle de coupe orthogonal (voir partie technique)  
 $\lambda_s$  = angle d'inclinaison de l'arête de coupe principale (voir partie technique)

<sup>3)</sup> Le code du groupe de plaquettes compatibles, des pièces de rechange et des accessoires spéciaux n'est utilisable que pour naviguer dans ce catalogue. Il ne peut pas être utilisé pour des commandes.

<sup>4)</sup> Les icônes des pièces de rechange et des accessoires spéciaux sont schématisées pour une compréhension simple. Elles ne sont pas incluses dans la liste des icônes. Les vis, dans certains cas, sont complétées avec l'information du couple de serrage (Nm), de la longueur de vis et du diamètre du filetage.

<sup>1)</sup> Los portaherramientas mostrados son de diseño a derecha (R)

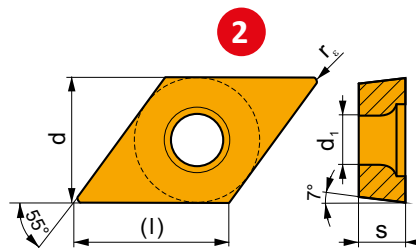
<sup>2)</sup>  $\gamma_o$  = ángulo ortogonal (ver sección técnica)  
 $\lambda_s$  = ángulo de desprendimiento del filo de corte (ver sección técnica)

<sup>3)</sup> El código del grupo de plaquetas compatibles, repuestos y accesorios especiales se utiliza sólo para el uso de este catálogo. No puede ser utilizado para pedidos.

<sup>4)</sup> Los iconos de los repuestos y accesorios especiales están diseñados esquemáticamente para su fácil comprensión. No están incluidos en la lista de iconos. En algunos casos, la información de los tornillos se completa con el par de apriete en Nm, longitud y tamaño de rosca.

**1 DCMW**

	d	d <sub>1</sub>	l	s
21.5	.250	.110	.307	.094
32.5	.375	.173	.457	.156





i	ANSI	Material	P	M	K	N	S	H	? (Chip)	Drop (Fluid)	r <sub>c</sub>	f <sub>min</sub>	f <sub>max</sub>	a <sub>p min</sub>	a <sub>p max</sub>
	DCMW 21.50.5	T5305	<input type="checkbox"/>	<input type="checkbox"/>	<input checked="" type="checkbox"/>	<input type="checkbox"/>	<input type="checkbox"/>	<input checked="" type="checkbox"/>	●	+	.008	.002	.004	.008	.079
		T5315	<input checked="" type="checkbox"/>	<input type="checkbox"/>	<input checked="" type="checkbox"/>	<input type="checkbox"/>	<input type="checkbox"/>	<input type="checkbox"/>	●	+	.008	.002	.004	.008	.079
		T6310	<input checked="" type="checkbox"/>	<input type="checkbox"/>	<input checked="" type="checkbox"/>	<input type="checkbox"/>	<input type="checkbox"/>	<input checked="" type="checkbox"/>	●	+	.008	.002	.004	.008	.079
	DCMW 32.51	T5305	<input type="checkbox"/>	<input type="checkbox"/>	<input checked="" type="checkbox"/>	<input type="checkbox"/>	<input type="checkbox"/>	<input checked="" type="checkbox"/>	●	+	.016	.004	.008	.016	.079
		T5315	<input checked="" type="checkbox"/>	<input type="checkbox"/>	<input checked="" type="checkbox"/>	<input type="checkbox"/>	<input type="checkbox"/>	<input type="checkbox"/>	●	+	.016	.004	.008	.016	.079
		T6310	<input checked="" type="checkbox"/>	<input type="checkbox"/>	<input checked="" type="checkbox"/>	<input type="checkbox"/>	<input type="checkbox"/>	<input checked="" type="checkbox"/>	●	+	.016	.002	.008	.016	.079
	DCMW 32.52	T5305	<input type="checkbox"/>	<input type="checkbox"/>	<input checked="" type="checkbox"/>	<input type="checkbox"/>	<input type="checkbox"/>	<input checked="" type="checkbox"/>	●	+	.031	.004	.014	.031	.114
		T5315	<input checked="" type="checkbox"/>	<input type="checkbox"/>	<input checked="" type="checkbox"/>	<input type="checkbox"/>	<input type="checkbox"/>	<input type="checkbox"/>	●	+	.031	.004	.014	.031	.114
		T6310	<input checked="" type="checkbox"/>	<input type="checkbox"/>	<input checked="" type="checkbox"/>	<input type="checkbox"/>	<input type="checkbox"/>	<input checked="" type="checkbox"/>	●	+	.031	.002	.014	.031	.114

<b>1</b>	Designation of insert Designación Désignation de la plaquette
<b>2</b>	Schematic drawing of insert Esquema de la plaquita Dessin schématique de la plaquette
<b>3</b>	Table with insert sizes [in] Tabla con tamaños de plaquita [in] Tableau des tailles de plaquettes [in]
<b>4</b>	Icons - specific features, cutting edge type and picture of representative insert Iconos - características específicas, tipo de filo de corte y foto representativa de la plaquita Ícônes - caractéristiques spécifiques, type d'arête de coupe et photo d'une plaquette représentative
<b>5</b>	Profile of main cutting edge Perfil del filo de corte Profil de l'arête de coupe principale
<b>6</b>	ANSI code of insert Codificación ANSI de plaquitas Code ANSI de la plaquette








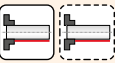
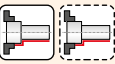
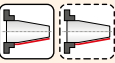
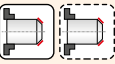
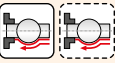
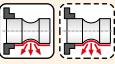
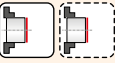
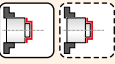
<b>7</b>	Grade Calidad Nuance
<b>8</b>	Application area of insert Área de aplicación Domaine d'application de la plaquette
<b>9</b>	Suitability of insert use with respect to specific working conditions Uso de plaquitas en función de las condiciones de trabajo Possibilité d'utilisation de la plaquette en fonction des conditions de travail spécifiques
<b>10</b>	Influence of use of cutting fluids in continual cut Influencia del uso de fluidos de corte en corte continuo Influence de l'usage du fluide en coupe continue
<b>11</b>	Insert radii [in] Radio de plaquita [in] Rayon de plaquette [in]
<b>12</b>	Maximum range of cutting depth [in] and feed [in/rev] Gama máxima de profundidad de corte [in] y avance [in/rot] Plage de profondeurs de passe [in] et d'avances [in/tr]

**ICONS AND SYMBOLS - TURNING**  
**ICONOS Y SÍMBOLOS - TORNEADO**  
**ICÔNES ET SYMBOLES - TOURNAGE**

-  Priority use  
 Uso prioritario  
 Utilisation prioritaire
-  Possible use  
 Uso posible  
 Utilisation possible

Icon absence - tool is not recommended for specific operation or group of materials or it does not have specific feature  
 Ausencia de icono - la herramienta no se recomienda para la operación específica, grupo de materiales o no tiene ninguna característica específica  
 Absence d'icône - outil non recommandé pour l'opération spécifique ou pour le groupe de matériaux ou parce qu'il ne possède pas de caractéristiques spécifiques

**Icons - turning holders / Iconos - portaherramientas de torneado**  
**icônes - Porte-outils**

<b>General features of tools / Características generales de las herramientas</b> <b>Caractéristiques principales des outils</b>			
	Material groups	Grupos de materiales	Groupe de matériaux
	Finishing – very good surface quality	Acabado - calidad superficial muy buena	Finition – très bonne qualité de surface
	Medium machining – good surface quality	Mecanizado medio - calidad superficial buena	Usinage moyen – bonne qualité de surface
	Roughing – unlimited surface roughness	Desbaste - rugosidad superficial ilimitada	Ébauche – Rugosité de surface non limitée
	Stable working conditions	Condiciones estables	Conditions de travail stables
	Unstable working conditions	Condiciones inestables	Conditions de travail instables
	Very unstable working conditions	Condiciones muy inestables	Conditions de travail très instables
<b>Possible applications / Posibilidades tecnológicas de la herramienta</b> <b>Possibilités technologiques des outils</b>			
	Longitudinal turning without shoulder - external	Torneado longitudinal sin escuadra - exterior	Tournage longitudinal sans épaulement - extérieur
	Longitudinal turning with shoulder - external	Torneado longitudinal con escuadra - exterior	Tournage longitudinal avec épaulement - extérieur
	Cone turning - external	Torneado cónico - exterior	Tournage conique - extérieur
	Chamfering (beveling)	Achaflanado (beveling)	Chanfreinage (biseautage)
	One directional copy turning - external	Torneado en copia unidireccional - exterior	Tournage en copiage unidirectionnel - extérieur
	Multi directional copy turning - external	Torneado en copia multidireccional - exterior	Tournage en copiage multidirectionnel - extérieur
	Face turning without shoulder	Refrentado sin escuadra	Tournage de face sans épaulement
	Face turning with shoulder	Refrentado con escuadra	Tournage de face avec épaulement

	Face copy turning	Refrentado en copia	Tournage de face en copiage
	Longitudinal turning without shoulder - internal	Torneado longitudinal sin escuadra - interior	Tournage longitudinal sans épaulement - intérieur
	Longitudinal turning with shoulder - internal	Torneado longitudinal con escuadra - interior	Tournage longitudinal sans épaulement - intérieur
	Cone turning - internal	Torneado cónico - interior	Tournage conique - intérieur
	Chamfering (beveling) in hole	Achaflanado (beveling) en interior	Chanfreinage (biseautage) dans un trou
	One directional copy turning - internal	Torneado en copia unidireccional - interior	Tournage en copiage unidirectionnel - intérieur
	Multi directional copy turning - internal	Torneado en copia multidireccional - interior	Tournage en copiage multidirectionnel - intérieur
	Machining the rear face (shoulder) from the back	Refrentado trasero	Usinage de la face arrière (épaulement) en tirant
	Chamfering (beveling) from the back	Achaflanado (beveling) trasero	Chanfreinage (biseautage) en tirant
	Face copy turning in hole	Refrentado en copia interior	Tournage de face en copiage dans un trou
	Internal shaping	Chavetero interior	Mortaisage intérieur
	Thread turning - external	Torneado de roscas - exterior	Tournage de filets - extérieur
	Thread turning - internal	Torneado de roscas - interior	Tournage de filets - intérieur
	Scarfing	Scarfing	Raclage
	Parting off	Tronzado	Tronçonnage
	Tube parting off	Tronzado de tubos	Tronçonnage de tubes
	Shallow radial groove	Ranurado radial poco profundo	Gorge radiale peu profonde
	Deep radial groove	Ranurado radial profundo	Gorge radiale profonde
	Wide radial groove (with following expansion)	Ranurado radial ancho (con torneado axial)	Large gorge radiale (avec élargissements successifs)
	Shallow axial groove	Ranurado axial poco profundo	Gorge axiale peu profonde
	Shallow and wide axial groove (with following expansion)	Ranurado axial poco profundo y ancho (con torneado radial)	Gorge axiale peu profonde et large (avec élargissements successifs)



**ICONS AND SYMBOLS - TURNING**  
**ICONOS Y SÍMBOLOS - TORNEADO**  
**ICÔNES ET SYMBOLES - TOURNAGE**

	Deep axial groove	Ranurado axial profundo	Gorge axiale profonde
	Deep and wide axial groove (with following expansion)	Ranurado axial profundo y ancho (con torneado radial)	Gorge axiale profonde et large (avec élargissements successifs)
	Face copy turning	Refrentado en copia	Tournage de face en copiage
	Internal grooving	Ranurado interior	Gorge intérieure
	Internal grooving (with following expansion)	Ranurado interior ancho (con torneado axial)	Gorge intérieure (avec élargissements successifs)
	Copy turning (multi directional machining)	Torneado en copia (mecanizado multidireccional)	Tournage en copiage (usinage multidirectionnel)
	Undercut turning	Torneado de desahogos	Tournage de dégagements
<b>Others / Otros</b> <b>Outros / Autres</b>			
	Internal supply of coolant	Refrigeración interior	Alimentation interne de liquide de refroidissement
	Group of railway cassettes	Grupo de cassettes para ferrocarril	Groupe de cassettes ferroviaires
	Group of heads for roughing	Grupo de cabezas para desbaste	Groupe de têtes d'ébauche
	Group of blades	Grupo de lamas	Groupe de lames
	Clamping torque of screw [Nm]	Par de apriete de tornillos [Nm]	Couple de serrage de la vis [Nm]

**Icons and symbols - inserts / Iconos y símbolos - plaquitas**  
**Íconos e símbolos - pastilhas / Icônes et symboles - Plaquettes**



<b>Features / Características</b> <b>Características / Caractéristiques</b>			
	First choice	Primera elección	Premier choix
	Universal wide range option	Gama completa universal	Large gamme de solutions universelles
	Thin-walled and slim workpieces	Piezas delgadas y de paredes delgadas	Paroies fines et pièces minces
	Heavy working conditions	Condiciones de trabajo pesadas	Conditions de travail très difficiles
	Large overhang	Gran voladizo	Long porte-à-faux
	High Feed Cutting	Alto avance	Usinage grande avance

	High Speed Cutting	Alta velocidad	Usinage grande vitesse
	Insert with wiper geometry	Plaquita con geometría rascadora (wiper)	Plaquette avec géométrie wiper
	For short chipping materials	Para materiales de viruta corta	Pour matériaux à copeaux courts
	For tough materials (long chipping)	Para materiales difíciles (viruta larga)	Pour matériaux tenaces (copeaux longs)
	Railway wheel machining	Mecanizado de ruedas de ferrocarril	Usinage de roues ferroviaires
	Sharp edge	Filo vivo	Arête vive
	Rounded edge	Filo redondeado	Arête arrondie
	Edge with facet	Filo con faceta	Arête avec listel
	Rounded edge with facet	Filo redondeado con faceta	Arête arrondie avec listel
	Edge with double facet	Filo con doble faceta	Arête avec double listel
	Rounded edge with double facet	Filo redondeado con doble faceta	Arête arrondie avec double listel






**Conditions of use / Condiciones de uso  
 Condições de utilização / Conditions d'utilisation**

	Main application	Aplicación principal	Applcation principale
	Secondary application	Aplicación secundaria	Applcation secondaire
	Supplementary application	Aplicación suplementaria	Applcation supplémentaire
	Stable working conditions	Condiciones estables	Conditions de travail stables
	Unstable working conditions	Condiciones inestables	Conditions de travail instables
	Very unstable working conditions	Condiciones muy inestables	Conditions de travail très instables
	Very negative effect on tool life – cooling is not recommended	Efecto muy negativo en la vida de filo - no se recomienda refrigerante	Effet très négatif sur la durée de vie de l'outil - L'arrosage n'est pas recommandé

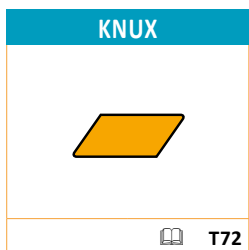
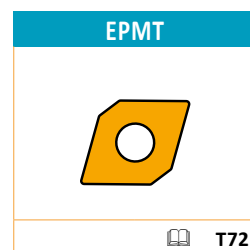
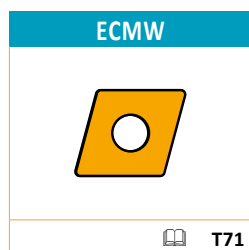
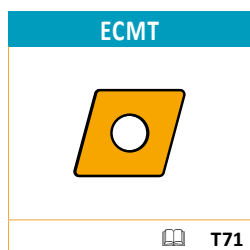
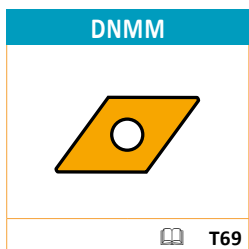
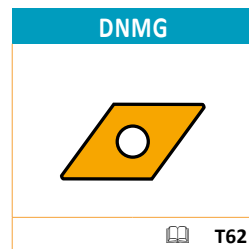
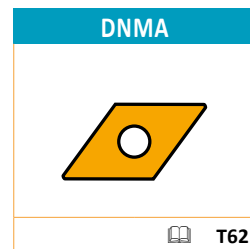
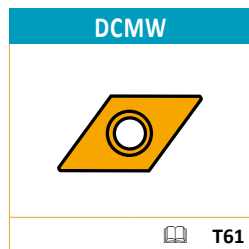
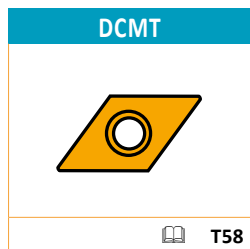
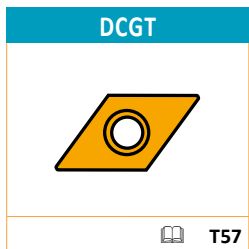
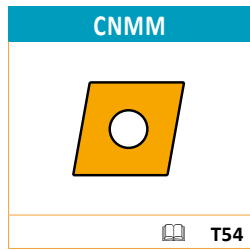
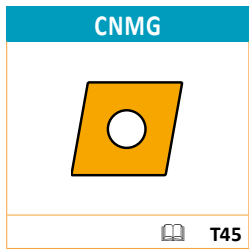
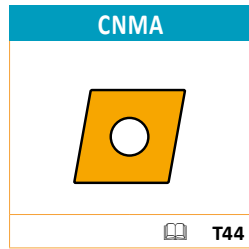
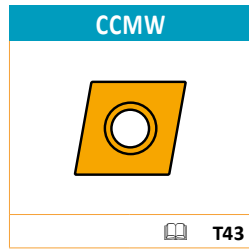
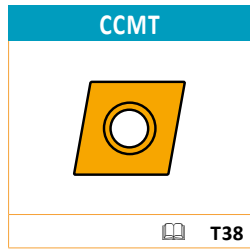
**ICONS AND SYMBOLS - TURNING**  
**ICONOS Y SÍMBOLOS - TORNEADO**  
**ICÔNES ET SYMBOLES - TOURNAGE**

--	Negative effect on tool life – cooling is not recommended	Efecto negativo en la vida de filo - no se recomienda refrigerante	Effet négatif sur la durée de vie de l'outil - L'arrosage n'est pas recommandé
-	Slightly negative effect on tool life	Efecto ligeramente negativo en la vida de filo	Effet légèrement négatif sur la durée de vie de l'outil
+ / -	Influence of cooling may be both positive and negative – decisive factor is specific working conditions	La influencia del refrigerante puede ser positiva o negativa - depende de las condiciones de trabajo	L'influence de l'arrosage peut être positive ou négative - les conditions spécifiques de travail sont le facteur décisif
+	Slightly positive effect on tool life	Efecto ligeramente positivo en la vida de filo	Effet légèrement positif sur la durée de vie de l'outil
++	Positive effect on tool life – cooling is recommended	Efecto positivo en la vida de filo - se recomienda refrigerante	Effet positif sur la durée de vie de l'outil - L'arrosage est recommandé
+++	Very positive effect on tool life – cooling is recommended	Efecto muy positivo en la vida de filo - se recomienda refrigerante	Effet très positif sur la durée de vie de l'outil - L'arrosage est recommandé
<b>Others / Otros</b> <b>Outros / Autres</b>			
	Thread pitch [mm]	Paso de rodca [mm]	Pas du filet [mm]
	Threads per in	Hilos por pulgada	Filets au pouce

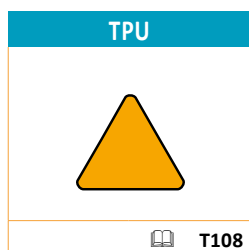
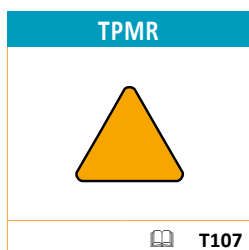
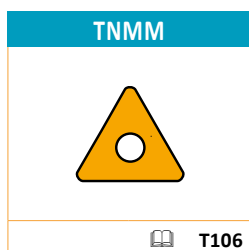
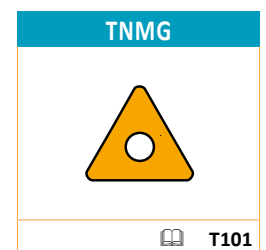
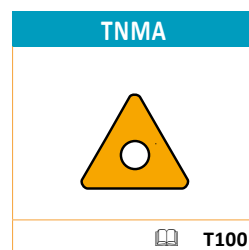
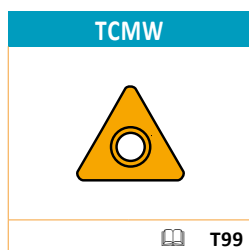
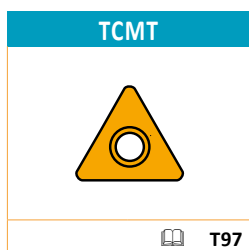
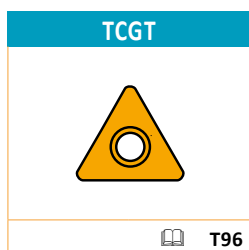
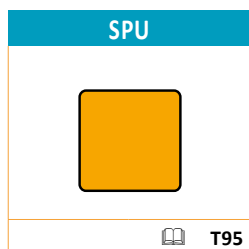
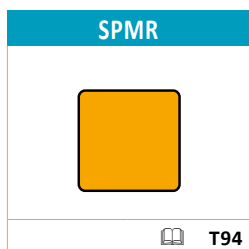
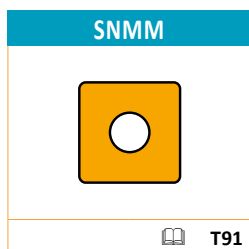
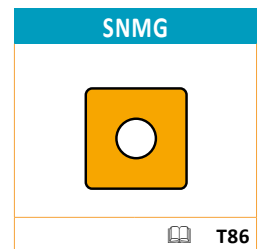
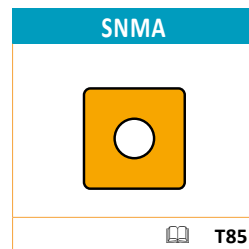
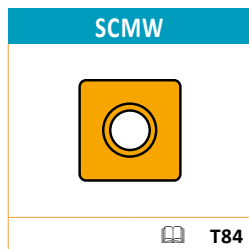
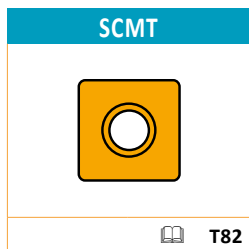
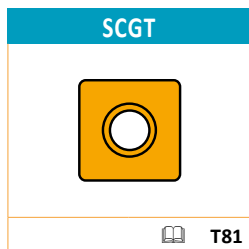
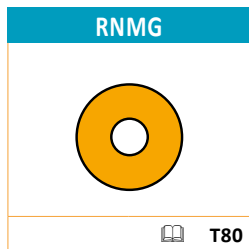
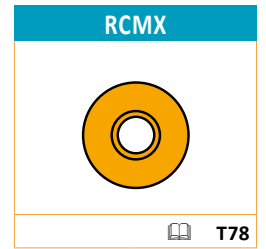
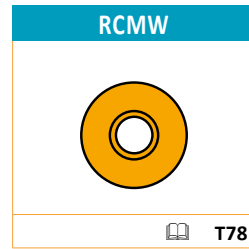
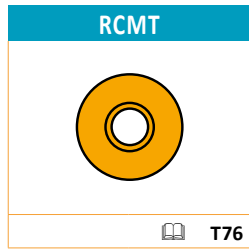
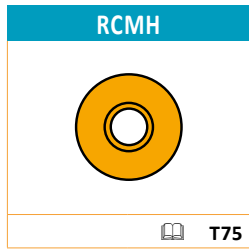
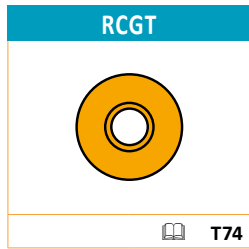
**Icons - technical pages / Iconos - sección técnica**  
**Íconos - seção técnica / Icônes - Pages techniques**

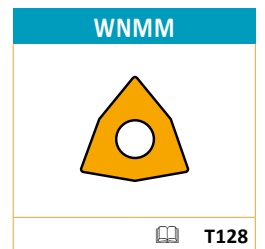
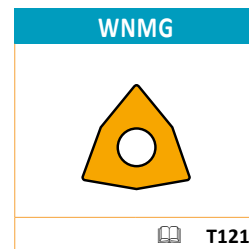
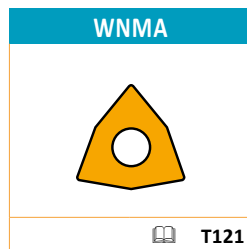
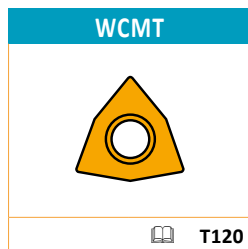
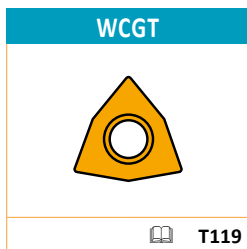
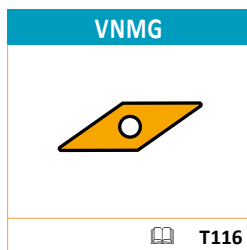
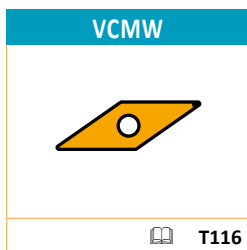
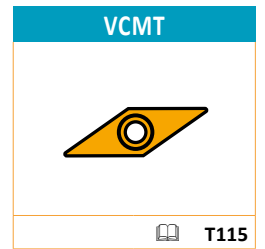
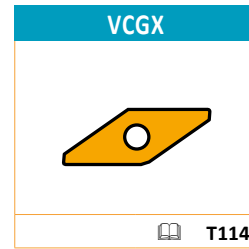
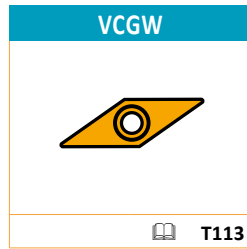
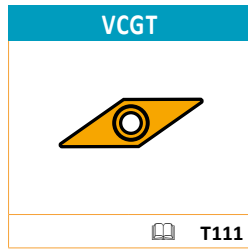
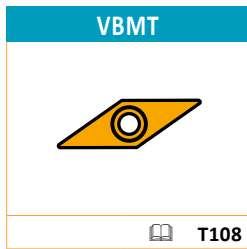
	Fine finishing	Acabado fino	Finition fine
	Finishing	Acabado	Finition
	Medium machining	Mecanizado medio	Usinage moyen
	Roughing	Desbaste	Ébauche
	Heavy roughing	Desbaste pesado	Ébauche lourde
	Parting Off and Grooving	Tronzado y Ranurado	Tronçonnage et gorges
	Threading	Roscado	Filetage
	Depth of cut [in]	Profundidad de corte [in]	Profondeur de coupe [in]

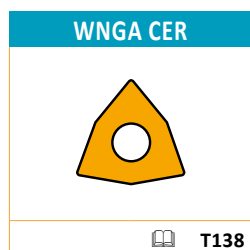
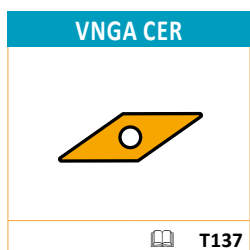
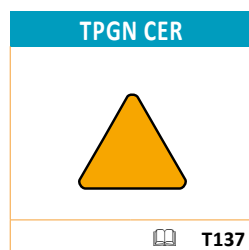
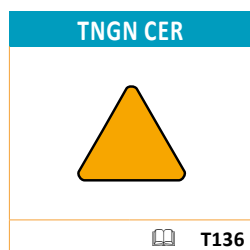
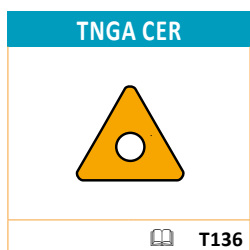
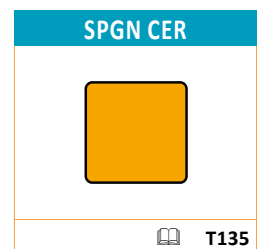
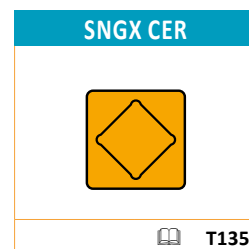
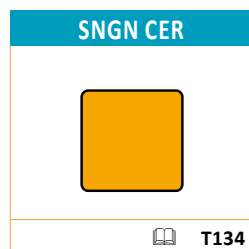
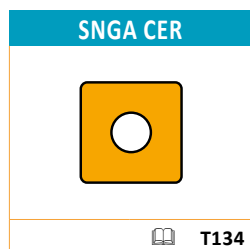
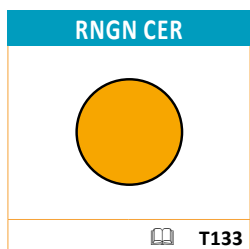
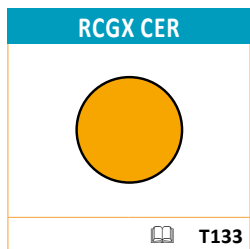
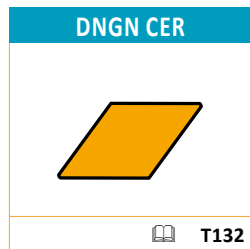
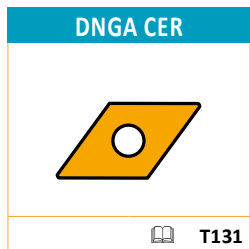
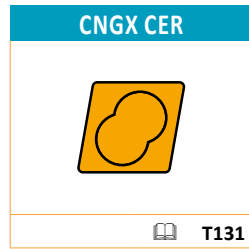
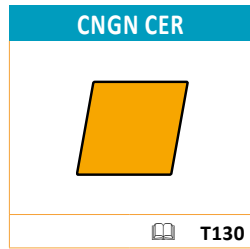
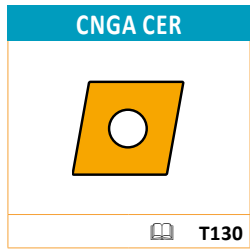
	Feed [in/rev]	Avance [in/rev]	Avance [in/rev]
	Durability [min]	Durabilidad [min]	Durabilité [min]
	Grade	Calidad	Nuance
	Coating	Recubrimiento	Revêtement
	Cutting speed	Velocidad de corte	Vitesse de coupe
	Cutting edge profile	Perfil del filo de corte	Profil de l'arête de coupe
	Cooling	Refrigerante	Arrosage
	Very high cutting speed, excellent system rigidity (stable working conditions)	Velocidad de corte muy alta (condiciones estables)	Vitesse de coupe très élevée, excellente rigidité du système (conditions de travail stables)
	High cutting speed, high system rigidity (stable working conditions)	Velocidad de corte alta, alta rigidez del sistema (condiciones estables)	Vitesse de coupe élevée, bonne rigidité du système (conditions de travail stables)
	High cutting speed, system rigidity slightly limited (depth of cut changing)	Alta velocidad de corte, rigidez del sistema ligeramente limitada (profundidad de corte variable)	Vitesse de coupe élevée, rigidité du système légèrement limitée (variation de la profondeur de coupe)
	Medium cutting speed, system rigidity limited (slightly interrupted cut)	Velocidad de corte media, rigidez del sistema limitada (corte ligeramente interrumpido)	Vitesse de coupe moyenne, rigidité du système limitée (coupe légèrement interrompue)
	Low cutting speed, low system rigidity (interrupted cut)	Velocidad de corte baja, rigidez del sistema baja (corte interrumpido)	Vitesse de coupe faible, mauvaise rigidité du système (coupe interrompue)
	Very low cutting speed, very low system rigidity (very unstable working conditions)	Velocidad de corte muy baja, rigidez del sistema muy baja (condiciones muy inestables)	Vitesse de coupe très faible, très mauvaise rigidité du système (conditions de travail très instables)



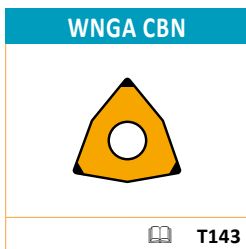
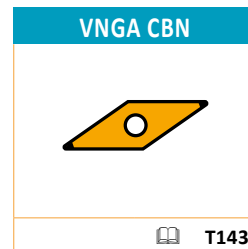
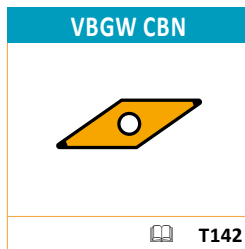
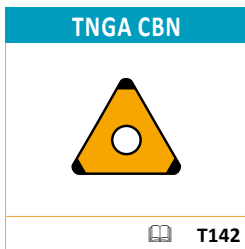
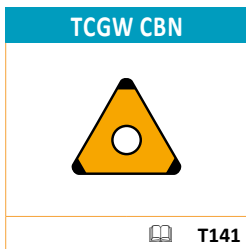
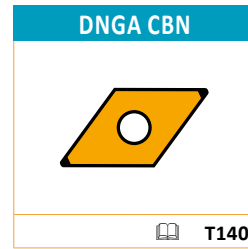
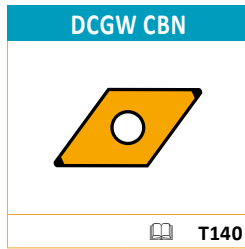
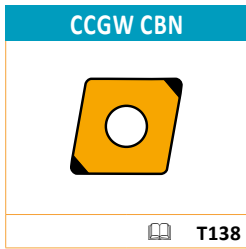




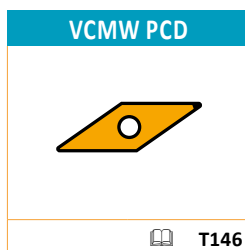
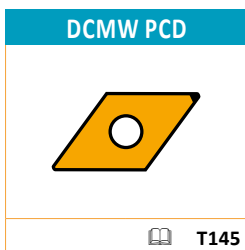
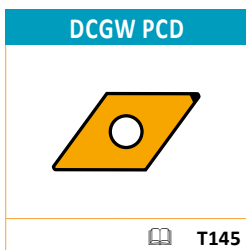




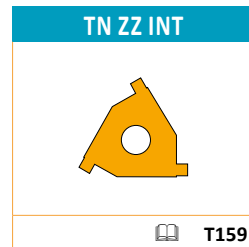
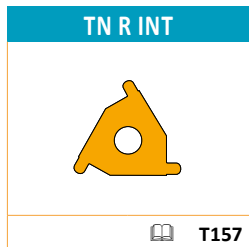
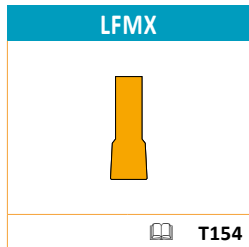
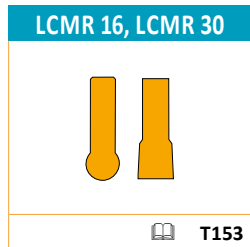
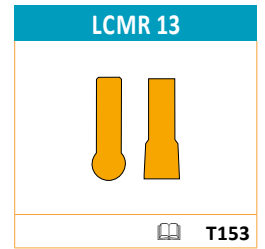
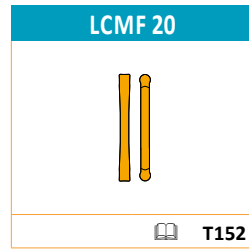
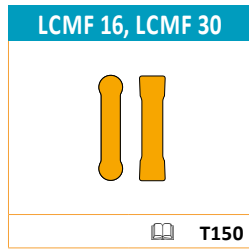
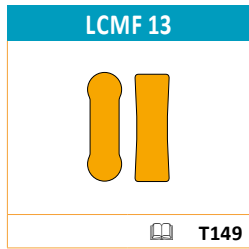
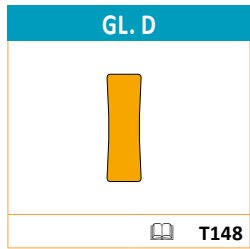
NAVIGATOR - CBN INSERTS  
NAVEGADOR - CBN  
NAVIGATEUR - PLAQUETTES CBN



NAVIGATOR - PCD INSERTS  
NAVEGADOR - PCD  
NAVIGATEUR - PLAQUETTES PCD



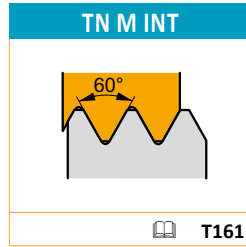
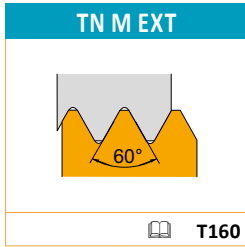
NAVIGATOR - INSERTS FOR PARTING AND GROOVING  
NAVEGADOR - TRONZADO Y RANURADO  
NAVIGATEUR - PLAQUETTES POUR TRONÇONNAGE ET GORGES





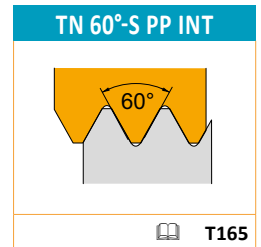
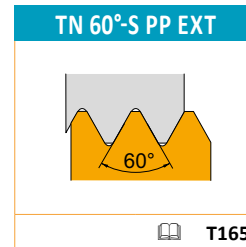
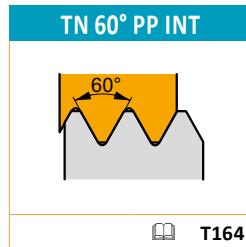
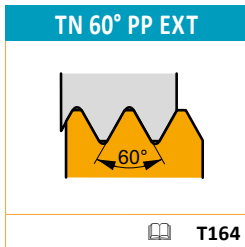
# M

Full profile  
 Perfil completo  
 Perfil completo  
 Profil complet



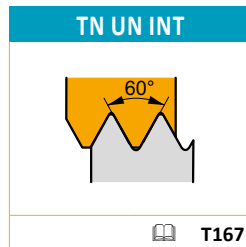
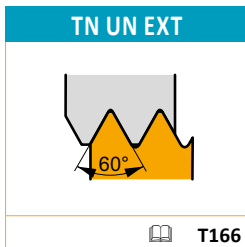
# M

Partial profile  
 Perfil parcial  
 Perfil parcial  
 Profil partiel



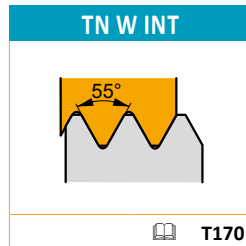
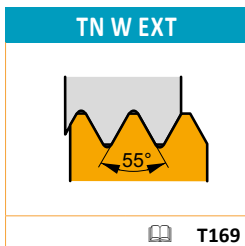
# UN

Full profile  
 Perfil completo  
 Perfil completo  
 Profil complet



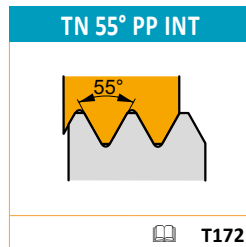
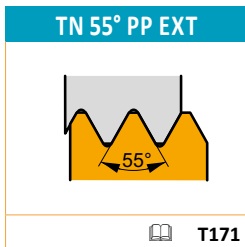
# W

Full profile  
 Perfil completo  
 Perfil completo  
 Profil complet



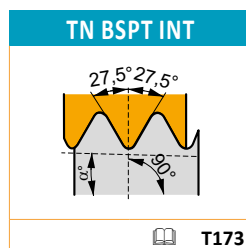
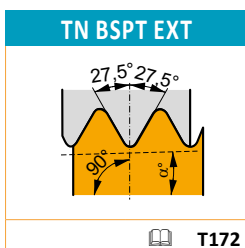
# W

Partial profile  
 Perfil parcial  
 Perfil parcial  
 Profil partiel



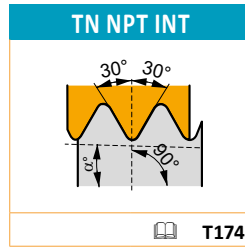
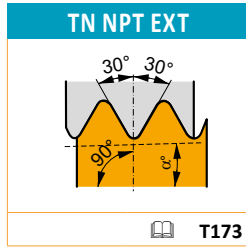
# BSPT

Full profile  
 Perfil completo  
 Perfil completo  
 Profil complet



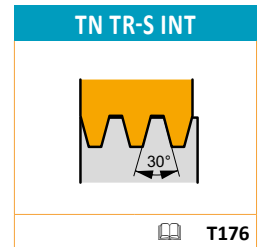
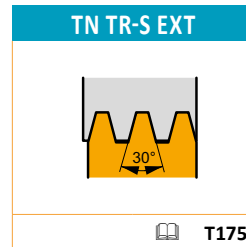
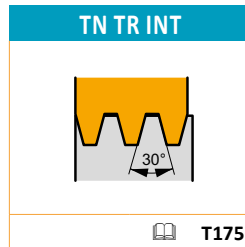
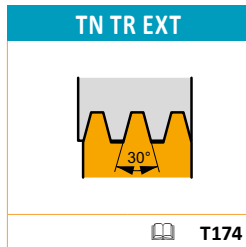
## NPT

Full profile  
 Perfil completo  
 Perfil completo  
 Profil complet



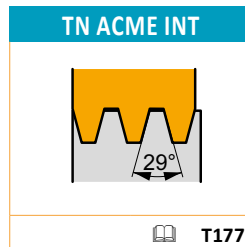
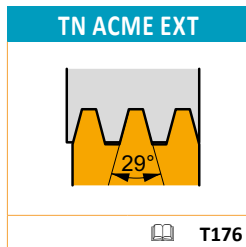
## TR

Full profile  
 Perfil completo  
 Perfil completo  
 Profil complet



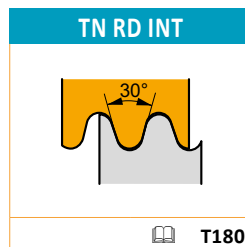
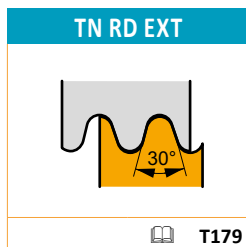
## ACME

Full profile  
 Perfil completo  
 Perfil completo  
 Profil complet



## RD

Full profile  
 Perfil completo  
 Perfil completo  
 Profil complet



**TURNING – EXTERNAL**

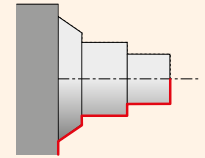
SHORT AND STABLE COMPONENTS  
 (negative inserts)

**TOURNAGE – EXTÉRIEUR**

COMPOSANTS COURTS ET STABLES  
 (plaquettes négatives)

**TORNEADO - EXTERIOR**

PIEZAS CORTAS Y ESTABLES  
 (plaquitas negativas)



**DCKN(RL) EXT**

**75°**

CN..

.500  
.625

1.000x1.000

T184 T44 - T56

**DCLN(RL) EXT**

**95°**

CN..

.375  
.500  
.625  
.750

.625x.625  
1.500x1.500

T185 T44 - T56

**DCRN(RL) EXT**

**75°**

CN..

.500  
.625  
.750

.750x.750  
1.500x1.500

T187 T44 - T56

**DDJN(RL) EXT**

**93°**

DN..

.375  
.500

.750x.750  
1.250x1.250

T188 T62 - T70

**DDPNN EXT**

DN..

.375  
.500

.750x.750  
1.000x1.000

T189 T62 - T70

**DRSNR EXT**

RN..

.500

1.000x1.000

T190 T80

**DSDNN EXT**

**45°**

SN..

.500  
.625  
.750  
1.000

.750x.750  
1.500x1.500

T191 T85 - T94

**DSKN(RL) EXT**

**75°**

SN..

.500  
.625

1.000x1.000  
1.250x1.250

T192 T85 - T94

**DSRN(RL) EXT**

**75°**

SN..

.500  
.625  
.750

.750x.750  
1.500x1.500

T193 T85 - T94

**DSSN(RL) EXT**

**45°**

SN..

.500  
.625  
.750

.750x.750  
1.500x1.500

T195 T85 - T94

**DTGN(RL) EXT**

**90°**

TN..

.375  
.500

.750x.750  
1.500x1.500

T196 T100-T107

**DTJN(RL) EXT**

**93°**

TN..

3  
4

.750x.750  
1.250x1.250

T197 T100-T107

**TURNING – EXTERNAL**

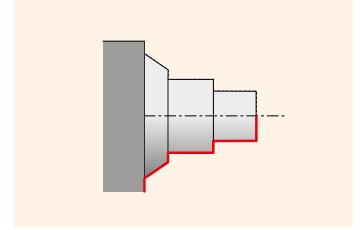
SHORT AND STABLE COMPONENTS  
 (negative inserts)

**TOURNAGE – EXTÉRIEUR**

COMPOSANTS COURTS ET STABLES  
 (plaquettes négatives)

**TORNEADO - EXTERIOR**

PIEZAS CORTAS Y ESTABLES  
 (plaquitas negativas)



**DTTN(RL) EXT**

**60°**

TN..

3  
4

■	.750x.750 1.000x1.000
---	--------------------------

T198 T100-T107

**DVJN(RL) EXT**

**93°**

VN..

.375

■	.750x.750 1.250x1.250
---	--------------------------

T199 T116-T118

**DWLN(RL) EXT**

**95°**

WN..

.375  
.500

■	.625x.625 1.250x1.250
---	--------------------------

T200 T121-T128

**PRDCN EXT**

RC..

.625  
.750  
1.000  
1.250

■	1.260x.984 1.575x1.575
---	---------------------------

T201 T74 - T80

**PRSC(RL) EXT**

RC..

.625  
.750  
1.000

■	1.260x.984 1.575x1.575
---	---------------------------

T202 T74 - T80

**TURNING – EXTERNAL**

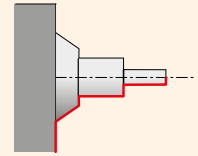
LONG AND UNSTABLE COMPONENTS  
 (Positive inserts)

**TOURNAGE – EXTÉRIEUR**

COMPOSANTS LONGS ET INSTABLES  
 (plaquettes positives)

**TORNEADO - EXTERIOR**

PIEZAS LARGAS E INESTABLES  
 (plaquetas positivas)



SCLC(RL) EXT	
<b>95°</b>	CC..
	.250 .312 .375 .500
	.375x.375 1.000x1.000

SDJC(RL) EXT	
<b>93°</b>	DC..
	.250 .375 .625
	.375x.375 1.000x1.000

SDPCN EXT	
<b>62°30'</b>	DC..
	2 3
	.375x.375 1.000x1.000

SRDCN EXT	
	RC..
	.250 .312 .375 .500 .625
	.472x.472 1.260x.984

SRSC(RL) EXT	
	RC..
	.250 .312 .375 .500 .625
	.630x.630 1.260x.984

SSDCN EXT	
<b>45°</b>	SC..
	09 12
	12x12 25x25

STGC(RL) EXT	
<b>93°</b>	TN..
	2 3
	.500x.500 1.000x1.000

SVHB(C)(RL) EXT	
<b>107°30'</b>	VB, VC..
	.3125
	.7500x.7500 1.000x1.000

SVJB(C)(RL) EXT	
<b>93°</b>	VB, VC..
	.3125
	.625x.625 1.250x1.250

SVVB(C)N EXT	
<b>72°30'</b>	VB, VC..
	.3125
	.500x.500 1.250x1.250

SWLC(RL) EXT	
<b>95°</b>	WC..
	.375 .500
	.750x.750 1.000x1.000

**TURNING – INTERNAL**

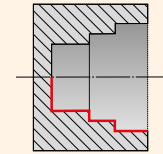
SHORT AND STABLE COMPONENTS  
 (negative inserts)

**TOURNAGE – INTÉRIEUR**

COMPOSANTS COURTS ET STABLES  
 (plaquettes négatives)

**TORNEADO - INTERIOR**

PIEZAS CORTAS Y ESTABLES  
 (plaquitas negativas)



DCLN(RL) INT	
<b>95°</b>	CN..
	.375 .500
	.750 1.500
	T215
	T44 - T56

DDUN(RL) INT	
<b>93°</b>	DN..
	.375 .625
	1.000 1.500
	T216
	T62 - T70

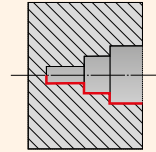
DTFN(RL) INT	
<b>90°</b>	TN..
	.375 .500
	1.000 1.500
	T217
	T100-T107

DWLN(RL) INT	
<b>95°</b>	WN..
	.375 .500
	1.000 1.500
	T218
	T121-T128

**TURNING – INTERNAL**  
 LONG AND UNSTABLE COMPONENTS  
 (positive inserts)

**TOURNAGE – INTÉRIEUR**  
 COMPOSANTS LONGS ET INSTABLES  
 (plaquettes positives)

**TORNEADO - INTERIOR**  
 PIEZAS LARGAS E INESTABLES  
 (plaquetas positivas)



SCLC(RL) INT	
<b>95°</b> 	CC..
	 .250 .375 .500
	.375 --- 1.250
 T219	 T36 - T43

SDQC(RL) INT	
<b>107°30'</b> 	DC..
	 .250 .375
	.375 --- 1.000
 T220	 T57- T61

SDUC(RL) INT	
<b>93°</b> 	DC..
	 .250 .375
	.375 --- 1.250
 T221	 T57- T61

SDUC(RL)-E INT	
<b>93°</b> 	DC..
	 .250 .375
	.375 --- .625
 T222	 T57- T61

SDZC(RL) INT	
<b>93°</b> 	DC..
	 .250 .375
	1.250
 T223	 T57- T61

STFC(RL) INT	
<b>90°</b> 	TC..
	 .156 .187 .250 .375
	.500 --- 1.000
 T224	 T96 - T99

**TURNING – INTERNAL**

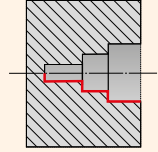
LONG AND UNSTABLE COMPONENTS  
 (positive inserts)

**TOURNAGE – INTÉRIEUR**

COMPOSANTS LONGS ET INSTABLES  
 (plaquettes positives)

**TORNEADO - INTERIOR**

PIEZAS LARGAS E INESTABLES  
 (plaquetas positivas)



SVQB(C)(RL) INT	
<b>107°30'</b>	VB, VC..
	 .250

SVUB(C)(RL) INT	
<b>93°</b>	VB, VC..
	 .250

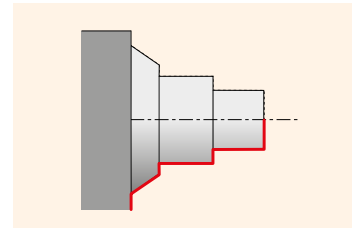
SWLC(RL) INT	
<b>95°</b>	WC..
	 .375 .500



**TURNING – HEAVY ROUGHING – EXTERNAL**  
 FIXED TOOL HOLDERS

**TORNEADO - DESBASTE PESADO - EXTERIOR**  
 PORTAHERRAMIENTAS FIJOS

**TOURNAGE – ÉBAUCHE LOURDE - EXTÉRIEUR**  
 PORTE-OUTILS FIXES



DCRN(RL) EXT	
<b>75°</b>	CN..
	.750
	1.250x1.250 1.500x1.500
	T187
	T44 - T56

DCLN(RL) EXT	
<b>95°</b>	CN..
	.750
	1.250x1.250 1.500x1.500
	T185
	T44 - T56

PRDCN EXT	
	RC..
	.750 1.000 1.250
	1.260x1.260 1.575x1.575
	T201
	T74 - T80

PRSC(RL) EXT	
	RC..
	.750 1.000
	1.260x1.260 1.575x1.575
	T202
	T74 - T80

DSRN(RL) EXT	
<b>75°</b>	SN..
	.750 1.000
	1.250x1.250 1.500x1.500
	T193
	T85 - T94

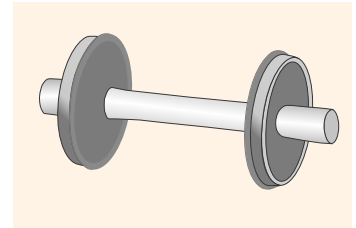
DSDNN EXT	
<b>45°</b>	SN..
	1.000
	1.250x1.250 1.500x1.500
	T191
	T85 - T94

DSSN(RL) EXT	
<b>45°</b>	SN..
	.750
	1.260x1.260 1.500x1.500
	T195
	T85 - T94

**TURNING – HEAVY ROUGHING – EXTERNAL**  
 RAILWAY WHEEL MACHINING

**TORNEADO - DESBASTE PESADO - EXTERIOR**  
 MECANIZADO DE RUEDAS DE FERROCARRIL

**TOURNAGE – ÉBAUCHE LOURDE - EXTÉRIEUR**  
 USINAGE DE ROUES FERROVIAIRES



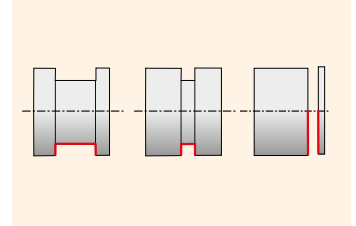
PRDCN EXT	
	RC..
	.750 1.000 1.250
1.260x1.260 --- 1.575x1.575	
T201	T74 - T80

PRSC(RL) EXT	
	RC..
	.750 1.000
1.260x1.260 --- 1.575x1.575	
T202	T74 - T80

PARTING OFF AND  
 GROOVING - EXTERNAL

TRONZADO Y RANURADO - EXTERIOR

TRONÇONNAGE ET GORGES  
 - EXTÉRIEUR



**GLSF(RL) EXT**

GL. D

GL2  
GL3  
GL4  
GL5  
GL6

.625x.625  
1.000x1.000

T230 T148

**GLS B + DU. D**

GL. D

CDX

.787x.787  
1.259x1.142

T231 T248 T148

**GFK(RL) EXT**

LCMF

.625x.625  
1.000x1.000

T232 T149 - T152

**GFI(RL) EXT**

LCMF, LCMR

.625x.625  
1.250x1.000

.118  
.157  
.197  
.236  
.315

T233 T149 - T152 T153 - T154

**GFM(RL) EXT**

LCMF, LCMR

.750x.750  
1.250x1.000

.118  
.157  
.197  
.236  
.315

T234 T149 - T152 T153 - T154

**XLCCN 25 BS + MS-EN**

LCMF, LCMR

.500x.500  
1.250x1.000

.118  
.157  
.197  
.236

T244 T243 T149 - T152 T153 - T154

**XLCCN B + DU, D**

LCMF, LCMR

.750x.750  
1.500x1.500

.118  
.157  
.197  
.236  
.315

T246 T248 T149 - T152 T153 - T154

**XLCCF(NRL) BS + MS-EN**

LFMX

.500x.500  
1.250x1.000

.059  
.063  
.079  
.087  
.122  
.161  
.201  
.250

T245 T243 T154-155

**XLCCFN B + DU, D**

LFMX

.750x.750  
1.500x1.500

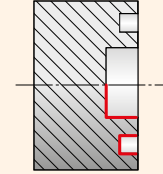
.059  
.063  
.079  
.087  
.122  
.161  
.201

T247 T248 T154-155

FACE GROOVING

RANURADO FRONTAL

GORGES FRONTALES



**GFIL-L AXIAL**

LCMF, LCMR

.118  
.157

.670-1.180  
4.330-6.690 T149 - T152

T240 T153 - T154

**GFIL-R AXIAL**

LCMF, LCMR

.118  
.157

.670-1.180  
5.510x9.060 T149 - T152

T237 T153 - T154

**GFIR-L AXIAL**

LCMF, LCMR

.118  
.157

.670-1.180  
5.510x9.060 T149 - T152

T235 T153 - T154

**GFIR-R AXIAL**

LCMF, LCMR

.118  
.157

.670-1.180  
4.330-6.690 T149 - T152

T239 T153 - T154

**GGI(RL)-90 AXIAL**

LCMF, LCMR

.118  
.157

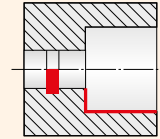
.670-1.180  
4.330-6.690 T149 - T152

T241 T153 - T154

GROOVING – INTERNAL

RANURADO - INTERIOR

GORGES - INTÉRIEUR



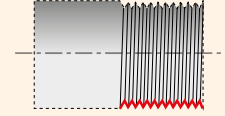
**GG.(RL) INT**

	LCMF, LCMR
	 .118 .157
 .630 1.260	T149 - T152 T153 - T154
T242	

**THREAD TURNING  
 - EXTERNAL**

**ROSCADO - EXTERIOR**

**TOURNAGE DE FILETS  
 - EXTÉRIEUR**



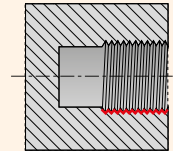
SE(RL)	
	TN..
	.375
	.500
	.750x.750
	1.250x1.000
T250	T157 - T179

SE(RL)-S	
	TN..
	.500
	1.000x1.000
	1.250x1.000
T251	T157 - T179

**THREAD TURNING  
 - INTERNAL**

**ROSCADO - INTERIOR**

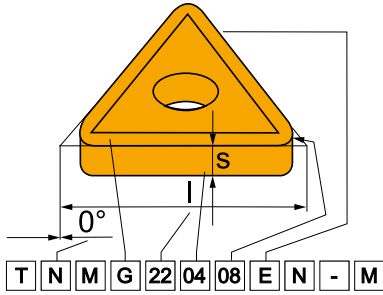
**TOURNAGE DE FILETS  
 - INTÉRIEUR**



SI(RL)	
	TN..
	.250
	.375
	.500
	.500
	1.750
T252	T157 - T179

SI(RL)-S	
	TN..
	.500
	1.550
	1.800
T253	T157 - T179





<b>ISO</b>	<b>1</b>	<b>2</b>	<b>3</b>	<b>4</b>
	T	N	U	N
	T	N	M	G
<b>ANSI</b>	<b>1</b>	<b>2</b>	<b>3</b>	<b>4</b>
	T	N	U	N
	T	N	M	G

1				1			
Insert shape Forma de plaquita Forme de la plaquette							
H	O	P	R				
S	T	C	D				
E	M	V	W				
L	A	B	K				

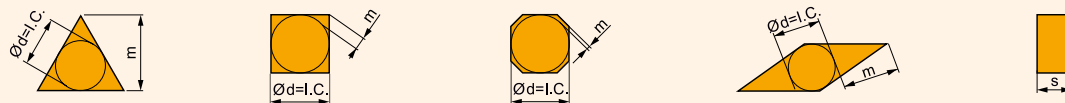
2		2	
Insert clearance angle Ángulo de incidencia Angle de dépolle de la plaquette			
A		B	
C		D	
E		F	
G		N	
P		O	Special Especial Especial Spécial

4		4	
Insert type Tipo de plaquita Type de plaquette			
N			
R			
F			
A			
M			
G			
W			
T			
Q			
U			
B			
H			
C			
J			
X		Special / Especial Especial / Spécial	

**3** **3**

Tolerances / Tolerancias  
Tolerâncias / Tolérances

	[mm]			[in]		
	m (±)	s (±)	d = I.C. (±)	m (±)	s (±)	d = I.C. (±)
A	.005	.025	.025	.0002	.001	.0010
F	.005	.025	.013	.0002	.001	.0005
C	.013	.025	.025	.0005	.001	.0010
H	.013	.025	.013	.0005	.001	.0005
E	.025	.025	.025	.0010	.001	.0010
G	.025	.130	.025	.0010	.005	.0010
J	.005	.025	.05 ÷ .13	.0002	.001	.002 ÷ .005
K	.013	.025	.05 ÷ .13	.0005	.001	.002 ÷ .005
L	.025	.025	.05 ÷ .13	.0010	.001	.002 ÷ .005
M	.08 ÷ .18	.130	.05 ÷ .13	.003 ÷ .007	.005	.002 ÷ .005
N	.08 ÷ .18	.025	.05 ÷ .13	.003 ÷ .007	.001	.002 ÷ .005
U	.05 ÷ .38	.130	.05 ÷ .13	.005 ÷ .015	.005	.003 ÷ .010





ISO/ANSI CODE DESIGNATION - INSERTS  
 DESIGNACIÓN CÓDIGO ISO/ANSI - PLAQUITAS  
 CODIFICATION ISO/ANSI - PLAQUETTES

<b>5</b>	<b>6</b>	<b>7</b>	<b>8</b>	<b>9</b>	<b>10</b>
<b>22</b>	<b>04</b>	<b>08</b>			
<b>22</b>	<b>04</b>	<b>08</b>	<b>E</b>	<b>N</b>	<b>M</b>
<b>5A</b>	<b>6A</b>	<b>7A</b>	<b>8</b>	<b>9</b>	<b>10</b>
<b>4</b>	<b>3</b>	<b>2</b>			
<b>4</b>	<b>3</b>	<b>2</b>	<b>E</b>	<b>N</b>	<b>M</b>

5		Insert cutting edge length (insert size) Longitud del filo de corte (tamaño de plaquita) Longueur de l'arête de coupe (taille de plaquette)												
d = I.C.		H	O	P	S	T	C	D	E	M	V	W	R	K
[mm]	[in]													
3,97	5/32"				03	06		04			06	02		
4,76	3/16"				04	08	04	05	04	04	08	L3		
5,56	7/32"				05	09	05	06	05	05	09	03		
6,35	1/4"	03	02	04	08	11	06	07	08	08	11	04	06	
7,94	5/16"	04	03	05	07	13	08	09	06	07	13	05	07	
9,525	3/8"	05	04	07	09	16	09	11	09	09	16	06	09	16
12,7	1/2"	07	05	09	12	22	12	15	13	12	22	08	12	
15,875	5/8"	09	06	11	15	27	16	19	16	15	27	10	15	
19,05	3/4"	11	07	13	19	33	19	23	19	19	33	13	19	
25,40	1"	14	10	18	25	44	25	31	26	25	44	17	25	
31,75	1 1/4"	18	13	23	31	54	32	38	32	31	54	21	31	

6		Insert thickness Espesor Épaisseur de la plaquette	
		s	
		[mm]	[in]
<b>01</b>		1,59	1/16"
<b>T1</b>		1,98	5/64"
<b>02</b>		2,38	3/32"
<b>03</b>		3,18	1/8"
<b>T3</b>		3,97	5/32"
<b>04</b>		4,76	3/16"
<b>05</b>		5,56	7/32"
<b>06</b>		6,35	1/4"
<b>07</b>		7,94	5/16"
<b>09</b>		9,52	3/8"

7		Insert nose radius Radio de punta Rayon de pointe de la plaquette	
		r <sub>c</sub>	
		[mm]	[in]
<b>00</b>		0	0"
<b>02</b>		0,2	1/128"
<b>04</b>		0,4	1/64"
<b>08</b>		0,8	1/32"
<b>12</b>		1,2	3/64"
<b>16</b>		1,6	1/16"
<b>24</b>		2,4	3/32"
<b>32</b>		3,2	1/8"
		Round inserts Plaquetas redondas Plaquettes rondes	
		d=I.C.	
		[in]	<b>00</b>
		[mm]	<b>MO</b>

ANSI		
<b>5A</b>	<b>6A</b>	<b>7A</b>
Inscribed circle Círculo inscrito Cercle inscrit	Insert thickness Espesor Épaisseur de la plaquette	Insert nose radius Radio de punta Rayon de pointe de la plaquette
		r <sub>c</sub>
		[mm]
		[in]
		0
		0,2
		0,5
		1
		2
		3
		4
		5
		6
		7
		8
		10
		12
		14
		16

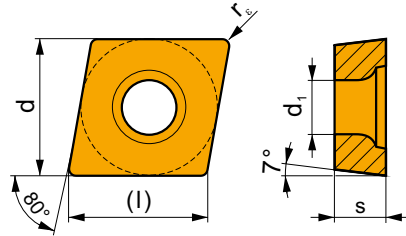
8		8	
Insert cutting edge design / Condición del filo de corte / Configuration de l'arête de coupe			
<b>F</b>	Sharp edges Filos vivos Arêtes vives	<b>E</b>	Rounded edges Filos redondeados Arêtes arrondies
<b>T</b>	Edges with facet Filos con faceta Arêtes avec listel	<b>S</b>	Rounded edges with facet Filo redondeado con faceta Arêtes arrondies avec listel
<b>K</b>	Edges with double facet Filos con doble faceta Arêtes avec double listel	<b>P</b>	Rounded edges with double facet Filos redondeados con doble faceta Arêtes arrondies avec double listel

9		9	
Feed direction / Dirección de avance / Direction d'avance			
<b>R</b>	Feed Avance		
<b>L</b>	Feed Avance		
		<b>N</b>	

10		10	
Chip breaker designation / Designación del rompevirutas / Désignation du brise-copeaux (géométrie)			

# CCGT

	d	d <sub>1</sub>	l	s
2.52-AL	.313	.134	.319	.135
2.52-SF3	.313	.134	.319	.135
21.5	.250	.110	.252	.094
21.5-SF3	.250	.110	.252	.102
32.5	.375	.173	.382	.156
32.5-SF3	.250	.110	.252	.166
43	.500	.217	.508	.187
43-SF3	.500	.217	.508	.197



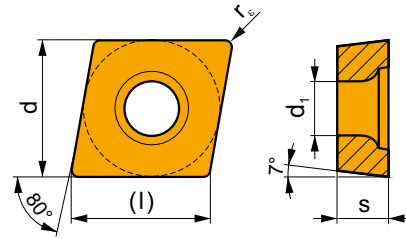
For tools see pages: T203, T219

i	ANSI	Material	P	M	K	N	S	H	Chip	Coolant	r <sub>s</sub>	f <sub>min</sub>	f <sub>max</sub>	a <sub>p min</sub>	a <sub>p max</sub>
	CCGT 21.50.5F-AL	T0315				■			●	+/-	.008	.002	.006	.012	.118
		HF7				■			●	+/-	.008	.002	.006	.012	.118
	CCGT 21.51F-AL	T0315				■			●	+	.016	.004	.012	.016	.138
		HF7				■			●	+	.016	.004	.012	.016	.138
	CCGT 2.520.5F-AL	T0315				■			●	+/-	.008	.002	.006	.012	.098
	CCGT 2.521F-AL	T0315				■			●	+	.016	.002	.012	.016	.098
		HF7				■			●	+	.016	.002	.012	.016	.098
	CCGT 32.50.5F-AL	T0315				■			●	+/-	.008	.004	.006	.012	.157
		HF7				■			●	+/-	.008	.004	.006	.012	.157
	CCGT 32.51F-AL	T0315				■			●	+	.016	.004	.012	.016	.177
		HF7				■			●	+	.016	.004	.012	.016	.177
	CCGT 32.52F-AL	T0315				■			●	+	.031	.006	.024	.031	.197
	HF7				■			●	+	.031	.006	.024	.031	.197	
CCGT 431F-AL	T0315				■			●	+	.016	.004	.012	.016	.276	
	HF7				■			●	+	.016	.004	.012	.016	.276	
CCGT 432F-AL	T0315				■			●	+	.031	.006	.024	.031	.276	
	HF7				■			●	+	.031	.006	.024	.031	.276	
	CCGT 2.520.5-AL	T8310				▣			●	+	.008	.002	.006	.012	.098
	CCGT 2.521-AL	T8310				▣			●	+	.016	.002	.012	.016	.098
	CCGT 32.50.5-FF2	T7325	▣	▣					●	+	.008	.002	.006	.006	.098
		T9325	■	▣	▣				●	+	.008	.002	.006	.006	.098
	CCGT 21.51-NF1	T7325	▣	■			■		●	+	.016	.002	.008	.012	.079
		T6310	▣	■	▣		■		●	+	.016	.002	.008	.012	.079
	CCGT 21.52-NF1	T7325	▣	■			■		●	+	.031	.004	.009	.020	.079
		T6310	▣	■	▣		■		●	+	.031	.004	.009	.020	.079
	CCGT 32.51-NF1	T7325	▣	■			■		●	++	.016	.002	.010	.012	.118
		T6310	▣	■	▣		■		●	+	.016	.002	.010	.012	.118

i	ANSI		P	M	K	N	S	H			$r_e$	$f_{min}$	$f_{max}$	$a_{p min}$	$a_{p max}$
	CCGT 32.52-NF1		T7325	■	■		■		●	++	.031	.005	.012	.020	.118
			T6310	■	■	■	■		●	+	.031	.005	.012	.020	.118
			T6310												
			T6310												
	CCGT 21.50.5-SF3		T6310		■	■	■		●	+	.008	.001	.006	.008	.063
			T8315		■	■	□		●	+/-	.008	.001	.006	.008	.063
	CCGT 21.51-SF3		T6310		■	■	■		●	+	.016	.001	.008	.008	.079
			T8315		■	■	□		●	+/-	.016	.001	.008	.008	.079
	CCGT 2.520.5-SF3		T6310		■	■	■		●	+	.008	.001	.006	.008	.079
			T8315		■	■	□		●	+/-	.008	.001	.006	.008	.079
	CCGT 2.521-SF3		T6310		■	■	■		●	+	.016	.001	.009	.008	.098
			T8315		■	■	□		●	+/-	.016	.001	.009	.008	.098
	CCGT 32.50.5-SF3		T6310		■	■	■		●	+	.008	.001	.006	.008	.079
			T8315		■	■	□		●	+/-	.008	.001	.006	.008	.079
	CCGT 32.51-SF3		T6310		■	■	■		●	+	.016	.001	.010	.008	.110
			T8315		■	■	□		●	+	.016	.001	.010	.008	.110
	CCGT 32.52-SF3		T6310		■	■	■		●	+	.031	.003	.012	.024	.126
			T8315		■	■	□		●	+	.031	.003	.012	.024	.126
	CCGT 432-SF3		T6310		■	■	■		●	+	.031	.004	.014	.024	.157
			T8315		■	■	□		●	+	.031	.004	.014	.024	.157
	CCGT 21.50.5R-SI		T8330	■	■	□	□	■	●	+	.008	.003	.006	.016	.063
			T8315	■	■	□	□	□	●	+	.016	.003	.010	.020	.059
	CCGT 21.51R-SI		T8330	■	■	□	□	■	●	+	.016	.003	.010	.020	.059
			T8315	■	■	□	□	□	●	+	.016	.006	.012	.031	.079
	CCGT 32.51R-SI		T8315	■	■	□	□	□	●	+	.016	.006	.012	.031	.079
			T8330	■	■	□	□	■	●	+	.016	.006	.012	.031	.079
	CCGT 432R-SI		T8330	■	■	□	□	■	●	++	.031	.009	.017	.039	.157
			T8330	■	■	□	□	■	●	++	.031	.009	.017	.039	.157
	CCGT 21.50.5L-SI		T8330	■	■	□	□	■	●	+	.008	.003	.006	.016	.063
			T8315	■	■	□	□	□	●	+	.016	.003	.010	.020	.059
	CCGT 21.51L-SI		T8330	■	■	□	□	■	●	+	.016	.003	.010	.020	.059
			T8315	■	■	□	□	□	●	+	.016	.006	.012	.031	.079
	CCGT 32.51L-SI		T8315	■	■	□	□	□	●	+	.016	.006	.012	.031	.079
			T8330	■	■	□	□	■	●	+	.016	.006	.012	.031	.079
	CCGT 432L-SI		T8330	■	■	□	□	■	●	++	.031	.009	.017	.039	.157
			T8330	■	■	□	□	■	●	++	.031	.009	.017	.039	.157

# CCMT

	d	d <sub>1</sub>	l	s
2.52	.313	.134	.319	.125
21.5	.250	.110	.252	.094
32.5	.375	.173	.382	.156
43	.500	.217	.508	.187



For tools see pages: T203, T219

i	ANSI	Material	P	M	K	N	S	H	Coating	C	r <sub>c</sub>	f <sub>min</sub>	f <sub>max</sub>	a <sub>p min</sub>	a <sub>p max</sub>
	CCMT 1.821-FM2	T9315	■	■	■			□	●	++	.016	.002	.010	.012	.106
	CCMT 21.50.5-FF	T8315	■	■	■	□	□		●	+/-	.008	.002	.006	.008	.079
		T8330	■	■	■	□	□		●	+	.008	.002	.006	.008	.079
		T9315	■	■	■				●	+	.008	.002	.006	.008	.079
	CCMT 21.51-FF	T8315	■	■	■	□	□		●	+	.016	.002	.009	.016	.079
		T8330	■	■	■	□	□		●	+	.016	.002	.009	.016	.079
		T9315	■	■	■				●	+	.016	.002	.009	.008	.079
	CCMT 32.51-FF	T8315	■	■	■	□	□		●	+	.016	.002	.009	.016	.079
		T8330	■	■	■	□	□		●	+	.016	.002	.009	.016	.079
		T9315	■	■	■				●	+	.016	.002	.009	.008	.079
	CCMT 21.50.5-FF2	T7325	■	■					●	+	.008	.001	.005	.006	.059
		T9315	■	■	■				●	+	.008	.001	.005	.006	.059
		T9325	■	■	■				●	+	.008	.001	.005	.006	.059
		T8330	■	■	■				●	+	.008	.001	.005	.006	.059
		TT010	■	■					●	+/-	.008	.001	.005	.006	.059
	CCMT 21.51-FF2	T7325	■	■					●	+	.016	.002	.008	.012	.098
		T9315	■	■	■				●	+	.016	.002	.008	.012	.098
		T9325	■	■	■				●	+	.016	.002	.008	.012	.098
		T9335	■	■					●	++	.016	.002	.008	.012	.098
		T8330	■	■	■				●	+	.016	.002	.008	.012	.098
		TT010	■	■					●	+/-	.016	.002	.008	.012	.098
	CCMT 2.520.5-FF2	T7325	■	■					●	+	.008	.002	.006	.008	.059
		T9325	■	■	■				●	+	.008	.002	.006	.008	.059
		T8330	■	■	■				●	+	.008	.002	.006	.008	.059
		TT010	■	■					●	+/-	.008	.002	.006	.008	.059
	CCMT 2.521-FF2	T7325	■	■					●	+	.016	.002	.009	.012	.098
		T9325	■	■	■				●	+	.016	.002	.009	.012	.098
		T8330	■	■	■				●	+	.016	.002	.009	.012	.098
		TT010	■	■					●	+/-	.016	.002	.009	.012	.098
	CCMT 2.522-FF2	T7325	■	■					●	++	.031	.003	.011	.024	.118
		T9325	■	■	■				●	+	.031	.003	.011	.024	.118
		T8330	■	■	■				●	+	.031	.003	.011	.024	.118
	CCMT 32.51-FF2	T7325	■	■					●	++	.016	.002	.009	.012	.118
		T9315	■	■	■				●	+	.016	.002	.009	.012	.118
		T9325	■	■	■				●	+	.016	.002	.009	.012	.118
		T9335	■	■					●	++	.016	.002	.009	.012	.118
		T8330	■	■	■				●	+	.016	.002	.009	.012	.118
		TT010	■	■					●	+/-	.016	.002	.009	.012	.118
	CCMT 32.52-FF2	T7325	■	■					●	++	.031	.003	.011	.024	.118
		T9315	■	■	■				●	++	.031	.003	.011	.024	.118
		T9325	■	■	■				●	+	.031	.003	.011	.024	.118
		T8330	■	■	■				●	+	.031	.003	.011	.024	.118
		TT010	■	■					●	+/-	.031	.003	.011	.024	.118



ANSI



P M K N S H



r<sub>c</sub>

f<sub>min</sub>

f<sub>max</sub>

a<sub>p min</sub>

a<sub>p max</sub>

CCMT 21.50.5-FM

T7325	█	█			□	
T7335	█	█			□	
T9315	█		█			
T9325	█	█	█		□	
T8315	█	█	█		□	
T8330	█	█	█		□	

●	+	.008	.004	.006	.006	.039
●	++	.008	.004	.006	.006	.039
●	+	.008	.004	.006	.006	.039
●	+	.008	.004	.006	.006	.039
●	+/-	.008	.002	.006	.006	.039
●	+	.008	.002	.006	.006	.039

CCMT 21.51-FM

T7325	█	█			□	
T7335	█	█			□	
T9315	█		█			
T9325	█	█	█		□	
T8315	█	█	█		□	
T8330	█	█	█		□	

●	+	.16	.006	.008	.012	.059
●	++	.16	.006	.008	.012	.059
●	+	.16	.006	.008	.012	.059
●	+	.16	.006	.008	.012	.059
●	+/-	.16	.003	.008	.012	.059
●	+	.16	.003	.008	.012	.059

CCMT 21.52-FM

T7325	█	█			□	
T9315	█		█			
T9325	█	█	█		□	
T8330	█	█	█		□	

●	++	.031	.006	.012	.020	.079
●	++	.031	.006	.012	.020	.079
●	+	.031	.006	.012	.020	.079
●	+	.031	.005	.012	.020	.079

CCMT 32.50.5-FM

T7325	█	█			□	
T7335	█	█			□	
T9315	█		█			
T9325	█	█	█		□	
T8315	█	█	█		□	
T8330	█	█	█		□	

●	+	.008	.004	.006	.008	.118
●	++	.008	.004	.006	.008	.118
●	+	.008	.004	.006	.008	.118
●	+	.008	.004	.006	.008	.118
●	+/-	.008	.002	.006	.008	.118
●	+	.008	.002	.006	.006	.118

CCMT 32.51-FM

T7325	█	█			□	
T7335	█	█			□	
T9315	█		█			
T9325	█	█	█		□	
T8315	█	█	█		□	
T8330	█	█	█		□	

●	++	.16	.006	.012	.012	.118
●	++	.16	.006	.012	.012	.118
●	++	.16	.006	.012	.012	.118
●	+	.16	.006	.012	.012	.118
●	+	.16	.004	.012	.012	.118
●	+	.16	.004	.012	.012	.118

CCMT 32.52-FM

T7325	█	█			□	
T7335	█	█			□	
T9315	█		█			
T9325	█	█	█		□	
T8315	█	█	█		□	
T8330	█	█	█		□	

●	++	.031	.006	.014	.020	.118
●	++	.031	.006	.014	.020	.118
●	++	.031	.006	.014	.020	.118
●	+	.031	.006	.014	.020	.118
●	+	.031	.006	.014	.020	.118
●	+	.031	.006	.014	.020	.118

CCMT 431-FM

T7325	█	█			□	
T7335	█	█			□	
T9315	█		█			
T9325	█	█	█		□	
T8315	█	█	█		□	
T8330	█	█	█		□	

●	++	.16	.006	.012	.016	.157
●	++	.16	.006	.012	.016	.157
●	++	.16	.006	.012	.016	.157
●	+	.16	.006	.012	.016	.157
●	+	.16	.004	.012	.016	.157
●	+	.16	.004	.012	.016	.157

CCMT 432-FM

T7325	█	█			□	
T7335	█	█			□	
T9315	█		█			
T9325	█	█	█		□	
T8315	█	█	█		□	
T8330	█	█	█		□	

●	++	.031	.006	.014	.020	.157
●	++	.031	.006	.014	.020	.157
●	++	.031	.006	.014	.020	.157
●	+	.031	.006	.014	.020	.157
●	+	.031	.006	.014	.020	.157
●	+	.031	.006	.014	.020	.157

CCMT 433-FM

T9325	█	█	█		□	
T8330	█	█	█		□	

●	++	.047	.006	.018	.031	.157
●	++	.047	.006	.018	.031	.157

CCMT 2.521-FM2

T9325	█	█	█		□	
T9335	█	█			□	
T8330	█	█	█		□	

●	+	.16	.002	.010	.012	.106
●	++	.16	.002	.010	.012	.106
●	+	.16	.002	.010	.012	.106

CCMT 2.522-FM2

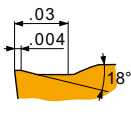
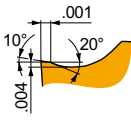
T9325	█	█	█		□	
T9335	█	█			□	
T8330	█	█	█		□	

●	+	.031	.004	.016	.024	.138
●	++	.031	.004	.016	.024	.138
●	+	.031	.004	.016	.024	.138

CCMT 32.51-FM2









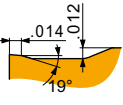
T9315	█		█		□	
T9325	█	█	█		□	
T6310	█	█	█		□	

●	++	.16	.002	.010	.012	.106
●	+	.16	.002	.010	.012	.106
●	+	.16	.002	.010	.012	.106



i	ANSI		P	M	K	N	S	H			r <sub>e</sub>	f <sub>min</sub>	f <sub>max</sub>	a <sub>p min</sub>	a <sub>p max</sub>	
   	CCMT 32.51-FM2	T8330	■	■	■		□	□	●	+	.016	.002	.010	.012	.106	
	CCMT 32.52-FM2	T7325	■	■			□		●	++	.031	.004	.014	.031	.138	
	T9315	■	■	■			□		●	++	.031	.004	.014	.031	.138	
	T9325	■	■	■			□		●	+	.031	.004	.014	.031	.138	
	T9335	■	■				□		●	++	.031	.004	.014	.031	.138	
	T6310	■	■	■			□	□	●	+	.031	.004	.014	.031	.138	
	T8330	■	■	■			□	□	●	+	.031	.004	.014	.031	.138	
	CCMT 432-FM2	T7325	■	■			□		●	++	.031	.006	.014	.031	.157	
	T9325	■	■	■			□		●	+	.031	.006	.014	.031	.157	
	T9335	■	■				□		●	++	.031	.006	.014	.031	.157	
	T8330	■	■	■			□	□	●	+	.031	.006	.014	.031	.157	
	CCMT 21.50.5-NF2	T7325	■	■			■			●	+	.008	.003	.006	.008	.059
	T9325	■	■	■		■				●	+	.008	.003	.006	.008	.059
	T6310	■	■	■		■				●	+	.008	.003	.006	.008	.059
	T8330	■	■	■		■				●	+	.008	.003	.006	.008	.059
CCMT 21.51-NF2	T7325	■	■			■			●	+	.016	.004	.008	.008	.079	
T9315	■	■	■						●	+	.016	.004	.008	.008	.079	
T9325	■	■	■		■				●	+	.016	.004	.008	.008	.079	
T9335	■	■			■				●	++	.016	.004	.008	.008	.079	
T6310	■	■	■		■				●	+	.016	.004	.008	.008	.079	
T8330	■	■	■		■				●	+	.016	.004	.008	.008	.079	
H07		■	■		■				●	+	.016	.004	.008	.008	.079	
CCMT 2.521-NF2	T5315	■	□	■					●	+	.016	.004	.010	.008	.142	
T7325	■	■			■				●	++	.016	.004	.010	.008	.142	
T7335	■	■							●	++	.016	.004	.010	.008	.142	
T9315	■	■	■						●	++	.016	.004	.010	.008	.142	
T9325	■	■	■		■				●	+	.016	.004	.010	.008	.142	
T9335	■	■			■				●	++	.016	.004	.010	.008	.142	
CCMT 2.522-NF2	T5315	■	□	■					●	+	.031	.005	.016	.024	.157	
T7325	■	■			■				●	++	.031	.005	.016	.024	.157	
T7335	■	■							●	++	.031	.005	.016	.024	.157	
T9325	■	■	■		■				●	+	.031	.005	.016	.024	.157	
H07*		■	■		■				●	+	.031	.005	.016	.024	.157	
CCMT 32.51-NF2	T7325	■	■			■			●	++	.016	.004	.010	.008	.142	
T9315	■	■	■						●	++	.016	.004	.010	.008	.142	
T9325	■	■	■		■				●	+	.016	.004	.010	.008	.142	
T9335	■	■			■				●	++	.016	.004	.010	.008	.142	
T6310	■	■	■		■				●	+	.016	.004	.010	.008	.142	
T8330	■	■	■		■				●	+	.016	.004	.010	.008	.142	
H07		■	■		■				●	+	.016	.004	.010	.008	.142	
CCMT 32.52-NF2	T7325	■	■			■			●	++	.031	.005	.014	.024	.157	
T9315	■	■	■						●	++	.031	.005	.014	.024	.157	
T9325	■	■	■		■				●	+	.031	.005	.014	.024	.157	
T9335	■	■			■				●	++	.031	.005	.014	.024	.157	
T6310	■	■	■		■				●	+	.031	.005	.014	.024	.157	
T8330	■	■	■		■				●	+	.031	.005	.014	.024	.157	
CCMT 21.50.5-RF	T7335	■	■						●	++	.008	.004	.006	.039	.118	
CCMT 21.51-RF	T5315	■	□	■					●	+	.016	.004	.012	.039	.118	
T7335	■	■							●	++	.016	.006	.012	.039	.118	
CCMT 32.51-RF	T7335	■	■						●	++	.016	.006	.012	.031	.157	
CCMT 32.52-RF	T5315	■	□	■					●	+	.031	.004	.016	.031	.157	
T7335	■	■							●	++	.031	.006	.016	.031	.157	
CCMT 432-RF	T5315	■	□	■					●	++	.031	.008	.024	.039	.177	
T7335	■	■							●	++	.031	.008	.024	.039	.177	

\* Non-stocked item


			ANSI		P	M	K	N	S	H			r <sub>c</sub>	f <sub>min</sub>	f <sub>max</sub>	a <sub>p min</sub>	a <sub>p max</sub>
   			CCMT 32.51-RM	T5305	<input type="checkbox"/>	<input type="checkbox"/>	<input checked="" type="checkbox"/>	<input type="checkbox"/>	<input type="checkbox"/>	<input type="checkbox"/>	<input checked="" type="checkbox"/>	+	.016	.006	.012	.039	.157
				T5315	<input checked="" type="checkbox"/>	<input type="checkbox"/>	<input checked="" type="checkbox"/>	<input type="checkbox"/>	<input type="checkbox"/>	<input type="checkbox"/>	<input checked="" type="checkbox"/>	+	.016	.006	.012	.039	.157
				T7335	<input checked="" type="checkbox"/>	<input checked="" type="checkbox"/>	<input type="checkbox"/>	<input type="checkbox"/>	<input type="checkbox"/>	<input checked="" type="checkbox"/>	++	.016	.006	.012	.039	.157	
				T9315	<input checked="" type="checkbox"/>	<input type="checkbox"/>	<input checked="" type="checkbox"/>	<input type="checkbox"/>	<input type="checkbox"/>	<input checked="" type="checkbox"/>	++	.016	.006	.012	.039	.157	
				T9325	<input checked="" type="checkbox"/>	<input checked="" type="checkbox"/>	<input checked="" type="checkbox"/>	<input type="checkbox"/>	<input type="checkbox"/>	<input checked="" type="checkbox"/>	+	.016	.006	.012	.039	.157	
				T8330	<input checked="" type="checkbox"/>	<input checked="" type="checkbox"/>	<input checked="" type="checkbox"/>	<input checked="" type="checkbox"/>	<input type="checkbox"/>	<input checked="" type="checkbox"/>	+	.016	.006	.012	.039	.157	
				CCMT 32.52-RM	T5305	<input type="checkbox"/>	<input type="checkbox"/>	<input checked="" type="checkbox"/>	<input type="checkbox"/>	<input type="checkbox"/>	<input checked="" type="checkbox"/>	+	.031	.008	.016	.059	.157
					T5315	<input checked="" type="checkbox"/>	<input type="checkbox"/>	<input checked="" type="checkbox"/>	<input type="checkbox"/>	<input type="checkbox"/>	<input checked="" type="checkbox"/>	+	.031	.008	.016	.059	.157
					T7335	<input checked="" type="checkbox"/>	<input checked="" type="checkbox"/>	<input type="checkbox"/>	<input type="checkbox"/>	<input type="checkbox"/>	<input checked="" type="checkbox"/>	++	.031	.008	.016	.059	.157
					T9315	<input checked="" type="checkbox"/>	<input type="checkbox"/>	<input checked="" type="checkbox"/>	<input type="checkbox"/>	<input type="checkbox"/>	<input checked="" type="checkbox"/>	++	.031	.008	.016	.059	.157
T9325	<input checked="" type="checkbox"/>	<input checked="" type="checkbox"/>	<input checked="" type="checkbox"/>		<input type="checkbox"/>	<input type="checkbox"/>	<input checked="" type="checkbox"/>	+	.031	.008	.016	.059	.157				
T8330	<input checked="" type="checkbox"/>	<input checked="" type="checkbox"/>	<input checked="" type="checkbox"/>		<input checked="" type="checkbox"/>	<input type="checkbox"/>	<input checked="" type="checkbox"/>	+	.031	.008	.016	.059	.157				
CCMT 432-RM	T5305	<input type="checkbox"/>	<input type="checkbox"/>	<input checked="" type="checkbox"/>	<input type="checkbox"/>	<input type="checkbox"/>	<input checked="" type="checkbox"/>	+	.031	.008	.016	.059	.177				
	T5315	<input checked="" type="checkbox"/>	<input type="checkbox"/>	<input checked="" type="checkbox"/>	<input type="checkbox"/>	<input type="checkbox"/>	<input checked="" type="checkbox"/>	+	.031	.008	.016	.059	.177				
	T7335	<input checked="" type="checkbox"/>	<input checked="" type="checkbox"/>	<input type="checkbox"/>	<input type="checkbox"/>	<input type="checkbox"/>	<input checked="" type="checkbox"/>	++	.031	.008	.016	.059	.177				
	T9315	<input checked="" type="checkbox"/>	<input type="checkbox"/>	<input checked="" type="checkbox"/>	<input type="checkbox"/>	<input type="checkbox"/>	<input checked="" type="checkbox"/>	++	.031	.008	.016	.059	.177				
	T9325	<input checked="" type="checkbox"/>	<input checked="" type="checkbox"/>	<input checked="" type="checkbox"/>	<input type="checkbox"/>	<input type="checkbox"/>	<input checked="" type="checkbox"/>	+	.031	.008	.016	.059	.177				
	T8330	<input checked="" type="checkbox"/>	<input checked="" type="checkbox"/>	<input checked="" type="checkbox"/>	<input checked="" type="checkbox"/>	<input type="checkbox"/>	<input checked="" type="checkbox"/>	+	.031	.008	.016	.059	.177				
CCMT 433-RM	T9315	<input checked="" type="checkbox"/>	<input type="checkbox"/>	<input checked="" type="checkbox"/>	<input type="checkbox"/>	<input type="checkbox"/>	<input checked="" type="checkbox"/>	++	.047	.008	.020	.059	.177				
	T9325	<input checked="" type="checkbox"/>	<input checked="" type="checkbox"/>	<input checked="" type="checkbox"/>	<input type="checkbox"/>	<input type="checkbox"/>	<input checked="" type="checkbox"/>	+	.047	.008	.020	.059	.177				
	T8330	<input checked="" type="checkbox"/>	<input checked="" type="checkbox"/>	<input checked="" type="checkbox"/>	<input checked="" type="checkbox"/>	<input type="checkbox"/>	<input checked="" type="checkbox"/>	+	.047	.008	.020	.059	.177				
CCMT 431-RM3	T7325	<input checked="" type="checkbox"/>	<input checked="" type="checkbox"/>	<input type="checkbox"/>	<input type="checkbox"/>	<input type="checkbox"/>	<input type="checkbox"/>	<input checked="" type="checkbox"/>	++	.016	.010	.012	.016	.142			
	T9315	<input checked="" type="checkbox"/>	<input type="checkbox"/>	<input checked="" type="checkbox"/>	<input type="checkbox"/>	<input type="checkbox"/>	<input type="checkbox"/>	<input checked="" type="checkbox"/>	++	.016	.010	.012	.016	.142			
	T9325	<input checked="" type="checkbox"/>	<input checked="" type="checkbox"/>	<input checked="" type="checkbox"/>	<input type="checkbox"/>	<input type="checkbox"/>	<input type="checkbox"/>	<input checked="" type="checkbox"/>	+	.016	.010	.012	.016	.142			
CCMT 432-RM3	T7325	<input checked="" type="checkbox"/>	<input checked="" type="checkbox"/>	<input type="checkbox"/>	<input type="checkbox"/>	<input type="checkbox"/>	<input type="checkbox"/>	<input checked="" type="checkbox"/>	++	.031	.010	.016	.031	.157			
	T9315	<input checked="" type="checkbox"/>	<input type="checkbox"/>	<input checked="" type="checkbox"/>	<input type="checkbox"/>	<input type="checkbox"/>	<input type="checkbox"/>	<input checked="" type="checkbox"/>	++	.031	.010	.016	.031	.157			
	T9325	<input checked="" type="checkbox"/>	<input checked="" type="checkbox"/>	<input checked="" type="checkbox"/>	<input type="checkbox"/>	<input type="checkbox"/>	<input type="checkbox"/>	<input checked="" type="checkbox"/>	++	.031	.010	.016	.031	.157			
	T6310	<input checked="" type="checkbox"/>	<input checked="" type="checkbox"/>	<input checked="" type="checkbox"/>	<input type="checkbox"/>	<input type="checkbox"/>	<input type="checkbox"/>	<input checked="" type="checkbox"/>	+	.031	.010	.016	.031	.157			
CCMT 433-RM3	T7325*	<input checked="" type="checkbox"/>	<input checked="" type="checkbox"/>	<input type="checkbox"/>	<input type="checkbox"/>	<input type="checkbox"/>	<input type="checkbox"/>	<input checked="" type="checkbox"/>	++	.047	.010	.018	.047	.157			
	T9315	<input checked="" type="checkbox"/>	<input type="checkbox"/>	<input checked="" type="checkbox"/>	<input type="checkbox"/>	<input type="checkbox"/>	<input type="checkbox"/>	<input checked="" type="checkbox"/>	++	.047	.010	.018	.047	.157			
CCMT 21.50.5-UR	T7325	<input checked="" type="checkbox"/>	<input checked="" type="checkbox"/>	<input type="checkbox"/>	<input type="checkbox"/>	<input type="checkbox"/>	<input type="checkbox"/>	<input type="checkbox"/>	<input checked="" type="checkbox"/>	+	.008	.004	.006	.008	.079		
	T7335	<input checked="" type="checkbox"/>	<input checked="" type="checkbox"/>	<input type="checkbox"/>	<input type="checkbox"/>	<input type="checkbox"/>	<input type="checkbox"/>	<input type="checkbox"/>	<input checked="" type="checkbox"/>	++	.008	.004	.006	.008	.079		
	T9315	<input checked="" type="checkbox"/>	<input type="checkbox"/>	<input checked="" type="checkbox"/>	<input type="checkbox"/>	<input type="checkbox"/>	<input type="checkbox"/>	<input type="checkbox"/>	<input checked="" type="checkbox"/>	+	.008	.004	.006	.008	.079		
	T9325	<input checked="" type="checkbox"/>	<input checked="" type="checkbox"/>	<input checked="" type="checkbox"/>	<input type="checkbox"/>	<input type="checkbox"/>	<input type="checkbox"/>	<input type="checkbox"/>	<input checked="" type="checkbox"/>	+	.008	.004	.006	.008	.079		
	T8315	<input checked="" type="checkbox"/>	<input checked="" type="checkbox"/>	<input checked="" type="checkbox"/>	<input type="checkbox"/>	<input type="checkbox"/>	<input type="checkbox"/>	<input type="checkbox"/>	<input checked="" type="checkbox"/>	+/-	.008	.003	.006	.008	.079		
	T8330	<input checked="" type="checkbox"/>	<input checked="" type="checkbox"/>	<input checked="" type="checkbox"/>	<input type="checkbox"/>	<input type="checkbox"/>	<input type="checkbox"/>	<input type="checkbox"/>	<input checked="" type="checkbox"/>	+	.008	.003	.006	.008	.079		
	TT310	<input checked="" type="checkbox"/>	<input checked="" type="checkbox"/>	<input type="checkbox"/>	<input type="checkbox"/>	<input type="checkbox"/>	<input type="checkbox"/>	<input type="checkbox"/>	<input checked="" type="checkbox"/>	+/-	.008	.003	.006	.008	.079		
	T5315	<input checked="" type="checkbox"/>	<input type="checkbox"/>	<input checked="" type="checkbox"/>	<input type="checkbox"/>	<input type="checkbox"/>	<input type="checkbox"/>	<input type="checkbox"/>	<input checked="" type="checkbox"/>	+	.016	.004	.012	.016	.079		
CCMT 21.51-UR	T7325	<input checked="" type="checkbox"/>	<input checked="" type="checkbox"/>	<input type="checkbox"/>	<input type="checkbox"/>	<input type="checkbox"/>	<input type="checkbox"/>	<input type="checkbox"/>	<input checked="" type="checkbox"/>	++	.016	.006	.012	.016	.079		
	T7335	<input checked="" type="checkbox"/>	<input checked="" type="checkbox"/>	<input type="checkbox"/>	<input type="checkbox"/>	<input type="checkbox"/>	<input type="checkbox"/>	<input type="checkbox"/>	<input checked="" type="checkbox"/>	++	.016	.006	.012	.016	.079		
	T9315	<input checked="" type="checkbox"/>	<input type="checkbox"/>	<input checked="" type="checkbox"/>	<input type="checkbox"/>	<input type="checkbox"/>	<input type="checkbox"/>	<input type="checkbox"/>	<input checked="" type="checkbox"/>	++	.016	.006	.012	.016	.079		
	T9325	<input checked="" type="checkbox"/>	<input checked="" type="checkbox"/>	<input checked="" type="checkbox"/>	<input type="checkbox"/>	<input type="checkbox"/>	<input type="checkbox"/>	<input type="checkbox"/>	<input checked="" type="checkbox"/>	+	.016	.006	.012	.016	.079		
	T8315	<input checked="" type="checkbox"/>	<input checked="" type="checkbox"/>	<input checked="" type="checkbox"/>	<input type="checkbox"/>	<input type="checkbox"/>	<input type="checkbox"/>	<input type="checkbox"/>	<input checked="" type="checkbox"/>	+	.016	.003	.012	.016	.079		
	T8330	<input checked="" type="checkbox"/>	<input checked="" type="checkbox"/>	<input checked="" type="checkbox"/>	<input type="checkbox"/>	<input type="checkbox"/>	<input type="checkbox"/>	<input type="checkbox"/>	<input checked="" type="checkbox"/>	+	.016	.003	.012	.016	.079		
	TT310	<input checked="" type="checkbox"/>	<input checked="" type="checkbox"/>	<input type="checkbox"/>	<input type="checkbox"/>	<input type="checkbox"/>	<input type="checkbox"/>	<input type="checkbox"/>	<input checked="" type="checkbox"/>	+/-	.016	.003	.012	.016	.079		
	T5315	<input checked="" type="checkbox"/>	<input type="checkbox"/>	<input checked="" type="checkbox"/>	<input type="checkbox"/>	<input type="checkbox"/>	<input type="checkbox"/>	<input type="checkbox"/>	<input checked="" type="checkbox"/>	+	.031	.004	.020	.031	.079		
CCMT 21.52-UR	T7325	<input checked="" type="checkbox"/>	<input checked="" type="checkbox"/>	<input type="checkbox"/>	<input type="checkbox"/>	<input type="checkbox"/>	<input type="checkbox"/>	<input type="checkbox"/>	<input checked="" type="checkbox"/>	++	.031	.006	.020	.031	.079		
	T9315	<input checked="" type="checkbox"/>	<input type="checkbox"/>	<input checked="" type="checkbox"/>	<input type="checkbox"/>	<input type="checkbox"/>	<input type="checkbox"/>	<input type="checkbox"/>	<input checked="" type="checkbox"/>	++	.031	.006	.020	.031	.079		
	T9325	<input checked="" type="checkbox"/>	<input checked="" type="checkbox"/>	<input checked="" type="checkbox"/>	<input type="checkbox"/>	<input type="checkbox"/>	<input type="checkbox"/>	<input type="checkbox"/>	<input checked="" type="checkbox"/>	++	.031	.006	.020	.031	.079		
	T8330	<input checked="" type="checkbox"/>	<input checked="" type="checkbox"/>	<input checked="" type="checkbox"/>	<input type="checkbox"/>	<input type="checkbox"/>	<input type="checkbox"/>	<input type="checkbox"/>	<input checked="" type="checkbox"/>	+	.031	.003	.020	.031	.079		
	TT310	<input checked="" type="checkbox"/>	<input checked="" type="checkbox"/>	<input type="checkbox"/>	<input type="checkbox"/>	<input type="checkbox"/>	<input type="checkbox"/>	<input type="checkbox"/>	<input checked="" type="checkbox"/>	+/-	.008	.003	.006	.008	.118		
CCMT 32.50.5-UR	TT310	<input checked="" type="checkbox"/>	<input checked="" type="checkbox"/>	<input type="checkbox"/>	<input type="checkbox"/>	<input type="checkbox"/>	<input type="checkbox"/>	<input type="checkbox"/>	<input checked="" type="checkbox"/>	+/-	.008	.003	.006	.008	.118		
	CCMT 32.51-UR	T5315	<input checked="" type="checkbox"/>	<input type="checkbox"/>	<input checked="" type="checkbox"/>	<input type="checkbox"/>	<input type="checkbox"/>	<input type="checkbox"/>	<input type="checkbox"/>	<input checked="" type="checkbox"/>	+	.016	.004	.012	.016	.079	
		T7325	<input checked="" type="checkbox"/>	<input checked="" type="checkbox"/>	<input type="checkbox"/>	<input type="checkbox"/>	<input type="checkbox"/>	<input type="checkbox"/>	<input type="checkbox"/>	<input checked="" type="checkbox"/>	++	.016	.006	.012	.016	.079	
		T7335	<input checked="" type="checkbox"/>	<input checked="" type="checkbox"/>	<input type="checkbox"/>	<input type="checkbox"/>	<input type="checkbox"/>	<input type="checkbox"/>	<input type="checkbox"/>	<input checked="" type="checkbox"/>	++	.016	.006	.012	.016	.079	
		T9310	<input checked="" type="checkbox"/>	<input type="checkbox"/>	<input checked="" type="checkbox"/>	<input type="checkbox"/>	<input type="checkbox"/>	<input type="checkbox"/>	<input type="checkbox"/>	<input checked="" type="checkbox"/>	+	.016	.006	.012	.016	.079	
		T9315	<input checked="" type="checkbox"/>	<input type="checkbox"/>	<input checked="" type="checkbox"/>	<input type="checkbox"/>	<input type="checkbox"/>	<input type="checkbox"/>	<input type="checkbox"/>	<input checked="" type="checkbox"/>	++	.016	.006	.012	.016	.079	
		T9325	<input checked="" type="checkbox"/>	<input checked="" type="checkbox"/>	<input checked="" type="checkbox"/>	<input type="checkbox"/>	<input type="checkbox"/>	<input type="checkbox"/>	<input type="checkbox"/>	<input checked="" type="checkbox"/>	+	.016	.006	.012	.016	.079	
T8315		<input checked="" type="checkbox"/>	<input checked="" type="checkbox"/>	<input checked="" type="checkbox"/>	<input type="checkbox"/>	<input type="checkbox"/>	<input type="checkbox"/>	<input type="checkbox"/>	<input checked="" type="checkbox"/>	+	.016	.003	.012	.016	.079		

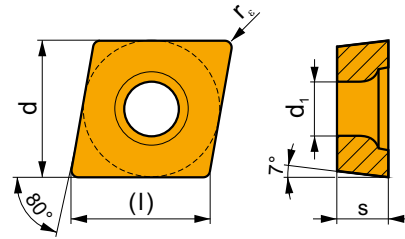
\* Non-stocked item

i	ANSI		P	M	K	N	S	H			r <sub>c</sub>	f <sub>min</sub>	f <sub>max</sub>	a <sub>p min</sub>	a <sub>p max</sub>	 		
																?	?	
 	CCMT 32.51-UR	T8330	■	■	■	□			●	+	.016	.003	.012	.016	.079			
		TT310	■	▣						●	+/-	.016	.003	.012	.016	.118		
	CCMT 32.52-UR	T5315	▣	□	■					●	+	.031	.004	.020	.031	.118		
		T7325	▣	■						●	++	.031	.006	.020	.031	.118		
		T7335	▣	■						●	++	.031	.006	.020	.031	.118		
		T9310	■		▣					●	+	.031	.006	.020	.031	.118		
		T9315	■		▣					●	++	.031	.006	.020	.031	.118		
		T9325	■	■	▣					●	++	.031	.006	.020	.031	.118		
		T8315	▣	■	■	□				●	+	.031	.003	.020	.031	.118		
		T8330	■	■	■	□				●	+	.031	.003	.020	.031	.118		
	TT310	■	▣						●	+/-	.031	.003	.020	.031	.118			
	CCMT 431-UR	T5315	▣	□	■					●	+	.016	.004	.012	.016	.118		
		T7325	▣	■						●	++	.016	.006	.012	.016	.118		
		T9315	■		▣					●	++	.016	.006	.012	.016	.118		
T9325		■	■	▣					●	+	.016	.006	.012	.016	.118			
T8330		■	■	■	□				●	+	.016	.003	.012	.016	.118			
CCMT 432-UR		T5315	▣	□	■					●	+	.031	.004	.020	.031	.157		
	T7325	▣	■						●	++	.031	.006	.020	.031	.157			
	T7335	▣	■						●	++	.031	.006	.020	.031	.157			
	T9315	■		▣					●	++	.031	.006	.020	.031	.157			
	T9325	■	■	▣					●	++	.031	.006	.020	.031	.157			
	T8330	■	■	■	□				●	+	.031	.003	.020	.031	.157			
CCMT 433-UR	T5315	▣	□	■					●	+	.047	.004	.020	.047	.157			
	T7325	▣	■						●	++	.047	.006	.020	.047	.157			
	T9315	■		▣					●	++	.047	.006	.020	.047	.157			
	T9325	■	■	▣					●	++	.047	.006	.020	.047	.157			
 	CCMT 21.51W-FM	T9315	■		▣				●	++	.016	.006	.016	.012	.079			
		T9325	■	■	▣		□			●	+	.016	.006	.016	.012	.079		
	CCMT 32.51W-FM	T7325	▣	■			□			●	++	.016	.006	.016	.012	.079		
		T9315	■		▣					●	++	.016	.006	.016	.012	.079		
		T9325	■	■	▣		□			●	+	.016	.006	.016	.012	.079		
		T8330	■	■	▣		□			●	+	.016	.004	.016	.012	.079		
CCMT 32.52W-FM	T9315	■		▣					●	++	.031	.006	.016	.020	.118			
	T9325	■	■	▣		□			●	+	.031	.006	.016	.020	.118			
	T8330	■	■	▣		□			●	+	.031	.006	.016	.020	.118			
 	CCMT 21.51W-UR	TT310	■	▣					●	+/-	.016	.003	.012	.016	.079			
	CCMT 32.52W-UR	TT310	■	▣					●	+/-	.031	.003	.020	.031	.118			




















# CCMW

	d	d <sub>1</sub>	l	s
21.5	.250	.110	.252	.094
32.5	.375	.173	.382	.156
43	.500	.217	.508	.187



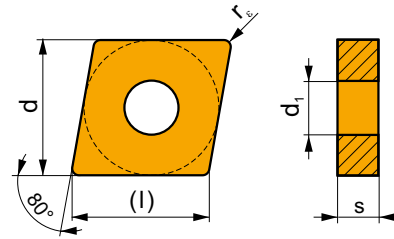
For tools see pages: T203, T219

		ANSI		P	M	K	N	S	H			r <sub>e</sub>	f <sub>min</sub>	f <sub>max</sub>	a <sub>p min</sub>	a <sub>p max</sub>
CCMW 21.50.5		T5305		<input type="checkbox"/>	<input type="checkbox"/>	<input checked="" type="checkbox"/>	<input type="checkbox"/>	<input type="checkbox"/>	<input checked="" type="checkbox"/>	<input checked="" type="checkbox"/>	+ / -	.008	.004	.006	.008	.165
				<input checked="" type="checkbox"/>	<input type="checkbox"/>	<input checked="" type="checkbox"/>	<input type="checkbox"/>	<input type="checkbox"/>	<input checked="" type="checkbox"/>	<input checked="" type="checkbox"/>	+	.008	.002	.006	.008	.165
CCMW 21.51		T5305		<input type="checkbox"/>	<input type="checkbox"/>	<input checked="" type="checkbox"/>	<input type="checkbox"/>	<input type="checkbox"/>	<input checked="" type="checkbox"/>	<input checked="" type="checkbox"/>	+	.016	.004	.012	.016	.165
				<input checked="" type="checkbox"/>	<input type="checkbox"/>	<input checked="" type="checkbox"/>	<input type="checkbox"/>	<input type="checkbox"/>	<input checked="" type="checkbox"/>	<input checked="" type="checkbox"/>	+	.016	.004	.012	.016	.165
CCMW 32.51		T5305		<input type="checkbox"/>	<input type="checkbox"/>	<input checked="" type="checkbox"/>	<input type="checkbox"/>	<input type="checkbox"/>	<input checked="" type="checkbox"/>	<input checked="" type="checkbox"/>	+	.016	.004	.012	.016	.248
				<input checked="" type="checkbox"/>	<input type="checkbox"/>	<input checked="" type="checkbox"/>	<input type="checkbox"/>	<input type="checkbox"/>	<input checked="" type="checkbox"/>	<input checked="" type="checkbox"/>	+	.016	.004	.012	.016	.248
				<input checked="" type="checkbox"/>	<input type="checkbox"/>	<input checked="" type="checkbox"/>	<input type="checkbox"/>	<input type="checkbox"/>	<input checked="" type="checkbox"/>	<input checked="" type="checkbox"/>	+	.016	.002	.012	.016	.165
CCMW 32.52		T5305		<input type="checkbox"/>	<input type="checkbox"/>	<input checked="" type="checkbox"/>	<input type="checkbox"/>	<input type="checkbox"/>	<input checked="" type="checkbox"/>	<input checked="" type="checkbox"/>	+	.031	.004	.014	.031	.248
				<input checked="" type="checkbox"/>	<input type="checkbox"/>	<input checked="" type="checkbox"/>	<input type="checkbox"/>	<input type="checkbox"/>	<input checked="" type="checkbox"/>	<input checked="" type="checkbox"/>	+	.031	.004	.014	.031	.248
				<input checked="" type="checkbox"/>	<input type="checkbox"/>	<input checked="" type="checkbox"/>	<input type="checkbox"/>	<input type="checkbox"/>	<input checked="" type="checkbox"/>	<input checked="" type="checkbox"/>	+	.031	.002	.014	.031	.248
CCMW 431		T5305		<input type="checkbox"/>	<input type="checkbox"/>	<input checked="" type="checkbox"/>	<input type="checkbox"/>	<input type="checkbox"/>	<input checked="" type="checkbox"/>	<input checked="" type="checkbox"/>	+	.016	.004	.012	.016	.331
				<input checked="" type="checkbox"/>	<input type="checkbox"/>	<input checked="" type="checkbox"/>	<input type="checkbox"/>	<input type="checkbox"/>	<input checked="" type="checkbox"/>	<input checked="" type="checkbox"/>	+	.016	.004	.012	.016	.331
				<input checked="" type="checkbox"/>	<input type="checkbox"/>	<input checked="" type="checkbox"/>	<input type="checkbox"/>	<input type="checkbox"/>	<input checked="" type="checkbox"/>	<input checked="" type="checkbox"/>	+	.016	.002	.012	.016	.331
CCMW 432		T5305		<input type="checkbox"/>	<input type="checkbox"/>	<input checked="" type="checkbox"/>	<input type="checkbox"/>	<input type="checkbox"/>	<input checked="" type="checkbox"/>	<input checked="" type="checkbox"/>	+	.031	.004	.016	.031	.331
				<input checked="" type="checkbox"/>	<input type="checkbox"/>	<input checked="" type="checkbox"/>	<input type="checkbox"/>	<input type="checkbox"/>	<input checked="" type="checkbox"/>	<input checked="" type="checkbox"/>	+	.031	.004	.016	.031	.331
				<input checked="" type="checkbox"/>	<input type="checkbox"/>	<input checked="" type="checkbox"/>	<input type="checkbox"/>	<input type="checkbox"/>	<input checked="" type="checkbox"/>	<input checked="" type="checkbox"/>	+	.031	.002	.016	.031	.331



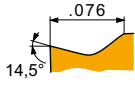
## CNGG

	d	d <sub>1</sub>	l	s
43	.500	.203	.508	.187



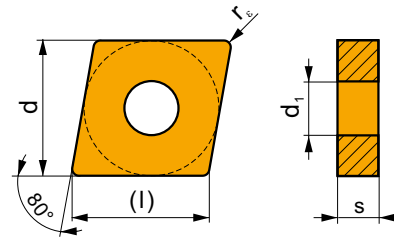
For tools see pages: T184-T185, T187, T215

		ANSI		P	M	K	N	S	H			r <sub>c</sub>	f <sub>min</sub>	f <sub>max</sub>	a <sub>p min</sub>	a <sub>p max</sub>		
   	 	CNGG 430.5-SF	 T6310 T8315 T8330 H07	<input checked="" type="checkbox"/>	<input checked="" type="checkbox"/>	<input type="checkbox"/>	<input checked="" type="checkbox"/>	<input type="checkbox"/>	<input type="checkbox"/>	<input checked="" type="checkbox"/>	+	.008	.003	.006	.008	.098		
				<input checked="" type="checkbox"/>	<input checked="" type="checkbox"/>	<input type="checkbox"/>	<input type="checkbox"/>	<input type="checkbox"/>	<input checked="" type="checkbox"/>	<input type="checkbox"/>	<input type="checkbox"/>	<input checked="" type="checkbox"/>	+/-	.008	.003	.006	.008	.098
				<input checked="" type="checkbox"/>	<input checked="" type="checkbox"/>	<input type="checkbox"/>	<input type="checkbox"/>	<input checked="" type="checkbox"/>	<input type="checkbox"/>	<input type="checkbox"/>	<input type="checkbox"/>	<input checked="" type="checkbox"/>	+	.008	.003	.006	.008	.098
				<input type="checkbox"/>	<input checked="" type="checkbox"/>	<input type="checkbox"/>	<input checked="" type="checkbox"/>	<input type="checkbox"/>	<input type="checkbox"/>	<input type="checkbox"/>	<input checked="" type="checkbox"/>	<input type="checkbox"/>	<input checked="" type="checkbox"/>	+	.008	.003	.006	.008











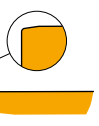
## CNMA

	d	d <sub>1</sub>	l	s
43	.500	.203	.508	.187
54	.625	.250	.634	.250
64	.750	.313	.760	.250




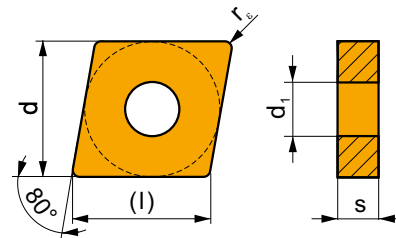
For tools see pages: T184-T185, T187, T215

		ANSI		P	M	K	N	S	H			r <sub>c</sub>	f <sub>min</sub>	f <sub>max</sub>	a <sub>p min</sub>	a <sub>p max</sub>	
   	 	CNMA 431	T5305	<input type="checkbox"/>	<input type="checkbox"/>	<input checked="" type="checkbox"/>	<input type="checkbox"/>	<input type="checkbox"/>	<input checked="" type="checkbox"/>	<input checked="" type="checkbox"/>	+	.016	.004	.012	.016	.331	
			T5315	<input checked="" type="checkbox"/>	<input type="checkbox"/>	<input checked="" type="checkbox"/>	<input type="checkbox"/>	<input type="checkbox"/>	<input type="checkbox"/>	<input type="checkbox"/>	<input checked="" type="checkbox"/>	+	.016	.004	.012	.016	.331
		CNMA 432	T5305	<input type="checkbox"/>	<input type="checkbox"/>	<input checked="" type="checkbox"/>	<input type="checkbox"/>	<input type="checkbox"/>	<input type="checkbox"/>	<input checked="" type="checkbox"/>	<input checked="" type="checkbox"/>	+	.031	.004	.024	.031	.331
			T5315	<input checked="" type="checkbox"/>	<input type="checkbox"/>	<input checked="" type="checkbox"/>	<input type="checkbox"/>	<input type="checkbox"/>	<input type="checkbox"/>	<input type="checkbox"/>	<input checked="" type="checkbox"/>	++	.031	.004	.024	.031	.331
			T6310	<input checked="" type="checkbox"/>	<input type="checkbox"/>	<input checked="" type="checkbox"/>	<input type="checkbox"/>	<input checked="" type="checkbox"/>	<input type="checkbox"/>	<input type="checkbox"/>	<input checked="" type="checkbox"/>	++	.031	.002	.024	.031	.331
		CNMA 433	T5305	<input type="checkbox"/>	<input type="checkbox"/>	<input checked="" type="checkbox"/>	<input type="checkbox"/>	<input type="checkbox"/>	<input type="checkbox"/>	<input checked="" type="checkbox"/>	<input checked="" type="checkbox"/>	+	.047	.004	.024	.047	.331
			T5315	<input checked="" type="checkbox"/>	<input type="checkbox"/>	<input checked="" type="checkbox"/>	<input type="checkbox"/>	<input type="checkbox"/>	<input type="checkbox"/>	<input type="checkbox"/>	<input checked="" type="checkbox"/>	++	.047	.004	.024	.047	.331
			T6310	<input checked="" type="checkbox"/>	<input type="checkbox"/>	<input checked="" type="checkbox"/>	<input type="checkbox"/>	<input checked="" type="checkbox"/>	<input type="checkbox"/>	<input type="checkbox"/>	<input checked="" type="checkbox"/>	++	.047	.002	.024	.047	.331
		CNMA 434	T5305	<input type="checkbox"/>	<input type="checkbox"/>	<input checked="" type="checkbox"/>	<input type="checkbox"/>	<input type="checkbox"/>	<input type="checkbox"/>	<input checked="" type="checkbox"/>	<input checked="" type="checkbox"/>	+	.063	.004	.024	.063	.331
			T5315	<input checked="" type="checkbox"/>	<input type="checkbox"/>	<input checked="" type="checkbox"/>	<input type="checkbox"/>	<input type="checkbox"/>	<input type="checkbox"/>	<input type="checkbox"/>	<input checked="" type="checkbox"/>	++	.063	.004	.024	.063	.331
		CNMA 543	T5305	<input type="checkbox"/>	<input type="checkbox"/>	<input checked="" type="checkbox"/>	<input type="checkbox"/>	<input type="checkbox"/>	<input type="checkbox"/>	<input checked="" type="checkbox"/>	<input checked="" type="checkbox"/>	+	.047	.004	.024	.047	.335
			T5315	<input checked="" type="checkbox"/>	<input type="checkbox"/>	<input checked="" type="checkbox"/>	<input type="checkbox"/>	<input type="checkbox"/>	<input type="checkbox"/>	<input type="checkbox"/>	<input checked="" type="checkbox"/>	++	.047	.004	.024	.047	.335
T6310	<input checked="" type="checkbox"/>		<input type="checkbox"/>	<input checked="" type="checkbox"/>	<input type="checkbox"/>	<input checked="" type="checkbox"/>	<input type="checkbox"/>	<input type="checkbox"/>	<input checked="" type="checkbox"/>	++	.047	.002	.024	.047	.335		
CNMA 544	T5305	<input type="checkbox"/>	<input type="checkbox"/>	<input checked="" type="checkbox"/>	<input type="checkbox"/>	<input type="checkbox"/>	<input type="checkbox"/>	<input checked="" type="checkbox"/>	<input checked="" type="checkbox"/>	+	.063	.004	.024	.063	.335		
	T5315	<input checked="" type="checkbox"/>	<input type="checkbox"/>	<input checked="" type="checkbox"/>	<input type="checkbox"/>	<input type="checkbox"/>	<input type="checkbox"/>	<input type="checkbox"/>	<input checked="" type="checkbox"/>	++	.063	.004	.024	.063	.335		
CNMA 643	T5305	<input type="checkbox"/>	<input type="checkbox"/>	<input checked="" type="checkbox"/>	<input type="checkbox"/>	<input type="checkbox"/>	<input type="checkbox"/>	<input checked="" type="checkbox"/>	<input checked="" type="checkbox"/>	++	.047	.004	.035	.047	.500		












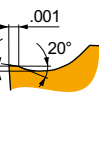
		ANSI		P	M	K	N	S	H			$r_c$	$f_{min}$	$f_{max}$	$a_{p min}$	$a_{p max}$	
 		CNMA 643	T5315	█	□	█			□	●	++	.047	.004	.035	.047	.500	
			T6310	█	□	█			█	●	++	.047	.002	.035	.047	.500	
		CNMA 644	T5305	□		█				█	●	++	.063	.004	.035	.063	.500
			T5315	█	□	█				□	●	++	.063	.004	.035	.063	.500
 		CNMA 432S	T5305	□		█			█	●	+	.031	.004	.024	.031	.331	
		CNMA 433S	T5305	□		█			█	●	+	.047	.004	.024	.063	.331	
		CNMA 543S	T5305	□		█			█	●	+	.047	.004	.024	.047	.335	
		CNMA 644S	T5305	□		█			█	●	++	.063	.004	.035	.063	.500	

## CNMG

	d	d <sub>1</sub>	l	s
32	.375	.150	.382	.125
43	.500	.203	.508	.187
54	.625	.250	.634	.250
64	.750	.313	.760	.250
86	1.000	.359	.016	.375



For tools see pages: T184-T185, T187, T215

		ANSI		P	M	K	N	S	H			$r_c$	$f_{min}$	$f_{max}$	$a_{p min}$	$a_{p max}$
 		CNMG 431-FF	T7325	█	█				□	●	+	.016	.004	.006	.016	.059
			T8315	█	█	█	□	□		●	+/-	.016	.002	.006	.016	.059
 		CNMG 432-FF	T7325	█	█				□	●	+	.031	.006	.008	.031	.059
			T8315	█	█	█	□	□		●	+/-	.031	.003	.008	.031	.059
  		CNMG 321-FM	T7325	█	█				□	●	++	.016	.006	.012	.020	.248
			T9315	█	█	█				●	++	.016	.006	.012	.020	.248
			T9325	█	█	█		□		●	+	.016	.006	.012	.020	.248
			T8330	█	█	█		□		●	+	.016	.004	.012	.020	.248
		CNMG 322-FM	T7325	█	█				□	●	++	.031	.006	.018	.031	.118
			T9315	█	█	█				●	++	.031	.006	.018	.031	.118
			T9325	█	█	█		□		●	++	.031	.006	.018	.031	.118
			T8330	█	█	█		□		●	++	.031	.004	.018	.031	.118
		CNMG 431-FM	T7325	█	█				□	●	++	.016	.006	.012	.020	.118
			T7335	█	█				□	●	++	.016	.006	.012	.020	.118
T9310	█		█	█				●	+	.016	.006	.012	.020	.118		
T9315	█		█	█				●	++	.016	.006	.012	.020	.118		
T9325	█		█	█		□		●	+	.016	.006	.012	.020	.118		
T8315	█		█	█		□		●	+	.016	.004	.012	.020	.118		
CNMG 432-FM	T8330	█	█	█		□		●	+	.016	.004	.012	.020	.118		
	TT310	█	█					●	+/-	.016	.004	.012	.020	.118		
	T7325	█	█				□	●	++	.031	.006	.018	.031	.118		
	T7335	█	█				□	●	++	.031	.006	.018	.031	.118		

i	ANSI		P	M	K	N	S	H			r <sub>c</sub>	f <sub>min</sub>	f <sub>max</sub>	a <sub>p min</sub>	a <sub>p max</sub>
   	CNMG 432-FM	T9310	■	■	■				●	+	.031	.006	.018	.031	.118
		T9315	■	■	■				●	++	.031	.006	.018	.031	.118
		T9325	■	■	■		□		●	++	.031	.006	.018	.031	.118
		T8315	■	■	■		□		●	+	.031	.006	.018	.031	.118
		T8330	■	■	■		□		●	++	.031	.006	.018	.031	.118
		TT310	■	■	■				●	+/-	.031	.006	.018	.031	.118
		T7325	■	■	■		□		●	++	.047	.006	.018	.047	.157
  	CNMG 433-FM	T9315	■	■	■				●	++	.047	.006	.018	.047	.157
		T9325	■	■	■		□		●	++	.047	.006	.018	.047	.157
		T9315	■	■	■				●	++	.031	.010	.024	.031	.276
		T5315	■	■	■		□		●	++	.031	.010	.024	.031	.276
		T5305	■	■	■				●	++	.047	.010	.028	.047	.276
		T5315	■	■	■		□		●	++	.047	.010	.028	.047	.276
		T5305	■	■	■				●	++	.031	.010	.024	.031	.276
  	CNMG 322-M	T9315	■	■	■			□	●	++	.031	.006	.024	.031	.157
		T9325	■	■	■				●	++	.031	.006	.024	.031	.157
		T9335	■	■	■				●	+++	.031	.006	.024	.031	.157
	CNMG 431-M	T5315	■	■	■			□	●	+	.016	.007	.012	.031	.236
		T9310	■	■	■				●	+	.016	.007	.012	.031	.236
		T9315	■	■	■			□	●	++	.016	.007	.012	.031	.236
		T9325	■	■	■				●	+	.016	.007	.012	.031	.236
		T9335	■	■	■				●	++	.016	.007	.012	.031	.236
	CNMG 432-M	T5305	■	■	■			□	●	+	.031	.007	.024	.031	.236
		T5315	■	■	■			□	●	++	.031	.007	.024	.031	.236
		T9310	■	■	■				●	++	.031	.007	.024	.031	.236
		T9315	■	■	■			□	●	++	.031	.007	.024	.031	.236
		T9325	■	■	■				●	++	.031	.007	.024	.031	.236
		T9335	■	■	■				●	+++	.031	.007	.024	.031	.236
		T8330	■	■	■			□	●	++	.031	.007	.024	.031	.236
	CNMG 433-M	T5305	■	■	■			□	●	++	.047	.007	.031	.047	.236
		T5315	■	■	■			□	●	++	.047	.007	.031	.047	.236
		T9310	■	■	■				●	++	.047	.007	.031	.047	.236
		T9315	■	■	■			□	●	++	.047	.007	.031	.047	.236
		T9325	■	■	■				●	++	.047	.007	.031	.047	.236
	CNMG 434-M	T9335	■	■	■				●	++	.047	.007	.031	.047	.236
		T9335	■	■	■				●	+++	.047	.007	.031	.047	.236
		T5305	■	■	■			□	●	++	.063	.007	.031	.063	.236
		T9325	■	■	■				●	++	.063	.007	.031	.063	.236
		T9335	■	■	■				●	+++	.063	.007	.031	.063	.236
	CNMG 542-M	T9310	■	■	■				●	++	.031	.007	.024	.031	.276
		T9315	■	■	■			□	●	++	.031	.007	.024	.031	.276
T9325		■	■	■				●	++	.031	.007	.024	.031	.276	
T9335		■	■	■				●	+++	.031	.007	.024	.031	.276	
CNMG 543-M	T9315	■	■	■			□	●	++	.047	.007	.024	.047	.276	
	T9325	■	■	■				●	++	.047	.007	.024	.047	.276	
	T9335	■	■	■				●	+++	.047	.007	.024	.047	.276	
CNMG 544-M	T9325	■	■	■				●	++	.063	.007	.024	.063	.276	
	T9335	■	■	■				●	+++	.063	.007	.024	.063	.276	
CNMG 642-M	T9315	■	■	■			□	●	++	.031	.007	.024	.031	.315	
	T9325	■	■	■				●	++	.031	.007	.024	.031	.315	
	T9335	■	■	■				●	+++	.031	.007	.024	.031	.315	
CNMG 643-M	T9310	■	■	■				●	++	.047	.007	.031	.047	.315	
	T9315	■	■	■			□	●	++	.047	.007	.031	.047	.315	
	T9325	■	■	■				●	++	.047	.007	.031	.047	.315	
	T9335	■	■	■				●	+++	.047	.007	.031	.047	.315	
CNMG 644-M	T9310*	■	■	■				●	++	.063	.007	.031	.063	.315	
	T9315	■	■	■			□	●	++	.063	.007	.031	.063	.315	
	T9325	■	■	■				●	++	.063	.007	.031	.063	.315	
	T9335	■	■	■				●	+++	.063	.007	.031	.063	.315	

\* Non-stocked item



ANSI



P

M

K

N

S

H

 $r_c$  $f_{min}$  $f_{max}$  $a_{pmin}$  $a_{pmax}$ 

CNMG 321-NF

T7335



++

.016

.004

.012

.016

.118

T9325



+

.016

.004

.012

.016

.118

T6310



+

.016

.004

.012

.016

.118

T8315



+

.016

.004

.012

.016

.118

CNMG 322-NF

T7335



++

.031

.006

.012

.031

.118

T9325



+

.031

.006

.012

.031

.118

T6310



+

.031

.005

.012

.031

.118

T8330



+

.031

.005

.012

.031

.118

CNMG 431-NF

T7325



++

.016

.006

.012

.016

.118

T7335



++

.016

.006

.012

.016

.118

T9315



++

.016

.006

.012

.016

.118

T9325



+

.016

.006

.012

.016

.118

T6310



+

.016

.005

.012

.016

.118

T8315



+

.016

.005

.012

.016

.118

T8330



+

.016

.005

.012

.016

.118

HF7



+

.016

.005

.012

.016

.118

CNMG 432-NF

T7325



++

.031

.006

.014

.031

.138

T7335



++

.031

.006

.014

.031

.138

T9315



++

.031

.006

.014

.031

.138

T9325



+

.031

.006

.014

.031

.138

T6310



+

.031

.006

.014

.031

.138

T8315



+

.031

.006

.014

.031

.138

T8330



+

.031

.006

.014

.031

.138

HF7



+

.031

.006

.014

.031

.138

CNMG 433-NF

T7325



i	ANSI		P	M	K	N	S	H			r <sub>c</sub>	f <sub>min</sub>	f <sub>max</sub>	a <sub>p min</sub>	a <sub>p max</sub>	
																1
   	<b>CNMG 643-NM</b> 	T7325	█	█			█		⊕	++	.047	.012	.020	.047	.315	
		T7335	█	█						⊕	++	.047	.012	.020	.047	.315
		T9325	█	█	□			□		⊕	++	.047	.012	.020	.047	.315
		T8315	█	█	□	□	□			⊕	+	.047	.012	.020	.047	.315
		T8330	█	█	□	□	█			⊕	++	.047	.012	.020	.047	.315
	<b>CNMG 322-NMR</b>	T7325	█	█			█		⊕	++	.031	.008	.016	.031	.118	
		T7335	█	█			█		⊕	++	.031	.008	.016	.031	.118	
		T9325	█	█			█		⊕	+	.031	.008	.016	.031	.118	
	<b>CNMG 431-NMR</b>	T6310	█	█			█		⊙	+	.016	.008	.012	.016	.157	
		T7325	█	█			█		⊙	++	.016	.008	.012	.016	.157	
		T7335	█	█			█		⊙	++	.016	.008	.012	.016	.157	
		T9315	█	█					⊙	+	.016	.008	.012	.016	.157	
		T9325	█	█			█		⊙	+	.016	.008	.012	.016	.157	
	<b>CNMG 432-NMR</b>	T8330	█	█			█		⊕	+	.016	.008	.012	.016	.157	
		T6310	█	█			█		⊕	++	.031	.008	.022	.031	.197	
		T7325	█	█			█		⊕	++	.031	.008	.022	.031	.197	
		T7335	█	█			█		⊕	++	.031	.008	.022	.031	.197	
T9315		█	█					⊕	++	.031	.008	.022	.031	.197		
<b>CNMG 433-NMR</b>	T9325	█	█			█		⊕	++	.031	.008	.022	.031	.197		
	T8330	█	█			█		⊕	++	.031	.008	.022	.031	.197		
	T6310	█	█			█		⊕	++	.047	.009	.024	.047	.217		
	T7325	█	█			█		⊕	++	.047	.009	.024	.047	.217		
	T7335	█	█			█		⊕	+++	.047	.009	.024	.047	.217		
<b>CNMG 434-NMR</b>	T9315	█	█					⊕	++	.047	.009	.024	.047	.217		
	T9325	█	█			█		⊕	++	.047	.009	.024	.047	.217		
	T8330	█	█			█		⊕	++	.047	.009	.024	.047	.217		
	T7325	█	█			█		⊕	++	.063	.010	.026	.063	.217		
	T7335	█	█			█		⊕	+++	.063	.010	.026	.063	.217		
<b>CNMG 542-NMR</b>	T9325	█	█			█		⊕	++	.063	.010	.026	.063	.217		
	T7325	█	█			█		⊕	++	.031	.009	.022	.031	.256		
	T7335	█	█			█		⊕	++	.031	.009	.022	.031	.256		
	T9315	█	█					⊕	++	.031	.009	.022	.031	.256		
	T9325	█	█			█		⊕	++	.031	.009	.022	.031	.256		
<b>CNMG 543-NMR</b>	T9325	█	█			█		⊕	++	.047	.009	.026	.047	.276		
	T7325	█	█			█		⊕	++	.047	.009	.026	.047	.276		
	T7335	█	█			█		⊕	+++	.047	.009	.026	.047	.276		
	T9315	█	█					⊕	++	.047	.009	.026	.047	.276		
	T9325	█	█			█		⊕	++	.047	.009	.026	.047	.276		
<b>CNMG 544-NMR</b>	T8330	█	█			█		⊕	++	.047	.009	.026	.047	.276		
	T7325	█	█			█		⊕	++	.063	.010	.028	.063	.276		
	T7335	█	█			█		⊕	+++	.063	.010	.028	.063	.276		
	T9325	█	█			█		⊕	++	.063	.010	.028	.063	.276		
	T8330	█	█			█		⊕	++	.063	.010	.028	.063	.276		
<b>CNMG 642-NMR</b>	T9325	█	█			█		⊕	++	.063	.010	.028	.063	.276		
	T6310	█	█			█		⊕	++	.031	.008	.024	.031	.295		
	T7325	█	█			█		⊕	++	.031	.008	.024	.031	.295		
	T7335	█	█			█		⊕	++	.031	.008	.024	.031	.295		
	T9315	█	█					⊕	++	.031	.008	.024	.031	.295		
<b>CNMG 643-NMR</b>	T9325	█	█			█		⊕	++	.031	.008	.024	.031	.295		
	T6310	█	█			█		⊕	++	.047	.009	.026	.047	.315		
	T7325	█	█			█		⊕	++	.047	.009	.026	.047	.315		
	T7335	█	█			█		⊕	+++	.047	.009	.026	.047	.315		
	T9315	█	█					⊕	++	.047	.009	.026	.047	.315		
<b>CNMG 644-NMR</b>	T9325	█	█			█		⊕	++	.047	.009	.026	.047	.315		
	T8330	█	█			█		⊕	++	.047	.009	.026	.047	.315		
	T7325	█	█			█		⊕	++	.063	.010	.028	.063	.315		
	T7335	█	█			█		⊕	+++	.063	.010	.028	.063	.315		
	T9315	█	█					⊕	++	.063	.010	.028	.063	.315		



ANSI



P

M

K

N

S

H

 $r_c$  $f_{min}$  $f_{max}$  $a_{p min}$  $a_{p max}$ 

CNMG 432-NRM

T7325



++

.031

.009

.022

.031

.276

T7335



++

.031

.009

.022

.031

.276

T9315



++

.031

.009

.022

.031

.276

CNMG 433-NRM

T7325



++

.047

.010

.028

.047

.276

T7335



+++

.047

.010

.028

.047

.276

T9315



++

.047

.010

.028

.047

.276

CNMG 434-NRM

T7325



++

.063

.012

.030

.063

.276

T7335\*



+++

.063

.012

.030

.063

.276

T9315



++

.063

.012

.030

.063

.276

CNMG 542-NRM

T7325



++

.031

.011

.024

.031

.315

T7335\*



+++

.031

.011

.024

.031

.315

T9315



++

.031

.011

.024

.031

.315

CNMG 543-NRM

T7325



++

.047

.011

.028

.047

.315

T7335



+++

.047

.011

.028

.047

.315

T9315



++

.047

.011

.028

.047

.315

CNMG 544-NRM

T7325



++

.063

.012

.031

.063

.315

T7335



+++

.063

.012

.031

.063

.315

T9315



++

.063

.012

.031

.063

.315

CNMG 642-NRM

T7325



++

.031

.011

.024

.031

.394

T7335\*



+++

.031

.011

.024

.031

.394

T9315



++

.031

.011

.024

.031

.394

CNMG 643-NRM

T6310



++

.047

.009

.026

.047

.315

T7325



++

.047

.013

.028

.047

.394

T7335



+++

.047

.013

.028

.047

i	ANSI	Image	P	M	K	N	S	H	?	Image	r <sub>c</sub>	f <sub>min</sub>	f <sub>max</sub>	a <sub>p min</sub>	a <sub>p max</sub>			
	CNMG 644-R		T5315	█	□	█		□	●	+	.063	.010	.028	.079	.354			
			T9310	█		█		□	●	+	.063	.010	.028	.079	.354			
			T9315	█		█		□	●	+	.063	.010	.028	.079	.354			
			T9325	█	█	█			●	+	.063	.010	.028	.079	.354			
			T9335	█	█				●	+++	.063	.010	.028	.079	.354			
	CNMG 432-RM		T5305	□		█		□	●	+	.031	.008	.020	.039	.276			
			T5315	█	□	█		□	●	+	.031	.008	.020	.039	.276			
			T7325	█	█		█		●	++	.031	.008	.020	.039	.276			
			T7335	█	█		█		●	++	.031	.008	.020	.039	.276			
			T9310	█		█			●	+	.031	.008	.020	.039	.276			
			T9315	█		█		□	●	++	.031	.008	.020	.039	.276			
			T9325	█	█	█		□	●	+	.031	.008	.020	.039	.276			
			T9335	█	█				●	++	.031	.008	.020	.039	.276			
			T6310	█	█	█		█	□	●	+	.031	.008	.020	.039	.276		
			T8315	█	█	█		□	□	●	+	.031	.008	.020	.039	.276		
			T8330	█	█	█		█	□	●	+	.031	.008	.020	.039	.276		
				CNMG 433-RM		T5305	□		█		□	●	++	.047	.010	.028	.059	.276
						T5315	█	□	█		□	●	++	.047	.010	.028	.059	.276
T7325	█	█					█		●	++	.047	.010	.028	.059	.276			
T7335	█	█					█		●	+++	.047	.010	.028	.059	.276			
T9310	█					█			●	++	.047	.010	.028	.059	.276			
T9315	█					█		□	●	++	.047	.010	.028	.059	.276			
T9325	█	█				█		□	●	++	.047	.010	.028	.059	.276			
T9335	█	█							●	+++	.047	.010	.028	.059	.276			
T6310	█	█				█		█	□	●	++	.047	.010	.028	.059	.276		
T8315	█	█				█		□	□	●	++	.047	.010	.028	.059	.276		
T8330	█	█				█		█	□	●	+	.047	.010	.028	.059	.276		
	CNMG 434-RM					T5305	□		█		□	●	++	.063	.012	.030	.079	.276
						T5315	█	□	█		□	●	++	.063	.012	.030	.079	.276
			T7325	█	█		█		●	++	.063	.012	.030	.079	.276			
			T7335	█	█		█		●	+++	.063	.012	.030	.079	.276			
			T9310	█		█			●	++	.063	.012	.030	.079	.276			
			T9315	█		█		□	●	++	.063	.012	.030	.079	.276			
			T9325	█	█	█		□	●	++	.063	.012	.030	.079	.276			
			T9335	█	█				●	+++	.063	.012	.030	.079	.276			
			T8330	█	█	█		█	□	●	+	.063	.012	.030	.079	.276		
				CNMG 542-RM		T5305	□		█		□	●	+	.031	.008	.020	.039	.315
						T5315	█	□	█		□	●	+	.031	.008	.020	.039	.315
						T9315	█		█		□	●	++	.031	.008	.020	.039	.315
						T9325	█	█	█		□	●	+	.031	.008	.020	.039	.315
T9335	█	█							●	++	.031	.008	.020	.039	.315			
T8330	█	█				█		█	□	●	+	.031	.008	.020	.039	.315		
	CNMG 543-RM					T5305	□		█		□	●	++	.047	.010	.028	.059	.315
			T5315	█	□	█		□	●	++	.047	.010	.028	.059	.315			
			T7325	█	█		█		●	++	.047	.010	.028	.059	.315			
			T7335	█	█		█		●	+++	.047	.010	.028	.059	.315			
			T9310	█		█			●	++	.047	.010	.028	.059	.315			
			T9315	█		█		□	●	++	.047	.010	.028	.059	.315			
			T9325	█	█	█		□	●	++	.047	.010	.028	.059	.315			
			T9335	█	█				●	+++	.047	.010	.028	.059	.315			
			T6310	█	█	█		█	□	●	++	.047	.010	.028	.059	.315		
			T8330	█	█	█		█	□	●	+	.047	.010	.028	.059	.315		
	CNMG 544-RM		T5305	□		█		□	●	++	.063	.012	.031	.079	.315			





ANSI



P

M

K

N

S

H

 $r_c$  $f_{min}$  $f_{max}$  $a_{p min}$  $a_{p max}$ 

## CNMG 544-RM

T5315	█	□	█			□	●	++	.063	.012	.031	.079	.315
T7325	█	█			█		●	++	.063	.012	.031	.079	.315
T7335	█	█			█		●	+++	.063	.012	.031	.079	.315
T9310	█	█	█				●	++	.063	.012	.031	.079	.315
T9315	█	█	█			□	●	++	.063	.012	.031	.079	.315
T9325	█	█	█			□	●	++	.063	.012	.031	.079	.315
T9335	█	█	█				●	+++	.063	.012	.031	.079	.315

## CNMG 642-RM

T5305	□	█	█			□	●	+	.031	.008	.020	.039	.394
T5315	█	□	█			□	●	+	.031	.008	.020	.039	.394
T7335	█	█			█		●	++	.031	.008	.020	.039	.394
T9315	█	█	█			□	●	++	.031	.008	.020	.039	.394
T9325	█	█	█			□	●	+	.031	.008	.020	.039	.394
T9335	█	█	█				●	++	.031	.008	.020	.039	.394

## CNMG 643-RM

T5305	□	█	█			□	●	++	.047	.010	.028	.059	.394
T5315	█	□	█			□	●	++	.047	.010	.028	.059	.394
T7325	█	█			█		●	++	.047	.010	.028	.059	.394
T7335	█	█			█		●	+++	.047	.010	.028	.059	.394
T9310	█	█	█				●	++	.047	.010	.028	.059	.394
T9315	█	█	█			□	●	++	.047	.010	.028	.059	.394
T9325	█	█	█			□	●	++	.047	.010	.028	.059	.394
T9335	█	█	█				●	+++	.047	.010	.028	.059	.394
T6310	█	█	█		█	□	●	++	.047	.010	.028	.059	.394
T8330	█	█	█		█	□	●	++	.047	.010	.028	.059	.394

## CNMG 644-RM

T5305	□	█	█			□	●	++	.063	.012	.031	.079	.394
T5315	█	□	█			□	●	++	.063	.012	.031	.079	.394
T7325	█	█			█		●	++	.063	.012	.031	.079	.394
T7335	█	█			█		●	+++	.063	.012	.031	.079	.394
T9310	█	█	█				●	++	.063	.012	.031	.079	.394
T9315	█	█	█			□	●	++	.063	.012	.031	.079	.394
T9325	█	█	█			□	●	++	.063	.012	.031	.079	.394
T9335	█	█	█				●	+++	.063	.012	.031	.079	.394
T6310	█	█	█		█	□	●	++	.063	.012	.031	.079	.394

## CNMG 866-RM

T7335	█	█			█		●	+++	.094	.016	.039	.098	.591
T9315	█	█	█			□	●	+++	.094	.016	.039	.098	.591
T9325	█	█	█			□	●	++	.094	.016	.039	.098	.591
T9335	█	█	█				●	+++	.094	.016	.039	.098	.591
T9226	█	█	█			□	●	+++	.094	.016	.039	.098	.591

## CNMG 431-SF

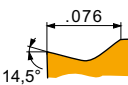
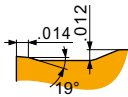
T7325	█	█			█		●	++	.016	.006	.012	.016	.106
T7335	█	█			█		●	++	.016	.006	.012	.016	.106
T9315	█	█				□	●	++	.016	.006	.012	.016	.106
T9325	█	█			█		●	+	.016	.006	.012	.016	.106
T6310	█	█			█	□	●	+	.016	.004	.012	.016	.106
T8315	█	█			█	□	●	+	.016	.004	.012	.016	.106
T8330	█	█			█	□	●	+	.016	.004	.012	.016	.106
H07	█	█			█	□	●	+	.016	.004	.012	.016	.106

## CNMG 432-SF

T7325	█	█			█		●	++	.031	.006	.012	.031	.118
T7335	█	█			█		●	++	.031	.006	.012	.031	.118
T9315	█	█				□	●	++	.031	.006	.012	.031	.118
T9325	█	█			█		●	+	.031	.006	.012	.031	.118
T6310	█	█			█	□	●	+	.031	.005	.012	.031	.118
T8315	█	█			█	□	●	+	.031	.005	.012	.031	.118
T8330	█	█			█	□	●	+	.031	.005	.012	.031	.118
H07	█	█			█	□	●	+	.031	.005	.012	.031	.118

## CNMG 433-SF

T7325	█	█			█		●	++	.047	.006	.014	.047	.118
T6310	█	█			█	□	●	+	.047	.006	.014	.047	.118
T8315	█	█			█	□	●	+	.047	.006	.014	.047	.118

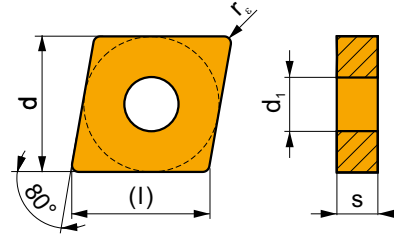


i	ANSI		Material								r <sub>c</sub>	f <sub>min</sub>	f <sub>max</sub>	a <sub>p min</sub>	a <sub>p max</sub>
			P	M	K	N	S	H							
	CNMG 431-SM	T7325	█	█			█		●	++	.016	.007	.012	.016	.157
		T7335	█	█			█		●	++	.016	.007	.012	.016	.157
		T9315	█		█			□	●	++	.016	.007	.012	.016	.157
		T9325	█	█	█		█		●	+	.016	.007	.012	.016	.157
		T6310	█	█	█		█	□	●	+	.016	.007	.012	.016	.157
		T8330	█	█	█		█	□	●	+	.016	.007	.012	.016	.157
	CNMG 432-SM	T7325	█	█			█		●	++	.031	.008	.018	.031	.157
		T7335	█	█			█		●	++	.031	.008	.018	.031	.157
		T9315	█		█			□	●	++	.031	.008	.018	.031	.157
		T9325	█	█	█		█		●	++	.031	.008	.018	.031	.157
		T6310	█	█	█		█	□	●	+	.031	.008	.018	.031	.157
		T8330	█	█	█		█	□	●	++	.031	.008	.018	.031	.157
	CNMG 433-SM	T7325	█	█			█		●	++	.047	.009	.018	.047	.177
		T7335	█	█			█		●	++	.047	.009	.018	.047	.177
		T9315	█		█			□	●	++	.047	.009	.018	.047	.177
		T9325	█	█	█		█		●	++	.047	.009	.018	.047	.177
		T6310	█	█	█		█	□	●	++	.047	.009	.018	.047	.177
		T8330	█	█	█		█	□	●	++	.047	.009	.018	.047	.177
	CNMG 542-SM	T7325	█	█			█		●	++	.031	.009	.020	.031	.197
		T7335	█	█			█		●	++	.031	.009	.020	.031	.197
		T9325	█	█	█		█		●	++	.031	.009	.020	.031	.197
		T8330	█	█	█		█	□	●	++	.031	.009	.020	.031	.197
	CNMG 543-SM	T7325	█	█			█		●	++	.047	.010	.022	.047	.217
		T7335	█	█			█		●	+++	.047	.010	.022	.047	.217
		T9315	█		█			□	●	++	.047	.010	.022	.047	.217
		T9325	█	█	█		█		●	++	.047	.010	.022	.047	.217
	CNMG 643-SM	T7325	█	█			█		●	++	.047	.010	.022	.047	.236
		T7335	█	█			█		●	+++	.047	.010	.022	.047	.236
		T9315	█		█			□	●	++	.047	.010	.022	.047	.236
		T9325	█	█	█		█		●	++	.047	.010	.022	.047	.236
	CNMG 431R-SI	T7325	█	█			█		●	++	.016	.008	.012	.031	.197
		T7335	█	█			█		●	++	.016	.008	.012	.031	.197
		T9325	█	█	□		□		●	+	.016	.008	.012	.031	.197
		T8330	█	█	□	□	█		●	+	.016	.008	.012	.031	.197
	CNMG 432R-SI	T7325	█	█			█		●	++	.031	.008	.020	.031	.197
		T7335	█	█			█		●	++	.031	.008	.020	.031	.197
		T9325	█	█	□		□		●	+	.031	.008	.020	.031	.197
		T8315	█	█	□	□	□		●	+	.031	.008	.020	.031	.197
	CNMG 431L-SI	T7325	█	█			█		●	++	.016	.008	.012	.031	.197
		T7335	█	█			█		●	++	.016	.008	.012	.031	.197
		T9325	█	█	□		□		●	+	.016	.008	.012	.031	.197
		T8330	█	█	□	□	█		●	+	.016	.008	.012	.031	.197
	CNMG 432L-SI	T7325	█	█			█		●	++	.031	.008	.020	.031	.197
		T7335	█	█			█		●	++	.031	.008	.020	.031	.197
		T9325	█	█	□		□		●	+	.031	.008	.020	.031	.197
		T8315	█	█	□	□	□		●	+	.031	.008	.020	.031	.197
	CNMG 433L-SI	T7325	█	█			█		●	+	.031	.008	.020	.031	.197
		T9325	█	█	□		□		●	+	.047	.008	.020	.047	.197

i	ANSI	Image	P	M	K	N	S	H	?	Water	r <sub>c</sub>	f <sub>min</sub>	f <sub>max</sub>	a <sub>p min</sub>	a <sub>p max</sub>
✓ W	CNMG 432W-F		T9315	■	■				●	++	.031	.006	.024	.031	.173
			T9325	■	■				●	++	.031	.006	.024	.031	.173
✓ W	CNMG 432W-M		T5315	■	□	■		□	●	++	.031	.006	.024	.031	.157
			T9315	■	■	■		□	●	++	.031	.006	.024	.031	.157
✓ S	CNMG 433W-M		T5315	■	□	■		□	●	++	.047	.008	.035	.047	.157
			T9315	■	■	■		□	●	++	.047	.008	.035	.047	.157
✓ W	CNMG 431W-MR		T9315	■	■	■			●	++	.016	.008	.024	.020	.157
			T9325	■	■	■			●	++	.016	.008	.024	.020	.157
✓ S	CNMG 432W-MR		T5315	■	□	■			●	++	.031	.008	.028	.031	.197
			T9310	■	■	■			●	++	.031	.008	.028	.031	.197
✓ S	CNMG 433W-MR		T5315	■	□	■			●	++	.047	.010	.030	.047	.197
			T9310	■	■	■			●	++	.047	.010	.030	.047	.197
✓ W	CNMG 431W-NM		T7325	■	■		■		●	++	.016	.006	.016	.020	.118
			T7335	■	■				●	++	.016	.006	.016	.020	.118
✓ U	CNMG 432W-NM		T9315	■	□				●	++	.016	.006	.016	.020	.118
			T9325	■	■	□		□	●	+	.016	.006	.016	.020	.118
✓ S	CNMG 433W-NM		T7325	■	■		■		●	++	.031	.008	.020	.031	.118
			T7335	■	■				●	++	.031	.008	.020	.031	.118
✓ S	CNMG 432W-NM		T9315	■	□				●	++	.031	.008	.020	.031	.118
			T9325	■	■	□		□	●	+	.031	.008	.020	.031	.118
✓ S	CNMG 433W-NM		T7325	■	■		■		●	++	.047	.008	.022	.047	.138
			T7335	■	■				●	++	.047	.008	.022	.047	.138
✓ S	CNMG 432W-NM		T9315	■	□				●	++	.047	.008	.022	.047	.138
			T9325	■	■	□		□	●	++	.047	.008	.022	.047	.138

## CNMM

	d	d <sub>1</sub>	l	s
43	.500	.203	.508	.187
54	.625	.250	.634	.250
64	.750	.313	.760	.250
86	1.000	.359	.016	.375

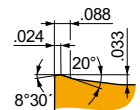
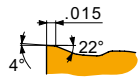
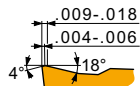


For tools see pages: T184-T185, T187, T215


i	ANSI	Material	P	M	K	N	S	H	Chip	Coolant	r <sub>c</sub>	f <sub>min</sub>	f <sub>max</sub>	a <sub>p min</sub>	a <sub>p max</sub>	
																?
	CNMM 543-DR	T9315	■	■	■				☹	+++	.047	.012	.033	.098	.354	
		T9325	■	■	■		□		☹	++	.047	.012	.033	.098	.354	
		T9335	■	■	■				☹	+++	.047	.012	.033	.098	.354	
	CNMM 642-DR	T9315	■	■	■					☹	++	.031	.012	.024	.098	.354
		T9325	■	■	■		□		☹	++	.031	.012	.024	.098	.354	
		T9335	■	■	■				☹	+++	.031	.012	.024	.098	.354	
	CNMM 643-DR	T9315	■	■	■					☹	+++	.047	.012	.033	.098	.354
		T9325	■	■	■		□		☹	++	.047	.012	.033	.098	.354	
		T9335	■	■	■				☹	+++	.047	.012	.033	.098	.354	
CNMM 644-DR	T9325	■	■	■		□			☹	++	.063	.012	.033	.098	.354	
	T9335	■	■	■					☹	+++	.063	.012	.033	.098	.354	
	T9335	■	■	■					☹	+++	.063	.012	.033	.098	.354	
	CNMM 644-HR	T9325	■	■	■		□		☹	++	.063	.020	.047	.197	.524	
		T9335	■	■	■				☹	+++	.063	.020	.047	.197	.524	
	CNMM 646-HR	T8345	■	■	■		□		☹	++	.063	.020	.047	.197	.524	
		T9315	■	■	■					☹	+++	.094	.020	.055	.197	.524
		T9325	■	■	■		□		☹	++	.094	.020	.055	.197	.524	
	CNMM 866-HR	T9335	■	■	■					☹	+++	.094	.020	.055	.197	.524
T8345		■	■	■		□		☹	+++	.094	.020	.055	.197	.524		
T8345		■	■	■		□		☹	+++	.094	.020	.055	.197	.524		
	CNMM 644-HR2	T9315	■	■	■				☹	+++	.063	.020	.047	.118	.512	
		T9335	■	■	■		□		☹	+++	.063	.020	.047	.118	.512	
	CNMM 646-HR2	T9226	■	■	■		□		☹	+++	.063	.020	.047	.118	.512	
		T9315	■	■	■					☹	+++	.094	.020	.051	.118	.512
		T9335	■	■	■		□		☹	+++	.094	.020	.051	.118	.512	
	CNMM 866-HR2	T9226	■	■	■		□		☹	+++	.094	.020	.051	.118	.512	
T9315		■	■	■					☹	+++	.094	.028	.055	.118	.630	
T9335		■	■	■		□		☹	+++	.094	.028	.055	.118	.630		
	CNMM 432-NR	T7325	■	■			■		☹	++	.031	.010	.024	.039	.331	
		T7335	■	■					☹	+++	.031	.010	.024	.039	.331	
		T9315	■	■		□			☹	++	.031	.010	.024	.039	.331	
	CNMM 433-NR	T9325	■	■			□		☹	++	.031	.010	.024	.039	.331	
		T8330	■	■		□	□	■	☹	++	.031	.010	.024	.039	.331	
		T7325	■	■			■		☹	+++	.047	.010	.031	.047	.331	
CNMM 433-NR	T7335	■	■					☹	+++	.047	.010	.031	.047	.331		
	T9325	■	■		□	□		☹	++	.047	.010	.031	.047	.331		

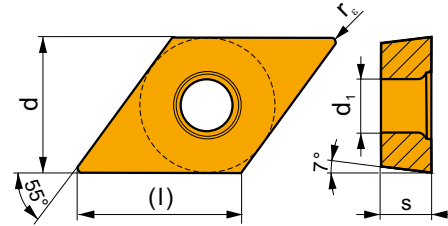
i	ANSI	Image	P	M	K	N	S	H	?	Image	r <sub>e</sub>	f <sub>min</sub>	f <sub>max</sub>	a <sub>p min</sub>	a <sub>p max</sub>	
V S Image	CNMM 433-NR	T8330 Image: .01, 23°	■	■	□	□	■		✘	++	.047	.010	.031	.047	.331	
Image: .016, .005, 15°, 21° P	CNMM 432-NR2	T7325	■	■			■		☹	++	.031	.010	.022	.031	.295	
			T7335	■	■				☹	+++	.031	.010	.022	.031	.295	
			T9315	■		□			☹	++	.031	.010	.022	.031	.295	
			T9325	■	■	□		□	☹	++	.031	.010	.022	.031	.295	
			T8330	■	■	□	□	■	☹	++	.031	.010	.022	.031	.295	
	CNMM 433-NR2	T7335	T9315	■	■				☹	+++	.047	.011	.028	.047	.295	
				T9325	■	■	□		□	☹	++	.047	.011	.028	.047	.295
				T8330	■	■	□	□	■	☹	++	.047	.011	.028	.047	.295
				T7325	■	■			■	☹	+++	.031	.012	.024	.039	.374
	CNMM 542-NR2	T9325	T8330	■	■	□		□	☹	++	.031	.012	.024	.039	.374	
				T7335	■	■				☹	+++	.031	.012	.024	.039	.374
				T9315	■		□			☹	++	.047	.014	.026	.059	.374
	CNMM 543-NR2	T7325	T7335	■	■			■		☹	+++	.047	.014	.026	.059	.374
				T9315	■	■				☹	+++	.047	.014	.026	.059	.374
				T9325	■	■	□		□	☹	++	.047	.014	.026	.059	.374
				T8330	■	■	□	□	■	☹	++	.047	.014	.026	.059	.374
				T7325	■	■			■	☹	+++	.063	.014	.031	.079	.374
	CNMM 544-NR2	T7335	T9325	■	■				☹	+++	.063	.014	.031	.079	.374	
				T9315	■	■	□		□	☹	++	.063	.014	.031	.079	.374
				T8330	■	■	□	□	■	☹	++	.063	.014	.031	.079	.374
T7325				■	■			■	☹	+++	.047	.014	.035	.059	.472	
CNMM 643-NR2	T7335	T9325	■	■				☹	+++	.047	.014	.035	.059	.472		
			T9315	■	■	□		□	☹	++	.047	.014	.035	.059	.472	
			T8330	■	■	□	□	■	☹	++	.047	.014	.035	.059	.472	
			T7325	■	■			■	☹	+++	.063	.016	.039	.079	.472	
CNMM 644-NR2	T7335	T9315	■	■				☹	+++	.063	.016	.039	.079	.472		
			T9325	■	■	□		□	☹	+++	.063	.016	.039	.079	.472	
			T8330	■	■	□	□	■	☹	++	.063	.016	.039	.079	.472	
			T9315	■		□			☹	+++	.063	.016	.039	.079	.472	
			T9325	■	■	□		□	☹	++	.063	.016	.039	.079	.472	
CNMM 646-NR2	T8330	T7335	■	■	□	□	■	☹	++	.063	.016	.039	.079	.472		
			T9325	■	■	□		□	☹	++	.063	.016	.039	.079	.472	
			T9315	■		□			☹	+++	.094	.016	.047	.098	.472	
			T7325	■	■			■	☹	+++	.094	.016	.047	.098	.472	
CNMM 866-NR2	T7325	T7335	■	■			■		☹	+++	.094	.020	.063	.118	.630	
			T9315	■	■				☹	+++	.094	.020	.063	.118	.630	
			T9325	■	■	□		□	☹	+++	.094	.020	.063	.118	.630	
			T8330	■	■	□	□	■	☹	++	.094	.020	.063	.118	.630	
			T7325	■	■			■	☹	+++	.094	.014	.039	.079	.630	
CNMM 866-NRM	T7335	T9315	■	■				☹	+++	.094	.014	.039	.079	.630		
			T9325	■	■	□		□	☹	+++	.094	.014	.039	.079	.630	
			T8330	■	■	□	□	■	☹	+++	.094	.014	.039	.079	.630	

i	ANSI		Material								r <sub>c</sub>	f <sub>min</sub>	f <sub>max</sub>	a <sub>p min</sub>	a <sub>p max</sub>
			P	M	K	N	S	H							
	CNMM 432-OR	T9315	■	■	▣					++	.031	.010	.024	.079	.315
		T9325	■	■	▣		□			++	.031	.010	.024	.079	.315
		T9335	■	▣						+++	.031	.010	.024	.079	.315
		T8330	■	■	▣		□			++	.031	.010	.024	.079	.315
	CNMM 433-OR	T9315	■	■	▣					++	.047	.012	.028	.098	.315
		T9325	■	■	▣		□			++	.047	.012	.028	.098	.315
		T9335	■	▣						+++	.047	.012	.028	.098	.315
	CNMM 434-OR	T9315	■	■	▣					+++	.063	.014	.031	.098	.315
		T9325	■	■	▣		□			++	.063	.014	.031	.098	.315
		T9335	■	▣						+++	.063	.014	.031	.098	.315
	CNMM 542-OR	T9315	■	■	▣					++	.031	.012	.024	.118	.315
		T9325	■	■	▣		□			++	.031	.012	.024	.118	.315
		T9335	■	▣						+++	.031	.012	.024	.118	.315
	CNMM 543-OR	T9315	■	■	▣					+++	.047	.014	.035	.118	.394
		T9325	■	■	▣		□			++	.047	.014	.035	.118	.394
	CNMM 544-OR	T9315	■	■	▣					+++	.063	.014	.039	.118	.394
		T9325	■	■	▣		□			++	.063	.014	.039	.118	.394
	CNMM 643-OR	T9315	■	■	▣					+++	.047	.014	.035	.118	.394
		T9325	■	■	▣		□			++	.047	.014	.035	.118	.394
		T9335	■	▣						+++	.047	.014	.035	.118	.394
		T8330	■	■	▣		□			++	.047	.014	.035	.118	.394
	CNMM 644-OR	T9315	■	■	▣					+++	.063	.015	.047	.118	.394
		T9325	■	■	▣		□			++	.063	.015	.047	.118	.394
		T9335	■	▣						+++	.063	.015	.047	.118	.394
		T8330	■	■	▣		□			++	.063	.015	.047	.118	.394
		T8345	▣	■	▣		□			++	.063	.015	.047	.118	.394
	CNMM 646-OR	T9315	■	■	▣					+++	.094	.015	.049	.118	.472
		T9325	■	■	▣		□			++	.094	.015	.049	.118	.472
	CNMM 866-OR	T9315	■	■	▣					+++	.094	.018	.067	.157	.630
		T9325	■	■	▣		□			+++	.094	.018	.067	.157	.630
		T9335	■	▣						+++	.094	.018	.067	.157	.630
		T8330	■	■	▣		□			++	.094	.018	.067	.157	.630
	CNMM 644-OR1	T9325	■	■	▣		□			++	.063	.012	.039	.118	.433
		T9335	■	▣						+++	.063	.012	.039	.118	.433
	CNMM 866-923	T9335	■	▣						+++	.094	.018	.059	.118	.630
		T8330	■	▣	▣					++	.094	.018	.059	.118	.630











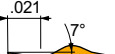











# DCGT

	d	d <sub>1</sub>	l	s
21.5	.250	.110	.307	.094
21.5-SF3	.250	.110	.307	.102
32.5	.375	.173	.457	.156
32.5-SF3	.375	.173	.457	.166



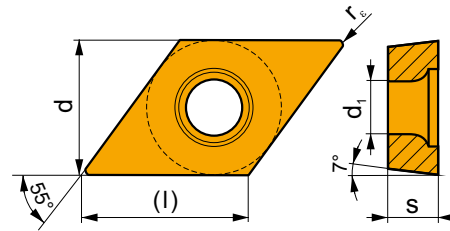
For tools see pages: T204-T205, T220-T223

		ANSI		P	M	K	N	S	H			r <sub>c</sub>	f <sub>min</sub>	f <sub>max</sub>	a <sub>p min</sub>	a <sub>p max</sub>
		DCGT 21.50.5F-AL	T0315				■			●	+	.008	.002	.005	.012	.083
			HF7				■			●	+	.008	.002	.005	.012	.083
		DCGT 21.51F-AL	T0315				■			●	+	.016	.004	.009	.016	.083
			HF7				■			●	+	.016	.004	.009	.016	.083
		DCGT 32.50.5F-AL	T0315				■			●	+	.008	.002	.005	.012	.130
			HF7				■			●	+	.008	.002	.005	.012	.130
		DCGT 32.51F-AL	T0315				■			●	+	.016	.004	.009	.016	.130
			HF7				■			●	+	.016	.004	.009	.016	.130
		DCGT 32.52F-AL	T0315				■			●	++	.031	.006	.019	.031	.130
			HF7				■			●	++	.031	.006	.019	.031	.130
		DCGT 32.50.5-FF2	T7325	■	■					●	++	.008	.001	.005	.006	.098
			T9325	■	■	■				●	+	.008	.001	.005	.006	.098
			T8330	■	■	■				●	+	.008	.001	.005	.006	.098
			TT010	■	■					●	+/-	.008	.001	.005	.006	.098
		DCGT 32.51-NF1	T7325	■	■			■		●	++	.016	.002	.009	.012	.118
			T6310	■	■	■		■		●	+	.016	.002	.009	.012	.118
		DCGT 32.52-NF1	T7325	■	■			■		●	++	.031	.005	.010	.020	.118
			T6310	■	■	■		■		●	+	.031	.005	.010	.020	.118
		DCGT 21.50.5-SF3	T6310			■	■	■		●	+	.008	.002	.005	.008	.063
			T8315			■	■	■		●	+	.008	.002	.005	.008	.063
			H07			■	■	■		●	+	.008	.002	.005	.008	.063
		DCGT 21.51-SF3	T6310			■	■	■		●	+	.016	.002	.008	.008	.079
			T8315			■	■	■		●	+	.016	.002	.008	.008	.079
			H07			■	■	■		●	+	.016	.002	.008	.008	.079
		DCGT 32.50.5-SF3	T6310			■	■	■		●	+	.008	.002	.005	.008	.079
			H07			■	■	■		●	+	.008	.002	.005	.008	.079
		DCGT 32.51-SF3	T6310			■	■	■		●	+	.016	.002	.009	.008	.087
			T8315			■	■	■		●	+	.016	.002	.009	.008	.087
			H07			■	■	■		●	+	.016	.002	.009	.008	.087
		DCGT 32.52-SF3	T6310			■	■	■		●	+	.031	.003	.012	.024	.098
			T8315			■	■	■		●	+	.031	.003	.012	.024	.098
			H07			■	■	■		●	+	.031	.003	.012	.024	.098
			H07			■	■	■		●	+	.031	.003	.012	.024	.098
		DCGT 21.50.5-SF3	T6310			■	■	■		●	+	.008	.002	.005	.008	.063
			T8315			■	■	■		●	+	.008	.002	.005	.008	.063
			H07			■	■	■		●	+	.008	.002	.005	.008	.063
		DCGT 21.51-SF3	T6310			■	■	■		●	+	.016	.002	.008	.008	.079
			T8315			■	■	■		●	+	.016	.002	.008	.008	.079
			H07			■	■	■		●	+	.016	.002	.008	.008	.079
		DCGT 32.50.5-SF3	T6310			■	■	■		●	+	.008	.002	.005	.008	.079
			H07			■	■	■		●	+	.008	.002	.005	.008	.079
		DCGT 32.51-SF3	T6310			■	■	■		●	+	.016	.002	.009	.008	.087
			T8315			■	■	■		●	+	.016	.002	.009	.008	.087
			H07			■	■	■		●	+	.016	.002	.009	.008	.087
		DCGT 32.52-SF3	T6310			■	■	■		●	+	.031	.003	.012	.024	.098
			T8315			■	■	■		●	+	.031	.003	.012	.024	.098
			H07			■	■	■		●	+	.031	.003	.012	.024	.098
			H07			■	■	■		●	+	.031	.003	.012	.024	.098

i	ANSI	T8330	P M K N S H					?	+	r <sub>c</sub>	f <sub>min</sub>	f <sub>max</sub>	a <sub>p min</sub>	a <sub>p max</sub>
    	DCGT 32.51R-SI	T8330	■	■	□	□	■	●	+	.016	.003	.009	.016	.098
	DCGT 32.52R-SI	T8330	■	■	□	□	■	●	+	.031	.006	.012	.031	.098
    	DCGT 32.51L-SI	T8330	■	■	□	□	■	●	+	.016	.003	.009	.016	.098

### DCMT

	d	d <sub>1</sub>	l	s
21.5	.250	.110	.307	.094
32.5	.375	.173	.457	.156
43	.500	.217	.610	.187



For tools see pages: T204-T205, T220-T223

i	ANSI	T8315	P M K N S H					?	+	r <sub>c</sub>	f <sub>min</sub>	f <sub>max</sub>	a <sub>p min</sub>	a <sub>p max</sub>
    	DCMT 32.50.5-FF	T8315	■	■	■	□	□	●	+	.008	.002	.005	.008	.079
		T8330	■	■	■	□	□	●	+	.008	.002	.005	.008	.079
		T9315	■	■	■			●	++	.008	.002	.005	.008	.079
	DCMT 32.51-FF	T8315	■	■	■	□	□	●	+	.016	.002	.009	.016	.079
		T8330	■	■	■	□	□	●	+	.016	.002	.009	.016	.079
		T9315	■	■	■			●	++	.016	.002	.009	.008	.079
	DCMT 32.52-FF	T8315	■	■	■	□	□	●	+	.031	.002	.009	.031	.079
		T8330	■	■	■	□	□	●	+	.031	.002	.009	.031	.079
		T9315	■	■	■			●	++	.031	.002	.009	.008	.079
     	DCMT 21.50.5-FF2	T7325	■	■				●	++	.008	.001	.005	.006	.059
		T9325	■	■	■			●	+	.008	.001	.005	.006	.059
		T8330	■	■	■			●	+	.008	.001	.005	.006	.059
		TT010	■	■				●	+/-	.008	.001	.005	.006	.059
	DCMT 21.51-FF2	T7325	■	■				●	++	.016	.002	.008	.012	.079
		T9315	■	■	■			●	++	.016	.002	.008	.012	.079
		T9325	■	■	■			●	+	.016	.002	.008	.012	.079
		T8330	■	■	■			●	+	.016	.002	.008	.012	.079
	DCMT 21.52-FF2	T7325	■	■				●	++	.031	.002	.010	.024	.079
		T9315	■	■	■			●	++	.031	.002	.010	.024	.079
		T9325	■	■	■			●	+	.031	.002	.010	.024	.079
		T8330	■	■	■			●	+	.031	.002	.010	.024	.079
DCMT 32.51-FF2	T7325	■	■				●	++	.016	.002	.009	.012	.098	
	T9315	■	■	■			●	++	.016	.002	.009	.012	.098	



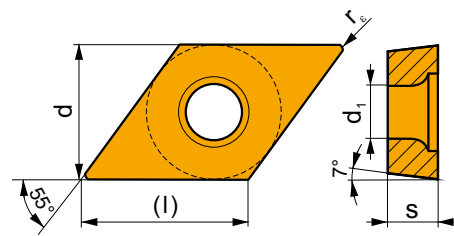
i	ANSI		P	M	K	N	S	H			r <sub>c</sub>	f <sub>min</sub>	f <sub>max</sub>	a <sub>p min</sub>	a <sub>p max</sub>	
   	DCMT 32.51-FF2	T9325	■	■	■				●	+	.016	.002	.009	.012	.098	
		T9335	■	■					●	++	.016	.002	.009	.012	.098	
		T8330	■	■	■					●	+	.016	.002	.009	.012	.098
		TT010	■	■						●	+/-	.016	.002	.009	.012	.098
	DCMT 32.52-FF2	T7325	■	■						●	++	.031	.003	.010	.024	.118
		T9315	■	■	■					●	++	.031	.003	.010	.024	.118
		T9325	■	■	■					●	+	.031	.003	.010	.024	.118
		T8330	■	■	■					●	+	.031	.003	.010	.024	.118
	DCMT 21.50.5-FM	T7325	■	■				□		●	++	.008	.003	.005	.008	.039
		T9315	■	■	■					●	++	.008	.003	.005	.008	.039
		T9325	■	■	■			□		●	+	.008	.003	.005	.008	.039
		T8315	■	■	■			□		●	+	.008	.002	.005	.008	.039
DCMT 21.51-FM	T8330	■	■	■			□		●	+	.008	.002	.005	.008	.039	
	T7325	■	■				□		●	++	.016	.006	.009	.008	.079	
	T7335	■	■				□		●	++	.016	.006	.009	.008	.079	
	T9315	■	■	■					●	++	.016	.006	.009	.008	.079	
DCMT 32.50.5-FM	T9325	■	■	■			□		●	+	.016	.006	.009	.008	.079	
	T8315	■	■	■			□		●	+	.016	.003	.009	.008	.079	
	T8330	■	■	■			□		●	+	.016	.003	.009	.008	.039	
	T7325	■	■				□		●	++	.008	.003	.005	.008	.079	
DCMT 32.51-FM	T9315	■	■	■					●	++	.008	.003	.005	.008	.079	
	T9325	■	■	■			□		●	+	.008	.003	.005	.008	.079	
	T8315	■	■	■			□		●	+	.008	.003	.005	.008	.079	
	T8330	■	■	■			□		●	+	.008	.003	.005	.008	.059	
DCMT 32.52-FM	T7325	■	■				□		●	++	.016	.006	.009	.012	.118	
	T7335	■	■				□		●	++	.016	.006	.009	.012	.118	
	T9315	■	■	■					●	++	.016	.006	.009	.012	.118	
	T9325	■	■	■			□		●	+	.016	.006	.009	.012	.118	
DCMT 32.53-FM	T8315	■	■	■			□		●	+	.016	.004	.009	.012	.118	
	T8330	■	■	■			□		●	+	.016	.004	.009	.012	.118	
	T7325	■	■				□		●	++	.031	.006	.012	.020	.118	
	T7335	■	■				□		●	++	.031	.006	.012	.020	.118	
DCMT 21.51-FM2	T9315	■	■	■					●	++	.031	.006	.012	.020	.118	
	T9325	■	■	■			□		●	+	.031	.006	.012	.020	.118	
	T8315	■	■	■			□		●	+	.031	.004	.012	.020	.118	
	T8330	■	■	■			□		●	+	.031	.004	.012	.020	.118	
DCMT 32.51-FM2	T9315	■	■	■					●	++	.047	.008	.016	.035	.130	
	T9325	■	■	■			□		●	++	.047	.008	.016	.035	.130	
	T8330	■	■	■			□		●	++	.047	.008	.016	.035	.130	
	T7325	■	■				□		●	++	.016	.002	.009	.008	.083	
DCMT 32.51-FM2	T9315	■	■	■				□	●	++	.016	.002	.009	.008	.083	
	T9325	■	■	■			□		●	+	.016	.002	.009	.008	.083	
	T6310	■	■	■			□	□	●	+	.016	.002	.009	.008	.083	
	T8330	■	■	■			□	□	●	+	.016	.002	.009	.008	.083	
DCMT 32.52-FM2	T7325	■	■				□		●	++	.016	.002	.009	.008	.110	
	T9315	■	■	■			□		●	++	.016	.002	.009	.008	.110	
	T9325	■	■	■			□		●	+	.016	.002	.009	.008	.110	
	T9335	■	■				□		●	++	.016	.002	.009	.008	.110	
DCMT 32.52-FM2	T6310	■	■	■			□	□	●	+	.016	.002	.009	.008	.110	
	T8330	■	■	■			□	□	●	+	.016	.002	.009	.008	.110	
	T7325	■	■				□		●	++	.031	.004	.012	.024	.110	
	T9315	■	■	■			□		●	++	.031	.004	.012	.024	.110	
DCMT 32.52-FM2	T9325	■	■	■			□		●	+	.031	.004	.012	.024	.110	
	T9335	■	■				□		●	++	.031	.004	.012	.024	.110	
	T6310	■	■	■			□	□	●	+	.031	.004	.012	.024	.110	
	T8330	■	■	■			□	□	●	+	.031	.004	.012	.024	.110	

i	ANSI	Image	P	M	K	N	S	H	?	Image	r <sub>c</sub>	f <sub>min</sub>	f <sub>max</sub>	a <sub>p min</sub>	a <sub>p max</sub>
  	DCMT 32.53-FM2	T9325	■	■	■		□		●	+	.047	.005	.012	.039	.110
	DCMT 432-FM2	T9315	■		■			□	●	++	.031	.004	.012	.024	.138
		T9325	■	■	■			□	●	+	.031	.004	.012	.024	.138
		T9335	■	■				□	●	++	.031	.004	.012	.024	.138
  	DCMT 32.51-RF	T5315	■	□	■				●	+	.016	.004	.009	.031	.130
		T7335	■	■					●	++	.016	.006	.009	.031	.130
	DCMT 32.52-RF	T5315	■	□	■				●	++	.031	.004	.016	.031	.130
		T7335	■	■					●	+++	.031	.006	.016	.031	.130
  	DCMT 32.51-RM	T5305	□		■			□	●	+	.016	.006	.009	.039	.130
		T5315	■	□	■			□	●	+	.016	.006	.009	.039	.130
		T7335	■	■					●	++	.016	.006	.009	.039	.130
		T9315	■		■			□	●	++	.016	.006	.009	.039	.130
		T9325	■	■	■			□	●	+	.016	.006	.009	.039	.130
		T8330	■	■	■		■	□	●	+	.016	.006	.009	.039	.130
	DCMT 32.52-RM	T5305	□		■			□	●	+	.031	.006	.016	.039	.130
		T5315	■	□	■			□	●	++	.031	.006	.016	.039	.130
		T7335	■	■					●	+++	.031	.006	.016	.039	.130
		T9315	■		■			□	●	++	.031	.006	.016	.039	.130
		T9325	■	■	■			□	●	++	.031	.006	.016	.039	.130
		T8330	■	■	■		■	□	●	++	.031	.006	.016	.039	.130
	DCMT 32.53-RM	T7335	■	■					●	+++	.047	.006	.018	.059	.130
		T9315	■		■			□	●	++	.047	.006	.018	.059	.130
		T9325	■	■	■			□	●	++	.047	.006	.018	.059	.130
		T8330	■	■	■		■	□	●	++	.047	.006	.018	.059	.130
DCMT 432-RM	T9315	■		■			□	●	++	.031	.008	.019	.039	.177	
	T9325	■	■	■			□	●	++	.031	.008	.019	.039	.177	
	T8330	■	■	■		■	□	●	++	.031	.008	.019	.039	.177	
	DCMT 21.50.5-UR	T7325	■	■					●	++	.008	.003	.005	.008	.039
		T9315	■		■				●	++	.008	.003	.005	.008	.039
		T9325	■	■	■				●	+	.008	.003	.005	.008	.039
		T8315	■	■	■		□		●	+	.008	.002	.005	.008	.039
		T8330	■	■	■		□		●	+	.008	.002	.005	.008	.039
	DCMT 21.51-UR	T7325	■	■					●	++	.016	.006	.009	.016	.079
		T9315	■		■				●	++	.016	.006	.009	.016	.079
		T9325	■	■	■				●	+	.016	.006	.009	.016	.079
	T8315	■	■	■		□		●	+	.016	.003	.009	.016	.079	
	T8330	■	■	■		□		●	+	.016	.003	.009	.016	.079	
	TT310	■	■					●	+/-	.016	.002	.006	.016	.079	
 	DCMT 32.50.5-UR	T7325	■	■					●	++	.008	.003	.005	.008	.079
		T9315	■		■				●	++	.008	.003	.005	.008	.079
		T9325	■	■	■				●	+	.008	.003	.005	.008	.079
		T8330	■	■	■		□		●	+	.008	.002	.005	.008	.079
		TT310	■	■					●	+/-	.008	.002	.005	.008	.079
	DCMT 32.51-UR	T5315	■	□	■				●	+	.016	.004	.009	.016	.079
		T7325	■	■					●	++	.016	.006	.009	.016	.079
		T7335	■	■					●	++	.016	.006	.009	.016	.079
		T9315	■		■				●	++	.016	.006	.009	.016	.079
		T9325	■	■	■				●	+	.016	.006	.009	.016	.079
		T8315	■	■	■		□		●	+	.016	.003	.009	.016	.079
		T8330	■	■	■		□		●	+	.016	.003	.009	.016	.079
		TT310	■	■					●	+/-	.016	.003	.009	.016	.098
DCMT 32.52-UR	T5315	■	□	■				●	++	.031	.004	.019	.031	.079	
	T7335	■	■					●	+++	.031	.006	.019	.031	.079	

i	ANSI	Image	P	M	K	N	S	H	?	Image	r <sub>c</sub>	f <sub>min</sub>	f <sub>max</sub>	a <sub>p min</sub>	a <sub>p max</sub>	
																Image
	DCMT 32.52-UR	T9315	■	■	■				●	++	.031	.006	.019	.031	.079	
		T9325	■	■	■				●	++	.031	.006	.019	.031	.079	
		T8315	■	■	■	□				●	++	.031	.003	.019	.031	.079
		T8330	■	■	■	□				●	++	.031	.003	.019	.031	.079
		TT310	■	■						●	+/-	.031	.003	.019	.031	.098
	DCMT 32.53-UR	T7325	■	■						●	++	.047	.006	.012	.047	.079
		T9315	■	■	■					●	++	.047	.006	.012	.047	.079
		T9325	■	■	■					●	+	.047	.006	.012	.047	.079
	DCMX 32.51W-FM	T7325	■	■			□			●	++	.016	.006	.016	.012	.079
		T9315	■	■	■					●	++	.016	.006	.016	.012	.079
T9325		■	■	■		□			●	++	.016	.006	.016	.012	.079	
T8330		■	■	■		□			●	++	.016	.004	.016	.012	.079	
DCMX 32.52W-FM		T7325	■	■			□			●	++	.031	.006	.016	.020	.118
		T9315	■	■	■					●	++	.031	.006	.016	.020	.118
		T9325	■	■	■		□			●	++	.031	.006	.016	.020	.118

## DCMW

Image	d	d <sub>1</sub>	l	s
21.5	.250	.110	.307	.094
32.5	.375	.173	.457	.156

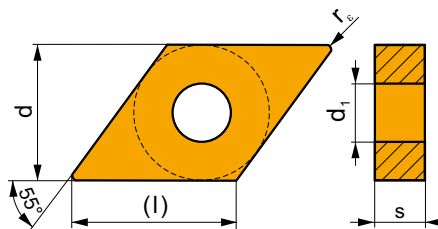


For tools see pages: T204-T205, T220-T223

i	ANSI	Image	P	M	K	N	S	H	?	Image	r <sub>c</sub>	f <sub>min</sub>	f <sub>max</sub>	a <sub>p min</sub>	a <sub>p max</sub>	
																Image
	DCMW 21.50.5	T5305	□	■	■			■	●	+	.008	.002	.004	.008	.079	
		T6310	■	□	■		■		■	●	+	.008	.002	.004	.008	.079
	DCMW 21.51	T5305	□	■	■		■		■	●	+	.016	.004	.008	.016	.079
		T5315	■	□	■		■		■	●	+	.016	.004	.008	.016	.079
	DCMW 32.51	T6310	■	□	■		■		■	●	+	.016	.002	.008	.016	.079
		T5305	□	■	■		■		■	●	+	.016	.004	.009	.016	.114
		T5315	■	□	■		■		■	●	+	.016	.004	.009	.016	.114
	DCMW 32.52	T6310	■	□	■		■		■	●	+	.016	.002	.009	.016	.114
		T5305	□	■	■		■		■	●	+	.031	.004	.014	.031	.114
		T5315	■	□	■		■		■	●	+	.031	.004	.014	.031	.114
		T6310	■	□	■		■		■	●	+	.031	.002	.014	.031	.114

## DNMA

	d	d <sub>1</sub>	l	s
43	.500	.203	.610	.187
44	.500	.203	.610	.250

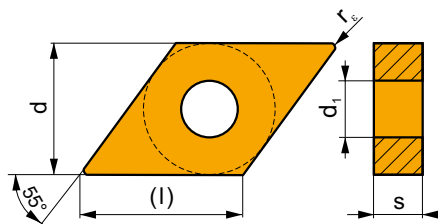


For tools see pages: T188-T189, T216

i	ANSI	Image	P	M	K	N	S	H	Image	Image	r <sub>c</sub>	f <sub>min</sub>	f <sub>max</sub>	a <sub>p min</sub>	a <sub>p max</sub>
	DNMA 431	T5305	<input type="checkbox"/>	<input type="checkbox"/>	<input checked="" type="checkbox"/>	<input type="checkbox"/>	<input type="checkbox"/>	<input checked="" type="checkbox"/>	●	+	.016	.004	.009	.016	.154
	DNMA 432	T5305	<input type="checkbox"/>	<input type="checkbox"/>	<input checked="" type="checkbox"/>	<input type="checkbox"/>	<input type="checkbox"/>	<input checked="" type="checkbox"/>	●	++	.031	.004	.019	.031	.154
	DNMA 441	T5305	<input type="checkbox"/>	<input type="checkbox"/>	<input checked="" type="checkbox"/>	<input type="checkbox"/>	<input type="checkbox"/>	<input checked="" type="checkbox"/>	●	+	.016	.004	.009	.016	.154
		T5315	<input checked="" type="checkbox"/>	<input type="checkbox"/>	<input checked="" type="checkbox"/>	<input type="checkbox"/>	<input type="checkbox"/>	<input type="checkbox"/>	●	+	.016	.004	.009	.016	.154
	DNMA 442	T6310	<input checked="" type="checkbox"/>	<input type="checkbox"/>	<input checked="" type="checkbox"/>	<input type="checkbox"/>	<input type="checkbox"/>	<input checked="" type="checkbox"/>	●	+	.016	.002	.009	.016	.154
		T5305	<input type="checkbox"/>	<input type="checkbox"/>	<input checked="" type="checkbox"/>	<input type="checkbox"/>	<input type="checkbox"/>	<input checked="" type="checkbox"/>	●	++	.031	.004	.019	.031	.154
		T5315	<input checked="" type="checkbox"/>	<input type="checkbox"/>	<input checked="" type="checkbox"/>	<input type="checkbox"/>	<input type="checkbox"/>	<input type="checkbox"/>	●	++	.031	.004	.019	.031	.154
	DNMA 443	T6310	<input checked="" type="checkbox"/>	<input type="checkbox"/>	<input checked="" type="checkbox"/>	<input type="checkbox"/>	<input type="checkbox"/>	<input checked="" type="checkbox"/>	●	++	.031	.002	.019	.031	.154
		T5305	<input type="checkbox"/>	<input type="checkbox"/>	<input checked="" type="checkbox"/>	<input type="checkbox"/>	<input type="checkbox"/>	<input checked="" type="checkbox"/>	●	++	.047	.004	.028	.047	.154
			T5315	<input checked="" type="checkbox"/>	<input type="checkbox"/>	<input checked="" type="checkbox"/>	<input type="checkbox"/>	<input type="checkbox"/>	●	++	.047	.004	.028	.047	.154













































































































































































































































































































## DNMG

	d	d <sub>1</sub>	l	s
33	.375	.150	.457	.187
43	.500	.203	.610	.187
44	.500	.203	.610	.250


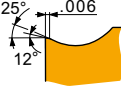



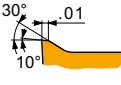




For tools see pages: T188-T189, T216

i	ANSI	Image	P	M	K	N	S	H	Image	Image	r <sub>c</sub>	f <sub>min</sub>	f <sub>max</sub>	a <sub>p min</sub>	a <sub>p max</sub>
	DNMG 330.5-FF	T8315	<input checked="" type="checkbox"/>	<input checked="" type="checkbox"/>	<input checked="" type="checkbox"/>	<input type="checkbox"/>	<input type="checkbox"/>	<input type="checkbox"/>	●	+	.008	.002	.005	.008	.059
	DNMG 331-FF	T8315	<input checked="" type="checkbox"/>	<input checked="" type="checkbox"/>	<input checked="" type="checkbox"/>	<input type="checkbox"/>	<input type="checkbox"/>	<input type="checkbox"/>	●	+	.016	.002	.008	.016	.059
		T8330	<input checked="" type="checkbox"/>	<input checked="" type="checkbox"/>	<input checked="" type="checkbox"/>	<input type="checkbox"/>	<input type="checkbox"/>	<input type="checkbox"/>	●	+	.016	.002	.008	.016	.059
	DNMG 332-FF	T8315	<input checked="" type="checkbox"/>	<input checked="" type="checkbox"/>	<input checked="" type="checkbox"/>	<input type="checkbox"/>	<input type="checkbox"/>	<input type="checkbox"/>	●	+	.031	.003	.010	.031	.059
	DNMG 431-FF	T8315	<input checked="" type="checkbox"/>	<input checked="" type="checkbox"/>	<input checked="" type="checkbox"/>	<input type="checkbox"/>	<input type="checkbox"/>	<input type="checkbox"/>	●	+	.016	.002	.008	.016	.059
	DNMG 441-FF	T7325	<input checked="" type="checkbox"/>	<input checked="" type="checkbox"/>	<input checked="" type="checkbox"/>	<input type="checkbox"/>	<input type="checkbox"/>	<input type="checkbox"/>	●	++	.016	.006	.008	.016	.059
		T8315	<input checked="" type="checkbox"/>	<input checked="" type="checkbox"/>	<input checked="" type="checkbox"/>	<input type="checkbox"/>	<input type="checkbox"/>	<input type="checkbox"/>	●	+	.016	.002	.008	.016	.059
	DNMG 442-FF	T7325	<input checked="" type="checkbox"/>	<input checked="" type="checkbox"/>	<input checked="" type="checkbox"/>	<input type="checkbox"/>	<input type="checkbox"/>	<input type="checkbox"/>	●	++	.031	.006	.010	.031	.059
		T8315	<input checked="" type="checkbox"/>	<input checked="" type="checkbox"/>	<input checked="" type="checkbox"/>	<input type="checkbox"/>	<input type="checkbox"/>	<input type="checkbox"/>	●	+	.031	.003	.010	.031	.059

		ANSI		P	M	K	N	S	H			r <sub>c</sub>	f <sub>min</sub>	f <sub>max</sub>	a <sub>p min</sub>	a <sub>p max</sub>
 	DNMG 331-FM	T7325									++	.016	.006	.009	.016	.118
		T9310									+	.016	.006	.009	.016	.118
		T9315									++	.016	.006	.009	.016	.118
		T9325									+	.016	.006	.009	.016	.118
		T8315									+	.016	.004	.009	.016	.118
		T8330									+	.016	.004	.009	.016	.118
DNMG 332-FM	T7325									++	.031	.006	.014	.031	.118	
	T9310									+	.031	.006	.014	.031	.118	
	T9315									++	.031	.006	.014	.031	.118	
	T9325									++	.031	.006	.014	.031	.118	
	T8315									+	.031	.004	.014	.031	.118	
	T8330									++	.031	.004	.014	.031	.118	
DNMG 431-FM	T7325									++	.016	.006	.009	.020	.118	
	T9315									++	.016	.006	.009	.020	.118	
	T9325									+	.016	.006	.009	.020	.118	
DNMG 432-FM	T7325									++	.031	.006	.018	.031	.118	
	T9315									++	.031	.006	.018	.031	.118	
	T9325									++	.031	.006	.018	.031	.118	
	T8330									++	.031	.006	.018	.031	.118	
DNMG 441-FM	T7325									++	.016	.006	.009	.020	.118	
	T7335									++	.016	.006	.009	.020	.118	
	T9310									+	.016	.006	.009	.020	.118	
	T9315									++	.016	.006	.009	.020	.118	
	T9325									+	.016	.006	.009	.020	.118	
	T8315									+	.016	.004	.009	.020	.118	
	T8330									+	.016	.004	.009	.020	.118	
	TT310									+/-	.016	.004	.009	.020	.118	
	DNMG 442-FM	T7325									++	.031	.006	.018	.031	.118
T7335										+++	.031	.006	.018	.031	.118	
T9310										++	.031	.006	.018	.031	.118	
T9315										++	.031	.006	.018	.031	.118	
T9325										++	.031	.006	.018	.031	.118	
T8315										++	.031	.006	.018	.031	.118	
T8330										++	.031	.006	.018	.031	.118	
DNMG 443-FM	T7325									++	.047	.006	.018	.047	.118	
	T9315									++	.047	.006	.018	.047	.118	
	T9325															

i	ANSI		P	M	K	N	S	H			$r_e$	$f_{min}$	$f_{max}$	$a_{p_{min}}$	$a_{p_{max}}$
	DNMG 432-M	T9325	■	■	■				●	++	.031	.006	.019	.031	.177
		T9335	■	■	■				●	+++	.031	.006	.019	.031	.177
	DNMG 433-M	T5315	■	□	■			□	●	++	.047	.007	.028	.047	.177
		T9315	■	□	■			□	●	+++	.047	.007	.028	.047	.177
		T9325	■	■	■				●	++	.047	.007	.028	.047	.177
	DNMG 441-M	T9335	■	■	■				●	+++	.047	.007	.028	.047	.177
		T5315	■	□	■			□	●	+	.016	.007	.009	.031	.118
		T9315	■	□	■			□	●	++	.016	.007	.009	.031	.118
	DNMG 442-M	T9325	■	■	■				●	+	.016	.007	.009	.031	.118
		T9335	■	■	■				●	++	.016	.007	.009	.031	.118
		T5315	■	□	■			□	●	++	.031	.006	.019	.031	.177
		T9310	■	□	■			□	●	++	.031	.006	.019	.031	.177
T9315		■	□	■			□	●	++	.031	.006	.019	.031	.177	
DNMG 443-M	T9325	■	■	■				●	++	.031	.006	.019	.031	.177	
	T9335	■	■	■				●	+++	.031	.006	.019	.031	.177	
	T5315	■	□	■			□	●	++	.047	.007	.028	.047	.177	
	T9310	■	□	■			□	●	++	.047	.007	.028	.047	.177	
	T9315	■	□	■			□	●	+++	.047	.007	.028	.047	.177	
DNMG 331-NF	T9325	■	■	■				●	++	.047	.007	.028	.047	.177	
	T7325	■	■	■			■	●	++	.016	.004	.009	.016	.118	
	T7335	■	■	■			■	●	++	.016	.004	.009	.016	.118	
	T9315	■	■	■				●	++	.016	.004	.009	.016	.118	
	T9325	■	■	■			■	●	+	.016	.004	.009	.016	.118	
	T6310	■	■	■			■	●	+	.016	.004	.009	.016	.118	
DNMG 332-NF	T8330	■	■	■			■	●	+	.016	.004	.009	.016	.118	
	T7325	■	■	■			■	●	++	.031	.006	.012	.031	.118	
	T7335	■	■	■			■	●	++	.031	.006	.012	.031	.118	
	T9315	■	■	■				●	++	.031	.006	.012	.031	.118	
	T9325	■	■	■			■	●	+	.031	.006	.012	.031	.118	
	T6310	■	■	■			■	●	+	.031	.005	.012	.031	.118	
DNMG 431-NF	T8330	■	■	■			■	●	+	.031	.005	.012	.031	.118	
	T7325	■	■	■			■	●	++	.016	.006	.009	.016	.118	
	T7335	■	■	■			■	●	++	.016	.006	.009	.016	.118	
	T9315	■	■	■				●	++	.016	.006	.009	.016	.118	
	T9325	■	■	■			■	●	+	.016	.006	.009	.016	.118	
	T6310	■	■	■			■	●	+	.016	.005	.009	.016	.118	
DNMG 432-NF	T8330	■	■	■			■	●	+	.016	.005	.009	.016	.118	
	T7325	■	■	■			■	●	++	.031	.006	.012	.031	.118	
	T7335	■	■	■			■	●	++	.031	.006	.012	.031	.118	
	T9315	■	■	■				●	++	.031	.006	.012	.031	.118	
	T9325	■	■	■			■	●	+	.031	.006	.012	.031	.118	
	T6310	■	■	■			■	●	+	.031	.006	.012	.031	.118	
DNMG 441-NF	T8330	■	■	■			■	●	+	.031	.006	.012	.031	.118	
	HF7	■	□	□	□	□		●	+	.016	.005	.009	.016	.118	
	T7325	■	■	■			■	●	++	.016	.006	.009	.016	.118	
	T7335	■	■	■			■	●	++	.016	.006	.009	.016	.118	
	T9315	■	■	■				●	++	.016	.006	.009	.016	.118	
	T9325	■	■	■			■	●	+	.016	.006	.009	.016	.118	
	T6310	■	■	■			■	●	+	.016	.005	.009	.016	.118	
DNMG 442-NF	T8315	■	■	■			■	●	+	.016	.005	.009	.016	.118	
	T8330	■	■	■			■	●	+	.016	.005	.009	.016	.118	
	T7325	■	■	■			■	●	++	.031	.006	.012	.031	.118	
	T7335	■	■	■			■	●	++	.031	.006	.012	.031	.118	
	T9315	■	■	■				●	++	.031	.006	.012	.031	.118	
	T9325	■	■	■			■	●	+	.031	.006	.012	.031	.118	
DNMG 443-NF	T6310	■	■	■			■	●	+	.031	.006	.012	.031	.118	
	T8315	■	■	■			■	●	+	.031	.006	.012	.031	.118	
	T8330	■	■	■			■	●	+	.031	.006	.012	.031	.118	
	T8330	■	■	■			■	●	+	.031	.006	.012	.031	.118	

i	ANSI	Image	P	M	K	N	S	H	?	Image	r <sub>c</sub>	f <sub>min</sub>	f <sub>max</sub>	a <sub>p min</sub>	a <sub>p max</sub>	
   	DNMG 442-NF	HF7		☐		☐	☐		●	+	.031	.006	.012	.031	.118	
	DNMG 443-NF	T9325	■	■			■		●	++	.047	.006	.014	.047	.138	
	T6310	■	■		☐	■			●	+	.047	.006	.014	.047	.138	
   	DNMG 331-NM	T7325	■	■			■		●	++	.016	.006	.009	.020	.118	
	T7335	■	■						●	++	.016	.006	.009	.020	.118	
	T9325	■	■	☐		☐			●	+	.016	.006	.009	.020	.118	
	T8315	■	■	☐	☐	☐			●	+	.016	.006	.009	.020	.118	
	T8330	■	■	☐	☐	■			●	+	.016	.006	.009	.020	.118	
	DNMG 332-NM	T7325	■	■			■		●	++	.031	.008	.016	.031	.118	
	T7335	■	■						●	++	.031	.008	.016	.031	.118	
	T9325	■	■	☐		☐			●	++	.031	.008	.016	.031	.118	
	T8315	■	■	☐	☐	☐			●	+	.031	.008	.016	.031	.118	
	T8330	■	■	☐	☐	■			●	++	.031	.008	.016	.031	.118	
	DNMG 432-NM	T7335	■	■						●	++	.031	.008	.016	.031	.118
	T9325	■	■	☐		☐				●	++	.031	.008	.016	.031	.118
T8330	■	■	☐	☐	■			●	++	.031	.008	.016	.031	.118		
DNMG 441-NM	T7325	■	■			■			●	++	.016	.006	.009	.020	.118	
T7335	■	■							●	++	.016	.006	.009	.020	.118	
T9315	■	■	☐						●	++	.016	.006	.009	.020	.118	
T9325	■	■	☐		☐				●	+	.016	.006	.009	.020	.118	
T8315*	■	■	☐	☐	☐				●	+	.016	.006	.009	.020	.118	
T8330	■	■	☐	☐	■				●	+	.016	.006	.009	.020	.118	
DNMG 442-NM	T7325	■	■			■			●	++	.031	.008	.016	.031	.118	
T7335	■	■							●	++	.031	.008	.016	.031	.118	
T9315	■	■	☐						●	++	.031	.008	.016	.031	.118	
T9325	■	■	☐		☐				●	++	.031	.008	.016	.031	.118	
T8315	■	■	☐	☐	☐				●	+	.031	.008	.016	.031	.118	
T8330	■	■	☐	☐	■				●	++	.031	.008	.016	.031	.118	
DNMG 443-NM	T7325	■	■			■			●	++	.047	.008	.016	.047	.138	
T7335	■	■							●	++	.047	.008	.016	.047	.138	
T9325	■	■	☐		☐				●	++	.047	.008	.016	.047	.138	
T8315	■	■	☐	☐	☐				●	+	.047	.008	.016	.047	.138	
DNMG 331-NMR	T7325	■	■			■			●	++	.016	.007	.009	.016	.118	
T9315	■	■	☐						●	++	.016	.007	.009	.016	.118	
T9325	■	■	☐		■				●	+	.016	.007	.009	.016	.118	
DNMG 332-NMR	T7325	■	■			■			●	++	.031	.008	.016	.031	.118	
T9315	■	■	☐						●	++	.031	.008	.016	.031	.118	
T9325	■	■	☐		■				●	++	.031	.008	.016	.031	.118	
DNMG 333-NMR	T7325	■	■			■			●	++	.047	.008	.020	.047	.130	
T9315	■	■	☐						●	++	.047	.008	.020	.047	.130	
T9325*	■	■	☐		■				●	++	.047	.008	.020	.047	.130	
DNMG 431-NMR	T7325	■	■			■			●	++	.016	.008	.009	.016	.138	
T7335	■	■				■			●	++	.016	.008	.009	.016	.138	
T9325	■	■	☐		■				●	+	.016	.008	.009	.016	.138	
DNMG 432-NMR	T7325	■	■			■			●	++	.031	.008	.019	.031	.157	
T7335*	■	■				■			●	+++	.031	.008	.019	.031	.157	
T9315*	■	■	☐						●	++	.031	.008	.019	.031	.157	
T9325	■	■	☐		■				●	++	.031	.008	.019	.031	.157	
T8330	■	■	☐		■				●	++	.031	.008	.019	.031	.157	
DNMG 441-NMR	T7325	■	■			■			●	++	.016	.008	.009	.016	.138	
T7335	■	■				■			●	++	.016	.008	.009	.016	.138	
T9315	■	■	☐						●	++	.016	.008	.009	.016	.138	
T9325	■	■	☐		■				●	+	.016	.008	.009	.016	.138	
T8330	■	■	☐		■				●	+	.016	.008	.009	.016	.138	

\* Non-stocked item

i	ANSI	Image	P	M	K	N	S	H	Image	Image	r <sub>c</sub>	f <sub>min</sub>	f <sub>max</sub>	a <sub>p min</sub>	a <sub>p max</sub>	
																?
	DNMG 442-NMR	T6310	█	█			█		⊕	++	.031	.008	.019	.031	.157	
		T7325	█	█			█		⊕	++	.031	.008	.019	.031	.157	
		T7335	█	█			█		⊕	+++	.031	.008	.019	.031	.157	
		T9315	█							●	++	.031	.008	.019	.031	.157
		T9325	█	█			█		⊕	++	.031	.008	.019	.031	.157	
	DNMG 443-NMR	T7325	█	█			█		⊕	++	.047	.009	.022	.047	.157	
		T7335	█	█			█		⊕	+++	.047	.009	.022	.047	.157	
		T9315	█							●	++	.047	.009	.022	.047	.157
		T9325	█	█			█		⊕	++	.047	.009	.022	.047	.157	
		T8330	█	█			█		⊕	++	.047	.009	.022	.047	.157	
	DNMG 150408-NRM	T7325	█	█			□		●	++	.031	.009	.018	.031	.157	
		T7335	█	█			□		●	+++	.031	.009	.018	.031	.157	
		T9315	█							●	++	.031	.009	.018	.031	.157
	DNMG 150604-NRM	T7325	█	█			□			●	++	.016	.006	.009	.016	.157
		T7335	█	█			□			●	++	.016	.006	.009	.016	.157
	DNMG 150608-NRM	T7325	█	█			□			●	++	.031	.009	.018	.031	.157
		T7335	█	█			□			⊕	+++	.031	.009	.018	.031	.157
		T9315	█							●	++	.031	.009	.018	.031	.157
	DNMG 150612-NRM	T7325	█	█			□			⊕	+++	.047	.010	.028	.047	.157
		T7335	█	█			□			⊕	+++	.047	.010	.028	.047	.157
T9315		█							⊕	+++	.047	.010	.028	.047	.157	
	DNMG 432-R	T5315	█	□	█			□	●	++	.031	.010	.019	.079	.177	
		DNMG 442-R	T5305	□		█			□	●	++	.031	.010	.019	.079	.177
	DNMG 443-R	T5315	█	□	█			□	⊕	++	.031	.010	.019	.079	.177	
		T9310	█		█			□	●	++	.031	.010	.019	.079	.177	
		T9315	█		█			□	⊕	++	.031	.010	.019	.079	.177	
		T9325	█	█	█					⊕	++	.031	.010	.019	.079	.177
		T5305	□		█			□	⊕	++	.047	.010	.028	.079	.177	
		T5315	█	□	█			□	⊕	++	.047	.010	.028	.079	.177	
	DNMG 444-R	T9310*	█		█			□	⊕	++	.047	.010	.028	.079	.177	
		T9315	█		█			□	⊕	+++	.047	.010	.028	.079	.177	
T9325		█	█	█					⊕	++	.047	.010	.028	.079	.177	
DNMG 444-R		T9325	█	█	█				⊕	++	.063	.012	.031	.079	.177	
DNMG 332-RM	T9315	█		█			□		●	++	.031	.008	.019	.039	.130	
	T9325	█	█	█			□		●	++	.031	.008	.019	.039	.130	
	T9335	█	█						⊕	+++	.031	.008	.019	.039	.130	
DNMG 333-RM	T9315	█		█			□		⊕	+++	.047	.010	.024	.059	.130	
	T9325	█	█	█			□		⊕	++	.047	.010	.024	.059	.130	
	T9335	█	█						⊕	+++	.047	.010	.024	.059	.130	
DNMG 432-RM	T9315	█		█			□		●	++	.031	.010	.019	.031	.177	
	T9325	█	█	█			□		●	++	.031	.010	.019	.031	.177	
	T9335	█	█						⊕	+++	.031	.010	.019	.031	.177	
DNMG 433-RM	T7325	█	█			█			⊕	+++	.047	.010	.028	.059	.177	
	T9315	█		█			□		⊕	+++	.047	.010	.028	.059	.177	
	T9325	█	█	█			□		⊕	++	.047	.010	.028	.059	.177	
	T9335	█	█						⊕	+++	.047	.010	.028	.059	.177	
	DNMG 442-RM	T5305	□		█			□	●	++	.031	.008	.019	.039	.177	
		T5315	█	□	█			□	●	++	.031	.008	.019	.039	.177	
	DNMG 442-RM	T7325	█	█			█			⊕	++	.031	.008	.019	.039	.177
		T7335	█	█			█			⊕	+++	.031	.008	.019	.039	.177
		T9310	█		█					●	++	.031	.008	.019	.039	.177
		T9315	█		█			□		●	++	.031	.008	.019	.039	.177
		T9325	█	█	█			□		⊕	++	.031	.008	.019	.039	.177
		T9335	█	█						⊕	+++	.031	.008	.019	.039	.177
		T8315	█	█	█			□	□	⊕	++	.031	.008	.019	.039	.177
		T8330	█	█	█			█	□	⊕	++	.031	.008	.019	.039	.177

\* Non-stocked item



i		ANSI		Material								r <sub>ε</sub>	f <sub>min</sub>	f <sub>max</sub>	a <sub>p min</sub>	a <sub>p max</sub>
				P	M	K	N	S	H							
   		DNMG 443-RM	T5305	<input type="checkbox"/>	<input type="checkbox"/>	<input checked="" type="checkbox"/>	<input type="checkbox"/>	<input type="checkbox"/>	<input type="checkbox"/>	<input checked="" type="checkbox"/>	++	.047	.010	.028	.059	.177
			T5315	<input checked="" type="checkbox"/>	<input type="checkbox"/>	<input checked="" type="checkbox"/>	<input type="checkbox"/>	<input type="checkbox"/>	<input type="checkbox"/>	<input checked="" type="checkbox"/>	++	.047	.010	.028	.059	.177
			T7325	<input checked="" type="checkbox"/>	<input checked="" type="checkbox"/>	<input type="checkbox"/>	<input type="checkbox"/>	<input checked="" type="checkbox"/>	<input type="checkbox"/>	<input checked="" type="checkbox"/>	+++	.047	.010	.028	.059	.177
			T7335	<input checked="" type="checkbox"/>	<input checked="" type="checkbox"/>	<input type="checkbox"/>	<input type="checkbox"/>	<input checked="" type="checkbox"/>	<input type="checkbox"/>	<input checked="" type="checkbox"/>	+++	.047	.010	.028	.059	.177
			T9310	<input checked="" type="checkbox"/>	<input type="checkbox"/>	<input checked="" type="checkbox"/>	<input type="checkbox"/>	<input type="checkbox"/>	<input type="checkbox"/>	<input checked="" type="checkbox"/>	++	.047	.010	.028	.059	.177
			T9315	<input checked="" type="checkbox"/>	<input type="checkbox"/>	<input checked="" type="checkbox"/>	<input type="checkbox"/>	<input type="checkbox"/>	<input type="checkbox"/>	<input checked="" type="checkbox"/>	+++	.047	.010	.028	.059	.177
		T9325	<input checked="" type="checkbox"/>	<input checked="" type="checkbox"/>	<input checked="" type="checkbox"/>	<input type="checkbox"/>	<input type="checkbox"/>	<input type="checkbox"/>	<input checked="" type="checkbox"/>	++	.047	.010	.028	.059	.177	
		T9335	<input checked="" type="checkbox"/>	<input checked="" type="checkbox"/>	<input type="checkbox"/>	<input type="checkbox"/>	<input type="checkbox"/>	<input type="checkbox"/>	<input checked="" type="checkbox"/>	+++	.047	.010	.028	.059	.177	
		T8330	<input checked="" type="checkbox"/>	<input checked="" type="checkbox"/>	<input checked="" type="checkbox"/>	<input type="checkbox"/>	<input checked="" type="checkbox"/>	<input type="checkbox"/>	<input checked="" type="checkbox"/>	++	.047	.010	.028	.059	.177	
		DNMG 444-RM	T5315	<input checked="" type="checkbox"/>	<input type="checkbox"/>	<input checked="" type="checkbox"/>	<input type="checkbox"/>	<input type="checkbox"/>	<input type="checkbox"/>	<input checked="" type="checkbox"/>	++	.063	.012	.030	.079	.177
			T9315	<input checked="" type="checkbox"/>	<input type="checkbox"/>	<input checked="" type="checkbox"/>	<input type="checkbox"/>	<input type="checkbox"/>	<input type="checkbox"/>	<input checked="" type="checkbox"/>	+++	.063	.012	.030	.079	.177
			T9325	<input checked="" type="checkbox"/>	<input checked="" type="checkbox"/>	<input checked="" type="checkbox"/>	<input type="checkbox"/>	<input type="checkbox"/>	<input type="checkbox"/>	<input checked="" type="checkbox"/>	++	.063	.012	.030	.079	.177
T9335	<input checked="" type="checkbox"/>		<input checked="" type="checkbox"/>	<input type="checkbox"/>	<input type="checkbox"/>	<input type="checkbox"/>	<input type="checkbox"/>	<input checked="" type="checkbox"/>	+++	.063	.012	.030	.079	.177		
DNMG 331-SF	T7325	<input checked="" type="checkbox"/>	<input checked="" type="checkbox"/>	<input type="checkbox"/>	<input type="checkbox"/>	<input checked="" type="checkbox"/>	<input type="checkbox"/>	<input checked="" type="checkbox"/>	++	.016	.006	.009	.016	.079		
	T9315	<input checked="" type="checkbox"/>	<input type="checkbox"/>	<input type="checkbox"/>	<input type="checkbox"/>	<input type="checkbox"/>	<input type="checkbox"/>	<input checked="" type="checkbox"/>	++	.016	.006	.009	.016	.079		
	T9325	<input checked="" type="checkbox"/>	<input checked="" type="checkbox"/>	<input type="checkbox"/>	<input type="checkbox"/>	<input checked="" type="checkbox"/>	<input type="checkbox"/>	<input checked="" type="checkbox"/>	+	.016	.006	.009	.016	.079		
	T6310	<input checked="" type="checkbox"/>	<input checked="" type="checkbox"/>	<input type="checkbox"/>	<input checked="" type="checkbox"/>	<input type="checkbox"/>	<input type="checkbox"/>	<input checked="" type="checkbox"/>	+	.016	.004	.009	.016	.079		
	T8315	<input checked="" type="checkbox"/>	<input checked="" type="checkbox"/>	<input type="checkbox"/>	<input type="checkbox"/>	<input type="checkbox"/>	<input type="checkbox"/>	<input checked="" type="checkbox"/>	+	.016	.004	.009	.016	.079		
	T8315*	<input checked="" type="checkbox"/>	<input checked="" type="checkbox"/>	<input type="checkbox"/>	<input type="checkbox"/>	<input type="checkbox"/>	<input type="checkbox"/>	<input checked="" type="checkbox"/>	+	.016	.004	.009	.016	.079		
DNMG 332-SF	T7325	<input checked="" type="checkbox"/>	<input checked="" type="checkbox"/>	<input type="checkbox"/>	<input type="checkbox"/>	<input checked="" type="checkbox"/>	<input type="checkbox"/>	<input checked="" type="checkbox"/>	++	.031	.006	.011	.031	.098		
	T7335	<input checked="" type="checkbox"/>	<input checked="" type="checkbox"/>	<input type="checkbox"/>	<input type="checkbox"/>	<input checked="" type="checkbox"/>	<input type="checkbox"/>	<input checked="" type="checkbox"/>	++	.031	.006	.011	.031	.098		
	T9325	<input checked="" type="checkbox"/>	<input checked="" type="checkbox"/>	<input type="checkbox"/>	<input type="checkbox"/>	<input checked="" type="checkbox"/>	<input type="checkbox"/>	<input checked="" type="checkbox"/>	++	.031	.006	.011	.031	.098		
	T6310	<input checked="" type="checkbox"/>	<input checked="" type="checkbox"/>	<input type="checkbox"/>	<input type="checkbox"/>	<input type="checkbox"/>	<input type="checkbox"/>	<input checked="" type="checkbox"/>	+	.031	.005	.011	.031	.098		
DNMG 431-SF	T9325	<input checked="" type="checkbox"/>	<input checked="" type="checkbox"/>	<input type="checkbox"/>	<input type="checkbox"/>	<input checked="" type="checkbox"/>	<input type="checkbox"/>	<input checked="" type="checkbox"/>	+	.016	.006	.009	.016	.098		
	T6310	<input checked="" type="checkbox"/>	<input checked="" type="checkbox"/>	<input type="checkbox"/>	<input checked="" type="checkbox"/>	<input type="checkbox"/>	<input type="checkbox"/>	<input checked="" type="checkbox"/>	+	.016	.004	.009	.016	.098		
	T8315	<input checked="" type="checkbox"/>	<input checked="" type="checkbox"/>	<input type="checkbox"/>	<input type="checkbox"/>	<input type="checkbox"/>	<input type="checkbox"/>	<input checked="" type="checkbox"/>	+	.016	.004	.009	.016	.098		
DNMG 432-SF	T9325	<input checked="" type="checkbox"/>	<input checked="" type="checkbox"/>	<input type="checkbox"/>	<input type="checkbox"/>	<input checked="" type="checkbox"/>	<input type="checkbox"/>	<input checked="" type="checkbox"/>	+	.031	.006	.012	.031	.118		
	T6310	<input checked="" type="checkbox"/>	<input checked="" type="checkbox"/>	<input type="checkbox"/>	<input checked="" type="checkbox"/>	<input type="checkbox"/>	<input type="checkbox"/>	<input checked="" type="checkbox"/>	+	.031	.005	.012	.031	.118		
	T8315*	<input checked="" type="checkbox"/>	<input checked="" type="checkbox"/>	<input type="checkbox"/>	<input type="checkbox"/>	<input type="checkbox"/>	<input type="checkbox"/>	<input checked="" type="checkbox"/>	+	.031	.005	.012	.031	.118		
	T8330	<input checked="" type="checkbox"/>	<input checked="" type="checkbox"/>	<input type="checkbox"/>	<input checked="" type="checkbox"/>	<input type="checkbox"/>	<input type="checkbox"/>	<input checked="" type="checkbox"/>	+	.031	.005	.012	.031	.118		
DNMG 441-SF	T7325	<input checked="" type="checkbox"/>	<input checked="" type="checkbox"/>	<input type="checkbox"/>	<input type="checkbox"/>	<input checked="" type="checkbox"/>	<input type="checkbox"/>	<input checked="" type="checkbox"/>	++	.016	.006	.009	.016	.098		
	T7335	<input checked="" type="checkbox"/>	<input checked="" type="checkbox"/>	<input type="checkbox"/>	<input type="checkbox"/>	<input checked="" type="checkbox"/>	<input type="checkbox"/>	<input checked="" type="checkbox"/>	++	.016	.006	.009	.016	.098		
	T9315	<input checked="" type="checkbox"/>	<input type="checkbox"/>	<input type="checkbox"/>	<input type="checkbox"/>	<input type="checkbox"/>	<input type="checkbox"/>	<input checked="" type="checkbox"/>	++	.016	.006	.009	.016	.098		
	T9325	<input checked="" type="checkbox"/>	<input checked="" type="checkbox"/>	<input type="checkbox"/>	<input type="checkbox"/>	<input checked="" type="checkbox"/>	<input type="checkbox"/>	<input checked="" type="checkbox"/>	+	.016	.006	.009	.016	.098		
	T6310	<input checked="" type="checkbox"/>	<input checked="" type="checkbox"/>	<input type="checkbox"/>	<input checked="" type="checkbox"/>	<input type="checkbox"/>	<input type="checkbox"/>	<input checked="" type="checkbox"/>	+	.016	.004	.009	.016	.098		
	T8315	<input checked="" type="checkbox"/>	<input checked="" type="checkbox"/>	<input type="checkbox"/>	<input type="checkbox"/>	<input type="checkbox"/>	<input type="checkbox"/>	<input checked="" type="checkbox"/>	+	.016	.004	.009	.016	.098		
	T8330	<input checked="" type="checkbox"/>	<input checked="" type="checkbox"/>	<input type="checkbox"/>	<input checked="" type="checkbox"/>	<input type="checkbox"/>	<input type="checkbox"/>	<input checked="" type="checkbox"/>	+	.016	.004	.009	.016	.098		
	H07	<input type="checkbox"/>	<input checked="" type="checkbox"/>	<input type="checkbox"/>	<input type="checkbox"/>	<input checked="" type="checkbox"/>	<input type="checkbox"/>	<input checked="" type="checkbox"/>	+	.016	.004	.009	.016	.098		
	T9325	<input checked="" type="checkbox"/>	<input checked="" type="checkbox"/>	<input type="checkbox"/>	<input type="checkbox"/>	<input checked="" type="checkbox"/>	<input type="checkbox"/>	<input checked="" type="checkbox"/>	+	.016	.006	.009	.016	.098		
DNMG 442-SF	T7325	<input checked="" type="checkbox"/>	<input checked="" type="checkbox"/>	<input type="checkbox"/>	<input type="checkbox"/>	<input checked="" type="checkbox"/>	<input type="checkbox"/>	<input checked="" type="checkbox"/>	++	.031	.006	.012	.031	.118		
	T7335	<input checked="" type="checkbox"/>	<input checked="" type="checkbox"/>	<input type="checkbox"/>	<input type="checkbox"/>	<input checked="" type="checkbox"/>	<input type="checkbox"/>	<input checked="" type="checkbox"/>	++	.031	.006	.012	.031	.118		
	T9315	<input checked="" type="checkbox"/>	<input type="checkbox"/>	<input type="checkbox"/>	<input type="checkbox"/>	<input type="checkbox"/>	<input type="checkbox"/>	<input checked="" type="checkbox"/>	++	.031	.006	.012	.031	.118		
	T9325	<input checked="" type="checkbox"/>	<input checked="" type="checkbox"/>	<input type="checkbox"/>	<input type="checkbox"/>	<input checked="" type="checkbox"/>	<input type="checkbox"/>	<input checked="" type="checkbox"/>	+	.031	.006	.012	.031	.118		
	T6310	<input checked="" type="checkbox"/>	<input checked="" type="checkbox"/>	<input type="checkbox"/>	<input checked="" type="checkbox"/>	<input type="checkbox"/>	<input type="checkbox"/>	<input checked="" type="checkbox"/>	+	.031	.005	.012	.031	.118		
	T8315	<input checked="" type="checkbox"/>	<input checked="" type="checkbox"/>	<input type="checkbox"/>	<input type="checkbox"/>	<input type="checkbox"/>	<input type="checkbox"/>	<input checked="" type="checkbox"/>	+	.031	.005	.012	.031	.118		
	T8330	<input checked="" type="checkbox"/>	<input checked="" type="checkbox"/>	<input type="checkbox"/>	<input checked="" type="checkbox"/>	<input type="checkbox"/>	<input type="checkbox"/>	<input checked="" type="checkbox"/>	+	.031	.005	.012	.031	.118		
	H07	<input type="checkbox"/>	<input checked="" type="checkbox"/>	<input type="checkbox"/>	<input type="checkbox"/>	<input checked="" type="checkbox"/>	<input type="checkbox"/>	<input checked="" type="checkbox"/>	+	.031	.005	.012	.031	.118		
	T9325	<input checked="" type="checkbox"/>	<input checked="" type="checkbox"/>	<input type="checkbox"/>	<input type="checkbox"/>	<input checked="" type="checkbox"/>	<input type="checkbox"/>	<input checked="" type="checkbox"/>	+	.031	.006	.012	.031	.118		
DNMG 443-SF	T7325	<input checked="" type="checkbox"/>	<input checked="" type="checkbox"/>	<input type="checkbox"/>	<input type="checkbox"/>	<input checked="" type="checkbox"/>	<input type="checkbox"/>	<input checked="" type="checkbox"/>	++	.047	.006	.012	.047	.118		
	T9315	<input checked="" type="checkbox"/>	<input type="checkbox"/>	<input type="checkbox"/>	<input type="checkbox"/>	<input type="checkbox"/>	<input type="checkbox"/>	<input checked="" type="checkbox"/>	++	.047	.006	.012	.047	.118		
	T6310	<input checked="" type="checkbox"/>	<input checked="" type="checkbox"/>	<input type="checkbox"/>	<input checked="" type="checkbox"/>	<input type="checkbox"/>	<input type="checkbox"/>	<input checked="" type="checkbox"/>	+	.047	.006	.012	.047	.118		

\* Non-stocked item

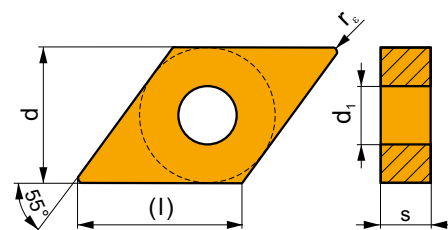
i	ANSI		Material							r <sub>c</sub>	f <sub>min</sub>	f <sub>max</sub>	a <sub>p min</sub>	a <sub>p max</sub>	
			P	M	K	N	S								H
	DNMG 331-SM	T7325	█	█				●	++	.016	.006	.009	.016	.118	
		T7335	█	█				●	++	.016	.006	.009	.016	.118	
		T9325	█	█	█		█		●	+	.016	.006	.009	.016	.118
		T6310	█	█	█		█	□	●	+	.016	.006	.009	.016	.118
	DNMG 332-SM	T7325	█	█				●	++	.031	.007	.014	.031	.130	
		T7335	█	█				●	++	.031	.007	.014	.031	.130	
	DNMG 332-SM	T9325	█	█	█		█	●	++	.031	.007	.014	.031	.130	
		T6310	█	█	█		█	□	●	+	.031	.007	.014	.031	.130
		T8330	█	█	█		█	□	●	++	.031	.007	.014	.031	.130
	DNMG 431-SM	T6310	█	█	█		█	□	●	+	.016	.007	.009	.016	.157
	DNMG 432-SM	T6310	█	█	█		█	□	●	+	.031	.008	.018	.031	.157
	DNMG 441-SM	T7325	█	█					●	++	.016	.007	.009	.016	.138
		T7335	█	█					●	++	.016	.007	.009	.016	.138
	DNMG 442-SM	T9315	█	█	█			□	●	++	.016	.007	.009	.016	.138
		T9325	█	█	█		█		●	+	.016	.007	.009	.016	.138
		T6310	█	█	█		█	□	●	+	.016	.007	.009	.016	.138
		T8330	█	█	█		█	□	●	+	.016	.007	.009	.016	.138
		T7325	█	█					●	++	.031	.008	.016	.031	.157
		T7335	█	█					●	++	.031	.008	.016	.031	.157
	DNMG 443-SM	T9315	█	█	█			□	●	++	.031	.008	.016	.031	.157
		T9325	█	█	█		█		●	++	.031	.008	.016	.031	.157
		T6310	█	█	█		█	□	●	++	.031	.008	.016	.031	.157
T8330		█	█	█		█	□	●	++	.031	.008	.016	.031	.157	
T7325		█	█					●	++	.047	.009	.016	.047	.157	
T7335		█	█					●	+++	.047	.009	.016	.047	.157	
	DNMG 331R-SI	T7325	█	█				●	++	.016	.008	.009	.031	.130	
		T7335	█	█				●	++	.016	.008	.009	.031	.130	
		T9325	█	█	□		□		●	+	.016	.008	.009	.031	.130
		T8330	█	█	□	□	█		●	+	.016	.008	.009	.031	.130
	DNMG 332R-SI	T7335*	█	█					●	+++	.031	.008	.019	.031	.130
		T9325	█	█	□		□		●	++	.031	.008	.019	.031	.130
		T8330	█	█	□	□	█		●	++	.031	.008	.019	.031	.130
	DNMG 431R-SI	T9325	█	█	□		□		●	+	.016	.008	.009	.016	.177
	DNMG 432R-SI	T8330	█	█	□	□	█		●	+	.016	.008	.009	.016	.177
		T9325	█	█	□		□		●	++	.031	.008	.019	.031	.177
	DNMG 441R-SI	T8330	█	█	□	□	█		●	++	.031	.008	.019	.031	.177
		T7325	█	█					●	++	.016	.008	.009	.031	.177
T7335		█	█					●	++	.016	.008	.009	.031	.177	
T9325		█	█	□		□		●	+	.016	.008	.009	.031	.177	
DNMG 442R-SI	T8315	█	█	□	□	□		●	+	.016	.008	.009	.031	.177	
	T8330	█	█	□	□	█		●	+	.016	.008	.009	.031	.177	
	T7325	█	█					●	++	.031	.008	.019	.031	.177	
	T7335	█	█					●	+++	.031	.008	.019	.031	.177	
DNMG 331L-SI	T9325	█	█	□		□		●	++	.031	.008	.019	.031	.177	
	T8315	█	█	□	□	□		●	++	.031	.008	.019	.031	.177	
	T8330	█	█	□	□	█		●	++	.031	.008	.019	.031	.177	
	T7335	█	█					●	++	.016	.008	.009	.031	.130	
DNMG 331L-SI	T9325	█	█	□		□		●	+	.016	.008	.009	.031	.130	
	T8330	█	█	□	□	█		●	+	.016	.008	.009	.031	.130	

\* Non-stocked item

i	ANSI	Image	P	M	K	N	S	H	?	Image	$r_e$	$f_{min}$	$f_{max}$	$a_{p min}$	$a_{p max}$
	DNMG 332L-SI	T7325*	█	█			█		●	++	.031	.008	.019	.031	.130
		T7335	█	█					●	+++	.031	.008	.019	.031	.130
		T9325	█	█	□		□		●	++	.031	.008	.019	.031	.130
		T8330	█	█	□	□	█		●	++	.031	.008	.019	.031	.130
	DNMG 431L-SI	T9325	█	█	□		□		●	+	.016	.008	.009	.016	.177
		T8330	█	█	□	□	█		●	+	.016	.008	.009	.016	.177
	DNMG 432L-SI	T7335	█	█					●	+++	.031	.008	.019	.031	.177
		T9325	█	█	□		□		●	++	.031	.008	.019	.031	.177
	DNMG 441L-SI	T8330	█	█	□	□	█		●	++	.031	.008	.019	.031	.177
		T7325	█	█			█		●	++	.016	.008	.009	.031	.177
		T7335	█	█					●	++	.016	.008	.009	.031	.177
		T9325	█	█	□		□		●	+	.016	.008	.009	.031	.177
	DNMG 442L-SI	T8315	█	█	□	□	□		●	+	.016	.008	.009	.031	.177
		T8330	█	█	□	□	█		●	+	.016	.008	.009	.031	.177
		T7325	█	█			█		●	++	.031	.008	.019	.031	.177
		T7335	█	█					●	+++	.031	.008	.019	.031	.177
DNMG 442W-MR	T9325	█	█	□		□		●	++	.031	.008	.019	.031	.177	
	T5315	█	□	█				●	++	.031	.008	.022	.031	.157	
	T9315	█	█	█				●	++	.031	.008	.022	.031	.157	
DNMG 443W-MR	T9325	█	█	█				●	++	.031	.008	.022	.031	.157	
	T9310	█	█	█				●	++	.047	.008	.024	.047	.157	
DNMG 443W-MR	T9325	█	█	█				●	++	.047	.008	.024	.047	.157	
	T9325	█	█	█				●	++	.047	.008	.024	.047	.157	
	DNMX 441W-NM	T7325	█	█			█		●	++	.016	.006	.016	.020	.118
		T7335	█	█					●	+++	.016	.006	.016	.020	.118
	DNMX 442W-NM	T9315	█	█	□				●	++	.016	.006	.016	.020	.118
		T7325	█	█			█		●	++	.031	.008	.020	.031	.118
	DNMX 442W-NM	T7335	█	█					●	+++	.031	.008	.020	.031	.118
		T9315	█	█	□				●	++	.031	.008	.020	.031	.118
		T9325	█	█	□		□		●	++	.031	.008	.020	.031	.118

\* Non-stocked item

DNMM				
Image	d	$d_1$	l	s
43	.500	.203	.610	.187
44	.500	.203	.610	.250



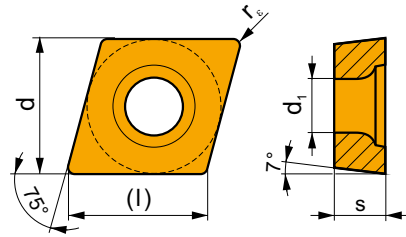
For tools see pages: T188-T189, T216

i	ANSI	Image	P	M	K	N	S	H	?	Image	$r_e$	$f_{min}$	$f_{max}$	$a_{p min}$	$a_{p max}$
	DNMM 432-NR	T7335	█	█					●	+++	.031	.010	.019	.039	.177
		T9325	█	█	□		□		●	++	.031	.010	.019	.039	.177
	DNMM 442-NR	T7325	█	█			█		●	+++	.031	.010	.019	.039	.177
		T7335	█	█					●	+++	.031	.010	.019	.039	.177
		T9325	█	█	□		□		●	++	.031	.010	.019	.039	.177
		T8330	█	█	□	□	█		●	++	.031	.010	.019	.039	.177

i	ANSI	Image	P	M	K	N	S	H	Image	Image	$r_\epsilon$	$f_{min}$	$f_{max}$	$a_{p min}$	$a_{p max}$
	DNMM 442-NR2	<p>.016 .005 21° 15°</p>	T9335	■	■				●	+	.031	.011	.019	.031	.177
			T9325	■	■	□		□	●	+	.031	.011	.019	.031	.177
	DNMM 442-OR		T9325	■	■	■		□	●	+	.031	.010	.019	.079	.177
			T9335	■	■	■		□	●	+	.031	.010	.019	.079	.177
	DNMM 443-OR	<p>.009-.018 .004-.006 4° 18°</p>	T9315	■	■	■		□	●	+	.047	.012	.028	.079	.177
			T9325	■	■	■		□	●	+	.047	.012	.028	.079	.177
	DNMM 444-OR		T9335	■	■	■		□	●	+	.047	.012	.028	.079	.177
			T9325	■	■	■		□	●	+	.063	.014	.031	.079	.177

### ECGT

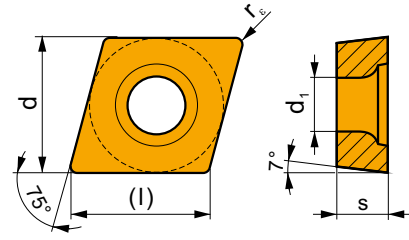
Image	d	d <sub>1</sub>	l	s	
	2.52	.313	.134	.323	.125
	2.52-SF3	.313	.134	.323	.135
	21.5	.250	.110	.256	.094
	21.5-SF3	.250	.110	.256	.102



i	ANSI	Image	P	M	K	N	S	H	Image	Image	$r_\epsilon$	$f_{min}$	$f_{max}$	$a_{p min}$	$a_{p max}$
	ECGT 21.50.5-SF2	<p>.016 25°</p>	T6310	■		■	■		●	+	.008	.001	.006	.004	.063
			H07	■	■	■		●	+	.008	.001	.006	.004	.063	
	ECGT 21.51-SF2	T6310	■	■	■		●	+	.016	.002	.008	.008	.098		
		H07	■	■	■		●	+	.016	.002	.008	.008	.098		
	ECGT 2.520.5-SF2		T6310	■		■	■		●	+	.008	.001	.008	.004	.079
			H07	■	■	■		●	+	.008	.001	.008	.004	.079	
	ECGT 2.521-SF2		T6310	■		■	■		●	+	.016	.002	.010	.008	.098
			H07	■	■	■		●	+	.016	.002	.010	.008	.098	
	ECGT 21.50.5-SF3	<p>.006 20°</p>	T6310	■		■	■		●	+	.008	.001	.006	.008	.063
			H07	■	■	■		●	+	.008	.001	.006	.008	.063	
	ECGT 2.521-SF3	T6310	■		■	■		●	+	.016	.002	.009	.008	.098	
		H07	■	■	■		●	+	.016	.002	.009	.008	.098		

## ECMT

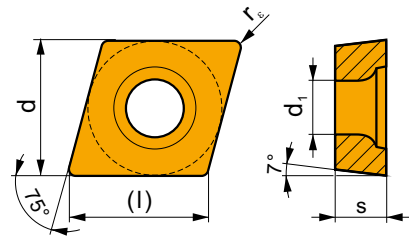
	d	d <sub>1</sub>	l	s
2.52	.313	.134	.323	.125
21.5	.250	.110	.256	.094



i	ANSI	Material	P	M	K	N	S	H	Chip	Coolant	r <sub>e</sub>	f <sub>min</sub>	f <sub>max</sub>	a <sub>p min</sub>	a <sub>p max</sub>	
																?
	ECMT 21.51-FM2	T7325	█	█			□		●	++	.016	.002	.010	.012	.106	
		T9315	█		█			□		●	++	.016	.002	.010	.012	.106
		T9325	█	█	█			□		●	+	.016	.002	.010	.012	.106
		T9335	█					□		●	++	.016	.002	.010	.012	.106
		T8330	█	█	█			□	□	●	+	.016	.002	.010	.012	.106
		T5315	█	□	█				□	●	+	.016	.002	.010	.012	.106
	ECMT 2.521-FM2	T7325	█	█				□		●	++	.016	.002	.010	.012	.106
		T9315	█		█			□		●	++	.016	.002	.010	.012	.106
		T9325	█	█	█			□		●	+	.016	.002	.010	.012	.106
		T9335	█					□		●	++	.016	.002	.010	.012	.106
		T8330	█	█	█			□	□	●	+	.016	.002	.010	.012	.106
		T7325	█	█				□		●	++	.031	.004	.016	.024	.138
ECMT 2.522-FM2	T9315	█		█			□		●	++	.031	.004	.016	.024	.138	
	T9325	█	█	█			□		●	+	.031	.004	.016	.024	.138	
	T9335	█					□		●	++	.031	.004	.016	.024	.138	
	T8330	█	█	█			□	□	●	++	.031	.004	.016	.024	.138	

## ECMW

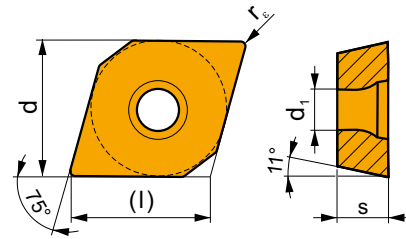
	d	d <sub>1</sub>	l	s
2.52	.313	.134	.323	.125
21.5	.250	.110	.256	.094



i	ANSI	Material	P	M	K	N	S	H	Chip	Coolant	r <sub>e</sub>	f <sub>min</sub>	f <sub>max</sub>	a <sub>p min</sub>	a <sub>p max</sub>
	ECMW 21.51	H07		█					●	+	.016	.002	.012	.016	.165
	ECMW 2.521	H07		█					●	+	.016	.002	.012	.016	.220
	ECMW 2.522	H07		█					●	+	.031	.002	.012	.031	.220

## EPMT

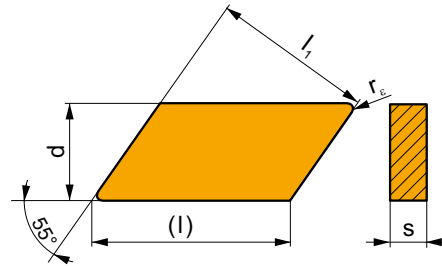
	d	d <sub>1</sub>	l	s
1.81.5	.219	.098	.224	.094



		ANSI		P	M	K	N	S	H			r <sub>ε</sub>	f <sub>min</sub>	f <sub>max</sub>	a <sub>p min</sub>	a <sub>p max</sub>
  		EPMT 1.81.50.5-NF2	T7325	■	■					●	+	.008	.002	.006	.008	.098
		T7335	■	■						●	++	.008	.002	.006	.008	.098
		T9315	■		■					●	+	.008	.002	.006	.008	.098
		T9325	■	■	■					●	+	.008	.002	.006	.008	.098
		T9335	■	■			■			●	++	.008	.002	.006	.008	.098
		H07		■	■			■		●	+	.008	.002	.006	.008	.098
		TT010	■	■						●	+/-	.008	.002	.006	.008	.098

## KNUX


	d	l	l <sub>1</sub>	s
1604	.375	.768	.636	.187

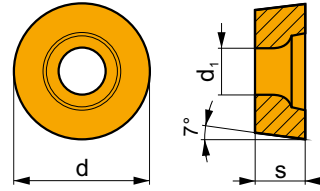


		ANSI		P	M	K	N	S	H			r <sub>ε</sub>	f <sub>min</sub>	f <sub>max</sub>	a <sub>p min</sub>	a <sub>p max</sub>
  		KNUX 160405L-22	T5315	■	□	■				●	++	.020	.009	.016	.020	.189
		T7325	■	■						●	++	.020	.009	.016	.020	.189
		T7335	■	■						●	+++	.020	.009	.016	.020	.189
		T9325	■	■	■					●	++	.020	.009	.016	.020	.189
		T9335	■	■						●	+++	.020	.009	.016	.020	.189
  		KNUX 160405R-22	T5315	■	□	■				●	++	.020	.009	.016	.020	.189
		T7325	■	■						●	++	.020	.009	.016	.020	.189
		T7335	■	■						●	+++	.020	.009	.016	.020	.189
		T9325	■	■	■					●	++	.020	.009	.016	.020	.189
		T9335	■	■						●	+++	.020	.009	.016	.020	.189
  		KNUX 160410L-22	T9335	■	■					●	+++	.039	.009	.022	.039	.189










<b>i</b>		ANSI		P	M	K	N	S	H			r <sub>e</sub>	f <sub>min</sub>	f <sub>max</sub>	a <sub>p min</sub>	a <sub>p max</sub>	
		<b>KNUX 160410R-22</b>		T9335	■	■					●	+++	.039	.009	.022	.039	.189
		<b>KNUX 160405L-32</b>		T5315	■	□	■				●	++	.020	.010	.016	.020	.189
		<b>KNUX 160405L-32</b>		T7325	■	■					●	++	.020	.010	.016	.020	.189
		<b>KNUX 160405L-32</b>		T7335	■	■					●	+++	.020	.010	.016	.020	.189
		<b>KNUX 160405R-32</b>		T9325	■	■	■				●	++	.020	.010	.016	.020	.189
		<b>KNUX 160405R-32</b>		T9335	■	■					●	+++	.020	.010	.016	.020	.189
		<b>KNUX 160410L-32</b>		T9325	■	■	■				●	++	.039	.010	.024	.039	.189
		<b>KNUX 160410L-32</b>		T9335	■	■					●	+++	.039	.010	.024	.039	.189
		<b>KNUX 160410R-32</b>		T9325	■	■	■				●	++	.039	.010	.024	.039	.189
		<b>KNUX 160410R-32</b>		T9335	■	■					●	+++	.039	.010	.024	.039	.189
		<b>KNUX 160405ER-72</b>		T5315	■	□	■				●	+	.020	.006	.009	.020	.157
		<b>KNUX 160405ER-72</b>		T9325	■	■	■				●	+	.020	.006	.009	.020	.157
		<b>KNUX 160405ER-72</b>		T9335	■	■					●	++	.020	.006	.009	.020	.157
		<b>KNUX 160405EL-72</b>		T5315	■	□	■				●	+	.020	.006	.009	.020	.157
		<b>KNUX 160405EL-72</b>		T9325	■	■	■				●	+	.020	.006	.009	.020	.157
		<b>KNUX 160405EL-72</b>		T9335	■	■					●	++	.020	.006	.009	.020	.157
		<b>KNUX 160405SR-73</b>		6640	■	■	■	□			●	++	.020	.008	.012	.020	.189
		<b>KNUX 160410SR-73</b>		T5315	■	□	■	□			●	++	.039	.008	.024	.039	.189
		<b>KNUX 160410SR-73</b>		6640	■	■	■	□			●	+++	.039	.008	.024	.039	.189
		<b>KNUX 160405SL-73</b>		6640	■	■	■	□			●	++	.020	.008	.012	.020	.189
		<b>KNUX 160410SL-73</b>		6640	■	■	■	□			●	+++	.039	.008	.024	.039	.189
		<b>KNUX 160415SR-74</b>		6640	■	■	■	□			●	+++	.059	.012	.028	.059	.189
		<b>KNUX 160415SR-74</b>															
		<b>KNUX 160415SL-74</b>		6640	■	■	■	□			●	+++	.059	.012	.028	.059	.189
		<b>KNUX 160415SL-74</b>															

## RCGT

	d	d <sub>1</sub>	s
0803	.315	.134	.125
1003	.394	.173	.125



For tools see pages: T201-T202, T206-T207

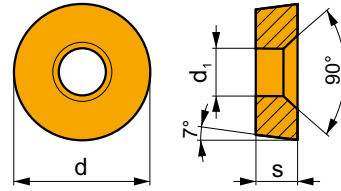
		ANSI		P	M	K	N	S	H			r <sub>c</sub>	f <sub>min</sub>	f <sub>max</sub>	a <sub>p min</sub>	a <sub>p max</sub>
		RCGT 0803MOF-AL	T0315				■			●	+	-	.008	.059	.031	.118
			HF7				■			●	+	-	.008	.059	.031	.118
		RCGT 1003MOF-AL	T0315				■			●	+	-	.008	.079	.039	.157
			HF7				■			●	+	-	.008	.079	.039	.157





# RCMH

	d	d <sub>i</sub>	s
3209	1.260	.413	.375

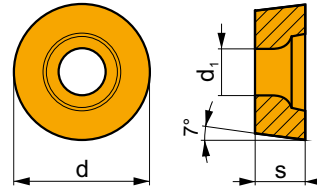


For tools see pages: T201-T202, T206-T207

i	ANSI	T9315	P	M	K	N	S	H	?	++	-	f <sub>min</sub>	f <sub>max</sub>	a <sub>p min</sub>	a <sub>p max</sub>
	RCMH 3209MO-RM2	T9315	■	■	■				●	++	-	.031	.051	.079	.315
	RCMH 3209MO-RR2	T9310	■	■	■				●	++	-	.031	.059	.098	.315















































































## RCMT

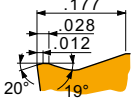
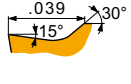
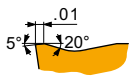
	d	d <sub>1</sub>	s
0602	.236	.110	.094
0803	.315	.134	.125
10T3	.394	.173	.156
1204	.472	.173	.187
1606	.630	.217	.250
2006	.787	.256	.250
2507	.984	.339	.313
3009	1.181	.394	.375



For tools see pages: T201-T202, T206-T207

	ANSI		P	M	K	N	S	H			r <sub>e</sub>	f <sub>min</sub>	f <sub>max</sub>	a <sub>p min</sub>	a <sub>p max</sub>					
   	RCMT 1606MOS-37	 T9315										++	-	.008	.035	.039	.157			
														+	-	.008	.035	.039	.157	
   	RCMT 2006MOS-371	 T9315										++	-	.008	.047	.039	.197			
														+	-	.008	.047	.039	.197	
   	RCMT 2507MOS-372	 T9325										+	-	.008	.047	.039	.236			
   	RCMT 0602MOE-FM	 T7325										+	-	.006	.024	.012	.094			
														+	-	.006	.024	.012	.094	
															+	-	.006	.024	.012	.094
															+	-	.004	.024	.012	.094
															+	-	.006	.024	.012	.094
   	RCMT 0803MOE-FM	 T7325										++	-	.006	.031	.020	.118			
														++	-	.006	.031	.020	.118	
															+	-	.006	.031	.020	.118
															+	-	.006	.031	.020	.118
   	RCMT 10T3MOE-FM	 T7325										++	-	.012	.039	.028	.157			
														++	-	.012	.039	.028	.157	
															+	-	.012	.039	.028	.157
   	RCMT 1204MOE-FM	 T7325										++	-	.012	.039	.028	.189			
														++	-	.012	.039	.028	.189	
															+	-	.012	.039	.028	.189
															+	-	.012	.039	.028	.189

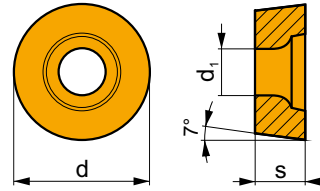
		ANSI		P	M	K	N	S	H			r <sub>e</sub>	f <sub>min</sub>	f <sub>max</sub>	a <sub>p min</sub>	a <sub>p max</sub>	
   	RCMT 0803MOE-RM3	T7325		█	█						+	-	.006	.024	.020	.118	
		T9315		█		█						+	-	.006	.024	.020	.118
	RCMT 1204MOE-RM3	T7325		█	█							++	-	.010	.028	.028	.177
		T9315		█		█						++	-	.010	.028	.028	.177
		T8330		█	█	█						+	-	.010	.028	.028	.177
	RCMT 1606MOE-RM3	H07*		█	█							+	-	.010	.028	.028	.177
		T7325		█	█							++	-	.010	.035	.039	.177
		T9315		█		█						++	-	.010	.035	.039	.177
	RCMT 2507MOE-RM3	T8330		█	█	█						+	-	.010	.035	.039	.177
		H07		█	█							+	-	.012	.035	.079	.236
T7325			█	█							+	-	.006	.016	.009	.059	
  	RCMT 0602MOE-UR	T9315		█		█					+	-	.006	.016	.009	.059	
		T9325		█	█	█						+	-	.006	.016	.009	.059
		T6310		█	█	█	□					+/-	-	.004	.016	.009	.059
		T8330		█	█	█	□					+	-	.004	.016	.009	.059
		T7325		█	█							+	-	.006	.020	.013	.118
	RCMT 0803MOE-UR	T9315		█		█						+	-	.006	.020	.013	.118
		T9325		█	█	█						+	-	.006	.020	.013	.118
		T6310		█	█	█	□					+	-	.005	.020	.013	.118
		T8330		█	█	█	□					+	-	.005	.020	.013	.118
	RCMT 10T3MOE-UR	T7325		█	█							+	-	.006	.024	.016	.157
T9315			█		█						+	-	.006	.024	.016	.157	
T9325			█	█	█						+	-	.006	.024	.016	.157	
T6310			█	█	█	□					+	-	.006	.024	.016	.157	
T8330			█	█	█	□					+	-	.006	.024	.016	.157	
RCMT 1204MOE-UR	T7325*		█	█							++	-	.007	.039	.019	.189	
	T9315		█		█						++	-	.007	.039	.019	.189	
	T9325		█	█	█						+	-	.007	.039	.019	.189	
	T6310		█	█	█	□					+	-	.007	.039	.019	.189	
	T8330		█	█	█	□					+	-	.007	.039	.019	.189	
RCMT 3009MO-RR4	T9310*		█		█						++	-	.031	.059	.157	.315	
	T9315*		█		█						++	-	.031	.059	.157	.315	
	T9316		█	□	█						++	-	.031	.059	.157	.315	



\* Non-stocked item

## RCMW

	d	d <sub>1</sub>	s
0602	.236	.110	.094
0803	.315	.134	.125
10T3	.394	.173	.156
1204	.472	.173	.187

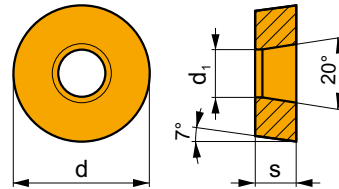


For tools see pages: T201-T202, T206-T207

		ANSI		P	M	K	N	S	H			r <sub>ε</sub>	f <sub>min</sub>	f <sub>max</sub>	a <sub>p min</sub>	a <sub>p max</sub>
		RCMW 0602MO	T5305	<input type="checkbox"/>	<input type="checkbox"/>	<input checked="" type="checkbox"/>	<input type="checkbox"/>	<input type="checkbox"/>	<input checked="" type="checkbox"/>		+/-	-	.004	.008	.020	.059
			T5315	<input checked="" type="checkbox"/>	<input type="checkbox"/>	<input checked="" type="checkbox"/>	<input type="checkbox"/>	<input type="checkbox"/>	<input type="checkbox"/>	<input type="checkbox"/>		+/-	-	.004	.008	.020
		RCMW 0803MO	T5305	<input type="checkbox"/>	<input type="checkbox"/>	<input checked="" type="checkbox"/>	<input type="checkbox"/>	<input type="checkbox"/>	<input checked="" type="checkbox"/>		+/-	-	.004	.012	.020	.079
			T5315	<input checked="" type="checkbox"/>	<input type="checkbox"/>	<input checked="" type="checkbox"/>	<input type="checkbox"/>	<input type="checkbox"/>	<input type="checkbox"/>	<input type="checkbox"/>		+/-	-	.004	.012	.020
		RCMW 10T3MO	T5305	<input type="checkbox"/>	<input type="checkbox"/>	<input checked="" type="checkbox"/>	<input type="checkbox"/>	<input type="checkbox"/>	<input checked="" type="checkbox"/>		+/-	-	.004	.014	.020	.098
			T5315	<input checked="" type="checkbox"/>	<input type="checkbox"/>	<input checked="" type="checkbox"/>	<input type="checkbox"/>	<input type="checkbox"/>	<input type="checkbox"/>	<input type="checkbox"/>		+/-	-	.004	.014	.020
		RCMW 1204MO	T5305	<input type="checkbox"/>	<input type="checkbox"/>	<input checked="" type="checkbox"/>	<input type="checkbox"/>	<input type="checkbox"/>	<input checked="" type="checkbox"/>		+/-	-	.004	.016	.020	.118
			T5315	<input checked="" type="checkbox"/>	<input type="checkbox"/>	<input checked="" type="checkbox"/>	<input type="checkbox"/>	<input type="checkbox"/>	<input type="checkbox"/>	<input type="checkbox"/>		+/-	-	.004	.016	.020

## RCMX

	d	d <sub>1</sub>	s
1003	.394	.142	.125
1204	.472	.165	.187
1606	.630	.205	.250
2006	.787	.256	.250
2507	.984	.283	.313
3209	1.260	.374	.375



For tools see pages: T201-T202, T206-T207

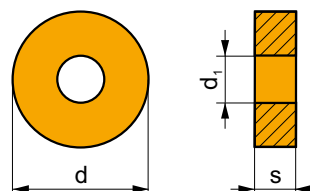
		ANSI		P	M	K	N	S	H			r <sub>ε</sub>	f <sub>min</sub>	f <sub>max</sub>	a <sub>p min</sub>	a <sub>p max</sub>
		RCMX 3209MO-RM2	T5315	<input checked="" type="checkbox"/>	<input type="checkbox"/>	<input checked="" type="checkbox"/>	<input type="checkbox"/>	<input type="checkbox"/>	<input type="checkbox"/>		++	-	.031	.051	.079	.315
		RCMX 3209MO-RM1	T9310	<input checked="" type="checkbox"/>	<input type="checkbox"/>	<input checked="" type="checkbox"/>	<input type="checkbox"/>	<input type="checkbox"/>	<input type="checkbox"/>	<input type="checkbox"/>		++	-	.031	.051	.079
		RCMX 3209MO-RM2	T9310	<input checked="" type="checkbox"/>	<input type="checkbox"/>	<input checked="" type="checkbox"/>	<input type="checkbox"/>	<input type="checkbox"/>	<input type="checkbox"/>		++	-	.031	.051	.079	.315
		RCMX 3209MO-RM2	T9315	<input checked="" type="checkbox"/>	<input type="checkbox"/>	<input checked="" type="checkbox"/>	<input type="checkbox"/>	<input type="checkbox"/>	<input type="checkbox"/>	<input type="checkbox"/>		++	-	.031	.051	.079
		RCMX 3209MO-RM1	T9316	<input checked="" type="checkbox"/>	<input type="checkbox"/>	<input checked="" type="checkbox"/>	<input type="checkbox"/>	<input type="checkbox"/>	<input type="checkbox"/>		++	-	.028	.059	.079	.315
		RCMX 3209MO-RM2	T9325	<input checked="" type="checkbox"/>	<input type="checkbox"/>	<input checked="" type="checkbox"/>	<input type="checkbox"/>	<input type="checkbox"/>	<input type="checkbox"/>	<input type="checkbox"/>		++	-	.031	.051	.079
		RCMX 3209MO-RM2	T9335	<input checked="" type="checkbox"/>	<input type="checkbox"/>	<input checked="" type="checkbox"/>	<input type="checkbox"/>	<input type="checkbox"/>	<input type="checkbox"/>		+++	-	.031	.059	.118	.315

i	ANSI		P	M	K	N	S	H			r <sub>c</sub>	f <sub>min</sub>	f <sub>max</sub>	a <sub>p min</sub>	a <sub>p max</sub>
	RCMX 1003MOS-31		T9325	■	▣	▣				++	-	.016	.039	.059	.098
			T9335	■	▣					++	-	.016	.039	.059	.098
	RCMX 1606MOS-37		T9315	■		▣				++	-	.008	.035	.039	.157
			T9325	■	□	▣				+	-	.008	.035	.039	.157
	RCMX 1204MOS-321		T9315	■		▣				++	-	.016	.039	.039	.118
			T9325	■	□	▣				++	-	.016	.039	.039	.118
			T9335	■	□					++	-	.016	.039	.039	.118
	RCMX 1606MOS-331		T9315	■		▣				++	-	.016	.047	.039	.157
			T9325	■	□	▣				++	-	.016	.047	.039	.157
			T9335	■	□					++	-	.016	.047	.039	.157
	RCMX 2006MO-RF1		T5305	□		■				+	-	.018	.047	.039	.197
			T9310	■		▣				++	-	.018	.047	.039	.197
			T9315	■		▣				++	-	.018	.047	.039	.197
			T9316	■	□	■				++	-	.018	.047	.039	.197
			T9325	■	□	▣				++	-	.018	.047	.039	.197
			T9335	■	□					-	-	-	-	-	-
	RCMX 2507MO-RF1		T9310	■		▣				++	-	.024	.047	.059	.276
			T9315	■		▣				++	-	.024	.047	.059	.276
			T9316	■	□	■				++	-	.024	.047	.059	.276
			T9325	■	□	▣				++	-	.024	.047	.059	.276
			T9335	■	□					+++	-	.031	.047	.118	.276
			T8345	▣	□	▣				++	-	.031	.047	.118	.276
	RCMX 2006MO-RM1		T9310	■		▣				++	-	.020	.051	.059	.197
			T9315	■		▣				++	-	.020	.051	.059	.197
			T9325	■	□	▣				++	-	.020	.051	.059	.197
			T9335	■	□					++	-	.008	.035	.059	.197
	RCMX 2507MO-RM1		T9310	■		▣				++	-	.028	.047	.079	.276
			T9315	■		▣				++	-	.028	.047	.079	.276
			T9316	■	□	■				++	-	.028	.047	.079	.276
			T9325	■	□	▣				++	-	.028	.047	.079	.276
			T9335	■	□					+++	-	.024	.035	.079	.276

i	ANSI	Image	P	M	K	N	S	H	?	Drop	r <sub>c</sub>	f <sub>min</sub>	f <sub>max</sub>	a <sub>p min</sub>	a <sub>p max</sub>	
  	RCMX 2507MO-RM2		T9310	■	▣				●	++	-	.031	.059	.079	.276	
			T9315	■	▣				●	++	-	.031	.059	.079	.276	
			T9316	■	□	■				●	++	-	.031	.059	.079	.276
			T9325	■	□	▣				✘	++	-	.031	.059	.079	.276
  	RCMX 3209MO-RR2		T9310	■	▣				●	++	-	.031	.059	.098	.315	
			T9315	■	▣				●	++	-	.031	.059	.098	.315	
			T9316	■	□	■				●	++	-	.031	.059	.098	.315

## RNMG

	d	d <sub>1</sub>	s
43	.500	.203	.187
54	.625	.250	.250
64	.750	.313	.250
86	1.000	.359	.375

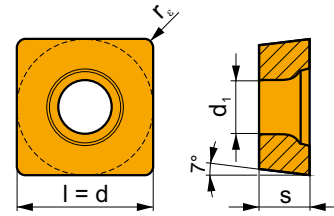


For tools see pages: T190

i	ANSI	Image	P	M	K	N	S	H	?	Drop	r <sub>c</sub>	f <sub>min</sub>	f <sub>max</sub>	a <sub>p min</sub>	a <sub>p max</sub>
  	RNMG 43-08		T5305	□	■			■	●	+	-	.012	.031	.039	.189
			T9315	▣	▣			▣	●	++	-	.012	.031	.039	.189
			T9325	▣	▣				●	+	-	.012	.031	.039	.189
	RNMG 54-08	T5305	□	■			■	●	+	-	.012	.031	.039	.236	
		T9315	▣	▣			▣	✘	++	-	.012	.031	.039	.236	
		T9325	▣	▣				✘	+	-	.012	.031	.039	.236	
RNMG 64-08	T9315	▣	▣			▣	●	++	-	.012	.031	.039	.236		
	T9325	▣	▣				●	+	-	.012	.031	.039	.236		
  	RNMG 86-081		T9315	■	▣				✘	++	-	.031	.047	.118	.276
			T9325	■	▣	▣				✘	++	-	.031	.047	.118

# SCGT

	d	d <sub>i</sub>	l	s
32.5	.375	.173	.375	.156
32.5-SF3	.375	.173	.375	.166
43	.500	.217	.500	.187

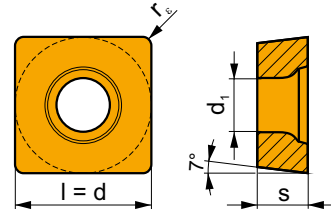


For tools see pages: T208

		ANSI		P	M	K	N	S	H			r <sub>e</sub>	f <sub>min</sub>	f <sub>max</sub>	a <sub>p min</sub>	a <sub>p max</sub>
		SCGT 432F-AL	T0315				■			●	+	.031	.006	.024	.031	.276
			HF7				■			●	+	.031	.006	.024	.031	.276
		SCGT 32.52-NF1	T7325	▣	■			■		●	+	.031	.005	.012	.020	.118
			T6310	▣	■	▣		■		●	+	.031	.005	.012	.020	.118
		SCGT 432-NF1	H07*		▣	▣		■		●	+	.031	.005	.012	.020	.118
			T7325	▣	■			■		●	++	.031	.006	.014	.020	.138
		SCGT 32.51-SF3	T6310		■		▣	■		●	+	.016	.002	.010	.016	.118
			T8315		■		▣	□		●	+/-	.016	.002	.010	.016	.118
		SCGT 32.52-SF3	H07		▣		▣	■		●	+	.016	.002	.010	.016	.118
			T6310		■		▣	■		●	+	.031	.004	.012	.024	.126
		SCGT 32.52-SF3	T8315		■		▣	□		●	+/-	.031	.004	.012	.024	.126

# SCMT

	d	d <sub>1</sub>	l	s
126	1.500	.343	1.500	.375
32.5	.375	.173	.375	.156
43	.500	.217	.500	.187
86	1.000	.343	.1000	.375



For tools see pages: T208

i	ANSI	Material	P	M	K	N	S	H	Chip	Coolant	r <sub>c</sub>	f <sub>min</sub>	f <sub>max</sub>	a <sub>p min</sub>	a <sub>p max</sub>
	SCMT 32.51-FF2	T9325	■	■	■				●	+	.016	.002	.009	.012	.118
	SCMT 32.52-FF2	T9325	■	■	■				●	+	.031	.003	.011	.024	.118
		T8330	■	■	■				●	+	.031	.003	.011	.024	.118
	SCMT 32.51-FM	T7325	■	■			□		●	+	.016	.006	.012	.012	.118
		T7335	■	■			□		●	++	.016	.006	.012	.012	.118
		T9315	■	■	■				●	+	.016	.006	.012	.012	.118
		T9325	■	■	■		□		●	+	.016	.006	.012	.012	.118
		T8315	■	■	■		□		●	+/-	.016	.004	.012	.012	.118
		T8330	■	■	■		□		●	+	.016	.004	.012	.012	.118
	SCMT 32.52-FM	T7325	■	■			□		●	++	.031	.006	.014	.020	.118
		T7335	■	■			□		●	++	.031	.006	.014	.020	.118
		T9315	■	■	■				●	+	.031	.006	.014	.020	.118
		T9325	■	■	■		□		●	+	.031	.006	.014	.020	.118
	SCMT 431-FM	T7325	■	■			□		●	+	.016	.006	.012	.016	.157
		T9315	■	■	■				●	+	.016	.006	.012	.016	.157
		T9325	■	■	■		□		●	+	.016	.006	.012	.016	.157
		T8315	■	■	■		□		●	+/-	.016	.004	.012	.016	.157
		T8330	■	■	■		□		●	+	.016	.004	.012	.016	.157
	SCMT 432-FM	T7325	■	■			□		●	++	.031	.006	.014	.020	.157
		T7335	■	■			□		●	++	.031	.006	.014	.020	.157
		T9315	■	■	■				●	+	.031	.006	.014	.020	.157
		T9325	■	■	■		□		●	+	.031	.006	.014	.020	.157
		T8315	■	■	■		□		●	+	.031	.006	.014	.020	.157
	SCMT 433-FM	T7325	■	■			□		●	++	.047	.006	.018	.031	.157
		T9315	■	■	■				●	++	.047	.006	.018	.031	.157
		T9325	■	■	■		□		●	+	.047	.006	.018	.031	.157
		T8330	■	■	■		□		●	+	.047	.006	.018	.031	.157
	SCMT 32.51-FM2	T7325	■	■			□		●	+	.016	.002	.010	.016	.118
	SCMT 32.52-FM2	T9315	■	■	■		□		●	+	.031	.004	.014	.031	.138
		T9325	■	■	■		□		●	+	.031	.004	.014	.031	.138
		T9335	■	■	■		□		●	++	.031	.004	.014	.031	.138
		T8330	■	■	■		□	□	●	+	.031	.004	.014	.031	.138



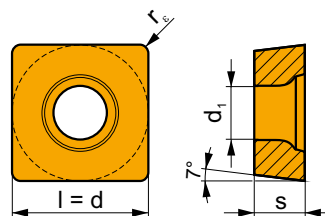
i	ANSI	ANSI Symbol	P	M	K	N	S	H	?	Water	r <sub>c</sub>	f <sub>min</sub>	f <sub>max</sub>	a <sub>p min</sub>	a <sub>p max</sub>						
		<b>SCMT 32.52-RF</b>	T5315	█	□	█				●	+	.031	.004	.016	.031	.157					
			T7335*	█	█						●	++	.031	.006	.016	.031	.157				
			<b>SCMT 432-RF</b>	T5315	█	□	█					●	+	.031	.008	.027	.039	.177			
				T7335	█	█						●	++	.031	.008	.027	.039	.177			
		<b>SCMT 32.52-RM</b>	T5315	█	□	█		□		●	+	.031	.008	.016	.059	.157					
			T7335	█	█						●	++	.031	.008	.016	.059	.157				
			T9315	█	█	█			□		●	++	.031	.008	.016	.059	.157				
			T9325	█	█	█		□			●	+	.031	.008	.016	.059	.157				
			T8330	█	█	█		█	□		●	+	.031	.008	.016	.059	.157				
			<b>SCMT 432-RM</b>	T5305	□	█				□		●	+	.031	.008	.016	.059	.177			
				T5315	█	□	█			□		●	+	.031	.008	.016	.059	.177			
				T7335	█	█						●	++	.031	.008	.016	.059	.177			
				T9315	█	█	█			□		●	++	.031	.008	.016	.059	.177			
				T9325	█	█	█		□			●	+	.031	.008	.016	.059	.177			
				T8330	█	█	█		█	□		●	+	.031	.008	.016	.059	.177			
					<b>SCMT 432-RM3</b>	T9315	█	█	█				●	++	.031	.010	.016	.031	.157		
T9325	█	█				█					●	+	.031	.010	.016	.031	.157				
T9335	█	█				█					●	++	.031	.010	.016	.031	.157				
T6310	█	█				█					●	+	.031	.010	.016	.031	.157				
T8330	█	█				█					●	+	.031	.010	.016	.031	.157				
<b>SCMT 433-RM3</b>	T7325*	█				█	█					●	++	.047	.010	.018	.047	.157			
	T9325	█				█	█					●	++	.047	.010	.018	.047	.157			
						<b>SCMT 32.51-UR</b>	T7325	█	█					●	+	.016	.006	.012	.016	.118	
							T9315	█	█	█					●	+	.016	.006	.012	.016	.118
							T9325	█	█	█					●	+	.016	.006	.012	.016	.118
T8330			█	█	█			□			●	+	.016	.003	.012	.016	.118				
<b>SCMT 32.52-UR</b>			T5315	█	□		█					●	+	.031	.004	.020	.031	.118			
			T7325	█	█							●	++	.031	.006	.020	.031	.118			
			T9315	█	█		█					●	++	.031	.006	.020	.031	.118			
			T9325	█	█		█					●	+	.031	.006	.020	.031	.118			
			T8330	█	█		█		□			●	+	.031	.003	.020	.031	.118			
<b>SCMT 432-UR</b>			TT310	█	█							●	+/-	.031	.003	.020	.031	.118			
	T5315	█	□	█					●	+	.031	.004	.020	.031	.157						
	T7325	█	█						●	++	.031	.006	.020	.031	.157						
	T9315	█	█	█					●	++	.031	.006	.020	.031	.157						
	T9325	█	█	█					●	+	.031	.006	.020	.031	.157						
<b>SCMT 433-UR</b>	T8330	█	█	█		□			●	+	.031	.003	.020	.031	.157						
	T9325	█	█	█					●	+	.047	.006	.020	.047	.157						
	T8330	█	█	█		□			●	+	.047	.003	.020	.047	.157						
		<b>SCMT 1268-DR4</b>	T9335	█	█					●	+++	.126	.028	.055	.157	.709					
					<b>SCMT 866-OR</b>	T9325	█	█	█		□		✘	++	.094	.024	.071	.118	.630		
T9335	█	█				█					✘	+++	.094	.024	.071	.118	.630				
T9226	█	█				█		□			✘	+++	.094	.024	.071	.118	.630				
<b>SCMT 1268-OR</b>	T9315	█				█	█					✘	+++	.126	.039	.079	.157	.945			
	T9325	█				█	█		□			✘	+++	.126	.039	.079	.157	.945			
	T9335	█				█	█					✘	+++	.126	.039	.079	.157	.945			

\* Non-stocked item

i	ANSI	Image	P	M	K	N	S	H	?	Drop	$r_\epsilon$	$f_{min}$	$f_{max}$	$a_{p min}$	$a_{p max}$
	SCMT 1268-OR	T9226	■	■	▣		□		✘	+++	.126	.039	.079	.157	.945
	SCMT 866-SR	T9325	■	■	▣				✘	++	.094	.024	.071	.118	.630
		T9335	■	▣					✘	+++	.094	.024	.071	.118	.630
	SCMT 1268-SR	T9335	■	▣					✘	+++	.126	.047	.079	.157	.945

## SCMW

Image	d	$d_1$	l	s	
	32.5	.375	.173	.375	.156
	43	.500	.217	.500	.187

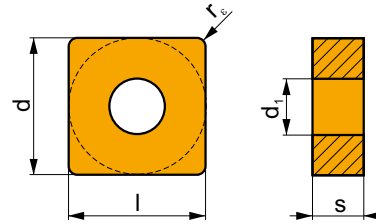


For tools see pages: T208

i	ANSI	Image	P	M	K	N	S	H	?	Drop	$r_\epsilon$	$f_{min}$	$f_{max}$	$a_{p min}$	$a_{p max}$
	SCMW 32.51		T5305	□	■			▣	●	+	.016	.004	.013	.016	.177
			T5315	▣	□	■			□	●	+	.016	.004	.013	.016
	SCMW 32.52		T5305	□	■			▣	●	+	.031	.004	.014	.031	.177
			T5315	▣	□	■			□	●	+	.031	.004	.014	.031
	SCMW 432		T5305	□	■			▣	●	+	.031	.004	.016	.031	.236
			T5315	▣	□	■			□	●	+	.031	.004	.016	.031

## SNMA

	d	d <sub>1</sub>	l	s
43	.500	.203	.500	.187
54	.625	.250	.625	.250
64	.750	.313	.750	.250
85	1.000	.359	.1000	.313
86	1.000	.359	.1000	.375

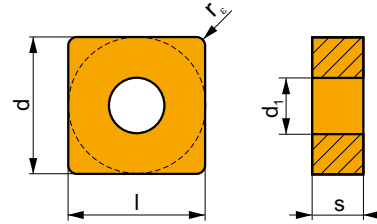


For tools see pages: T191-T193, T195

		ANSI		P	M	K	N	S	H			r <sub>e</sub>	f <sub>min</sub>	f <sub>max</sub>	a <sub>p min</sub>	a <sub>p max</sub>
		SNMA 432	T5305	<input type="checkbox"/>	<input type="checkbox"/>	<input checked="" type="checkbox"/>	<input type="checkbox"/>	<input type="checkbox"/>	<input checked="" type="checkbox"/>		+	.031	.004	.024	.031	.236
			T5315	<input checked="" type="checkbox"/>	<input type="checkbox"/>	<input checked="" type="checkbox"/>	<input type="checkbox"/>	<input type="checkbox"/>	<input type="checkbox"/>		+	.031	.004	.024	.031	.236
			T6310	<input checked="" type="checkbox"/>	<input type="checkbox"/>	<input checked="" type="checkbox"/>	<input type="checkbox"/>	<input type="checkbox"/>	<input type="checkbox"/>		+	.031	.002	.024	.031	.236
		SNMA 433	T5305	<input type="checkbox"/>	<input type="checkbox"/>	<input checked="" type="checkbox"/>	<input type="checkbox"/>	<input type="checkbox"/>	<input checked="" type="checkbox"/>		+	.047	.004	.024	.047	.236
			T5315	<input checked="" type="checkbox"/>	<input type="checkbox"/>	<input checked="" type="checkbox"/>	<input type="checkbox"/>	<input type="checkbox"/>	<input type="checkbox"/>		+	.047	.004	.024	.047	.236
		SNMA 543	T5305	<input type="checkbox"/>	<input type="checkbox"/>	<input checked="" type="checkbox"/>	<input type="checkbox"/>	<input type="checkbox"/>	<input checked="" type="checkbox"/>		+	.047	.004	.035	.047	.280
			T5315	<input checked="" type="checkbox"/>	<input type="checkbox"/>	<input checked="" type="checkbox"/>	<input type="checkbox"/>	<input type="checkbox"/>	<input type="checkbox"/>		++	.047	.004	.035	.047	.280
		SNMA 643	T5305	<input type="checkbox"/>	<input type="checkbox"/>	<input checked="" type="checkbox"/>	<input type="checkbox"/>	<input type="checkbox"/>	<input checked="" type="checkbox"/>		+	.047	.004	.035	.047	.350
			T5315	<input checked="" type="checkbox"/>	<input type="checkbox"/>	<input checked="" type="checkbox"/>	<input type="checkbox"/>	<input type="checkbox"/>	<input type="checkbox"/>		++	.047	.004	.035	.047	.350
		SNMA 644	T5305	<input type="checkbox"/>	<input type="checkbox"/>	<input checked="" type="checkbox"/>	<input type="checkbox"/>	<input type="checkbox"/>	<input checked="" type="checkbox"/>		+	.063	.004	.035	.063	.350
			T5315	<input checked="" type="checkbox"/>	<input type="checkbox"/>	<input checked="" type="checkbox"/>	<input type="checkbox"/>	<input type="checkbox"/>	<input type="checkbox"/>		++	.063	.004	.035	.063	.350
		SNMA 856	T5305	<input type="checkbox"/>	<input type="checkbox"/>	<input checked="" type="checkbox"/>	<input type="checkbox"/>	<input type="checkbox"/>	<input checked="" type="checkbox"/>		++	.094	.004	.043	.094	.472
			T5315	<input checked="" type="checkbox"/>	<input type="checkbox"/>	<input checked="" type="checkbox"/>	<input type="checkbox"/>	<input type="checkbox"/>	<input type="checkbox"/>		++	.094	.004	.043	.094	.472
		SNMA 866	T5305	<input type="checkbox"/>	<input type="checkbox"/>	<input checked="" type="checkbox"/>	<input type="checkbox"/>	<input type="checkbox"/>	<input checked="" type="checkbox"/>		++	.094	.004	.043	.094	.472
			T5315	<input checked="" type="checkbox"/>	<input type="checkbox"/>	<input checked="" type="checkbox"/>	<input type="checkbox"/>	<input type="checkbox"/>	<input type="checkbox"/>		++	.094	.004	.043	.094	.472
		SNMA 433S	T5305	<input type="checkbox"/>	<input type="checkbox"/>	<input checked="" type="checkbox"/>	<input type="checkbox"/>	<input type="checkbox"/>	<input checked="" type="checkbox"/>		+	.047	.004	.024	.047	.236
		SNMA 644S	T5305	<input type="checkbox"/>	<input type="checkbox"/>	<input checked="" type="checkbox"/>	<input type="checkbox"/>	<input type="checkbox"/>	<input checked="" type="checkbox"/>		+	.063	.004	.035	.047	.350
		SNMA 856S	T5305	<input type="checkbox"/>	<input type="checkbox"/>	<input checked="" type="checkbox"/>	<input type="checkbox"/>	<input type="checkbox"/>	<input checked="" type="checkbox"/>		++	.094	.004	.043	.094	.472
		SNMA 866S	T5305	<input type="checkbox"/>	<input type="checkbox"/>	<input checked="" type="checkbox"/>	<input type="checkbox"/>	<input type="checkbox"/>	<input checked="" type="checkbox"/>		++	.094	.004	.043	.094	.472

# SNMG

	d	d <sub>1</sub>	l	s
43	.500	.203	.500	.187
54	.625	.250	.625	.250
64	.750	.313	.750	.250
85	1.000	.359	.1000	.313
86	1.000	.359	.1000	.375



For tools see pages: T191-T193, T195

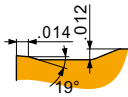
i	ANSI	Material	P	M	K	N	S	H	Chip	Coolant	r <sub>c</sub>	f <sub>min</sub>	f <sub>max</sub>	a <sub>p min</sub>	a <sub>p max</sub>
	SNMG 431-FM	T7325	█	█			□		●	+	.016	.006	.012	.020	.118
	T9315	█	█	█					●	+	.016	.006	.012	.020	.118
	T9325	█	█	█			□		●	+	.016	.006	.012	.020	.118
	T6310	█	█	█			□		●	+	.016	.004	.012	.020	.118
	T8315	█	█	█			□		●	+/-	.016	.004	.012	.020	.118
	T8430	█	█	█			█		●	+	.016	.004	.012	.020	.118
	SNMG 432-FM	T7325	█	█			□		●	++	.031	.006	.018	.031	.118
	T9310	█	█	█					●	+	.031	.006	.018	.031	.118
	T9315	█	█	█					●	++	.031	.006	.018	.031	.118
	T9325	█	█	█			□		●	+	.031	.006	.018	.031	.118
	T8315	█	█	█			□		●	+	.031	.006	.018	.031	.118
	T8430	█	█	█			█		●	+	.031	.006	.018	.031	.118
	SNMG 433-FM	T9315	█	█	█				●	++	.047	.006	.018	.047	.118
	T9325	█	█	█			□		●	+	.047	.006	.018	.047	.118
	T8430	█	█	█			█		●	+	.047	.006	.018	.047	.118
	SNMG 434-FM	T9315	█	█	█				●	++	.063	.006	.018	.063	.331
	T9325	█	█	█			□		●	+	.063	.006	.018	.063	.331
	T8430	█	█	█			█		●	+	.063	.006	.018	.063	.331
	SNMG 432-KR	T5305	□	█	█			□	●	+	.031	.008	.020	.031	.276
	T5315	█	□	█			□		●	+	.031	.008	.020	.031	.276
	SNMG 433-KR	T5305	□	█	█			□	●	+	.047	.010	.028	.047	.276
	T5315	█	□	█			□		●	++	.047	.010	.028	.047	.276
	SNMG 432-M	T5305	□	█	█			□	●	+	.031	.006	.024	.031	.236
	T5315	█	□	█			□		●	+	.031	.006	.024	.031	.236
	T9310	█	█	█					●	+	.031	.006	.024	.031	.236
	T9315	█	█	█			□		●	++	.031	.006	.024	.031	.236
	T9325	█	█	█					●	++	.031	.006	.024	.031	.236
	T9335	█	█	█					●	++	.031	.006	.024	.031	.236
	SNMG 433-M	T9315	█	█	█			□	●	++	.047	.007	.031	.047	.236
T9325	█	█	█					●	++	.047	.007	.031	.047	.236	
	SNMG 434-M	T9325	█	█	█				●	++	.063	.007	.031	.063	.236
	T9325	█	█	█					●	++	.063	.007	.031	.063	.236
	SNMG 543-M	T9315	█	█	█			□	●	++	.047	.007	.031	.047	.315
	T9325	█	█	█					●	++	.047	.007	.031	.047	.315
	T9335	█	█	█					●	+++	.047	.007	.031	.047	.315
	SNMG 643-M	T9315	█	█	█			□	●	++	.047	.007	.031	.047	.315

i	ANSI		Material Groups								r <sub>c</sub>	f <sub>min</sub>	f <sub>max</sub>	a <sub>p min</sub>	a <sub>p max</sub>	
			P	M	K	N	S	H								
   	SNMG 643-M	T9325	■	■	■				●	++	.047	.007	.031	.047	.315	
		T9335	■	■					●	+++	.047	.007	.031	.047	.315	
	SNMG 644-M	T9315	■	■	■			□	●	++	.063	.007	.031	.063	.315	
		T9325	■	■	■				●	++	.063	.007	.031	.063	.315	
		T9335	■	■					●	+++	.063	.007	.031	.063	.315	
	  	SNMG 431-NF	T7325	■	■			■	●	+	.016	.006	.012	.016	.118	
			T7335	■	■			■	●	++	.016	.006	.012	.016	.118	
			T9315	■	■					●	+	.016	.006	.012	.016	.118
			T9325	■	■			■		●	+	.016	.006	.012	.016	.118
			T6310	■	■		□	■		●	+	.016	.005	.012	.016	.118
SNMG 432-NF		T7325	■	■			■	●	++	.031	.006	.014	.031	.138		
		T7335	■	■			■	●	++	.031	.006	.014	.031	.138		
		T9315	■	■					●	+	.031	.006	.014	.031	.138	
		T9325	■	■			■		●	+	.031	.006	.014	.031	.138	
		T6310	■	■		□	■		●	+	.031	.006	.014	.031	.138	
		T8315	■	■		□	□		●	+	.031	.006	.014	.031	.138	
		T8430	■	■	■	■	■		●	+	.031	.006	.014	.031	.138	
		HF7	■	□		□	□		●	+	.031	.006	.014	.031	.138	
		   	SNMG 432-NM	T7325	■	■			■	●	++	.031	.008	.020	.031	.118
				T7335	■	■					●	++	.031	.008	.020	.031
T9325	■			■	□		□		●	+	.031	.008	.020	.031	.118	
T8315	■			■	□	□	□		●	+	.031	.008	.020	.031	.118	
T8430	■			■	■	■	■		●	+	.031	.008	.020	.031	.118	
SNMG 433-NM	T7325		■	■			■	●	++	.047	.008	.020	.047	.138		
	T7335		■	■					●	++	.047	.008	.020	.047	.138	
	T9325		■	■	□		□		●	+	.047	.008	.020	.047	.138	
	T8315		■	■	□	□	□		●	+	.047	.008	.020	.047	.138	
	  		SNMG 432-NMR	T6310	■	■			■	●	+	.031	.008	.022	.031	.197
T7325		■		■			■		●	++	.031	.008	.022	.031	.197	
T7335		■		■			■		●	++	.031	.008	.022	.031	.197	
T9315		■		■					●	++	.031	.008	.022	.031	.197	
T9325		■		■			■		●	+	.031	.008	.022	.031	.197	
SNMG 433-NMR		T6310	■	■			■		●	+	.047	.009	.024	.047	.217	
		T7325	■	■			■		●	++	.047	.009	.024	.047	.217	
		T7335	■	■			■		●	++	.047	.009	.024	.047	.217	
		T9315	■	■					●	++	.047	.009	.024	.047	.217	
		T9325	■	■			■		●	++	.047	.009	.024	.047	.217	
SNMG 434-NMR		T7325	■	■			■		✘	++	.063	.010	.026	.063	.236	
		T7335	■	■			■		✘	+++	.063	.010	.026	.063	.236	
		T9325*	■	■			■		●	++	.063	.010	.026	.063	.236	
		SNMG 543-NMR	T6310	■	■			■		✘	++	.047	.009	.026	.047	.236
			T7325	■	■			■		✘	++	.047	.009	.026	.047	.236
T9315	■		■					●	++	.047	.009	.026	.047	.236		
SNMG 643-NMR	T9325	■	■			■		●	++	.047	.009	.026	.047	.236		
	T6310	■	■			■		✘	++	.047	.009	.026	.047	.315		
	T7325	■	■			■		✘	++	.047	.009	.026	.047	.315		
	T7335	■	■			■		✘	++	.047	.009	.026	.047	.315		
	T9315	■	■					●	++	.047	.009	.026	.047	.315		
SNMG 644-NMR	T9325	■	■			■		●	++	.047	.009	.026	.047	.315		
	T6310	■	■			■		✘	++	.063	.010	.028	.063	.315		
	T7325	■	■			■		✘	++	.063	.010	.028	.063	.315		
	T7335	■	■			■		✘	++	.063	.010	.028	.063	.315		
	T9315*	■	■					●	++	.063	.010	.028	.063	.315		
T9325	■	■			■		●	++	.063	.010	.028	.063	.315			

i	ANSI		Material							r <sub>c</sub>	f <sub>min</sub>	f <sub>max</sub>	a <sub>p min</sub>	a <sub>p max</sub>		
			P	M	K	N	S								H	
              	SNMG 432-NRM	T7325	█	█				☐	☹	++	.031	.009	.022	.031	.276	
	T7335	█	█					☐	☹	++	.031	.009	.022	.031	.276	
	T9315	█								☹	++	.031	.009	.022	.031	.276
	SNMG 433-NRM	T7325	█	█					☐	☹	++	.047	.010	.028	.047	.276
	T7335	█	█						☐	☹	++	.047	.010	.028	.047	.276
	T9315	█								☹	++	.047	.010	.028	.047	.276
	SNMG 543-NRM	T7325	█	█					☐	☹	++	.047	.011	.028	.047	.315
	T7335	█	█						☐	☹	+++	.047	.011	.028	.047	.315
	T9315*	█								☹	++	.047	.011	.028	.047	.315
	SNMG 544-NRM	T7325	█	█					☐	☹	++	.063	.012	.031	.063	.315
	T7335	█	█						☐	☹	+++	.063	.012	.031	.063	.315
	T9315	█								☹	++	.063	.012	.031	.063	.315
	SNMG 643-NRM	T7325	█	█					☐	☹	++	.047	.013	.028	.047	.394
	T7335	█	█						☐	☹	+++	.047	.013	.028	.047	.394
	T9315	█								☹	++	.047	.013	.028	.047	.394
SNMG 644-NRM	T7325	█	█					☐	☹	++	.063	.013	.031	.063	.394	
T7335	█	█						☐	☹	+++	.063	.013	.031	.063	.394	
T9315*	█								☹	++	.063	.013	.031	.063	.394	
SNMG 856-NRM	T7325	█	█					☐	☹	++	.094	.014	.039	.079	.551	
T7335	█	█						☐	☹	+++	.094	.014	.039	.079	.551	
T9315	█								☹	++	.094	.014	.039	.079	.551	
SNMG 866-NRM	T7325	█	█					☐	☹	++	.094	.014	.039	.079	.591	
T7335	█	█						☐	☹	+++	.094	.014	.039	.079	.591	
T9315	█								☹	++	.094	.014	.039	.079	.591	
SNMG 432-R	T5305	☐		█				☐	☹	+	.031	.010	.024	.079	.236	
T9315	█		█					☐	☹	++	.031	.010	.024	.079	.236	
T9325	█	█	█						☹	++	.031	.010	.024	.079	.236	
T9335	█	█							☹	++	.031	.010	.024	.079	.236	
SNMG 433-R	T5305	☐		█				☐	☹	+	.047	.010	.028	.079	.236	
T9310*	█		█					☐	☹	++	.047	.010	.028	.079	.236	
T9325	█	█	█						☹	++	.047	.010	.028	.079	.236	
T9335	█	█							☹	++	.047	.010	.028	.079	.236	
SNMG 434-R	T9315	█		█				☐	☹	++	.063	.012	.031	.079	.236	
T9325	█	█	█						☹	++	.063	.012	.031	.079	.236	
SNMG 543-R	T5305	☐		█				☐	☹	+	.047	.010	.028	.079	.276	
T5315	█	☐	█					☐	☹	++	.047	.010	.028	.079	.276	
T9315	█		█					☐	☹	++	.047	.010	.028	.079	.276	
T9325	█	█	█						☹	++	.047	.010	.028	.079	.276	
SNMG 544-R	T5315	█	☐	█				☐	☹	++	.063	.010	.028	.079	.276	
T9325	█	█	█						☹	++	.063	.010	.028	.079	.276	
SNMG 643-R	T9310	█		█				☐	☹	++	.047	.010	.028	.079	.354	
T9315	█		█					☐	☹	++	.047	.010	.028	.079	.354	
T9325	█	█	█						☹	++	.047	.010	.028	.079	.354	
SNMG 644-R	T9310	█		█				☐	☹	++	.063	.012	.031	.079	.354	
T9315	█		█					☐	☹	++	.063	.012	.031	.079	.354	
T9325	█	█	█						☹	++	.063	.012	.031	.079	.354	
T9335	█	█							☹	+++	.063	.012	.031	.079	.354	

\* Non-stocked item

i	ANSI		Material								r <sub>c</sub>	f <sub>min</sub>	f <sub>max</sub>	a <sub>p min</sub>	a <sub>p max</sub>		
			P	M	K	N	S	H									
	SNMG 432-RM	T5305	☐	■	■			☐	⊗	+	.031	.008	.020	.039	.276		
		T5315	▣	☐	■			☐	⊗	+	.031	.008	.020	.039	.276		
		T7325	▣	■			▣		⊗	++	.031	.008	.020	.039	.276		
		T7335	▣	■			▣		⊗	++	.031	.008	.020	.039	.276		
		T9310*	■	■	▣				⊗	+	.031	.008	.020	.039	.276		
		T9315	■	■	▣			☐	⊗	++	.031	.008	.020	.039	.276		
		T9325	■	■	▣		☐		⊗	+	.031	.008	.020	.039	.276		
		T9335	■	▣					⊗	++	.031	.008	.020	.039	.276		
		T6310	▣	■	▣		▣	☐	⊗	+	.031	.008	.020	.039	.276		
		T8315	▣	■	■		☐	☐	⊗	+	.031	.008	.020	.039	.276		
		T8430	■	▣	▣				⊗	+	.031	.008	.020	.039	.276		
			SNMG 433-RM	T5305	☐	■	■			☐	⊗	+	.047	.010	.028	.059	.276
				T5315	▣	☐	■			☐	⊗	++	.047	.010	.028	.059	.276
				T7325	▣	■			▣		⊗	++	.047	.010	.028	.059	.276
T7335	▣			■			▣		⊗	++	.047	.010	.028	.059	.276		
T9310	■			■	▣				⊗	++	.047	.010	.028	.059	.276		
T9315	■			■	▣			☐	⊗	++	.047	.010	.028	.059	.276		
T9325	■			■	▣		☐		⊗	++	.047	.010	.028	.059	.276		
T9335	■			▣					⊗	++	.047	.010	.028	.059	.276		
T6310	▣			■	▣		▣	☐	⊗	++	.047	.010	.028	.059	.276		
	SNMG 434-RM			T5305	☐	■	■			☐	⊗	+	.063	.012	.030	.079	.276
				T5315	▣	☐	■			☐	⊗	++	.063	.012	.030	.079	.276
				T7335	▣	■			▣		⊗	+++	.063	.012	.030	.079	.276
				T9310	■	■	▣				⊗	++	.063	.012	.030	.079	.276
				T9315	■	■	▣			☐	⊗	++	.063	.012	.030	.079	.276
		T9325	■	■	▣		☐		⊗	++	.063	.012	.030	.079	.276		
		T9335	■	▣					⊗	+++	.063	.012	.030	.079	.276		
		T8430	■	▣	▣				⊗	++	.063	.012	.030	.079	.276		
			SNMG 543-RM	T5305	☐	■	■			☐	⊗	+	.047	.010	.028	.059	.315
				T5315	▣	☐	■			☐	⊗	++	.047	.010	.028	.059	.315
				T7325	▣	■			▣		⊗	++	.047	.010	.028	.059	.315
				T7335	▣	■			▣		⊗	++	.047	.010	.028	.059	.315
				T9310	■	■	▣				⊗	++	.047	.010	.028	.059	.315
				T9315	■	■	▣			☐	⊗	++	.047	.010	.028	.059	.315
T9325	■			■	▣		☐		⊗	++	.047	.010	.028	.059	.315		
T9335	■			▣					⊗	++	.047	.010	.028	.059	.315		
T6310	▣			■	▣		▣	☐	⊗	++	.047	.010	.028	.059	.315		
	SNMG 544-RM			T5305	☐	■	■			☐	⊗	++	.063	.012	.031	.079	.315
				T5315	▣	☐	■			☐	⊗	++	.063	.012	.031	.079	.315
				T7335	▣	■			▣		⊗	+++	.063	.012	.031	.079	.315
				T9315	■	■	▣			☐	⊗	++	.063	.012	.031	.079	.315
				T9325	■	■	▣		☐		⊗	++	.063	.012	.031	.079	.315
		T9335	■	▣					⊗	+++	.063	.012	.031	.079	.315		
			SNMG 643-RM	T5305	☐	■	■			☐	⊗	+	.047	.010	.028	.059	.394
				T5315	▣	☐	■			☐	⊗	++	.047	.010	.028	.059	.394
				T7325	▣	■			▣		⊗	++	.047	.010	.028	.059	.394
				T7335	▣	■			▣		⊗	++	.047	.010	.028	.059	.394
				T9310	■	■	▣				⊗	++	.047	.010	.028	.059	.394
				T9315	■	■	▣			☐	⊗	++	.047	.010	.028	.059	.394
				T9325	■	■	▣		☐		⊗	++	.047	.010	.028	.059	.394
				T9335	■	▣					⊗	++	.047	.010	.028	.059	.394
	SNMG 644-RM			T5305	☐	■	■			☐	⊗	++	.063	.012	.031	.079	.394
				T5315	▣	☐	■			☐	⊗	++	.063	.012	.031	.079	.394
				T7335	▣	■			▣		⊗	+++	.063	.012	.031	.079	.394
				T9310	■	■	▣				⊗	++	.063	.012	.031	.079	.394
				T9315	■	■	▣			☐	⊗	++	.063	.012	.031	.079	.394



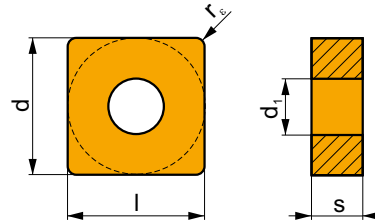
\* Non-stocked item

i	ANSI		Material								r <sub>c</sub>	f <sub>min</sub>	f <sub>max</sub>	a <sub>p min</sub>	a <sub>p max</sub>
			P	M	K	N	S	H							
          	SNMG 644-RM	T9325	■	■	▣		□		⊗	++	.063	.012	.031	.079	.394
		T9335	■	▣					⊗	+++	.063	.012	.031	.079	.394
		T6310	▣	■	▣		▣	□	⊗	++	.063	.012	.031	.079	.394
	SNMG 866-RM	T7325	▣	■			▣		⊗	+++	.094	.016	.047	.094	.591
		T7335	▣	■			▣		⊗	+++	.094	.016	.047	.094	.591
		T9315	■	■	▣			□	⊗	+++	.094	.016	.047	.094	.591
		T9325	■	■	▣			□	⊗	++	.094	.016	.047	.094	.591
		T9335	■	▣					⊗	+++	.094	.016	.047	.094	.591
		T9226	■	■	▣			□	⊗	+++	.094	.016	.047	.094	.591
	SNMG 431-SF	T7325	▣	■			■		⊗	+	.016	.006	.012	.016	.118
		T9325	▣	■			▣		⊗	+	.016	.006	.012	.016	.118
	SNMG 432-SF	T7325	▣	■			■		⊗	+	.031	.006	.012	.031	.118
T7335		▣	■			■		⊗	++	.031	.006	.012	.031	.118	
T9325		▣	■			▣		⊗	+	.031	.006	.012	.031	.118	
T6310		▣	■		□	■	□	⊗	+	.031	.005	.012	.031	.118	
T8315		▣	■		□	□	□	⊗	+/-	.031	.005	.012	.031	.118	
T8430		■	■	▣	▣	▣	▣	⊗	+	.031	.005	.012	.031	.118	
H07		■	▣		□	■		⊗	+	.031	.005	.012	.031	.118	
SNMG 433-SF	T7325	▣	■			■		⊗	++	.047	.006	.014	.047	.138	
	T6310	▣	■		□	■	□	⊗	+	.047	.006	.014	.047	.138	
	T8430	■	■	▣	▣	▣	▣	⊗	+	.047	.006	.014	.047	.138	
SNMG 432-SM	T7325	▣	■			■		⊗	++	.031	.008	.018	.031	.177	
	T7335	▣	■			■		⊗	++	.031	.008	.018	.031	.177	
	T9315	■	■	▣			□	⊗	++	.031	.008	.018	.031	.177	
	T9325	■	■	▣		▣		⊗	+	.031	.008	.018	.031	.177	
	T6310	▣	■	▣		■	□	⊗	+	.031	.008	.018	.031	.177	
	T8430	■	■	▣	▣	▣	▣	⊗	+	.031	.008	.018	.031	.177	
SNMG 433-SM	T7325	▣	■			■		⊗	++	.047	.009	.020	.047	.197	
	T7335	▣	■			■		⊗	++	.047	.009	.020	.047	.197	
	T9315	■	■	▣			□	⊗	++	.047	.009	.020	.047	.197	
	T9325	■	■	▣		▣		⊗	+	.047	.009	.020	.047	.197	
	T6310	▣	■	▣		■	□	⊗	+	.047	.009	.020	.047	.197	
SNMG 643-SM	T7325	▣	■			■		⊗	++	.047	.010	.022	.047	.217	
	T7335	▣	■			■		⊗	++	.047	.010	.022	.047	.217	
	T9325	■	■	▣		▣		⊗	++	.047	.010	.022	.047	.217	
	T6310	▣	■	▣		■	□	⊗	+	.047	.010	.022	.047	.217	
SNMG 644-SM	T7325	▣	■			■		⊗	++	.063	.012	.022	.063	.236	
	T7335	▣	■			■		⊗	++	.063	.012	.022	.063	.236	
	T9325	■	■	▣		▣		⊗	++	.063	.012	.022	.063	.236	



# SNMM

	d	d <sub>1</sub>	l	s
43	.500	.203	.500	.187
54	.625	.250	.625	.250
64	.750	.313	.750	.250
85	1.000	.359	.1000	.313
86	1.000	.359	.1000	.375



For tools see pages: T191-T193, T195

		ANSI		P	M	K	N	S	H			r <sub>s</sub>	f <sub>min</sub>	f <sub>max</sub>	a <sub>p min</sub>	a <sub>p max</sub>		
		SNMM 433-DR		T9315*	■	■	■				●	++	.047	.012	.033	.098	.331	
				T9325	■	■	■		□			●	++	.047	.012	.033	.098	.331
				T9335	■	■	■					●	+++	.047	.012	.033	.098	.331
		SNMM 543-DR		T9335	■	■	■				●	+++	.047	.012	.033	.098	.354	
				T9335	■	■	■				●	+++	.047	.012	.033	.098	.354	
		SNMM 643-DR		T9325	■	■	■		□		●	++	.047	.012	.033	.098	.354	
				T9335	■	■	■				●	+++	.047	.012	.033	.098	.354	
		SNMM 644-DR		T9325	■	■	■		□		●	++	.063	.012	.033	.098	.354	
				T9335	■	■	■				●	+++	.063	.012	.033	.098	.354	
		SNMM 644-HR		T9325	■	■	■		□		●	++	.063	.020	.054	.197	.524	
				T9335	■	■	■				●	+++	.063	.020	.054	.197	.524	
				T8345	■	■	■		□		●	++	.063	.020	.054	.197	.524	
		SNMM 646-HR		T9315	■	■	■				●	+++	.094	.020	.055	.197	.524	
				T9325	■	■	■		□		●	++	.094	.020	.055	.197	.524	
				T9335	■	■	■				●	+++	.094	.020	.055	.197	.524	
				T8345	■	■	■		□		●	++	.094	.020	.055	.197	.524	
		SNMM 854-HR		T9325	■	■	■		□		●	++	.063	.020	.054	.197	.551	
				T9335	■	■	■				●	+++	.063	.020	.054	.197	.551	
				T8345	■	■	■		□		●	++	.063	.020	.054	.197	.551	
		SNMM 856-HR		T9315	■	■	■				●	+++	.094	.020	.055	.197	.551	
				T9325	■	■	■		□		●	++	.094	.020	.055	.197	.551	
				T9335	■	■	■				●	+++	.094	.020	.055	.197	.551	
				T8345	■	■	■		□		●	++	.094	.020	.055	.197	.551	
		SNMM 858-HR		T9325	■	■	■		□		●	++	.126	.024	.055	.197	.551	
				T9325	■	■	■		□		●	+++	.094	.020	.055	.197	.551	
		SNMM 866-HR		T9315	■	■	■				●	+++	.094	.020	.055	.197	.551	
				T9325	■	■	■		□		●	++	.094	.020	.055	.197	.551	
				T9335	■	■	■				●	+++	.094	.020	.055	.197	.551	
				T8345	■	■	■		□		●	++	.094	.020	.055	.197	.551	
		SNMM 868-HR		T9325	■	■	■		□		●	++	.126	.024	.055	.197	.551	

\* Non-stocked item

i	ANSI		Material								r <sub>c</sub>	f <sub>min</sub>	f <sub>max</sub>	a <sub>p min</sub>	a <sub>p max</sub>
			P	M	K	N	S	H							
	SNMM 644-HR2	T9335	■	▣			□	✘	+++	.063	.020	.051	.118	.512	
	SNMM 646-HR2	T9315	■		▣			☉	+++	.094	.020	.051	.118	.512	
		T9335	■	▣			□	✘	+++	.094	.020	.051	.118	.512	
		SNMM 856-HR2	T9335	■	▣			□	✘	+++	.094	.028	.055	.118	.630
			T9226	■	▣	▣		□	✘	+++	.094	.028	.055	.118	.630
		SNMM 866-HR2	T9315	■		▣			☉	+++	.094	.028	.055	.118	.630
			T9335	■	▣			□	✘	+++	.094	.028	.055	.118	.630
			T9226	■	▣	▣		□	✘	+++	.094	.028	.055	.118	.630
		SNMM 868-HR2	T9315	■		▣			☉	+++	.126	.028	.055	.126	.630
		SNMM 432-NR	T7325	▣	■			■	☉	++	.031	.010	.027	.039	.331
			T7335	▣	■			■	☉	+++	.031	.010	.027	.039	.331
			T9325	■	■	□		□	☉	++	.031	.010	.027	.039	.331
		T8430	■	■	▣		▣	✘	++	.031	.010	.027	.039	.331	
	SNMM 432-NR2	T7325	▣	■			■	☉	++	.031	.012	.022	.031	.276	
		T7335	▣	■			■	☉	++	.031	.012	.022	.031	.276	
			T9325	■	■	□		□	☉	++	.031	.012	.022	.031	.276
			T8430	■	■	▣		▣	✘	+	.031	.012	.022	.031	.276
		SNMM 433-NR2	T7335	▣	■			■	✘	+++	.047	.013	.028	.047	.295
			T9325	■	■	□		□	☉	++	.047	.013	.028	.047	.295
			T8430	■	■	▣		▣	✘	++	.047	.013	.028	.047	.295
		SNMM 543-NR2	T7325	▣	■			■	✘	++	.047	.012	.028	.047	.354
			T7335	▣	■			■	✘	++	.047	.012	.028	.047	.354
			T9325	■	■	□		□	☉	++	.047	.012	.028	.047	.354
			T8430	■	■	▣		▣	✘	++	.047	.012	.028	.047	.354
		SNMM 544-NR2	T7335	▣	■			■	✘	+++	.063	.014	.035	.063	.354
		T9325	■	■	□		□	✘	++	.063	.014	.035	.063	.354	
	SNMM 643-NR2	T7325	▣	■			■	✘	++	.047	.013	.028	.059	.472	
		T7335	▣	■			■	✘	+++	.047	.013	.028	.059	.472	
			T9325	■	■	□		□	✘	++	.047	.013	.028	.059	.472
		SNMM 644-NR2	T7325	▣	■			■	✘	++	.063	.014	.035	.063	.472
			T7335	▣	■			■	✘	+++	.063	.014	.035	.063	.472
			T9315	■		□			☉	++	.063	.014	.035	.063	.472
			T9325	■	■	□		□	✘	++	.063	.014	.035	.063	.472
			T8430	■	■	▣		▣	✘	++	.063	.014	.035	.063	.472
		SNMM 646-NR2	T7325	▣	■			■	✘	+++	.094	.016	.047	.098	.472
			T7335	▣	■			■	✘	+++	.094	.016	.047	.098	.472
			T9325	■	■	□		□	✘	++	.094	.016	.047	.098	.472
		SNMM 856-NR2	T7335	▣	■			■	✘	+++	.094	.020	.055	.118	.630
		T9315	■		□			✘	+++	.094	.020	.055	.118	.630	
		T9325	■	■	□		□	✘	++	.094	.020	.055	.118	.630	
		T9226	■	■	□		□	✘	+++	.094	.020	.055	.118	.630	
		T8430	■	■	▣		▣	✘	++	.094	.020	.055	.118	.630	

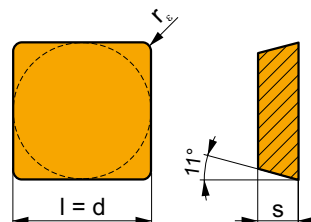
i	ANSI		P	M	K	N	S	H			r <sub>e</sub>	f <sub>min</sub>	f <sub>max</sub>	a <sub>p min</sub>	a <sub>p max</sub>	
 	SNMM 866-NR2	T7325	█	█					✘	+++	.094	.020	.063	.118	.630	
		T7335	█	█					✘	+++	.094	.020	.063	.118	.630	
		T9315	█		□					✘	+++	.094	.020	.063	.118	.630
		T9325	█	█	□		□			✘	++	.094	.020	.063	.118	.630
		T9226	█	█	□		□			✘	+++	.094	.020	.063	.118	.630
 	SNMM 854-NRM	T7325	█	█			□		✘	++	.063	.013	.035	.063	.551	
		T7335*	█	█			□		✘	+++	.063	.013	.035	.063	.551	
		T9315*	█						☉	++	.063	.013	.035	.063	.551	
	SNMM 856-NRM	T7325	█	█			□		✘	++	.094	.014	.039	.079	.551	
		T7335	█	█			□		✘	+++	.094	.014	.039	.079	.551	
T9315		█						☉	++	.094	.014	.039	.079	.551		
SNMM 866-NRM	T7325	█	█			□		✘	++	.094	.014	.039	.079	.630		
	T7335	█	█			□		✘	+++	.094	.014	.039	.079	.630		
	T9315	█						☉	++	.094	.014	.039	.079	.630		
SNMM 432-OR	T9315	█		█					☉	++	.031	.012	.027	.059	.236	
	T9325	█	█	█		□			☉	++	.031	.012	.027	.059	.236	
	T9335	█	█						☉	+++	.031	.012	.027	.059	.236	
SNMM 433-OR	T9315	█		█					☉	++	.047	.013	.028	.079	.236	
	T9325	█	█	█		□		✘	++	.047	.013	.028	.079	.236		
SNMM 434-OR	T9325	█	█	█		□		✘	++	.063	.014	.031	.079	.315		
SNMM 542-OR	T9315	█		█					☉	++	.031	.014	.024	.079	.315	
	T9325	█	█	█		□			☉	++	.031	.014	.024	.079	.315	
	T9335	█	█						☉	+++	.031	.014	.024	.079	.315	
SNMM 543-OR	T9325	█	█	█		□		✘	++	.047	.014	.039	.079	.354		
	T9335	█	█						✘	+++	.047	.014	.039	.079	.354	
SNMM 544-OR	T9315	█		█					✘	+++	.063	.016	.039	.079	.394	
	T9325	█	█	█		□		✘	++	.063	.016	.039	.079	.394		
SNMM 643-OR	T9315	█		█					☉	++	.047	.014	.039	.118	.394	
	T9325	█	█	█		□		✘	++	.047	.014	.039	.118	.394		
	T9335	█	█						✘	+++	.047	.014	.039	.118	.394	
 	SNMM 644-OR	T8430	█	█	█		█		✘	++	.047	.014	.039	.118	.394	
		T9315	█		█					✘	+++	.063	.015	.047	.079	.394
		T9325	█	█	█		□			✘	++	.063	.015	.047	.079	.394
		T9335	█	█						✘	+++	.063	.015	.047	.079	.394
		T8430	█	█	█		█			✘	++	.063	.015	.047	.079	.394
SNMM 646-OR	T8345	█	█	█		□			✘	++	.063	.015	.047	.079	.394	
	T9315	█		█					✘	+++	.094	.018	.047	.138	.472	
SNMM 854-OR	T9325	█	█	█		□		✘	++	.063	.018	.054	.157	.630		
	T9335	█	█						✘	+++	.063	.018	.054	.157	.630	
	T9226	█	█	█		□		✘	+++	.063	.018	.054	.157	.630		
SNMM 856-OR	T9315	█		█					✘	+++	.094	.018	.067	.157	.630	
	T9325	█	█	█		□		✘	++	.094	.018	.067	.157	.630		
	T9335	█	█						✘	+++	.094	.018	.067	.157	.630	
	T8430	█	█	█		█			✘	++	.094	.018	.067	.157	.630	
	T8345	█	█	█		□			✘	++	.094	.018	.067	.157	.630	
SNMM 866-OR	T9315	█		█					✘	+++	.094	.018	.067	.157	.630	
	T9325	█	█	█		□		✘	++	.094	.018	.067	.157	.630		
	T9335	█	█						✘	+++	.094	.018	.067	.157	.630	
	T9226	█	█	█		□		✘	+++	.094	.018	.067	.157	.630		
		T8430	█	█	█		█		✘	++	.094	.018	.067	.157	.630	

\* Non-stocked item

i	ANSI	Image	P	M	K	N	S	H	?	Drop	$r_c$	$f_{min}$	$f_{max}$	$a_{p min}$	$a_{p max}$
	SNMM 644-OR1	T9325	■	■	▣		□		✘	++	.063	.012	.039	.118	.433
		T9335	■	▣					✘	+++	.063	.012	.039	.118	.433
	SNMM 856-SR	T9325	■	■	▣				✘	++	.094	.028	.063	.197	.630
		T9335	■	▣					✘	+++	.094	.028	.063	.197	.630
	SNMM 866-SR	T9335	■	▣					✘	+++	.094	.028	.063	.197	.630
	SNMM 644-923	T9335	■	▣					✘	+++	.063	.018	.054	.118	.512
		T8430	■	■	▣		▣		✘	++	.063	.018	.054	.118	.512
		T8345	▣	▣	▣				✘	++	.063	.018	.054	.118	.512
	SNMM 854-923	T9335	■	▣					✘	+++	.063	.018	.054	.118	.512
	SNMM 856-923	T9335	■	▣					✘	+++	.094	.018	.059	.118	.512
		T8430	■	■	▣		▣		✘	++	.094	.018	.059	.118	.512
	SNMM 866-923	T9315	■		▣				✘	+++	.094	.018	.059	.118	.630
		T9226	■	▣	▣				✘	+++	.094	.018	.059	.118	.630
		T9335	■	▣					✘	+++	.094	.018	.059	.118	.630
		T8430	■	■	▣		▣		✘	++	.094	.018	.059	.118	.630
		T8345	▣	▣	▣				✘	++	.094	.018	.059	.118	.630
		SNMM 868-923	T9226	■	▣	▣				✘	+++	.126	.018	.059	.126

## SPMR

Image	d	l	s
	.375	.375	.125
	.500	.500	.125



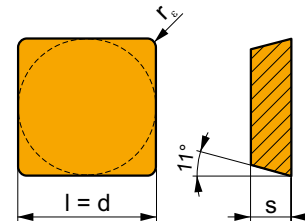
i	ANSI	Image	P	M	K	N	S	H	?	Drop	$r_c$	$f_{min}$	$f_{max}$	$a_{p min}$	$a_{p max}$
	SPMR 321-46	T9325	■	■	▣				●	+	.016	.006	.013	.039	.118
	SPMR 322-46	T9325	■	■	▣				●	+	.031	.006	.016	.039	.118

i		ANSI		P	M	K	N	S	H			$r_e$	$f_{min}$	$f_{max}$	$a_{p\ min}$	$a_{p\ max}$	
  		SPMR 421-48	T9325	■	■	▣				●	+	.016	.008	.013	.039	.315	
		T9335	■	▣						●	++	.016	.008	.013	.039	.315	
		6630	■	■	▣					●	++	.016	.008	.013	.039	.315	
		SPMR 422-48	T9325	■	■	▣					●	++	.031	.008	.027	.039	.315
		T9335	■	▣						●	++	.031	.008	.027	.039	.315	
		6630	■	■	▣					●	++	.031	.008	.027	.039	.315	
		SPMR 423-48	T9325	■	■	▣					●	++	.047	.008	.028	.047	.315
		T9335	■	▣						●	++	.047	.008	.028	.047	.315	



## SPU

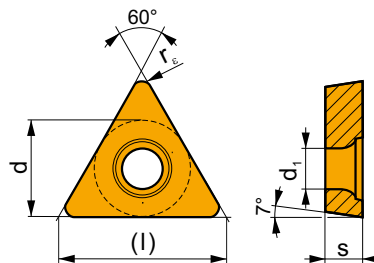
	d	l	m	s
42	.500	.500	.084	.125
53	.625	.625	.110	.187
63	.750	.750	.136	.187



i		ANSI		P	M	K	N	S	H			$r_e$	$f_{min}$	$f_{max}$	$a_{p\ min}$	$a_{p\ max}$
   		SPU 422	6640	▣	□	▣				●	++	.031	.004	.012	.031	.236
		SPU 423	6640	▣	□	▣				●	++	.047	.004	.012	.047	.236
		SPU 532	6640	▣	□	▣				●	++	.031	.004	.016	.031	.280
		SPU 533	6640	▣	□	▣				●	++	.047	.004	.016	.047	.280
		SPU 632	6640	▣	□	▣				●	++	.031	.004	.016	.063	.350
		SPU 633	6640	▣	□	▣				●	++	.047	.004	.016	.047	.350
		SPU 634	6640	▣	□	▣				●	++	.063	.004	.016	.063	.350
		SPU 422	6640	▣	□	▣				●	++	.031	.004	.012	.031	.236
	SPU 423	6640	▣	□	▣				●	++	.047	.004	.012	.047	.236	
		SPU 532	6640	▣	□	▣				●	++	.031	.004	.016	.031	.280
		SPU 533	6640	▣	□	▣				●	++	.047	.004	.016	.047	.280
		SPU 632	6640	▣	□	▣				●	++	.031	.004	.016	.063	.350
		SPU 633	6640	▣	□	▣				●	++	.047	.004	.016	.047	.350
		SPU 634	6640	▣	□	▣				●	++	.063	.004	.016	.063	.350

# TCGT

	d	d <sub>1</sub>	l	s
1.21.2	.156	.087	.272	.078
1.81.5	.219	.098	.378	.094
21.5	.250	.110	.433	.094
21.5-SF3	.250	.110	.433	.102
32.5	.375	.173	.650	.156
32.5-SF3	.375	.173	.650	.166



For tools see pages: T224

i	ANSI	Material	P	M	K	N	S	H	?	Drop	r <sub>c</sub>	f <sub>min</sub>	f <sub>max</sub>	a <sub>p min</sub>	a <sub>p max</sub>
	TCGT 1.81.50.5F-AL	T0315				■			●	+	.008	.002	.005	.012	.117
	TCGT 1.81.51F-AL	T0315				■			●	+	.016	.004	.009	.016	.117
	TCGT 21.50.5F-AL	T0315				■			●	+	.008	.002	.005	.012	.143
		HF7				■			●	+	.008	.002	.005	.012	.143
	TCGT 21.51F-AL	T0315				■			●	+	.016	.004	.009	.016	.143
		HF7				■			●	+	.016	.004	.009	.016	.143
	TCGT 21.52F-AL	T0315				■			●	++	.031	.006	.019	.031	.143
		HF7				■			●	++	.031	.006	.019	.031	.143
	TCGT 32.51F-AL	T0315				■			●	+	.016	.004	.009	.016	.208
		HF7				■			●	+	.016	.004	.009	.016	.208
	TCGT 32.52F-AL	T0315				■			●	++	.031	.006	.019	.031	.208
		HF7				■			●	++	.031	.006	.019	.031	.208
	TCGT 1.21.20.5-FF2	T8430	■		■				●	+	.008	.001	.005	.006	.078
		TT010	■	■					●	+/-	.008	.001	.005	.006	.078
	TCGT 1.81.50.5-FF2	TT010	■	■					●	+/-	.008	.002	.005	.008	.059
	TCGT 21.51-NF1	T7325	■	■			■		●	++	.016	.003	.009	.012	.098
		T6310	■	■	■		■		●	+	.016	.003	.009	.012	.098
		H07*	■	■	■		■		●	+	.016	.003	.009	.012	.098
	TCGT 21.50.5-SF3	T6310		■		■	■		●	+	.008	.001	.005	.008	.063
		T8315		■		■	□		●	+	.008	.001	.005	.008	.063
	TCGT 21.51-SF3	T6310		■		■	■		●	+	.016	.002	.008	.008	.079
		T8315		■		■	□		●	+	.016	.002	.008	.008	.079
		H07		■		■	■		●	+	.016	.002	.008	.008	.079
	TCGT 32.51-SF3	T6310		■		■	■		●	+	.016	.002	.009	.008	.098
		T8315		■		■	□		●	+	.016	.002	.009	.008	.098
		H07		■		■	■		●	+	.016	.002	.009	.008	.098
	TCGT 32.52-SF3	T6310		■		■	■		●	+	.031	.003	.012	.024	.126
		T8315		■		■	□		●	+	.031	.003	.012	.024	.126
		H07		■		■	■		●	+	.031	.003	.012	.024	.126
	TCGT 32.53-SF3	T6310		■		■	■		●	++	.047	.004	.024	.031	.138

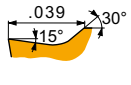
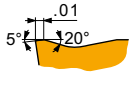
\* Non-stocked item



i	ANSI	Image	P	M	K	N	S	H	Image	Image	r <sub>c</sub>	f <sub>min</sub>	f <sub>max</sub>	a <sub>p min</sub>	a <sub>p max</sub>
  	TCMT 32.51-FF2		T9325	■	■	■			●	+	.016	.002	.009	.012	.118
			T9335	■	■				●	++	.016	.002	.009	.012	.118
	TCMT 32.52-FF2	T8430	■	■	■			●	+	.016	.002	.009	.012	.118	
		TT010	■	■				●	+/-	.016	.002	.009	.012	.118	
		T7325	■	■				●	++	.031	.003	.011	.024	.118	
		T9315	■	■	■			●	++	.031	.003	.011	.024	.118	
		T9325	■	■	■			●	++	.031	.003	.011	.024	.118	
		T9335	■	■				●	++	.031	.003	.011	.024	.118	
		T8430	■	■	■			●	+	.031	.003	.011	.024	.118	
		TCMT 21.50.5-FM	T7325	■	■			□		●	++	.008	.003	.005	.008
T7335	■		■			□		●	++	.008	.003	.005	.008	.079	
T9315	■		■	■			●	++	.008	.003	.005	.008	.079		
T9325	■		■	■		□		●	+	.008	.003	.005	.008	.079	
T8315	■		■	■		□		●	+	.008	.003	.005	.008	.079	
T8430	■		■	■	■		●	+	.008	.003	.005	.008	.079		
TCMT 21.51-FM	T7325		■	■			□		●	++	.016	.006	.009	.008	.079
	T7335		■	■			□		●	++	.016	.006	.009	.008	.079
	T9315		■	■	■			●	++	.016	.006	.009	.008	.079	
	T9325		■	■	■		□		●	+	.016	.006	.009	.008	.079
	T8315	■	■	■		□		●	+	.016	.003	.009	.008	.079	
	T8430	■	■	■	■		●	+	.016	.003	.009	.008	.079		
TCMT 21.52-FM	T7325	■	■			□		●	++	.031	.006	.012	.020	.098	
	T9315	■	■	■			●	++	.031	.006	.012	.020	.098		
	T9325	■	■	■		□		●	+	.031	.006	.012	.020	.098	
	T8430	■	■	■	■		●	+	.031	.006	.012	.020	.098		
	TCMT 32.51-FM	T7325	■	■			□		●	++	.016	.006	.009	.012	.118
		T7335	■	■			□		●	++	.016	.006	.009	.012	.118
		T9315	■	■	■			●	++	.016	.006	.009	.012	.118	
		T9325	■	■	■		□		●	+	.016	.006	.009	.012	.118
		T8315	■	■	■		□		●	+	.016	.004	.009	.012	.118
		T8430	■	■	■	■		●	+	.016	.004	.009	.012	.118	
TCMT 32.52-FM	T7325	■	■			□		●	++	.031	.006	.014	.020	.118	
	T7335	■	■			□		●	++	.031	.006	.014	.020	.118	
	T9315	■	■	■			●	++	.031	.006	.014	.020	.118		
	T9325	■	■	■		□		●	++	.031	.006	.014	.020	.118	
	T8315	■	■	■		□		●	-	.031	.004	.010	.020	.118	
	T8430	■	■	■	■		●	-	.031	.004	.010	.020	.118		
TCMT 21.51-FM2	T9325	■	■	■		□		●	+	.016	.002	.009	.012	.098	
	T8430	■	■	■			●	+	.016	.002	.009	.012	.098		
	TCMT 21.52-FM2	T9325	■	■	■		□		●	+	.031	.004	.012	.024	.118
		T9335	■	■			□		●	++	.031	.004	.012	.024	.118
	TCMT 32.52-FM2	T8430	■	■	■			●	+	.031	.004	.012	.024	.118	
		T7325	■	■			□		●	++	.031	.004	.014	.031	.138
		T9325	■	■	■		□		●	++	.031	.004	.014	.031	.138
		T9335	■	■			□		●	++	.031	.004	.014	.031	.138
	TCMT 32.52-RM	T8430	■	■	■			●	+	.031	.004	.014	.031	.138	
		TCMT 32.53-RM	T5305	□	■	■		□		●	+	.031	.006	.016	.039
T5315			■	□	■		□		●	++	.031	.006	.016	.039	.157
TCMT 32.53-RM		T7335	■	■				●	+++	.031	.006	.016	.039	.157	
		T9315	■	■	■		□		●	++	.031	.006	.016	.039	.157
		T9325	■	■	■		□		●	++	.031	.006	.016	.039	.157
		T8430	■	■	■	■	■	●	+	.031	.006	.016	.039	.157	
		T5305	□	■	■		□		●	++	.047	.006	.018	.059	.157
		T5315	■	□	■		□		●	++	.047	.006	.018	.059	.157
		T9315	■	■	■		□		●	++	.047	.006	.018	.059	.157
	T9325	■	■	■		□		●	++	.047	.006	.018	.059	.157	
T8430	■	■	■	■	■	●	++	.047	.006	.018	.059	.157			

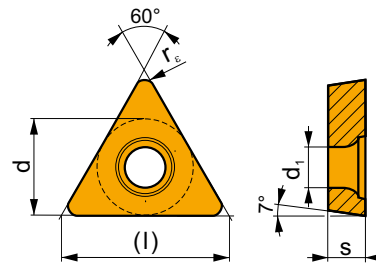


i	ANSI		P	M	K	N	S	H			$r_e$	$f_{min}$	$f_{max}$	$a_{p min}$	$a_{p max}$
 	TCMT 32.51-RM3	T7325	■	■					●	++	.016	.010	.009	.016	.118
		T9315	■		■				●	++	.016	.010	.009	.016	.118
	T9325	■	■	■				●	++	.016	.010	.009	.016	.118	
	T9335	■	■					●	++	.016	.010	.009	.016	.118	
	T6310	■	■	■				●	+	.016	.010	.009	.016	.118	
	T8430	■	■	■			■	●	++	.016	.010	.009	.016	.118	
	TCMT 32.52-RM3	T7325	■	■					●	++	.031	.010	.016	.031	.118
		T9315	■		■				●	++	.031	.010	.016	.031	.118
		T9325	■	■	■				●	++	.031	.010	.016	.031	.118
		T9335	■	■					●	+++	.031	.010	.016	.031	.118
T6310		■	■	■				●	++	.031	.010	.016	.031	.118	
T8430		■	■	■			■	●	++	.031	.010	.016	.031	.118	
	TCMT 21.51-UR	T7325	■	■					●	++	.016	.006	.009	.016	.079
		T9315	■		■				●	++	.016	.006	.009	.016	.079
		T9325	■	■	■				●	+	.016	.006	.009	.016	.079
		T8430	■	■	■				●	+	.016	.003	.009	.016	.079
	TCMT 32.51-UR	T7325	■	■					●	++	.016	.006	.009	.016	.118
		T9315	■		■				●	++	.016	.006	.009	.016	.118
		T9325	■	■	■				●	+	.016	.006	.009	.016	.118
		T8430	■	■	■				●	+	.016	.003	.009	.016	.118
	TCMT 32.52-UR	TT310	■	■					●	+/-	.016	.003	.009	.016	.118
		T5315	■	■	■				●	+	.031	.004	.012	.031	.118
T7325		■	■					●	++	.031	.006	.012	.031	.118	
T9315		■		■				●	++	.031	.006	.012	.031	.118	
	TCMT 32.52-UR	T9325	■	■	■				●	+	.031	.006	.012	.031	.118
		T8430	■	■	■				●	+	.031	.003	.012	.031	.118



## TCMW

	d	d <sub>1</sub>	l	s
21.5	.250	.110	.433	.094
32.5	.375	.173	.650	.156

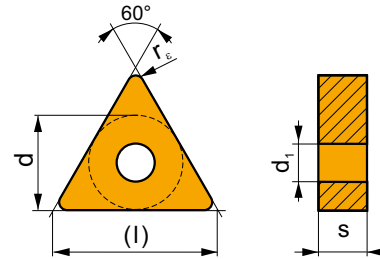


For tools see pages: T224

i	ANSI		P	M	K	N	S	H			$r_e$	$f_{min}$	$f_{max}$	$a_{p min}$	$a_{p max}$
  	TCMW 21.51	T5305	□		■			■	●	+	.016	.004	.008	.016	.142
		T5315	■	□	■			□	●	+	.016	.004	.008	.016	.142
	TCMW 32.51	T5305	□		■			■	●	+	.016	.004	.009	.016	.189
		T5315	■	□	■			□	●	+	.016	.004	.009	.016	.189
	TCMW 32.52	T6310	■	□	■			■	●	+	.016	.002	.009	.016	.189
		T5305	□		■			■	●	+	.031	.004	.014	.031	.189
	TCMW 32.52	T5315	■	□	■			□	●	+	.031	.004	.014	.031	.189
		T6310	■	□	■			■	●	+	.031	.002	.014	.031	.189

# TNMA

	d	d <sub>1</sub>	l	s
33	.375	.150	.650	.187
43	.500	.203	.866	.187

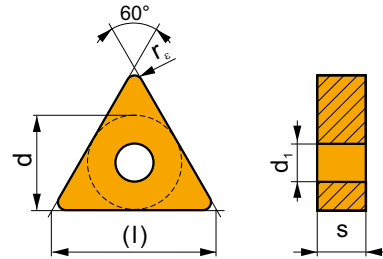


For tools see pages: T196-T198, T209, T217, T250-T253

i	ANSI	Material	P	M	K	N	S	H	Chip	Coolant	r <sub>c</sub>	f <sub>min</sub>	f <sub>max</sub>	a <sub>p min</sub>	a <sub>p max</sub>
	TNMA 331	T5305	<input type="checkbox"/>	<input type="checkbox"/>	<input checked="" type="checkbox"/>	<input type="checkbox"/>	<input type="checkbox"/>	<input checked="" type="checkbox"/>	●	+	.016	.004	.009	.016	.189
		T5315	<input checked="" type="checkbox"/>	<input type="checkbox"/>	<input checked="" type="checkbox"/>	<input type="checkbox"/>	<input type="checkbox"/>	<input type="checkbox"/>	●	+	.016	.004	.009	.016	.189
	TNMA 332	T5305	<input type="checkbox"/>	<input type="checkbox"/>	<input checked="" type="checkbox"/>	<input type="checkbox"/>	<input type="checkbox"/>	<input checked="" type="checkbox"/>	●	+	.031	.004	.016	.031	.189
		T5315	<input checked="" type="checkbox"/>	<input type="checkbox"/>	<input checked="" type="checkbox"/>	<input type="checkbox"/>	<input type="checkbox"/>	<input type="checkbox"/>	●	++	.031	.004	.016	.031	.189
		T6310	<input checked="" type="checkbox"/>	<input type="checkbox"/>	<input checked="" type="checkbox"/>	<input type="checkbox"/>	<input checked="" type="checkbox"/>	<input checked="" type="checkbox"/>	●	++	.031	.002	.016	.031	.189
	TNMA 333	T5305	<input type="checkbox"/>	<input type="checkbox"/>	<input checked="" type="checkbox"/>	<input type="checkbox"/>	<input type="checkbox"/>	<input checked="" type="checkbox"/>	●	+	.047	.004	.016	.047	.189
		T5315	<input checked="" type="checkbox"/>	<input type="checkbox"/>	<input checked="" type="checkbox"/>	<input type="checkbox"/>	<input type="checkbox"/>	<input type="checkbox"/>	●	++	.047	.004	.016	.047	.189
	TNMA 432	T5305	<input type="checkbox"/>	<input type="checkbox"/>	<input checked="" type="checkbox"/>	<input type="checkbox"/>	<input type="checkbox"/>	<input checked="" type="checkbox"/>	●	+	.031	.004	.016	.031	.252
		T5315	<input checked="" type="checkbox"/>	<input type="checkbox"/>	<input checked="" type="checkbox"/>	<input type="checkbox"/>	<input type="checkbox"/>	<input type="checkbox"/>	●	++	.031	.004	.016	.031	.252
		T6310	<input checked="" type="checkbox"/>	<input type="checkbox"/>	<input checked="" type="checkbox"/>	<input type="checkbox"/>	<input checked="" type="checkbox"/>	<input checked="" type="checkbox"/>	●	++	.031	.002	.016	.031	.252
	TNMA 433	T5305	<input type="checkbox"/>	<input type="checkbox"/>	<input checked="" type="checkbox"/>	<input type="checkbox"/>	<input type="checkbox"/>	<input checked="" type="checkbox"/>	●	+	.047	.004	.016	.047	.252
		T5315	<input checked="" type="checkbox"/>	<input type="checkbox"/>	<input checked="" type="checkbox"/>	<input type="checkbox"/>	<input type="checkbox"/>	<input type="checkbox"/>	●	++	.047	.004	.016	.047	.252
	TNMA 332S	T5305	<input type="checkbox"/>	<input type="checkbox"/>	<input checked="" type="checkbox"/>	<input type="checkbox"/>	<input type="checkbox"/>	<input checked="" type="checkbox"/>	●	+	.031	.004	.016	.031	.189
	TNMA 433S	T5305	<input type="checkbox"/>	<input type="checkbox"/>	<input checked="" type="checkbox"/>	<input type="checkbox"/>	<input type="checkbox"/>	<input checked="" type="checkbox"/>	●	+	.047	.004	.016	.047	.252

# TNMG

	d	d <sub>1</sub>	l	s
33	.375	.150	.650	.187
43	.500	.203	.866	.187
54	.625	.250	1.083	.250
66	.750	.313	1.299	.375



For tools see pages: T196-T198, T209, T217, T250-T253

i	ANSI	Image	P	M	K	N	S	H	?	Image	r <sub>c</sub>	f <sub>min</sub>	f <sub>max</sub>	a <sub>p min</sub>	a <sub>p max</sub>
  	TNMG 331-FF	T7325	█	█					●	++	.016	.006	.008	.016	.059
		T8315	█	█	█				●	+	.016	.002	.008	.016	.059
		T8430	█	█	█				●	+	.016	.002	.008	.016	.059
		T7325	█	█					●	++	.031	.006	.010	.031	.059
 	TNMG 332-FF	T8315	█	█	█				●	+	.031	.003	.010	.031	.059
		T7325	█	█					●	++	.016	.006	.009	.020	.118
		T7335	█	█					●	++	.016	.006	.009	.020	.118
		T9310	█		█				●	+	.016	.006	.009	.020	.118
  	TNMG 331-FM	T9315	█		█				●	++	.016	.006	.009	.020	.118
		T9325	█	█	█				●	+	.016	.006	.009	.020	.118
		T8315	█	█	█				●	+	.016	.004	.009	.020	.118
		T8430	█	█	█		█		●	+	.016	.004	.009	.020	.118
		TT310	█	█					●	+/-	.016	.004	.009	.020	.118
		T7325	█	█					●	++	.031	.006	.018	.031	.118
		T7335	█	█					●	+++	.031	.006	.018	.031	.118
		T9310	█		█				●	++	.031	.006	.018	.031	.118
		T9315	█		█				●	++	.031	.006	.018	.031	.118
		T9325	█	█	█				●	++	.031	.006	.018	.031	.118
		T8315	█	█	█				●	++	.031	.006	.018	.031	.118
		T8430	█	█	█		█		●	++	.031	.006	.018	.031	.118
 	TNMG 332-FM	TT310	█	█					●	+/-	.031	.006	.018	.031	.118
		T7325	█	█					●	++	.047	.006	.018	.047	.118
		T9315	█		█				●	++	.047	.006	.018	.047	.118
		T9325	█	█	█				●	++	.047	.006	.018	.047	.118
 	TNMG 333-FM	T8430	█	█	█		█		●	++	.047	.006	.018	.047	.118
		T9315	█		█				●	++	.047	.006	.018	.047	.118
		T9325	█	█	█				●	++	.047	.006	.018	.047	.118
		T8430	█	█	█		█		●	++	.047	.006	.018	.047	.118
 	TNMG 431-FM	T9315	█		█				●	++	.016	.008	.009	.031	.197
		T9325	█	█	█				●	+	.016	.006	.009	.031	.118
		T8430	█	█	█		█		●	+	.016	.006	.009	.031	.118
 	TNMG 432-FM	T9315	█		█				●	++	.031	.006	.018	.031	.118
		T9325	█	█	█				●	++	.031	.006	.018	.031	.118
		T8430	█	█	█		█		●	++	.031	.006	.018	.031	.118
 	TNMG 332-KR	T5305	█		█			█	●	+	.031	.008	.016	.031	.156
		T5315	█	█	█			█	●	+	.031	.008	.016	.031	.156

i	ANSI		P	M	K	N	S	H			r <sub>c</sub>	f <sub>min</sub>	f <sub>max</sub>	a <sub>p min</sub>	a <sub>p max</sub>		
 	TNMG 331-M	T5315	█	□	█			□	●	+	.016	.007	.009	.031	.118		
		T9315	█		█			□	●	++	.016	.007	.009	.031	.118		
		T9325	█	█	█					●	+	.016	.007	.009	.031	.118	
		T9335	█	█						●	++	.016	.007	.009	.031	.118	
	TNMG 332-M	T5305	□		█				□	●	++	.031	.006	.019	.031	.197	
		T5315	█	□	█				□	●	++	.031	.006	.019	.031	.197	
		T9310	█		█					●	++	.031	.006	.019	.031	.197	
		T9315	█		█				□	●	++	.031	.006	.019	.031	.197	
		T9325	█	█	█					●	++	.031	.006	.019	.031	.197	
	TNMG 333-M	T5315	█	□	█				□	●	++	.047	.007	.028	.047	.208	
		T9315	█		█				□	●	+++	.047	.007	.028	.047	.208	
		T9325	█	█	█					●	++	.047	.007	.028	.047	.208	
		T9335	█	█						●	+++	.047	.007	.028	.047	.208	
	TNMG 432-M	T5305	□		█				□	●	++	.031	.007	.019	.031	.236	
		T5315	█	□	█				□	●	++	.031	.007	.019	.031	.236	
		T9310	█		█					●	++	.031	.007	.019	.031	.236	
T9315		█		█				□	●	++	.031	.007	.019	.031	.236		
T9325		█	█	█					●	++	.031	.007	.019	.031	.236		
T9335		█	█						●	+++	.031	.007	.019	.031	.236		
TNMG 433-M	T5315	█	□	█				□	●	++	.047	.007	.028	.047	.236		
	T9315	█		█				□	●	+++	.047	.007	.028	.047	.236		
	T9325	█	█	█					●	++	.047	.007	.028	.047	.236		
	T9335	█	█						●	+++	.047	.007	.028	.047	.236		
 	TNMG 331-NF	T7325	█	█				█	●	++	.016	.006	.009	.016	.118		
		T7335	█	█				█	●	++	.016	.006	.009	.016	.118		
		T9315	█							●	++	.016	.006	.009	.016	.118	
		T9325	█	█					█	●	+	.016	.006	.009	.016	.118	
	TNMG 332-NF	T6310	█	█			□	█		●	+	.016	.005	.009	.016	.118	
		T8315	█	█			□	□		●	+	.016	.005	.009	.016	.118	
		T8430	█	█	█	█	█			●	+	.016	.005	.009	.016	.118	
		HF7		□			□	□		●	+	.016	.005	.009	.016	.118	
		T7325	█	█				█		●	++	.031	.006	.012	.031	.118	
		T7335	█	█				█		●	++	.031	.006	.012	.031	.118	
		T9315	█							●	++	.031	.006	.012	.031	.118	
		T9325	█	█				█		●	+	.031	.006	.012	.031	.118	
TNMG 331-NM	T7325	█	█					█	●	++	.016	.006	.009	.020	.118		
	T7335	█	█						●	++	.016	.006	.009	.020	.118		
	T9325	█	█	□				□	●	+	.016	.006	.009	.020	.118		
	T8315*	█	█	□	□	□			●	+	.016	.006	.009	.020	.118		
	T8430	█	█		█	█			●	+	.016	.006	.009	.020	.118		
	TNMG 332-NM	T7325	█	█					█	●	++	.031	.008	.016	.039	.118	
		T7335	█	█						●	++	.031	.008	.016	.039	.118	
		T9315	█		□					●	++	.031	.008	.016	.039	.118	
T9325		█	█	□				□	●	++	.031	.008	.016	.039	.118		
TNMG 432-NM	T7325	█	█					█	●	++	.031	.008	.016	.039	.138		
	T7335	█	█						●	++	.031	.008	.016	.039	.138		
	T9315	█		□					●	++	.031	.008	.016	.039	.138		
	T9325	█	█	□				□	●	++	.031	.008	.016	.039	.138		
TNMG 433-NM	T8315	█	█	□	□	□			●	+	.031	.008	.016	.039	.138		
	T8430	█	█		█	█			●	++	.031	.008	.016	.039	.138		
	TNMG 433-NM	T7325	█	█					█	●	++	.047	.008	.016	.047	.138	

\* Non-stocked item

i	ANSI	Image	P	M	K	N	S	H	Image	Image	r <sub>c</sub>	f <sub>min</sub>	f <sub>max</sub>	a <sub>p min</sub>	a <sub>p max</sub>	
																?
1	TNMG 433-NM	T7335	█	█					●	++	.047	.008	.016	.047	.138	
			T9325	█	█	□		□		●	++	.047	.008	.016	.047	.138
U																
S																
1	TNMG 331-NMR	T6310	█	█				█		●	+	.016	.008	.009	.016	.157
		T7325	█	█				█		●	++	.016	.008	.009	.016	.157
		T7335	█	█				█		●	++	.016	.008	.009	.016	.157
		T9315	█	█						●	++	.016	.008	.009	.016	.157
		T9325	█	█				█		●	+	.016	.008	.009	.016	.157
		T8430	█	█				█		●	+	.016	.008	.009	.016	.157
	TNMG 332-NMR	T6310	█	█						●	++	.031	.008	.019	.031	.157
		T7325	█	█				█		●	++	.031	.008	.019	.031	.157
		T7335	█	█				█		●	+++	.031	.008	.019	.031	.157
		T9315	█	█						●	++	.031	.008	.019	.031	.157
	TNMG 333-NMR	T9325	█	█				█		●	++	.031	.008	.019	.031	.157
		T8430	█	█				█		●	++	.031	.008	.019	.031	.157
		T7325	█	█				█		●	++	.047	.009	.022	.047	.177
		T9315	█	█						●	++	.047	.009	.022	.047	.177
TNMG 432-NMR	T9325	█	█				█		●	++	.047	.009	.022	.047	.177	
	T6310	█	█						●	++	.031	.008	.019	.031	.236	
TNMG 433-NMR	T7325	█	█				█		●	++	.031	.008	.019	.031	.236	
	T7335	█	█				█		●	+++	.031	.008	.019	.031	.236	
	T9315	█	█						●	++	.031	.008	.019	.031	.236	
	T9325	█	█				█		●	++	.031	.008	.019	.031	.236	
	T8430	█	█				█		●	++	.031	.008	.019	.031	.236	
TNMG 433-NMR	T6310	█	█						●	++	.047	.009	.028	.047	.236	
	T7325	█	█				█		●	+++	.047	.009	.028	.047	.236	
	T9315	█	█						●	++	.047	.009	.028	.047	.236	
	T9325	█	█				█		●	++	.047	.009	.028	.047	.236	
TNMG 332-R	T5305	█	█	█				□	●	++	.031	.010	.019	.031	.208	
	T5315	█	█	█				□	●	++	.031	.010	.019	.031	.208	
	T9310	█	█	█				□	●	++	.031	.010	.019	.031	.208	
	T9315	█	█	█				□	●	++	.031	.010	.019	.031	.208	
	T9325	█	█	█					●	++	.031	.010	.019	.031	.208	
	T9335	█	█	█					●	+++	.031	.010	.019	.031	.208	
TNMG 333-R	T5315	█	█	█				□	●	++	.047	.010	.028	.079	.236	
	T9325	█	█	█					●	++	.047	.010	.028	.079	.236	
	T9335	█	█	█					●	+++	.047	.010	.028	.079	.236	
TNMG 432-R	T9325	█	█	█					●	++	.031	.010	.019	.079	.236	
	T9335	█	█	█					●	+++	.031	.010	.019	.079	.236	
	T9335	█	█	█					●	+++	.031	.010	.019	.079	.236	
TNMG 433-R	T9310	█	█	█				□	●	++	.047	.010	.028	.079	.236	
	T9315	█	█	█				□	●	+++	.047	.010	.028	.079	.236	
	T9325	█	█	█					●	++	.047	.010	.028	.079	.236	
TNMG 434-R	T9315	█	█	█				□	●	+++	.063	.010	.031	.079	.236	
	T9325	█	█	█					●	++	.063	.010	.031	.079	.236	
1	TNMG 332-RM	T5305	█	█	█			□	●	++	.031	.008	.019	.039	.208	
		T5315	█	█	█			□	●	++	.031	.008	.019	.039	.208	
		T7325	█	█				█		●	++	.031	.008	.019	.039	.208
		T7335	█	█				█		●	+++	.031	.008	.019	.039	.208
		T9310	█	█	█					●	++	.031	.008	.019	.039	.208
		T9315	█	█	█				□	●	++	.031	.008	.019	.039	.208
		T9325	█	█	█				□	●	++	.031	.008	.019	.039	.208
S	TNMG 332-RM	T9335	█	█					●	+++	.031	.008	.019	.039	.208	
		T9335	█	█					●	+++	.031	.008	.019	.039	.208	

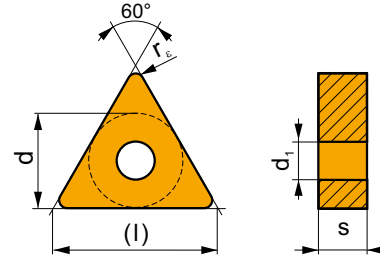
i	ANSI		P	M	K	N	S	H			r <sub>c</sub>	f <sub>min</sub>	f <sub>max</sub>	a <sub>p min</sub>	a <sub>p max</sub>	1		S		
TNMG 333-RM	T5305		<input type="checkbox"/>	<input type="checkbox"/>	<input checked="" type="checkbox"/>	<input type="checkbox"/>	<input type="checkbox"/>	<input type="checkbox"/>		++	.047	.010	.026	.059	.208					
	T5315		<input checked="" type="checkbox"/>	<input type="checkbox"/>	<input checked="" type="checkbox"/>	<input type="checkbox"/>	<input type="checkbox"/>	<input type="checkbox"/>		++	.047	.010	.026	.059	.208					
	T7325		<input checked="" type="checkbox"/>	<input checked="" type="checkbox"/>	<input type="checkbox"/>	<input type="checkbox"/>	<input checked="" type="checkbox"/>	<input type="checkbox"/>		+++	.047	.010	.026	.059	.208					
	T7335		<input checked="" type="checkbox"/>	<input checked="" type="checkbox"/>	<input type="checkbox"/>	<input type="checkbox"/>	<input checked="" type="checkbox"/>	<input type="checkbox"/>		+++	.047	.010	.026	.059	.208					
	T9315		<input checked="" type="checkbox"/>	<input type="checkbox"/>	<input checked="" type="checkbox"/>	<input type="checkbox"/>	<input type="checkbox"/>	<input type="checkbox"/>		+++	.047	.010	.026	.059	.208					
	T9325		<input checked="" type="checkbox"/>	<input checked="" type="checkbox"/>	<input checked="" type="checkbox"/>	<input type="checkbox"/>	<input type="checkbox"/>	<input type="checkbox"/>		++	.047	.010	.026	.059	.208					
	T9335		<input checked="" type="checkbox"/>	<input checked="" type="checkbox"/>	<input type="checkbox"/>	<input type="checkbox"/>	<input type="checkbox"/>	<input type="checkbox"/>		+++	.047	.010	.026	.059	.208					
	T8430		<input checked="" type="checkbox"/>	<input checked="" type="checkbox"/>	<input checked="" type="checkbox"/>	<input type="checkbox"/>	<input type="checkbox"/>	<input type="checkbox"/>		++	.047	.010	.026	.059	.208					
TNMG 432-RM	T5305		<input type="checkbox"/>	<input type="checkbox"/>	<input checked="" type="checkbox"/>	<input type="checkbox"/>	<input type="checkbox"/>	<input type="checkbox"/>		++	.031	.008	.019	.039	.276					
	T5315		<input checked="" type="checkbox"/>	<input type="checkbox"/>	<input checked="" type="checkbox"/>	<input type="checkbox"/>	<input type="checkbox"/>	<input type="checkbox"/>		++	.031	.008	.019	.039	.276					
	T7325		<input checked="" type="checkbox"/>	<input checked="" type="checkbox"/>	<input type="checkbox"/>	<input type="checkbox"/>	<input checked="" type="checkbox"/>	<input type="checkbox"/>		++	.031	.008	.019	.039	.276					
	T7335		<input checked="" type="checkbox"/>	<input checked="" type="checkbox"/>	<input type="checkbox"/>	<input type="checkbox"/>	<input checked="" type="checkbox"/>	<input type="checkbox"/>		+++	.031	.008	.019	.039	.276					
	T9310*		<input checked="" type="checkbox"/>	<input type="checkbox"/>	<input checked="" type="checkbox"/>	<input type="checkbox"/>	<input type="checkbox"/>	<input type="checkbox"/>		++	.031	.008	.019	.039	.276					
	T9315		<input checked="" type="checkbox"/>	<input type="checkbox"/>	<input checked="" type="checkbox"/>	<input type="checkbox"/>	<input type="checkbox"/>	<input type="checkbox"/>		++	.031	.008	.019	.039	.276					
	T9325		<input checked="" type="checkbox"/>	<input checked="" type="checkbox"/>	<input checked="" type="checkbox"/>	<input type="checkbox"/>	<input type="checkbox"/>	<input type="checkbox"/>		++	.031	.008	.019	.039	.276					
	T9335		<input checked="" type="checkbox"/>	<input checked="" type="checkbox"/>	<input type="checkbox"/>	<input type="checkbox"/>	<input type="checkbox"/>	<input type="checkbox"/>		+++	.031	.008	.019	.039	.276					
TNMG 433-RM	T5305		<input type="checkbox"/>	<input type="checkbox"/>	<input checked="" type="checkbox"/>	<input type="checkbox"/>	<input type="checkbox"/>	<input type="checkbox"/>		++	.047	.010	.026	.059	.276					
	T5315		<input checked="" type="checkbox"/>	<input type="checkbox"/>	<input checked="" type="checkbox"/>	<input type="checkbox"/>	<input type="checkbox"/>	<input type="checkbox"/>		++	.047	.010	.026	.059	.276					
	T7325		<input checked="" type="checkbox"/>	<input checked="" type="checkbox"/>	<input type="checkbox"/>	<input type="checkbox"/>	<input checked="" type="checkbox"/>	<input type="checkbox"/>		+++	.047	.010	.026	.059	.276					
	T7335		<input checked="" type="checkbox"/>	<input checked="" type="checkbox"/>	<input type="checkbox"/>	<input type="checkbox"/>	<input checked="" type="checkbox"/>	<input type="checkbox"/>		+++	.047	.010	.026	.059	.276					
	T9315		<input checked="" type="checkbox"/>	<input type="checkbox"/>	<input checked="" type="checkbox"/>	<input type="checkbox"/>	<input type="checkbox"/>	<input type="checkbox"/>		+++	.047	.010	.026	.059	.276					
	T9325		<input checked="" type="checkbox"/>	<input checked="" type="checkbox"/>	<input checked="" type="checkbox"/>	<input type="checkbox"/>	<input type="checkbox"/>	<input type="checkbox"/>		++	.047	.010	.026	.059	.276					
	T9335		<input checked="" type="checkbox"/>	<input checked="" type="checkbox"/>	<input type="checkbox"/>	<input type="checkbox"/>	<input type="checkbox"/>	<input type="checkbox"/>		+++	.047	.010	.026	.059	.276					
	T8430		<input checked="" type="checkbox"/>	<input checked="" type="checkbox"/>	<input checked="" type="checkbox"/>	<input type="checkbox"/>	<input type="checkbox"/>	<input type="checkbox"/>		++	.047	.010	.026	.059	.276					
TNMG 434-RM	T5305		<input type="checkbox"/>	<input type="checkbox"/>	<input checked="" type="checkbox"/>	<input type="checkbox"/>	<input type="checkbox"/>	<input type="checkbox"/>		++	.063	.012	.030	.079	.276					
	T5315		<input checked="" type="checkbox"/>	<input type="checkbox"/>	<input checked="" type="checkbox"/>	<input type="checkbox"/>	<input type="checkbox"/>	<input type="checkbox"/>		++	.063	.012	.030	.079	.276					
	T7325		<input checked="" type="checkbox"/>	<input checked="" type="checkbox"/>	<input type="checkbox"/>	<input type="checkbox"/>	<input checked="" type="checkbox"/>	<input type="checkbox"/>		+++	.063	.012	.030	.079	.276					
	T9315		<input checked="" type="checkbox"/>	<input type="checkbox"/>	<input checked="" type="checkbox"/>	<input type="checkbox"/>	<input type="checkbox"/>	<input type="checkbox"/>		+++	.063	.012	.030	.079	.276					
	T9325		<input checked="" type="checkbox"/>	<input checked="" type="checkbox"/>	<input checked="" type="checkbox"/>	<input type="checkbox"/>	<input type="checkbox"/>	<input type="checkbox"/>		++	.063	.012	.030	.079	.276					
	T9335		<input checked="" type="checkbox"/>	<input checked="" type="checkbox"/>	<input type="checkbox"/>	<input type="checkbox"/>	<input type="checkbox"/>	<input type="checkbox"/>		+++	.063	.012	.030	.079	.276					
	T7325		<input checked="" type="checkbox"/>	<input checked="" type="checkbox"/>	<input type="checkbox"/>	<input type="checkbox"/>	<input checked="" type="checkbox"/>	<input type="checkbox"/>		+++	.047	.014	.028	.047	.351					
	T9325		<input checked="" type="checkbox"/>	<input checked="" type="checkbox"/>	<input checked="" type="checkbox"/>	<input type="checkbox"/>	<input type="checkbox"/>	<input type="checkbox"/>		++	.047	.014	.028	.047	.351					
TNMG 543-RM	T7325		<input checked="" type="checkbox"/>	<input checked="" type="checkbox"/>	<input type="checkbox"/>	<input type="checkbox"/>	<input checked="" type="checkbox"/>	<input type="checkbox"/>		+++	.047	.014	.028	.047	.351					
	T9325		<input checked="" type="checkbox"/>	<input checked="" type="checkbox"/>	<input checked="" type="checkbox"/>	<input type="checkbox"/>	<input type="checkbox"/>	<input type="checkbox"/>		++	.047	.014	.028	.047	.351					
	T7325		<input checked="" type="checkbox"/>	<input checked="" type="checkbox"/>	<input type="checkbox"/>	<input type="checkbox"/>	<input checked="" type="checkbox"/>	<input type="checkbox"/>		+++	.063	.014	.030	.079	.351					
	T9315		<input checked="" type="checkbox"/>	<input type="checkbox"/>	<input checked="" type="checkbox"/>	<input type="checkbox"/>	<input type="checkbox"/>	<input type="checkbox"/>		+++	.063	.014	.030	.079	.351					
TNMG 544-RM	T9325		<input checked="" type="checkbox"/>	<input checked="" type="checkbox"/>	<input checked="" type="checkbox"/>	<input type="checkbox"/>	<input type="checkbox"/>	<input type="checkbox"/>		++	.063	.014	.030	.079	.351					
	T9335		<input checked="" type="checkbox"/>	<input checked="" type="checkbox"/>	<input type="checkbox"/>	<input type="checkbox"/>	<input type="checkbox"/>	<input type="checkbox"/>		+++	.063	.014	.030	.079	.351					
	T7325		<input checked="" type="checkbox"/>	<input checked="" type="checkbox"/>	<input type="checkbox"/>	<input type="checkbox"/>	<input checked="" type="checkbox"/>	<input type="checkbox"/>		+++	.094	.014	.031	.118	.351					
	T9325		<input checked="" type="checkbox"/>	<input checked="" type="checkbox"/>	<input checked="" type="checkbox"/>	<input type="checkbox"/>	<input type="checkbox"/>	<input type="checkbox"/>		++	.094	.014	.031	.118	.351					
TNMG 546-RM	T7325		<input checked="" type="checkbox"/>	<input checked="" type="checkbox"/>	<input type="checkbox"/>	<input type="checkbox"/>	<input checked="" type="checkbox"/>	<input type="checkbox"/>		+++	.094	.014	.031	.118	.351					
	T9325		<input checked="" type="checkbox"/>	<input checked="" type="checkbox"/>	<input checked="" type="checkbox"/>	<input type="checkbox"/>	<input type="checkbox"/>	<input type="checkbox"/>		++	.094	.014	.031	.118	.351					
	T9335		<input checked="" type="checkbox"/>	<input checked="" type="checkbox"/>	<input type="checkbox"/>	<input type="checkbox"/>	<input type="checkbox"/>	<input type="checkbox"/>		+++	.094	.014	.031	.118	.351					
TNMG 548-RM	T9335		<input checked="" type="checkbox"/>	<input checked="" type="checkbox"/>	<input type="checkbox"/>	<input type="checkbox"/>	<input type="checkbox"/>		+++	.126	.014	.031	.126	.351						
TNMG 666-RM	T9335		<input checked="" type="checkbox"/>	<input checked="" type="checkbox"/>	<input type="checkbox"/>	<input type="checkbox"/>	<input type="checkbox"/>		+++	.094	.018	.035	.118	.429						
TNMG 331-SF	T7325		<input checked="" type="checkbox"/>	<input checked="" type="checkbox"/>	<input type="checkbox"/>	<input type="checkbox"/>	<input checked="" type="checkbox"/>	<input type="checkbox"/>		++	.016	.006	.009	.016	.098					
	T7335		<input checked="" type="checkbox"/>	<input checked="" type="checkbox"/>	<input type="checkbox"/>	<input type="checkbox"/>	<input checked="" type="checkbox"/>	<input type="checkbox"/>		++	.016	.006	.009	.016	.098					
	T9315		<input checked="" type="checkbox"/>	<input type="checkbox"/>	<input checked="" type="checkbox"/>	<input type="checkbox"/>	<input type="checkbox"/>	<input type="checkbox"/>		++	.016	.006	.009	.016	.098					
	T9325		<input checked="" type="checkbox"/>	<input checked="" type="checkbox"/>	<input type="checkbox"/>	<input type="checkbox"/>	<input checked="" type="checkbox"/>	<input type="checkbox"/>		+	.016	.006	.009	.016	.098					
	T6310		<input checked="" type="checkbox"/>	<input checked="" type="checkbox"/>	<input type="checkbox"/>	<input type="checkbox"/>	<input checked="" type="checkbox"/>	<input type="checkbox"/>		+	.016	.004	.009	.016	.098					
	T8315		<input checked="" type="checkbox"/>	<input checked="" type="checkbox"/>	<input type="checkbox"/>	<input type="checkbox"/>	<input type="checkbox"/>	<input type="checkbox"/>		+	.016	.004	.009	.016	.098					
	T8430		<input checked="" type="checkbox"/>	<input checked="" type="checkbox"/>	<input checked="" type="checkbox"/>	<input checked="" type="checkbox"/>	<input checked="" type="checkbox"/>	<input checked="" type="checkbox"/>		+	.016	.004	.009	.016	.098					
	H07		<input type="checkbox"/>	<input checked="" type="checkbox"/>	<input type="checkbox"/>	<input type="checkbox"/>	<input checked="" type="checkbox"/>	<input type="checkbox"/>		+	.016	.004	.009	.016	.098					
	TNMG 332-SF	T7325		<input checked="" type="checkbox"/>	<input checked="" type="checkbox"/>	<input type="checkbox"/>	<input type="checkbox"/>	<input checked="" type="checkbox"/>	<input type="checkbox"/>		++	.031	.006	.011	.031	.118				
		T7335		<input checked="" type="checkbox"/>	<input checked="" type="checkbox"/>	<input type="checkbox"/>	<input type="checkbox"/>	<input checked="" type="checkbox"/>	<input type="checkbox"/>		++	.031	.006	.011	.031	.118				
T9315			<input checked="" type="checkbox"/>	<input type="checkbox"/>	<input checked="" type="checkbox"/>	<input type="checkbox"/>	<input type="checkbox"/>	<input type="checkbox"/>		++	.031	.006	.011	.031	.118					
T9325			<input checked="" type="checkbox"/>	<input checked="" type="checkbox"/>	<input type="checkbox"/>	<input type="checkbox"/>	<input checked="" type="checkbox"/>	<input type="checkbox"/>		++	.031	.006	.011	.031	.118					
T6310			<input checked="" type="checkbox"/>	<input checked="" type="checkbox"/>	<input type="checkbox"/>	<input type="checkbox"/>	<input checked="" type="checkbox"/>	<input type="checkbox"/>		+	.031	.005	.011	.031	.118					
T8315			<input checked="" type="checkbox"/>	<input checked="" type="checkbox"/>	<input type="checkbox"/>	<input type="checkbox"/>	<input type="checkbox"/>	<input type="checkbox"/>		+	.031	.005	.011	.031	.118					
T8430			<input checked="" type="checkbox"/>	<input checked="" type="checkbox"/>	<input checked="" type="checkbox"/>	<input checked="" type="checkbox"/>	<input checked="" type="checkbox"/>	<input checked="" type="checkbox"/>		++	.031	.005	.011	.031	.118					

\* Non-stocked item

i	ANSI		P M K N S H							r <sub>c</sub>	f <sub>min</sub>	f <sub>max</sub>	a <sub>p min</sub>	a <sub>p max</sub>	
   	TNMG 332-SF	H07		■		□	■	●	+	.031	.005	.011	.031	.118	
	TNMG 333-SF	T7325	■	■			■	●	++	.047	.006	.011	.047	.118	
	TNMG 432-SF	T6310	■	■		□	■	□	●	+	.031	.006	.014	.031	.138
	T8315	■	■		□	□	□	●	+	.031	.006	.014	.031	.138	
	T8430	■	■	■	■	■	■	●	++	.031	.006	.014	.031	.138	
  	TNMG 331-SM	T7325	■	■			■	●	++	.016	.007	.009	.016	.157	
	T7335	■	■			■	●	++	.016	.007	.009	.016	.157		
	T9315	■	■	■		□	●	++	.016	.007	.009	.016	.157		
	T9325	■	■	■		■	●	+	.016	.007	.009	.016	.157		
	T6310	■	■	■		□	●	+	.016	.007	.009	.016	.157		
	T8430	■	■	■	■	■	■	●	+	.016	.007	.009	.016	.157	
	TNMG 332-SM	T7325	■	■			■	●	++	.031	.008	.016	.031	.157	
	T7335	■	■			■	●	++	.031	.008	.016	.031	.157		
	T9315	■	■	■		□	●	++	.031	.008	.016	.031	.157		
	T9325	■	■	■		■	●	++	.031	.008	.016	.031	.157		
	T6310	■	■	■		□	●	++	.031	.008	.016	.031	.157		
	T8430	■	■	■	■	■	■	●	++	.031	.008	.016	.031	.157	
	TNMG 333-SM	T7325	■	■			■	●	++	.047	.009	.016	.047	.157	
	T7335	■	■			■	●	+++	.047	.009	.016	.047	.157		
	T9325	■	■	■		■	●	++	.047	.009	.016	.047	.157		
	TNMG 431-SM	T7325	■	■			■	●	++	.016	.008	.009	.016	.157	
	T9325	■	■	■		■	●	+	.016	.008	.009	.016	.157		
	T6310	■	■	■		□	●	+	.016	.008	.009	.016	.157		
	T8430	■	■	■	■	■	■	●	+	.016	.008	.009	.016	.157	
	TNMG 432-SM	T7325	■	■			■	●	++	.031	.008	.018	.031	.177	
T7335	■	■			■	●	+++	.031	.008	.018	.031	.177			
T9315	■	■	■		□	●	++	.031	.008	.018	.031	.177			
T9325	■	■	■		■	●	++	.031	.008	.018	.031	.177			
T6310	■	■	■		□	●	++	.031	.008	.018	.031	.177			
T8430	■	■	■	■	■	■	●	++	.031	.008	.018	.031	.177		
TNMG 433-SM	T7325	■	■			■	●	++	.047	.009	.020	.047	.197		
T7335	■	■			■	●	+++	.047	.009	.020	.047	.197			
T9315	■	■	■		□	●	++	.047	.009	.020	.047	.197			
T9325	■	■	■		■	●	++	.047	.009	.020	.047	.197			
TNMG 331R-SI	T7325	■	■			■	●	++	.016	.008	.009	.031	.197		
T7335	■	■			■	●	++	.016	.008	.009	.031	.197			
T9325	■	■	□		□	●	+	.016	.008	.009	.031	.197			
T8315	■	■	□	□	□	●	+	.016	.008	.009	.031	.197			
T8430	■	■		■	■	●	+	.016	.008	.009	.031	.197			
TNMG 332R-SI	T7325	■	■			■	●	++	.031	.008	.019	.031	.197		
T7335	■	■			■	●	+++	.031	.008	.019	.031	.197			
T9325	■	■	□		□	●	++	.031	.008	.019	.031	.197			
T8315	■	■	□	□	□	●	++	.031	.008	.019	.031	.197			
T8430	■	■		■	■	●	++	.031	.008	.019	.031	.197			
TNMG 331L-SI	T7325	■	■			■	●	++	.016	.008	.009	.031	.197		
T7335	■	■			■	●	++	.016	.008	.009	.031	.197			
T9325	■	■	□		□	●	+	.016	.008	.009	.031	.197			
T8315	■	■	□	□	□	●	+	.016	.008	.009	.031	.197			
T8430	■	■		■	■	●	+	.016	.008	.009	.031	.197			
TNMG 332L-SI	T7325	■	■			■	●	++	.031	.008	.019	.031	.197		
T7335	■	■			■	●	+++	.031	.008	.019	.031	.197			
T9325	■	■	□		□	●	++	.031	.008	.019	.031	.197			
T8315	■	■	□	□	□	●	++	.031	.008	.019	.031	.197			
T8430	■	■		■	■	●	++	.031	.008	.019	.031	.197			

# TNMM

	d	d <sub>1</sub>	l	s
33	.375	.150	.650	.187
43	.500	.203	.866	.187
54	.625	.250	1.083	.250



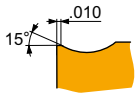
For tools see pages: T196-T198, T209, T217, T250-T253

i	ANSI	Material	P	M	K	N	S	H	Chip	Coolant	r <sub>c</sub>	f <sub>min</sub>	f <sub>max</sub>	a <sub>p min</sub>	a <sub>p max</sub>	
																?
	TNMM 332-DR	T9325	■	■	▣		□		●	++	.031	.012	.019	.098	.208	
	TNMM 432-DR	T9325	■	■	▣		□		●	++	.031	.012	.019	.098	.286	
	T9335	■	▣						●	+++	.031	.012	.019	.098	.286	
	TNMM 433-DR	T9315*	■		▣					●	+++	.047	.012	.028	.098	.286
	T9325	■	■	▣			□		●	++	.047	.012	.028	.098	.286	
	T9335	■	▣						●	+++	.047	.012	.028	.098	.286	
	TNMM 434-DR	T9325	■	■	▣			□		●	++	.063	.012	.033	.098	.286
	TNMM 544-DR	T9325	■	■	▣			□		●	++	.063	.012	.033	.098	.351
	T9335	■	▣						●	+++	.063	.012	.033	.098	.351	
	TNMM 544-HR	T9325	■	▣	▣			□		●	+++	.063	.020	.038	.197	.351
T9335	■	▣						●	+++	.063	.020	.038	.197	.351		
	TNMM 332-NR2	T9325	■	■	□		□		●	++	.031	.008	.019	.031	.208	
	TNMM 432-NR2	T7325	▣	■			■		●	+++	.031	.010	.019	.031	.286	
	T9325	■	■	□			□		●	++	.031	.010	.019	.031	.286	
	TNMM 433-NR2	T7325	▣	■			■		●	+++	.047	.012	.028	.047	.286	
	T9325	■	■	□			□		●	++	.047	.012	.028	.047	.286	
	T8430	■	■	▣			▣		●	++	.047	.012	.028	.047	.286	
	TNMM 332-OR	T9315	■		▣				●	++	.031	.010	.018	.079	.197	
	T9325	■	■	▣			□		●	++	.031	.010	.018	.079	.197	
	TNMM 333-OR	T9325	■	■	▣			□		●	++	.047	.012	.024	.079	.208
	TNMM 432-OR	T9315	■		▣				●	++	.031	.012	.019	.079	.236	
	T9325	■	■	▣			□		●	++	.031	.012	.019	.079	.236	
	T9335	■	▣						●	+++	.031	.012	.019	.079	.236	
	TNMM 433-OR	T9315	■		▣				●	+++	.047	.013	.028	.079	.276	
	T9325	■	■	▣			□		●	++	.047	.013	.028	.079	.276	
	T9335	■	▣						●	+++	.047	.013	.028	.079	.276	
	TNMM 434-OR	T9315	■		▣				●	+++	.063	.016	.031	.118	.286	
TNMM 433R	T9335	■	▣					●	+++	.047	.008	.020	.047	.197		

\* Non-stocked item

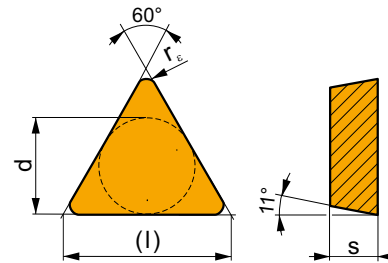


		ANSI		P	M	K	N	S	H			$r_c$	$f_{min}$	$f_{max}$	$a_{p min}$	$a_{p max}$
		TNMM 433L	T9335	■	▣					●	+++	.047	.008	.020	.047	.197

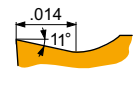
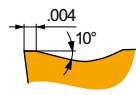


## TPMR

	d	l	s
22	.250	.433	.125
32	.375	.650	.125

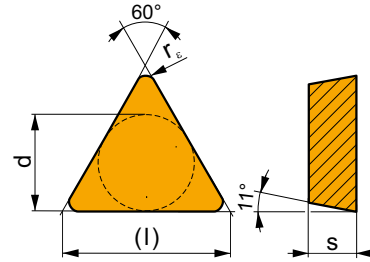


		ANSI		P	M	K	N	S	H			$r_c$	$f_{min}$	$f_{max}$	$a_{p min}$	$a_{p max}$
		TPMR 221-46	T9325	■	▣	▣				●	+	.016	.006	.009	.039	.118
			T9335	■	▣					●	++	.016	.006	.009	.039	.118
			6640	■	▣	▣				●	++	.016	.004	.009	.039	.118
		TPMR 222-46	T9325	■	▣	▣				●	++	.031	.006	.016	.039	.118
			T9335	■	▣				●	+++	.031	.006	.016	.039	.118	
		TPMR 321-47	T9325	■	▣	▣				●	+	.016	.006	.009	.031	.157
			T9335	■	▣				●	++	.016	.006	.009	.031	.157	
			6630	■	▣	▣			●	++	.016	.006	.009	.031	.157	
			6640	■	▣	▣			●	++	.016	.004	.009	.031	.157	
			T9325	■	▣	▣			●	++	.031	.006	.016	.031	.157	
		TPMR 322-47	T9335	■	▣				●	+++	.031	.006	.016	.031	.157	
			6630	■	▣	▣			●	++	.031	.006	.016	.031	.157	
			6640	■	▣	▣			●	++	.031	.004	.016	.031	.157	
			T9325	■	▣	▣			●	++	.047	.006	.016	.047	.157	
		TPMR 323-47	T9325	■	▣	▣			●	++	.047	.006	.016	.047	.157	
			T9335	■	▣				●	+++	.047	.006	.016	.047	.157	
		TPMR 322-61	T9325	■	▣	▣		□	●	++	.031	.012	.019	.039	.208	
			T9335	■	▣				●	+++	.031	.012	.019	.039	.208	
		TPMR 221-PF2	TT010	■	▣				●	+/-	.016	.004	.009	.008	.118	
			TPMR 321-PF2	TT010	■	▣				●	+/-	.016	.004	.009	.008	.150



## TPU

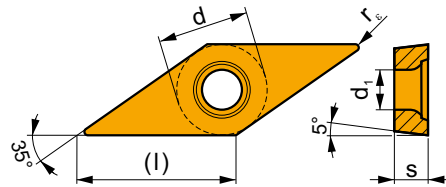
	d	l	s
22	.250	.433	.125
32	.375	.650	.125
43	.500	.866	.187



		ANSI		P	M	K	N	S	H			$r_c$	$f_{min}$	$f_{max}$	$a_{p min}$	$a_{p max}$
		TPU 221	6640	☑	☐	☑				●	++	.016	.004	.009	.016	.142
		TPU 222	6640	☑	☐	☑				●	++	.031	.004	.012	.031	.142
		TPU 321	6640	☑	☐	☑				●	++	.016	.004	.009	.016	.189
		TPU 322	6640	☑	☐	☑				●	++	.031	.004	.012	.031	.189
		TPU 323	6640	☑	☐	☑				●	++	.047	.004	.012	.047	.189
		TPU 432	6640	☑	☐	☑				●	++	.031	.004	.016	.031	.252
		TPU 433	6640	☑	☐	☑				●	++	.047	.004	.016	.047	.252

## VBMT

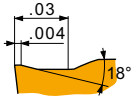
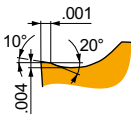
	d	$d_1$	l	s
21.5	.250	.110	.437	.094
22	.250	.110	.437	.125
33	.375	.173	.654	.187



For tools see pages: T210-T212, T225-T226

		ANSI		P	M	K	N	S	H			$r_c$	$f_{min}$	$f_{max}$	$a_{p min}$	$a_{p max}$
		VBMT 331-FF2	T7325	☑	☑					●	++	.016	.002	.008	.012	.098
			T9315	☑		☑				●	++	.016	.002	.008	.012	.098
			T9325	☑	☑	☑				●	+	.016	.002	.008	.012	.098
			T9335	☑	☑					●	++	.016	.002	.008	.012	.098
			T8330	☑	☑	☑				●	+	.016	.002	.008	.012	.098

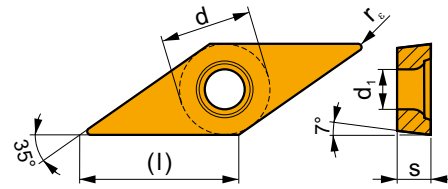
i	ANSI		P	M	K	N	S	H			r <sub>c</sub>	f <sub>min</sub>	f <sub>max</sub>	a <sub>p min</sub>	a <sub>p max</sub>	
   	VBMT 220.5-FM	T7325	█	█			□		●	++	.008	.003	.004	.008	.079	
		T9325	█	█	█		□		●	+	.008	.003	.004	.008	.079	
		T8315	█	█	█		□		●	+	.008	.003	.004	.008	.079	
		T8330	█	█	█		□		●	+	.008	.003	.004	.008	.079	
	VBMT 221-FM	T7325	█	█			□		●	++	.016	.006	.008	.016	.079	
		T7335	█	█			□		●	++	.016	.006	.008	.016	.079	
		T9315	█	█	█				●	++	.016	.006	.008	.016	.079	
		T9325	█	█	█		□		●	+	.016	.006	.008	.016	.079	
		T8315	█	█	█		□		●	+	.016	.003	.008	.016	.079	
		T8330	█	█	█		□		●	+	.016	.003	.008	.016	.079	
	VBMT 222-FM	T7325	█	█			□		●	++	.031	.006	.010	.031	.098	
		T9315	█	█	█				●	++	.031	.006	.010	.031	.098	
		T9325	█	█	█		□		●	++	.031	.006	.010	.031	.098	
		T8330	█	█	█		□		●	++	.031	.004	.010	.031	.098	
	VBMT 330.5-FM	T7325	█	█			□		●	++	.008	.003	.004	.008	.079	
		T9315	█	█	█				●	++	.008	.003	.004	.008	.079	
T9325		█	█	█		□		●	+	.008	.003	.004	.008	.079		
T8330		█	█	█		□		●	+	.008	.003	.004	.008	.079		
  	VBMT 331-FM	T5315	█	□	█				●	+	.016	.004	.008	.016	.079	
		T7325	█	█			□		●	++	.016	.006	.008	.016	.079	
		T7335	█	█			□		●	++	.016	.006	.008	.016	.079	
		T9315	█	█	█				●	++	.016	.006	.008	.016	.079	
	VBMT 332-FM	T9325	█	█	█		□		●	+	.016	.006	.008	.016	.079	
		T8315	█	█	█		□		●	+	.016	.004	.008	.016	.079	
		T8330	█	█	█		□		●	+	.016	.004	.008	.016	.079	
		T5315	█	□	█				●	+	.031	.006	.012	.031	.098	
  	VBMT 332-FM	T7325	█	█			□		●	++	.031	.006	.012	.031	.098	
		T7335	█	█			□		●	++	.031	.006	.012	.031	.098	
		T9315	█	█	█				●	++	.031	.006	.012	.031	.098	
		T9325	█	█	█		□		●	++	.031	.006	.012	.031	.098	
	VBMT 333-FM	T8315	█	█	█		□		●	+	.031	.006	.012	.031	.098	
		T8330	█	█	█		□		●	++	.031	.006	.012	.031	.098	
		T7325	█	█			□		●	++	.047	.008	.016	.047	.118	
		T9315	█	█	█				●	++	.047	.008	.016	.047	.118	
  	VBMT 331-FM2	T9325	█	█	█		□		●	++	.047	.008	.016	.047	.118	
		T8330	█	█	█		□		●	++	.047	.008	.016	.047	.118	
		T7325	█	█			□		●	++	.016	.002	.008	.008	.110	
		T9315	█	█	█			□		●	++	.016	.002	.008	.008	.110
	VBMT 332-FM2	T9325	█	█	█		□		●	+	.016	.002	.008	.008	.110	
		T9335	█	█			□		●	++	.016	.002	.008	.008	.110	
		T6310	█	█	█		□	□		●	+	.016	.002	.008	.008	.110
		T8330	█	█	█		□	□		●	+	.016	.002	.008	.008	.110
VBMT 333-FM2	T7325	█	█			□		●	++	.031	.004	.010	.024	.118		
	T9315	█	█	█			□		●	++	.031	.004	.010	.024	.118	
	T9325	█	█	█		□		●	++	.031	.004	.010	.024	.118		
	T9335	█	█			□		●	++	.031	.004	.010	.024	.118		
VBMT 333-FM2	T6310	█	█	█		□	□		●	++	.031	.004	.010	.024	.118	
	T8330	█	█	█		□	□		●	++	.031	.004	.010	.024	.118	
	T9315	█	█	█			□		●	++	.047	.005	.012	.039	.118	
	T9325	█	█	█		□		●	++	.047	.005	.012	.039	.118		



i	ANSI		P	M	K	N	S	H			r <sub>c</sub>	f <sub>min</sub>	f <sub>max</sub>	a <sub>p min</sub>	a <sub>p max</sub>	1				
																				?
VBMT 331-RM	T5305		<input type="checkbox"/>	<input type="checkbox"/>	<input checked="" type="checkbox"/>	<input type="checkbox"/>	<input type="checkbox"/>	<input type="checkbox"/>	<input checked="" type="checkbox"/>	+	.016	.004	.008	.031	.142					
	T5315		<input checked="" type="checkbox"/>	<input type="checkbox"/>	<input checked="" type="checkbox"/>	<input type="checkbox"/>	<input type="checkbox"/>	<input type="checkbox"/>	<input checked="" type="checkbox"/>	+	.016	.004	.008	.031	.142					
	T7335		<input checked="" type="checkbox"/>	<input checked="" type="checkbox"/>	<input type="checkbox"/>	<input type="checkbox"/>	<input type="checkbox"/>	<input type="checkbox"/>	<input checked="" type="checkbox"/>	++	.016	.006	.008	.031	.142					
	T9315		<input checked="" type="checkbox"/>	<input type="checkbox"/>	<input checked="" type="checkbox"/>	<input type="checkbox"/>	<input type="checkbox"/>	<input type="checkbox"/>	<input type="checkbox"/>	<input checked="" type="checkbox"/>	++	.016	.006	.008	.031	.142				
	T9325		<input checked="" type="checkbox"/>	<input checked="" type="checkbox"/>	<input checked="" type="checkbox"/>	<input type="checkbox"/>	<input type="checkbox"/>	<input type="checkbox"/>	<input type="checkbox"/>	<input checked="" type="checkbox"/>	+	.016	.006	.008	.031	.142				
	T8330		<input checked="" type="checkbox"/>	<input checked="" type="checkbox"/>	<input checked="" type="checkbox"/>	<input type="checkbox"/>	<input checked="" type="checkbox"/>	<input type="checkbox"/>	<input type="checkbox"/>	<input checked="" type="checkbox"/>	+	.016	.004	.008	.031	.142				
VBMT 332-RM	T5305		<input type="checkbox"/>	<input type="checkbox"/>	<input checked="" type="checkbox"/>	<input type="checkbox"/>	<input type="checkbox"/>	<input type="checkbox"/>	<input checked="" type="checkbox"/>	+	.031	.004	.014	.039	.142					
	T5315		<input checked="" type="checkbox"/>	<input type="checkbox"/>	<input checked="" type="checkbox"/>	<input type="checkbox"/>	<input type="checkbox"/>	<input type="checkbox"/>	<input checked="" type="checkbox"/>	++	.031	.004	.014	.039	.142					
	T7335		<input checked="" type="checkbox"/>	<input checked="" type="checkbox"/>	<input type="checkbox"/>	<input type="checkbox"/>	<input type="checkbox"/>	<input type="checkbox"/>	<input checked="" type="checkbox"/>	+++	.031	.006	.014	.039	.142					
	T9315		<input checked="" type="checkbox"/>	<input type="checkbox"/>	<input checked="" type="checkbox"/>	<input type="checkbox"/>	<input type="checkbox"/>	<input type="checkbox"/>	<input type="checkbox"/>	<input checked="" type="checkbox"/>	++	.031	.006	.014	.039	.142				
	T9325		<input checked="" type="checkbox"/>	<input checked="" type="checkbox"/>	<input checked="" type="checkbox"/>	<input type="checkbox"/>	<input type="checkbox"/>	<input type="checkbox"/>	<input type="checkbox"/>	<input checked="" type="checkbox"/>	++	.031	.006	.014	.039	.142				
	T8330		<input checked="" type="checkbox"/>	<input checked="" type="checkbox"/>	<input checked="" type="checkbox"/>	<input type="checkbox"/>	<input checked="" type="checkbox"/>	<input type="checkbox"/>	<input type="checkbox"/>	<input checked="" type="checkbox"/>	++	.031	.004	.014	.039	.142				
VBMT 333-RM	T7335		<input checked="" type="checkbox"/>	<input checked="" type="checkbox"/>	<input type="checkbox"/>	<input type="checkbox"/>	<input type="checkbox"/>	<input type="checkbox"/>	<input checked="" type="checkbox"/>	+++	.047	.006	.016	.047	.142					
	T9315		<input checked="" type="checkbox"/>	<input type="checkbox"/>	<input checked="" type="checkbox"/>	<input type="checkbox"/>	<input type="checkbox"/>	<input type="checkbox"/>	<input checked="" type="checkbox"/>	++	.047	.006	.016	.047	.142					
	T9325		<input checked="" type="checkbox"/>	<input checked="" type="checkbox"/>	<input checked="" type="checkbox"/>	<input type="checkbox"/>	<input type="checkbox"/>	<input type="checkbox"/>	<input checked="" type="checkbox"/>	++	.047	.006	.016	.047	.142					
VBMT 21.50.5-UR	TT310		<input checked="" type="checkbox"/>	<input checked="" type="checkbox"/>	<input type="checkbox"/>	<input type="checkbox"/>	<input type="checkbox"/>	<input type="checkbox"/>	<input checked="" type="checkbox"/>	+/-	.008	.003	.004	.008	.079					
	VBMT 21.51-UR	T7325		<input checked="" type="checkbox"/>	<input checked="" type="checkbox"/>	<input type="checkbox"/>	<input type="checkbox"/>	<input type="checkbox"/>	<input type="checkbox"/>	<input checked="" type="checkbox"/>	++	.016	.006	.008	.016	.079				
		T9315		<input checked="" type="checkbox"/>	<input type="checkbox"/>	<input checked="" type="checkbox"/>	<input type="checkbox"/>	<input type="checkbox"/>	<input type="checkbox"/>	<input checked="" type="checkbox"/>	++	.016	.006	.008	.016	.079				
T9325			<input checked="" type="checkbox"/>	<input checked="" type="checkbox"/>	<input checked="" type="checkbox"/>	<input type="checkbox"/>	<input type="checkbox"/>	<input type="checkbox"/>	<input checked="" type="checkbox"/>	+	.016	.006	.008	.016	.079					
T8330			<input checked="" type="checkbox"/>	<input checked="" type="checkbox"/>	<input checked="" type="checkbox"/>	<input type="checkbox"/>	<input type="checkbox"/>	<input type="checkbox"/>	<input checked="" type="checkbox"/>	+	.016	.003	.008	.016	.079					
TT310			<input checked="" type="checkbox"/>	<input checked="" type="checkbox"/>	<input type="checkbox"/>	<input type="checkbox"/>	<input type="checkbox"/>	<input type="checkbox"/>	<input checked="" type="checkbox"/>	+/-	.016	.003	.008	.016	.079					
VBMT 330.5-UR	T8330		<input checked="" type="checkbox"/>	<input checked="" type="checkbox"/>	<input checked="" type="checkbox"/>	<input type="checkbox"/>	<input type="checkbox"/>	<input type="checkbox"/>	<input checked="" type="checkbox"/>	+	.008	.002	.004	.008	.079					
VBMT 331-UR	T5315		<input checked="" type="checkbox"/>	<input type="checkbox"/>	<input checked="" type="checkbox"/>	<input type="checkbox"/>	<input type="checkbox"/>	<input type="checkbox"/>	<input checked="" type="checkbox"/>	+	.016	.004	.008	.016	.079					
	T7325		<input checked="" type="checkbox"/>	<input checked="" type="checkbox"/>	<input type="checkbox"/>	<input type="checkbox"/>	<input type="checkbox"/>	<input type="checkbox"/>	<input checked="" type="checkbox"/>	++	.016	.006	.008	.016	.079					
	T9310		<input checked="" type="checkbox"/>	<input type="checkbox"/>	<input checked="" type="checkbox"/>	<input type="checkbox"/>	<input type="checkbox"/>	<input type="checkbox"/>	<input checked="" type="checkbox"/>	+	.016	.006	.008	.016	.079					
	T9315		<input checked="" type="checkbox"/>	<input type="checkbox"/>	<input checked="" type="checkbox"/>	<input type="checkbox"/>	<input type="checkbox"/>	<input type="checkbox"/>	<input checked="" type="checkbox"/>	++	.016	.006	.008	.016	.079					
	T9325		<input checked="" type="checkbox"/>	<input checked="" type="checkbox"/>	<input checked="" type="checkbox"/>	<input type="checkbox"/>	<input type="checkbox"/>	<input type="checkbox"/>	<input checked="" type="checkbox"/>	+	.016	.006	.008	.016	.079					
	T8330		<input checked="" type="checkbox"/>	<input checked="" type="checkbox"/>	<input checked="" type="checkbox"/>	<input type="checkbox"/>	<input type="checkbox"/>	<input type="checkbox"/>	<input checked="" type="checkbox"/>	+	.016	.003	.008	.016	.079					
VBMT 332-UR	TT310		<input checked="" type="checkbox"/>	<input checked="" type="checkbox"/>	<input type="checkbox"/>	<input type="checkbox"/>	<input type="checkbox"/>	<input type="checkbox"/>	<input checked="" type="checkbox"/>	+/-	.016	.003	.008	.016	.079					
	T5315		<input checked="" type="checkbox"/>	<input type="checkbox"/>	<input checked="" type="checkbox"/>	<input type="checkbox"/>	<input type="checkbox"/>	<input type="checkbox"/>	<input checked="" type="checkbox"/>	+	.031	.004	.012	.031	.118					
	T7325		<input checked="" type="checkbox"/>	<input checked="" type="checkbox"/>	<input type="checkbox"/>	<input type="checkbox"/>	<input type="checkbox"/>	<input type="checkbox"/>	<input checked="" type="checkbox"/>	++	.031	.006	.012	.031	.118					
	T9310		<input checked="" type="checkbox"/>	<input type="checkbox"/>	<input checked="" type="checkbox"/>	<input type="checkbox"/>	<input type="checkbox"/>	<input type="checkbox"/>	<input checked="" type="checkbox"/>	+	.031	.006	.012	.031	.118					
	T9315		<input checked="" type="checkbox"/>	<input type="checkbox"/>	<input checked="" type="checkbox"/>	<input type="checkbox"/>	<input type="checkbox"/>	<input type="checkbox"/>	<input checked="" type="checkbox"/>	++	.031	.006	.012	.031	.118					
	T9325		<input checked="" type="checkbox"/>	<input checked="" type="checkbox"/>	<input checked="" type="checkbox"/>	<input type="checkbox"/>	<input type="checkbox"/>	<input type="checkbox"/>	<input checked="" type="checkbox"/>	++	.031	.006	.012	.031	.118					
VBMT 333-UR	T8330		<input checked="" type="checkbox"/>	<input checked="" type="checkbox"/>	<input checked="" type="checkbox"/>	<input type="checkbox"/>	<input type="checkbox"/>	<input type="checkbox"/>	<input checked="" type="checkbox"/>	+	.031	.003	.012	.031	.118					
	TT310		<input checked="" type="checkbox"/>	<input checked="" type="checkbox"/>	<input type="checkbox"/>	<input type="checkbox"/>	<input type="checkbox"/>	<input type="checkbox"/>	<input checked="" type="checkbox"/>	+/-	.031	.003	.012	.031	.118					
	VBMT 333-UR	T7325		<input checked="" type="checkbox"/>	<input checked="" type="checkbox"/>	<input type="checkbox"/>	<input type="checkbox"/>	<input type="checkbox"/>	<input type="checkbox"/>	<input checked="" type="checkbox"/>	++	.047	.006	.012	.047	.118				
		T9310		<input checked="" type="checkbox"/>	<input type="checkbox"/>	<input checked="" type="checkbox"/>	<input type="checkbox"/>	<input type="checkbox"/>	<input type="checkbox"/>	<input checked="" type="checkbox"/>	+	.047	.006	.012	.047	.118				
		T9315		<input checked="" type="checkbox"/>	<input type="checkbox"/>	<input checked="" type="checkbox"/>	<input type="checkbox"/>	<input type="checkbox"/>	<input type="checkbox"/>	<input checked="" type="checkbox"/>	++	.047	.006	.012	.047	.118				
		T9325		<input checked="" type="checkbox"/>	<input checked="" type="checkbox"/>	<input checked="" type="checkbox"/>	<input type="checkbox"/>	<input type="checkbox"/>	<input type="checkbox"/>	<input checked="" type="checkbox"/>	++	.047	.006	.012	.047	.118				
T8330			<input checked="" type="checkbox"/>	<input checked="" type="checkbox"/>	<input checked="" type="checkbox"/>	<input type="checkbox"/>	<input type="checkbox"/>	<input type="checkbox"/>	<input checked="" type="checkbox"/>	+	.047	.003	.012	.047	.118					

## VCGT

	d	d <sub>1</sub>	l	s
1.21.5	.156	.087	.272	.094
2.52	.313	.134	.543	.125
2.52-AL	.313	.134	.543	.135
2.52-SF3	.313	.134	.543	.135
21.5-SF3	.250	.110	.437	.102
22	.250	.110	.437	.125
33	.375	.173	.654	.187
33-SF3	.375	.173	.654	.197



For tools see pages: T210-T212, T225-T226

		ANSI		P	M	K	N	S	H			r <sub>c</sub>	f <sub>min</sub>	f <sub>max</sub>	a <sub>p min</sub>	a <sub>p max</sub>
		VCGT 1.21.50.5-AL	T8310				☑			●	+	.008	.002	.004	.012	.069
		VCGT 1.21.50.5F-AL	HF7				☑			●	+	.008	.002	.004	.012	.069
		VCGT 1.21.51-AL	T8310				☑			●	+	.016	.002	.008	.016	.069
		VCGT 220.5F-AL	T0315				☑			●	+	.008	.002	.004	.012	.108
			HF7				☑			●	+	.008	.002	.004	.012	.108
		VCGT 221F-AL	T0315				☑			●	+	.016	.004	.008	.016	.108
			HF7				☑			●	+	.016	.004	.008	.016	.108
		VCGT 2.520.5-AL	T8310				☑			●	+	.008	.002	.004	.012	.128
		VCGT 2.520.5F-AL	T0315				☑			●	+	.008	.002	.004	.012	.128
			HF7				☑			●	+	.008	.002	.004	.012	.128
		VCGT 2.521-AL	T8310				☑			●	+	.016	.002	.008	.016	.128
		VCGT 2.521F-AL	T0315				☑			●	+	.016	.002	.008	.016	.128
			HF7				☑			●	+	.016	.002	.008	.016	.128
		VCGT 2.522-AL	T8310				☑			●	++	.031	.004	.014	.031	.128
		VCGT 2.522F-AL	T0315				☑			●	+	.031	.004	.014	.031	.128
			HF7				☑			●	+	.031	.004	.014	.031	.128
		VCGT 330.5F-AL	T0315				☑			●	+	.008	.002	.004	.012	.157
			HF7				☑			●	+	.008	.002	.004	.012	.157
		VCGT 331F-AL	T0315				☑			●	+	.016	.004	.008	.016	.157
			HF7				☑			●	+	.016	.004	.008	.016	.157
		VCGT 332F-AL	T0315				☑			●	++	.031	.006	.016	.031	.157
			HF7				☑			●	++	.031	.006	.016	.031	.157
		VCGT 333F-AL	T0315				☑			●	++	.047	.006	.024	.047	.157
			HF7				☑			●	++	.047	.006	.024	.047	.157
		VCGT 1.21.50.5-FF2	T8315	☑	☑	☑				●	+	.008	.001	.004	.006	.059
			T8330	☑	☑	☑				●	+	.008	.001	.004	.006	.059
		VCGT 1.21.51-FF2	T8315	☑	☑	☑				●	+	.016	.002	.008	.012	.069
			T8330	☑	☑	☑				●	+	.016	.002	.008	.012	.069
		VCGT 2.520.5-FF2	T5315	☑	☐	☑				●	+	.008	.002	.004	.006	.059
			T7325	☑	☑					●	++	.008	.002	.004	.006	.059
			T9315	☑	☑	☑				●	++	.008	.002	.004	.006	.059
			T9325	☑	☑	☑				●	+	.008	.002	.004	.006	.059
			T8330	☑	☑	☑				●	+	.008	.002	.004	.006	.059
			TT010	☑	☑					●	+/-	.008	.002	.004	.006	.059
		VCGT 2.521-FF2	T5315	☑	☐	☑				●	+	.016	.002	.008	.012	.098
			T7325	☑	☑					●	++	.016	.002	.008	.012	.098
			T9315	☑	☑	☑				●	++	.016	.002	.008	.012	.098
			T9325	☑	☑	☑				●	+	.016	.002	.008	.012	.098
			T8330	☑	☑	☑				●	+	.016	.002	.008	.012	.098
			TT010	☑	☑					●	+/-	.016	.002	.008	.012	.098
		VCGT 2.522-FF2	T7325	☑	☑					●	++	.031	.003	.011	.024	.118
			T9315	☑	☑	☑				●	++	.031	.003	.011	.024	.118
			T9325	☑	☑	☑				●	++	.031	.003	.011	.024	.118
			TT010	☑	☑					●	+/-	.031	.003	.011	.024	.118

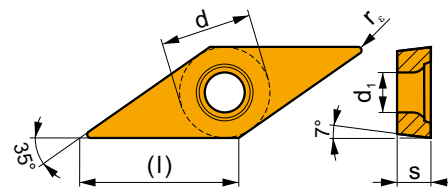
i	ANSI		P	M	K	N	S	H			r <sub>c</sub>	f <sub>min</sub>	f <sub>max</sub>	a <sub>p min</sub>	a <sub>p max</sub>
  	VCGT 2.522-FM2	T9325	■	■	■		□		●	++	.031	.004	.015	.024	.128
		T8330	■	■	■		□	□	●	++	.031	.004	.015	.024	.128
		T7325	■	■					●	++	.008	.002	.004	.008	.128
		T7335	■	■					●	++	.008	.002	.004	.008	.128
		T9315*	■	■	■				●	++	.008	.002	.004	.008	.128
		T9325	■	■	■				●	+	.008	.002	.004	.008	.128
		T9335	■	■			■		●	++	.008	.002	.004	.008	.128
		H07	■	■	■		■		●	+	.008	.002	.004	.008	.128
		TT010	■	■					●	+/-	.008	.002	.004	.008	.128
	  	VCGT 2.521-NF2	T5315	■	□	■				●	+	.016	.004	.006	.008
T7325			■	■					●	++	.016	.004	.006	.008	.128
		T7335	■	■					●	++	.016	.004	.006	.008	.128
		T9315	■	■	■				●	++	.016	.004	.006	.008	.128
		T9325	■	■	■				●	+	.016	.004	.006	.008	.128
		T9335	■	■			■		●	++	.016	.004	.006	.008	.128
		T6310	■	■	■		■		●	+	.016	.004	.006	.008	.128
		H07	■	■	■		■		●	+	.016	.004	.006	.008	.128
		TT010	■	■					●	+/-	.016	.004	.006	.008	.128
		VCGT 2.522-NF2	T5315	■	□	■				●	++	.031	.006	.015	.024
	T7325	■	■					●	++	.031	.006	.015	.024	.128	
	T7335	■	■					●	+++	.031	.006	.015	.024	.128	
	T9315	■	■	■				●	++	.031	.006	.015	.024	.128	
	T9325	■	■	■				●	++	.031	.006	.015	.024	.128	
	T9335	■	■			■		●	+++	.031	.006	.015	.024	.128	
	TT010	■	■					●	+/-	.031	.006	.015	.024	.128	
	VCGT 2.520.2-SF2	T6310		■		■	■		●	+	.004	.001	.004	.004	.098
		T8310		■		■	■		●	+	.004	.001	.004	.004	.098
		H07		■		■	■		●	+	.004	.001	.004	.004	.098
	VCGT 2.520.5-SF2	T6310		■		■	■		●	+	.008	.001	.004	.008	.098
		T8310		■		■	■		●	+	.008	.001	.004	.008	.098
		H07		■		■	■		●	+	.008	.001	.004	.008	.098
	VCGT 2.521-SF2	HF7		□		■	□		●	+	.008	.001	.004	.008	.098
		T6310		■		■	■		●	+	.016	.002	.008	.008	.098
		T8310		■		■	■		●	+	.016	.002	.008	.008	.098
		H07		■		■	■		●	+	.016	.002	.008	.008	.098
VCGT 2.522-SF2	HF7		□		■	□		●	+	.016	.002	.008	.008	.098	
	T6310		■		■	■		●	++	.031	.003	.011	.020	.098	
	T8310		■		■	■		●	++	.031	.003	.011	.020	.098	
	H07		■		■	■		●	++	.031	.003	.011	.020	.098	
VCGT 1.21.50.5-SF3	T6310		■		■	■		●	+	.008	.001	.004	.008	.063	
	H07		■		■	■		●	+	.008	.001	.004	.008	.063	
	T6310		■		■	■		●	+	.016	.001	.008	.008	.069	
VCGT 21.50.5-SF3	T6310		■		■	■		●	+	.008	.001	.004	.008	.063	
	T8315		■		■	□		●	+	.008	.001	.004	.008	.063	
	H07		■		■	■		●	+	.008	.001	.004	.008	.063	
VCGT 21.51-SF3	T6310		■		■	■		●	+	.016	.002	.008	.008	.079	
	T8315		■		■	□		●	+	.016	.002	.008	.008	.079	
	H07		■		■	■		●	+	.016	.002	.008	.008	.079	
VCGT 2.520.5-SF3	T6310		■		■	■		●	+	.008	.001	.004	.008	.063	
	T8315		■		■	□		●	+	.008	.001	.004	.008	.063	
	H07		■		■	■		●	+	.008	.001	.004	.008	.063	
VCGT 2.521-SF3	T6310		■		■	■		●	+	.016	.001	.008	.008	.087	
	T8315		■		■	□		●	+	.016	.001	.008	.008	.087	
	H07		■		■	■		●	+	.016	.001	.008	.008	.087	

\* Non-stocked item

i	ANSI		P	M	K	N	S	H			$r_c$	$f_{min}$	$f_{max}$	$a_{p min}$	$a_{p max}$
     	VCGT 2.522-SF3	T6310		■		▣	■		●	+	.031	.003	.012	.024	.118
		T8315		■		▣	□		●	+	.031	.003	.012	.024	.118
		H07		▣		▣	■		●	+	.031	.003	.012	.024	.118
	VCGT 331-SF3	T6310		■		▣	■		●	+	.016	.001	.008	.008	.087
		T8315		■		▣	□		●	+	.016	.001	.008	.008	.087
		H07		▣		▣	■		●	+	.016	.001	.008	.008	.087
	VCGT 332-SF3	T6310		■		▣	■		●	+	.031	.003	.012	.024	.118
		T8315		■		▣	□		●	+	.031	.003	.012	.024	.118
		H07		▣		▣	■		●	+	.031	.003	.012	.024	.118
VCGT 333-SF3	T6310		■		▣	■		●	++	.047	.004	.014	.039	.126	
	H07		▣		▣	■		●	++	.047	.004	.014	.039	.126	

## VCGW

	d	d <sub>1</sub>	l	s
2.52	.313	.134	.543	.125

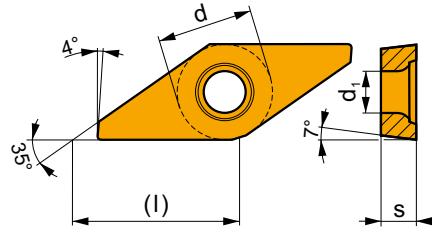


For tools see pages: T210-T212, T225-T226

i	ANSI		P	M	K	N	S	H			$r_c$	$f_{min}$	$f_{max}$	$a_{p min}$	$a_{p max}$
   	VCGW 2.520.5	T5305	□		■			▣	●	+	.008	.003	.004	.016	.128
	VCGW 2.521	T5305	□		■			▣	●	+	.016	.004	.008	.016	.128
	VCGW 2.522	T5305	□		■			▣	●	++	.031	.004	.016	.031	.128

# VCGX

	d	d <sub>1</sub>	l	s
2.52	.313	.134	.543	.125



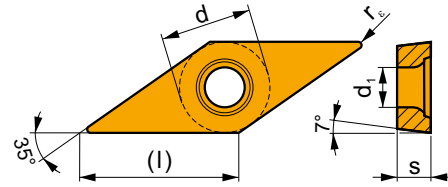
For tools see pages: T210-T212, T225-T226

		ANSI		P	M	K	N	S	H			r <sub>e</sub>	f <sub>min</sub>	f <sub>max</sub>	a <sub>p min</sub>	a <sub>p max</sub>
		VCGX 2.520FR-FF2	T6310	█	█	█				●	+	.000	.002	.003	.008	.059
			TT010	█	█					●	+/-	.000	.002	.003	.008	.059
		VCGX 2.520.2FR-FF2	T6310	█	█	█				●	+	.004	.002	.003	.008	.059
			TT010	█	█					●	+/-	.004	.002	.003	.008	.059
		VCGX 2.520FL-FF2	T6310	█	█	█				●	+	.000	.002	.003	.008	.059
			TT010	█	█					●	+/-	.000	.002	.003	.008	.059



## VCMT

	d	d <sub>1</sub>	l	s
22	.250	.110	.437	.125
33	.375	.173	.654	.187

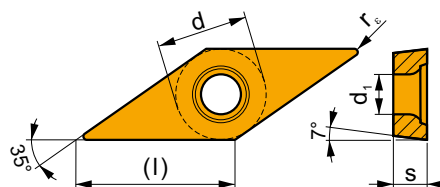


For tools see pages: T210-T212, T225-T226

i	ANSI	Material	P	M	K	N	S	H	?	Drop	r <sub>c</sub>	f <sub>min</sub>	f <sub>max</sub>	a <sub>p min</sub>	a <sub>p max</sub>
	VCMT 331-FM	T7325	█	█					●	++	.016	.006	.008	.012	.079
		T9315	█	█	█				●	++	.016	.006	.008	.012	.079
		T9325	█	█	█				●	+	.016	.006	.008	.012	.079
		T8330	█	█	█				●	+	.016	.004	.008	.012	.079
	VCMT 332-FM	T7325	█	█					●	++	.031	.006	.012	.020	.098
		T9315	█	█	█				●	++	.031	.006	.012	.020	.098
		T9325	█	█	█				●	++	.031	.006	.012	.020	.098
		T8330	█	█	█				●	++	.031	.006	.012	.020	.098
	VCMT 221-UR	T7325	█	█					●	++	.016	.006	.008	.016	.079
		T9315	█	█	█				●	++	.016	.006	.008	.016	.079
		T9325	█	█	█				●	+	.016	.006	.008	.016	.079
		T8330	█	█	█				●	+	.016	.003	.008	.016	.079
VCMT 222-UR	T7325	█	█					●	++	.031	.006	.012	.031	.079	
	T9315	█	█	█				●	++	.031	.006	.012	.031	.079	
	T9325	█	█	█				●	++	.031	.006	.012	.031	.079	
	T8330	█	█	█				●	+	.031	.003	.012	.031	.079	
VCMT 331-UR	T7325	█	█					●	++	.016	.006	.008	.016	.079	
	T9315	█	█	█				●	++	.016	.006	.008	.016	.079	
	T9325	█	█	█				●	+	.016	.006	.008	.016	.079	
	T8330	█	█	█				●	+	.016	.003	.008	.016	.079	
VCMT 332-UR	T7325	█	█					●	++	.031	.006	.012	.031	.118	
	T9315	█	█	█				●	++	.031	.006	.012	.031	.118	
	T9325	█	█	█				●	++	.031	.006	.012	.031	.118	
	T8330	█	█	█				●	+	.031	.003	.012	.031	.118	

## VCMW

	d	d <sub>1</sub>	l	s
22	.250	.110	.437	.125
33	.375	.173	.654	.187

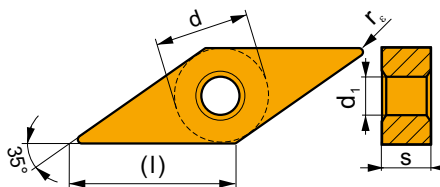


For tools see pages: T210-T212, T225-T226

i	ANSI	Image	P	M	K	N	S	H	?	Image	r <sub>e</sub>	f <sub>min</sub>	f <sub>max</sub>	a <sub>p min</sub>	a <sub>p max</sub>		
	VCMW 220.5		T5305	<input type="checkbox"/>	<input type="checkbox"/>	<input checked="" type="checkbox"/>	<input type="checkbox"/>	<input type="checkbox"/>	<input checked="" type="checkbox"/>	<input checked="" type="checkbox"/>	+	.008	.003	.004	.008	.094	
			T5315	<input checked="" type="checkbox"/>	<input type="checkbox"/>	<input type="checkbox"/>	<input type="checkbox"/>	<input type="checkbox"/>	<input type="checkbox"/>	<input checked="" type="checkbox"/>	<input checked="" type="checkbox"/>	+	.008	.003	.004	.008	.094
			T6310	<input checked="" type="checkbox"/>	<input type="checkbox"/>	<input checked="" type="checkbox"/>	<input type="checkbox"/>	<input type="checkbox"/>	<input type="checkbox"/>	<input checked="" type="checkbox"/>	<input checked="" type="checkbox"/>	<input checked="" type="checkbox"/>	+	.008	.002	.004	.008
	VCMW 221		T5305	<input type="checkbox"/>	<input type="checkbox"/>	<input checked="" type="checkbox"/>	<input type="checkbox"/>	<input type="checkbox"/>	<input checked="" type="checkbox"/>	<input checked="" type="checkbox"/>	+	.016	.004	.008	.016	.094	
			T5315	<input checked="" type="checkbox"/>	<input type="checkbox"/>	<input type="checkbox"/>	<input type="checkbox"/>	<input type="checkbox"/>	<input type="checkbox"/>	<input checked="" type="checkbox"/>	<input checked="" type="checkbox"/>	+	.016	.004	.008	.016	.094
			T6310	<input checked="" type="checkbox"/>	<input type="checkbox"/>	<input checked="" type="checkbox"/>	<input type="checkbox"/>	<input type="checkbox"/>	<input type="checkbox"/>	<input checked="" type="checkbox"/>	<input checked="" type="checkbox"/>	+	.016	.002	.008	.016	.094
	VCMW 331		T5305	<input type="checkbox"/>	<input type="checkbox"/>	<input checked="" type="checkbox"/>	<input type="checkbox"/>	<input type="checkbox"/>	<input checked="" type="checkbox"/>	<input checked="" type="checkbox"/>	+	.016	.004	.008	.016	.146	
			T5315	<input checked="" type="checkbox"/>	<input type="checkbox"/>	<input type="checkbox"/>	<input type="checkbox"/>	<input type="checkbox"/>	<input type="checkbox"/>	<input checked="" type="checkbox"/>	<input checked="" type="checkbox"/>	+	.016	.004	.008	.016	.146
			T6310	<input checked="" type="checkbox"/>	<input type="checkbox"/>	<input checked="" type="checkbox"/>	<input type="checkbox"/>	<input type="checkbox"/>	<input type="checkbox"/>	<input checked="" type="checkbox"/>	<input checked="" type="checkbox"/>	+	.016	.002	.008	.016	.146
	VCMW 332		T5305	<input type="checkbox"/>	<input type="checkbox"/>	<input checked="" type="checkbox"/>	<input type="checkbox"/>	<input type="checkbox"/>	<input checked="" type="checkbox"/>	<input checked="" type="checkbox"/>	++	.031	.004	.016	.031	.146	
			T5315	<input checked="" type="checkbox"/>	<input type="checkbox"/>	<input type="checkbox"/>	<input type="checkbox"/>	<input type="checkbox"/>	<input type="checkbox"/>	<input checked="" type="checkbox"/>	<input checked="" type="checkbox"/>	++	.031	.004	.016	.031	.146
			T6310	<input checked="" type="checkbox"/>	<input type="checkbox"/>	<input checked="" type="checkbox"/>	<input type="checkbox"/>	<input type="checkbox"/>	<input type="checkbox"/>	<input checked="" type="checkbox"/>	<input checked="" type="checkbox"/>	++	.031	.002	.016	.031	.146

## VNMG

	d	d <sub>1</sub>	l	s
33	.375	.150	.654	.187



For tools see pages: T199

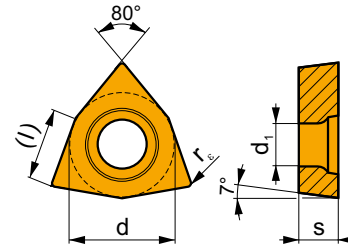
i	ANSI	Image	P	M	K	N	S	H	?	Image	r <sub>e</sub>	f <sub>min</sub>	f <sub>max</sub>	a <sub>p min</sub>	a <sub>p max</sub>		
	VNMG 331-FF		T7325	<input checked="" type="checkbox"/>	<input checked="" type="checkbox"/>	<input type="checkbox"/>	<input type="checkbox"/>	<input type="checkbox"/>	<input type="checkbox"/>	<input checked="" type="checkbox"/>	++	.016	.006	.008	.016	.059	
			T8315	<input checked="" type="checkbox"/>	<input checked="" type="checkbox"/>	<input checked="" type="checkbox"/>	<input type="checkbox"/>	<input type="checkbox"/>	<input type="checkbox"/>	<input checked="" type="checkbox"/>	<input checked="" type="checkbox"/>	+	.016	.002	.008	.016	.059
			T8330	<input checked="" type="checkbox"/>	<input checked="" type="checkbox"/>	<input checked="" type="checkbox"/>	<input type="checkbox"/>	<input type="checkbox"/>	<input type="checkbox"/>	<input checked="" type="checkbox"/>	<input checked="" type="checkbox"/>	<input checked="" type="checkbox"/>	+	.016	.002	.008	.016
			T7325	<input type="checkbox"/>	<input type="checkbox"/>	<input checked="" type="checkbox"/>	<input type="checkbox"/>	<input type="checkbox"/>	<input type="checkbox"/>	<input checked="" type="checkbox"/>	+	.016	.002	.008	.016	.059	
			T8315	<input checked="" type="checkbox"/>	<input type="checkbox"/>	<input type="checkbox"/>	<input type="checkbox"/>	<input type="checkbox"/>	<input type="checkbox"/>	<input checked="" type="checkbox"/>	<input checked="" type="checkbox"/>	+	.016	.002	.008	.016	.059
			T8330	<input checked="" type="checkbox"/>	<input type="checkbox"/>	<input checked="" type="checkbox"/>	<input type="checkbox"/>	<input type="checkbox"/>	<input type="checkbox"/>	<input checked="" type="checkbox"/>	<input checked="" type="checkbox"/>	+	.016	.002	.008	.016	.059

i	ANSI	Image	P	M	K	N	S	H	Image	Image	r <sub>c</sub>	f <sub>min</sub>	f <sub>max</sub>	a <sub>p min</sub>	a <sub>p max</sub>		
																?	
  	VNMG 331-FM	 .001 10° 20° .004	T7325	█	█			□	●	++	.016	.006	.008	.020	.118		
			T9310	█		█				●	+	.016	.006	.008	.020	.118	
			T9315	█		█					●	++	.016	.006	.008	.020	.118
			T9325	█	█	█			□		●	+	.016	.006	.008	.020	.118
			T8330	█	█	█			□		●	+	.016	.004	.008	.020	.118
	VNMG 332-FM	 .001 10° 20° .004	T7325	█	█			□		●	++	.031	.006	.014	.031	.118	
			T9310	█		█				●	++	.031	.006	.014	.031	.118	
			T9315	█		█					●	++	.031	.006	.014	.031	.118
			T9325	█	█	█			□		●	++	.031	.006	.014	.031	.118
			T8330	█	█	█			□		●	++	.031	.006	.014	.031	.118
	VNMG 333-FM	 .001 10° 20° .004	T7325	█	█			□		●	++	.047	.006	.018	.047	.118	
			T9315	█		█				●	++	.047	.006	.018	.047	.118	
T9325			█	█	█			□		●	++	.047	.006	.018	.047	.118	
T8330			█	█	█			□		●	++	.047	.006	.018	.047	.118	
T9315			█		█					●	++	.047	.006	.018	.047	.118	
  	VNMG 331-M	 .012 .004 10° 16° 5°	T5315	█	□	█		□	●	+	.016	.005	.008	.031	.118		
			T9315	█		█			□	●	++	.016	.006	.008	.031	.118	
			T9325	█	█	█					●	+	.016	.006	.008	.031	.118
			T9335	█	█						●	++	.016	.006	.008	.031	.118
			T5305	□		█			□		●	++	.031	.006	.016	.031	.118
	VNMG 332-M	 .012 .004 10° 16° 5°	T5315	█	□	█		□		●	++	.031	.006	.016	.031	.118	
			T9310	█		█				●	++	.031	.006	.016	.031	.118	
			T9315	█		█			□		●	++	.031	.006	.016	.031	.118
			T9325	█	█	█					●	++	.031	.006	.016	.031	.118
			T9335	█	█						●	+++	.031	.006	.016	.031	.118
	VNMG 333-M	 .012 .004 10° 16° 5°	T9325	█	█	█				●	++	.047	.007	.024	.047	.157	
			T9335	█	█					●	+++	.047	.007	.024	.047	.157	
  	VNMG 331-NF	 .006 25° 12°	T7325	█	█			█	●	++	.016	.006	.008	.016	.098		
			T7335	█	█			█	●	++	.016	.006	.008	.016	.098		
			T9315	█							●	++	.016	.006	.008	.016	.098
			T9325	█	█			█			●	+	.016	.006	.008	.016	.098
			T6310	█	█		□	█			●	+	.016	.004	.008	.016	.098
	VNMG 332-NF	 .006 25° 12°	T8315	█	█		□	□		●	+	.016	.004	.008	.016	.098	
			T8330	█	█		□	█		●	+	.016	.004	.008	.016	.098	
			T7325	█	█			█			●	++	.031	.006	.012	.031	.118
			T7335	█	█			█			●	++	.031	.006	.012	.031	.118
			T9315	█							●	++	.031	.006	.012	.031	.118
	VNMG 331-NM	 .01 30° 10°	T9325	█	█	□		□		●	+	.016	.006	.008	.020	.118	
			T8315	█	█	□	□	□		●	+	.016	.006	.008	.020	.118	
T8330			█	█	□	□	█		●	+	.016	.006	.008	.020	.118		
T7325			█	█			█			●	++	.031	.008	.016	.031	.118	
T7335			█	█						●	+++	.031	.008	.016	.031	.118	
VNMG 332-NM	 .01 30° 10°	T9325	█	█	□		□		●	++	.031	.008	.016	.031	.118		
		T8315	█	█	□	□	□		●	++	.031	.008	.016	.031	.118		
		T8330	█	█	□	□	█		●	++	.031	.008	.016	.031	.118		
		T7325	█	█			█			●	++	.031	.008	.016	.031	.118	
		T7335	█	█						●	+++	.031	.008	.016	.031	.118	
   	VNMG 331-NMR	 .012 22° 10°	T7325	█	█			█	●	++	.016	.007	.008	.016	.118		
			T7335	█	█			█	●	++	.016	.007	.008	.016	.118		
			T9325	█	█			█			●	+	.016	.007	.008	.016	.118
			T7325	█	█			█			●	++	.031	.008	.014	.031	.118
			T7335	█	█			█			●	++	.031	.008	.014	.031	.118
	VNMG 332-NMR	 .012 22° 10°	T9315	█						●	++	.031	.008	.014	.031	.118	
			T9325	█	█			█		●	++	.031	.008	.014	.031	.118	
			T9315	█							●	++	.031	.008	.014	.031	.118
			T9325	█	█			█			●	++	.031	.008	.014	.031	.118
			T7325	█	█			█			●	++	.047	.008	.016	.047	.118

i	ANSI		P	M	K	N	S	H			r <sub>c</sub>	f <sub>min</sub>	f <sub>max</sub>	a <sub>p min</sub>	a <sub>p max</sub>	
	VNMG 333-NMR		T9325	■	■		▣		●	++	.047	.008	.016	.047	.118	
			T8330	■	■		▣		●	++	.047	.008	.016	.047	.118	
	VNMG 331-SF		T7325	▣	■			■	●	++	.016	.006	.008	.016	.079	
			T9315	▣	■			□	●	++	.016	.006	.008	.016	.079	
	VNMG 332-SF		T9325	▣	■		▣		●	+	.016	.006	.008	.016	.079	
			T6310	▣	■		□	■	□	●	+	.016	.004	.008	.016	.079
	VNMG 333-SF		T8315	▣	■		□	□	●	+	.016	.004	.008	.016	.079	
			T8330	▣	■		□	▣	□	●	+	.016	.004	.008	.016	.079
	VNMG 331-SM		T9315	▣	■			□	●	++	.031	.006	.010	.031	.098	
			T9325	▣	■		▣		●	++	.031	.006	.010	.031	.098	
	VNMG 332-SM		T6310	▣	■		□	■	●	++	.031	.005	.010	.031	.098	
			T8315	▣	■		□	□	□	●	+	.031	.005	.010	.031	.098
	VNMG 333-SM		T8330	▣	■		□	▣	□	●	++	.031	.005	.010	.031	.098
			T7325	▣	■			■		●	++	.047	.006	.011	.047	.118
	VNMG 331-SM		T6310	▣	■		□	■	□	●	++	.047	.006	.011	.047	.118
			T7325	▣	■			■		●	++	.016	.006	.008	.016	.118
	VNMG 332-SM		T7335	▣	■			■	●	++	.016	.006	.008	.016	.118	
			T9315	■	■	▣			□	●	++	.016	.006	.008	.016	.118
	VNMG 333-SM		T9325	■	■	▣		▣	●	+	.016	.006	.008	.016	.118	
			T6310	▣	■	▣		■	□	●	+	.016	.006	.008	.016	.118
	VNMG 331-SM		T8330	■	■	▣		▣	□	●	+	.016	.006	.008	.016	.118
			T7325	▣	■			■		●	++	.031	.008	.012	.031	.138
	VNMG 332-SM		T9315	■	■	▣		□	●	++	.031	.008	.012	.031	.138	
			T9325	■	■	▣		▣		●	++	.031	.008	.012	.031	.138
	VNMG 333-SM		T6310	▣	■	▣		■	□	●	+	.031	.008	.012	.031	.138
			T8330	■	■	▣		▣	□	●	+	.031	.008	.012	.031	.138
	VNMG 333-SM		T6310	▣	■	▣		■	□	●	++	.047	.009	.016	.047	.138

## WCGT

	d	d <sub>1</sub>	l	s
1.21	.156	.087	.106	.063
32.5	.375	.173	.256	.156
43	.500	.217	.343	.187

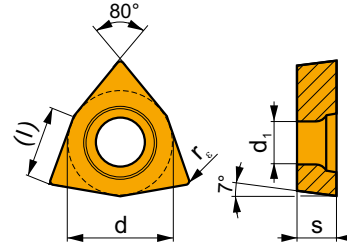


For tools see pages: T213, T227

		ANSI		P	M	K	N	S	H			r <sub>ε</sub>	f <sub>min</sub>	f <sub>max</sub>	a <sub>p min</sub>	a <sub>p max</sub>	
		WCGT 32.50.5F-AL	HF7				■			●	+/-	.008	.002	.006	.012	.118	
		WCGT 32.51F-AL	T0315				■				●	+	.016	.003	.012	.016	.138
			HF7				■				●	+	.016	.003	.012	.016	.138
		WCGT 32.52F-AL	T0315				■				●	+	.031	.003	.024	.031	.165
			HF7				■				●	+	.031	.003	.024	.031	.165
		WCGT 433F-AL	T0315				■				●	+	.047	.006	.024	.047	.220
		HF7				■				●	+	.047	.006	.024	.047	.220	
		WCGT 1.210.5-FF2	T8330	■	▣	■				●	+	.008	.002	.006	.008	.055	
			HF7		□	■					●	+/-	.008	.002	.006	.008	.055
			TT010	■	▣	■					●	+/-	.008	.002	.006	.008	.055
		WCGT 1.211-FF2	T8330	■	▣	■					●	+	.016	.002	.009	.012	.055
			HF7		□	■					●	+	.016	.002	.009	.012	.055
			TT010	■	▣						●	+/-	.016	.002	.009	.012	.055

# WCMT

	d	d <sub>1</sub>	l	s
32.5	.375	.173	.256	.156
43	.500	.217	.343	.187



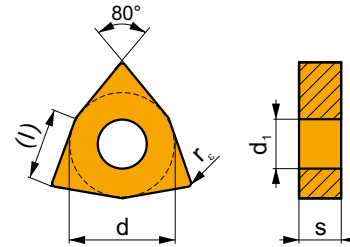
For tools see pages: T213, T227

i	ANSI	Material	P	M	K	N	S	H	Chip	Coolant	r <sub>c</sub>	f <sub>min</sub>	f <sub>max</sub>	a <sub>p min</sub>	a <sub>p max</sub>		
																1	2
	WCMT 32.51-FM	T7325	█	█					●	++	.016	.006	.012	.012	.118		
		T7335	█	█					●	++	.016	.006	.012	.012	.118		
		T9315	█		█					●	++	.016	.006	.012	.012	.118	
		T9325	█	█	█					●	+	.016	.006	.012	.012	.118	
		T8315	█	█	█					●	+	.016	.004	.012	.012	.118	
		T8330	█	█	█					●	+	.016	.004	.012	.012	.118	
	WCMT 32.52-FM	T7325	█	█						●	++	.031	.006	.014	.020	.118	
		T7335	█	█						●	++	.031	.006	.014	.020	.118	
		T9315	█		█					●	++	.031	.006	.014	.020	.118	
		T9325	█	█	█					●	+	.031	.006	.014	.020	.118	
		T8315	█	█	█					●	+	.031	.006	.014	.020	.118	
		T8330	█	█	█					●	+	.031	.006	.014	.020	.118	
WCMT 431-FM	T7325	█	█						●	++	.016	.006	.012	.016	.157		
	T9315	█		█					●	++	.016	.006	.012	.016	.157		
	T9325	█	█	█					●	+	.016	.006	.012	.016	.157		
	T8315	█	█	█					●	+	.016	.004	.012	.016	.157		
	T8330	█	█	█					●	+	.016	.004	.012	.016	.157		
	WCMT 432-FM	T7325	█	█						●	++	.031	.006	.014	.020	.157	
T7335		█	█						●	++	.031	.006	.014	.020	.157		
T9315		█		█					●	++	.031	.006	.014	.020	.157		
T9325		█	█	█					●	+	.031	.006	.014	.020	.157		
T8315		█	█	█					●	+	.031	.006	.014	.020	.157		
T8330		█	█	█					●	+	.031	.006	.014	.020	.157		
WCMT 433-FM	T9325	█	█	█					●	++	.047	.006	.018	.031	.157		
	T8330	█	█	█					●	++	.047	.006	.018	.031	.157		
	WCMT 32.52-RF	T7335	█	█					●	++	.031	.006	.016	.031	.157		
		WCMT 32.52-UR	T7325*	█	█						●	++	.031	.006	.012	.031	.118
			T9315	█		█					●	++	.031	.006	.012	.031	.118
	T9325		█	█	█					●	+	.031	.006	.012	.031	.118	

\* Non-stocked item

## WNMA

	d	d <sub>1</sub>	l	s
43	.500	.203	.343	.187

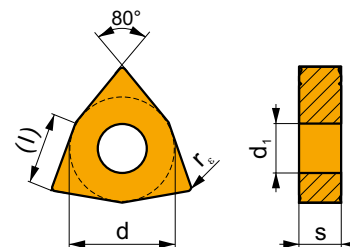


For tools see pages: T200, T218

		ANSI		P	M	K	N	S	H			r <sub>c</sub>	f <sub>min</sub>	f <sub>max</sub>	a <sub>p min</sub>	a <sub>p max</sub>		
  	 	WNMA 431	T5305	<input type="checkbox"/>	<input type="checkbox"/>	<input checked="" type="checkbox"/>	<input type="checkbox"/>	<input type="checkbox"/>	<input checked="" type="checkbox"/>	<input checked="" type="checkbox"/>	+	.016	.004	.012	.016	.173		
			T5315	<input checked="" type="checkbox"/>	<input type="checkbox"/>	<input checked="" type="checkbox"/>	<input type="checkbox"/>	<input type="checkbox"/>	<input type="checkbox"/>	<input type="checkbox"/>	<input checked="" type="checkbox"/>	<input checked="" type="checkbox"/>	+	.016	.004	.012	.016	.173
		WNMA 432	T5305	<input type="checkbox"/>	<input type="checkbox"/>	<input checked="" type="checkbox"/>	<input type="checkbox"/>	<input type="checkbox"/>	<input type="checkbox"/>	<input checked="" type="checkbox"/>	<input checked="" type="checkbox"/>	<input checked="" type="checkbox"/>	+	.031	.004	.024	.031	.173
			T5315	<input checked="" type="checkbox"/>	<input type="checkbox"/>	<input checked="" type="checkbox"/>	<input type="checkbox"/>	<input type="checkbox"/>	<input type="checkbox"/>	<input type="checkbox"/>	<input type="checkbox"/>	<input checked="" type="checkbox"/>	++	.031	.004	.024	.031	.173
		WNMA 433	T6310	<input checked="" type="checkbox"/>	<input type="checkbox"/>	<input checked="" type="checkbox"/>	<input type="checkbox"/>	<input type="checkbox"/>	<input type="checkbox"/>	<input checked="" type="checkbox"/>	<input checked="" type="checkbox"/>	<input checked="" type="checkbox"/>	++	.031	.002	.024	.031	.173
			T5305	<input type="checkbox"/>	<input type="checkbox"/>	<input checked="" type="checkbox"/>	<input type="checkbox"/>	<input type="checkbox"/>	<input type="checkbox"/>	<input checked="" type="checkbox"/>	<input checked="" type="checkbox"/>	<input checked="" type="checkbox"/>	+	.047	.004	.024	.047	.173
 	 	WNMA 432S	T5315	<input checked="" type="checkbox"/>	<input type="checkbox"/>	<input checked="" type="checkbox"/>	<input type="checkbox"/>	<input type="checkbox"/>	<input type="checkbox"/>	<input checked="" type="checkbox"/>	++	.047	.004	.024	.047	.173		
			T6310	<input checked="" type="checkbox"/>	<input type="checkbox"/>	<input checked="" type="checkbox"/>	<input type="checkbox"/>	<input type="checkbox"/>	<input type="checkbox"/>	<input checked="" type="checkbox"/>	<input checked="" type="checkbox"/>	<input checked="" type="checkbox"/>	++	.047	.002	.024	.047	.173
		T5305	<input type="checkbox"/>	<input type="checkbox"/>	<input checked="" type="checkbox"/>	<input type="checkbox"/>	<input type="checkbox"/>	<input type="checkbox"/>	<input checked="" type="checkbox"/>	<input checked="" type="checkbox"/>	<input checked="" type="checkbox"/>	+	.031	.004	.024	.031	.173	

## WNMG

	d	d <sub>1</sub>	l	s
32.5	.375	.150	.256	.156
33	.375	.150	.256	.187
43	.500	.203	.343	.187



For tools see pages: T200, T218

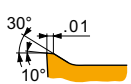
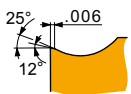
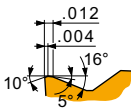
		ANSI		P	M	K	N	S	H			r <sub>c</sub>	f <sub>min</sub>	f <sub>max</sub>	a <sub>p min</sub>	a <sub>p max</sub>		
  	 	WNMG 330.5-FF	T8315	<input checked="" type="checkbox"/>	<input checked="" type="checkbox"/>	<input checked="" type="checkbox"/>	<input type="checkbox"/>	<input type="checkbox"/>	<input type="checkbox"/>	<input checked="" type="checkbox"/>	+/-	.008	.002	.006	.008	.059		
		WNMG 331-FF	T8315	<input checked="" type="checkbox"/>	<input checked="" type="checkbox"/>	<input checked="" type="checkbox"/>	<input type="checkbox"/>	<input type="checkbox"/>	<input type="checkbox"/>	<input type="checkbox"/>	<input checked="" type="checkbox"/>	+/-	.016	.002	.008	.016	.059	
		WNMG 431-FF	T7325	<input checked="" type="checkbox"/>	<input checked="" type="checkbox"/>	<input type="checkbox"/>	<input type="checkbox"/>	<input type="checkbox"/>	<input type="checkbox"/>	<input type="checkbox"/>	<input type="checkbox"/>	<input checked="" type="checkbox"/>	+	.016	.006	.008	.016	.059
			T8315	<input checked="" type="checkbox"/>	<input checked="" type="checkbox"/>	<input checked="" type="checkbox"/>	<input type="checkbox"/>	<input type="checkbox"/>	<input type="checkbox"/>	<input type="checkbox"/>	<input type="checkbox"/>	<input checked="" type="checkbox"/>	+/-	.016	.002	.008	.016	.059
		WNMG 432-FF	T7325	<input checked="" type="checkbox"/>	<input checked="" type="checkbox"/>	<input type="checkbox"/>	<input type="checkbox"/>	<input type="checkbox"/>	<input type="checkbox"/>	<input type="checkbox"/>	<input type="checkbox"/>	<input checked="" type="checkbox"/>	++	.031	.006	.010	.031	.059
			T8315	<input checked="" type="checkbox"/>	<input checked="" type="checkbox"/>	<input checked="" type="checkbox"/>	<input type="checkbox"/>	<input type="checkbox"/>	<input type="checkbox"/>	<input type="checkbox"/>	<input type="checkbox"/>	<input checked="" type="checkbox"/>	+	.031	.003	.010	.031	.059

i	ANSI	Image	P	M	K	N	S	H	Image	Image	r <sub>c</sub>	f <sub>min</sub>	f <sub>max</sub>	a <sub>p min</sub>	a <sub>p max</sub>	
1	WNMG 331-FM		T7325	█	█			□	●	++	.016	.006	.012	.020	.118	
			T9315	█	█	█			●	++	.016	.006	.012	.020	.118	
			T9325	█	█	█		□	●	+	.016	.006	.012	.020	.118	
			T8315	█	█	█		□	●	+	.016	.004	.012	.020	.118	
			T8330	█	█	█		□	●	+	.016	.004	.012	.020	.118	
			TT310	█	█				●	+/-	.016	.004	.012	.020	.118	
S	WNMG 332-FM		T7325	█	█			□	●	++	.031	.006	.014	.031	.118	
			T9315	█	█	█			●	++	.031	.006	.014	.031	.118	
			T9325	█	█	█		□	●	+	.031	.006	.014	.031	.118	
			T8330	█	█	█		□	●	+	.031	.004	.014	.031	.118	
S	WNMG 333-FM		T9315	█	█	█			●	++	.047	.006	.018	.047	.118	
			WNMG 32.51-FM	T7325	█	█			□	●	++	.016	.006	.012	.020	.118
S	WNMG 32.52-FM		T9325	█	█	█		□	●	+	.016	.006	.012	.020	.118	
			T8330	█	█	█		□	●	+	.016	.004	.012	.020	.118	
			T9325	█	█	█		□	●	+	.031	.006	.014	.031	.118	
S	WNMG 431-FM		T7325	█	█			□	●	++	.016	.006	.012	.020	.118	
			T7335	█	█			□	●	++	.016	.006	.012	.020	.118	
			T9310	█	█	█			●	+	.016	.006	.012	.020	.118	
			T9315	█	█	█			●	++	.016	.006	.012	.020	.118	
			T9325	█	█	█		□	●	+	.016	.006	.012	.020	.118	
			T8315	█	█	█		□	●	+	.016	.004	.012	.020	.118	
			T8330	█	█	█		□	●	+	.016	.004	.012	.020	.118	
			T8330	█	█	█		□	●	+	.016	.004	.012	.020	.118	
S	WNMG 432-FM		T7325	█	█			□	●	++	.031	.006	.018	.031	.118	
			T7335	█	█			□	●	++	.031	.006	.018	.031	.118	
			T9310	█	█	█			●	+	.031	.006	.018	.031	.118	
			T9315	█	█	█			●	++	.031	.006	.018	.031	.118	
			T9325	█	█	█		□	●	++	.031	.006	.018	.031	.118	
			T8315	█	█	█		□	●	+	.031	.006	.018	.031	.118	
			T8330	█	█	█		□	●	++	.031	.006	.018	.031	.118	
			T8330	█	█	█		□	●	++	.031	.006	.018	.031	.118	
S	WNMG 433-FM		T7325	█	█			□	●	++	.047	.006	.018	.047	.157	
			T7335	█	█			□	●	++	.047	.006	.018	.047	.157	
			T9310	█	█	█			●	+	.047	.006	.018	.047	.157	
			T9315	█	█	█			●	++	.047	.006	.018	.047	.157	
			T9325	█	█	█		□	●	++	.047	.006	.018	.047	.157	
			T8330	█	█	█		□	●	++	.047	.006	.018	.047	.157	
			T8330	█	█	█		□	●	++	.047	.006	.018	.047	.157	
			T8330	█	█	█		□	●	++	.047	.006	.018	.047	.157	
S	WNMG 432-KR		T5305	█	█	█		□	●	++	.031	.010	.024	.031	.217	
			T5315	█	█	█		□	●	++	.031	.010	.024	.031	.217	
			WNMG 433-KR	T5305	█	█	█		□	●	++	.047	.010	.024	.047	.217
			T5315	█	█	█		□	●	++	.047	.010	.024	.047	.217	
S	WNMG 331-M		T5315	█	█	█		□	●	+	.016	.006	.012	.031	.118	
			T9315	█	█	█		□	●	++	.016	.006	.012	.031	.118	
			T9325	█	█	█			●	+	.016	.006	.012	.031	.118	
			T9335	█	█	█			●	++	.016	.006	.012	.031	.118	
S	WNMG 332-M		T5315	█	█	█		□	●	++	.031	.007	.024	.031	.157	
			T9310	█	█	█			●	++	.031	.007	.024	.031	.157	
			T9315	█	█	█		□	●	++	.031	.007	.024	.031	.157	
			T9325	█	█	█			●	++	.031	.007	.024	.031	.157	
P	WNMG 431-M		T9335	█	█	█			●	+++	.031	.007	.024	.031	.157	
			T5315	█	█	█		□	●	+	.016	.006	.012	.031	.118	
			T9315	█	█	█		□	●	++	.016	.006	.012	.031	.118	
			T9325	█	█	█			●	+	.016	.006	.012	.031	.118	
P	WNMG 432-M		T9335	█	█	█			●	++	.016	.006	.012	.031	.118	
			T5305	█	█	█		□	●	+	.031	.007	.024	.031	.220	
			T5315	█	█	█		□	●	++	.031	.007	.024	.031	.220	

\* Non-stocked item



i	ANSI		P	M	K	N	S	H			r <sub>c</sub>	f <sub>min</sub>	f <sub>max</sub>	a <sub>p min</sub>	a <sub>p max</sub>	
	WNMG 432-M	T9310	■	■	■				●	++	.031	.007	.024	.031	.220	
		T9315	■	■	■			□	●	++	.031	.007	.024	.031	.220	
		T9325	■	■	■				●	++	.031	.007	.024	.031	.220	
		T9335	■	■	■				●	+++	.031	.007	.024	.031	.220	
		T8330	■	■	■			□	●	++	.031	.007	.024	.031	.220	
	WNMG 433-M	T5305	□	■	■				□	●	++	.047	.007	.031	.047	.220
		T5315	■	□	■				□	●	++	.047	.007	.031	.047	.220
		T9310	■	■	■					●	++	.047	.007	.031	.047	.220
		T9315	■	■	■				□	●	++	.047	.007	.031	.047	.220
		T9325	■	■	■					●	++	.047	.007	.031	.047	.220
	WNMG 331-NF	T7325	■	■			■		●	++	.016	.006	.012	.016	.118	
		T7335	■	■			■		●	++	.016	.004	.012	.016	.118	
		T9315	■	■						●	++	.016	.004	.012	.016	.118
		T9325	■	■			■			●	+	.016	.004	.012	.016	.118
		T6310	■	■		□	■			●	+	.016	.004	.012	.016	.118
	WNMG 332-NF	T7325	■	■			■			●	++	.031	.006	.012	.031	.118
		T9315	■	■						●	++	.031	.006	.012	.031	.118
		T9325	■	■			■			●	+	.031	.006	.012	.031	.118
		T6310	■	■		□	■			●	+	.031	.005	.012	.031	.118
	WNMG 431-NF	T7325	■	■			■			●	++	.016	.006	.012	.016	.118
T7335		■	■			■			●	++	.016	.006	.012	.016	.118	
T9315		■	■						●	++	.016	.006	.012	.016	.118	
T9325		■	■			■			●	+	.016	.006	.012	.016	.118	
T6310		■	■		□	■			●	+	.016	.005	.012	.016	.118	
T8315		■	■		□	□			●	+	.016	.005	.012	.016	.118	
T8330		■	■		□	■			●	+	.016	.005	.012	.016	.118	
HF7		□	□		□	□			●	+	.016	.005	.012	.016	.118	
WNMG 432-NF	T7325	■	■			■			●	++	.031	.006	.014	.031	.138	
	T7335	■	■			■			●	++	.031	.006	.014	.031	.138	
	T9315	■	■						●	++	.031	.006	.014	.031	.138	
	T9325	■	■			■			●	+	.031	.006	.014	.031	.138	
	T6310	■	■		□	■			●	+	.031	.006	.014	.031	.138	
	T8315	■	■		□	□			●	+	.031	.006	.014	.031	.138	
	T8330	■	■		□	■			●	+	.031	.006	.014	.031	.138	
	HF7	□	□		□	□			●	+	.031	.006	.014	.031	.138	
WNMG 433-NF	T7325	■	■			■			●	++	.047	.006	.014	.047	.157	
	T9315	■	■						●	++	.047	.006	.014	.047	.157	
	T9325	■	■			■			●	+	.047	.006	.014	.047	.157	
	T6310	■	■		□	■			●	+	.047	.006	.014	.047	.157	
WNMG 331-NM	T7325	■	■			■			●	++	.016	.006	.012	.020	.118	
	T7335	■	■			■			●	++	.016	.006	.012	.020	.118	
	T9325	■	■	□			□		●	+	.016	.006	.012	.020	.118	
	T8315*	■	■	□	□	□			●	+	.016	.006	.012	.020	.118	
	T8330	■	■	□	□	■			●	+	.016	.006	.012	.020	.118	
WNMG 332-NM	T7325	■	■			■			●	++	.031	.008	.016	.031	.118	
	T7335	■	■			■			●	++	.031	.008	.016	.031	.118	
	T9315	■	■	□					●	++	.031	.008	.016	.031	.118	
	T9325	■	■	□			□		●	+	.031	.008	.016	.031	.118	
	T8315	■	■	□	□	□			●	+	.031	.008	.016	.031	.118	
WNMG 333-NM	T7325	■	■			■			●	++	.047	.008	.020	.047	.138	
	T7335	■	■			■			●	++	.047	.008	.020	.047	.138	
	T9315	■	■	□					●	++	.047	.008	.020	.047	.138	

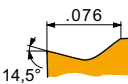
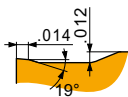


\* Non-stocked item

i	ANSI		P	M	K	N	S	H			r <sub>c</sub>	f <sub>min</sub>	f <sub>max</sub>	a <sub>p min</sub>	a <sub>p max</sub>					30°	
																				0.01	10°
	WNMG 333-NM	T9325	■	■	□		□		●	+	.047	.008	.020	.047	.138						
	WNMG 431-NM	T7325	■	■			■		●	++	.016	.006	.012	.020	.118						
		T7335	■	■					●	++	.016	.006	.012	.020	.118						
		T9315	■	■	□				●	++	.016	.006	.012	.020	.118						
		T9325	■	■	□		□		●	+	.016	.006	.012	.020	.118						
		T8315*	■	■	□	□	□		●	+	.016	.006	.012	.020	.118						
		T8330	■	■	□	□	■		●	+	.016	.006	.012	.020	.118						
	WNMG 432-NM	T7325	■	■			■		●	++	.031	.008	.020	.031	.118						
		T7335	■	■					●	++	.031	.008	.020	.031	.118						
		T9315	■	■	□				●	++	.031	.008	.020	.031	.118						
		T9325	■	■	□		□		●	+	.031	.008	.020	.031	.118						
		T8315	■	■	□	□	□		●	+	.031	.008	.020	.031	.118						
		T8330	■	■	□	□	■		●	+	.031	.008	.020	.031	.118						
	WNMG 433-NM	T7325	■	■			■		●	++	.047	.008	.020	.047	.138						
		T7335	■	■					●	++	.047	.008	.020	.047	.138						
		T9325	■	■	□		□		●	+	.047	.008	.020	.047	.138						
		T8315	■	■	□	□	□		●	+	.047	.008	.020	.047	.138						
	WNMG 331-NMR	T6310	■	■			■		●	+	.016	.008	.012	.016	.138						
		T7325	■	■			■		●	++	.016	.008	.012	.016	.138						
		T9325	■	■			■		●	+	.016	.008	.012	.016	.138						
	WNMG 332-NMR	T6310	■	■			■		●	+	.031	.008	.018	.031	.138						
		T7325	■	■			■		●	++	.031	.008	.018	.031	.138						
		T7335	■	■			■		●	++	.031	.008	.018	.031	.138						
		T9315	■	■					●	++	.031	.008	.018	.031	.138						
		T9325	■	■			■		●	++	.031	.008	.018	.031	.138						
	WNMG 431-NMR	T6310	■	■			■		●	+	.016	.008	.012	.016	.157						
		T7325	■	■			■		●	++	.016	.008	.012	.016	.157						
		T7335	■	■			■		●	++	.016	.008	.012	.016	.157						
		T9315	■	■					●	+	.016	.008	.012	.016	.157						
		T9325	■	■			■		●	+	.016	.008	.012	.016	.157						
		T8330	■	■			■		●	+	.016	.008	.012	.016	.157						
	WNMG 432-NMR	T6310	■	■			■		●	++	.031	.008	.022	.031	.197						
		T7325	■	■			■		●	++	.031	.008	.022	.031	.197						
		T7335	■	■			■		●	++	.031	.008	.022	.031	.197						
		T9315	■	■					●	++	.031	.008	.022	.031	.197						
		T9325	■	■			■		●	++	.031	.008	.022	.031	.197						
		T8330	■	■			■		●	++	.031	.008	.022	.031	.197						
	WNMG 433-NMR	T6310	■	■			■		●	++	.047	.009	.024	.047	.197						
		T7325	■	■			■		●	++	.047	.009	.024	.047	.197						
		T7335	■	■			■		●	+++	.047	.009	.024	.047	.197						
		T9315	■	■					●	++	.047	.009	.024	.047	.197						
		T9325	■	■			■		●	++	.047	.009	.024	.047	.197						
		T8330	■	■			■		●	++	.047	.009	.024	.047	.197						
	WNMG 431-NRM	T7325	■	■			□		●	++	.016	.006	.012	.016	.157						
		T7335*	■	■			□		●	++	.016	.006	.012	.016	.157						
		T9315*	■	■					●	++	.016	.006	.012	.016	.157						
	WNMG 432-NRM	T7325	■	■			□		●	++	.031	.009	.022	.031	.197						
		T7335	■	■			□		●	++	.031	.009	.022	.031	.197						
		T9315	■	■					●	++	.031	.009	.022	.031	.197						
	WNMG 433-NRM	T7325	■	■			□		●	++	.047	.010	.028	.047	.197						
		T7335	■	■			□		●	+++	.047	.010	.028	.047	.197						
		T9315	■	■					●	++	.047	.010	.028	.047	.197						
	WNMG 432-R	T5305	□	■	■		□		●	++	.031	.010	.024	.079	.220						
		T5315	■	□	■		□		●	++	.031	.010	.024	.079	.220						
		T9310	■	■	■		□		●	++	.031	.010	.024	.079	.220						
		T9315	■	■	■		□		●	++	.031	.010	.024	.079	.220						
		T9325	■	■	■				●	++	.031	.010	.024	.079	.220						
		T9335	■	■	■				●	+++	.031	.010	.024	.079	.220						

\* Non-stocked item

i	ANSI		Material Properties								r <sub>c</sub>	f <sub>min</sub>	f <sub>max</sub>	a <sub>p min</sub>	a <sub>p max</sub>			
			P	M	K	N	S	H										
	WNMG 433-R	T5305	☐	■	■	■	☐	☐	☐	++	.047	.010	.028	.079	.220			
		T5315	▣	☐	■	■	☐	☐	☐	++	.047	.010	.028	.079	.220			
		T9310	■	■	▣	■	☐	☐	☐	++	.047	.010	.028	.079	.220			
		T9315	■	■	▣	■	☐	☐	☐	++	.047	.010	.028	.079	.220			
		T9325	■	▣	▣	■	☐	☐	☐	++	.047	.010	.028	.079	.220			
		T9335	■	▣	■	■	☐	☐	☐	+++	.047	.010	.028	.079	.220			
	WNMG 333-RM	T7325	▣	■	■	■	▣	☐	☐	++	.047	.010	.024	.051	.157			
		T7335	▣	■	■	■	▣	☐	☐	+++	.047	.010	.024	.051	.157			
		T9315	■	■	▣	■	☐	☐	☐	++	.047	.010	.024	.051	.157			
		T9325	■	■	▣	■	☐	☐	☐	++	.047	.010	.024	.051	.157			
		T9335	■	▣	▣	■	☐	☐	☐	+++	.047	.010	.024	.051	.157			
		T9335	■	▣	■	■	☐	☐	☐	+++	.047	.010	.024	.051	.157			
	WNMG 432-RM	T5305	☐	■	■	■	☐	☐	●	+	.031	.008	.022	.039	.197			
		T5315	▣	☐	■	■	☐	☐	☐	●	+	.031	.008	.022	.039	.197		
		T7325	▣	■	■	■	▣	☐	☐	●	++	.031	.008	.022	.039	.197		
		T7335	▣	■	■	■	▣	☐	☐	●	++	.031	.008	.022	.039	.197		
		T9310	■	■	▣	■	☐	☐	☐	●	+	.031	.008	.022	.039	.197		
		T9315	■	■	▣	■	☐	☐	☐	●	++	.031	.008	.022	.039	.197		
		T9325	■	■	▣	■	☐	☐	☐	●	++	.031	.008	.022	.039	.197		
		T9335	■	▣	▣	■	☐	☐	☐	●	++	.031	.008	.022	.039	.197		
		T8315	▣	■	■	■	☐	☐	☐	●	+	.031	.008	.022	.039	.197		
		T8330	▣	■	■	■	▣	☐	☐	●	++	.031	.008	.022	.039	.197		
		T5305	☐	■	■	■	☐	☐	☐	●	++	.047	.010	.028	.059	.197		
		T5315	▣	☐	■	■	☐	☐	☐	●	++	.047	.010	.028	.059	.197		
		T9310	■	■	▣	■	☐	☐	☐	●	++	.047	.010	.028	.059	.197		
		T9315	■	■	▣	■	☐	☐	☐	●	++	.047	.010	.028	.059	.197		
	WNMG 433-RM	T9325	■	■	▣	■	☐	☐	●	++	.047	.010	.028	.059	.197			
		T9335	■	▣	▣	■	☐	☐	☐	●	+++	.047	.010	.028	.059	.197		
		T8315	▣	■	■	■	☐	☐	☐	●	++	.047	.010	.028	.059	.197		
		T5305	☐	■	■	■	☐	☐	☐	●	++	.063	.012	.030	.079	.197		
		T5315	▣	☐	■	■	☐	☐	☐	●	++	.063	.012	.030	.079	.197		
		T7335	▣	■	■	■	▣	☐	☐	●	+++	.063	.012	.030	.079	.197		
		T9310	■	■	▣	■	☐	☐	☐	●	++	.063	.012	.030	.079	.197		
		T9315	■	■	▣	■	☐	☐	☐	●	++	.063	.012	.030	.079	.197		
		T9325	■	■	▣	■	☐	☐	☐	●	++	.063	.012	.030	.079	.197		
		T9335	■	▣	▣	■	☐	☐	☐	●	+++	.063	.012	.030	.079	.197		
			WNMG 331-SF	T7325	▣	■	■	■	☐	☐	●	++	.016	.006	.010	.016	.098	
				T7335	▣	■	■	■	☐	☐	●	++	.016	.006	.010	.016	.098	
				T9325	▣	■	■	■	▣	☐	☐	●	+	.016	.006	.010	.016	.098
				T6310	▣	■	■	■	☐	☐	☐	●	+	.016	.004	.010	.016	.098
T8315	▣			■	■	■	☐	☐	☐	●	+	.016	.004	.010	.016	.098		
T8330	▣			■	■	■	▣	☐	☐	●	+	.016	.004	.010	.016	.098		
H07	■			▣	■	■	☐	☐	☐	●	+	.016	.004	.010	.016	.098		
H07	■			▣	■	■	☐	☐	☐	●	+	.016	.004	.010	.016	.098		
	WNMG 332-SF	T7335	▣	■	■	■	☐	☐	●	++	.031	.006	.011	.031	.118			
		T9325	▣	■	■	■	▣	☐	☐	●	+	.031	.006	.011	.031	.118		
		T6310	▣	■	■	■	☐	☐	☐	●	+	.031	.005	.011	.031	.118		
		T8315	▣	■	■	■	☐	☐	☐	●	+	.031	.005	.011	.031	.118		
		T8330	▣	■	■	■	▣	☐	☐	●	+	.031	.005	.011	.031	.118		
		H07	■	▣	■	■	☐	☐	☐	●	+	.031	.005	.011	.031	.118		
		H07	■	▣	■	■	☐	☐	☐	●	+	.031	.005	.011	.031	.118		
	WNMG 431-SF	T7325	▣	■	■	■	☐	☐	●	++	.016	.006	.012	.016	.106			
		T7335	▣	■	■	■	☐	☐	●	++	.016	.006	.012	.016	.106			
		T9315	▣	■	■	■	☐	☐	☐	●	++	.016	.006	.012	.016	.106		
		T9325	▣	■	■	■	▣	☐	☐	●	+	.016	.006	.012	.016	.106		
		T6310	▣	■	■	■	☐	☐	☐	●	+	.016	.004	.012	.016	.106		
		T8315	▣	■	■	■	☐	☐	☐	●	+	.016	.004	.012	.016	.106		
		T8315	▣	■	■	■	☐	☐	☐	●	+	.016	.004	.012	.016	.106		



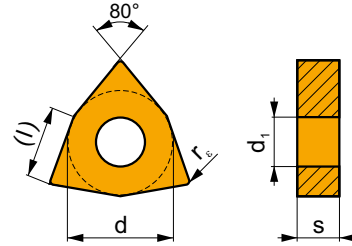
i	ANSI		P	M	K	N	S	H			r <sub>c</sub>	f <sub>min</sub>	f <sub>max</sub>	a <sub>p min</sub>	a <sub>p max</sub>		
	WNMG 431-SF	T8330	█	█		□	█	□	●	+	.016	.004	.012	.016	.106		
		H07		█		□	█		●	+	.016	.004	.012	.016	.106		
	WNMG 432-SF	T7325	█	█			█			●	++	.031	.006	.012	.031	.118	
		T7335	█	█			█			●	++	.031	.006	.012	.031	.118	
		T9315	█						□	●	++	.031	.006	.012	.031	.118	
		T9325	█	█			█			●	+	.031	.006	.012	.031	.118	
		T6310	█	█		□	█	□		●	+	.031	.005	.012	.031	.118	
		T8315	█	█		□	□	□		●	+	.031	.005	.012	.031	.118	
		T8330	█	█		□	█	□		●	+	.031	.005	.012	.031	.118	
	WNMG 433-SF	H07		█		□	█			●	+	.031	.005	.012	.031	.118	
		T7325	█	█			█			●	++	.047	.006	.012	.047	.118	
		WNMG 331-SM	T7325	█	█			█		●	++	.016	.007	.012	.016	.118	
			T7335	█	█			█		●	++	.016	.007	.012	.016	.118	
			T9315			█				□	●	++	.016	.007	.012	.016	.118
			T9325		█	█		█			●	+	.016	.007	.012	.016	.118
T8330				█	█	█	█	□		●	+	.016	.007	.012	.016	.118	
WNMG 332-SM		T7325	█	█			█			●	++	.031	.007	.014	.031	.138	
		T7335	█	█			█			●	++	.031	.007	.014	.031	.138	
		T9325		█	█		█			●	+	.031	.007	.014	.031	.138	
		T6310	█	█	█		█	□		●	+	.031	.007	.014	.031	.138	
WNMG 333-SM		T8330		█	█	█	█	□		●	+	.031	.007	.014	.031	.138	
		T7325	█	█			█			●	++	.047	.008	.016	.047	.157	
		T9325		█	█		█			●	+	.047	.008	.016	.047	.157	
WNMG 431-SM		T8330		█	█	█	█	□		●	+	.047	.008	.016	.047	.157	
		T7325	█	█			█			●	++	.016	.007	.012	.016	.157	
		T7335	█	█			█			●	++	.016	.007	.012	.016	.157	
	T9315			█				□	●	++	.016	.007	.012	.016	.157		
	T9325		█	█		█			●	+	.016	.007	.012	.016	.157		
	T6310	█	█	█		█	□		●	+	.016	.007	.012	.016	.157		
	T8330		█	█	█	█	□		●	+	.016	.007	.012	.016	.157		
WNMG 432-SM	T7325	█	█			█			●	++	.031	.008	.018	.031	.157		
	T7335	█	█			█			●	++	.031	.008	.018	.031	.157		
	T9315			█				□	●	++	.031	.008	.018	.031	.157		
	T9325		█	█		█			●	++	.031	.008	.018	.031	.157		
	T6310	█	█	█		█	□		●	+	.031	.008	.018	.031	.157		
	T8330		█	█	█	█	□		●	++	.031	.008	.018	.031	.157		
	T8330		█	█	█	█	□		●	++	.031	.008	.018	.031	.157		
WNMG 433-SM	T7325	█	█			█			●	++	.047	.009	.018	.047	.177		
	T7335	█	█			█			●	++	.047	.009	.018	.047	.177		
	T9315			█				□	●	++	.047	.009	.018	.047	.177		
	T9325		█	█		█			●	++	.047	.009	.018	.047	.177		
	T6310	█	█	█		█	□		●	++	.047	.009	.018	.047	.177		
	T8330		█	█	█	█	□		●	++	.047	.009	.018	.047	.177		
	T8330		█	█	█	█	□		●	++	.047	.009	.018	.047	.177		
WNMG 331R-SI	T9325		█		□				●	+	.016	.008	.012	.031	.165		
	T8330		█		□	□	█		●	+	.016	.008	.012	.031	.165		
WNMG 431R-SI	T7325	█	█			█			●	++	.016	.008	.012	.031	.197		
	T7335	█	█			█			●	++	.016	.008	.012	.031	.197		
	T9325			█				□	●	+	.016	.008	.012	.031	.197		
	T8315	█	█		□	□	□		●	+	.016	.008	.012	.031	.197		
	T8330		█		□	□	█		●	+	.016	.008	.012	.031	.197		
WNMG 432R-SI	T7325	█	█			█			●	++	.031	.008	.020	.031	.197		
	T7335	█	█			█			●	++	.031	.008	.020	.031	.197		
	T9325			█				□	●	+	.031	.008	.020	.031	.197		
	T8315	█	█		□	□	□		●	+	.031	.008	.020	.031	.197		
	T8330		█		□	□	█		●	+	.031	.008	.020	.031	.197		
WNMG 433R-SI	T9325		█		□			●	+	.047	.008	.020	.047	.197			

i	ANSI	Image	P	M	K	N	S	H	Image	Image	r <sub>c</sub>	f <sub>min</sub>	f <sub>max</sub>	a <sub>p min</sub>	a <sub>p max</sub>	
  	WNMG 331L-SI	T9325	■	■	□	□			●	+	.016	.008	.012	.031	.165	
		T8330	■	■	□	□	■			●	+	.016	.008	.012	.031	.165
	WNMG 431L-SI	T7325	■	■	□		■			●	++	.016	.008	.012	.031	.197
		T7335	■	■	□		■			●	++	.016	.008	.012	.031	.197
		T9325	■	■	□	□				●	+	.016	.008	.012	.031	.197
		T8315	■	■	□	□	□			●	+	.016	.008	.012	.031	.197
		T8330	■	■	□	□	■			●	+	.016	.008	.012	.031	.197
		T9325	■	■	□		■			●	++	.031	.008	.020	.031	.197
	WNMG 432L-SI	T7325	■	■	□		■			●	++	.031	.008	.020	.031	.197
		T7335	■	■	□		■			●	++	.031	.008	.020	.031	.197
		T9325	■	■	□	□				●	+	.031	.008	.020	.031	.197
		T8315	■	■	□	□	□			●	+	.031	.008	.020	.031	.197
T8330		■	■	□	□	■			●	+	.031	.008	.020	.031	.197	
T9325		■	■	□		■			●	++	.031	.006	.024	.031	.165	
WNMG 332W-F	T9315	■	■	■					●	++	.031	.006	.024	.031	.165	
	T9325	■	■	■					●	++	.031	.006	.024	.031	.165	
	T9315	■	■	■					●	+	.016	.006	.012	.016	.173	
WNMG 431W-F	T9315	■	■	■					●	++	.016	.006	.012	.016	.173	
	T9325	■	■	■					●	+	.016	.006	.012	.016	.173	
   	WNMG 332W-M	T9310	■	■	■				●	++	.031	.007	.024	.031	.118	
		T9315	■	■	■					●	++	.031	.007	.024	.031	.118
		T9325	■	■	■					●	++	.031	.007	.024	.031	.118
	WNMG 333W-M	T5315	■	■	■	□		□		●	++	.047	.008	.035	.047	.118
		T9315	■	■	■					●	++	.047	.008	.035	.047	.118
		T9325	■	■	■					●	++	.047	.008	.035	.047	.118
	WNMG 432W-M	T9315	■	■	■					●	++	.031	.007	.024	.031	.157
		T9325	■	■	■					●	++	.031	.007	.024	.031	.157
	WNMG 433W-M	T9325	■	■	■					●	++	.047	.008	.035	.047	.157
		T9315	■	■	■					●	++	.047	.008	.035	.047	.157
	  	WNMG 332W-MR	T9315	■	■	■				●	++	.031	.008	.028	.031	.118
			T9325	■	■	■					●	++	.031	.008	.028	.031
WNMG 431W-MR		T9315	■	■	■					●	++	.016	.008	.024	.020	.157
		T9325	■	■	■					●	++	.016	.008	.024	.020	.157
WNMG 432W-MR		T5315	■	■	■	□				●	++	.031	.008	.028	.031	.157
		T9310	■	■	■					●	++	.031	.008	.028	.031	.157
		T9315	■	■	■					●	++	.031	.008	.028	.031	.157
		T9325	■	■	■					●	++	.031	.008	.028	.031	.157
WNMG 433W-MR		T5315	■	■	■	□				●	++	.047	.010	.030	.047	.157
		T9310	■	■	■					●	++	.047	.010	.030	.047	.157
		T9315	■	■	■					●	++	.047	.010	.030	.047	.157
		T9325	■	■	■					●	++	.047	.010	.030	.047	.157
  	WNMG 332W-NM	T7325	■	■	□		■		●	++	.031	.008	.020	.031	.118	
		T7335	■	■	□		■			●	++	.031	.008	.020	.031	.118
		T9315	■	■	□					●	++	.031	.008	.020	.031	.118
		T9325	■	■	□	□				●	+	.031	.008	.020	.031	.118
	WNMG 431W-NM	T7325	■	■	□		■			●	++	.016	.006	.016	.020	.118
		T7335	■	■	□		■			●	++	.016	.006	.016	.020	.118
		T9315	■	■	□					●	++	.016	.006	.016	.020	.118
		T9325*	■	■	□	□				●	+	.016	.006	.016	.020	.118
	WNMG 432W-NM	T7325	■	■	□		■			●	++	.031	.008	.020	.031	.118
		T7335	■	■	□		■			●	++	.031	.008	.020	.031	.118
		T9315	■	■	□					●	++	.031	.008	.020	.031	.118
		T9325*	■	■	□	□				●	+	.031	.008	.020	.031	.118
WNMG 433W-NM	T7325	■	■	□		■			●	++	.047	.008	.022	.047	.138	
	T7335	■	■	□		■			●	++	.047	.008	.022	.047	.138	
	T9315	■	■	□					●	++	.047	.008	.022	.047	.138	

\* Non-stocked item

# WNMM

	d	d <sub>1</sub>	l	s
43	.500	.203	.343	.187
54	.625	.250	.425	.250
64	.750	.313	.512	.250



For tools see pages: T200, T218

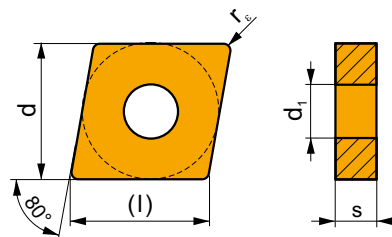
i	ANSI	Material	P	M	K	N	S	H	?	Drop	r <sub>ε</sub>	f <sub>min</sub>	f <sub>max</sub>	a <sub>p min</sub>	a <sub>p max</sub>
	WNMM 542-DR	T9325	■	■	▣		□		⚙	++	.031	.012	.024	.098	.276
		T9335	■	▣					⚙	+++	.031	.012	.024	.098	.276
	WNMM 643-DR	T9325	■	■	▣		□		⚙	++	.047	.012	.033	.098	.354
		T9335	■	▣					⚙	+++	.047	.012	.033	.098	.354
	WNMM 432-NR	T7325	▣	■			■		⚙	++	.031	.010	.024	.039	.220
		T7335	▣	■					⚙	+++	.031	.010	.024	.039	.220
	WNMM 433-NR2	T9325	■	■	□		□		⚙	++	.031	.010	.024	.039	.220
		T8430	■	■	▣		▣		⚙	++	.031	.010	.024	.039	.220
	WNMM 432-OR	T7335	▣	■					⚙	+++	.031	.010	.024	.039	.197
		T9325	■	■	□		□		⚙	++	.031	.010	.024	.039	.197
	WNMM 433-OR	T7325	▣	■			■		⚙	++	.047	.011	.028	.059	.197
		T9325	■	■	□		□		⚙	++	.047	.011	.028	.059	.197
	WNMM 432-OR	T9325	■	■	▣		□		⚙	++	.031	.010	.024	.079	.197
		T9335	■	▣					⚙	+++	.031	.010	.024	.079	.197
		T8430	■	▣	▣		▣		⚙	++	.031	.010	.024	.079	.197
	WNMM 433-OR	T9315	■	■	▣				⚙	++	.047	.013	.028	.079	.220
		T9325	■	■	▣		□		⚙	++	.047	.013	.028	.079	.220
		T9335	■	▣					⚙	+++	.047	.013	.028	.079	.220
	WNMM 434-OR	T9325	■	■	▣		□		⚙	++	.063	.014	.039	.118	.220
	WNMM 643-OR	T9325	■	■	▣		□		⚙	++	.047	.013	.028	.079	.354
WNMM 644-OR	T9325	■	■	▣		□		⚙	++	.063	.014	.039	.118	.354	

CERAMICS, CBN, PCD INSERTS  
PLAQUITAS DE CERÁMICA, CBN, PCD  
PLAQUETTES CÉRAMIQUES, CBN, PCD



## CNGA CER

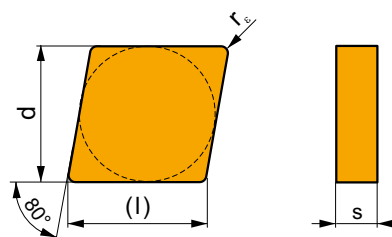
	d	d <sub>1</sub>	l	s
43	.500	.203	.508	.187



i	ANSI	TC	P	M	K	N	S	H	?	r <sub>e</sub>	f <sub>min</sub>	f <sub>max</sub>	a <sub>p min</sub>	a <sub>p max</sub>	
															TC
	CNGA 431 T00820	TC100			■		▣	□	●	-	.016	.002	.007	.016	.236
	CNGA 432 T00420	TC100			■		▣	□	●	-	.031	.002	.013	.031	.236
	CNGA 432 T00820	SN100			■				●	-	.031	.002	.013	.031	.236
	CNGA 433 T00420	TC100			■		▣	□	●	-	.047	.002	.020	.047	.236

## CNGN CER

	d	l	s
43	.500	.508	.187
45	.500	.508	.313

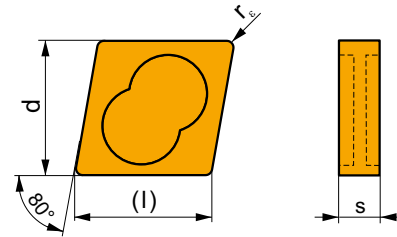


i	ANSI	TC	P	M	K	N	S	H	?	r <sub>e</sub>	f <sub>min</sub>	f <sub>max</sub>	a <sub>p min</sub>	a <sub>p max</sub>	
															TC
	CNG 432 T00420	TC100			■		▣	□	●	-	.031	.002	.013	.031	.236
	CNG 452 T00420	TC100			■		▣	□	●	-	.031	.002	.013	.031	.236
	CNG 453 T00420	TC100			■		▣	□	●	-	.047	.002	.020	.047	.236



## CNGX CER

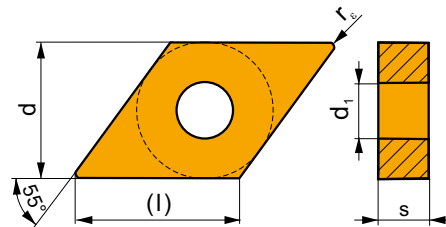
	d	l	s
45	.500	.508	.313







		ANSI		P	M	K	N	S	H			$r_c$	$f_{min}$	$f_{max}$	$a_{p min}$	$a_{p max}$
		CNGX 453 T00825	SN100			■				●	-	.047	.002	.020	.047	.236
		CNGX 454 T00825	SN100			■				●	-	.063	.002	.022	.063	.236

## DNGA CER

	d	d <sub>1</sub>	l	s
43	.500	.203	.610	.187

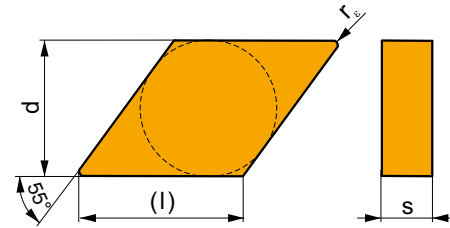






		ANSI		P	M	K	N	S	H			$r_c$	$f_{min}$	$f_{max}$	$a_{p min}$	$a_{p max}$
		DNGA 431 S00820	TC100			■	▣	□		●	-	.031	.002	.011	.031	.126

i	ANSI	TC100	P	M	K	N	S	H	?	●	-	$r_e$	$f_{min}$	$f_{max}$	$a_{p\ min}$	$a_{p\ max}$
   	DNGA 431 T00420	TC100			■	▣	□		●	-	.016	.002	.005	.016	.126	
	DNGA 432 T00520	TC100			■	▣	□		●	-	.031	.002	.011	.031	.126	

## DNGN CER

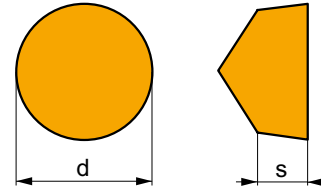
	d	l	s
43	.500	.610	.187



i	ANSI	TC100	P	M	K	N	S	H	?	●	-	$r_e$	$f_{min}$	$f_{max}$	$a_{p\ min}$	$a_{p\ max}$
   	DNG 431 T00420	TC100			■	▣	□		●	-	.016	.002	.005	.016	.126	

## RCGX CER

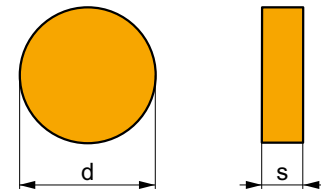
	d	s
0606	.250	.250
0907	.375	.313
1207	.500	.313



i	ANSI	TC100	P	M	K	N	S	H	?	r <sub>c</sub>	f <sub>min</sub>	f <sub>max</sub>	a <sub>p min</sub>	a <sub>p max</sub>	
  	RCGX 060600 K15015	TC100			■	□	□	□	●	-	-	.004	.018	.009	.067
	RCGX 090700 K15015	TC100			■	□	□	□	●	-	-	.006	.022	.014	.101
	RCGX 120700 K15015	TC100			■	□	□	□	●	-	-	.008	.026	.019	.135

## RNGN CER

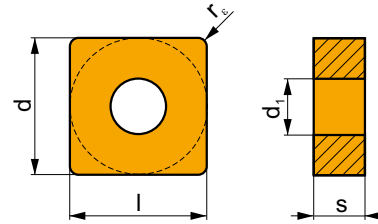
	d	s
32	.375	.125
43	.500	.187
45	.500	.313



i	ANSI	TC100	P	M	K	N	S	H	?	r <sub>c</sub>	f <sub>min</sub>	f <sub>max</sub>	a <sub>p min</sub>	a <sub>p max</sub>	
  	RNG 32 T00420	TC100			■	□	□	□	●	-	-	.006	.024	.014	.101
	RNG 43 T00420	TC100			■	□	□	□	●	-	-	.010	.028	.019	.135
	RNG 45 T00420	TC100			■	□	□	□	●	-	-	.010	.028	.019	.135
	RNG 45 T06015	TC100			■	□	□	□	●	-	-	.010	.028	.019	.135

## SNGA CER

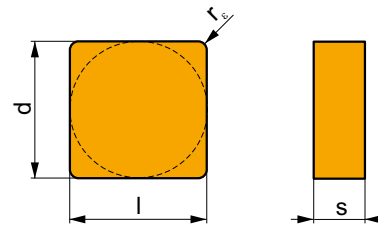
	d	d <sub>1</sub>	l	s
43	.500	.203	.500	.187



		ANSI		P	M	K	N	S	H			r <sub>ε</sub>	f <sub>min</sub>	f <sub>max</sub>	a <sub>p min</sub>	a <sub>p max</sub>
  		SNGA 432 T00425	TC100			■		▣	□	●	-	.031	.002	.015	.031	.236
		SNGA 432 T00820	SN100			■		▣	□	●	-	.031	.002	.015	.031	.236
		SNGA 433 T00420	TC100			■		▣	□	●	-	.047	.002	.022	.047	.236

## SNGN CER

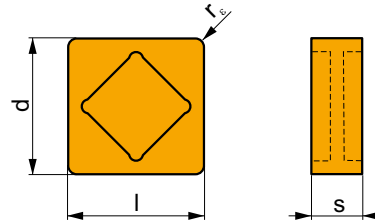
	d	l	s
32	.375	.375	.125
43	.500	.500	.187
45	.500	.500	.313



		ANSI		P	M	K	N	S	H			r <sub>ε</sub>	f <sub>min</sub>	f <sub>max</sub>	a <sub>p min</sub>	a <sub>p max</sub>
  		SNG 322 T00420	TC100			■		▣	□	●	-	.031	.002	.015	.031	.177
		SNG 323 T00420	TC100			■		▣	□	●	-	.047	.002	.022	.047	.177
		SNG 431 T00420	TC100			■		▣	□	●	-	.016	.002	.007	.016	.236
		SNG 432 T00420	TC100			■		▣	□	●	-	.031	.002	.015	.031	.236
		SNG 452 T00420	TC100			■		▣	□	●	-	.031	.002	.015	.031	.236
		SNG 453 T00420	TC100			■		▣	□	●	-	.047	.002	.022	.047	.236
		SNG 454 T00820	SN100			■					●	-	.063	.002	.022	.063

## SNGX CER

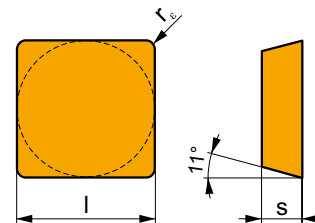
	d	l	s
45	.500	.500	.313
554	.625	.625	.313



		ANSI		P	M	K	N	S	H			$r_c$	$f_{min}$	$f_{max}$	$a_{p min}$	$a_{p max}$
		SNGX 453 T00825	SN100			■				●	-	.047	.002	.022	.047	.236
		SNGX 554 T00825	SN100			■				●	-	.063	.002	.022	.063	.281

## SPGN CER

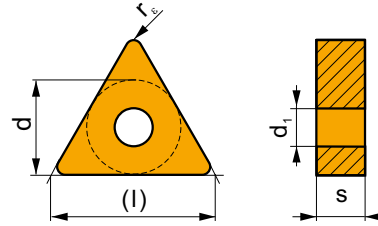
	d	l	s
42	.500	.500	.125
43	.500	.500	.187



		ANSI		P	M	K	N	S	H			$r_c$	$f_{min}$	$f_{max}$	$a_{p min}$	$a_{p max}$
		SPG 422 T00420	TC100			■	▣	□		●	-	.031	.002	.015	.031	.236

## TNGA CER

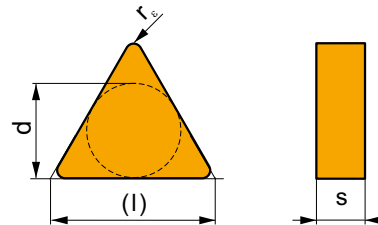
	d	d <sub>1</sub>	l	s
33	.375	.150	.650	.187



i	ANSI	TC	P	M	K	N	S	H	?	Drop	r <sub>E</sub>	f <sub>min</sub>	f <sub>max</sub>	a <sub>p min</sub>	a <sub>p max</sub>
	TNGA 332 T00420	TC100			■		▣	□	●	-	.031	.002	.011	.031	.148
	TNGA 332 T00820	SN100			■		▣	□	●	-	.031	.002	.011	.031	.148
	TNGA 333 T00420	TC100			■		▣	□	●	-	.047	.002	.016	.047	.148

## TNGN CER

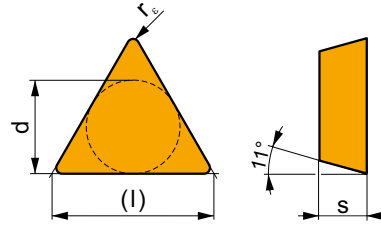
	d	l	s
33	.375	.650	.187
352	.375	.650	.313



i	ANSI	TC	P	M	K	N	S	H	?	Drop	r <sub>E</sub>	f <sub>min</sub>	f <sub>max</sub>	a <sub>p min</sub>	a <sub>p max</sub>
	TNG 332 T00420	TC100			■		▣	□	●	-	.031	.002	.011	.031	.148
	TNG 333 T00420	TC100			■		▣	□	●	-	.047	.002	.016	.047	.148
	TNG 352 T00820	TC100			■		▣	□	●	-	.031	.002	.011	.031	.148

## TPGN CER

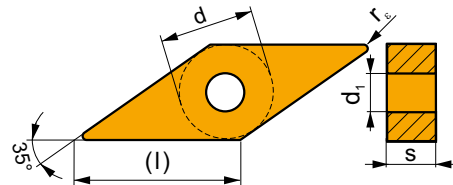
	d	l	s
22	.250	.433	.125
32	.375	.650	.125



		ANSI		P	M	K	N	S	H			$r_e$	$f_{min}$	$f_{max}$	$a_{p min}$	$a_{p max}$
		TPG 221 T00420	TC100			■		▣	□	●	-	.016	.002	.005	.016	.102
		TPG 222 T00420	TC100			■		▣	□	●	-	.031	.002	.011	.031	.102
		TPG 321 T00420	TC100			■		▣	□	●	-	.016	.002	.005	.016	.148
		TPG 322 T00420	TC100			■		▣	□	●	-	.031	.002	.011	.031	.148
		TPG 323 T00420	TC100			■		▣	□	●	-	.047	.002	.016	.047	.148

## VNGA CER

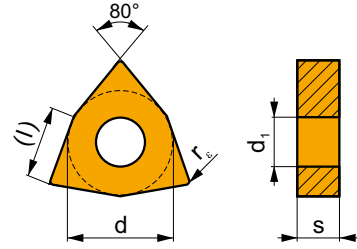
	d	$d_1$	l	s
33	.375	.150	.654	.187



		ANSI		P	M	K	N	S	H			$r_e$	$f_{min}$	$f_{max}$	$a_{p min}$	$a_{p max}$
		VNGA 331 T00420	TC100			■		▣	□	●	-	.016	.002	.004	.016	.113
		VNGA 332 T00420	TC100			■		▣	□	●	-	.031	.002	.009	.031	.113

## WNGA CER

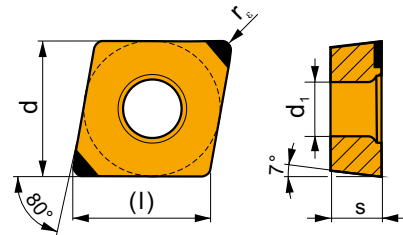
	d	d <sub>1</sub>	l	s
43	.500	.203	.343	.187



		ANSI		P	M	K	N	S	H			r <sub>e</sub>	f <sub>min</sub>	f <sub>max</sub>	a <sub>p min</sub>	a <sub>p max</sub>
		WNGA 432 T00820	SN100			■				●	-	.031	.002	.013	.031	.157

## CCGW CBN

	d	d <sub>1</sub>	l	s
21.5	.250	.110	.256	.094
32.5	.375	.177	.382	.156



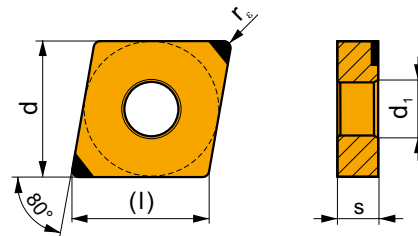
		ANSI		P	M	K	N	S	H			r <sub>e</sub>	f <sub>min</sub>	f <sub>max</sub>	a <sub>p min</sub>	a <sub>p max</sub>
		CCGW 21.51E	TB310					■	■	●	---	.016	.001	.008	.002	.106
		CCGW 32.51E	TB310					■	■	●	---	.016	.001	.008	.002	.106



i	ANSI		P	M	K	N	S	H			$r_c$	$f_{min}$	$f_{max}$	$a_{p min}$	$a_{p max}$
	CCGW 21.51S00420	TB310					■	■	●	---	.016	.001	.008	.002	.106
	CCGW 32.51S00420	TB310					■	■	●	---	.016	.001	.008	.002	.106
	CCGW 32.51S00420W	TB310						■	●	---	.016	.001	.008	.002	.106

### CNGA CBN

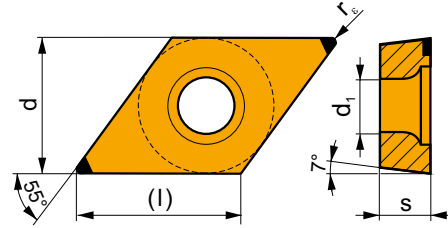
	d	d <sub>1</sub>	l	s
43	.500	.203	.508	.187



i	ANSI		P	M	K	N	S	H			$r_c$	$f_{min}$	$f_{max}$	$a_{p min}$	$a_{p max}$
	CNGA 431S00420	TB310					■	■	●	---	.016	.001	.008	.002	.106
	CNGA 432S00420	TB310					■	■	●	---	.031	.001	.008	.002	.106

## DCGW CBN

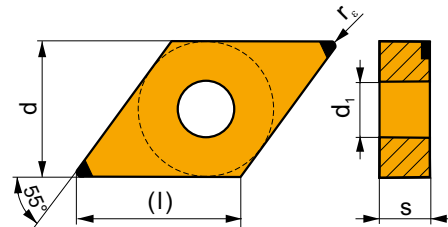
	d	d <sub>1</sub>	l	s
32.5	.375	.177	.457	.156



		ANSI		P	M	K	N	S	H			r <sub>e</sub>	f <sub>min</sub>	f <sub>max</sub>	a <sub>p min</sub>	a <sub>p max</sub>
		DCGW 32.51S00420	TB310					▣	■	●	---	.016	.001	.008	.002	.118
		DCGW 32.52S00420	TB310					▣	■	●	---	.031	.001	.008	.002	.118

## DNGA CBN

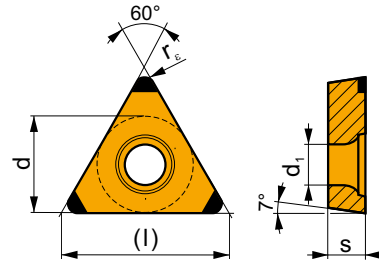
	d	d <sub>1</sub>	l	s
44	.500	.203	.610	.250



		ANSI		P	M	K	N	S	H			r <sub>e</sub>	f <sub>min</sub>	f <sub>max</sub>	a <sub>p min</sub>	a <sub>p max</sub>
		DNGA 442S00420	TB310					▣	■	●	---	.031	.001	.008	.002	.118

## TCGW CBN

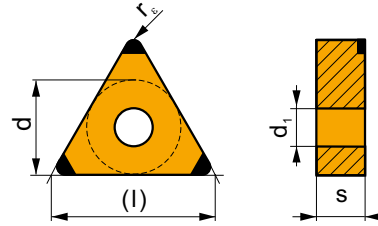
	d	d <sub>i</sub>	l	s
21.5	.250	.114	.433	.094



		ANSI		P	M	K	N	S	H			r <sub>c</sub>	f <sub>min</sub>	f <sub>max</sub>	a <sub>p min</sub>	a <sub>p max</sub>
		TCGW 21.51E	TB310					☑	■	●	---	.016	.001	.008	.002	.098
		TCGW 21.51S00420	TB310					☑	■	●	---	.016	.001	.008	.002	.098
		TCGW 21.52S00420	TB310					☑	■	●	---	.031	.001	.008	.002	.098

## TNGA CBN

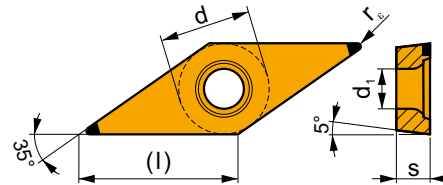
	d	d <sub>1</sub>	l	s
33	.375	.150	.650	.187



		ANSI		P	M	K	N	S	H			r <sub>e</sub>	f <sub>min</sub>	f <sub>max</sub>	a <sub>p min</sub>	a <sub>p max</sub>
		TNGA 332S00420	TB310					☑	■	●	---	.031	.001	.008	.002	.098

## VBGW CBN

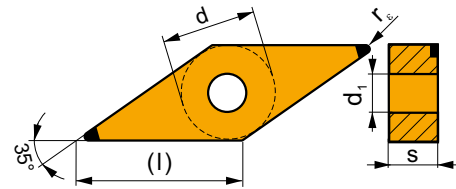
	d	d <sub>1</sub>	l	s
33	.375	.177	.630	.187



		ANSI		P	M	K	N	S	H			r <sub>e</sub>	f <sub>min</sub>	f <sub>max</sub>	a <sub>p min</sub>	a <sub>p max</sub>
		VBGW 331S00420	TB310					☑	■	●	---	.016	.001	.008	.002	.142
		VBGW 332S00420	TB310					☑	■	●	---	.031	.001	.008	.002	.142

## VNGA CBN

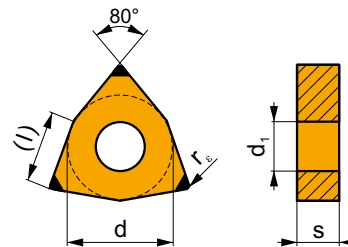
	d	d <sub>1</sub>	l	s
33	.375	.150	.630	.187



		ANSI		P	M	K	N	S	H			r <sub>c</sub>	f <sub>min</sub>	f <sub>max</sub>	a <sub>p min</sub>	a <sub>p max</sub>
		VNGA 331S00420	TB310					▣	■	●	---	.016	.001	.008	.002	.142
		VNGA 332S00420	TB310					▣	■	●	---	.031	.001	.008	.002	.142

## WNGA CBN

	d	d <sub>1</sub>	l	s
43	.500	.203	.343	.187

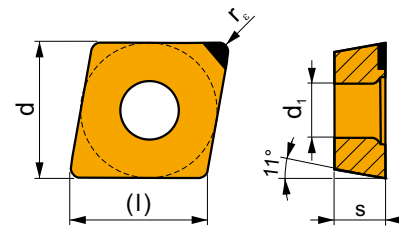


		ANSI		P	M	K	N	S	H			r <sub>c</sub>	f <sub>min</sub>	f <sub>max</sub>	a <sub>p min</sub>	a <sub>p max</sub>
		WNGA 432S00420	TB310					▣	■	●	---	.031	.001	.008	.002	.106

<b>i</b>		ANSI		P	M	K	N	S	H			$r_c$	$f_{min}$	$f_{max}$	$a_{p\ min}$	$a_{p\ max}$
		WNGA 432S00420W	TB310								---	.031	0,02	0,20	0,1	2,7

### CPGW PCD

	d	$d_1$	l	s
2.52	.313	.134	.319	.125
21.5	.250	.110	.252	.094

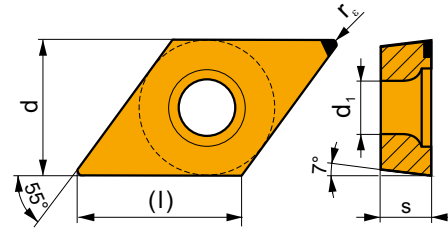


<b>i</b>		ANSI		P	M	K	N	S	H			$r_c$	$f_{min}$	$f_{max}$	$a_{p\ min}$	$a_{p\ max}$

CPGW 21.50.5 FN-30-1	PC30										--	.008	.002	.006	.008	.079
CPGW 21.51 F	D720										--	.016	.002	.012	.016	.079
CPGW 21.51 FN-30-1	PC30										--	.016	.002	.012	.016	.079
CPGW 21.52 F	D720										--	.031	.002	.016	.031	.079
CPGW 21.52 FN-30-1	PC30										--	.031	.002	.016	.031	.079
CPGW 2.520.5 FN-30-1	PC30										--	.008	.002	.006	.008	.079
CPGW 2.521 F	D720										--	.016	.002	.012	.016	.079
CPGW 2.521 FN-30-1	PC30										--	.016	.002	.012	.016	.079
CPGW 2.522 FN-30-1	PC30										--	.031	.002	.016	.031	.079

## DCGW PCD

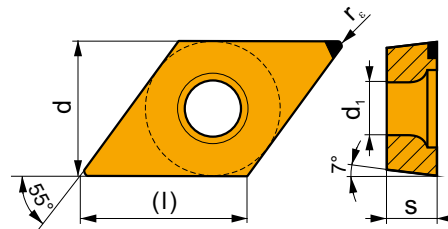
	d	d <sub>1</sub>	l	s
21.5	.250	.110	.307	.094



		ANSI		P	M	K	N	S	H			r <sub>ε</sub>	f <sub>min</sub>	f <sub>max</sub>	a <sub>p min</sub>	a <sub>p max</sub>
		DCGW 21.52 FN-30-1	PC30				■			●	--	.031	.002	.012	.031	.079

## DCMW PCD

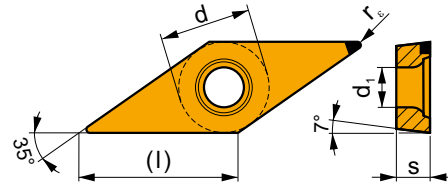
	d	d <sub>1</sub>	l	s
32.5	.375	.173	.457	.156



		ANSI		P	M	K	N	S	H			r <sub>ε</sub>	f <sub>min</sub>	f <sub>max</sub>	a <sub>p min</sub>	a <sub>p max</sub>
		DCMW 32.51FN	PD1				■			●	+/-	.016	.002	.007	.016	.079

## VCMW PCD

	d	d <sub>1</sub>	l	s
33	.375	.173	.654	.187



		ANSI		P	M	K	N	S	H			r <sub>ε</sub>	f <sub>min</sub>	f <sub>max</sub>	a <sub>p min</sub>	a <sub>p max</sub>
		VCMW 331FN	PD1				■			●	+/-	.016	.004	.006	.016	.079
		VCMW 332FN	PD1				■			●	+/-	.031	.004	.006	.031	.079



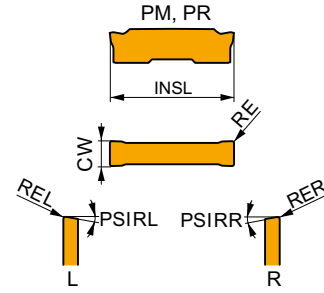
PARTING & GROOVING INSERTS  
PLAQUITAS PARA TRONZADO Y RANURADO  
PLAQUETTES POUR TRONÇONNAGE ET GORGES



**GL. D**

	CW	CWTOLL	CWTOLU	INSL
200	.079	.002	.002	.984
250	.098	.002	.002	.984
300	.118	.002	.002	.984
400	.157	.002	.002	.984
500	.197	.002	.002	.984
600	.236	.002	.002	.984

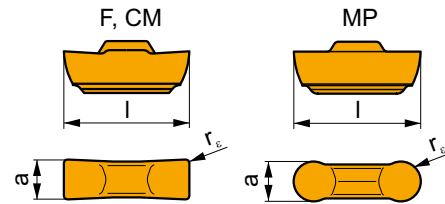
For tools see pages: T230 -231



i	ANSI	P	M	K	N	S	H	?	RE	FN	FX	PSIRL	PSIRR	
														Material
	GL2-D200M02-PM	G8330	■	■	▣			●	+++	.008	.002	.005	-	-
	GL2-D200M02-PM	T7325	▣	■				●	+++	.008	.002	.005	-	-
	GL3-D250G02-PM	G8330	■	■	▣			●	+++	.008	.002	.006	-	-
	GL3-D300M02-PM	G8330	■	■	▣			●	+++	.008	.002	.006	-	-
	GL3-D300M02-PM	T7325	▣	■				●	+++	.008	.002	.006	-	-
	GL4-D400M02-PM	G8330	■	■	▣			●	+++	.008	.003	.007	-	-
	GL4-D400M02-PM	T7325	▣	■			●	+++	.008	.003	.007	-	-	
	GL5-D500M03-PM	G8330	■	■	▣			●	+++	.012	.004	.008	-	-
	GL6-D600M03-PM	G8330	■	■	▣			●	+++	.012	.004	.009	-	-
	GL2-D200G02R06-PM	G8330	■	■	▣			●	+++	.008	.002	.005	-	6°
	GL2-D200G02R06-PM	T7325	▣	■				●	+++	.008	.002	.005	-	6°
	GL2-D200G02R12-PM	G8330	■	■	▣			●	+++	.008	.002	.006	-	12°
	GL3-D300G02R06-PM	G8330	■	■	▣			●	+++	.008	.002	.006	-	6°
	GL3-D300G02R06-PM	T7325	▣	■				●	+++	.008	.002	.006	-	6°
	GL3-D300G02R12-PM	G8330	■	■	▣			●	+++	.008	.002	.006	-	12°
	GL4-D400G02R06-PM	G8330	■	■	▣			●	+++	.008	.003	.007	-	6°
	GL4-D400G02R06-PM	T7325	▣	■				●	+++	.008	.003	.007	-	6°
	GL4-D400G02R12-PM	G8330	■	■	▣			●	+++	.008	.003	.007	-	12°
	GL2-D200G02L06-PM	G8330	■	■	▣			●	+++	.008	.002	.005	6°	-
	GL2-D200G02L06-PM	T7325	▣	■				●	+++	.008	.002	.005	6°	-
	GL2-D200G02L12-PM	G8330	■	■	▣			●	+++	.008	.002	.006	12°	-
	GL3-D300G02L06-PM	G8330	■	■	▣			●	+++	.008	.002	.006	6°	-
	GL3-D300G02L06-PM	T7325	▣	■				●	+++	.008	.002	.006	6°	-
	GL3-D300G02L12-PM	G8330	■	■	▣			●	+++	.008	.002	.006	12°	-
	GL4-D400G02L06-PM	G8330	■	■	▣			●	+++	.008	.003	.007	6°	-
	GL4-D400G02L06-PM	T7325	▣	■				●	+++	.008	.003	.007	6°	-
	GL4-D400G02L12-PM	G8330	■	■	▣			●	+++	.008	.003	.007	12°	-
	GL2-D200M02-PR	G8330	■	▣	▣			☹	+++	.008	.002	.006	-	-
	GL2-D200M02-PR	T7325	▣	▣				☹	+++	.008	.002	.006	-	-
	GL3-D300M02-PR	G8330	■	▣	▣			☹	+++	.008	.002	.008	-	-
	GL3-D300M02-PR	T7325	▣	▣			☹	+++	.008	.002	.008	-	-	
	GL4-D400M02-PR	G8330	■	▣	▣			☹	+++	.008	.003	.010	-	-
	GL4-D400M02-PR	T7325	▣	▣				☹	+++	.008	.003	.010	-	-
	GL5-D500M04-PR	G8330	■	▣	▣			☹	+++	.016	.004	.011	-	-
	GL6-D600M04-PR	G8330	■	▣	▣			☹	+++	.016	.004	.013	-	-
		GL2-D200G02R06-PR	G8330	■	▣	▣			●	+++	.008	.002	.006	-
GL2-D200G02R12-PR		G8330	■	▣	▣			●	+++	.008	.002	.006	-	12°
GL3-D300G02R06-PR		G8330	■	▣	▣			●	+++	.008	.002	.008	-	6°
GL3-D300G02R12-PR		G8330	■	▣	▣			●	+++	.008	.002	.008	-	12°
GL4-D400G02R06-PR		G8330	■	▣	▣			●	+++	.008	.003	.010	-	6°
GL4-D400G02R12-PR		G8330	■	▣	▣			●	+++	.008	.003	.010	-	12°
	GL2-D200G02L06-PR	G8330	■	▣	▣			●	+++	.008	.002	.006	6°	-
	GL2-D200G02L12-PR	G8330	■	▣	▣			●	+++	.008	.002	.006	12°	-
	GL3-D300G02L06-PR	G8330	■	▣	▣			●	+++	.008	.002	.008	6°	-
	GL3-D300G02L12-PR	G8330	■	▣	▣			●	+++	.008	.002	.008	12°	-
	GL4-D400G02L06-PR	G8330	■	▣	▣			●	+++	.008	.003	.010	6°	-
	GL4-D400G02L12-PR	G8330	■	▣	▣			●	+++	.008	.003	.010	12°	-

## LCMF 13

	a	a±	l
0313	.118	±.002	.496
0413	.157	±.002	.496

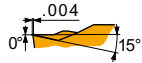


For tools see pages: T232-T235, T237, T239-T242, T244, T246

		ANSI		P	M	K	N	S	H			r <sub>e</sub>	f <sub>min</sub>	f <sub>max</sub>	a <sub>p min</sub>	a <sub>p max</sub>	κ°
		LCMF 031304-CM	T8330	■	▣	■				●	+++	.016	.002	.012	-	-	-
		LCMF 031304-CM-04*	T8330	■	▣	■				●	+++	.016	.002	.012	-	-	-
		LCMF 041304-CM	T8330	■	▣	■				●	+++	.016	.002	.012	-	-	-
		LCMF 031302-F	T8330	■	■	▣				●	+++	.008	.002	.008	.012	.118	-
		LCMF 031302-F-04	T8330	■	▣	■				●	+++	.008	.002	.008	.012	.079	-
		LCMF 031304-F	T8330	■	■	▣				●	+++	.016	.002	.010	.012	.118	-
		LCMF 031304-F-04*	T8330	■	▣	■				●	+++	.016	.002	.008	.012	.079	-
		LCMF 041304-F	T9325	■	▣	▣				●	+++	.016	.002	.010	.020	.118	-
			T8330	■	■	▣				●	+++	.016	.002	.010	.020	.118	-

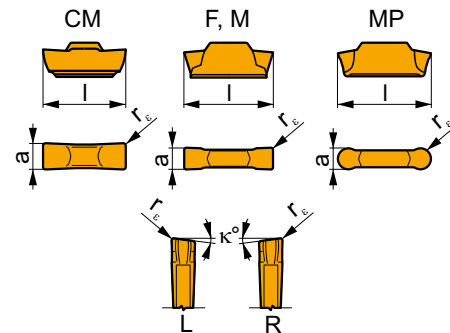
\*For internal holder A...-GG.R/L 0313-04

i	ANSI	T8330	P	M	K	N	S	H	?	+	$r_c$	$f_{min}$	$f_{max}$	$a_{p min}$	$a_{p max}$	$\kappa^\circ$
U	LCMF 0313MO-MP	T8330	■	▣	■				●	+++	.059	.002	.012	.020	.059	-
	LCMF 0313MO-MP-04	T8330	■	▣	■				●	+++	.059	.002	.012	.020	.059	-
	LCMF 0413MO-MP	T8330	■	▣	■				●	+++	.079	.002	.014	.020	.079	-



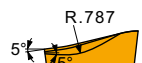
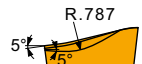
## LCMF 16, LCMF 30

	a	a±	l
0316	.118	±.002	.646
0416	.157	±.002	.646
0516	.197	±.002	.646
0616	.236	±.002	.646
0830	.315	±.002	1.181



For tools see pages: T232-T235, T237, T239-T242, T244, T246

i	ANSI	T8330	P	M	K	N	S	H	?	+	$r_c$	$f_{min}$	$f_{max}$	$a_{p min}$	$a_{p max}$	$\kappa^\circ$
1	LCMF 031602-CM	T8330	■	▣	■				●	+++	.008	.002	.012	-	-	-
	LCMF 031604-CM	T8330	■	▣	■				●	+++	.016	.002	.012	-	-	-
	LCMF 041602-CM	T8330	■	▣	■				●	+++	.008	.002	.012	-	-	-
	LCMF 041604-CM	T8330	■	▣	■				●	+++	.016	.002	.012	-	-	-
	LCMF 051604-CM	T8330	■	▣	■				●	+++	.016	.004	.016	-	-	-
	LCMF 061604-CM	T8330	■	▣	■				●	+++	.016	.004	.016	-	-	-
1	LCMF 031602R6-CM	T8330	■	▣	■				●	+++	.008	.002	.012	-	-	6
	LCMF 031602R15-CM*	T8330	■	▣	■				●	+++	.008	.002	.012	-	-	15
	LCMF 041602R6-CM	T8330	■	▣	■				●	+++	.008	.002	.012	-	-	6
	LCMF 041602R15-CM*	T8330	■	▣	■				●	+++	.008	.002	.012	-	-	15
1	LCMF 031602L6-CM	T8330	■	▣	■				●	+++	.008	.002	.012	-	-	6
	LCMF 031602L15-CM*	T8330	■	▣	■				●	+++	.008	.002	.012	-	-	15
	LCMF 041602L6-CM	T8330	■	▣	■				●	+++	.008	.002	.012	-	-	6
	LCMF 041602L15-CM*	T8330	■	▣	■				●	+++	.008	.002	.012	-	-	15

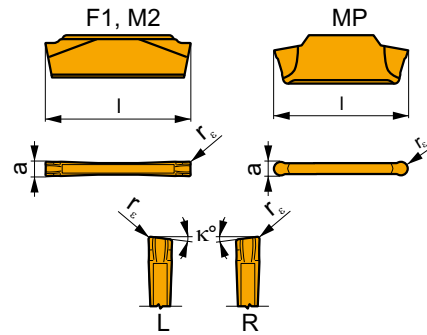


\* Tool holders have to be modified.

i	ANSI		P	M	K	N	S	H			r <sub>c</sub>	f <sub>min</sub>	f <sub>max</sub>	a <sub>p min</sub>	a <sub>p max</sub>	κ°
  	LCMF 031602-F	T8330	■	▣	■				●	+++	.008	.002	.007	.012	.118	-
	LCMF 031604-F	T8330	■	▣	■				●	+++	.016	.002	.007	.012	.118	-
	LCMF 041604-F	T9325	■	▣	▣				●	+++	.016	.006	.010	.020	.118	-
		T8330	■	▣	■				●	+++	.016	.003	.010	.020	.118	-
		T9325	■	▣	▣				●	+++	.031	.006	.010	.020	.118	-
	T8330	■	▣	■					●	+++	.031	.003	.010	.020	.118	-
	LCMF 051608-F	T9325	■	▣	▣				●	+++	.031	.006	.012	.020	.118	-
	T8330	■	▣	■					●	+++	.031	.004	.012	.020	.118	-
	LCMF 061608-F	T9325	■	▣	▣				●	+++	.031	.006	.014	.020	.118	-
	T8330	■	▣	■					●	+++	.031	.004	.014	.020	.118	-
  	LCMF 083008-F	T8330	■	▣	■				●	+++	.031	.004	.020	.031	.236	-
	LCMF 083012-F	T8330	■	▣	■				●	+++	.047	.010	.020	.047	.236	-
  	LCMF 031602-M	T8330	■	▣	■				●	+++	.008	.004	.010	.012	.118	-
	LCMF 031604-M	T8330	■	▣	■				●	+++	.016	.004	.010	.012	.118	-
	LCMF 041604-M	T9325	■	▣	▣				●	+++	.016	.006	.014	.020	.118	-
		T8330	■	▣	■				●	+++	.016	.006	.014	.020	.118	-
	LCMF 041608-M	T9325	■	▣	▣				●	+++	.031	.006	.014	.020	.118	-
	T8330	■	▣	■					●	+++	.031	.006	.014	.020	.118	-
	LCMF 051608-M	T9325	■	▣	▣				●	+++	.031	.007	.017	.020	.118	-
		T8330	■	▣	■				●	+++	.031	.007	.017	.020	.118	-
	LCMF 061608-M	T9325	■	▣	▣				●	+++	.031	.008	.020	.020	.118	-
	T8330	■	▣	■					●	+++	.031	.008	.020	.020	.118	-
  	LCMF 0316MO-MP	T8330	■	▣	■				●	+++	.059	.002	.016	.020	.059	-
	LCMF 0416MO-MP	T9325	■	▣	▣				●	+++	.079	.006	.024	.030	.079	-
	T8330	■	▣	■					●	+++	.079	.003	.024	.030	.079	-
	LCMF 0516MO-MP	T9325	■	▣	▣				●	+++	.098	.006	.028	.031	.098	-
		T8330	■	▣	■				●	+++	.098	.003	.028	.031	.098	-
	LCMF 0616MO-MP	T9325	■	▣	▣				●	+++	.118	.006	.031	.039	.118	-
	T8330	■	▣	■					●	+++	.118	.003	.031	.039	.118	-
	LCMF 0830MO-MP	T8330	■	▣	■				●	+++	.157	.004	.039	.039	.157	-

# LCMF 20

	a	a±	l
0220	.079	±.001	.768

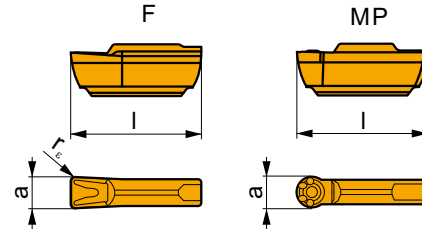


For tools see pages: T232-T235, T237, T239-T242, T244, T246

		ANSI		P	M	K	N	S	H			$r_c$	$f_{min}$	$f_{max}$	$a_{p min}$	$a_{p max}$	$k^\circ$
		LCMF 022002-F1	T8330	■	▣	■				●	+++	.008	.003	.008	.008	.079	-
		LCMF 022002-M2	T8330	■	■	▣	□	▣	□	●	+++	.008	.004	.009	.008	.079	-
		LCMF 022002R6-M2	T8330	■	■	▣	□	▣	□	●	+++	.008	.002	.008	-	-	6
		LCMF 022002L6-M2	T8330	■	■	▣	□	▣	□	●	+++	.008	.002	.008	-	-	6
		LCMF 0220MO-MP	T8330	■	▣	■				●	+++	.039	.003	.016	.008	.039	-

## LCMR 13

	a	a±	l
0313	.118	±.002	.496
0413	.157	±.002	.496

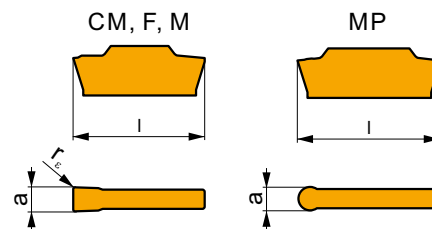


For tools see pages: T232-T235, T237, T239-T242, T244, T246

<b>i</b>		ANSI		P	M	K	N	S	H			$r_\epsilon$	$f_{min}$	$f_{max}$	$a_{p min}$	$a_{p max}$	$\kappa^\circ$
		LCMR 031304-F	T8330	■	■	■				●	+++	.016	.002	.010	.012	.118	-
		LCMR 041304-F	T8330	■	■	■				●	+++	.016	.004	.010	.020	.118	-
		LCMR 0313MO-MP	T8330	■	■	■				●	+++	.059	.002	.012	.020	.059	-
		LCMR 0413MO-MP	T8330	■	■	■				●	+++	.079	.002	.014	.020	.079	-

## LCMR 16, LCMR 30

	a	a±	l
0316	.118	±.002	.646
0416	.157	±.002	.646
0516	.197	±.002	.646
0616	.236	±.002	.646
0830	.315	±.002	1.181



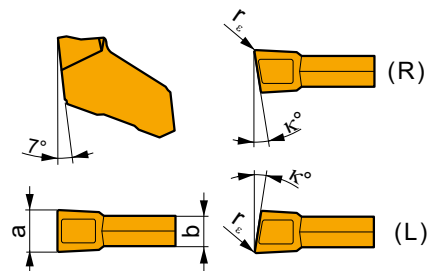
For tools see pages: T232-T235, T237, T239-T242, T244, T246

<b>i</b>		ANSI		P	M	K	N	S	H			$r_\epsilon$	$f_{min}$	$f_{max}$	$a_{p min}$	$a_{p max}$	$\kappa^\circ$
		LCMR 031602-CM	T8330	■	■	■				●	+++	.008	.002	.012	-	-	-
		LCMR 041604-CM	T8330	■	■	■				●	+++	.016	.002	.012	-	-	-

		ANSI		P	M	K	N	S	H			$r_e$	$f_{min}$	$f_{max}$	$a_{p min}$	$a_{p max}$	$\kappa^\circ$	
  	 	LCMR 031604-F	T8330	■	■	▣				●	+++	.016	.002	.007	.012	.118	-	
		LCMR 041604-F	T8330	■	■	▣					●	+++	.016	.003	.010	.020	.118	-
		LCMR 051604-F	T8330	■	■	▣					●	+++	.016	.004	.012	.020	.118	-
		LCMR 061608-F	T8330	■	■	▣					●	+++	.031	.004	.014	.020	.118	-
  	 	LCMR 083008-F	T8330	■	■	▣				●	+++	.031	.004	.020	.031	.236	-	
		LCMR 031604-M	T8330	■	▣	■					●	+++	.016	.004	.010	.012	.118	-
 	 	LCMR 041604-M	T8330	■	▣	■				●	+++	.016	.006	.014	.020	.118	-	
		LCMR 051604-M	T8330	■	▣	■					●	+++	.016	.007	.017	.020	.118	-
		LCMR 061608-M	T8330	■	▣	■					●	+++	.031	.008	.020	.020	.118	-
		LCMR 0316MO-MP	T8330	■	▣	■					●	+++	.059	.002	.016	.020	.059	-
  	 	LCMR 0416MO-MP	T8330	■	▣	■				●	+++	.079	.003	.024	.030	.079	-	
		LCMR 0516MO-MP	T8330	■	▣	■					●	+++	.098	.003	.028	.031	.098	-
		LCMR 0616MO-MP	T8330	■	▣	■					●	+++	.118	.004	.031	.039	.118	-

## LFMX

	a	a±	b
1.5-	.059	±.001	.051
1.6-	.063	±.001	.051
2.0-	.079	±.001	.063
2.2-	.079	±.001	.063
3.1-	.122	±.002	.102
4.1-	.161	±.002	.142
5.1-	.201	±.002	.181
6.35	.250	±.002	.228



For tools see pages: T245, 247

		ANSI		P	M	K	N	S	H			$r_e$	$f_{min}$	$f_{max}$	$a_{p min}$	$a_{p max}$	$\kappa^\circ$	
 		LFMX 1.5-.16ENF1	T8330	■	▣	■				●	+++	.006	.002	.004	-	-	-	
		LFMX 1.6-.16ENF1	T8330	■	▣	■					●	+++	.006	.002	.004	-	-	-
		LFMX 2.0-.16ENF1	T8330	■	▣	■					●	+++	.006	.002	.005	-	-	-
		LFMX 3.1-.20ENF1	T8330	■	▣	■					●	+++	.008	.002	.006	-	-	-
		LFMX 4.1-.20ENF1	T8330	■	▣	■					●	+++	.008	.002	.007	-	-	-



i	ANSI		P	M	K	N	S	H			r <sub>c</sub>	f <sub>min</sub>	f <sub>max</sub>	a <sub>p min</sub>	a <sub>p max</sub>	κ°
 	LFMX 1.6-.16SNF2	T8330	■	■	■	□	□	●	+++	.006	.002	.004	-	-	-	
	LFMX 2.0-.16SNF2	6640	■	■	■	□	□	●	+++	.006	.004	.006	-	-	-	
	LFMX 3.1-.20SNF2	T8330	■	■	■	□	□	●	+++	.006	.002	.006	-	-	-	
		6640	■	■	■	□	□	●	+++	.008	.004	.007	-	-	-	
	LFMX 3.1-.20TNF2	T8330	■	■	■	□	□	●	+++	.008	.003	.007	-	-	-	
		6640	■	■	■	□	□	●	+++	.008	.004	.007	-	-	-	
	LFMX 4.1-.20SNF2	T8330	■	■	■	□	□	●	+++	.008	.003	.009	-	-	-	
	LFMX 4.1-.20TNF2	T8330	■	■	■	□	□	●	+++	.008	.002	.009	-	-	-	
	LFMX 5.1-.20SNF2	T8330	■	■	■	□	□	●	+++	.008	.003	.010	-	-	-	
	LFMX 6.35-.20SNF2	T8330	■	■	■	□	□	●	+++	.008	.003	.012	-	-	-	
	LFMX 2.0-.16SNM2	6640	■	■	■	□	□	●	+++	.006	.004	.007	-	-	-	
		T8330	■	■	■	□	□	●	+++	.006	.003	.007	-	-	-	
	LFMX 2.2-.16SNM2	6640	■	■	■	□	□	●	+++	.006	.004	.007	-	-	-	
		T8330	■	■	■	□	□	●	+++	.006	.003	.007	-	-	-	
	LFMX 3.1-.20SNM2	6640	■	■	■	□	□	●	+++	.008	.004	.008	-	-	-	
		T8330	■	■	■	□	□	●	+++	.008	.003	.008	-	-	-	
	LFMX 3.1-.20TNM2	6640	■	■	■	□	□	●	+++	.008	.004	.008	-	-	-	
		T8330	■	■	■	□	□	●	+++	.008	.002	.008	-	-	-	
	LFMX 4.1-.20SNM2	6640	■	■	■	□	□	●	+++	.008	.004	.010	-	-	-	
		T8330	■	■	■	□	□	●	+++	.008	.003	.010	-	-	-	
LFMX 4.1-.20TNM2	6640	■	■	■	□	□	●	+++	.008	.004	.010	-	-	-		
	T8330	■	■	■	□	□	●	+++	.008	.002	.010	-	-	-		
LFMX 5.1-.20SNM2	6640	■	■	■	□	□	●	+++	.008	.004	.012	-	-	-		
	T8330	■	■	■	□	□	●	+++	.008	.003	.012	-	-	-		
LFMX 6.35-.20SNM2	6640	■	■	■	□	□	●	+++	.008	.004	.014	-	-	-		
	T8330	■	■	■	□	□	●	+++	.008	.003	.014	-	-	-		
LFMX 2.0-.16SR6M2	T8330	■	■	■	□	□	●	+++	.006	.002	.006	-	-	6		
LFMX 2.0-.16SR12M2	T8330	■	■	■	□	□	●	+++	.006	.002	.005	-	-	12		
LFMX 3.1-.20SR8M2	T8330	■	■	■	□	□	●	+++	.008	.003	.006	-	-	8		
LFMX 4.1-.20SR8M2	T8330	■	■	■	□	□	●	+++	.008	.003	.008	-	-	8		
LFMX 2.0-.16SL6M2	T8330	■	■	■	□	□	●	+++	.006	.002	.006	-	-	6		
LFMX 2.0-.16SL12M2	T8330	■	■	■	□	□	●	+++	.006	.002	.005	-	-	12		
LFMX 3.1-.20SL8M2	T8330	■	■	■	□	□	●	+++	.008	.003	.006	-	-	8		
LFMX 4.1-.20SL8M2	T8330	■	■	■	□	□	●	+++	.008	.003	.008	-	-	8		

ISO/ANSI CODE DESIGNATION - INDEXABLE CUTTING INSERTS FOR THREADING  
 DESIGNACIÓN CÓDIGO ISO/ANSI - PLAQUITAS PARA ROSCADO  
 CODIFICATION ISO/ANSI - PLAQUETTES DE COUPE INDEXABLES DE FILETAGE

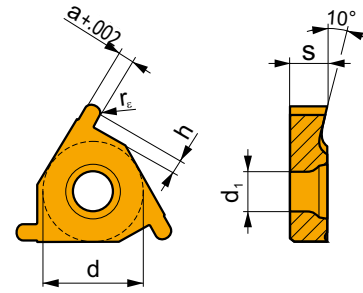
<b>ISO</b>	<b>1</b> T	<b>2</b> N	<b>3</b> 16	<b>4</b> E	<b>5</b> R	<b>6</b> 175	<b>7</b> M	<b>8</b> - P1
<b>ANSI</b>	<b>1</b> T	<b>2</b> N	<b>3</b> 16	<b>4</b> E	<b>5</b> R	<b>6</b> 120	<b>7</b> W	<b>8</b> - P1

<b>1</b> <b>1</b> Insert shape Forma de plaqueta Forme de la plaquette  T 	<b>2</b> <b>2</b> Insert clearance angle Ángulo de incidencia Angle de dépouille de la plaquette  N 	<b>3</b> <b>3</b> Insert cutting edge length (insert size) Longitud del filo de corte (tamaño de plaqueta) Longueur de l'arête de coupe (taille de plaquette)   l d = I.C. <table border="1"> <tr> <td>[mm]</td> <td>[in]</td> <td>[mm]</td> <td>[in]</td> </tr> <tr> <td>11</td> <td>.433</td> <td>6,350</td> <td>1/4</td> </tr> <tr> <td>16</td> <td>.650</td> <td>9,525</td> <td>3/8</td> </tr> <tr> <td>22</td> <td>.866</td> <td>12,7</td> <td>1/2</td> </tr> </table>	[mm]	[in]	[mm]	[in]	11	.433	6,350	1/4	16	.650	9,525	3/8	22	.866	12,7	1/2	<b>4</b> <b>4</b> External - Internal Exterior - Interior Extérieur - Intérieur  External Exterior Extérieur  E  Internal Interior Intérieur  N
[mm]	[in]	[mm]	[in]																
11	.433	6,350	1/4																
16	.650	9,525	3/8																
22	.866	12,7	1/2																

<b>5</b> <b>5</b> Direction of cut Dirección del corte Direction de coupe  Right Derecha Droite  R  Left Izquierda Gauche  L  Neutral Neutral Neutre  N	<b>6</b> <b>6</b> Thread pitch Paso de rosca Pas du filet   s x 100 Thread Pitch mm x 100 Paso de rosca mm x 100 Pas du filet mm x 100  <b>6</b>  No. of threads Nº de hilos Nb de filets  No. of threads per in x 10 Nº de hilos por pulgada x 10 b de filets au pouce x 10	<b>7</b> <b>7</b> Thread profile Perfil de rosca Profil du filet  M Metric 60° Métrica 60° Métrique 60° ISO 965/1-1980 TR TR 30° ISO 2901/3-1977  W Whitworth 55° ISO 228-1982 UN American UN 60° ISO 5864-1978  RD Round 30° Redonda 30° Rond 30° DIN 405-1981 ACME ACME 29° ANSI B1.5-1988  BSPT ISO 228/1 35 21 1959 ISO 7/1 API RD API  NPT ANSI B1.1-1983
<b>8</b> <b>8</b> Chip breaker designation Designación del rompevirutas Désignation du brise-copeaux (géométrie)  P1 Pressed Prensada Pressé		

## TN R EXT

	d	d <sub>1</sub>	s
16	.375	.154	.141
22	.500	.193	.185

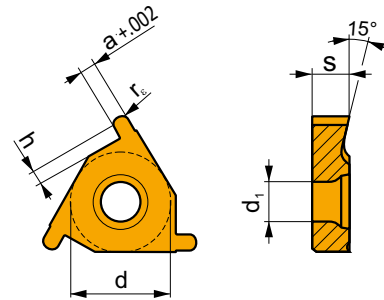


For tools see pages: T250 -T253

		ANSI		P	M	K	N	S	H			r <sub>c</sub>	f <sub>min</sub>	f <sub>max</sub>	a <sub>p min</sub>	a <sub>p max</sub>	a	h
		TN 16ER-R050	T8330	■	■	■	□	▣	□	●	+++	.020	-	-	-	-	.039	.051
		TN 16ER-R100	T8330	■	■	■	□	▣	□	●	+++	.039	-	-	-	-	.079	.073
		TN 22ER-R150	T8330	■	■	■	□	▣	□	●	+++	.059	-	-	-	-	.118	.087

## TN R INT

	d	d <sub>1</sub>	s
11	.250	.110	.122
16	.375	.154	.141
22	.500	.193	.185

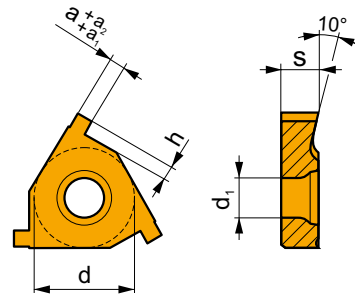


For tools see pages: T250 -T253

		ANSI		P	M	K	N	S	H			r <sub>c</sub>	f <sub>min</sub>	f <sub>max</sub>	a <sub>p min</sub>	a <sub>p max</sub>	a	h
		TN 11NR-R050	T8330	■	■	■	□	▣	□	●	+++	.020	-	-	-	-	.039	.051
		TN 16NR-R100	T8330	■	■	■	□	▣	□	●	+++	.039	-	-	-	-	.079	.073
		TN 22NR-R150	T8330	■	■	■	□	▣	□	●	+++	.059	-	-	-	-	.118	.087
		TN 11NL-R050	T8330	■	■	■	□	▣	□	●	+++	.020	-	-	-	-	.039	.051
		TN 16NL-R100	T8330	■	■	■	□	▣	□	●	+++	.039	-	-	-	-	.079	.073

## TN ZZ EXT

	d	d <sub>1</sub>	s
16	.375	.154	.134
22	.500	.193	.185

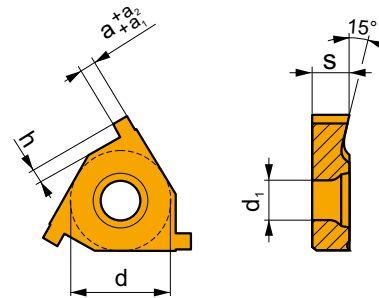


For tools see pages: T250 -T253

		ANSI		P	M	K	N	S	H			r <sub>c</sub>	f <sub>min</sub>	f <sub>max</sub>	a <sub>p min</sub>	a <sub>p max</sub>	a	a <sub>1</sub>	a <sub>2</sub>	h
		TN 16ER090ZZ	T8330	■	■	■	□	□	□	●	+++	-	-	-	-	-	.035	.002	.004	.035
		TN 16ER110ZZ	T8330	■	■	■	□	□	□	●	+++	-	-	-	-	-	.043	.002	.004	.051
		TN 16ER130ZZ	T8330	■	■	■	□	□	□	●	+++	-	-	-	-	-	.051	.002	.004	.063
		TN 16ER160ZZ	T8330	■	■	■	□	□	□	●	+++	-	-	-	-	-	.063	.002	.004	.073
		TN 16ER185ZZ	T8330	■	■	■	□	□	□	●	+++	-	-	-	-	-	.073	.002	.004	.073
		TN 16ER215ZZ	T8330	■	■	■	□	□	□	●	+++	-	-	-	-	-	.085	.002	.004	.073
		TN 16ER265ZZ	T8330	■	■	■	□	□	□	●	+++	-	-	-	-	-	.104	.002	.004	.081
		TN 22ER265ZZ	T8330	■	■	■	□	□	□	●	+++	-	-	-	-	-	.104	.003	.005	.087
		TN 22ER315ZZ	T8330	■	■	■	□	□	□	●	+++	-	-	-	-	-	.124	.003	.005	.087
		TN 22ER415ZZ	T8330	■	■	■	□	□	□	●	+++	-	-	-	-	-	.163	.003	.005	.094
		TN 16EL090ZZ	T8330	■	■	■	□	□	□	●	+++	-	-	-	-	-	.035	.002	.004	.035
		TN 16EL110ZZ	T8330	■	■	■	□	□	□	●	+++	-	-	-	-	-	.043	.002	.004	.051
		TN 16EL130ZZ	T8330	■	■	■	□	□	□	●	+++	-	-	-	-	-	.051	.002	.004	.063
		TN 16EL160ZZ	T8330	■	■	■	□	□	□	●	+++	-	-	-	-	-	.063	.002	.004	.073
		TN 16EL185ZZ	T8330	■	■	■	□	□	□	●	+++	-	-	-	-	-	.073	.002	.004	.073
		TN 16EL215ZZ	T8330	■	■	■	□	□	□	●	+++	-	-	-	-	-	.085	.002	.004	.073
		TN 16EL265ZZ	T8330	■	■	■	□	□	□	●	+++	-	-	-	-	-	.104	.002	.004	.081
		TN 22EL315ZZ	T8330	■	■	■	□	□	□	●	+++	-	-	-	-	-	.124	.003	.005	.087

## TN ZZ INT


	d	d <sub>1</sub>	s
11	.250	.110	.118
16	.375	.154	.134
22	.500	.193	.185

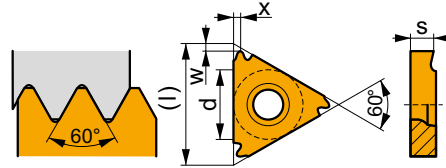


For tools see pages: T250 -T253








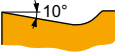
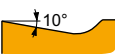
		ANSI		P	M	K	N	S	H			r <sub>c</sub>	f <sub>min</sub>	f <sub>max</sub>	a <sub>p min</sub>	a <sub>p max</sub>	a	a <sub>1</sub>	a <sub>2</sub>	h
		TN 11NR090ZZ	T8330	■	■	■	□	▣	□	●	+++	-	-	-	-	-	.035	.002	.004	.035
		TN 11NR110ZZ	T8330	■	■	■	□	▣	□	●	+++	-	-	-	-	-	.043	.002	.004	.051
		TN 16NR090ZZ	T8330	■	■	■	□	▣	□	●	+++	-	-	-	-	-	.035	.002	.004	.035
		TN 16NR110ZZ	T8330	■	■	■	□	▣	□	●	+++	-	-	-	-	-	.043	.002	.004	.051
		TN 16NR130ZZ	T8330	■	■	■	□	▣	□	●	+++	-	-	-	-	-	.051	.002	.004	.063
		TN 16NR160ZZ	T8330	■	■	■	□	▣	□	●	+++	-	-	-	-	-	.063	.002	.004	.073
		TN 16NR185ZZ	T8330	■	■	■	□	▣	□	●	+++	-	-	-	-	-	.073	.002	.004	.073
		TN 16NR215ZZ	T8330	■	■	■	□	▣	□	●	+++	-	-	-	-	-	.085	.002	.004	.073
		TN 16NR265ZZ	T8330	■	■	■	□	▣	□	●	+++	-	-	-	-	-	.104	.002	.004	.081
		TN 22NR265ZZ	T8330	■	■	■	□	▣	□	●	+++	-	-	-	-	-	.104	.003	.005	.087
		TN 22NR315ZZ	T8330	■	■	■	□	▣	□	●	+++	-	-	-	-	-	.124	.003	.005	.087
		TN 22NR415ZZ	T8330	■	■	■	□	▣	□	●	+++	-	-	-	-	-	.163	.003	.005	.094
		TN 11NL110ZZ	T8330	■	■	■	□	▣	□	●	+++	-	-	-	-	-	.043	.002	.004	.051
		TN 16NL090ZZ	T8330	■	■	■	□	▣	□	●	+++	-	-	-	-	-	.035	.002	.004	.035
		TN 16NL110ZZ	T8330	■	■	■	□	▣	□	●	+++	-	-	-	-	-	.043	.002	.004	.051
		TN 16NL130ZZ	T8330	■	■	■	□	▣	□	●	+++	-	-	-	-	-	.051	.002	.004	.063
		TN 16NL160ZZ	T8330	■	■	■	□	▣	□	●	+++	-	-	-	-	-	.063	.002	.004	.073
		TN 16NL185ZZ	T8330	■	■	■	□	▣	□	●	+++	-	-	-	-	-	.073	.002	.004	.073
		TN 16NL215ZZ	T8330	■	■	■	□	▣	□	●	+++	-	-	-	-	-	.085	.002	.004	.073
		TN 16NL265ZZ	T8330	■	■	■	□	▣	□	●	+++	-	-	-	-	-	.104	.002	.004	.081
		TN 22NL315ZZ	T8330	■	■	■	□	▣	□	●	+++	-	-	-	-	-	.124	.003	.005	.087

## TN M EXT

	d	l	s
16	.375	.650	.137
22	.500	.866	.185



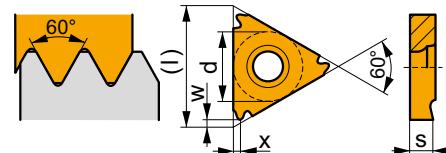
For tools see pages: T250 -T253

		ANSI		P	M	K	N	S	H			r <sub>c</sub>	f <sub>min</sub>	f <sub>max</sub>	a <sub>p min</sub>	a <sub>p max</sub>			x	w
		TN 16ER050M	T8010	■	■	■		▣		●	+++	-	-	-	-	-	0.50	-	.031	.031
		TN 16ER050M	T8030	■	■	■		▣	▣	●	+++	-	-	-	-	-	0.50	-	.031	.031
		TN 16ER075M	T8010	■	■	■		▣		●	+++	-	-	-	-	-	0.75	-	.031	.031
		TN 16ER075M	T8030	■	■	■		▣	▣	●	+++	-	-	-	-	-	0.75	-	.031	.031
		TN 16ER080M	T8010	■	■	■		▣		●	+++	-	-	-	-	-	0.80	-	.024	.031
		TN 16ER080M	T8030	■	■	■		▣	▣	●	+++	-	-	-	-	-	0.80	-	.024	.031
		TN 16ER100M	T8010	■	■	■		▣		●	+++	-	-	-	-	-	1.00	-	.031	.031
		TN 16ER100M	T8030	■	■	■		▣	▣	●	+++	-	-	-	-	-	1.00	-	.031	.031
		TN 16ER125M	T8010	■	■	■		▣		●	+++	-	-	-	-	-	1.25	-	.031	.031
		TN 16ER125M	T8030	■	■	■		▣	▣	●	+++	-	-	-	-	-	1.25	-	.031	.031
		TN 16ER150M	T8010	■	■	■		▣		●	+++	-	-	-	-	-	1.50	-	.031	.031
		TN 16ER150M	T8030	■	■	■		▣	▣	●	+++	-	-	-	-	-	1.50	-	.031	.031
		TN 16ER175M	T8010	■	■	■		▣		●	+++	-	-	-	-	-	1.75	-	.059	.047
		TN 16ER175M	T8030	■	■	■		▣	▣	●	+++	-	-	-	-	-	1.75	-	.059	.047
		TN 16ER200M	T8010	■	■	■		▣		●	+++	-	-	-	-	-	2.00	-	.059	.047
		TN 16ER200M	T8030	■	■	■		▣	▣	●	+++	-	-	-	-	-	2.00	-	.059	.047
		TN 16ER250M	T8010	■	■	■		▣		●	+++	-	-	-	-	-	2.50	-	.059	.047
		TN 16ER250M	T8030	■	■	■		▣	▣	●	+++	-	-	-	-	-	2.50	-	.059	.047
		TN 16ER300M	T8010	■	■	■		▣		●	+++	-	-	-	-	-	3.00	-	.059	.047
		TN 16ER300M	T8030	■	■	■		▣	▣	●	+++	-	-	-	-	-	3.00	-	.059	.047
		TN 22ER350M	T8010	■	■	■		▣		●	+++	-	-	-	-	-	3.50	-	.098	.071
		TN 22ER350M	T8030	■	■	■		▣	▣	●	+++	-	-	-	-	-	3.50	-	.098	.071
		TN 22ER400M	T8010	■	■	■		▣		●	+++	-	-	-	-	-	4.00	-	.098	.071
		TN 22ER400M	T8030	■	■	■		▣	▣	●	+++	-	-	-	-	-	4.00	-	.098	.071
		TN 22ER450M	T8010	■	■	■		▣		●	+++	-	-	-	-	-	4.50	-	.098	.071
		TN 22ER450M	T8030	■	■	■		▣	▣	●	+++	-	-	-	-	-	4.50	-	.098	.071
		TN 22ER500M	T8010	■	■	■		▣		●	+++	-	-	-	-	-	5.00	-	.098	.071
		TN 22ER500M	T8030	■	■	■		▣	▣	●	+++	-	-	-	-	-	5.00	-	.098	.071
		TN 16EL050M	T8030	■	■	■		▣	▣	●	+++	-	-	-	-	-	0.50	-	.031	.031
		TN 16EL075M	T8030	■	■	■		▣	▣	●	+++	-	-	-	-	-	0.75	-	.031	.031
		TN 16EL080M	T8030	■	■	■		▣	▣	●	+++	-	-	-	-	-	0.80	-	.024	.031
		TN 16EL100M	T8010	■	■	■		▣		●	+++	-	-	-	-	-	1.00	-	.031	.031
		TN 16EL100M	T8030	■	■	■		▣	▣	●	+++	-	-	-	-	-	1.00	-	.031	.031
		TN 16EL125M	T8010	■	■	■		▣		●	+++	-	-	-	-	-	1.25	-	.031	.031
		TN 16EL125M	T8030	■	■	■		▣	▣	●	+++	-	-	-	-	-	1.25	-	.031	.031
		TN 16EL150M	T8010	■	■	■		▣		●	+++	-	-	-	-	-	1.50	-	.031	.031
		TN 16EL150M	T8030	■	■	■		▣	▣	●	+++	-	-	-	-	-	1.50	-	.031	.031
		TN 16EL175M	T8010	■	■	■		▣		●	+++	-	-	-	-	-	1.75	-	.059	.047
		TN 16EL175M	T8030	■	■	■		▣	▣	●	+++	-	-	-	-	-	1.75	-	.059	.047
		TN 16EL200M	T8010	■	■	■		▣		●	+++	-	-	-	-	-	2.00	-	.059	.047
		TN 16EL200M	T8030	■	■	■		▣	▣	●	+++	-	-	-	-	-	2.00	-	.059	.047

i		ANSI		P	M	K	N	S	H			r <sub>e</sub>	f <sub>min</sub>	f <sub>max</sub>	a <sub>p min</sub>	a <sub>p max</sub>			x	w	
																					?
  		TN 16EL250M	T8010	■	■	■	□	▣	□	●	+++	-	-	-	-	-	2.50	-	.059	.047	
		TN 16EL250M	T8030	■	■	■	□	▣	□	●	+++	-	-	-	-	-	-	2.50	-	.059	.047
		TN 16EL300M	T8010	■	■	■	□	▣	□	●	+++	-	-	-	-	-	-	3.00	-	.059	.047
		TN 16EL300M	T8030	■	■	■	□	▣	□	●	+++	-	-	-	-	-	-	3.00	-	.059	.047
		TN 22EL350M	T8030	■	■	■	□	▣	□	●	+++	-	-	-	-	-	-	3.50	-	.098	.071
		TN 22EL400M	T8030	■	■	■	□	▣	□	●	+++	-	-	-	-	-	-	4.00	-	.098	.071
		TN 22EL450M	T8030	■	■	■	□	▣	□	●	+++	-	-	-	-	-	-	4.50	-	.098	.071
		TN 22EL500M	T8030	■	■	■	□	▣	□	●	+++	-	-	-	-	-	-	5.00	-	.098	.071
		TN 16ER100M-P1	T8030	■	■	■	□	▣	□	●	+++	-	-	-	-	-	-	1.00	-	.031	.031
		TN 16ER125M-P1	T8030	■	■	■	□	▣	□	●	+++	-	-	-	-	-	-	1.25	-	.031	.031
		TN 16ER150M-P1	T8030	■	■	■	□	▣	□	●	+++	-	-	-	-	-	-	1.50	-	.031	.031
		TN 16ER175M-P1	T8030	■	■	■	□	▣	□	●	+++	-	-	-	-	-	-	1.75	-	.059	.047
		TN 16ER200M-P1	T8030	■	■	■	□	▣	□	●	+++	-	-	-	-	-	-	2.00	-	.059	.047
		TN 16ER250M-P1	T8030	■	■	■	□	▣	□	●	+++	-	-	-	-	-	-	2.50	-	.059	.047
		TN 16ER300M-P1	T8030	■	■	■	□	▣	□	●	+++	-	-	-	-	-	-	3.00	-	.059	.047
		TN 16ER050M-AL	HF7				■					●	+++	-	-	-	-	-	0.50	-	.031
TN 16ER075M-AL	HF7				■					●	+++	-	-	-	-	-	0.75	-	.031	.031	
TN 16ER080M-AL	HF7				■					●	+++	-	-	-	-	-	0.80	-	.023	.031	
TN 16ER100M-AL	HF7				■					●	+++	-	-	-	-	-	1.00	-	.031	.031	
TN 16ER125M-AL	HF7				■					●	+++	-	-	-	-	-	1.25	-	.031	.031	
TN 16ER150M-AL	HF7				■					●	+++	-	-	-	-	-	1.50	-	.031	.031	
TN 16ER175M-AL	HF7				■					●	+++	-	-	-	-	-	1.75	-	.059	.047	
TN 16ER200M-AL	HF7				■					●	+++	-	-	-	-	-	2.00	-	.059	.047	
TN 16ER250M-AL	HF7				■					●	+++	-	-	-	-	-	2.50	-	.059	.047	
TN 16ER300M-AL	HF7				■					●	+++	-	-	-	-	-	3.00	-	.059	.047	

### TN M INT

	d	l	s
11	.250	.433	.118
16	.375	.650	.137
22	.500	.866	.185



For tools see pages: T250 - T253

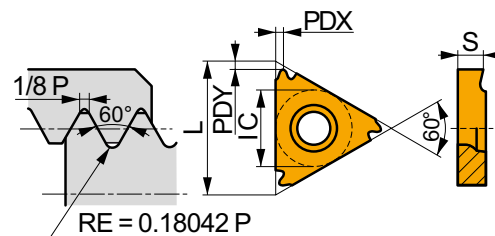
i		ANSI		P	M	K	N	S	H			r <sub>e</sub>	f <sub>min</sub>	f <sub>max</sub>	a <sub>p min</sub>	a <sub>p max</sub>			x	w	
																					?
  		TN 11NR050M	T8010	■	■	■	□	▣	□	●	+++	-	-	-	-	-	0.50	-	.031	.031	
		TN 11NR050M	T8030	■	■	■	□	▣	□	●	+++	-	-	-	-	-	-	0.50	-	.031	.031
		TN 11NR075M	T8010	■	■	■	□	▣	□	●	+++	-	-	-	-	-	-	0.75	-	.031	.031
		TN 11NR075M	T8030	■	■	■	□	▣	□	●	+++	-	-	-	-	-	-	0.75	-	.031	.031
		TN 11NR100M	T8010	■	■	■	□	▣	□	●	+++	-	-	-	-	-	-	1.00	-	.031	.031
		TN 11NR100M	T8030	■	■	■	□	▣	□	●	+++	-	-	-	-	-	-	1.00	-	.031	.031
		TN 11NR125M	T8010	■	■	■	□	▣	□	●	+++	-	-	-	-	-	-	1.25	-	.031	.031
		TN 11NR125M	T8030	■	■	■	□	▣	□	●	+++	-	-	-	-	-	-	1.25	-	.031	.031
		TN 11NR150M	T8010	■	■	■	□	▣	□	●	+++	-	-	-	-	-	-	1.50	-	.031	.031
		TN 11NR150M	T8030	■	■	■	□	▣	□	●	+++	-	-	-	-	-	-	1.50	-	.031	.031
		TN 11NR200M	T8010	■	■	■	□	▣	□	●	+++	-	-	-	-	-	-	2.00	-	.035	.031
		TN 11NR200M	T8030	■	■	■	□	▣	□	●	+++	-	-	-	-	-	-	2.00	-	.035	.031
		TN 16NR050M	T8010	■	■	■	□	▣	□	●	+++	-	-	-	-	-	-	0.50	-	.031	.031
		TN 16NR050M	T8030	■	■	■	□	▣	□	●	+++	-	-	-	-	-	-	0.50	-	.031	.031
		TN 16NR075M	T8010	■	■	■	□	▣	□	●	+++	-	-	-	-	-	-	0.75	-	.031	.031
		TN 16NR075M	T8030	■	■	■	□	▣	□	●	+++	-	-	-	-	-	-	0.75	-	.031	.031
TN 16NR100M	T8010	■	■	■	□	▣	□	●	+++	-	-	-	-	-	-	1.00	-	.031	.031		
TN 16NR100M	T8030	■	■	■	□	▣	□	●	+++	-	-	-	-	-	-	1.00	-	.031	.031		





i	ANSI	[Texture]	P	M	K	N	S	H	?	Water	r <sub>ε</sub>	f <sub>min</sub>	f <sub>max</sub>	a <sub>p min</sub>	a <sub>p max</sub>	[mm]	1 2 3 / 1"	x	w	
	TN 16NL175M	T8010	■	■	■	□	□	●	●	+++	-	-	-	-	-	1.75	-	.059	.047	
	TN 16NL175M	T8030	■	■	■	□	□	●	●	+++	-	-	-	-	-	1.75	-	.059	.047	
	TN 16NL200M	T8010	■	■	■	□	□	●	●	+++	-	-	-	-	-	2.00	-	.059	.047	
	TN 16NL200M	T8030	■	■	■	□	□	●	●	+++	-	-	-	-	-	2.00	-	.059	.047	
	TN 16NL250M	T8010	■	■	■	□	□	●	●	+++	-	-	-	-	-	2.50	-	.059	.047	
	TN 16NL250M	T8030	■	■	■	□	□	●	●	+++	-	-	-	-	-	2.50	-	.059	.047	
	TN 16NL300M	T8010	■	■	■	□	□	●	●	+++	-	-	-	-	-	3.00	-	.059	.047	
	TN 16NL300M	T8030	■	■	■	□	□	●	●	+++	-	-	-	-	-	3.00	-	.059	.047	
	TN 22NL350M	T8030	■	■	■	□	□	●	●	+++	-	-	-	-	-	3.50	-	.098	.071	
	TN 22NL400M	T8030	■	■	■	□	□	●	●	+++	-	-	-	-	-	4.00	-	.098	.071	
	TN 22NL500M	T8030	■	■	■	□	□	●	●	+++	-	-	-	-	-	5.00	-	.098	.071	
	TN 11NR100M-P1	T8030	■	■	■	□	□	●	●	+++	-	-	-	-	-	1.00	-	.031	.031	
	TN 11NR150M-P1	T8030	■	■	■	□	□	●	●	+++	-	-	-	-	-	1.50	-	.031	.031	
	TN 16NR100M-P1	T8030	■	■	■	□	□	●	●	+++	-	-	-	-	-	1.00	-	.031	.031	
	TN 16NR150M-P1	T8030	■	■	■	□	□	●	●	+++	-	-	-	-	-	1.50	-	.031	.031	
	TN 16NR200M-P1	T8030	■	■	■	□	□	●	●	+++	-	-	-	-	-	2.00	-	.059	.047	
	TN 16NR250M-P1	T8030	■	■	■	□	□	●	●	+++	-	-	-	-	-	2.50	-	.059	.047	
	TN 16NR300M-P1	T8030	■	■	■	□	□	●	●	+++	-	-	-	-	-	3.00	-	.059	.047	
		TN 16NR050M-AL	HF7				■		●	●	+++	-	-	-	-	-	0.50	-	.031	.031
		TN 16NR075M-AL	HF7				■		●	●	+++	-	-	-	-	-	0.75	-	.031	.031
TN 16NR100M-AL		HF7				■		●	●	+++	-	-	-	-	-	1.00	-	.031	.031	
TN 16NR125M-AL		HF7				■		●	●	+++	-	-	-	-	-	1.25	-	.031	.031	
TN 16NR150M-AL		HF7				■		●	●	+++	-	-	-	-	-	1.50	-	.031	.031	
TN 16NR175M-AL		HF7				■		●	●	+++	-	-	-	-	-	1.75	-	.059	.047	
TN 16NR200M-AL		HF7				■		●	●	+++	-	-	-	-	-	2.00	-	.059	.047	
TN 16NR250M-AL		HF7				■		●	●	+++	-	-	-	-	-	2.50	-	.059	.047	
TN 16NR300M-AL	HF7				■		●	●	+++	-	-	-	-	-	3.00	-	.059	.047		

TN MJ EXT			
IC	L	S	
16	3/8	.650	.137

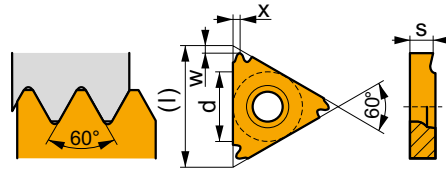


For tools see pages: T250 - T253

i	ANSI	[Texture]	P	M	K	N	S	H	?	Water	RE	FN	FX	CDN	CDX	TP	TPI	PDX	PDY
	TN 16ER100MJ	T8030	■	■	■	□	□	●	●	+++	-	-	-	-	-	1.00	-	.031	.031
	TN 16ER150MJ	T8030	■	■	■	□	□	●	●	+++	-	-	-	-	-	1.50	-	.031	.031

## TN 60° PP EXT

	d	l	s
16	.375	.650	.137
22	.500	.866	.185

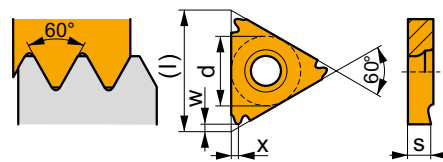


For tools see pages: T250 -T253

i	ANSI	T8030	P	M	K	N	S	H	?	r <sub>c</sub>	f <sub>min</sub>	f <sub>max</sub>	a <sub>p min</sub>	a <sub>p max</sub>	[mm]	1 2 3 / 1"	x	w
	TN 16ERA60	T8030	■	■	■	□	□	□	●	+++	-	-	-	-	0.50 - 1.50	48.0 - 16.0	.031	.024
	TN 16ERAG60	T8030	■	■	■	□	□	□	●	+++	-	-	-	-	0.50 - 3.00	48.0 - 8.0	.059	.043
	TN 16ERG60	T8030	■	■	■	□	□	□	●	+++	-	-	-	-	1.75 - 3.00	14.0 - 8.0	.059	.043
	TN 22ERN60	T8030	■	■	■	□	□	□	●	+++	-	-	-	-	3.50 - 5.00	7.0 - 5.0	.098	.071
	TN 16ELA60	T8030	■	■	■	□	□	□	●	+++	-	-	-	-	0.50 - 1.50	48.0 - 16.0	.031	.024
	TN 16ELAG60	T8030	■	■	■	□	□	□	●	+++	-	-	-	-	0.50 - 3.00	48.0 - 8.0	.059	.043
	TN 16ELG60	T8030	■	■	■	□	□	□	●	+++	-	-	-	-	1.75 - 3.00	14.0 - 8.0	.059	.043
	TN 22ELN60	T8030	■	■	■	□	□	□	●	+++	-	-	-	-	3.50 - 5.00	7.0 - 5.0	.098	.071

## TN 60° PP INT

	d	l	s
11	.250	.433	.118
16	.375	.650	.137
22	.500	.866	.185



For tools see pages: T250 -T253

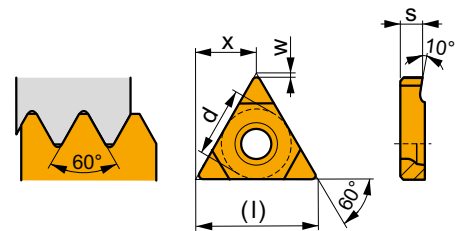
i	ANSI	T8030	P	M	K	N	S	H	?	r <sub>c</sub>	f <sub>min</sub>	f <sub>max</sub>	a <sub>p min</sub>	a <sub>p max</sub>	[mm]	1 2 3 / 1"	x	w
	TN 11NRA60	T8030	■	■	■	□	□	□	●	+++	-	-	-	-	0.50 - 1.50	48.0 - 16.0	.031	.028
	TN 16NRA60	T8030	■	■	■	□	□	□	●	+++	-	-	-	-	0.50 - 1.50	48.0 - 16.0	.031	.028
	TN 16NRAG60	T8030	■	■	■	□	□	□	●	+++	-	-	-	-	0.50 - 3.00	48.0 - 8.0	.059	.043
	TN 16NRG60	T8030	■	■	■	□	□	□	●	+++	-	-	-	-	1.75 - 3.00	14.0 - 8.0	.059	.043
	TN 22NRN60	T8030	■	■	■	□	□	□	●	+++	-	-	-	-	3.50 - 5.00	7.0 - 5.0	.098	.071

		ANSI		P	M	K	N	S	H			$r_\epsilon$	$f_{min}$	$f_{max}$	$a_{p\ min}$	$a_{p\ max}$			x	w
		TN 11NLA60	T8030	■	■	■	□	▣	□	●	+++	-	-	-	-	-	0.50 - 1.50	48.0 - 16.0	.031	.028
		TN 16NLAG60	T8030	■	■	■	□	▣	□	●	+++	-	-	-	-	-	0.50 - 3.00	48.0 - 8.0	.059	.043
		TN 22NLN60	T8030	■	■	■	□	▣	□	●	+++	-	-	-	-	-	3.50 - 5.00	7.0 - 5.0	.098	.071

$\pm 15^\circ$

### TN 60°-S PP EXT

	d	l	s
22	.500	.866	.181



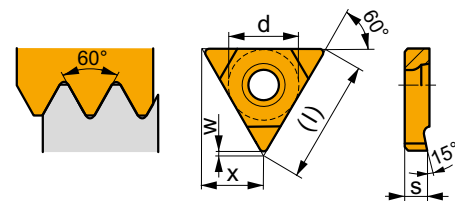
For tools see pages: T250 -T253

		ANSI		P	M	K	N	S	H			$r_\epsilon$	$f_{min}$	$f_{max}$	$a_{p\ min}$	$a_{p\ max}$			x	w
		TN 22EN350-500M	T8030	■	■	■	□	▣	□	●	+++	-	-	-	-	-	3.50 - 5.00	7.0 - 5.0	.433	.020
		TN 22EN550-800M	T8030	■	■	■	□	▣	□	●	+++	-	-	-	-	-	5.50 - 8.00	4.5 - 3.0	.433	.031

$\pm 10^\circ$

### TN 60°-S PP INT

	d	l	s
22	.500	.866	.181



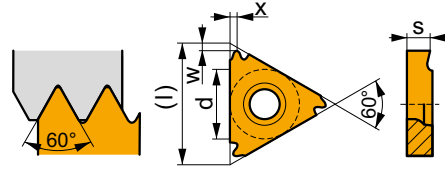
For tools see pages: T250 -T253

		ANSI		P	M	K	N	S	H			$r_\epsilon$	$f_{min}$	$f_{max}$	$a_{p\ min}$	$a_{p\ max}$			x	w
		TN 22NN350-500M	T8030	■	■	■	□	▣	□	●	+++	-	-	-	-	-	3.50 - 5.00	7.0 - 5.0	.433	.008
		TN 22NN550-800M	T8030	■	■	■	□	▣	□	●	+++	-	-	-	-	-	5.50 - 8.00	4.5 - 3.0	.433	.020

$\pm 15^\circ$

# TN UN EXT

	d	l	s
16	.375	.650	.137
22	.500	.866	.185

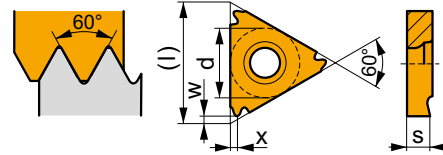


For tools see pages: T250 -T253

		ANSI		P	M	K	N	S	H			r <sub>e</sub>	f <sub>min</sub>	f <sub>max</sub>	a <sub>p min</sub>	a <sub>p max</sub>			x	w
		TN 16ER320UN	T8030	■	■	■	□	▣	□	●	+++	-	-	-	-	-	-	32.0	.031	.031
		TN 16ER280UN	T8030	■	■	■	□	▣	□	●	+++	-	-	-	-	-	-	28.0	.031	.031
		TN 16ER240UN	T8030	■	■	■	□	▣	□	●	+++	-	-	-	-	-	-	24.0	.031	.031
		TN 16ER200UN	T8010	■	■	■	□	▣	□	●	+++	-	-	-	-	-	-	20.0	.031	.031
			T8030	■	■	■	□	▣	□	●	+++	-	-	-	-	-	-	20.0	.031	.031
		TN 16ER180UN	T8030	■	■	■	□	▣	□	●	+++	-	-	-	-	-	-	18.0	.031	.031
		TN 16ER160UN	T8030	■	■	■	□	▣	□	●	+++	-	-	-	-	-	-	16.0	.031	.031
		TN 16ER140UN	T8030	■	■	■	□	▣	□	●	+++	-	-	-	-	-	-	14.0	.059	.047
		TN 16ER130UN	T8030	■	■	■	□	▣	□	●	+++	-	-	-	-	-	-	13.0	.059	.047
		TN 16ER120UN	T8030	■	■	■	□	▣	□	●	+++	-	-	-	-	-	-	12.0	.059	.047
		TN 16ER115UN	T8030	■	■	■	□	▣	□	●	+++	-	-	-	-	-	-	11.5	.059	.047
		TN 16ER110UN	T8030	■	■	■	□	▣	□	●	+++	-	-	-	-	-	-	11.0	.059	.047
		TN 16ER100UN	T8030	■	■	■	□	▣	□	●	+++	-	-	-	-	-	-	10.0	.059	.047
		TN 16ER090UN	T8030	■	■	■	□	▣	□	●	+++	-	-	-	-	-	-	9.0	.059	.047
		TN 16ER080UN	T8030	■	■	■	□	▣	□	●	+++	-	-	-	-	-	-	8.0	.059	.047
		TN 22ER070UN	T8030	■	■	■	□	▣	□	●	+++	-	-	-	-	-	-	7.0	.098	.071
		TN 22ER060UN	T8030	■	■	■	□	▣	□	●	+++	-	-	-	-	-	-	6.0	.098	.071
		TN 22ER050UN	T8030	■	■	■	□	▣	□	●	+++	-	-	-	-	-	-	5.0	.098	.071
		TN 16EL320UN	T8030	■	■	■	□	▣	□	●	+++	-	-	-	-	-	-	32.0	.031	.031
		TN 16EL280UN	T8030	■	■	■	□	▣	□	●	+++	-	-	-	-	-	-	28.0	.031	.031
		TN 16EL240UN	T8030	■	■	■	□	▣	□	●	+++	-	-	-	-	-	-	24.0	.031	.031
		TN 16EL200UN	T8030	■	■	■	□	▣	□	●	+++	-	-	-	-	-	-	20.0	.031	.031
		TN 16EL180UN	T8030	■	■	■	□	▣	□	●	+++	-	-	-	-	-	-	18.0	.031	.031
		TN 16EL160UN	T8030	■	■	■	□	▣	□	●	+++	-	-	-	-	-	-	16.0	.031	.031
		TN 16EL140UN	T8030	■	■	■	□	▣	□	●	+++	-	-	-	-	-	-	14.0	.059	.047
		TN 16EL120UN	T8030	■	■	■	□	▣	□	●	+++	-	-	-	-	-	-	12.0	.059	.047
		TN 16EL110UN	T8030	■	■	■	□	▣	□	●	+++	-	-	-	-	-	-	11.0	.059	.047
		TN 16EL100UN	T8030	■	■	■	□	▣	□	●	+++	-	-	-	-	-	-	10.0	.059	.047
		TN 16EL090UN	T8030	■	■	■	□	▣	□	●	+++	-	-	-	-	-	-	9.0	.059	.047
		TN 16EL080UN	T8030	■	■	■	□	▣	□	●	+++	-	-	-	-	-	-	8.0	.059	.047
		TN 22EL070UN	T8030	■	■	■	□	▣	□	●	+++	-	-	-	-	-	-	7.0	.098	.071
		TN 22EL060UN	T8030	■	■	■	□	▣	□	●	+++	-	-	-	-	-	-	6.0	.098	.071
		TN 22EL050UN	T8030	■	■	■	□	▣	□	●	+++	-	-	-	-	-	-	5.0	.098	.071
		TN 16ER200UN-P1	T8030	■	■	■	□	▣	□	●	+++	-	-	-	-	-	-	20.0	.031	.031
		TN 16ER180UN-P1	T8030	■	■	■	□	▣	□	●	+++	-	-	-	-	-	-	18.0	.031	.031
		TN 16ER160UN-P1	T8030	■	■	■	□	▣	□	●	+++	-	-	-	-	-	-	16.0	.031	.031
		TN 16ER140UN-P1	T8030	■	■	■	□	▣	□	●	+++	-	-	-	-	-	-	14.0	.059	.047
		TN 16ER120UN-P1	T8030	■	■	■	□	▣	□	●	+++	-	-	-	-	-	-	12.0	.059	.047
		TN 16ER080UN-P1	T8030	■	■	■	□	▣	□	●	+++	-	-	-	-	-	-	8.0	.059	.047

# TN UN INT


	d	l	s
16	.375	.650	.137
22	.500	.866	.185

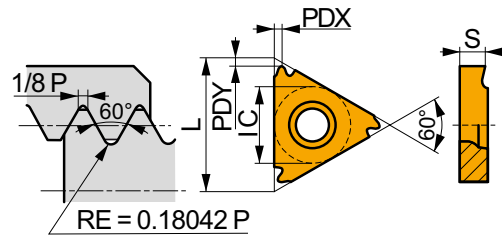


For tools see pages: T250 -T253














		ANSI		P	M	K	N	S	H			r <sub>c</sub>	f <sub>min</sub>	f <sub>max</sub>	a <sub>p min</sub>	a <sub>p max</sub>			x	w		
																					?	[mm]
		TN 16NR320UN	T8030	■	■	■	□	▣	□	●	+++	-	-	-	-	-	-	32.0	.031	.031		
		TN 16NR280UN	T8030	■	■	■	□	▣	□	●	+++	-	-	-	-	-	-	-	28.0	.031	.031	
		TN 16NR240UN	T8030	■	■	■	□	▣	□	●	+++	-	-	-	-	-	-	-	24.0	.031	.031	
		TN 16NR200UN	T8010	■	■	■	□	▣	□	●	+++	-	-	-	-	-	-	-	20.0	.031	.031	
		T8030	■	■	■	□	▣	□	●	+++	-	-	-	-	-	-	-	-	20.0	.031	.031	
		TN 16NR180UN	T8030	■	■	■	□	▣	□	●	+++	-	-	-	-	-	-	-	18.0	.031	.031	
		TN 16NR160UN	T8030	■	■	■	□	▣	□	●	+++	-	-	-	-	-	-	-	16.0	.031	.031	
		TN 16NR140UN	T8030	■	■	■	□	▣	□	●	+++	-	-	-	-	-	-	-	14.0	.059	.047	
		TN 16NR130UN	T8030	■	■	■	□	▣	□	●	+++	-	-	-	-	-	-	-	13.0	.059	.047	
		TN 16NR120UN	T8010	■	■	■	□	▣	□	●	+++	-	-	-	-	-	-	-	12.0	.059	.047	
		T8030	■	■	■	□	▣	□	●	+++	-	-	-	-	-	-	-	-	12.0	.059	.047	
		TN 16NR115UN	T8030	■	■	■	□	▣	□	●	+++	-	-	-	-	-	-	-	11.5	.059	.047	
		TN 16NR110UN	T8030	■	■	■	□	▣	□	●	+++	-	-	-	-	-	-	-	11.0	.059	.047	
		TN 16NR100UN	T8030	■	■	■	□	▣	□	●	+++	-	-	-	-	-	-	-	10.0	.059	.047	
		TN 16NR080UN	T8010	■	■	■	□	▣	□	●	+++	-	-	-	-	-	-	-	8.0	.059	.047	
		T8030	■	■	■	□	▣	□	●	+++	-	-	-	-	-	-	-	-	8.0	.059	.047	
TN 22NR060UN	T8030	■	■	■	□	▣	□	●	+++	-	-	-	-	-	-	-	6.0	.098	.071			
TN 22NR050UN	T8030	■	■	■	□	▣	□	●	+++	-	-	-	-	-	-	-	5.0	.098	.071			
		TN 16NL320UN	T8030	■	■	■	□	▣	□	●	+++	-	-	-	-	-	-	32.0	.031	.031		
		TN 16NL280UN	T8030	■	■	■	□	▣	□	●	+++	-	-	-	-	-	-	28.0	.031	.031		
		TN 16NL240UN	T8030	■	■	■	□	▣	□	●	+++	-	-	-	-	-	-	24.0	.031	.031		
		TN 16NL200UN	T8030	■	■	■	□	▣	□	●	+++	-	-	-	-	-	-	20.0	.031	.031		
		TN 16NL180UN	T8030	■	■	■	□	▣	□	●	+++	-	-	-	-	-	-	18.0	.031	.031		
		TN 16NL160UN	T8030	■	■	■	□	▣	□	●	+++	-	-	-	-	-	-	16.0	.031	.031		
		TN 16NL140UN	T8030	■	■	■	□	▣	□	●	+++	-	-	-	-	-	-	14.0	.059	.047		
		TN 16NL120UN	T8030	■	■	■	□	▣	□	●	+++	-	-	-	-	-	-	12.0	.059	.047		
		TN 16NL110UN	T8030	■	■	■	□	▣	□	●	+++	-	-	-	-	-	-	11.0	.059	.047		
		TN 16NL100UN	T8030	■	■	■	□	▣	□	●	+++	-	-	-	-	-	-	10.0	.059	.047		
		TN 16NL080UN	T8030	■	■	■	□	▣	□	●	+++	-	-	-	-	-	-	8.0	.059	.047		
		TN 22NL070UN	T8030	■	■	■	□	▣	□	●	+++	-	-	-	-	-	-	7.0	.098	.071		
		TN 22NL060UN	T8030	■	■	■	□	▣	□	●	+++	-	-	-	-	-	-	6.0	.098	.071		
				TN 16NR200UN-P1	T8030	■	■	■	□	▣	□	●	+++	-	-	-	-	-	-	20.0	.031	.031
				TN 16NR180UN-P1	T8030	■	■	■	□	▣	□	●	+++	-	-	-	-	-	-	18.0	.031	.031
				TN 16NR160UN-P1	T8030	■	■	■	□	▣	□	●	+++	-	-	-	-	-	-	16.0	.031	.031
TN 16NR140UN-P1	T8030			■	■	■	□	▣	□	●	+++	-	-	-	-	-	-	14.0	.059	.047		
TN 16NR120UN-P1	T8030			■	■	■	□	▣	□	●	+++	-	-	-	-	-	-	12.0	.059	.047		
TN 16NR080UN-P1	T8030			■	■	■	□	▣	□	●	+++	-	-	-	-	-	-	8.0	.059	.047		

## TN UNJ EXT

	IC	L	S
16	3/8	.650	.137

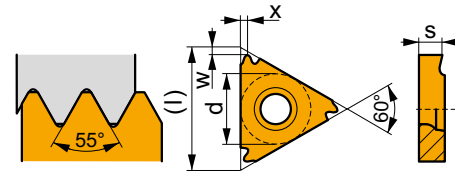


For tools see pages: T250 -T253

		ANSI		P	M	K	N	S	H			RE	FN	FX	CDN	CDX	TP	TPI	PDX	PDY
		TN 16ER320UNJ	T8030	■	■	■		☑		●	+++	-	-	-	-	-	-	32	.031	.031
		TN 16ER280UNJ	T8030	■	■	■		☑		●	+++	-	-	-	-	-	-	28	.031	.031
		TN 16ER240UNJ	T8030	■	■	■		☑		●	+++	-	-	-	-	-	-	24	.031	.031
		TN 16ER200UNJ	T8030	■	■	■		☑		●	+++	-	-	-	-	-	-	20	.031	.031
		TN 16ER180UNJ	T8030	■	■	■		☑		●	+++	-	-	-	-	-	-	18	.031	.031
		TN 16ER160UNJ	T8030	■	■	■		☑		●	+++	-	-	-	-	-	-	16	.059	.047
		TN 16ER120UNJ	T8030	■	■	■		☑		●	+++	-	-	-	-	-	-	12	.059	.047
		TN 16EL320UNJ	T8030	■	■	■		☑		●	+++	-	-	-	-	-	-	32	.031	.031
		TN 16EL280UNJ	T8030	■	■	■		☑		●	+++	-	-	-	-	-	-	28	.031	.031
		TN 16EL240UNJ	T8030	■	■	■		☑		●	+++	-	-	-	-	-	-	24	.031	.031
		TN 16EL200UNJ	T8030	■	■	■		☑		●	+++	-	-	-	-	-	-	20	.031	.031
		TN 16EL180UNJ	T8030	■	■	■		☑		●	+++	-	-	-	-	-	-	18	.031	.031
		TN 16EL160UNJ	T8030	■	■	■		☑		●	+++	-	-	-	-	-	-	16	.059	.047
		TN 16EL120UNJ	T8030	■	■	■		☑		●	+++	-	-	-	-	-	-	12	.059	.047

## TN W EXT

	d	l	s
16	.375	.650	.137
22	.500	.866	.185

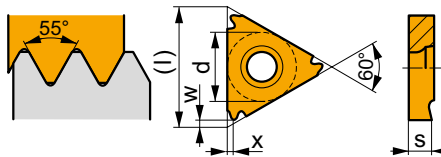


For tools see pages: T250 -T253

		ANSI		P	M	K	N	S	H			r <sub>c</sub>	f <sub>min</sub>	f <sub>max</sub>	a <sub>p min</sub>	a <sub>p max</sub>			x	w
		TN 16ER280W	T8030	■	■	■	□	▣	□	●	+++	-	-	-	-	-	-	28.0	.031	.031
		TN 16ER200W	T8030	■	■	■	□	▣	□	●	+++	-	-	-	-	-	-	20.0	.031	.031
		TN 16ER190W	T8010	■	■	■	□	▣	□	●	+++	-	-	-	-	-	-	19.0	.031	.031
			T8030	■	■	■	□	▣	□	●	+++	-	-	-	-	-	-	19.0	.031	.031
		TN 16ER180W	T8030	■	■	■	□	▣	□	●	+++	-	-	-	-	-	-	18.0	.031	.031
		TN 16ER160W	T8030	■	■	■	□	▣	□	●	+++	-	-	-	-	-	-	16.0	.031	.031
		TN 16ER140W	T8010	■	■	■	□	▣	□	●	+++	-	-	-	-	-	-	14.0	.059	.047
			T8030	■	■	■	□	▣	□	●	+++	-	-	-	-	-	-	14.0	.059	.047
		TN 16ER120W	T8030	■	■	■	□	▣	□	●	+++	-	-	-	-	-	-	12.0	.059	.047
		TN 16ER110W	T8010	■	■	■	□	▣	□	●	+++	-	-	-	-	-	-	11.0	.059	.047
			T8030	■	■	■	□	▣	□	●	+++	-	-	-	-	-	-	11.0	.059	.047
		TN 16ER100W	T8030	■	■	■	□	▣	□	●	+++	-	-	-	-	-	-	10.0	.059	.047
		TN 16ER090W	T8030	■	■	■	□	▣	□	●	+++	-	-	-	-	-	-	9.0	.059	.047
		TN 16ER080W	T8030	■	■	■	□	▣	□	●	+++	-	-	-	-	-	-	8.0	.059	.047
		TN 22ER070W	T8030	■	■	■	□	▣	□	●	+++	-	-	-	-	-	-	7.0	.098	.071
		TN 22ER060W	T8030	■	■	■	□	▣	□	●	+++	-	-	-	-	-	-	6.0	.098	.071
		TN 22ER050W	T8030	■	■	■	□	▣	□	●	+++	-	-	-	-	-	-	5.0	.098	.067
		TN 16EL280W	T8030	■	■	■	□	▣	□	●	+++	-	-	-	-	-	-	28.0	.031	.031
		TN 16EL200W	T8030	■	■	■	□	▣	□	●	+++	-	-	-	-	-	-	20.0	.031	.031
		TN 16EL190W	T8030	■	■	■	□	▣	□	●	+++	-	-	-	-	-	-	19.0	.031	.031
		TN 16EL160W	T8030	■	■	■	□	▣	□	●	+++	-	-	-	-	-	-	16.0	.031	.031
		TN 16EL140W	T8030	■	■	■	□	▣	□	●	+++	-	-	-	-	-	-	14.0	.059	.047
		TN 16EL120W	T8030	■	■	■	□	▣	□	●	+++	-	-	-	-	-	-	12.0	.059	.047
		TN 16EL110W	T8030	■	■	■	□	▣	□	●	+++	-	-	-	-	-	-	11.0	.059	.047
		TN 16EL100W	T8030	■	■	■	□	▣	□	●	+++	-	-	-	-	-	-	10.0	.059	.047
		TN 16EL090W	T8030	■	■	■	□	▣	□	●	+++	-	-	-	-	-	-	9.0	.059	.047
		TN 16EL080W	T8030	■	■	■	□	▣	□	●	+++	-	-	-	-	-	-	8.0	.059	.047
		TN 22EL070W	T8030	■	■	■	□	▣	□	●	+++	-	-	-	-	-	-	7.0	.098	.071
		TN 22EL060W	T8030	■	■	■	□	▣	□	●	+++	-	-	-	-	-	-	6.0	.098	.071
		TN 22EL050W	T8030	■	■	■	□	▣	□	●	+++	-	-	-	-	-	-	5.0	.098	.067
		TN 16ER190W-P1	T8030	■	■	■	□	▣	□	●	+++	-	-	-	-	-	-	19.0	.031	.031
		TN 16ER140W-P1	T8030	■	■	■	□	▣	□	●	+++	-	-	-	-	-	-	14.0	.059	.047
		TN 16ER110W-P1	T8030	■	■	■	□	▣	□	●	+++	-	-	-	-	-	-	11.0	.059	.047

# TN W INT

	d	l	s
11	.250	.433	.118
16	.375	.650	.137
22	.500	.866	.185



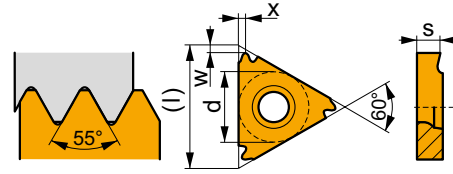
For tools see pages: T250 -T253

i		ANSI		P	M	K	N	S	H			r <sub>c</sub>	f <sub>min</sub>	f <sub>max</sub>	a <sub>p min</sub>	a <sub>p max</sub>			x	w																					
				T8010	■	■	■	□	□	●	+++	-	-	-	-	-			.031	.031																					
																					TN 11NR190W																				
																					T8030	■	■	■	□	□	●	+++	-	-	-	-	-	-	-	-	-	-	-	.031	.031
																					T8010	■	■	■	□	□	●	+++	-	-	-	-	-	-	-	-	-	-	-	.035	.028
																					T8030	■	■	■	□	□	●	+++	-	-	-	-	-	-	-	-	-	-	-	.031	.031
																					T8010	■	■	■	□	□	●	+++	-	-	-	-	-	-	-	-	-	-	-	.031	.031
																					T8030	■	■	■	□	□	●	+++	-	-	-	-	-	-	-	-	-	-	-	.031	.031
																					T8010	■	■	■	□	□	●	+++	-	-	-	-	-	-	-	-	-	-	-	.059	.047
																					T8030	■	■	■	□	□	●	+++	-	-	-	-	-	-	-	-	-	-	-	.059	.047
																					T8010	■	■	■	□	□	●	+++	-	-	-	-	-	-	-	-	-	-	-	.059	.047
																					T8030	■	■	■	□	□	●	+++	-	-	-	-	-	-	-	-	-	-	-	.059	.047
T8030	■	■	■	□	□	●	+++	-	-	-	-	-	-	-	-	-	-	-	.059	.047																					
																					TN 16NR090W																				
T8030	■	■	■	□	□	●	+++	-	-	-	-	-	-	-	-	-	-	-	.059	.047																					
																					TN 16NR080W																				
T8030	■	■	■	□	□	●	+++	-	-	-	-	-	-	-	-	-	-	-	.098	.071																					
																					TN 22NR070W																				
T8030	■	■	■	□	□	●	+++	-	-	-	-	-	-	-	-	-	-	-	.098	.071																					
																					TN 22NR060W																				
T8030	■	■	■	□	□	●	+++	-	-	-	-	-	-	-	-	-	-	-	.098	.067																					
																					TN 22NR050W																				
T8030	■	■	■	□	□	●	+++	-	-	-	-	-	-	-	-	-	-	-	.031	.031																					
																					TN 11NL190W																				
T8030	■	■	■	□	□	●	+++	-	-	-	-	-	-	-	-	-	-	-	.035	.028																					
																					TN 11NL140W																				
T8030	■	■	■	□	□	●	+++	-	-	-	-	-	-	-	-	-	-	-	.031	.031																					
																					TN 16NL280W																				
T8030	■	■	■	□	□	●	+++	-	-	-	-	-	-	-	-	-	-	-	.031	.031																					
																					TN 16NL200W																				
T8030	■	■	■	□	□	●	+++	-	-	-	-	-	-	-	-	-	-	-	.031	.031																					
																					TN 16NL190W																				
T8030	■	■	■	□	□	●	+++	-	-	-	-	-	-	-	-	-	-	-	.059	.047																					
																					TN 16NL120W																				
T8030	■	■	■	□	□	●	+++	-	-	-	-	-	-	-	-	-	-	-	.059	.047																					
																					TN 16NL110W																				
T8030	■	■	■	□	□	●	+++	-	-	-	-	-	-	-	-	-	-	-	.059	.047																					
																					TN 16NL100W																				
T8030	■	■	■	□	□	●	+++	-	-	-	-	-	-	-	-	-	-	-	.059	.047																					
																					TN 16NL090W																				
T8030	■	■	■	□	□	●	+++	-	-	-	-	-	-	-	-	-	-	-	.059	.047																					
																					TN 16NL080W																				
T8030	■	■	■	□	□	●	+++	-	-	-	-	-	-	-	-	-	-	-	.098	.071																					
																					TN 22NL070W																				
T8030	■	■	■	□	□	●	+++	-	-	-	-	-	-	-	-	-	-	-	.098	.071																					
																					TN 22NL060W																				
T8030	■	■	■	□	□	●	+++	-	-	-	-	-	-	-	-	-	-	-	.098	.067																					
																					TN 22NL050W																				
T8030	■	■	■	□	□	●	+++	-	-	-	-	-	-	-	-	-	-	-	.031	.031																					
																					TN 11NR190W-P1																				
T8030	■	■	■	□	□	●	+++	-	-	-	-	-	-	-	-	-	-	-	.035	.028																					
																					TN 11NR140W-P1																				
T8030	■	■	■	□	□	●	+++	-	-	-	-	-	-	-	-	-	-	-	.059	.047																					
																					TN 16NR140W-P1																				
T8030	■	■	■	□	□	●	+++	-	-	-	-	-	-	-	-	-	-	-	.059	.047																					
																					TN 16NR110W-P1																				



# TN 55° PP EXT

	d	l	s
16	.375	.650	.137
22	.500	.866	.185

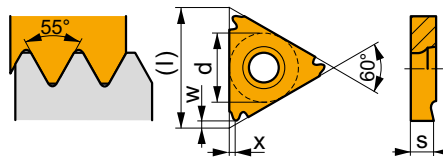


For tools see pages: T250 -T253

		ANSI		P	M	K	N	S	H			$r_c$	$f_{min}$	$f_{max}$	$a_{p min}$	$a_{p max}$			x	w
		TN 16ERA55	T8030	■	■	■	□	▣	□	●	+++	-	-	-	-	-	0.50 - 1.50	48.0 - 16.0	.031	.024
		TN 16ERAG55	T8010	■	■	■	□	▣	□	●	+++	-	-	-	-	-	0.50 - 3.00	48.0 - 8.0	1.50	1.10
		TN 16ERAG55	T8030	■	■	■	□	▣	□	●	+++	-	-	-	-	-	0.50 - 3.00	48.0 - 8.0	.059	.043
		TN 16ERG55	T8030	■	■	■	□	▣	□	●	+++	-	-	-	-	-	1.75 - 3.00	14.0 - 8.0	.059	.043
		TN 22ERN55	T8010	■	■	■	□	▣	□	●	+++	-	-	-	-	-	3.50 - 5.00	7.0 - 5.0	2.50	1.80
		TN 22ERN55	T8030	■	■	■	□	▣	□	●	+++	-	-	-	-	-	3.50 - 5.00	7.0 - 5.0	.098	.071
		TN 16ELA55	T8030	■	■	■	□	▣	□	●	+++	-	-	-	-	-	0.50 - 1.50	48.0 - 16.0	.031	.024
		TN 16ELAG55	T8030	■	■	■	□	▣	□	●	+++	-	-	-	-	-	0.50 - 3.00	48.0 - 8.0	.059	.043
		TN 16ELG55	T8030	■	■	■	□	▣	□	●	+++	-	-	-	-	-	1.75 - 3.00	14.0 - 8.0	.059	.043
		TN 22ELN55	T8030	■	■	■	□	▣	□	●	+++	-	-	-	-	-	3.50 - 5.00	7.0 - 5.0	.098	.071

## TN 55° PP INT

	d	l	s
11	.250	.433	.118
16	.375	.650	.137
22	.500	.866	.185

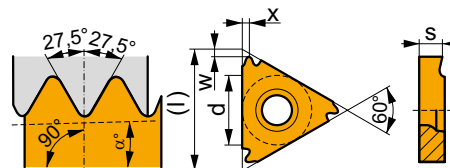


For tools see pages: T250 - T253

i	ANSI	T8030	P	M	K	N	S	H	?	r <sub>c</sub>	f <sub>min</sub>	f <sub>max</sub>	a <sub>p min</sub>	a <sub>p max</sub>	[mm]	1 <sup>23</sup> / <sub>1</sub> "	x	w
  	TN 11NRA55	T8030	■	■	■	□	▣	□	●	+++	-	-	-	-	0.50 - 1.50	48.0 - 16.0	.031	.024
	TN 16NRA55	T8030	■	■	■	□	▣	□	●	+++	-	-	-	-	0.50 - 1.50	48.0 - 16.0	.031	.024
	TN 16NRAG55	T8030	■	■	■	□	▣	□	●	+++	-	-	-	-	0.50 - 3.00	48.0 - 8.0	.059	.043
	TN 16NRG55	T8030	■	■	■	□	▣	□	●	+++	-	-	-	-	1.75 - 3.00	14.0 - 8.0	.059	.043
	TN 22NRN55	T8030	■	■	■	□	▣	□	●	+++	-	-	-	-	3.50 - 5.00	7.0 - 5.0	.098	.071
  	TN 11NLA55	T8030	■	■	■	□	▣	□	●	+++	-	-	-	-	0.50 - 1.50	48.0 - 16.0	.031	.024
	TN 16NLA55	T8030	■	■	■	□	▣	□	●	+++	-	-	-	-	0.50 - 1.50	48.0 - 16.0	.031	.024
	TN 16NLAG55	T8030	■	■	■	□	▣	□	●	+++	-	-	-	-	0.50 - 3.00	48.0 - 8.0	.059	.043
	TN 16NLG55	T8030	■	■	■	□	▣	□	●	+++	-	-	-	-	1.75 - 3.00	14.0 - 8.0	.059	.043

## TN BSPT EXT

	α°	d	l	s
16	1°47'	.375	.650	.137

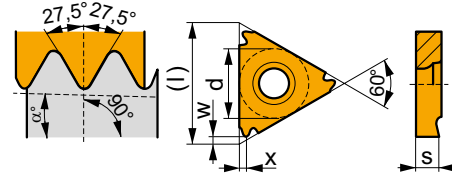


For tools see pages: T250 - T253

i	ANSI	T8030	P	M	K	N	S	H	?	r <sub>c</sub>	f <sub>min</sub>	f <sub>max</sub>	a <sub>p min</sub>	a <sub>p max</sub>	[mm]	1 <sup>23</sup> / <sub>1</sub> "	x	w
  	TN 16ER140BSPT	T8030	■	■	■	□	▣	□	●	+++	-	-	-	-	-	14.0	.059	.047
	TN 16ER110BSPT	T8030	■	■	■	□	▣	□	●	+++	-	-	-	-	-	11.0	.059	.047

## TN BSPT INT

	$\alpha^\circ$	d	l	s
16	1°47'	.375	.650	.137

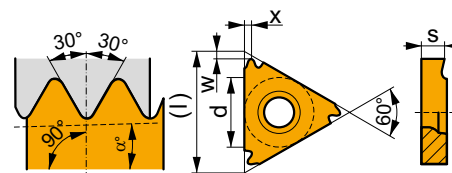


For tools see pages: T250 -T253

		ANSI		P	M	K	N	S	H			$r_e$	$f_{min}$	$f_{max}$	$a_{p\ min}$	$a_{p\ max}$			x	w
		TN 16NR140BSPT	T8030	■	■	■	□	▣	□	●	+++	-	-	-	-	-	-	14.0	.059	.047
		TN 16NR110BSPT	T8030	■	■	■	□	▣	□	●	+++	-	-	-	-	-	-	11.0	.059	.047

## TN NPT EXT

	$\alpha^\circ$	d	l	s
16	1°47'	.375	.650	.137

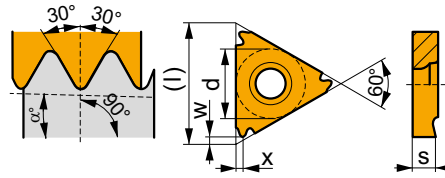


For tools see pages: T250 -T253

		ANSI		P	M	K	N	S	H			$r_e$	$f_{min}$	$f_{max}$	$a_{p\ min}$	$a_{p\ max}$			x	w
		TN 16ER270NPT	T8030	■	■	■	□	▣	□	●	+++	-	-	-	-	-	-	27.0	.031	.028
		TN 16ER180NPT	T8030	■	■	■	□	▣	□	●	+++	-	-	-	-	-	-	18.0	.031	.028
		TN 16ER140NPT	T8010	■	■	■	□	▣	□	●	+++	-	-	-	-	-	-	14.0	.059	.043
		TN 16ER115NPT	T8010	■	■	■	□	▣	□	●	+++	-	-	-	-	-	-	11.5	.059	.043
			T8030	■	■	■	□	▣	□	●	+++	-	-	-	-	-	-	11.5	.059	.043
		TN 16ER080NPT	T8030	■	■	■	□	▣	□	●	+++	-	-	-	-	-	-	8.0	.063	.043

## TN NPT INT

	$\alpha^\circ$	d	l	s
11	1°47'	.250	.433	.118
16	1°47'	.375	.650	.137

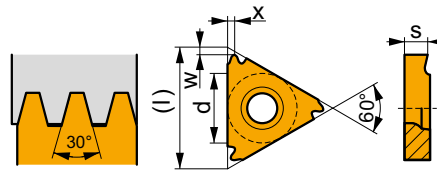


For tools see pages: T250 -T253

		ANSI		P	M	K	N	S	H			$r_c$	$f_{min}$	$f_{max}$	$a_{p min}$	$a_{p max}$			x	w
		TN 11NR180NPT	T8030	■	■	■	□	▣	□	●	+++	-	-	-	-	-	-	18.0	.031	.028
		TN 11NR140NPT	T8030	■	■	■	□	▣	□	●	+++	-	-	-	-	-	-	14.0	.039	.028
		TN 16NR140NPT	T8010	■	■	■	□	▣	□	●	+++	-	-	-	-	-	-	14.0	.059	.043
			T8030	■	■	■	□	▣	□	●	+++	-	-	-	-	-	-	14.0	.059	.043
		TN 16NR115NPT	T8010	■	■	■	□	▣	□	●	+++	-	-	-	-	-	-	11.5	.059	.043
			T8030	■	■	■	□	▣	□	●	+++	-	-	-	-	-	-	11.5	.059	.043
		TN 16NR080NPT	T8030	■	■	■	□	▣	□	●	+++	-	-	-	-	-	-	8.0	.063	.043

## TN TR EXT

	d	l	s
16	.375	.650	.137
22	.500	.866	.185

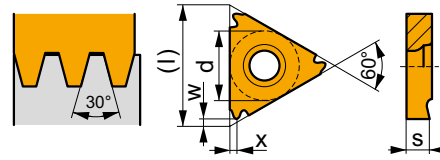


For tools see pages: T250 -T253

		ANSI		P	M	K	N	S	H			$r_c$	$f_{min}$	$f_{max}$	$a_{p min}$	$a_{p max}$			x	w
		TN 16ER150TR	T8030	■	■	■	□	▣	□	●	+++	-	-	-	-	-	1.50	-	.031	.035
		TN 16ER200TR	T8030	■	■	■	□	▣	□	●	+++	-	-	-	-	-	2.00	-	.059	.051
		TN 16ER300TR	T8030	■	■	■	□	▣	□	●	+++	-	-	-	-	-	3.00	-	.063	.051
		TN 22ER400TR	T8030	■	■	■	□	▣	□	●	+++	-	-	-	-	-	4.00	-	.087	.071
		TN 22ER500TR	T8030	■	■	■	□	▣	□	●	+++	-	-	-	-	-	5.00	-	.087	.071
		TN 16EL150TR	T8030	■	■	■	□	▣	□	●	+++	-	-	-	-	-	1.50	-	.031	.035
		TN 16EL200TR	T8030	■	■	■	□	▣	□	●	+++	-	-	-	-	-	2.00	-	.059	.051
		TN 16EL300TR	T8030	■	■	■	□	▣	□	●	+++	-	-	-	-	-	3.00	-	.063	.051
		TN 22EL400TR	T8030	■	■	■	□	▣	□	●	+++	-	-	-	-	-	4.00	-	.087	.071
		TN 22EL500TR	T8030	■	■	■	□	▣	□	●	+++	-	-	-	-	-	5.00	-	.087	.071

## TN TR INT

	d	l	s
16	.375	.650	.137
22	.500	.866	.185

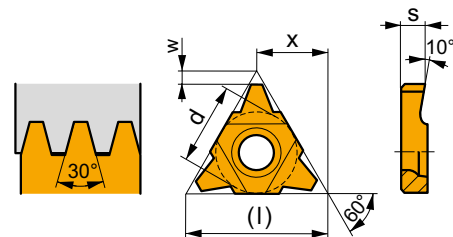


For tools see pages: T250 -T253

		ANSI		P	M	K	N	S	H			r <sub>c</sub>	f <sub>min</sub>	f <sub>max</sub>	a <sub>p min</sub>	a <sub>p max</sub>			x	w
		TN 16NR150TR	T8030	■	■	■	□	▣	□	●	+++	-	-	-	-	-	1.50	-	.031	.035
		TN 16NR200TR	T8030	■	■	■	□	▣	□	●	+++	-	-	-	-	-	2.00	-	.059	.051
		TN 16NR300TR	T8030	■	■	■	□	▣	□	●	+++	-	-	-	-	-	3.00	-	.063	.051
		TN 22NR400TR	T8030	■	■	■	□	▣	□	●	+++	-	-	-	-	-	4.00	-	.087	.071
		TN 22NR500TR	T8030	■	■	■	□	▣	□	●	+++	-	-	-	-	-	5.00	-	.087	.071
		TN 16NL150TR	T8030	■	■	■	□	▣	□	●	+++	-	-	-	-	-	1.50	-	.031	.035
	TN 16NL200TR	T8030	■	■	■	□	▣	□	●	+++	-	-	-	-	-	2.00	-	.059	.051	
	TN 16NL300TR	T8030	■	■	■	□	▣	□	●	+++	-	-	-	-	-	3.00	-	.063	.051	
	TN 22NL400TR	T8030	■	■	■	□	▣	□	●	+++	-	-	-	-	-	4.00	-	.087	.071	
	TN 22NL500TR	T8030	■	■	■	□	▣	□	●	+++	-	-	-	-	-	5.00	-	.087	.071	

## TN TR-S EXT

	d	l	s
22	.500	.866	.181

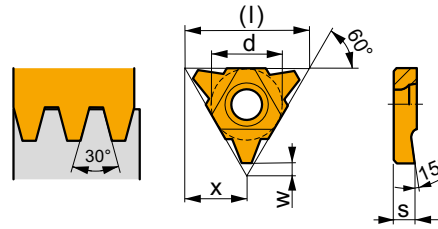


For tools see pages: T250 -T253

		ANSI		P	M	K	N	S	H			r <sub>c</sub>	f <sub>min</sub>	f <sub>max</sub>	a <sub>p min</sub>	a <sub>p max</sub>			x	w
		TN 22EN600TR	T8030	■	■	■	□	▣	□	●	+++	-	-	-	-	-	6.00	-	.433	.075
		TN 22EN700TR	T8030	■	■	■	□	▣	□	●	+++	-	-	-	-	-	7.00	-	.433	.091

## TN TR-S INT

	d	l	s
22	.500	.866	.181



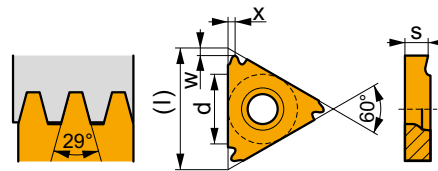
For tools see pages: T250 -T253

i	ANSI	T8030	P	M	K	N	S	H	?	r <sub>c</sub>	f <sub>min</sub>	f <sub>max</sub>	a <sub>p min</sub>	a <sub>p max</sub>	[mm]	1 2 3 / 1"	x	w	
1	TN 22NN600TR	T8030	■	■	■	□	▣	□	●	+++	-	-	-	-	-	6.00	-	.433	.075
	TN 22NN700TR	T8030	■	■	■	□	▣	□	●	+++	-	-	-	-	-	7.00	-	.433	.091
U																			
E																			



## TN ACME EXT

	d	l	s
16	.375	.650	.137
22	.500	.866	.185



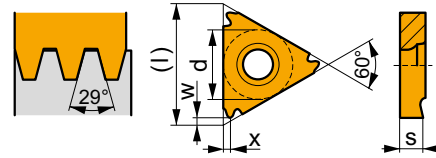
For tools see pages: T250 -T253

i	ANSI	T8030	P	M	K	N	S	H	?	r <sub>c</sub>	f <sub>min</sub>	f <sub>max</sub>	a <sub>p min</sub>	a <sub>p max</sub>	[mm]	1 2 3 / 1"	x	w	
1	TN 16ER120ACME	T8030	■	■	■	□	▣	□	●	+++	-	-	-	-	-	12.0	.059	.051	
	TN 16ER100ACME	T8030	■	■	■	□	▣	□	●	+++	-	-	-	-	-	10.0	.059	.051	
	TN 16ER080ACME	T8030	■	■	■	□	▣	□	●	+++	-	-	-	-	-	8.0	.059	.051	
	TN 22ER060ACME	T8030	■	■	■	□	▣	□	●	+++	-	-	-	-	-	6.0	.098	.079	
	TN 22ER050ACME	T8030	■	■	■	□	▣	□	●	+++	-	-	-	-	-	5.0	.091	.079	
1	TN 22EL060ACME	T8030	■	■	■	□	▣	□	●	+++	-	-	-	-	-	6.0	.098	.079	
	TN 22EL050ACME	T8030	■	■	■	□	▣	□	●	+++	-	-	-	-	-	5.0	.091	.079	
U																			
E																			



## TN ACME INT

	d	l	s
16	.375	.650	.137
22	.500	.866	.185

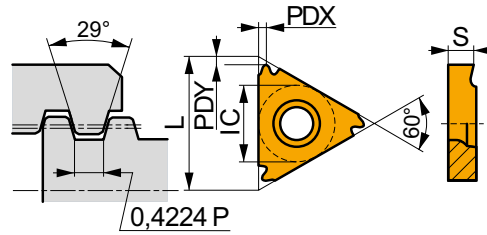


For tools see pages: T250 -T253

		ANSI		P	M	K	N	S	H			r <sub>c</sub>	f <sub>min</sub>	f <sub>max</sub>	a <sub>p min</sub>	a <sub>p max</sub>			x	w
		TN 16NR080ACME	T8030	■	■	■	□	▣	□	●	+++	-	-	-	-	-	-	8.0	.059	.051
		TN 22NR060ACME	T8030	■	■	■	□	▣	□	●	+++	-	-	-	-	-	-	6.0	.098	.079
		TN 22NR050ACME	T8030	■	■	■	□	▣	□	●	+++	-	-	-	-	-	-	5.0	.091	.079
		TN 22NL050ACME	T8030	■	■	■	□	▣	□	●	+++	-	-	-	-	-	-	5.0	.091	.079

## TN STACME EXT

	IC	L	S
16	3/8	.650	.137

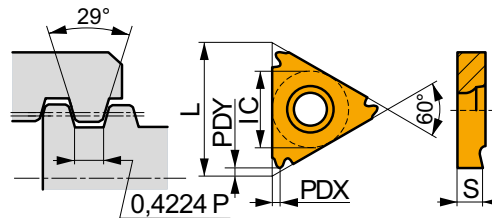


For tools see pages: T250 -T253

		ANSI		P	M	K	N	S	H			RE	FN	FX	CDN	CDX	TP	TPI	PDX	PDY	
   		TN 16ER160STACME	T8030	■	■	■		▣		●	+++	-	-	-	-	-	-	16	.031	.031	
		TN 16ER120STACME	T8030	■	■	■		▣		●	+++	-	-	-	-	-	-	-	12	.031	.031
		TN 16ER100STACME	T8030	■	■	■		▣		●	+++	-	-	-	-	-	-	-	10	.059	.051
		TN 16ER080STACME	T8030	■	■	■		▣		●	+++	-	-	-	-	-	-	-	8	.059	.051
		TN 16ER060STACME	T8030	■	■	■		▣		●	+++	-	-	-	-	-	-	-	6	.055	.051
   		TN 16EL160STACME	T8030	■	■	■		▣		●	+++	-	-	-	-	-	-	16	.031	.031	
		TN 16EL120STACME	T8030	■	■	■		▣		●	+++	-	-	-	-	-	-	-	12	.031	.031
		TN 16EL100STACME	T8030	■	■	■		▣		●	+++	-	-	-	-	-	-	-	10	.059	.051
		TN 16EL080STACME	T8030	■	■	■		▣		●	+++	-	-	-	-	-	-	-	8	.059	.051
		TN 16EL060STACME	T8030	■	■	■		▣		●	+++	-	-	-	-	-	-	-	6	.055	.051

## TN STACME INT

	IC	L	S
16	3/8	.650	.137



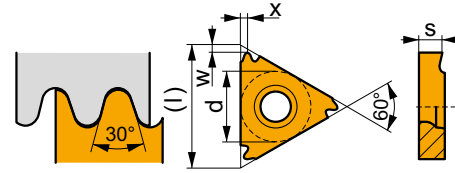
For tools see pages: T250 -T253

		ANSI		P	M	K	N	S	H			RE	FN	FX	CDN	CDX	TP	TPI	PDX	PDY	
   		TN 16NR160STACME	T8030	■	■	■		▣		●	+++	-	-	-	-	-	-	16	.031	.031	
		TN 16NR120STACME	T8030	■	■	■		▣		●	+++	-	-	-	-	-	-	-	12	.031	.031
		TN 16NR100STACME	T8030	■	■	■		▣		●	+++	-	-	-	-	-	-	-	10	.059	.051
		TN 16NR080STACME	T8030	■	■	■		▣		●	+++	-	-	-	-	-	-	-	8	.059	.051
		TN 16NR060STACME*	T8030	■	■	■		▣		●	+++	-	-	-	-	-	-	-	6	.051	.051
   		TN 16NL160STACME	T8030	■	■	■		▣		●	+++	-	-	-	-	-	-	16	.031	.031	
		TN 16NL120STACME	T8030	■	■	■		▣		●	+++	-	-	-	-	-	-	-	12	.031	.031
		TN 16NL100STACME	T8030	■	■	■		▣		●	+++	-	-	-	-	-	-	-	10	.059	.051
		TN 16NL080STACME	T8030	■	■	■		▣		●	+++	-	-	-	-	-	-	-	8	.059	.051
		TN 16NL060STACME*	T8030	■	■	■		▣		●	+++	-	-	-	-	-	-	-	6	.051	.051



## TN RD EXT

	d	l	s
16	.375	.650	.137
22	.500	.866	.185

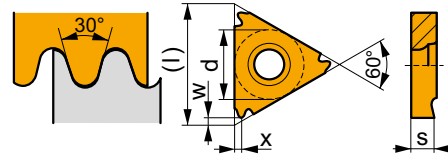


For tools see pages: T250 -T253

		ANSI		P	M	K	N	S	H			$r_s$	$f_{min}$	$f_{max}$	$a_{p min}$	$a_{p max}$		$\frac{123}{1''}$	x	w
		TN 16ER100RD	T8030	■	■	■	□	▣	□	●	+++	-	-	-	-	-	-	10.0	.059	.047
		TN 16ER080RD	T8030	■	■	■	□	▣	□	●	+++	-	-	-	-	-	-	8.0	.059	.047
		TN 16ER060RD	T8030	■	■	■	□	▣	□	●	+++	-	-	-	-	-	-	6.0	.059	.047
		TN 22ER060RD	T8030	■	■	■	□	▣	□	●	+++	-	-	-	-	-	-	6.0	.098	.071
		TN 22EL060RD	T8030	■	■	■	□	▣	□	●	+++	-	-	-	-	-	-	6.0	.098	.071

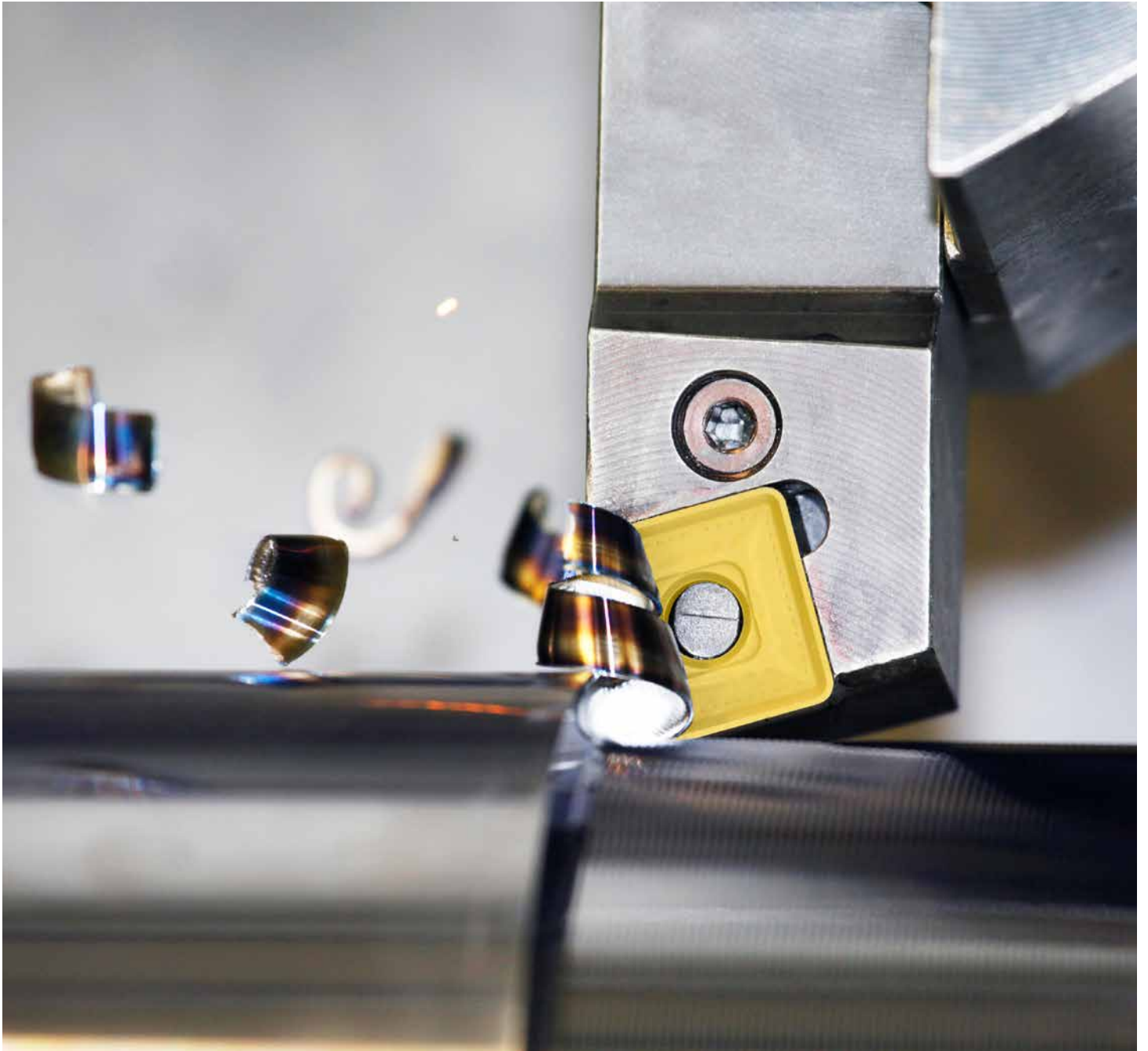
## TN RD INT

	d	l	s
16	.375	.650	.137
22	.500	.866	.185



For tools see pages: T250 -T253

		ANSI		P	M	K	N	S	H			$r_e$	$f_{min}$	$f_{max}$	$a_{p\ min}$	$a_{p\ max}$			x	w
		TN 16NR100RD	T8030	■	■	■	□	▣	□	●	+++	-	-	-	-	-	-	10.0	.059	.047
		TN 16NR080RD	T8030	■	■	■	□	▣	□	●	+++	-	-	-	-	-	-	8.0	.059	.047
		TN 16NR060RD	T8030	■	■	■	□	▣	□	●	+++	-	-	-	-	-	-	6.0	.059	.047
		TN 22NR060RD	T8030	■	■	■	□	▣	□	●	+++	-	-	-	-	-	-	6.0	.098	.071
		TN 22NL060RD	T8030	■	■	■	□	▣	□	●	+++	-	-	-	-	-	-	6.0	.098	.071



ISO/ANSI CODE DESIGNATION – EXTERNAL TURNING TOOLS  
 DESIGNACIÓN CÓDIGO ISO/ANSI - HERRAMIENTAS DE TORNEADO EXTERIOR  
 CODIFICATION ISO/ANSI - PORTE-OUTILS EXTERIEURS

<b>ISO</b>	<b>1</b>	<b>2</b>	<b>3</b>	<b>4</b>	<b>5</b>	-	<b>6</b>	<b>7</b>	<b>8</b>	<b>9</b>	-	<b>10</b>
	<b>P</b>	<b>C</b>	<b>L</b>	<b>N</b>	<b>R</b>		<b>32</b>	<b>25</b>	<b>L</b>	<b>12</b>		<b>S</b>
<b>ANSI</b>	<b>1</b>	<b>2</b>	<b>3</b>	<b>4</b>	<b>5</b>	-	<b>6 &amp; 7</b>		<b>9</b>	<b>8</b>		
	<b>D</b>	<b>C</b>	<b>L</b>	<b>N</b>	<b>R</b>		<b>16</b>	<b>4</b>	<b>D</b>			

<b>1</b>	<b>1</b>	<b>2</b>				<b>3</b>				
Clamping designation Tipo de fijación Désignation de la fixation		Insert shape Forma de plaqueta Forme de la plaquette				Holder style – cutting edge angle Tipo de herramienta - ángulo de posición Type d'outil - angle d'attaque				
C		H	O	P	R	A	B	C	D	D
D		S	T	C	D	E	F	G	H	J
P		E	M	V	W	K	L	M	N	P
M		L	A	B	K	Q	R	S	S	T
S						U	V	W	X	Y
X						Z			Special Especial Spécial	
G										

<b>4</b>	<b>4</b>		
Insert clearance angle Ángulo de incidencia Angle de dépeuille de la plaquette			
N	B	C	P
$\alpha_n=0^\circ$	$\alpha_n=5^\circ$	$\alpha_n=7^\circ$	$\alpha_n=11^\circ$

<b>5</b>	<b>5</b>
Direction of cut Dirección del corte Direction de coupe	
R	
L	
N	

<b>6 &amp; 7</b>	Shank width & Shank height [in] Anchura y altura del mango [in] Largeur de manche & hauteur de manche [in]	
	b [in]	h [in]
05	5/16	5/16
06	3/8	3/8
08	1/2	1/2
12	3/4	5/8
16	1	1
85	1	1 1/4
86	1	1 1/2
20	1 1/4	1 1/4
24	1 1/2	1 1/2
32	2	2

<b>8</b>	<b>8</b>			
Holder total length Longitud total Longueur totale de l'outil				
	$l_1$ [mm]			
	D	60		
	E	70		
	F	80		
	H	100		
	J	110		
	K	125		
	L	140		
	$l_1$ [in]	M	150	
	A	4.000	N	160
	B	4.500	P	170
	C	5.000	Q	180
	D	6.000	R	200
E	7.000	S	250	
F	8.000	T	300	
M	4.000	U	350	
N	4.500	V	400	
R	6.000	W	450	
S	7.000	X	Spec.	
T	8.000	Y	500	

For square shanks, the number is the width or height in terms of 16ths. For rectangular shanks the first digit is the width in terms of 8ths and the second digit is the height in terms of 4ths.

Para mangos cuadrados, el dígito indica el ancho o la altura en número de dieciseisavos de pulgada. Para mangos rectangulares, el primer dígito indica el ancho en número de octavos de pulgada y el segundo dígito indica la altura en número de cuartos de pulgada.

Pour les manches carrés, c'est le nombre 16 de la largeur et de la hauteur en pouce. Pour les manches rectangulaires le premier digit est le nombre 8 de la largeur en pouce et le second digit le nombre 4 de la hauteur en pouce.

<b>6</b>	Shank height [mm] Altura del mango [mm] Hauteur de manche [mm]				
08	10	12	16	20	25
32	38	40	45	50	60

<b>7</b>	Shank width [mm] Anchura del mango [mm] Largeur de manche [mm]				
08	10	12	16	20	25
32	38	40	45	50	60

ISO/ANSI CODE DESIGNATION – INTERNAL TURNING TOOLS  
 DESIGNACIÓN CÓDIGO ISO/ANSI - HERRAMIENTAS DE TORNEADO INTERIOR  
 CODIFICATION ISO/ANSI - PORTE-OUTILS INTÉRIEURS

<b>ISO</b>	<b>12</b>	<b>13</b>	<b>14</b>	-	<b>1</b>	<b>2</b>	<b>3</b>	<b>4</b>	<b>5</b>	<b>9</b>	-	<b>11</b>
	<b>A</b>	<b>25</b>	<b>T</b>	-	<b>P</b>	<b>C</b>	<b>L</b>	<b>N</b>	<b>L</b>	<b>12</b>	-	<b>X</b>
<b>ANSI</b>	<b>12</b>	<b>13</b>	<b>14</b>	-	<b>1</b>	<b>2</b>	<b>3</b>	<b>4</b>	<b>5</b>	<b>9</b>		
	<b>A</b>	<b>16</b>	<b>T</b>	-	<b>D</b>	<b>C</b>	<b>L</b>	<b>N</b>	<b>L</b>	<b>4</b>		

d = I.C.		Insert cutting edge length (insert size) Longitud del filo de corte (tamaño de plaquita) Longueur de l'arête de coupe (taille de plaquette)												
		H	O	P	S	T	C	D	E	M	V	W	R	K
[mm]	[in]													
3,97	5/32"				03	06		04			06	02		
4,76	3/16"				04	08	04	05	04	04	08	L3		
5,56	7/32"				05	09	05	06	05	05	09	03		
6,35	1/4"	03	02	04	08	11	06	07	08	08	11	04	06	
7,94	5/16"	04	03	05	07	13	08	09	06	07	13	05	07	
9,525	3/8"	05	04	07	09	16	09	11	09	09	16	06	09	16
12,7	1/2"	07	05	09	12	22	12	15	13	12	22	08	12	
15,875	5/8"	09	06	11	15	27	16	19	16	15	27	10	15	
19,05	3/4"	11	07	13	19	33	19	23	19	19	33	13	19	
25,40	1"	14	10	18	25	44	25	31	26	25	44	17	25	
31,75	1 1/4"	18	13	23	31	54	32	38	32	31	54	21	31	
								10						

<b>10</b>	
	Manufacturer's designation Designación del fabricante Désignation du fabricant
<b>M</b>	Clamping system "S" with shim Sistema de fijación "S" con placa base Système de fixation "S" avec assise
<b>S</b>	Holder with adjusting screws Portaherramientas con tornillos de ajuste Outil avec vis de réglage
<b>11</b>	
	Manufacturer's designation Designación del fabricante Désignation du fabricant
<b>X</b>	Special shank style Tipo de mango especial Type de queue spéciale
.	.
<b>93</b>	Z - style tool setting angle Ángulo de herramienta tipo Z Angle d'attaque - Outil type Z
.	.

<b>12</b>		<b>12</b>	
	Shank Mango Queue		
<b>S</b>	Steel shank Mango de acero Queue en acier		
<b>A</b>	Steel shank with coolant hole Mango de acero con refrigeración interna Queue en acier avec trou d'arrosage		
<b>E</b>	Tungsten carbide shank with coolant hole Mango de metal duro con refrigeración interna Queue en carbure avec trou d'arrosage		

<b>13</b>		<b>13</b>	
	Shank Ø [mm] Mango Ø [mm] Queue Ø [mm]		
	d [mm]		d [in]
	08	8	03
	10	10	04
	12	12	05
	16	16	06
	20	20	08
	25	25	10
	32	32	12
	40	40	16
	50	50	20
	60	60	1.250

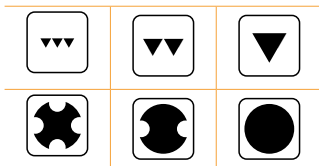
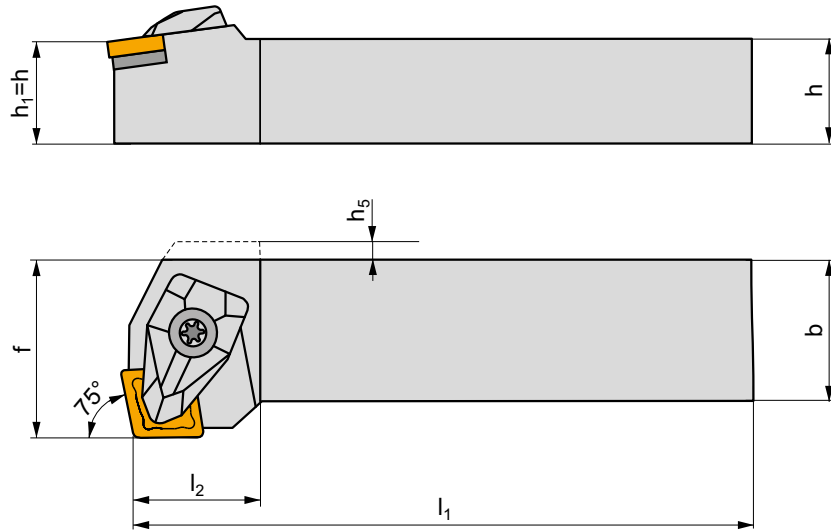
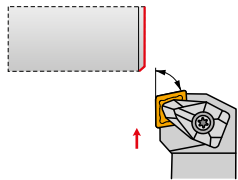
<b>14</b>		<b>14</b>	
	Holder total length Longitud total Longueur totale de l'outil		
			$l_1$ [mm]
		<b>D</b>	60
		<b>E</b>	70
		<b>F</b>	80
		<b>H</b>	100
		<b>J</b>	110
<b>F</b>	3.250	<b>K</b>	125
<b>H</b>	4.000	<b>L</b>	140
<b>K</b>	5.000	<b>M</b>	150
<b>M</b>	6.000	<b>N</b>	160
<b>P</b>	6.250	<b>P</b>	170
<b>Q</b>	7.250	<b>Q</b>	180
<b>R</b>	8.000	<b>R</b>	200
<b>S</b>	10.000	<b>S</b>	250
<b>T</b>	12.000	<b>T</b>	300
<b>U</b>	14.000	<b>U</b>	350
<b>V</b>	15.750	<b>V</b>	400
<b>W</b>	17.750	<b>W</b>	450
<b>Y</b>	20.000	<b>X</b>	Spec.
<b>X</b>	Spec.	<b>Y</b>	500

**DCKN(RL) EXT**

**P M K N S H**

**D**

T44 - T56



ANSI	$h=h_1$	b	f	$l_1$	$l_2$	$h_5$	$\lambda^\circ$	$\gamma^\circ$	lbs	IGI005	DC12	IAT001
DCKNR/L 16 4D	1.000	1.000	1.250	6.000	1.300	-	-6	-6	1.54	IGI005	DC12	IAT001

IGI005	CN.. 43.										
--------	----------	--	--	--	--	--	--	--	--	--	--

DC12	DCS 12	3.9	DCS 234-01	US 2002-T15P	FLAG T15P/3.5	-
------	--------	-----	------------	--------------	---------------	---

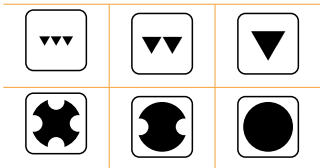
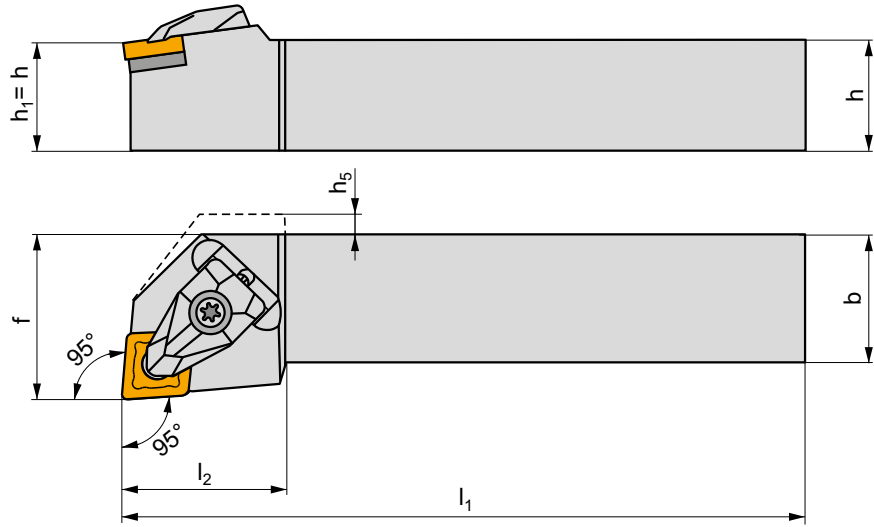
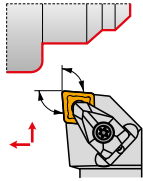
IAT001	CN.. 45.	-	DCS 234-02
IAT001	CER CN.N 43.	DCS 12C4	-
IAT001	CER CN.A 43.	DCS 12C2	-

# DCLN(RL) EXT

**P** **M** **K** **N** **S** **H**

**D**





T44 - T56



ANSI	$h=h_1$	$b$	$f$	$l_1$	$l_2$	$h_5$	$\lambda_s^\circ$	$\gamma^\circ$	lbs			
DCLNR/L 10 3A	.625	.625	.875	4.000	.980	-	-6	-6	.44	IGI004	DC09	-
DCLNR/L 12 3C	.750	.750	1.000	5.000	.980	-	-6	-6	1.06	IGI004	DC09	-
DCLNR/L 12 4B	.750	.750	1.000	4.500	1.260	-	-6	-6	.88	IGI005	DC12	IAT001
DCLNR/L 16 4D	1.000	1.000	1.250	6.000	1.260	-	-6	-6	1.54	IGI005	DC12	IAT001
DCLNR/L 85 4D	1.250	1.000	1.500	6.000	1.260	-	-6	-6	4.70	IGI005	DC12	IAT001
DCLNR/L 85 5D	1.250	1.000	1.500	6.000	1.540	-	-6	-6	4.70	IGI006	DC16	IAT005
DCLNR/L 20 6D	1.250	1.250	1.500	6.000	1.700	-	-6	-6	2.76	IGI007	DC19	-
DCLNR/L 24 6D	1.500	1.500	2.000	6.000	1.700	-	-6	-6	4.96	IGI007	DC19	-
DCLNR/L 24 8E	1.500	1.500	2.000	7.000	2.090	-	-6	-6	6.17	IGI008	DC25	-

IGI004	CN.. 32.
IGI005	CN.. 43.
IGI006	CN.. 54.
IGI007	CN.. 64.
IGI008	CN.. 86.

DC09	DCS 09	1.7	DCS 236-04	US 2004-T09P	FLAG T09P	-
DC12	DCS 12	3.9	DCS 234-01	US 2002-T15P	FLAG T15P/3.5	-
DC16	DCS 16	6.4	DCS 234-03	US 2007-T20P	-	LK T20P
DC19	DCS 19	6.4	DCS 236-01	US 2007-T20P	-	LK T20P
DC25	DCS 25	9.5	DCS 234-05	US 2008-T25P	-	LK T25P

			
IAT001	CN.. 45.	-	DCS 234-02
IAT005	CN.. 55.	-	DCS 234-04
IAT001	CER CN.N 43.	DCS 12C4	-
IAT001	CER CN.A 43.	DCS 12C2	-
IAT005	CER CN.N 54.	DCS 16C4	-
IAT005	CER CN.A 54.	DCS 16C2	-

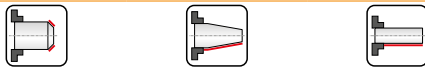
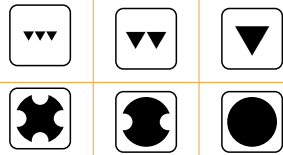
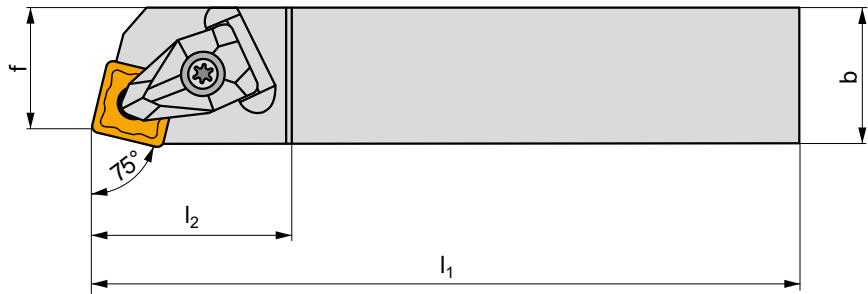
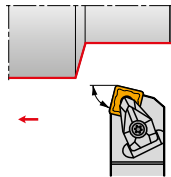


# DCRN(RL) EXT

P M K N S H

D

T44 - T56



ANSI	$h=h_1$	b	f	$l_1$	$l_2$	$\lambda^\circ$	$\gamma^\circ$	lbs			
DCRNR/L 12 4B	.750	.750	.855	4.500	1.350	-6	-6	.88	IGI005	DC12	IAT001
DCRNR/L 16 4D	1.000	1.000	1.048	6.000	1.350	-6	-6	1.54	IGI005	DC12	IAT001
DCRNR/L 20 4D	1.250	1.250	1.292	6.000	1.350	-6	-6	2.76	IGI005	DC12	IAT001
DCRNR/L 20 5D	1.250	1.250	1.291	6.000	1.640	-6	-6	2.76	IGI006	DC16	IAT005
DCRNR/L 20 6D	1.250	1.250	1.291	6.000	1.820	-6	-6	2.76	IGI007	DC19	-
DCRNR/L 24 6D	1.500	1.500	1.697	6.000	1.820	-6	-6	4.96	IGI007	DC19	-

IGI005					CN.. 43.						
IGI006					CN.. 54.						
IGI007					CN.. 64.						

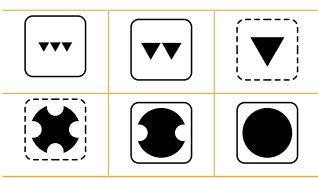
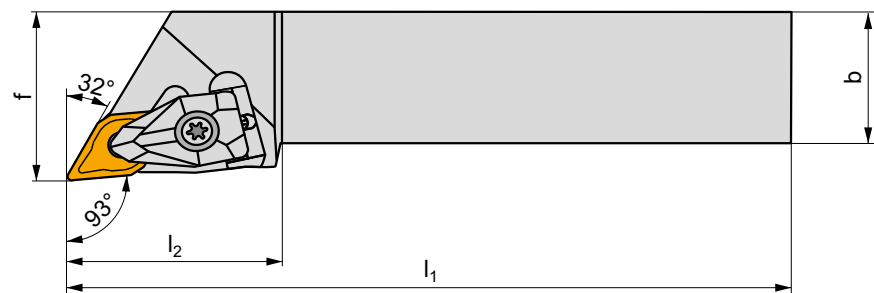
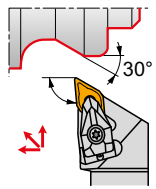
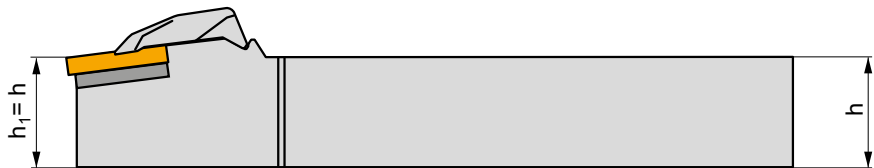
DC12	DCS 12	3.9	DCS 234-01	US 2002-T15P	FLAG T15P/3.5
DC16	DCS 16	6.4	DCS 234-03	US 2007-T20P	-
DC19	DCS 19	6.4	DCS 236-01	US 2007-T20P	-

IAT001	CN.. 45.		-	DCS 234-02
IAT005	CN.. 55.		-	DCS 234-04
IAT001	CER CN.N 43.		DCS 12C4	-
IAT001	CER CN.A 43.		DCS 12C2	-
IAT005	CER CN.N 54.		DCS 16C4	-
IAT005	CER CN.A 54.		DCS 16C2	-

**DDJN(RL) EXT**

**P M K N S H**

**D**  
T62 - T70



ANSI	$h=h_1$	b	f	$l_1$	$l_2$	$\lambda_c^\circ$	$\gamma^\circ$	lbs			
DDJNR/L 12 3C	.750	.750	1.000	5.000	1.190	-6	-6	1.06	IGI011	DD11	-
DDJNR/L 16 3D	1.000	1.000	1.250	6.000	1.190	-6	-6	1.54	IGI011	DD11	-
DDJNR/L 12 4B	.750	.750	1.000	4.500	1.450	-6	-6	.88	IGI012	DD156	IAT002
DDJNR/L 16 4D	1.000	1.000	1.250	6.000	1.550	-6	-6	1.54	IGI012	DD156	IAT002
DDJNR/L 20 4D	1.250	1.250	1.500	6.000	1.550	-6	-6	2.76	IGI012	DD156	IAT002

IGI011											
IGI012											

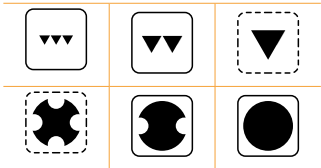
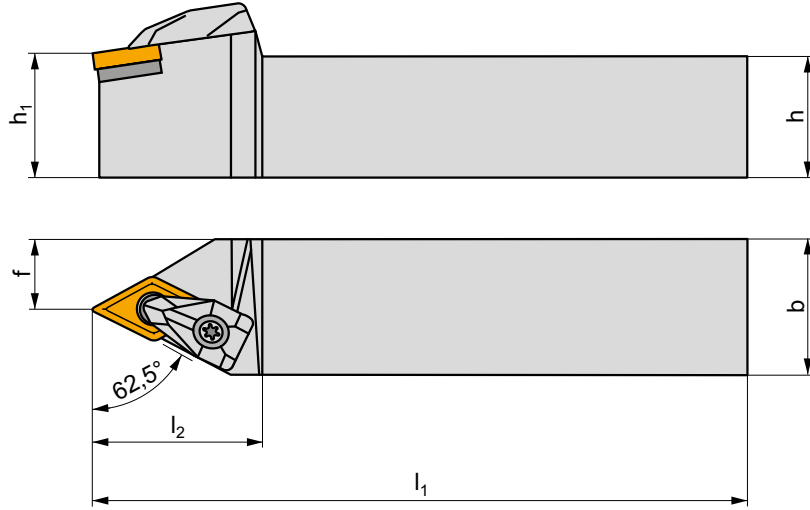
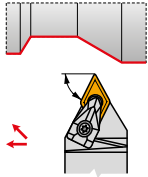
DD11	DCS 09	1.7		DDS 267-01		US 2004-T09P	FLAG T09P
DD156	DCS 12	3.9		DDS 266-01		US 2002-T15P	FLAG T15P/3.5

IAT002	DN.. 44.		-	DDS 266-02
IAT002	CER DN.N 44.		DCS 12C4	DDS 266-02
IAT002	CER DN.A 44.		DCS 12C2	DDS 266-02

# DDPNN EXT

P M K N S H

T62 - T70



ANSI	$h=h_1$	b	f	$l_1$	$l_2$	$\lambda_s^\circ$	$\gamma^\circ$	lbs	IGI011	IGI012	DD11	DD156	IAT002
<b>DDPNN 12 3B</b>	.750	.750	.375	4.500	1.230	-9	-5	1.06	IGI011	IGI012	DD11	DD156	-
<b>DDPNN 16 4D</b>	1.000	1.000	.500	6.000	1.610	-9	-5	1.54	IGI011	IGI012	DD11	DD156	IAT002

IGI011	DN.. 33.
IGI012	DN.. 43.

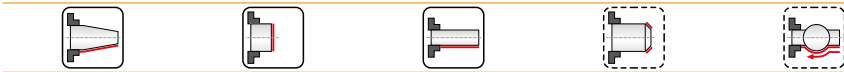
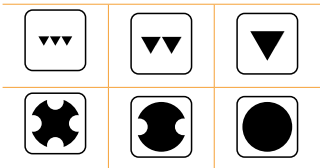
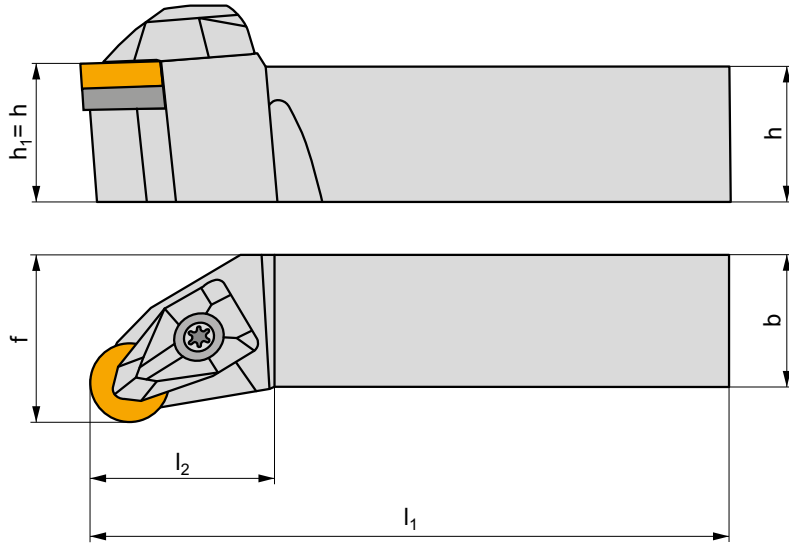
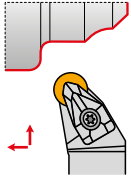
DD11	DCS 09	1.7	DDS 267-01	US 2004-T09P	FLAG T09P
DD156	DCS 12	3.9	DDS 266-01	US 2002-T15P	FLAG T15P/3.5

IAT002	DN.. 44.	-	DDS 266-02
IAT002	CER DN.N 44.	DCS 12C4	DDS 266-02
IAT002	CER DN.A 44.	DCS 12C2	DDS 266-02

**DRSNR EXT**

**P M K**

**D**  
T80



ANSI	$h=h_1$	b	f	$l_1$	$l_2$	$\lambda_s^\circ$	$\gamma^\circ$	lbs	IGI038	DR12
DRSNR 16 4D	1.000	1.000	1.250	6.000	1.244	-6	-6	1.54	IGI038	DR12

IGI038					RN.. 43					
--------	--	--	--	--	---------	--	--	--	--	--

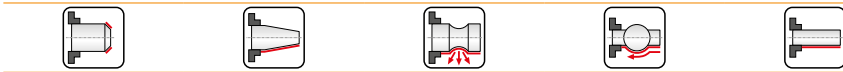
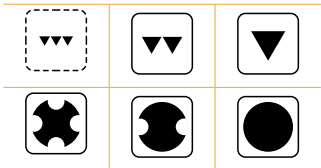
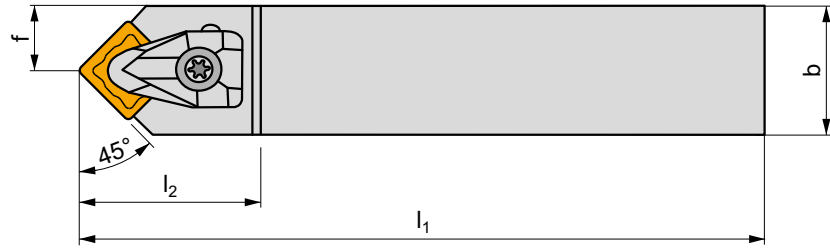
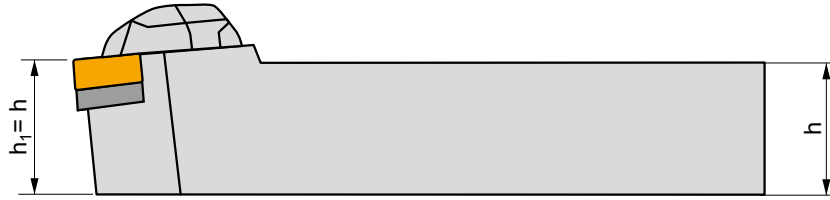
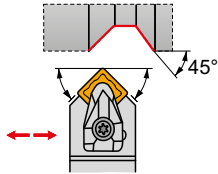
DR12	DCS 12	3.9		DRS 155-02		US 2002-T15P			FLAG T15P/3.5	
------	--------	-----	--	------------	--	--------------	--	--	---------------	--

# DSDNN EXT

P M K N S H

D

T85-T94



ANSI	$h=h_1$	b	f	$l_1$	$l_2$	$\lambda^\circ$	$\gamma^\circ$	lbs			
DSDNN 12 4B	.750	.750	.386	4.500	1.450	-6	-6	.88	IGI040	DS12	IAT003
DSDNN 16 4D	1.000	1.000	.512	6.000	1.450	-6	-6	1.54	IGI040	DS12	IAT003
DSDNN 20 5D	1.250	1.250	.646	6.000	1.760	-6	-6	2.76	IGI041	DS15	IAT006
DSDNN 20 6D	1.250	1.250	.646	6.000	1.970	-6	-6	2.76	IGI042	DS19	-
DSDNN 24 8D	1.500	1.500	.791	6.000	2.260	-6	-6	4.96	IGI043	DS25	-

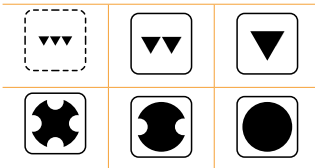
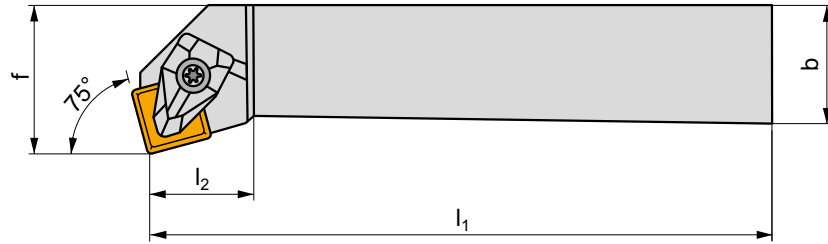
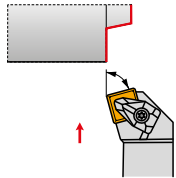
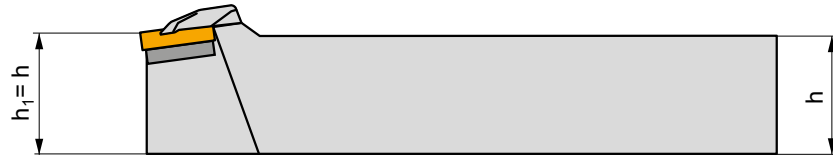
IGI040		SN.. 43.
IGI041		SN.. 54.
IGI042		SN.. 64.
IGI043		SN.. 85.

DS12	DCS 12	3.9	DSS 425-01	US 2002-T15P	FLAG T15P/3.5	-
DS15	DCS 16	6.4	DSS 425-03	US 2007-T20P	-	LK T20P
DS19	DCS 19	6.4	DSS 425-04	US 2007-T20P	-	LK T20P
DS25	DCS 25	9.5	DSS 425-07	US 2008-T25P	-	LK T25P

**DSKN(RL) EXT**

**P M K N S H**

**D**  
T85-T94



ANSI	$h=h_1$	b	f	$l_1$	$l_2$	$\lambda^\circ$	$\gamma^\circ$	lbs	IGI040	DS12	IAT003
DSKNR/L 16 4D	1.000	1.000	1.250	6.000	.930	-6	-6	1.54	IGI040	DS12	IAT003
DSKNR/L 20 5D	1.250	1.250	1.500	6.000	1.140	-6	-6	2.76	IGI041	DS15	IAT006

IGI040	SN.. 43.
IGI041	SN.. 54.

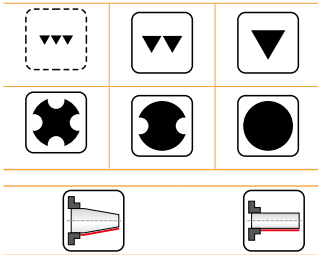
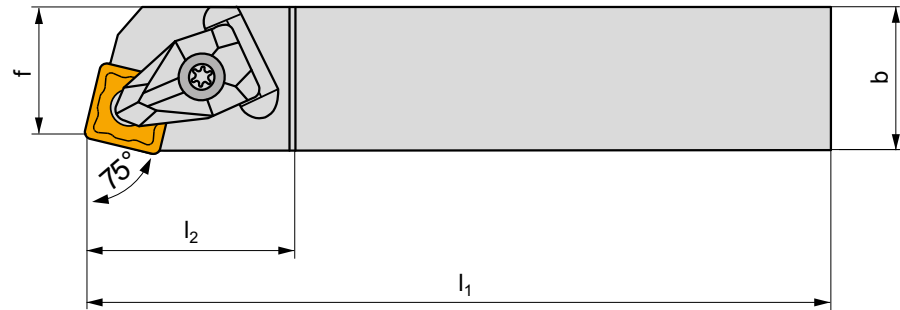
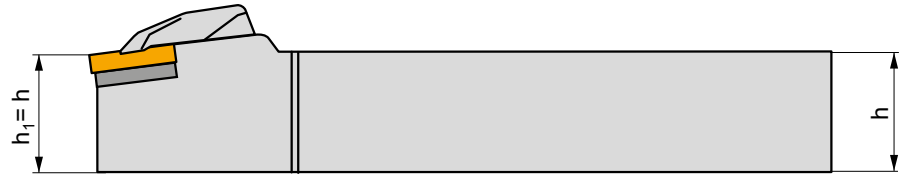
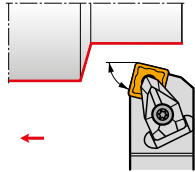
DS12	DCS 12	Nm	DSS 425-01	US 2002-T15P	FLAG T15P/3.5	-
DS15	DCS 16	6.4	DSS 425-03	US 2007-T20P	-	LK T20P

IAT003	SN.. 45.	-	DSS 425-02
IAT006	SN.. 55.	-	DSS 425-05
IAT003	CER SN.N 43.	DCS 12C4	-
IAT003	CER SN.A 43.	DCS 12C2	-
IAT006	CER SN.N 54.	DCS 16C4	-
IAT006	CER SN.A 54.	DCS 16C2	-

# DSRN(RL) EXT

P M K N S H





T85-T94



ANSI	$h=h_1$	$b$	$f$	$l_1$	$l_2$	$\lambda^\circ$	$\gamma^\circ$	lbs	IGI	DS	IAT
DSRNR/L 12 4B	.750	.750	.855	4.500	1.350	-6	-6	.88	IGI040	DS12	IAT003
DSRNR/L 16 4D	1.000	1.000	1.048	6.000	1.350	-6	-6	1.54	IGI040	DS12	IAT003
DSRNR/L 20 5D	1.250	1.250	1.291	6.000	1.640	-6	-6	2.76	IGI041	DS15	IAT006
DSRNR/L 20 6D	1.250	1.250	1.292	6.000	1.830	-6	-6	2.76	IGI042	DS19	-
DSRNR/L 24 6D	1.500	1.500	1.697	6.000	1.830	-6	-6	4.96	IGI042	DS19	-
DSRNR/L 24 8E	1.500	1.500	1.697	7.000	2.220	-6	-6	6.17	IGI043	DS25	-

IGI	SN.
IGI040	SN.. 43.
IGI041	SN.. 54.
IGI042	SN.. 64.
IGI043	SN.. 85.

DS	DCS	Nm	DSS	US	FLAG
DS12	DCS 12	3.9	DSS 425-01	US 2002-T15P	FLAG T15P/3.5
DS15	DCS 16	6.4	DSS 425-03	US 2007-T20P	-
DS19	DCS 19	6.4	DSS 425-04	US 2007-T20P	-
DS25	DCS 25	9.5	DSS 425-07	US 2008-T25P	-

			
IAT003	SN.. 45.	-	DSS 425-02
IAT006	SN.. 55.	-	DSS 425-05
IAT003	CER SN.N 43.	DCS 12C4	-
IAT003	CER SN.A 43.	DCS 12C2	-
IAT006	CER SN.N 54.	DCS 16C4	-
IAT006	CER SN.A 54.	DCS 16C2	-

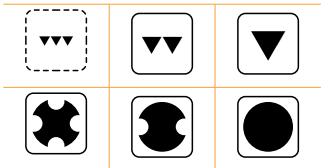
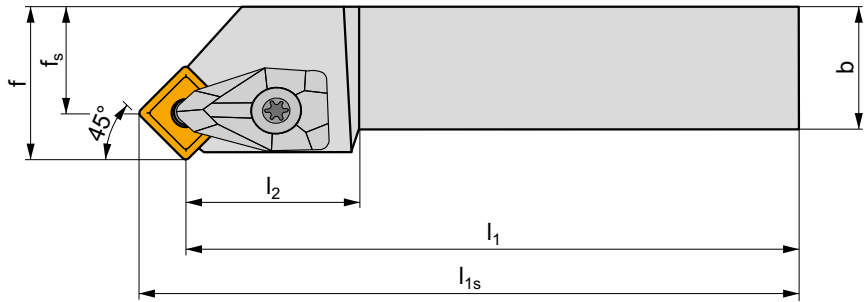
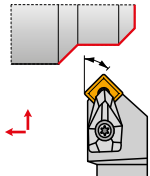
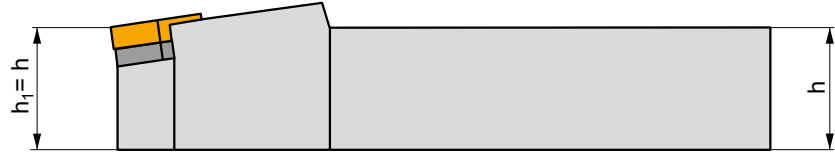


# DSSN(RL) EXT

P M K N S H

D

T85-T94



ANSI	$h=h_1$	$b$	$f$	$f_s$	$l_1$	$l_{1s}$	$l_2$	$\lambda_c^\circ$	$\gamma^\circ$	lbs			
DSSNR/L 12 4B	.750	.750	1.000	.740	4.500	4.880	1.130	0	-8	.88	IGI040	DS12	IAT003
DSSNR/L 16 4D	1.000	1.000	1.250	.925	6.000	6.327	1.172	0	-8	1.54	IGI040	DS12	IAT003
DSSNR/L 20 5D	1.250	1.250	1.500	1.098	6.000	6.413	1.303	0	-8	2.76	IGI041	DS15	IAT006
DSSNR/L 20 6D	1.250	1.250	1.500	1.008	6.000	6.492	1.413	0	-8	2.76	IGI042	DS19	-
DSSNR/L 24 6E	1.500	1.500	2.000	1.508	7.000	7.492	1.484	0	-8	6.17	IGI042	DS19	-

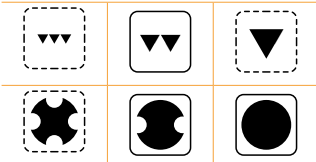
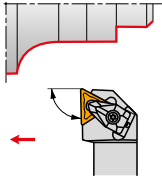
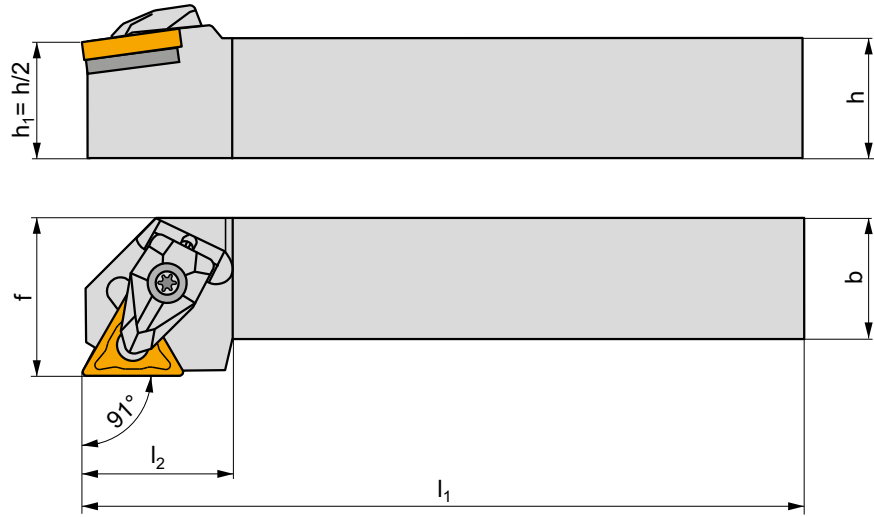
IGI040		SN.. 43.
IGI041		SN.. 54.
IGI042		SN.. 64.

DS12	DCS 12	3.9	DSS 425-01	US 2002-T15P	FLAG T15P/3.5	-
DS15	DCS 16	6.4	DSS 425-03	US 2007-T20P	-	LK T20P
DS19	DCS 19	6.4	DSS 425-04	US 2007-T20P	-	LK T20P

# DTGN(RL) EXT

P M K N S H

**D**  
T100-T107



ANSI	$h=h_1$	b	f	$l_1$	$l_2$	$\lambda_s^\circ$	$\gamma^\circ$	lbs		
DTGNR/L 12 3B	.750	.750	1.000	4.500	.970	-6	-6	.88	IGI058	DT16
DTGNR/L 16 3D	1.000	1.000	1.250	6.000	.970	-6	-6	1.54	IGI058	DT16
DTGNR/L 16 4D	1.000	1.000	1.250	6.000	1.260	-6	-6	1.54	IGI059	DT22
DTGNR/L 20 4D	1.250	1.250	1.500	6.000	1.310	-6	-6	2.76	IGI059	DT22
DTGNR/L 24 5D	1.500	1.500	2.000	6.000	1.550	-6	-6	4.96	IGI060	DT27

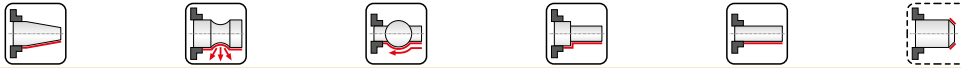
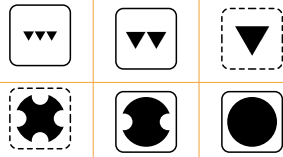
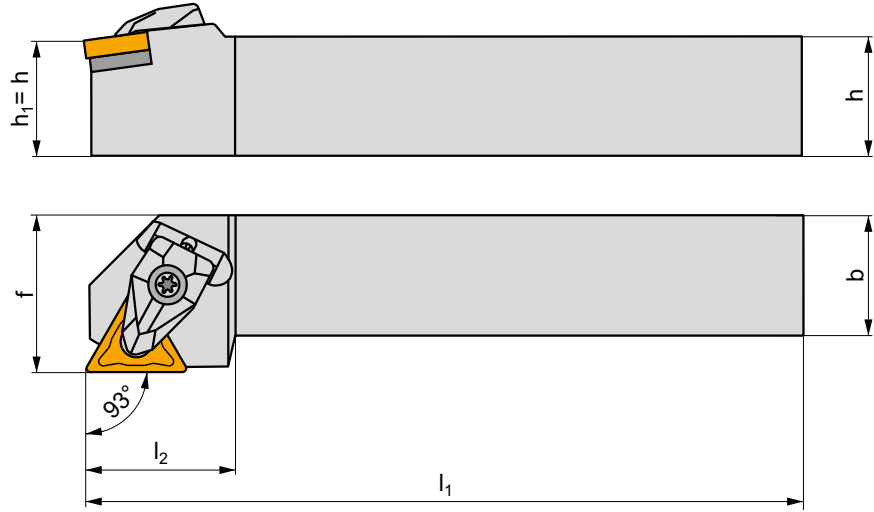
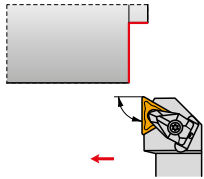
IGI058	TN.. 33.
IGI059	TN.. 43.
IGI060	TN.. 54.

DT16	DCS 09	1.7	DTS 315-02	US 2004-T09P	FLAG T09P
DT22	DCS 12	3.9	DTS 315-04	US 2002-T15P	FLAG T15P/3.5
DT27	DCS 16	6.4	DTS 315-05	US 2007-T20P	LK T20P

# DTJN(RL) EXT

P M K N S H

T100-T107



ANSI	$h=h_1$	b	f	$l_1$	$l_2$	$\lambda_s^\circ$	$\gamma^\circ$	lbs	IGI058	DT16
DTJNR/L 12 3B	.750	.750	1.000	4.500	.953	-6	-6	.88	IGI058	DT16
DTJNR/L 16 3D	1.000	1.000	1.250	6.000	.980	-6	-6	1.54	IGI058	DT16
DTJNR/L 20 4D	1.250	1.250	1.500	6.000	1.283	-6	-6	2.76	IGI059	DT22

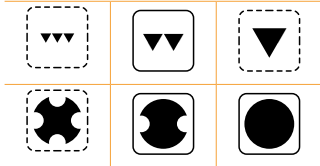
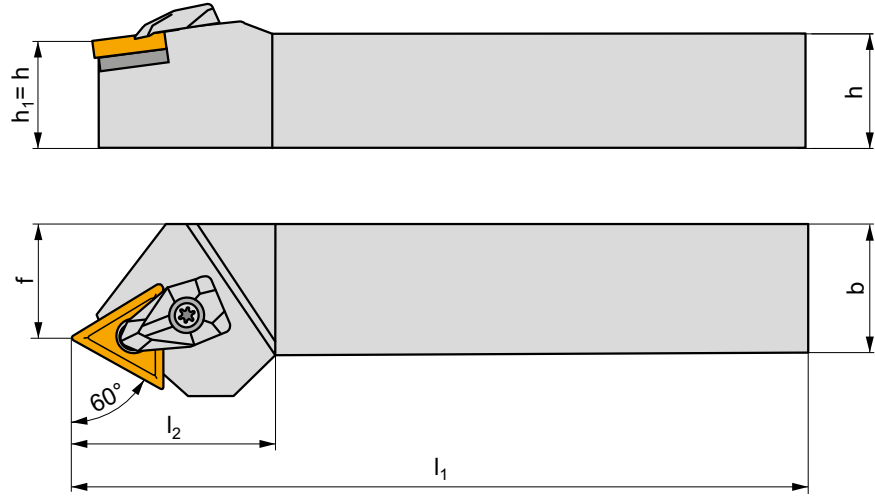
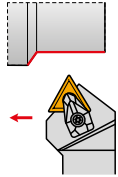
IGI058	TN.. 33.
IGI059	TN.. 43.

DT16	DCS 09	Nm	DTS 315-02	US 2004-T09P	FLAG T09P
DT22	DCS 12	3.9	DTS 315-04	US 2002-T15P	FLAG T15P/3.5

# DTTN(RL) EXT

P M K N S H

T100-T107



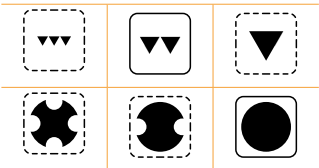
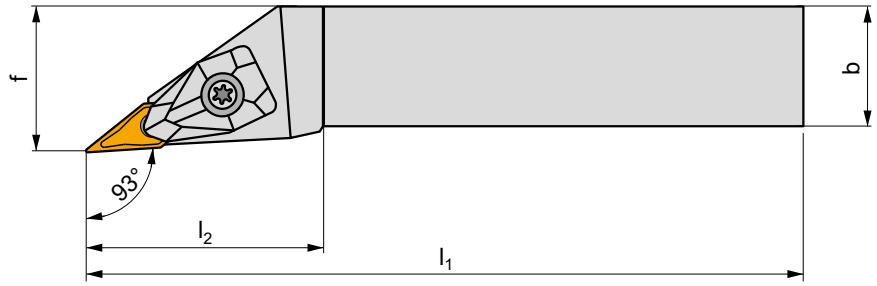
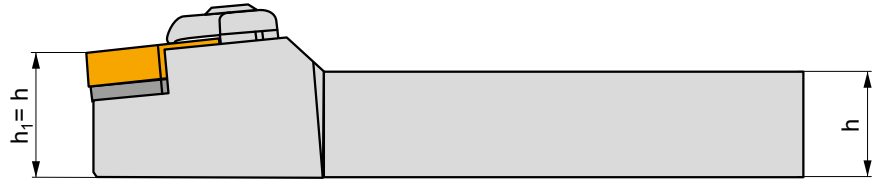
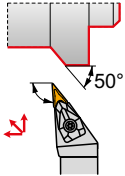
ANSI	$h=h_1$	b	f	$l_1$	$l_2$	$\lambda^\circ$	$\gamma^\circ$	lbs	IGI058	DT16
DTNR/L 12 3B	.750	.750	.598	4.500	1.190	-6	-6	.88	IGI058	DT16
DTNR/L 16 4D	1.000	1.000	.791	6.000	1.560	-6	-6	1.54	IGI059	DT22

IGI058	TN.. 33.
IGI059	TN.. 43.

DT16	DCS 09	Nm	DTS 315-02	US 2004-T09P	FLAG T09P
DT22	DCS 12	3.9	DTS 315-04	US 2002-T15P	FLAG T15P/3.5

**DVJN(RL) EXT**

**P M K N S H**



ANSI	$h=h_1$	b	f	$l_1$	$l_2$	$\lambda^\circ$	$\gamma^\circ$	lbs	IGI063	DV16
DVJNR/L 12 3B	.750	.750	1.000	4.500	1.830	-13	-4	.88	IGI063	DV16
DVJNR/L 16 3D	1.000	1.000	1.250	6.000	1.830	-13	-4	1.54	IGI063	DV16
DVJNR/L 20 3D	1.250	1.250	1.500	6.000	1.830	-13	-4	2.76	IGI063	DV16

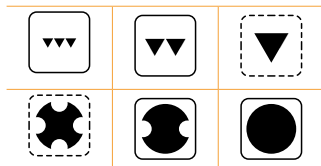
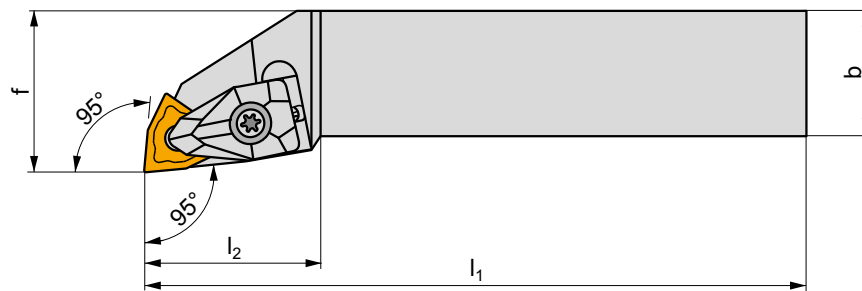
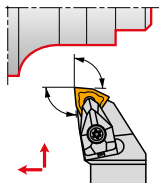
IGI063	VN.. 33.
--------	----------

DV16	DCS 16V	3.0 Nm	DVS 269-01	US 2009-T15P	FLAG T15P/3.5
------	---------	--------	------------	--------------	---------------

# DWLN(RL) EXT

P M K N S H

**D**  
T121-T128



ANSI	$h=h_1$	b	f	$l_1$	$l_2$	$\lambda_c^\circ$	$\gamma^\circ$	lbs			
DWLN/R 10 3B	.625	.625	.875	4.500	1.070	-6	-6	.60	IGI066	DW06	-
DWLN/R 12 3C	.750	.750	1.000	5.000	1.950	-6	-6	1.06	IGI066	DW06	-
DWLN/R 16 3D	1.000	1.000	1.250	6.000	1.950	-6	-6	1.54	IGI066	DW06	-
DWLN/R 12 4C	.750	.750	1.000	5.000	1.378	-6	-6	1.06	IGI067	DW08	IAT004
DWLN/R 16 4D	1.000	1.000	1.250	6.000	1.350	-6	-6	1.54	IGI067	DW08	IAT004
DWLN/R 20 4D	1.250	1.250	1.500	6.000	1.378	-6	-6	2.76	IGI067	DW08	IAT004

IGI066	WN.. 33.
IGI067	WN.. 43.

DW06	DCS 09	1.7	DWS 328-01	US 2004-T09P	FLAG T09P	-
DW08	DCS 12	3.9	DWS 331-12	US 2002-T15P	FLAG T15P/3.5	-

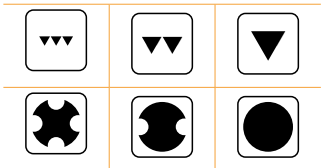
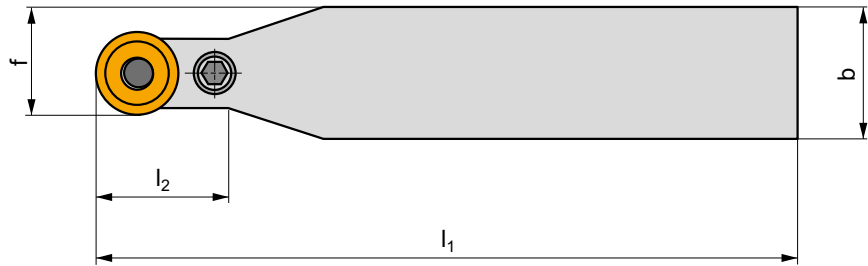
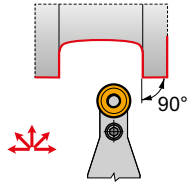
IAT004	CER WN.N 43.	DCS 12C4
IAT004	CER WN.A 43.	DCS 12C2

# PRDCN EXT

**P M K**

**P**

T78-T80



ANSI	$h=h_1$	b	f	$l_1$	$l_2$	$\lambda_s^\circ$	$\gamma_s^\circ$	lbs	IGI	IPRP
PRDCN 3225 P 16	1.260	.984	.807	6.693	1.260	0	0	1.76	IGI035	IPRP70
PRDCN 3232 P 20	1.260	1.260	1.024	6.693	1.260	0	0	2.87	IGI036	IPRP90
PRDCN 4040 S 20	1.575	1.575	1.181	9.843	1.575	0	0	6.83	IGI036	IPRP90
PRDCN 4040 S 25	1.575	1.575	1.280	9.843	1.575	0	0	7.05	IGI037	IPRP80

IGI035	RCMX 1606MO
IGI036	RCMX 2006MO
IGI037	RCMX 2507MO

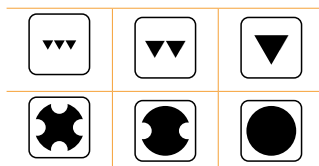
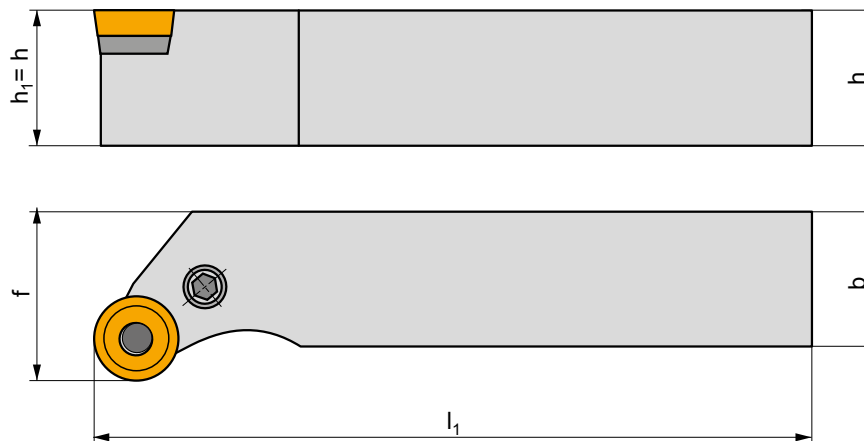
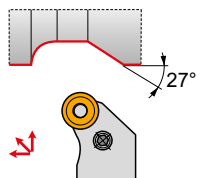
IPRP	RCU	PU	US	Nm	Thread	Length	NT	MT	HXX
IPRP70	RCU 160300	PU 07	US 36	6.0	M8x1	1.02	NT 05	MT 05	HXX 4
IPRP80	RCU 250600	PU 08	US 38	8.0	M10x1	1.14	NT 06	MT 06	HXX 5
IPRP90	RCU 200400	PU 09	US 36	6.0	M8x1	1.02	NT 07	MT 07	HXX 4

# PRSCR(RL) EXT

**P M K**

**P**

T78-T80



ANSI	$h=h_1$	$b$	$f$	$l_1$	$\lambda_s^\circ$	$\gamma_s^\circ$	lbs		
PRSCR/L 3225 P 16	1.260	.984	.807	6.693	0	0	1.98	IGI035	IPRP70
PRSCR/L 3232 P 20	1.260	1.260	1.024	6.693	0	0	3.09	IGI036	IPRP90
PRSCR/L 4040 S 25	1.575	1.575	1.280	9.843	0	0	7.50	IGI037	IPRP80

IGI035	RCMX 1606MO
IGI036	RCMX 2006MO
IGI037	RCMX 2507MO

IPRP70	RCU 160300	PU 07	US 36	6.0	M8x1	1.02	NT 05	MT 05	HXK 4
IPRP80	RCU 250600	PU 08	US 38	8.0	M10x1	1.14	NT 06	MT 06	HXK 5
IPRP90	RCU 200400	PU 09	US 36	6.0	M8x1	1.02	NT 07	MT 07	HXK 4

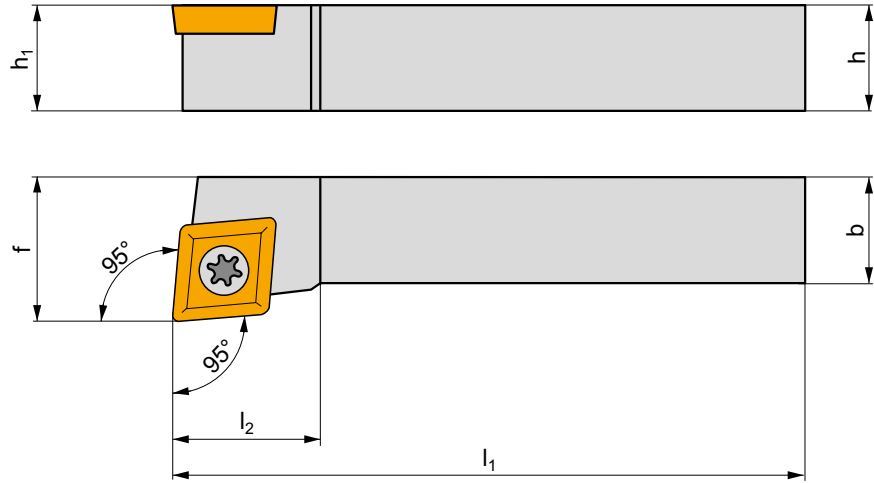
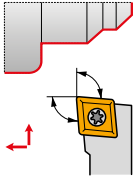


# SCLC(RL) EXT

P M K N S H

S

T36-T43



ANSI	$h=h_1$	b	f	$l_1$	$l_2$	$\lambda^\circ$	$\gamma^\circ$	lbs		
SCLCR/L 06 2	.375	.375	.500	2.500	.390	0	0	.24	IGI001	ISC06
SCLCR/L 08 3	.500	.500	.625	3.500	.390	0	0	.33	IGI002	ISC09
SCLCR/L 10 3	.625	.625	.750	4.000	.630	0	0	.62	IGI002	ISC095
SCLCR/L 12 4B	.750	.750	1.000	4.500	.830	0	0	.88	IGI003	ISC12
SCLCR/L 16 4D	1.000	1.000	1.250	6.000	.830	0	0	1.54	IGI003	ISC12



IGI001  
IGI002  
IGI003

CC.. 21.5.  
CC.. 32.5.  
CC.. 43.



ISC06  
ISC09  
ISC095  
ISC12

US 2003-T07P  
US 2010-T15P  
US 2001-T15P  
US 2018-T15P

.8  
3.0  
3.0  
3.0

M2.5  
M3.5  
M3.5  
M4

.26  
.40  
.48  
.55

-  
-  
SCS 232-01  
SCS 232-02

-  
-  
MS 9001  
MS 9003

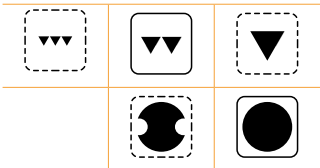
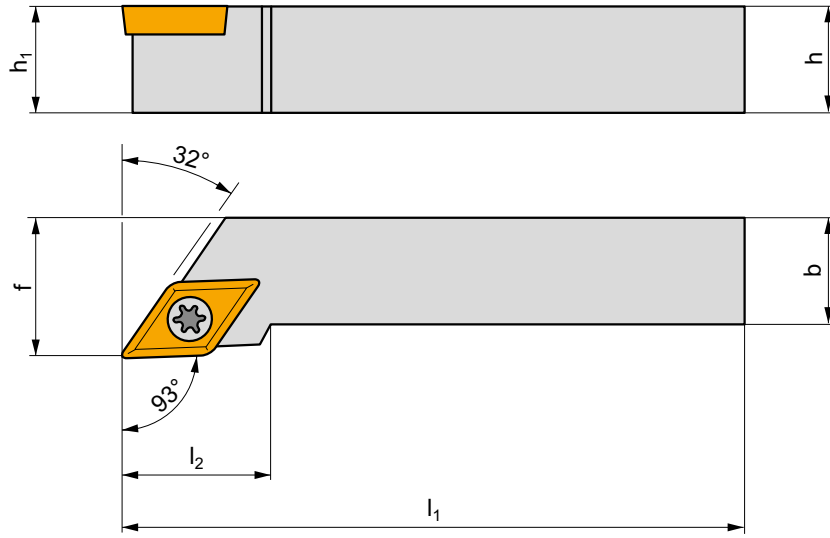
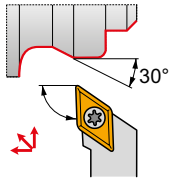
FLAG T07P  
FLAG T15P/3.5  
FLAG T15P/3.5  
FLAG T15P/4

-  
-  
-  
-

**SDJCR(L) EXT**

**P M K N S H**

**S**  
T57-T61



ANSI	$h=h_1$	$b$	$f$	$l_1$	$l_2$	$\lambda_s^\circ$	$\gamma^\circ$	lbs		
SDJCR/L 06 2	.375	.375	.500	2.500	.590	0	0	.24	IGI009	ISD07
SDJCR/L 08 2	.500	.500	.625	3.500	.670	0	0	.33	IGI009	ISD07
SDJCR/L 12 3B	.750	.750	1.000	4.500	.940	0	0	.88	IGI010	ISD11V
SDJCR/L 16 3D	1.000	1.000	1.250	6.000	1.100	0	0	1.54	IGI010	ISD11V

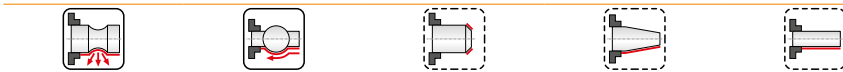
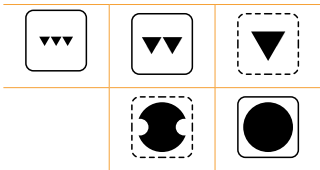
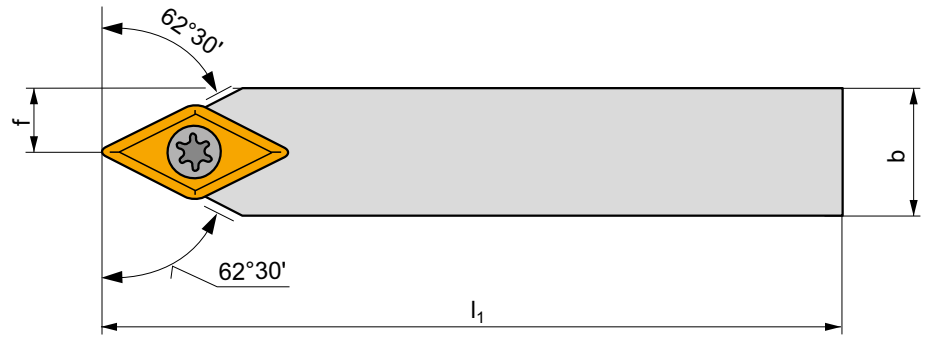
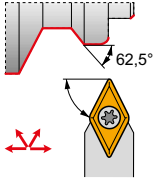
IGI009										DC.. 21.5.
IGI010										DC.. 32.5.

ISD07	US 2003-T07P	.8	M2.5	.26	-	-	FLAG T07P	-
ISD11V	US 2001-T15P	3.0	M3.5	.48	SDS 263-01	MS 9001	FLAG T15P/3.5	-

# SDPCN EXT

P M K N S H

T57-T61



ANSI	$h=h_1$	$b$	$f$	$l_1$	$l_2$	$\lambda_s^\circ$	$\gamma^\circ$	$\gamma_f$	lbs		
<b>SDPCN 06 2</b>	.375	.375	.216	2.500	.571	0	0	-	.24	IGI009	ISD07
<b>SDPCN 08 2</b>	.500	.500	.279	3.482	.571	0	0	-	.33	IGI009	ISD07
<b>SDPCN 10 3</b>	.625	.625	.341	4.000	.862	0	0	-	.62	IGI010	ISD11V
<b>SDPCN 12 3B</b>	.750	.750	.404	4.500	.862	0	0	-	.88	IGI010	ISD11V
<b>SDPCN 16 3C</b>	1.000	1.000	.529	5.000	.890	0	0	-	1.54	IGI010	ISD11V

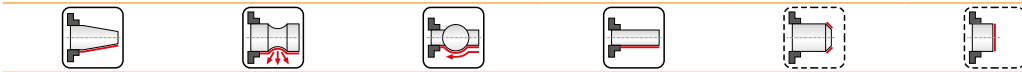
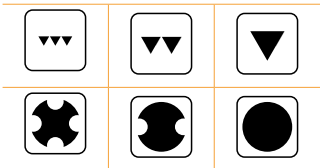
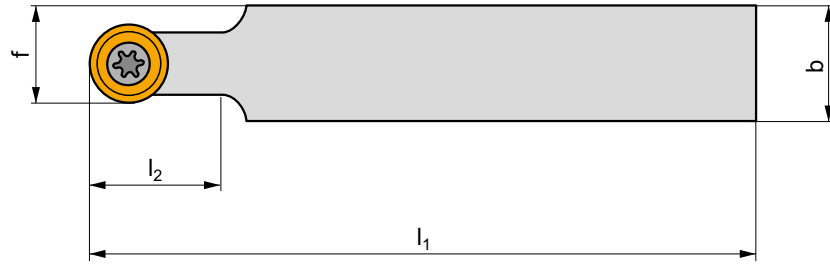
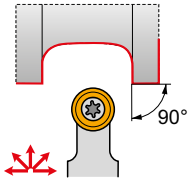
IGI009						DC.. 21.5.					
IGI010						DC.. 32.5.					

ISD07	US 2003-T07P	.8	M2.5	.26	-	-	FLAG T07P	-
ISD11V	US 2001-T15P	3.0	M3.5	.48	SDS 263-01	MS 9001	FLAG T15P/3.5	-

# SRDCN EXT

P M K N S H

S  
T76-T77



ANSI	h=h <sub>1</sub>	b	f	l <sub>1</sub>	l <sub>2</sub>	λ <sub>c</sub> °	γ°	lbs	IGI	ISO
SRDCN 1212 F 06	.472	.472	.354	3.150	.472	0	0	.22	IGI029	ISO1
SRDCN 1616 H 06	.630	.630	.433	3.937	.472	0	0	.44	IGI029	ISO1
SRDCN 2020 K 08	.787	.787	.551	4.921	.787	0	0	.88	IGI030	ISO3
SRDCN 2020 K 1003-M-A	.787	.787	.591	4.921	.984	0	0	.88	IGI031	ISR10
SRDCN 2020 K 10-M-A	.787	.787	.591	4.921	.984	0	0	.88	IGI032	ISR10
SRDCN 2525 M 10-M-A	.984	.984	.689	5.906	.984	0	0	1.54	IGI032	ISR10
SRDCN 2525 M 12-M-A	.984	.984	.728	5.906	1.181	0	0	1.54	IGI033	ISR12
SRDCN 3225 P 10-M	1.260	.984	.689	6.693	.984	0	0	1.98	IGI032	ISR10
SRDCN 3225 P 12-M	1.260	.984	.728	6.693	1.181	0	0	1.98	IGI033	ISR12
SRDCN 3225 P 16-M	1.260	.984	.807	6.693	1.260	0	0	2.20	IGI034	ISR16

IGI	RCMT
IGI029	RCMT 0602MO
IGI030	RCMT 0803MO
IGI031	RCMT 1003MO
IGI032	RCMT 10T3MO
IGI033	RCMT 1204MO
IGI034	RCMT 1606MO

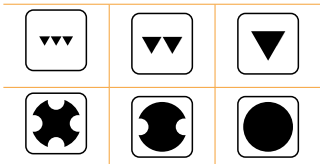
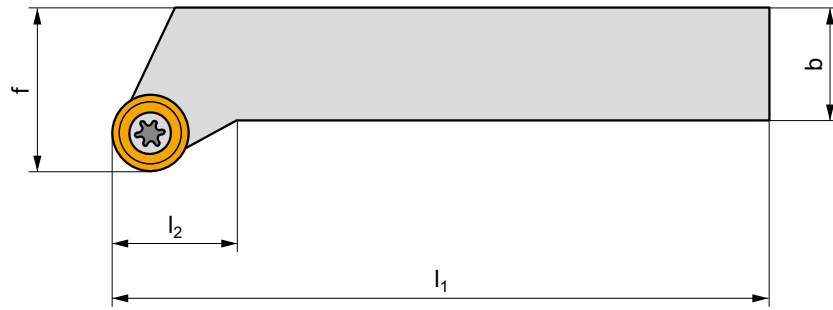
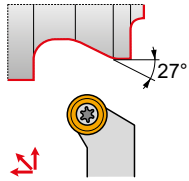
ISO	US	Nm	M	mm	mm	mm	mm	mm
ISO1	US 2506-T07P	.9	M2.5	.25	-	-	FLAG T07P	-
ISO3	US 3007-T09P	2.0	M3	.29	-	-	FLAG T09P	-
ISR10	US 3510-T15P	3.0	M3.5	.42	SRN 100300	MS 3510	FLAG T15P	HXK 3.5
ISR12	US 3510-T15P	3.0	M3.5	.42	SRN 120300	MS 3510	FLAG T15P	HXK 3.5
ISR16	US 5018-T20P	5.0	M5	.71	SRN 16T3MO	MS 5015	FLAG T20P	HXK 5

# SRSC(RL) EXT

P M K N S H

S

T76-T77



ANSI	$h=h_1$	b	f	$l_1$	$l_2$	$\lambda^\circ$	$\gamma^\circ$	lbs	IGI	ISO
SRSCR/L 1616 H 06	.630	.630	.787	3.937	.472	0	0	.49	IGI029	ISO1
SRSCR/L 2020 K 08	.787	.787	.984	4.921	.787	0	0	.99	IGI030	ISO3
SRSCR/L 2020 K 10-M-A	.787	.787	.984	4.921	.787	0	0	.99	IGI032	ISR10
SRSCR/L 2525 M 10-M-A	.984	.984	1.260	5.906	.787	0	0	1.65	IGI032	ISR10
SRSCR/L 2525 M 12-M-A	.984	.984	1.260	5.906	.787	0	0	1.65	IGI033	ISR12
SRSCR/L 3225 P 16-M	1.260	.984	1.260	6.693	.787	0	0	2.43	IGI034	ISR16

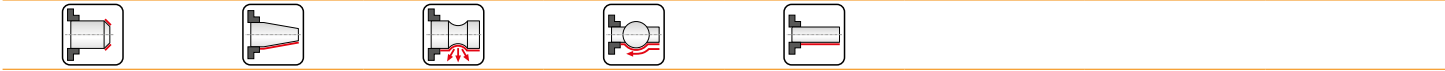
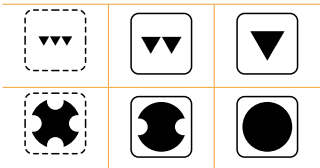
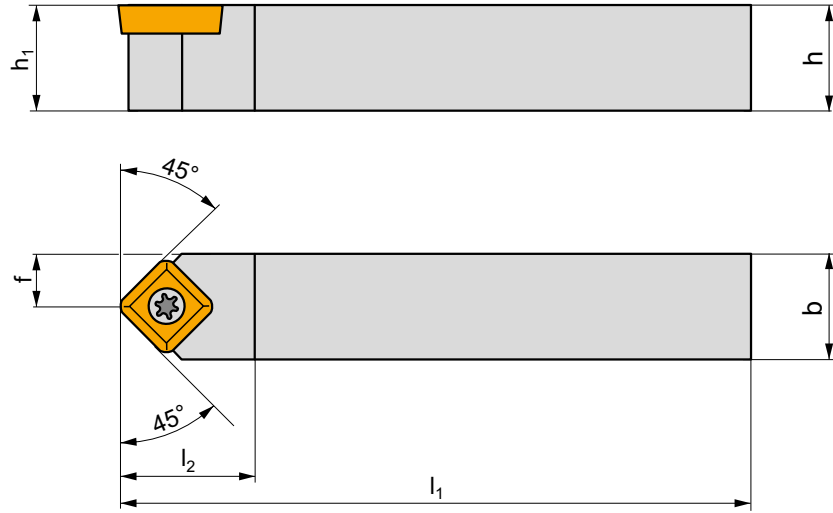
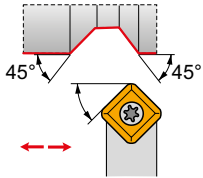
IGI	RCMT
IGI029	RCMT 0602MO
IGI030	RCMT 0803MO
IGI032	RCMT 10T3MO
IGI033	RCMT 1204MO
IGI034	RCMT 1606MO

ISO	US	Nm	M	mm	mm	mm	mm	mm	mm
ISO1	US 2506-T07P	.9	M2.5	.25	-	-	FLAG T07P	-	-
ISO3	US 3007-T09P	2.0	M3	.29	-	-	FLAG T09P	-	-
ISR10	US 3510-T15P	3.0	M3.5	.42	SRN 100300	MS 3510	FLAG T15P	HXK 3.5	-
ISR12	US 3510-T15P	3.0	M3.5	.42	SRN 120300	MS 3510	FLAG T15P	HXK 3.5	-
ISR16	US 5018-T20P	5.0	M5	.71	SRN 16T3MO	MS 5015	FLAG T20P	HXK 5	-

# SSDCN EXT

P M K N S H

S  
T81-T84



ANSI	$h=h_1$	b	f	$l_1$	$l_2$	$\lambda^\circ$	$\gamma^\circ$	lbs	IGI039	ISS09
SSDCN 08 3	.500	.500	.261	3.500	.594	0	0	.33	IGI039	ISS09
SSDCN 10 3	.625	.625	.323	4.000	.594	0	0	.62	IGI039	ISS095

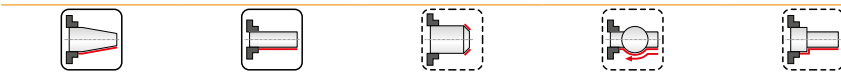
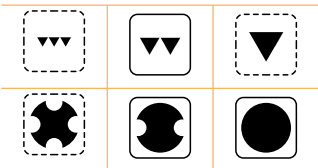
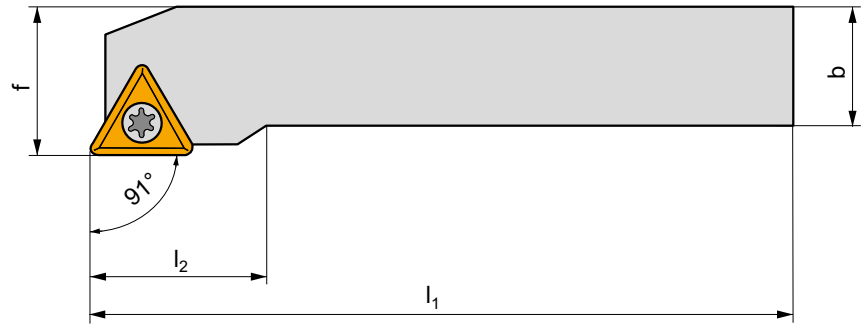
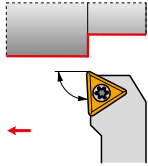
IGI039	SC.. 32.5.
--------	------------

ISS09	US 2010-T15P	Nm	M3.5	.40	-	-	FLAG T15P/3.5	-
ISS095	US 2010-T15P	3.0	M3.5	.40	SSS 420-01	MS 9001	FLAG T15P/3.5	-

# STGC(RL) EXT

P M K N S H

T96-T99



ANSI	$h=h_1$	b	f	$l_1$	$l_2$	$\lambda_s^\circ$	$\gamma^\circ$	lbs		
STGCR/L 08 2	.500	.500	.625	3.500	.543	0	0	.33	IGI044	IST11
STGCR/L 12 3B	.750	.750	1.000	4.500	.815	0	0	.88	IGI045	IST16
STGCR/L 16 3D	1.000	1.000	1.250	6.000	.815	0	0	1.54	IGI045	IST16

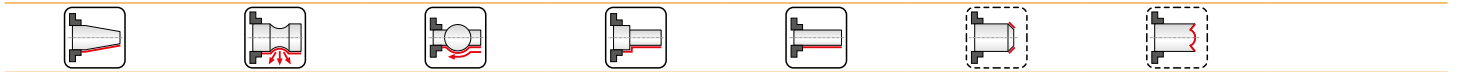
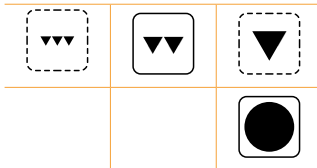
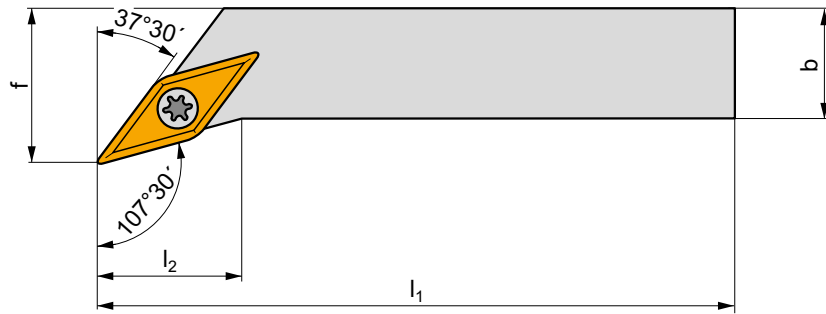
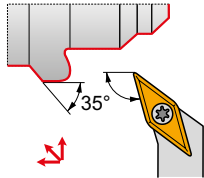
IGI044	TC.. 21.5.
IGI045	TC.. 32.5.

IST11	US 2003-T07P	.8	M2.5	.26	-	-	FLAG T07P	-
IST16	US 2001-T15P	3.0	M3.5	.48	STS 320-01	MS 9001	FLAG T15P/3.5	-

**SVHB(C)(RL) EXT**

P M K N S H

**S**  
T108-T116



ANSI	$h=h_1$	b	f	$l_1$	$l_2$	$\lambda^\circ$	$\gamma^\circ$	lbs		
SVHBR/L 12 3B	.750	.750	1.000	4.500	1.087	0	0	.88	IGI062	ISV16S
SVHBR/L 16 3D	1.000	1.000	1.250	6.000	1.087	0	0	1.54	IGI062	ISV16S

IGI062	VB.. 33.	VC.. 33.

ISV16S	US 2001-T15P	3.0	M3.5	.48	SVS 270-01	MS 9001	FLAG T15P/3.5	-

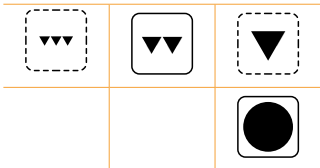
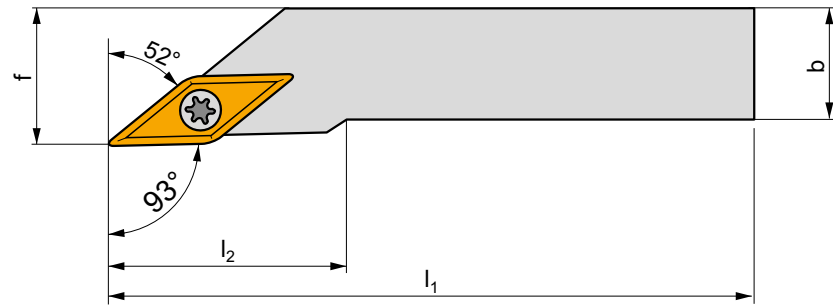
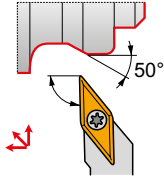


# SVJB(C)(RL) EXT

P M K N S H

S

T108-T116



ANSI	$h=h_1$	b	f	$l_1$	$l_2$	$\lambda_s^\circ$	$\gamma^\circ$	lbs		
SVJBR/L 10 2	.625	.625	.750	4.000	.835	0	0	.22	IGI061	ISV11
SVJBR/L 12 2B	.750	.750	1.000	4.500	.835	0	0	.88	IGI061	ISV11
SVJBR/L 12 3B	.750	.750	1.000	4.500	1.228	0	0	.88	IGI062	ISV16S
SVJBR/L 16 3D	1.000	1.000	1.250	6.000	1.240	0	0	1.54	IGI062	ISV16S
SVJBR/L 20 3D	1.250	1.250	1.500	6.000	1.240	0	0	2.76	IGI062	ISV16S

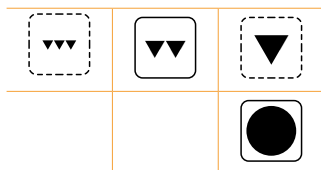
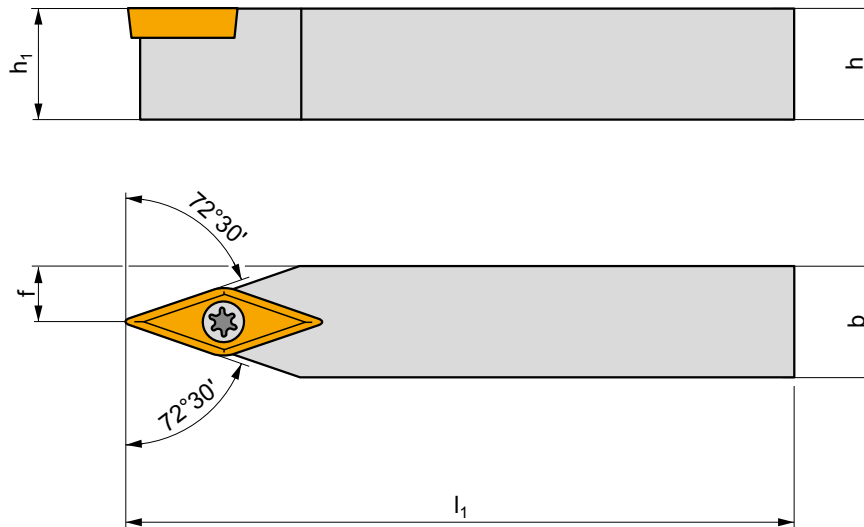
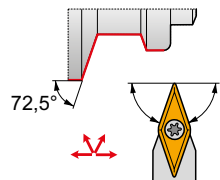
IGI061		VB.. 22.		VC.. 22.
IGI062		VB.. 33.		VC.. 33.

ISV11	US 2003-T07P	.8	M2.5	.26	-	-	FLAG T07P	-
ISV16S	US 2001-T15P	3.0	M3.5	.48	SVS 270-01	MS 9001	FLAG T15P/3.5	-

# SVVB(C)N EXT

P M K N S H

S  
T108-T116



ANSI	$h=h_1$	b	f	$l_1$	$l_2$	$\lambda_c^\circ$	$\gamma^\circ$	lbs		
SVVBN 08 2	.500	.500	.260	3.500	.831	0	0	.22	IGI061	ISV11
SVVBN 12 2B	.750	.750	.384	4.500	.831	0	0	.88	IGI061	ISV11
SVVBN 12 3B	.750	.750	.395	4.500	1.240	0	0	.88	IGI062	ISV16S
SVVBN 16 3D	1.000	1.000	.520	6.000	1.240	0	0	1.54	IGI062	ISV16S
SVVBN 20 3D	1.250	1.250	.645	6.000	1.240	0	0	2.76	IGI062	ISV16S

IGI061	VB.. 22.	VC.. 22.
IGI062	VB.. 33.	VC.. 33.

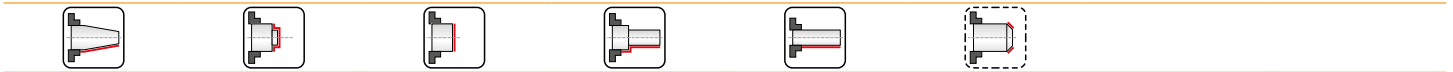
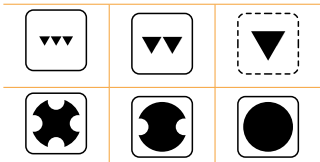
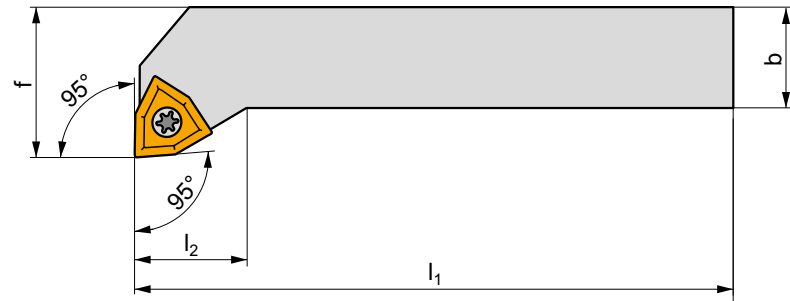
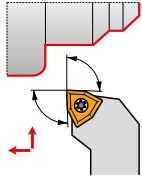
ISV11	US 2003-T07P	.8	M2.5	.26	-	-	FLAG T07P	-
ISV16S	US 2001-T15P	3.0	M3.5	.48	SVS 270-01	MS 9001	FLAG T15P/3.5	-

# SWLC(RL) EXT

P M K N S H

S

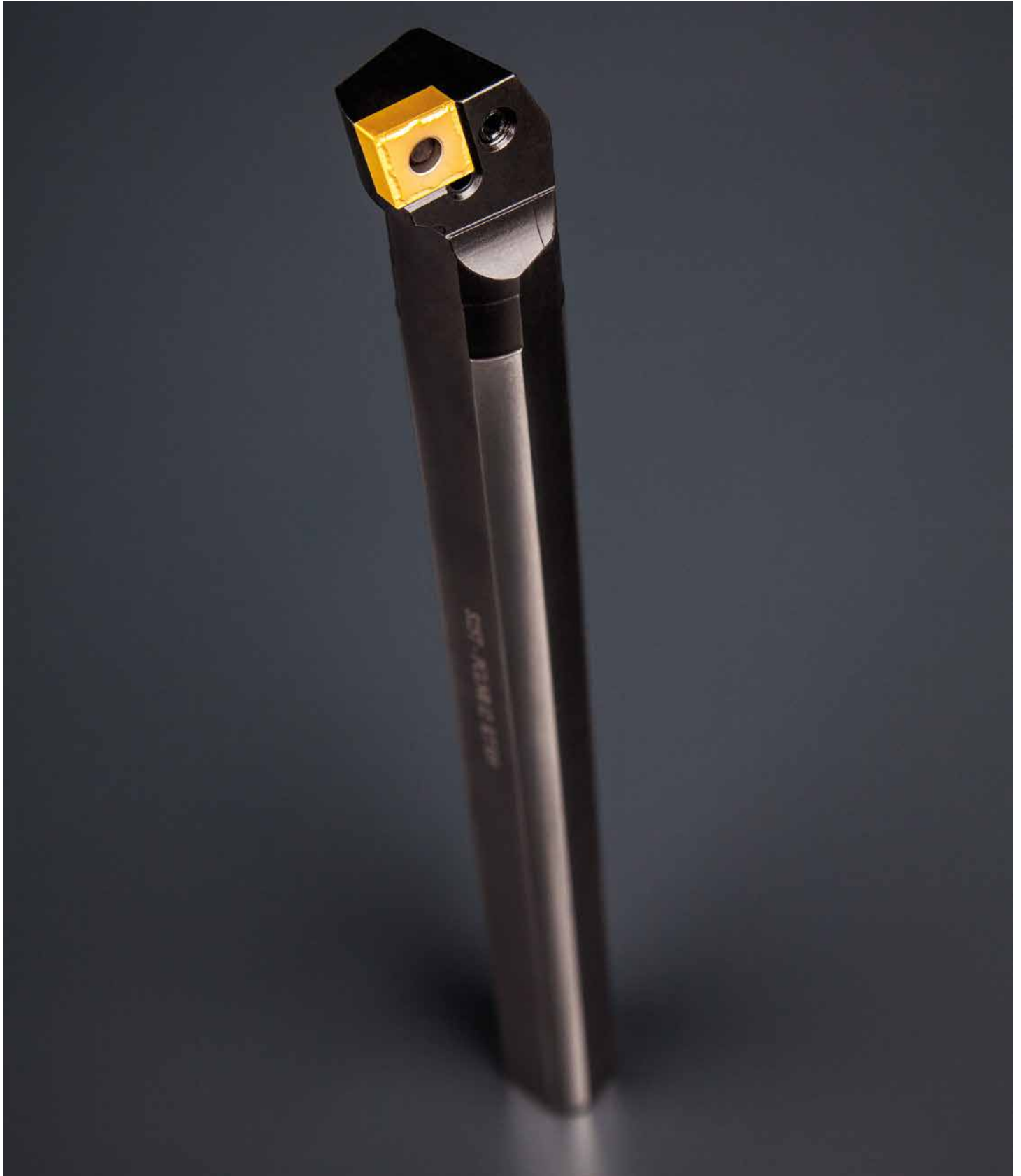
T119-T120



ANSI	$h=h_1$	b	f	$l_1$	$l_2$	$\lambda_s^\circ$	$\gamma^\circ$	lbs		
SWLCR/L 12 3B	.750	.750	1.000	4.500	.630	0	0	.88	IGI064	ISO8
SWLCR/L 16 4D	1.000	1.000	1.250	6.000	.830	0	0	1.54	IGI065	ISO9

IGI064										WC.. 32.5.
IGI065										WC.. 43.

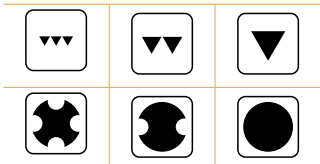
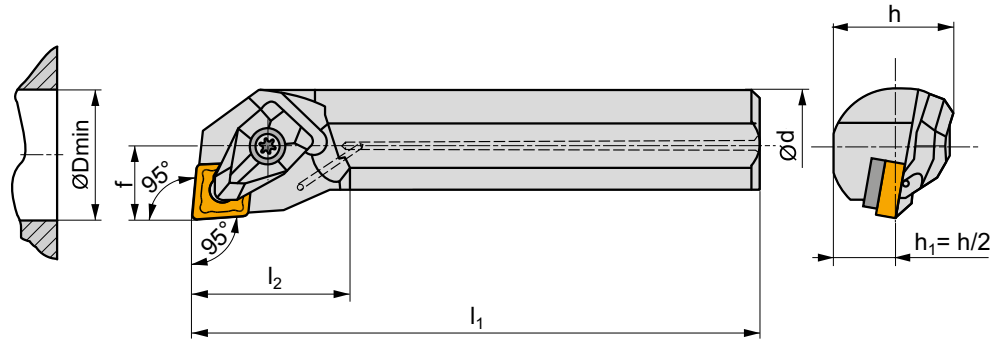
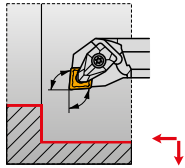
ISO8	US 3510-T15P		3.0	M3.5	.42	FLAG T15P				
ISO9	US 4512-T15P		5.0	M4.5	.48	FLAG T15P				



# DCLN(RL) INT

P M K N S H

D  
T44-T56



ANSI	d	D <sub>min</sub>	f	h	l <sub>1</sub>	l <sub>2</sub>	λ <sub>s</sub> °	γ°				
A12S-DCLNR/L 3	.750	1.000	.500	.709	10.000	1.024	-14	-6	✓	1.21	IGI004	DC09
A16T-DCLNR/L 4	1.000	1.280	.640	.906	12.000	1.339	-12	-6	✓	1.54	IGI005	DCI12
A20T-DCLNR/L 4	1.250	1.468	.765	1.181	12.000	1.299	-11	-6	✓	3.09	IGI005	DCI12
A24T-DCLNR/L 4	1.500	1.760	.890	1.374	12.000	1.575	-16	-6	✓	8.25	IGI005	DCI12
A24T-DCLNR/L 5	1.500	1.760	.890	1.374	12.000	1.575	-18	-6	✓	8.25	IGI006	DC16

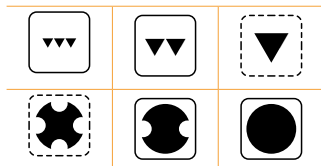
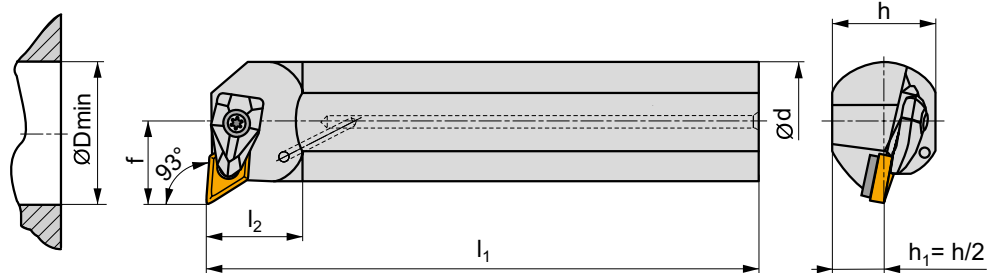
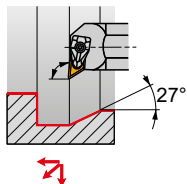
IGI004	CN.. 32.
IGI005	CN.. 43.
IGI006	CN.. 54.

DC09	DCS 09	1.7	DCS 236-04	US 2004-T09P	FLAG T09P	-
DC16	DCS 16	6.4	DCS 234-03	US 2007-T20P	-	LK T20P
DCI12	DCS 12	3.9	DCS 236-03	US 2002-T15P	FLAG T15P/3.5	-

**DDUN(RL) INT**

**P M K N S H**

**D**  
T62-T70



ANSI	d	D <sub>min</sub>	f	h	l <sub>1</sub>	l <sub>2</sub>	λ <sub>c</sub> °	γ°					
A16T-DDUNR/L 3	1.000	1.299	.750	.906	12.000	1.142	-12	-6	✓	1.54	IGI011	DD11	-
A20T-DDUNR/L 3	1.250	1.705	1.000	1.181	12.000	1.181	-9	-6	✓	3.09	IGI011	DD11	-
A20T-DDUNR/L 4	1.250	1.705	1.000	1.181	12.000	1.181	-13	-6	✓	3.09	IGI013	DD154	IAT007
A24T-DDUNR/L 4	1.500	2.000	1.125	1.374	12.000	1.299	-11	-6	✓	8.25	IGI013	DD154	IAT007

IGI011													
IGI013													

DD11	DCS 09	1.7		DDS 267-01	US 2004-T09P	FLAG T09P
DD154	DCS 12	3.9		DDS 266-02	US 2002-T15P	FLAG T15P/3.5

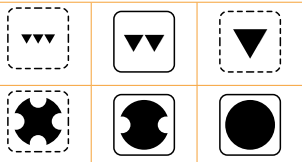
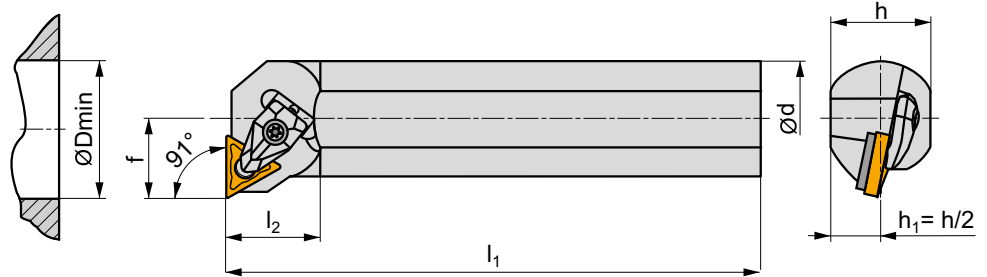
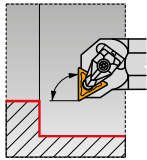
IAT007	DN.. 43.		-	DDS 266-01
IAT007	CER DN.N 44.		DCS 12C4	DDS 266-02
IAT007	CER DN.A 44.		DCS 12C2	DDS 266-02

# DTFN(RL) INT

P M K N S H

D

T100-T107



ANSI	d	D <sub>min</sub>	f	h	l <sub>1</sub>	l <sub>2</sub>	λ <sub>s</sub> °	γ°				
A16T-DTFNR/L 3	1.000	1.201	.640	.906	12.000	1.339	-12	-6	✓	1.54	IGI058	DTI16
A20T-DTFNR/L 3	1.250	1.468	.765	1.181	12.000	1.417	-11	-6	✓	3.09	IGI058	DTI16
A24T-DTFNR/L 4	1.500	1.760	.890	1.374	12.000	1.417	-15	-6	✓	8.25	IGI059	DT22

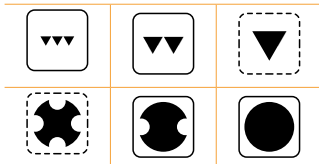
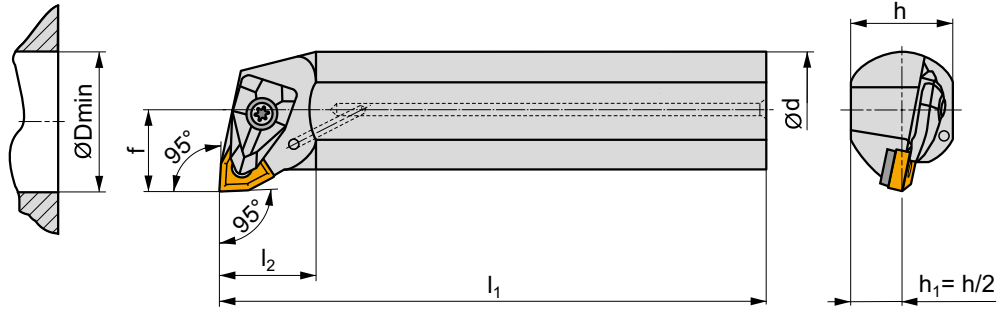
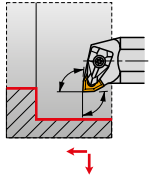
IGI058											TN.. 33.	
IGI059											TN.. 43.	

DTI16	DCS 09	1.7	DTS 316-01	US 2004-T09P	FLAG T09P
DT22	DCS 12	3.9	DTS 315-04	US 2002-T15P	FLAG T15P/3.5

**DWLN(RL) INT**

**P M K N S H**

**D**  
T121-T128



ANSI	d	D <sub>min</sub>	f	h	l <sub>1</sub>	l <sub>2</sub>	λ°	γ°				
A16T-DWLN(RL) 4	1.000	1.299	.750	.906	12.000	1.339	-12	-6	✓	1.54	IGI067	DWI08
A20T-DWLN(RL) 4	1.250	1.705	1.000	1.181	12.000	1.339	-15	-6	✓	3.09	IGI067	DWI08
A24T-DWLN(RL) 4	1.500	2.000	1.000	1.374	12.000	1.339	-13	-6	✓	8.25	IGI067	DW08

IGI067	WN.. 43.

DW08	DCS 12	3.9	DWS 331-12	US 2002-T15P	FLAG T15P/3.5
DWI08	DCS 12	3.9	DWS 328-02	US 2002-T15P	FLAG T15P/3.5

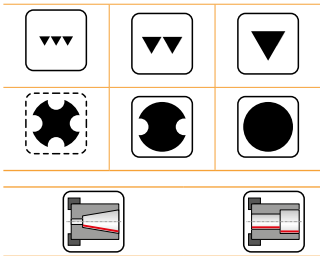
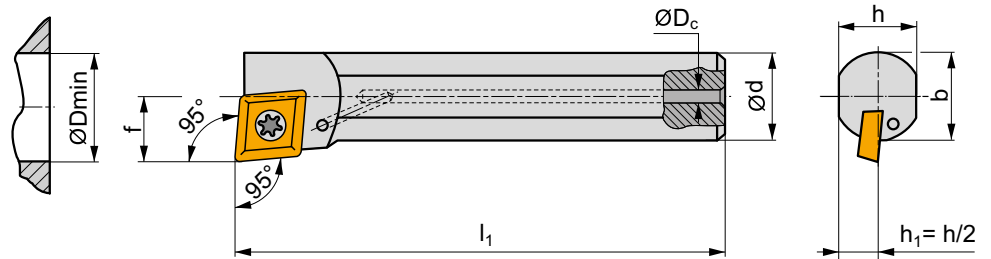
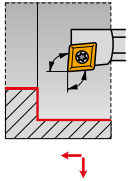


# SCLC(RL) INT

P M K N S H

S

T36-T43



ANSI	d	D <sub>min</sub>	f	h	b	l <sub>1</sub>	D <sub>c</sub>	λ°	γ°				
A06M-SCLCR/L 2	.375	.480	.250	.336	-	6.000	-	-11	0	✓	.13	IGI001	ISC06M
A08M-SCLCR/L 2	.500	.598	.312	.460	-	6.000	-	-8	0	✓	.33	IGI001	ISC06
A10R-SCLCR/L 3	.625	.772	.406	.562	-	8.000	-	-9	0	✓	.66	IGI002	ISC09M
A12S-SCLCR/L 3	.750	.929	.500	.709	-	10.000	-	-6	0	✓	1.21	IGI002	ISC09M
A16T-SCLCR/L 3	1.000	1.201	.640	.906	-	12.000	-	-4	0	✓	1.54	IGI002	ISC09
A20T-SCLCR/L 4	1.250	1.468	.765	1.181	-	12.000	-	-11	0	✓	3.09	IGI003	ISC12

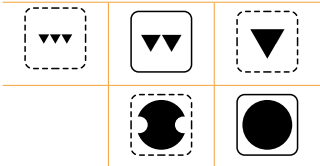
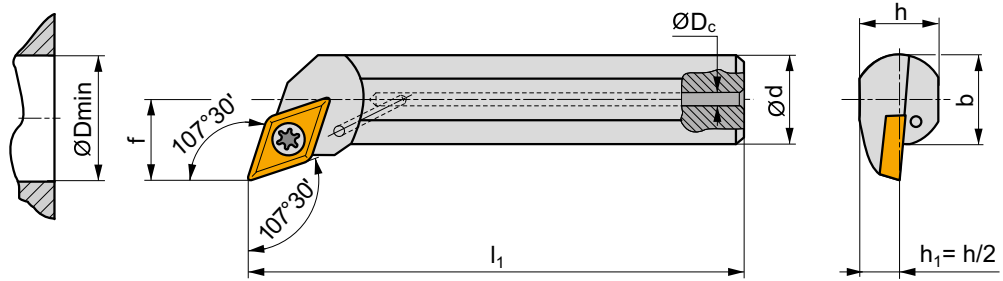
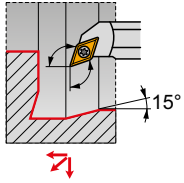
IGI001	CC.. 21.5.
IGI002	CC.. 32.5.
IGI003	CC.. 43.

ISC06M	US 2046-T07P	.9	M2.5	.20	-	-	FLAG T07P	-
ISC06	US 2003-T07P	.8	M2.5	.26	-	-	FLAG T07P	-
ISC09M	US 2009-T15P	3.0	M3.5	.32	-	-	FLAG T15P/3.5	-
ISC09	US 2010-T15P	3.0	M3.5	.40	-	-	FLAG T15P/3.5	-
ISC12	US 2018-T15P	3.0	M4	.55	SCS 232-02	MS 9003	FLAG T15P/4	-

**SDQC(RL) INT**

**P M K N S H**

**S**  
T57-T61



ANSI	d	D <sub>min</sub>	f	h	b	l <sub>1</sub>	D <sub>c</sub>	λ°	γ°				
A06M-SDQCR/L 2	.375	.598	.375	.336	-	6.000	-	-8	0	✓	.13	IGI009	ISD07
A08M-SDQCR/L 2	.500	.728	.437	.460	-	6.000	-	-6	0	✓	.33	IGI009	ISD07
A10R-SDQCR/L 2	.625	.850	.500	.562	-	8.000	-	-4	0	✓	.66	IGI009	ISD07
A12S-SDQCR/L 3	.750	.980	.562	.709	-	10.000	-	-6	0	✓	1.21	IGI010	ISD11M
A16T-SDQCR/L 3	1.000	1.299	.750	.906	-	12.000	-	-3	0	✓	1.54	IGI010	ISD11I

IGI009	DC.. 21.5.
IGI010	DC.. 32.5.

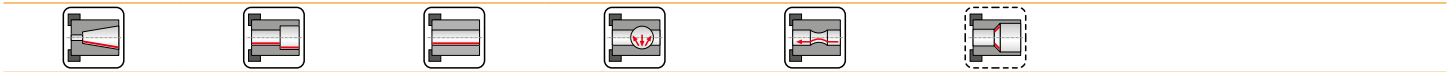
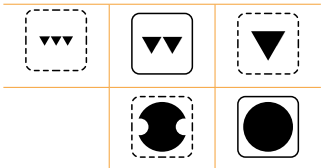
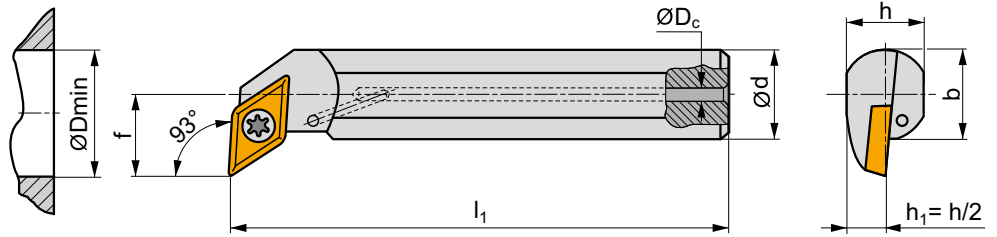
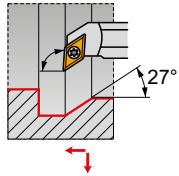
ISD07	US 2003-T07P	.8	M2.5	.26	-	-	FLAG T07P	-
ISD11M	US 2009-T15P	3.0	M3.5	.32	-	-	FLAG T15P/3.5	-
ISD11I	US 2010-T15P	3.0	M3.5	.40	-	-	FLAG T15P/3.5	-

# SDUC(RL) INT

P M K N S H

S

T57-T61



ANSI	d	D <sub>min</sub>	f	h	b	l <sub>1</sub>	D <sub>c</sub>	λ <sub>s</sub> °	γ <sub>o</sub> °		lbs		
A06M-SDUCR/L 2	.375	.598	.375	.336	-	6.000	-	-7	0	✓	.13	IGI009	ISD07
A08M-SDUCR/L 2	.500	.728	.438	.460	-	6.000	-	-5	0	✓	.33	IGI009	ISD07
A10R-SDUCR/L 2	.625	.850	.500	.562	-	8.000	-	-4	0	✓	.66	IGI009	ISD07
A12S-SDUCR/L 3	.750	1.051	.625	.709	-	10.000	-	-5	0	✓	1.21	IGI010	ISD11M
A16T-SDUCR/L 3	1.000	1.299	.750	.906	-	12.000	-	-3	0	✓	1.54	IGI010	ISD11I
A20T-SDUCR/L 3	1.250	1.579	.875	1.181	-	12.000	-	-8	0	✓	3.09	IGI010	ISD11V

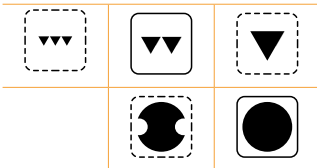
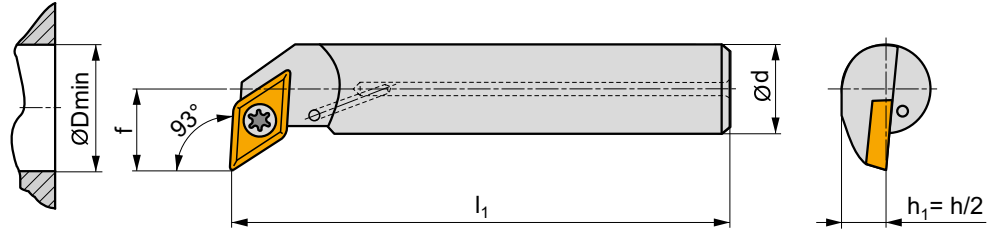
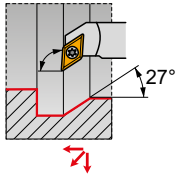
IGI009		DC.. 21.5.
IGI010		DC.. 32.5.

ISD07	US 2003-T07P	.8	M2.5	.26	-	-	FLAG T07P	-
ISD11M	US 2009-T15P	3.0	M3.5	.32	-	-	FLAG T15P/3.5	-
ISD11I	US 2010-T15P	3.0	M3.5	.40	-	-	FLAG T15P/3.5	-
ISD11V	US 2001-T15P	3.0	M3.5	.48	SDS 263-01	MS 9001	FLAG T15P/3.5	-

**SDUC(RL)-E INT**

**P M K N S H**

**S**  
T57-T61



ANSI	d	D <sub>min</sub>	f	h	l <sub>1</sub>	λ <sub>s</sub> °	γ°				
<b>E06M-SDUCR/L 2</b>	.375	.598	.375	.336	6.000	-7	0	✓	1.19	IGI009	ISD07
<b>E08R-SDUCR/L 2</b>	.500	.716	.438	.460	8.000	-5	0	✓	1.65	IGI009	ISD07
<b>E10R-SDUCR/L 2</b>	.625	.850	.500	.562	8.000	-4	0	✓	2.36	IGI009	ISD07

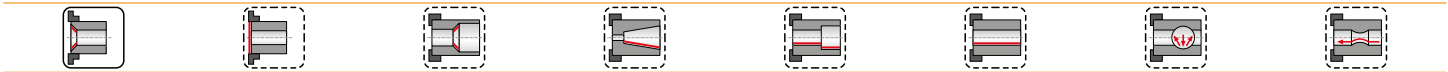
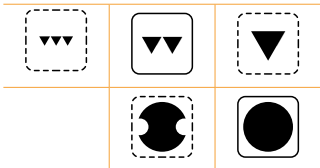
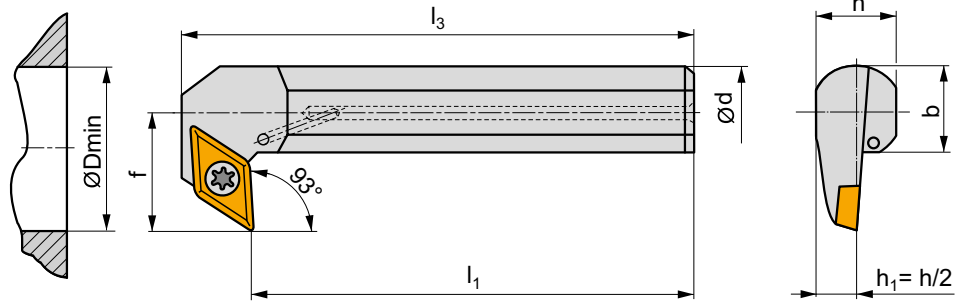
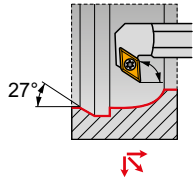
IGI009	DC.. 21.5.

ISD07	US 2003-T07P	.8	M2.5	.26	-

**SDZC(RL) INT**

**P M K N S H**

**S**  
T57-T61



ANSI	d	D <sub>min</sub>	f	h	b	l <sub>1</sub>	l <sub>3</sub>	λ°	γ°	lbs	IGI010	ISD11V
A20T-SDZCR/L 3-93	1.250	1.579	.875	1.181	-	12.000	12.658	-7	0	3.09	IGI010	ISD11V

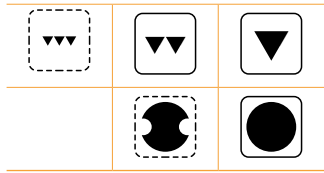
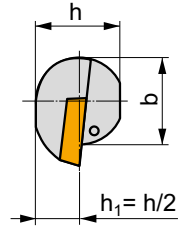
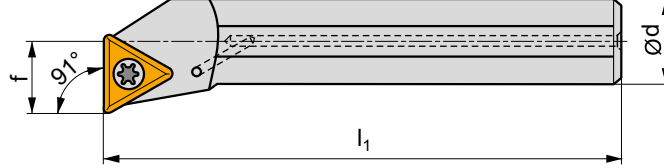
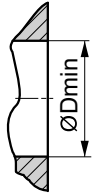
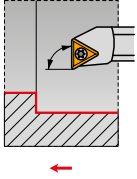
IGI010	DC.. 32.5.
--------	------------

ISD11V	US 2001-T15P	3.0	M3.5	.48	SDS 263-01	MS 9001	FLAG T15P/3.5	-
--------	--------------	-----	------	-----	------------	---------	---------------	---

# STFC(RL) INT

P M K N S H

**S**  
T96-T99



ANSI	d	D <sub>min</sub>	f	h	b	l <sub>1</sub>	λ°	γ°				
A08M-STFCR/L 2	.500	.598	.312	.460	-	6.000	-7	0	✓	.33	IGI044	IST11
A10R-STFCR/L 2	.625	.772	.406	.562	-	8.000	-5	0	✓	.66	IGI044	IST11
A12S-STFCR/L 2	.750	.929	.500	.709	-	10.000	-3	0	✓	1.21	IGI044	IST11
A16T-STFCR/L 3	1.000	1.201	.640	.906	-	12.000	-4	0	✓	1.54	IGI045	IST16I

IGI044	TC.. 21.5.
IGI045	TC.. 32.5.

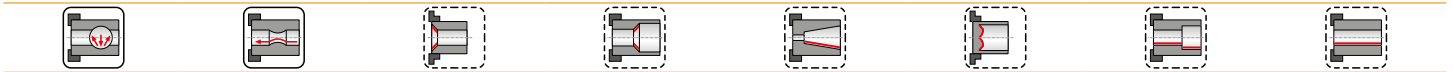
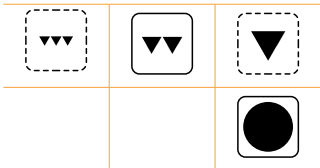
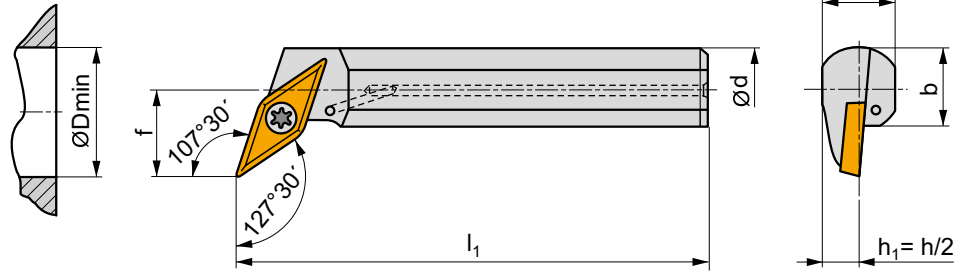
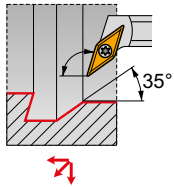
IST11	US 2003-T07P	.8	M2.5	.26	-	-	FLAG T07P	-	-
IST16I	US 2010-T15P	3.0	M3.5	.40	-	-	FLAG T15P/3.5	-	-

# SVQB(C)(RL) INT

P M K N S H

S

T108-T116



ANSI	d	D <sub>min</sub>	f	h	b	l <sub>1</sub>	λ°	γ°				
A16T-SVQBR/L 3	1.000	1.299	.750	.906	-	12.000	-7	0	✓	1.54	IGI062	ISV16
A20T-SVQBR/L 3	1.250	1.579	.875	1.181	-	12.000	-7	0	✓	4.52	IGI062	ISV16S
A24T-SVQBR/L 3	1.500	1.841	1.063	1.374	-	12.000	-5	0	✓	8.25	IGI062	ISV16S

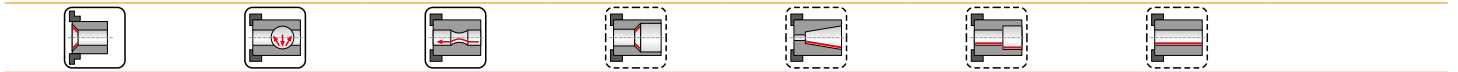
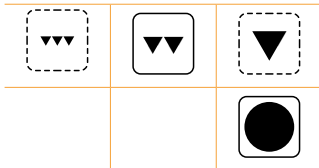
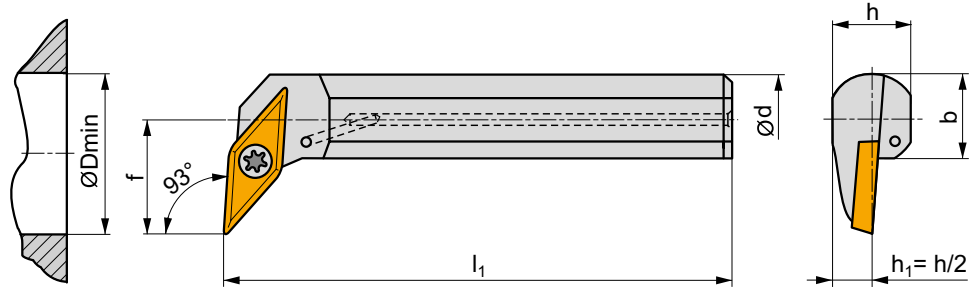
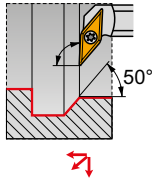
IGI062		VB.. 33.		VC.. 33.

ISV16	US 2010-T15P	3.0	M3.5	.40	-	-	FLAG T15P/3.5	-
ISV16S	US 2001-T15P	3.0	M3.5	.48	SVS 270-01	MS 9001	FLAG T15P/3.5	-

# SVUB(C)(RL) INT

P M K N S H

**S**  
T108-T116



ANSI	d	D <sub>min</sub>	f	h	b	l <sub>1</sub>	λ <sub>s</sub> °	γ°				
A10R-SVUBR/L 2	.625	.850	.486	.560	-	8.000	-7	0	✓	.66	IGI061	ISV11I
A12S-SVUBR/L 2	.750	1.012	.580	.710	-	10.000	-5	0	✓	1.21	IGI061	ISV11I
A20T-SVUBR/L 3	1.250	1.705	1.000	1.181	-	12.000	-5	0	✓	4.52	IGI062	ISV16S
A24T-SVUBR/L 3	1.500	2.126	1.125	1.374	-	12.000	-3	0	✓	8.25	IGI062	ISV16S

IGI061	VB.. 22.	VC.. 22.
IGI062	VB.. 33.	VC.. 33.

ISV16S	US 2001-T15P	3.0	M3.5	.48	SVS 270-01	MS 9001	FLAG T15P/3.5	-
ISV11I	US 2020-T07P	.8	M2.5	.28	-	-	FLAG T07P	-

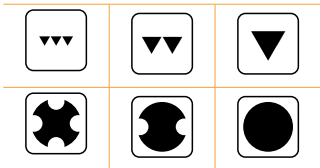
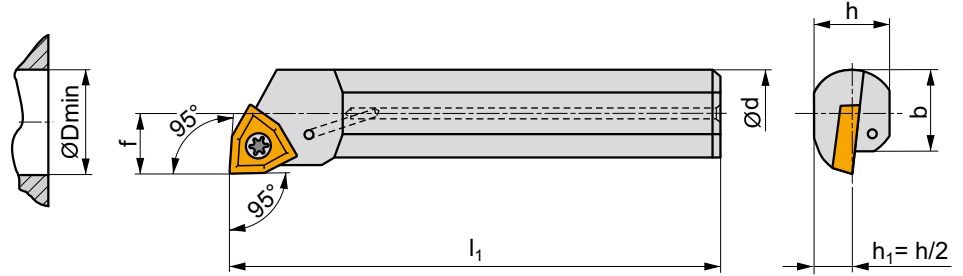
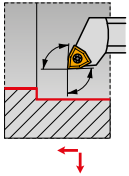


**SWLC(RL) INT**

**P M K N S H**

**S**

T119-T120



ANSI	d	D <sub>min</sub>	f	h	b	l <sub>1</sub>	λ°	γ°				
A12S-SWLCR/L 3	.750	.929	.500	.709	-	10.000	-6	0	✓	1.32	IGI064	ISO8

IGI064						WC.. 32.5.						

ISO8	US 3510-T15P	3.0	M3.5	.42	FLAG T15P							

ISO/ANSI CODE DESIGNATION – PARTING AND GROOVING TOOLS – EXTERNAL TURNING  
 DESIGNACIÓN CÓDIGO ISO/ANSI - HERRAMIENTAS DE TRONZADO Y RANURADO - EXTERIOR  
 CODIFICATION ISO/ANSI - OUTILS DE TRONÇONNAGE ET GORGES - TOURNAGE EXTÉRIEUR

ISO	1	2	3	4	5	6	7	8	9	10	11
	G	F	I	L	25	25	M	0316	R	030	017
ANSI	1	2	3	4	5 & 6	7	8	9	10	11	
	G	F	I	L	16	D	0316	R	1.18	.670	



<b>1</b>	<b>1</b>	<b>2</b>	<b>2</b>	<b>3</b>	<b>3</b>	<b>4</b>	<b>4</b>																										
Clamping designation Tipo de fijación Désignation de la fixation		Holder style – cutting edge angle Tipo de herramienta - ángulo de posición Type d'outil - angle d'attaque		Maximum grooving/turning depth Máxima profundidad de ranurado/torneado Profondeur maximum de gorge/tournage		Version (right/left) R/L Versión (derecha/izquierda) R/L Version (droite/gauche) R/L																											
<p style="text-align: center;"><b>G</b></p>		<table border="1" style="margin-left: auto; margin-right: auto;"> <thead> <tr> <th colspan="2"><math>\alpha^\circ</math></th> </tr> </thead> <tbody> <tr><td>G = 0°</td><td>K = 75°</td></tr> <tr><td>R = 15°</td><td>F = 90°</td></tr> <tr><td>T = 30°</td><td>B = 105°</td></tr> <tr><td>S = 45°</td><td>E = 120°</td></tr> <tr><td>W = 60°</td><td>D = 135°</td></tr> </tbody> </table>		$\alpha^\circ$		G = 0°	K = 75°	R = 15°	F = 90°	T = 30°	B = 105°	S = 45°	E = 120°	W = 60°	D = 135°	<table border="1" style="margin-left: auto; margin-right: auto;"> <tbody> <tr><td>G = 2,0 × a</td><td>N = 5,5 × a</td></tr> <tr><td>H = 2,5 × a</td><td>O = 6,0 × a</td></tr> <tr><td>I = 3,0 × a</td><td>P = 6,5 × a</td></tr> <tr><td>J = 3,5 × a</td><td>Q = 7,0 × a</td></tr> <tr><td>K = 4,0 × a</td><td>R = 7,5 × a</td></tr> <tr><td>L = 4,5 × a</td><td>S = 8,0 × a</td></tr> <tr><td>M = 5,0 × a</td><td>T = 8,5 × a</td></tr> </tbody> </table>		G = 2,0 × a	N = 5,5 × a	H = 2,5 × a	O = 6,0 × a	I = 3,0 × a	P = 6,5 × a	J = 3,5 × a	Q = 7,0 × a	K = 4,0 × a	R = 7,5 × a	L = 4,5 × a	S = 8,0 × a	M = 5,0 × a	T = 8,5 × a	<p style="text-align: center;"><b>R</b>      <b>L</b></p>	
$\alpha^\circ$																																	
G = 0°	K = 75°																																
R = 15°	F = 90°																																
T = 30°	B = 105°																																
S = 45°	E = 120°																																
W = 60°	D = 135°																																
G = 2,0 × a	N = 5,5 × a																																
H = 2,5 × a	O = 6,0 × a																																
I = 3,0 × a	P = 6,5 × a																																
J = 3,5 × a	Q = 7,0 × a																																
K = 4,0 × a	R = 7,5 × a																																
L = 4,5 × a	S = 8,0 × a																																
M = 5,0 × a	T = 8,5 × a																																

<b>5</b>	<b>6</b>	<b>7</b>	<b>7</b>	<b>8</b>	<b>8</b>																																									
Shank height [mm] Altura del mango [mm] Hauteur de manche [mm]	Shank width [mm] Anchura del mango [mm] Largeur de manche [mm]	Holder total length Longitud total Longueur totale de l'outil	Insert width Ancho de plaquita Largeur de plaquette																																											
<p style="text-align: center;">12 = 12 mm 16 = 16 mm 20 = 20 mm atd./etc.</p>	<p style="text-align: center;">12 = 12 mm 16 = 16 mm 20 = 20 mm atd./etc.</p>	<table border="1" style="margin-left: auto; margin-right: auto;"> <thead> <tr> <th><math>l_1</math> [mm]</th> <th><math>l_1</math> [in]</th> </tr> </thead> <tbody> <tr><td>H</td><td>100</td></tr> <tr><td>J</td><td>110</td></tr> <tr><td>K</td><td>125</td></tr> <tr><td>L</td><td>140</td></tr> <tr><td>E</td><td>150</td></tr> <tr><td>N</td><td>160</td></tr> <tr><td>P</td><td>170</td></tr> <tr><td>Q</td><td>180</td></tr> <tr><td>R</td><td>200</td></tr> </tbody> </table>	$l_1$ [mm]	$l_1$ [in]	H	100	J	110	K	125	L	140	E	150	N	160	P	170	Q	180	R	200	<table border="1" style="margin-left: auto; margin-right: auto;"> <thead> <tr> <th></th> <th>a [mm]</th> <th>a [in]</th> </tr> </thead> <tbody> <tr><td>02</td><td>2,0</td><td>.079</td></tr> <tr><td>03, 0313, 0316</td><td>3,0</td><td>.118</td></tr> <tr><td>04, 0413, 0416</td><td>4,0</td><td>.157</td></tr> <tr><td>05, 0516</td><td>5,0</td><td>.197</td></tr> <tr><td>06, 0616</td><td>6,0</td><td>.236</td></tr> <tr><td>08, 0830</td><td>8,0</td><td>.315</td></tr> </tbody> </table>		a [mm]	a [in]	02	2,0	.079	03, 0313, 0316	3,0	.118	04, 0413, 0416	4,0	.157	05, 0516	5,0	.197	06, 0616	6,0	.236	08, 0830	8,0	.315		
$l_1$ [mm]	$l_1$ [in]																																													
H	100																																													
J	110																																													
K	125																																													
L	140																																													
E	150																																													
N	160																																													
P	170																																													
Q	180																																													
R	200																																													
	a [mm]	a [in]																																												
02	2,0	.079																																												
03, 0313, 0316	3,0	.118																																												
04, 0413, 0416	4,0	.157																																												
05, 0516	5,0	.197																																												
06, 0616	6,0	.236																																												
08, 0830	8,0	.315																																												

6 & 7							
	b [in]	h [in]	b [in]	h [in]	b [in]	h [in]	
05	5/16	5/16	12	3/4	3/4	20	1 1/4
06	3/8	3/8	16	1	1	24	1 1/2
08	1/2	1/2	85	1	1 1/4	32	2
10	5/8	5/8	86	1	1 1/2		

For square shanks, the number is the width or height in terms of 16ths. For rectangular shanks the first digit is the width in terms of 8ths and the second digit is the height in terms of 4ths.

Para mangos cuadrados, el dígito indica el ancho o la altura en número de dieciseisavos de pulgada. Para mangos rectangulares, el primer dígito indica el ancho en número de octavos de pulgada y el segundo dígito indica la altura en número de cuartos de pulgada.

Pour les manches carrés, c'est le nombre 16 de la largeur et de la hauteur en pouce. Pour les manches rectangulaires le premier dígito est le nombre 8 de la largeur en pouce et le second dígito le nombre 4 de la hauteur en pouce.

<b>9</b>	<b>9</b>	<b>10</b>	<b>10</b>
<p style="text-align: center;"><b>L</b>      <b>R</b></p>		<p style="text-align: center;"><b>10</b></p>	
<p style="text-align: center;"><b>Blade curvature direction</b> Dirección de la curvatura de la lama Direction de la lame incurvée</p>		<p style="text-align: center;"><b>Maximum diameter - face grooving</b> Diámetro máximo - ranurado frontal Diámetro maximum - gorge frontale</p>	
<p style="text-align: center;">Additional information for axial turning. Información adicional para ranurado axial o frontal. Information complémentaire pour tournage axial</p>		<p style="text-align: center;">Additional information for axial turning. Información adicional para ranurado axial o frontal. Information complémentaire pour tournage axial</p>	
		<b>11</b>	<b>11</b>
		<p style="text-align: center;"><b>11</b></p>	
		<p style="text-align: center;"><b>Minimum diameter - face grooving</b> Diámetro mínimo - ranurado frontal Diámetro minimum - gorge frontale</p>	
		<p style="text-align: center;">Additional information for axial turning. Información adicional para ranurado axial o frontal. Information complémentaire pour tournage axial</p>	

ISO/ANSI CODE DESIGNATION – PARTING AND GROOVING TOOLS – INTERNAL TURNING  
 DESIGNACIÓN CÓDIGO ISO/ANSI - HERRAMIENTAS DE TRONZADO Y RANURADO - INTERIOR  
 CODIFICATION ISO/ANSI - OUTILS DE TRONÇONNAGE ET GORGES - TOURNAGE INTÉRIEUR

<b>ISO</b>	<b>1</b>	<b>2</b>	<b>3</b>	-	<b>4</b>	<b>5</b>	<b>6</b>	<b>7</b>	<b>8</b>
	<b>A</b>	<b>25</b>	<b>S</b>	-	<b>G</b>	<b>G</b>	<b>H</b>	<b>L</b>	<b>0313</b>
<b>ANSI</b>	<b>1</b>	<b>2</b>	<b>3</b>	-	<b>4</b>	<b>5</b>	<b>6</b>	<b>7</b>	<b>8</b>
	<b>A</b>	<b>16</b>	<b>S</b>	-	<b>G</b>	<b>G</b>	<b>H</b>	<b>L</b>	<b>0313</b>



<b>1</b>		<b>1</b>		<b>2</b>		<b>2</b>		<b>3</b>		<b>3</b>																																																																																			
Shank Mango Queue		Diameter of shank Diámetro del mango Diamètre de queue		Diameter of shank Diámetro del mango Diamètre de queue		Diameter of shank Diámetro del mango Diamètre de queue		Holder total length Longitud total Longueur totale de l'outil		Holder total length Longitud total Longueur totale de l'outil																																																																																			
<b>S</b>	Steel shank Mango de acero Queue en acier																																																																																												
	Steel shank with coolant hole Mango de acero con refrigeración interna Queue en acier avec trou d'arrosage		<table border="1"> <thead> <tr> <th>d [mm]</th> <th>d [mm]</th> </tr> </thead> <tbody> <tr><td>12</td><td>12</td></tr> <tr><td>16</td><td>16</td></tr> <tr><td>20</td><td>20</td></tr> <tr><td>25</td><td>25</td></tr> <tr><td>32</td><td>32</td></tr> <tr><td>40</td><td>40</td></tr> </tbody> </table>		d [mm]	d [mm]	12	12	16	16	20	20	25	25	32	32	40	40	<table border="1"> <thead> <tr> <th>d [in]</th> <th>d [in]</th> </tr> </thead> <tbody> <tr><td>.08</td><td>.500</td></tr> <tr><td>.10</td><td>.625</td></tr> <tr><td>.12</td><td>.750</td></tr> <tr><td>.16</td><td>1.000</td></tr> <tr><td>.20</td><td>1.250</td></tr> <tr><td>.24</td><td>1.500</td></tr> </tbody> </table>		d [in]	d [in]	.08	.500	.10	.625	.12	.750	.16	1.000	.20	1.250	.24	1.500	<table border="1"> <thead> <tr> <th>l<sub>1</sub> [mm]</th> <th>l<sub>1</sub> [in]</th> <th>l<sub>1</sub> [mm]</th> <th>l<sub>1</sub> [in]</th> </tr> </thead> <tbody> <tr><td>M</td><td>150</td><td>6.000</td><td>S</td><td>250</td><td>10.000</td></tr> <tr><td>P</td><td>170</td><td>6.250</td><td>T</td><td>300</td><td>12.000</td></tr> <tr><td>Q</td><td>180</td><td>7.250</td><td>U</td><td>350</td><td>14.000</td></tr> <tr><td>R</td><td>200</td><td>8.000</td><td>V</td><td>400</td><td>15.750</td></tr> </tbody> </table>		l <sub>1</sub> [mm]	l <sub>1</sub> [in]	l <sub>1</sub> [mm]	l <sub>1</sub> [in]	M	150	6.000	S	250	10.000	P	170	6.250	T	300	12.000	Q	180	7.250	U	350	14.000	R	200	8.000	V	400	15.750	<table border="1"> <thead> <tr> <th>l<sub>1</sub> [mm]</th> <th>l<sub>1</sub> [in]</th> <th>l<sub>1</sub> [mm]</th> <th>l<sub>1</sub> [in]</th> </tr> </thead> <tbody> <tr><td>M</td><td>150</td><td>6.000</td><td>S</td><td>250</td><td>10.000</td></tr> <tr><td>P</td><td>170</td><td>6.250</td><td>T</td><td>300</td><td>12.000</td></tr> <tr><td>Q</td><td>180</td><td>7.250</td><td>U</td><td>350</td><td>14.000</td></tr> <tr><td>R</td><td>200</td><td>8.000</td><td>V</td><td>400</td><td>15.750</td></tr> </tbody> </table>		l <sub>1</sub> [mm]	l <sub>1</sub> [in]	l <sub>1</sub> [mm]	l <sub>1</sub> [in]	M	150	6.000	S	250	10.000	P	170	6.250	T	300	12.000	Q	180	7.250	U	350	14.000	R	200	8.000	V	400
d [mm]	d [mm]																																																																																												
12	12																																																																																												
16	16																																																																																												
20	20																																																																																												
25	25																																																																																												
32	32																																																																																												
40	40																																																																																												
d [in]	d [in]																																																																																												
.08	.500																																																																																												
.10	.625																																																																																												
.12	.750																																																																																												
.16	1.000																																																																																												
.20	1.250																																																																																												
.24	1.500																																																																																												
l <sub>1</sub> [mm]	l <sub>1</sub> [in]	l <sub>1</sub> [mm]	l <sub>1</sub> [in]																																																																																										
M	150	6.000	S	250	10.000																																																																																								
P	170	6.250	T	300	12.000																																																																																								
Q	180	7.250	U	350	14.000																																																																																								
R	200	8.000	V	400	15.750																																																																																								
l <sub>1</sub> [mm]	l <sub>1</sub> [in]	l <sub>1</sub> [mm]	l <sub>1</sub> [in]																																																																																										
M	150	6.000	S	250	10.000																																																																																								
P	170	6.250	T	300	12.000																																																																																								
Q	180	7.250	U	350	14.000																																																																																								
R	200	8.000	V	400	15.750																																																																																								
<b>4</b>		<b>4</b>		<b>5</b>		<b>5</b>		<b>6</b>		<b>6</b>																																																																																			
Clamping designation Tipo de fijación Désignation de la fixation		Clamping designation Tipo de fijación Désignation de la fixation		Tool style – cutting edge angle Tipo de herramienta - ángulo de posición Type d'outil - angle d'attaque		Tool style – cutting edge angle Tipo de herramienta - ángulo de posición Type d'outil - angle d'attaque		Maximum grooving/turning depth Máxima profundidad de ranurado/torneado Profondeur maximum de gorge/tournage		Maximum grooving/turning depth Máxima profundidad de ranurado/torneado Profondeur maximum de gorge/tournage																																																																																			
<b>G</b>						<table border="1"> <thead> <tr> <th colspan="2">α°</th> </tr> </thead> <tbody> <tr><td>G = 0°</td><td>K = 75°</td></tr> <tr><td>R = 15°</td><td>F = 90°</td></tr> <tr><td>T = 30°</td><td>B = 105°</td></tr> <tr><td>S = 45°</td><td>E = 120°</td></tr> <tr><td>W = 60°</td><td>D = 135°</td></tr> </tbody> </table>		α°		G = 0°	K = 75°	R = 15°	F = 90°	T = 30°	B = 105°	S = 45°	E = 120°	W = 60°	D = 135°			<table border="1"> <tbody> <tr><td>E = 1,0 × a</td><td>J = 3,5 × a</td></tr> <tr><td>F = 1,5 × a</td><td>K = 4,0 × a</td></tr> <tr><td>G = 2,0 × a</td><td>L = 4,5 × a</td></tr> <tr><td>H = 2,5 × a</td><td>M = 5,0 × a</td></tr> <tr><td>I = 3,0 × a</td><td>N = 5,5 × a</td></tr> </tbody> </table>		E = 1,0 × a	J = 3,5 × a	F = 1,5 × a	K = 4,0 × a	G = 2,0 × a	L = 4,5 × a	H = 2,5 × a	M = 5,0 × a	I = 3,0 × a	N = 5,5 × a																																																												
α°																																																																																													
G = 0°	K = 75°																																																																																												
R = 15°	F = 90°																																																																																												
T = 30°	B = 105°																																																																																												
S = 45°	E = 120°																																																																																												
W = 60°	D = 135°																																																																																												
E = 1,0 × a	J = 3,5 × a																																																																																												
F = 1,5 × a	K = 4,0 × a																																																																																												
G = 2,0 × a	L = 4,5 × a																																																																																												
H = 2,5 × a	M = 5,0 × a																																																																																												
I = 3,0 × a	N = 5,5 × a																																																																																												
<b>7</b>		<b>7</b>		<b>8</b>		<b>8</b>		<b>8</b>		<b>8</b>																																																																																			
Version (right/left) R/L Versión (derecha/izquierda) R/L Version (droite/gauche) R/L		Version (right/left) R/L Versión (derecha/izquierda) R/L Version (droite/gauche) R/L		Insert width Ancho de plaquita Largeur de plaquette		Insert width Ancho de plaquita Largeur de plaquette		Insert width Ancho de plaquita Largeur de plaquette		Insert width Ancho de plaquita Largeur de plaquette																																																																																			
<b>R</b>										<table border="1"> <thead> <tr> <th>a [mm]</th> <th>a [mm]</th> </tr> </thead> <tbody> <tr><td>0313</td><td>3,0</td></tr> <tr><td>0413</td><td>4,0</td></tr> </tbody> </table>		a [mm]	a [mm]	0313	3,0	0413	4,0																																																																												
a [mm]	a [mm]																																																																																												
0313	3,0																																																																																												
0413	4,0																																																																																												

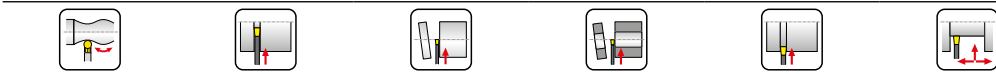
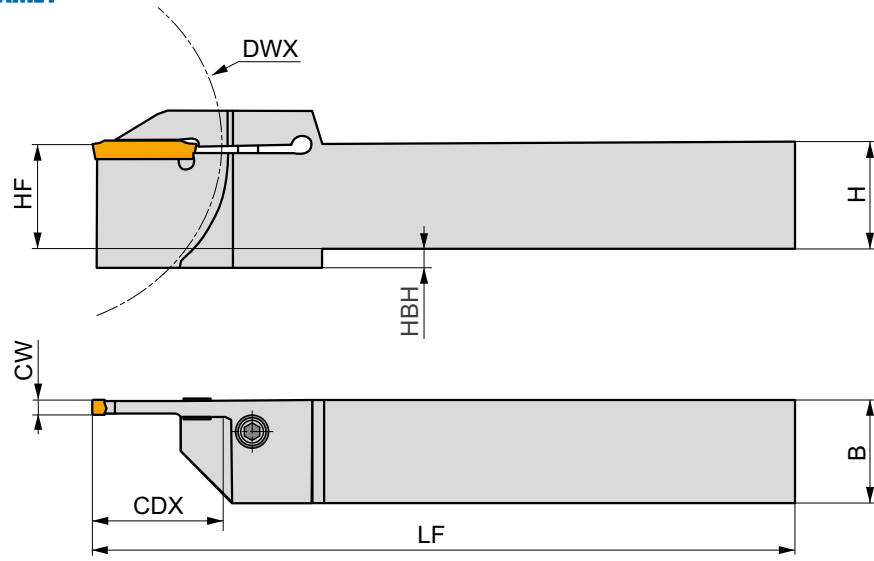
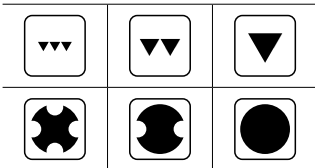
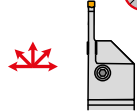
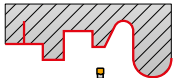
**GLSF(RL) EXT**

**P M K N S H**

**PRAMET**

**G**

T148



	HF	H	B	LF	CW	CDX	HBH	DWX	lbs		
	[in]	[in]	[in]	[in]	[in]	[in]	[in]	[in]			
<b>GL2-S10CFR/L-.63-1.78</b>	.625	.625	.625	5.000	.079	.630	.118	1.780	.510	GI334	GL12
<b>GL2-S12CFR/L-.79-3.15</b>	.750	.750	.750	5.000	.079	.790	.000	3.150	.860	GI334	GL11
<b>GL2-S16DFR/L-.79-3.15</b>	1.000	1.000	1.000	6.000	.079	.790	.000	3.150	1.500	GI334	GL11
<b>GL3-S10CFR/L-.63-1.78</b>	.625	.625	.625	5.000	.118	.630	.118	1.780	.510	GI335	GL12
<b>GL3-S12CFR/L-.79-3.15</b>	.750	.750	.750	5.000	.118	.790	.000	3.150	.860	GI335	GL11
<b>GL3-S16DFR/L-.79-3.15</b>	1.000	1.000	1.000	6.000	.118	.790	.000	3.150	1.500	GI335	GL11
<b>GL3-S16EFR/L-1.26-3.15</b>	1.000	1.000	1.000	7.000	.118	1.200	.197	3.150	1.590	GI335	GL11
<b>GL4-S12CFR/L-.79-3.15</b>	.750	.750	.750	5.000	.157	.790	.000	3.150	.860	GI336	GL11
<b>GL4-S16DFR/L-.79-3.15</b>	1.000	1.000	1.000	6.000	.157	.790	.000	3.150	1.500	GI336	GL11
<b>GL4-S16EFR/L-1.26-3.15</b>	1.000	1.000	1.000	7.000	.157	1.200	.197	3.150	1.590	GI336	GL11
<b>GL5-S12CFR/L-.79-3.15</b>	.750	.750	.750	5.000	.197	.790	.000	3.150	.860	GI337	GL11
<b>GL5-S16DFR/L-.79-3.15</b>	1.000	1.000	1.000	6.000	.197	.790	.000	3.150	1.500	GI337	GL11
<b>GL6-S12CFR/L-.79-3.15</b>	.750	.750	.750	5.000	.236	.790	.000	3.150	.860	GI338	GL11
<b>GL6-S16DFR/L-.79-3.15</b>	1.000	1.000	1.000	6.000	.236	.790	.000	3.150	1.500	GI338	GL11

GI334		GL2..
GI335		GL3..
GI336		GL4..
GI337		GL5..
GI338		GL6..

GL11	US 5018-T20P	5.0	M5	.717	-	LK T20P	-
GL12	HS 0516	5.0	M5	-	.63	-	HXX4

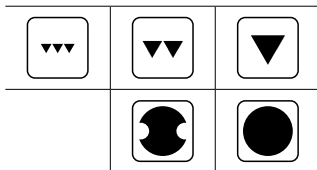
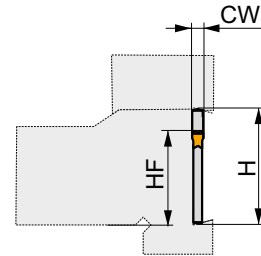
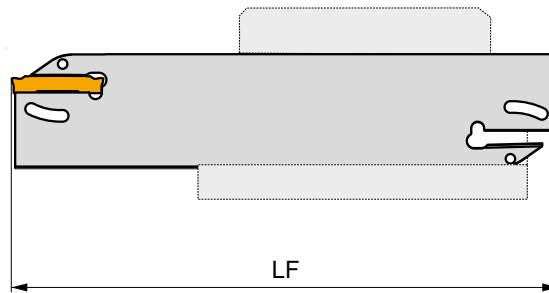
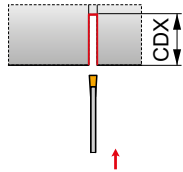
# GLS B

P M K N S H

PRAMET

X

T148



	HF	H	LF	CW	CDX	lbs		
	[in]	[in]	[in]	[in]	[in]			
<b>GL2-S26KB</b>	.787	1.024	4.921	.079	1.378	.310	G1334	KV2
<b>GL2-S32MB</b>	.984	1.260	5.906	.079	1.969	.350	G1334	KV2
<b>GL3-S26KB</b>	.787	1.024	4.921	.118	1.378	.310	G1335	KV2
<b>GL3-S32MB</b>	.984	1.260	5.906	.118	1.969	.350	G1335	KV2
<b>GL4-S32MB</b>	.984	1.260	5.906	.157	1.969	.350	G1336	KV2
<b>GL5-S32MB</b>	.984	1.260	5.906	.197	2.362	.350	G1337	KV2
<b>GL6-S32MB</b>	.984	1.260	5.906	.236	2.362	.350	G1338	KV2

G1334	GL2..	
G1335	GL3..	
G1336	GL4..	
G1337	GL5..	
G1338	GL6..	

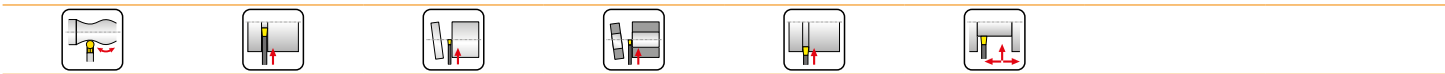
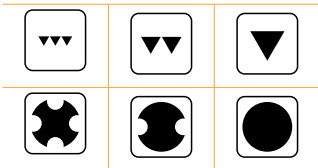
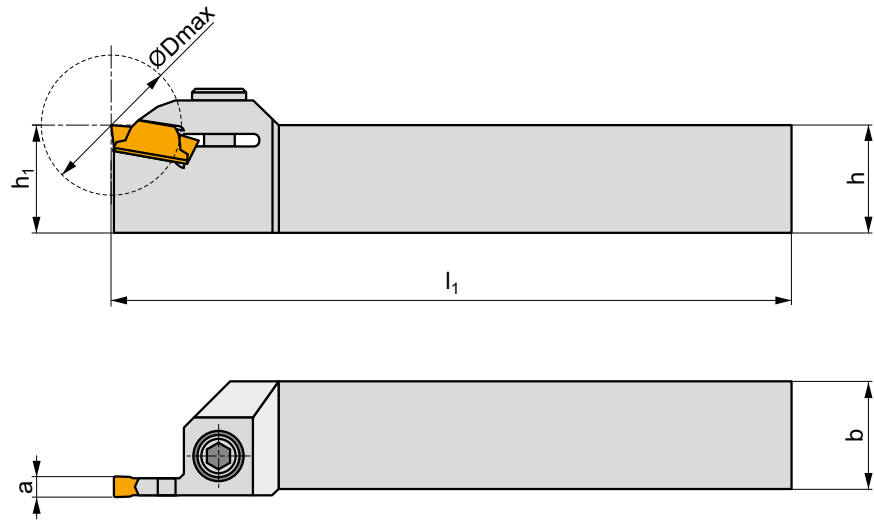
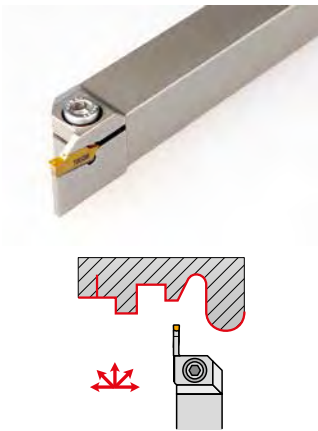
KV2	KV 15x150

**GFK(RL) EXT**

**P M K N S H**

**G**

T149-T155



ANSI	$h=h_1$	b	$l_1$	a	$D_{max}$	lbs	IGI022	IGL03
GFKR/L 10A 02	.625	.625	4.000	.078	1.259	.40	IGI022	IGL03
GFKR/L 12C 02	.750	.750	5.000	.078	1.259	.71	IGI022	IGL03
GFKR/L 16D 02	1.000	1.000	6.000	.078	1.259	1.50	IGI022	IGL05

IGI022	LCMF 022..
--------	------------

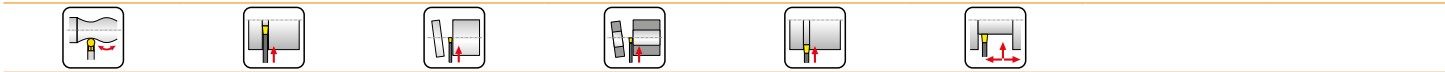
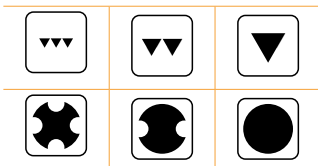
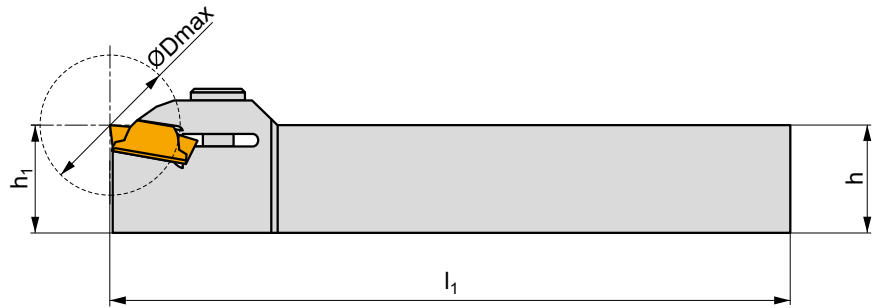
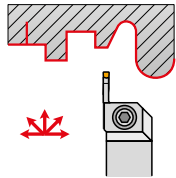
IGL03	HS 0616C	Nm	M6	.63	HXX 5
IGL05	HS 0625C	6.0	M6	.98	HXX 5

# GFI(RL) EXT

P M K N S H

G

T149-T155



ANSI	$h=h_1$	b	$l_1$	a	$D_{max}$	lbs		
GFIR/L 10A 03	.625	.625	4.000	.118	.708	.40	IGI016	IGL03
GFIR/L 12C 03	.750	.750	5.000	.118	.708	.73	IGI016	IGL03
GFIR/L 16D 03	1.000	1.000	6.000	.118	.708	1.57	IGI016	IGL05
GFIR/L 10A 04	.625	.625	4.000	.157	.944	.40	IGI018	IGL03
GFIR/L 12C 04	.750	.750	5.000	.157	.944	.73	IGI018	IGL03
GFIR/L 16D 04	1.000	1.000	6.000	.157	.944	1.54	IGI018	IGL05
GFIR/L 12C 05	.750	.750	5.000	.196	1.102	.73	IGI019	IGL03
GFIR/L 16D 05	1.000	1.000	6.000	.196	1.102	1.52	IGI019	IGL05
GFIR/L 12C 06	.750	.750	5.000	.236	1.102	.73	IGI020	IGL03
GFIR/L 16D 06	1.000	1.000	6.000	.236	1.102	1.50	IGI020	IGL05
GFIR/L 16D 08	1.000	1.000	7.000	.315	1.890	1.54	IGI021	IGL09
GFIR/L 85E 08	1.250	1.000	7.000	.315	1.890	2.20	IGI021	IGL09

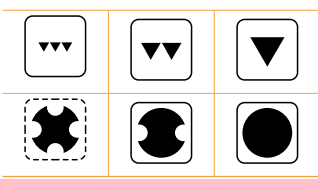
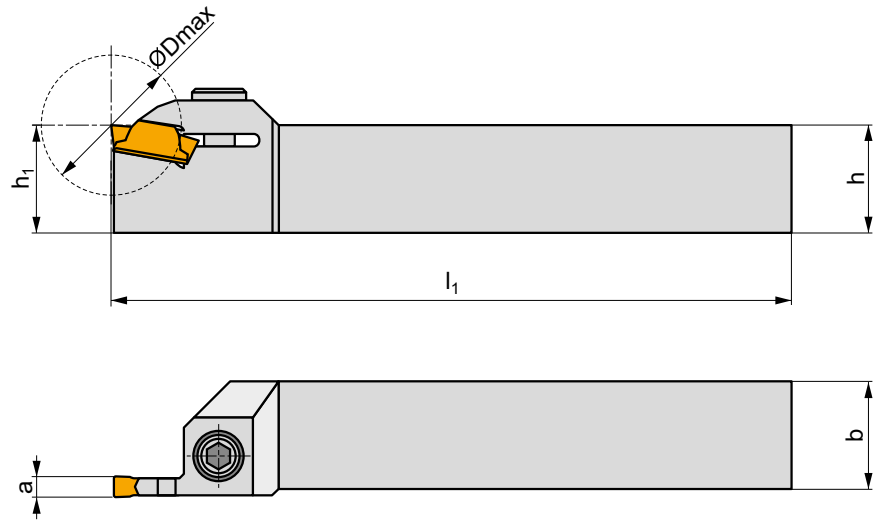
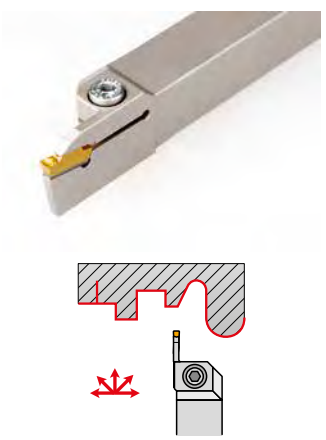
IGI016	LCM. 0316..
IGI018	LCM. 0416..
IGI019	LCM. 0516..
IGI020	LCM. 0616..
IGI021	LCM. 083..

IGL05	HS 0625C	6.0	M6	.98	HXK 5
IGL09	HSI 1020	8.0	M10	.79	HXK 6
IGL03	HS 0616C	6.0	M6	.63	HXK 5

**GFM(RL) EXT**

**P M K N S H**

**G**  
T149-T155



ANSI	$h=h_1$	b	$l_1$	a	$D_{max}$	lbs		
GFMR/L 12C 0316	.750	.750	5.000	.118	1.181	.71	IGI016	IGL04
GFMR/L 16D 0316	1.000	1.000	6.000	.118	1.181	.68	IGI016	IGL04
GFMR/L 12C 0416	.750	.750	5.000	.158	1.575	1.50	IGI018	IGL04
GFMR/L 16D 0416	1.000	1.000	6.000	.158	1.575	1.46	IGI018	IGL04
GFMR/L 16D 0516	1.000	1.000	6.000	.197	1.969	1.43	IGI019	IGL04
GFMR/L 85E 0516	1.250	1.000	7.000	.197	1.969	1.41	IGI019	IGL04
GFMR/L 16D 0616	1.000	1.000	6.000	.236	2.362	2.14	IGI020	IGL04
GFMR/L 85E 0616	1.250	1.000	7.000	.236	2.362	2.12	IGI020	IGL04
GFMR/L 85E 0830	1.250	1.000	7.000	.315	3.150	2.03	IGI021	IGL09

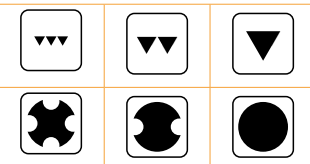
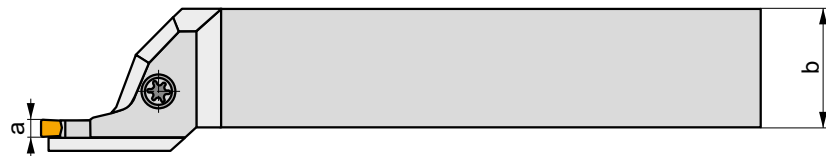
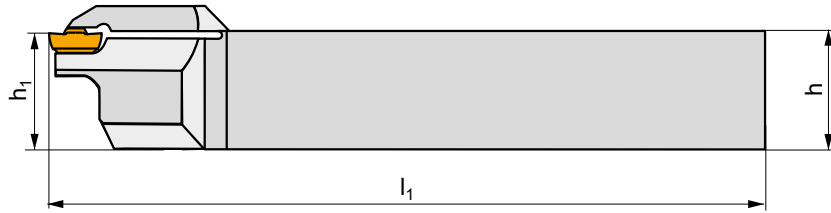
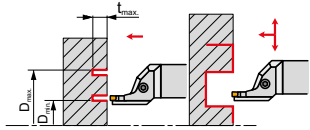
IGI016	LCM. 0316..
IGI018	LCM. 0416..
IGI019	LCM. 0516..
IGI020	LCM. 0616..
IGI021	LCM. 083..

IGL04	HS 0620C	6.0	M6	.79	HXK 5
IGL09	HSI 1020	8.0	M10	.79	HXK 6










# GFIR-L AXIAL

P M K N S H



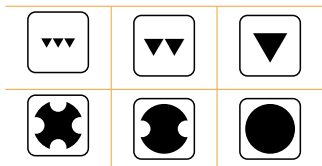
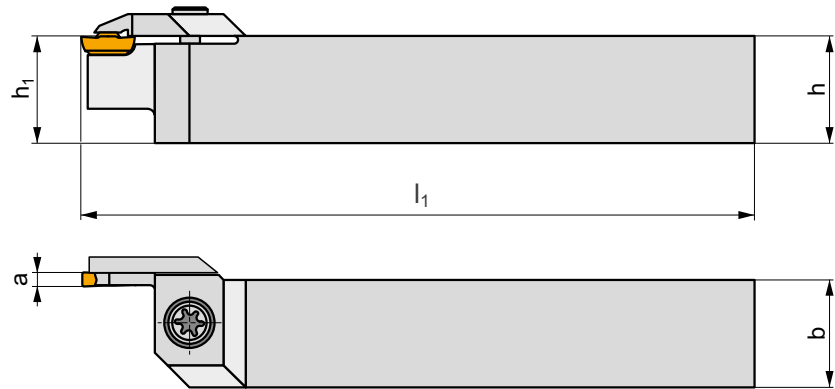
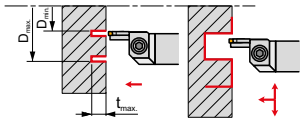
ANSI	$h=h_1$	b	$l_1$	a	$t_{max}$	$D_{min}$	$D_{max}$	lbs		
GFIR 16D 03L 1.18-670	1.000	1.000	6.000	.118	.374	.670	1.180	1.52	IGI014	IGL07
GFIR 16D 03L 1.54-940	1.000	1.000	6.000	.118	.374	.940	1.540	1.52	IGI014	IGL07
GFIR 16D 03L 1.97-1.30	1.000	1.000	6.000	.118	.433	1.300	1.970	1.50	IGI014	IGL07
GFIR 16D 03L 2.36-1.69	1.000	1.000	6.000	.118	.433	1.690	2.360	1.50	IGI014	IGL07
GFIR 16D 03L 2.99-2.09	1.000	1.000	6.000	.118	.433	2.090	2.990	1.50	IGI014	IGL07
GFIR 16D 03L 3.94-2.76	1.000	1.000	6.000	.118	.354	2.760	3.940	1.50	IGI016	IGL08
GFIR 16D 03L 5.12-3.54	1.000	1.000	6.000	.118	.354	3.540	5.120	1.52	IGI016	IGL08
GFIR 16D 03L 6.69-4.33	1.000	1.000	6.000	.118	.354	4.330	6.690	1.50	IGI016	IGL08
GFIR 16D 04L 1.18-670	1.000	1.000	6.000	.158	.374	.670	1.180	1.52	IGI017	IGL07
GFIR 16D 04L 1.34-826	1.000	1.000	6.000	.158	.374	.826	1.340	1.54	IGI017	IGL07
GFIR 16D 04L 1.57-1.02	1.000	1.000	6.000	.158	.433	1.020	1.570	1.52	IGI017	IGL07
GFIR 16D 04L 1.97-1.26	1.000	1.000	6.000	.158	.433	1.260	1.970	1.52	IGI017	IGL07
GFIR 16D 04L 2.36-1.65	1.000	1.000	6.000	.158	.433	1.650	2.360	1.52	IGI017	IGL07
GFIR 16D 04L 2.95-2.05	1.000	1.000	6.000	.158	.433	2.050	2.950	1.52	IGI017	IGL07
GFIR 16D 04L 3.94-2.76	1.000	1.000	6.000	.158	.472	2.760	3.940	1.50	IGI018	IGL08
GFIR 16D 04L 5.12-3.54	1.000	1.000	6.000	.158	.472	3.540	5.120	1.50	IGI018	IGL08
GFIR 16D 04L 6.69-4.33	1.000	1.000	6.000	.158	.472	4.330	6.690	1.50	IGI018	IGL08
GFIR 16D 04L 9.06-5.51	1.000	1.000	6.000	.158	.472	5.510	9.060	1.50	IGI018	IGL08

IGI014	LCM. 0313..
IGI016	LCM. 0316..
IGI017	LCM. 0413..
IGI018	LCM. 0416..

		 Nm				
IGL07	US 5018-T20P	5.0	M5	.71	FLAG T20P	-
IGL08	US 6020-T25P	6.0	M6	.79	-	SDR T25P








# GFIL-R AXIAL

P M K N S H



ANSI	$h=h_1$	b	$l_1$	a	$t_{max}$	$D_{min}$	$D_{max}$	lbs		
GFIL 16D 03R 1.18-.670	1.000	1.000	6.000	.118	.374	.670	1.180	1.52	IGI014	IGL07
GFIL 16D 03R 1.54-.940	1.000	1.000	6.000	.118	.374	.940	1.540	1.52	IGI014	IGL07
GFIL 16D 03R 1.97-1.30	1.000	1.000	6.000	.118	.433	1.300	1.970	1.50	IGI014	IGL07
GFIL 16D 03R 2.36-1.69	1.000	1.000	6.000	.118	.433	1.690	2.360	1.50	IGI014	IGL07
GFIL 16D 03R 2.99-2.09	1.000	1.000	6.000	.118	.433	2.090	2.990	1.50	IGI014	IGL07
GFIL 16D 03R 3.94-2.76	1.000	1.000	6.000	.118	.354	2.760	3.940	1.50	IGI016	IGL08
GFIL 16D 03R 5.12-3.54	1.000	1.000	6.000	.118	.354	3.540	5.120	1.52	IGI016	IGL08
GFIL 16D 03R 6.69-4.33	1.000	1.000	6.000	.118	.354	4.330	6.690	1.50	IGI016	IGL08
GFIL 16D 04R 1.18-.670	1.000	1.000	6.000	.158	.374	.670	1.180	1.52	IGI017	IGL07
GFIL 16D 04R 1.34-.826	1.000	1.000	6.000	.158	.374	.826	1.340	1.54	IGI017	IGL07
GFIL 16D 04R 1.57-1.02	1.000	1.000	6.000	.158	.433	1.020	1.570	1.52	IGI017	IGL07
GFIL 16D 04R 1.97-1.26	1.000	1.000	6.000	.158	.433	1.260	1.970	1.52	IGI017	IGL07
GFIL 16D 04R 2.36-1.65	1.000	1.000	6.000	.158	.433	1.650	2.360	1.52	IGI017	IGL07
GFIL 16D 04R 2.95-2.05	1.000	1.000	6.000	.158	.433	2.050	2.950	1.52	IGI017	IGL07
GFIL 16D 04R 3.94-2.76	1.000	1.000	6.000	.158	.472	2.760	3.940	1.50	IGI018	IGL08
GFIL 16D 04R 5.12-3.54	1.000	1.000	6.000	.158	.472	3.540	5.120	1.50	IGI018	IGL08
GFIL 16D 04R 6.69-4.33	1.000	1.000	6.000	.158	.472	4.330	6.690	1.50	IGI018	IGL08
GFIL 16D 04R 9.06-5.51	1.000	1.000	6.000	.158	.472	5.510	9.060	1.50	IGI018	IGL08

IGI014	LCM. 0313..
IGI016	LCM. 0316..
IGI017	LCM. 0413..
IGI018	LCM. 0416..

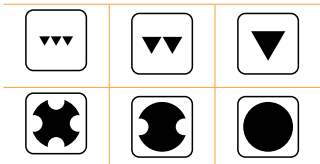
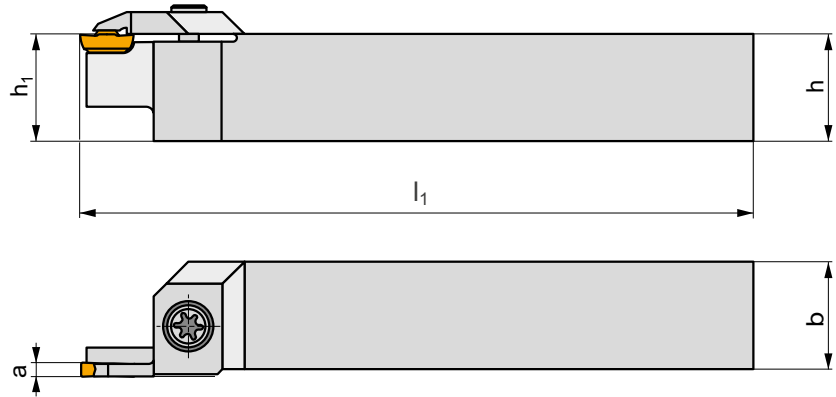
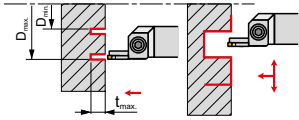
		 Nm				
IGL07	US 5018-T20P	5.0	M5	.71	FLAG T20P	-
IGL08	US 6020-T25P	6.0	M6	.79	-	SDR T25P

**GFIR-R AXIAL**

**P M K N S H**

**G**

T149-T155



ANSI	$h=h_1$	$b$	$l_1$	$a$	$t_{max}$	$D_{min}$	$D_{max}$	lbs	IGI014	IGL07
GFIR 16D 0313R 1.18-.670	1.000	1.000	6.000	.118	.354	.670	1.180	1.46	IGI014	IGL07
GFIR 16D 0313R 1.54-.940	1.000	1.000	6.000	.118	.354	.940	1.540	1.48	IGI014	IGL07
GFIR 16D 0313R 1.97-1.30	1.000	1.000	6.000	.118	.354	1.300	1.970	1.50	IGI014	IGL07
GFIR 16D 0313R 2.36-1.69	1.000	1.000	6.000	.118	.354	1.690	2.360	1.52	IGI014	IGL07
GFIR 16D 0313R 2.99-2.09	1.000	1.000	6.000	.118	.354	2.090	2.990	1.52	IGI014	IGL07
GFIR 16D 0316R 3.94-2.76	1.000	1.000	6.000	.118	.354	2.760	3.940	1.54	IGI016	IGL07
GFIR 16D 0316R 5.12-3.54	1.000	1.000	6.000	.118	.354	3.540	5.120	1.57	IGI016	IGL07
GFIR 16D 0316R 6.69-4.33	1.000	1.000	6.000	.118	.354	4.330	6.690	1.57	IGI016	IGL07

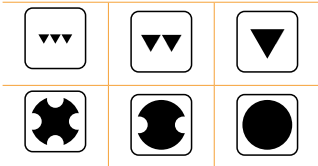
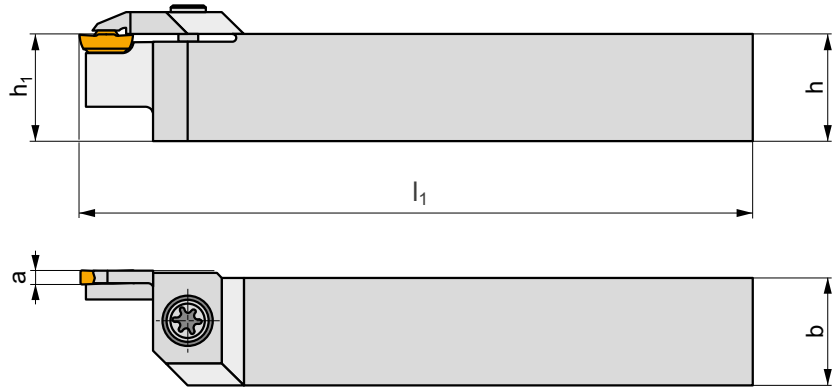
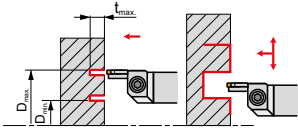
IGI014	LCM. 0313..
IGI016	LCM. 0316..

IGL07	US 5018-T20P	5.0	M5	.71	FLAG T20P
-------	--------------	-----	----	-----	-----------

**GFIL-L AXIAL**

**P M K N S H**

**G**  
T149-T155



ANSI	$h=h_1$	b	$l_1$	a	$t_{max}$	$D_{min}$	$D_{max}$	lbs	IGI014	IGL07
GFIL 16D 0313L 1.18-.670	1.000	1.000	6.000	.118	.354	.670	1.180	1.46	IGI014	IGL07
GFIL 16D 0313L 1.54-.940	1.000	1.000	6.000	.118	.354	.940	1.540	1.48	IGI014	IGL07
GFIL 16D 0313L 1.97-1.30	1.000	1.000	6.000	.118	.354	1.300	1.970	1.50	IGI014	IGL07
GFIL 16D 0313L 2.36-1.69	1.000	1.000	6.000	.118	.354	1.690	2.360	1.52	IGI014	IGL07
GFIL 16D 0313L 2.99-2.09	1.000	1.000	6.000	.118	.354	2.090	2.990	1.52	IGI014	IGL07
GFIL 16D 0316L 3.94-2.76	1.000	1.000	6.000	.118	.354	2.760	3.940	1.54	IGI016	IGL07
GFIL 16D 0316L 5.12-3.54	1.000	1.000	6.000	.118	.354	3.540	5.120	1.57	IGI016	IGL07
GFIL 16D 0316L 6.69-4.33	1.000	1.000	6.000	.118	.354	4.330	6.690	1.57	IGI016	IGL07

IGI014	LCM. 0313..
IGI016	LCM. 0316..

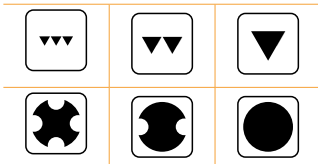
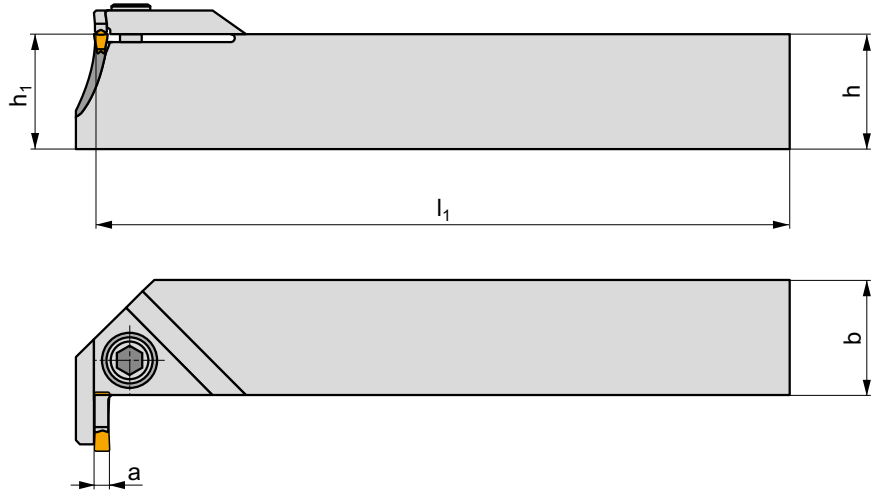
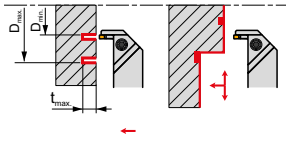
IGL07	US 5018-T20P	5.0	M5	.71	FLAG T20P
-------	--------------	-----	----	-----	-----------

# GGI(RL)-90 AXIAL

P M K N S H

G

T149-T155



ANSI	$h=h_1$	b	$l_1$	a	$t_{max}$	$D_{min}$	$D_{max}$	lbs		
GGIR 16D 03R 1.18-.670	1.000	1.000	6.000	.118	.374	.670	1.180	1.70	IGI014	IGL01
GGIR 16D 03R 1.54-.940	1.000	1.000	6.000	.118	.374	.940	1.540	1.70	IGI014	IGL01
GGIR 16D 03R 1.97-1.30	1.000	1.000	6.000	.118	.433	1.300	1.970	1.70	IGI014	IGL01
GGIR 16D 03R 2.36-1.69	1.000	1.000	6.000	.118	.433	1.690	2.360	1.70	IGI014	IGL01
GGIR 16D 03R 2.99-2.09	1.000	1.000	6.000	.118	.433	2.090	2.990	1.70	IGI014	IGL01
GGIR 16D 03R 3.94-2.76	1.000	1.000	6.000	.118	.354	2.760	3.940	1.70	IGI016	IGL04
GGIR 16D 03R 5.12-3.54	1.000	1.000	6.000	.118	.354	3.540	5.120	1.70	IGI016	IGL04
GGIR 16D 03R 6.69-4.33	1.000	1.000	6.000	.118	.354	4.330	6.690	1.70	IGI016	IGL04
GGIL 16D 03L 1.18-.670	1.000	1.000	6.000	.118	.374	.670	1.180	1.70	IGI014	IGL01
GGIL 16D 03L 1.54-.940	1.000	1.000	6.000	.118	.374	.940	1.540	1.70	IGI014	IGL01
GGIL 16D 03L 1.97-1.30	1.000	1.000	6.000	.118	.433	1.300	1.970	1.70	IGI014	IGL01
GGIL 16D 03L 2.36-1.69	1.000	1.000	6.000	.118	.433	1.690	2.360	1.70	IGI014	IGL01
GGIL 16D 03L 2.99-2.09	1.000	1.000	6.000	.118	.433	2.090	2.990	1.70	IGI014	IGL01
GGIL 16D 03L 3.94-2.76	1.000	1.000	6.000	.118	.354	2.760	3.940	1.70	IGI016	IGL04
GGIL 16D 03L 5.12-3.54	1.000	1.000	6.000	.118	.354	3.540	5.120	1.70	IGI016	IGL04
GGIL 16D 03L 6.69-4.33	1.000	1.000	6.000	.118	.354	4.330	6.690	1.70	IGI016	IGL04

IGI014	LCM. 0313..
IGI016	LCM. 0316..

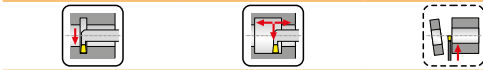
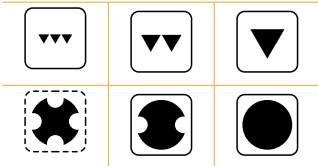
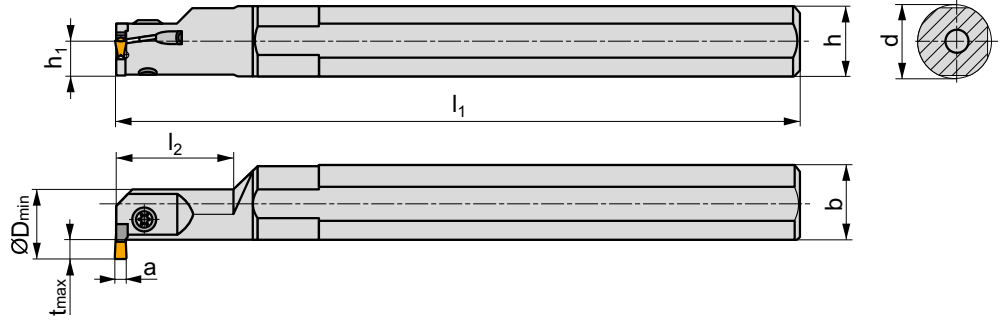
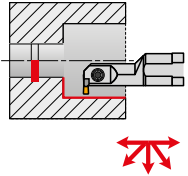
IGL01	HS 0520C	5.0	M5	.79	HXX 4
IGL04	HS 0620C	6.0	M6	.79	HXX 5

**GG.(RL) INT**

**P M K N S H**

**G**

T149-T155



ANSI	d	h	h <sub>1</sub>	b	l <sub>1</sub>	l <sub>2</sub>	a	t <sub>max</sub>	D <sub>min</sub>				
<b>A10Q-GGER/L 0313-04</b>	.625	.591	.296	.608	7.000	.984	.118	.118	.630	#	.51	IGI015	IGL06
<b>A12R-GGFR/L 0313-04</b>	.750	.709	.355	.729	8.000	1.181	.118	.217	.787	#	.73	IGI015	IGL06
<b>A16S-GGHR/L 0313</b>	1.000	.906	.453	.953	10.000	1.575	.118	.295	.984	#	1.70	IGI014	IGL06
<b>A16S-GGFR/L 0413</b>	1.000	.906	.453	.953	10.000	1.575	.158	.295	.984	#	1.70	IGI017	IGL06
<b>A20T-GGHR/L 0413</b>	1.250	1.181	.591	1.216	12.000	1.969	.158	.413	1.260	#	3.42	IGI017	IGL06

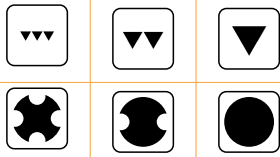
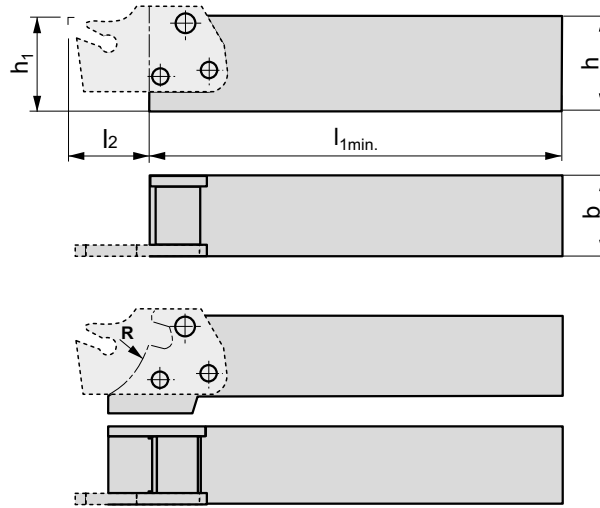
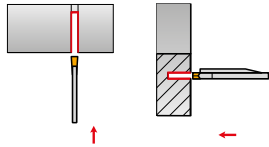
IGI014	LCM. 0313..
IGI015	LCM. 0313....04
IGI017	LCM. 0413..

IGL06	SR 85011-T15P	5.0	M5	.35	FLAG T15P



# MS-EN

T149-T155



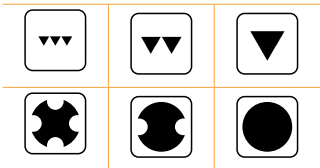
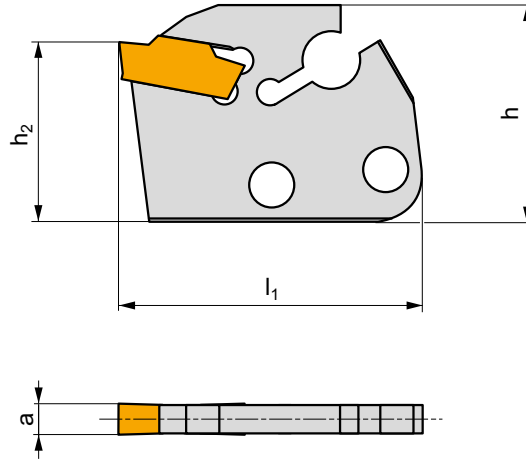
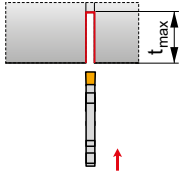
ANSI	$h=h_1$	b	$l_{1min}$	$l_2$	R	lbs		
MS-EN-08 A	.500	.500	4.000	.591 (.788)	-	.29	IGI072	IND4
MS-EN-10 A	.625	.625	4.000	.591 (.788)	-	.44	IGI072	IND4
MS-EN-12 C	.750	.750	5.000	.591 (.984)	-	.82	IGI068	IND5
MS-EN-16 D	1.000	1.000	6.000	.591 (.984)	-	1.65	IGI068	IND5
MS-EN-85 E	1.250	1.000	7.000	.591 (.984)	-	2.40	IGI068	IND5

IGI068	XLC.. 25..15...
IGI072	XLCF. 16..15...

IND4	3x US 4011-T15P	3.5	M4	.42	-	-	-	-	FLAG T15P
IND5	2x US 45013-T20P	5.0	M5	.51	US 46017-T20P	5.0	M6	17	FLAG T20P

**XLCCN 25 BS**

**P M K N S H**



ANSI	h	h <sub>2</sub>	l <sub>1</sub>	a	t <sub>max</sub>	lbs		
XLCCN 250215-0316	1.142	.945	1.575	.118	.591	.02	IGI016	-
XLCCN 250225-0316	1.142	.945	1.969	.118	.984	.04	IGI016	-
XLCCN 250315-0416	1.142	.945	1.575	.157	.591	.04	IGI018	-
XLCCN 250325-0416	1.142	.945	1.969	.157	.984	.07	IGI018	-
XLCCN 250425-0516	1.142	.945	1.969	.197	.984	.07	IGI019	-
XLCCN 250525-0616	1.142	.945	1.969	.236	.984	.09	IGI020	-

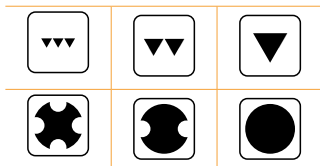
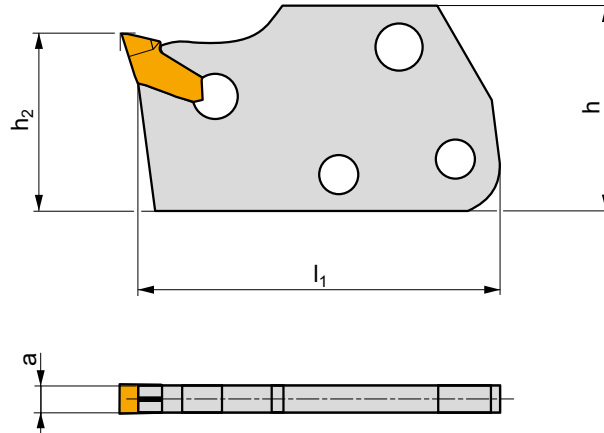
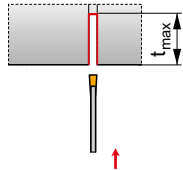
IGI016	LCM. 0316..
IGI018	LCM. 0416..
IGI019	LCM. 0516..
IGI020	LCM. 0616..

# XLCF(NRL) BS

P M K N S H

X

T154-T155



ANSI	h	h <sub>2</sub>	l <sub>1</sub>	a	t <sub>max</sub>	lbs		
XLCFN 160215-3.00	.984	.472	1.378	.122	.591	.02	IGI025	KV
XLCFN 160220-3.00	.984	.472	1.575	.122	.787	.04	IGI025	KV
XLCFN 250215-3.00	1.142	.945	1.575	.122	.591	.04	IGI025	KV
XLCFN 250225-3.00	1.142	.945	1.969	.122	.984	.04	IGI025	KV
XLCFN 250315-4.00	1.142	.945	1.575	.161	.591	.04	IGI026	KV
XLCFN 250325-4.00	1.142	.945	1.969	.161	.984	.07	IGI026	KV
XLCFN 250425-5.00	1.142	.945	1.969	.201	.984	.09	IGI027	KV
XLCFN 250525-6.35	1.142	.945	1.969	.250	.984	.09	IGI028	KV
XLCFR/L 160115-1.60	.984	.472	1.378	.059 - .063	.591	.02	IGI023	KV
XLCFR/L 160115-2.00	.984	.472	1.378	.079 - .087	.591	.02	IGI024	KV
XLCFR/L 250115-1.60	1.142	.945	1.575	.059 - .063	.591	.02	IGI023	KV
XLCFR/L 250115-2.00	1.142	.945	1.575	.079 - .087	.591	.02	IGI024	KV

IGI023	LFMX 1.5.	LFMX 1.6.
IGI024	LFMX 2..	LFMX 2.2.
IGI025	LFMX 3.1.	-
IGI026	LFMX 4.1.	-
IGI027	LFMX 5.1.	-
IGI028	LFMX 6.35.	-

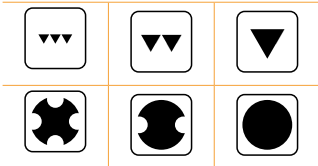
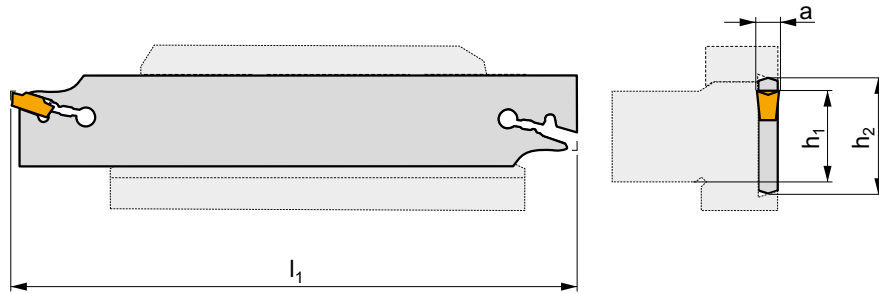
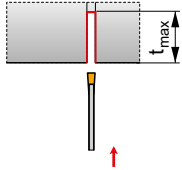
KV	KV 5x70

# XLCCN B

P M K N S H

X

T149-T154



ANSI	$h_1$	$h_2$	$l_1$	$a$	$t_{max}$	lbs		
XLCCN 2602 J 0316	.787	1.024	4.331	.118	1.378	.11	IGI016	KV1
XLCCN 3202 M 0316	.984	1.260	5.906	.118	1.969	.18	IGI016	KV1
XLCCN 3203 M 0416	.984	1.260	5.906	.157	1.969	.24	IGI018	KV1
XLCCN 3204 M 0516	.984	1.260	5.906	.197	2.362	.31	IGI019	KV1
XLCCN 3205 M 0616	.984	1.260	5.906	.236	2.362	.37	IGI020	KV1

IGI016	LCM. 0316..
IGI018	LCM. 0416..
IGI019	LCM. 0516..
IGI020	LCM. 0616..

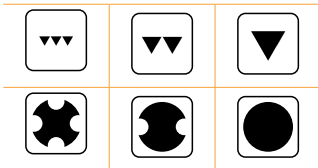
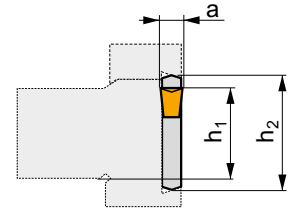
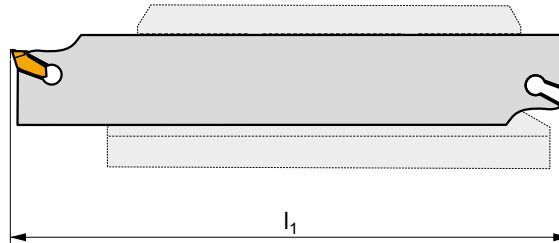
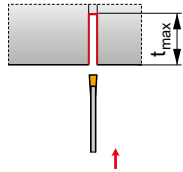
KV1	KV 5x100

# XLCFN B

P M K N S H

X

T154-T155



ANSI	$h_1$	$h_2$	$l_1$	$a$	$t_{max}$	lbs	IGI023	KV
XLCFN 2601 J 1.60	.787	1.024	4.331	.059 - .063	.591	.07	IGI023	KV
XLCFN 2601 J 2.00	.787	1.024	4.331	.079 - .087	.984	.09	IGI024	KV
XLCFN 2602 J 3.00	.787	1.024	4.331	.122	1.476	.11	IGI025	KV
XLCFN 2603 J 4.00	.787	1.024	4.331	.161	1.575	.13	IGI026	KV
XLCFN 3201 M 1.60	.984	1.260	5.906	.059 - .063	.591	.13	IGI023	KV
XLCFN 3201 M 2.00	.984	1.260	5.906	.079 - .087	.984	.15	IGI024	KV
XLCFN 3202 M 3.00	.984	1.260	5.906	.122	1.969	.18	IGI025	KV
XLCFN 3203 M 4.00	.984	1.260	5.906	.161	1.969	.24	IGI026	KV
XLCFN 3204 M 5.00	.984	1.260	5.906	.201	2.362	.31	IGI027	KV
XLCFN 3205 M 6.35	.984	1.260	5.906	.250	2.362	.37	IGI028	KV
XLCFN 4502 S 3.00	1.260	1.772	9.843	.122	3.150	.26	IGI025	KV
XLCFN 4503 S 4.00	1.260	1.772	9.843	.161	3.150	.42	IGI026	KV
XLCFN 4504 S 5.00	1.260	1.772	9.843	.201	3.150	.62	IGI027	KV
XLCFN 4505 S 6.35	1.260	1.772	9.843	.250	3.150	.88	IGI028	KV

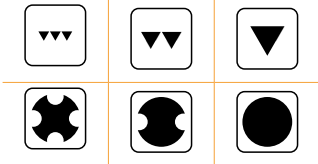
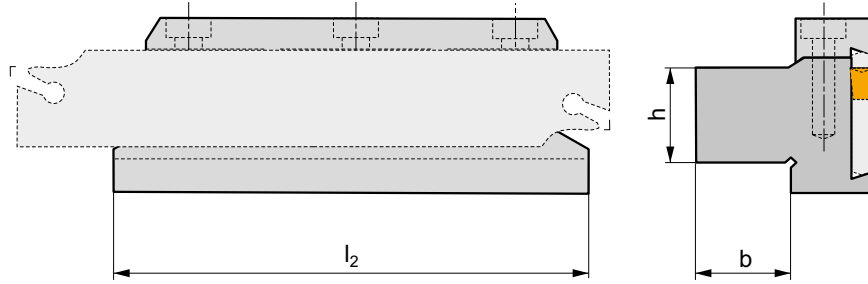
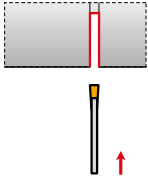
IGI023	LFMX 1.5.	LFMX 1.6.
IGI024	LFMX 2..	LFMX 2.2.
IGI025	LFMX 3.1.	-
IGI026	LFMX 4.1.	-
IGI027	LFMX 5.1.	-
IGI028	LFMX 6.35.	-

KV	KV 5x70

# DU. D

P M K N S H

T149-T155



ANSI	h	b	$l_2$	lbs		
26-DU 12	.750	.750	3.540	1.15	IGI069	IND2
32-DU 74	1.000	.875	4.330	1.87	IGI070	IND2
32-DU 104	1.000	1.250	4.330	2.31	IGI070	IND2
32-DU 95	1.250	1.125	4.330	2.31	IGI070	IND2
45-DU 95	1.250	1.125	4.330	2.98	IGI071	IND7
45-DU 24	1.500	1.500	4.330	3.90	IGI071	IND7

IGI069	XLC.N 26..
IGI070	XLC.N 32..
IGI071	XLC.N 45..

IND2	HS 0625	6.0	M6	.98	HXX 5
IND7	HS 0630	6.0	M6	1.18	HXX 5

<b>ISO</b>	<b>1</b>	<b>2</b>	<b>3</b>	-	<b>4</b>	<b>5</b>	<b>6</b>	<b>7</b>	-	<b>8</b>
	<b>S</b>	<b>E</b>	<b>R</b>		<b>S</b>	<b>2525</b>	<b>M</b>	<b>16</b>		
<b>ANSI</b>	<b>1</b>	<b>2</b>	<b>3</b>	-	<b>4</b>	<b>5</b>	<b>6</b>	<b>7</b>	-	<b>8</b>
	<b>S</b>	<b>E</b>	<b>R</b>		<b>S</b>	<b>16</b>	<b>D</b>	<b>16</b>		

<b>1</b>	<b>1</b>	<b>2</b>	<b>2</b>	<b>3</b>	<b>3</b>	<b>4</b>	<b>4</b>
Clamping designation Tipo de fijación Désignation de la fixation		Machining orientation Tipo de mecanizado Procédé d'usinage		Direction of cut Dirección del corte Direction de coupe		Type of construction Tipo de construcción Type de construction	
C		E	External Exterior Extérieur	R-Right	External Exterior Extérieur	-	Normal
P					Internal Intérieur		
M		I	Internal Intérieur	L-Left	External Exterior Extérieur	S	Special Especial Spécial
S					Internal Intérieur		

<b>5</b>	
Holder dimensions [mm] Dimensiones del portaherramientas [mm] Dimensions de l'outil [mm]	
External turning Mecanizado exterior Tournage extérieur	2525 25 x 25 mm
Internal turning Mecanizado interior Tournage intérieur	1416 Shank - 14 mm / Shank height Ø - 16 mm Mango - 14 mm / Ø montaje - 16mm Queue - 14 mm / Ø Hauteur de manche - 16 mm

<b>6</b>	
Holder total length Longitud total Longueur totale de l'outil	
	l <sub>1</sub> [mm]
	K 125
	L 140
	M 150
	N 160
	P 170
	Q 180
	R 200
	S 250
	T 300

<b>7</b>		
Insert cutting edge length (insert size) Longitud del filo de corte (tamaño de plaqueta) Longueur de l'arête de coupe (taille de plaquette)		
d = I.C.	T	
	[mm]	[in]
	6,350	1/4
	9,525	3/8
	12,700	1/2

<b>5</b>																						
Tool dimensions [in] Dimensiones de la herramienta (pulgadas) Dimensions de l'outil [in]																						
	<table border="1"> <tr> <td></td> <td>b [in]</td> <td>h [in]</td> </tr> <tr> <td>10</td> <td>5/8</td> <td>5/8</td> </tr> <tr> <td>12</td> <td>3/4</td> <td>3/4</td> </tr> <tr> <td>16</td> <td>1</td> <td>1</td> </tr> <tr> <td>85</td> <td>1</td> <td>1 1/4</td> </tr> <tr> <td>86</td> <td>1</td> <td>1 1/2</td> </tr> <tr> <td>20</td> <td>1 1/4</td> <td>1 1/4</td> </tr> </table>		b [in]	h [in]	10	5/8	5/8	12	3/4	3/4	16	1	1	85	1	1 1/4	86	1	1 1/2	20	1 1/4	1 1/4
	b [in]	h [in]																				
10	5/8	5/8																				
12	3/4	3/4																				
16	1	1																				
85	1	1 1/4																				
86	1	1 1/2																				
20	1 1/4	1 1/4																				
	<table border="1"> <tr> <td></td> <td>d [in]</td> </tr> <tr> <td>08</td> <td>.500</td> </tr> <tr> <td>10</td> <td>.625</td> </tr> <tr> <td>12</td> <td>.750</td> </tr> <tr> <td>16</td> <td>1.000</td> </tr> <tr> <td>20</td> <td>1.250</td> </tr> <tr> <td>24</td> <td>1.500</td> </tr> </table>		d [in]	08	.500	10	.625	12	.750	16	1.000	20	1.250	24	1.500							
	d [in]																					
08	.500																					
10	.625																					
12	.750																					
16	1.000																					
20	1.250																					
24	1.500																					

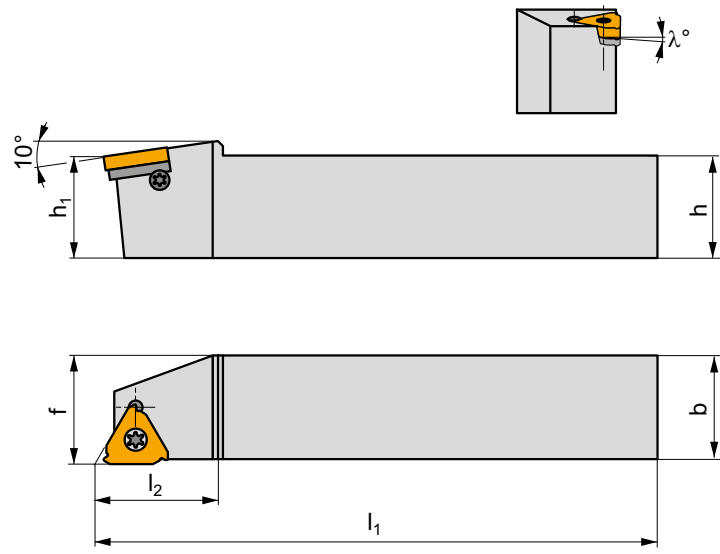
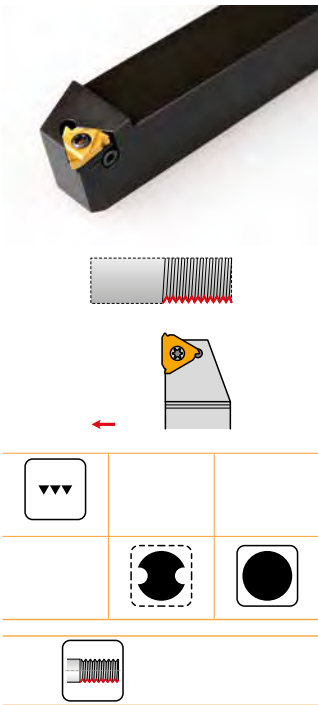
<b>6</b>	
	l <sub>1</sub> [in]
	C 5.000
	D 6.000
	E 7.000
	F 8.000
	l <sub>1</sub> [in]
	K 5.000
	M 6.000
	P 6.250
	Q 7.250
	R 8.000
	S 10.000
	T 12.000
	U 14.000

<b>8</b>	
Helix angle λ Ángulo de hélice λ Angle d'hélice λ	
0	Helix angle λ = 0° Ángulo de hélice λ = 0° Angle d'hélice λ = 0°
1	Helix angle λ = 1° Ángulo de hélice λ = 1° Angle d'hélice λ = 1°
2	Helix angle λ = 2° Ángulo de hélice λ = 2° Angle d'hélice λ = 2°

**SE(RL)**

**P M K N S H**

**S**  
T157-T180



ANSI	$h=h_1$	$b$	$f$	$l_1$	$l_2$	$\lambda^\circ$	lbs		
SER/L 12 C16	.750	.750	.750	5.000	.900	T334	.77	IGI048	IZ12
SER/L 16 D16	1.000	1.000	1.000	6.000	.950	T334	1.54	IGI048	IZ12
SER/L 85 D16	1.250	1.000	1.000	6.000	1.000	T334	1.98	IGI048	IZ12
SER/L 16 D22	1.000	1.000	1.000	6.000	1.000	T334	1.54	IGI052	IZ13
SER/L 85 D22	1.250	1.000	1.000	6.000	1.000	T334	1.98	IGI052	IZ13

IGI048	TN 16EL..	TN 16ER..
IGI052	TN 22EL..	TN 22ER..

IZ12	US 3512A-T15P	3.0	M3.5	.50	-	HS 0304	FLAG T15P	HXK 2.5	T334
IZ13	US 4514A-T20	5.0	M4.5	.55	SP 0405	-	FLAG T20	-	T334

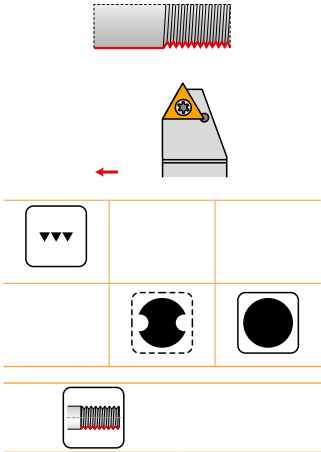
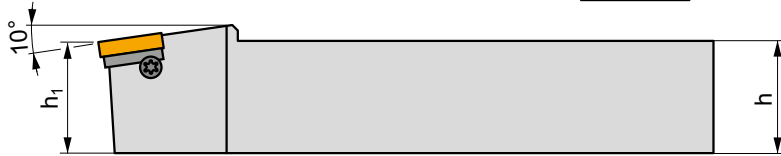
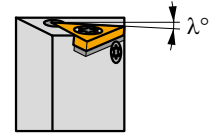


**SE(RL)-S**

**P M K N S H**

**S**

T157-T180



ANSI	$h=h_1$	$b$	$f$	$l_1$	$l_2$	$\lambda^\circ$	lbs	IGI053	IZ13
SER/L-S 16 D22	1.000	1.000	.575	6.000	1.200	T334	.77	IGI053	IZ13
SER/L-S 85 D22	1.250	1.000	.575	6.000	1.200	T334	1.54	IGI053	IZ13

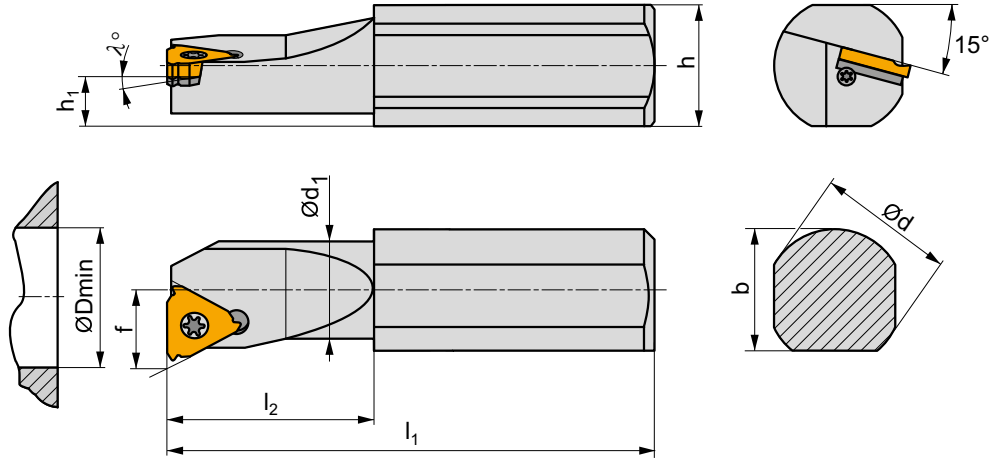
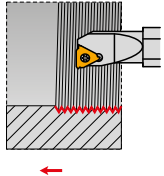
IGI053	TN 22EN..
--------	-----------

IZ13	US 4514A-T20	3.0	M4.5	.55	SP 0405	FLAG T20	T334
------	--------------	-----	------	-----	---------	----------	------

**SI(RL)**

**P M K N S H**

**S**  
T157-T180



ANSI	b	d	D <sub>min</sub>	d <sub>1</sub>	f	h	h <sub>1</sub>	l <sub>1</sub>	l <sub>2</sub>	λ°		lbs			
SIR/L 10 K11-0	.570	.625	.500	.380	.295	.550	-	5.000	1.000	0	-	.33	IGI046	IZ11	
SIR/L 10 K11-1	.570	.625	.500	.380	.295	.550	-	5.000	1.000	1	-	.33	IGI046	IZ11	
SIR/L 10 M11-0	.570	.625	.630	.500	.350	.550	-	6.000	1.250	0	-	.44	IGI046	IZ11	
SIR/L 10 M11-1	.570	.625	.630	.500	.350	.550	-	6.000	1.250	1	-	.44	IGI046	IZ11	
SIR/L 10 M16-0	.550	.625	.850	-	.450	.550	-	6.000	-	0	-	.44	IGI050	IZ9	
SIR/L 10 M16-1	.550	.625	.850	-	.450	.550	-	6.000	-	1	-	.44	IGI050	IZ9	
SIR/L 10 M16-2**	.550	.625	.650	.600	.430	.550	-	6.000	1.500	2	✓	.44	IGI050	IZ10	
SIR/L 12 P16	.700	.750	.850	-	.500	.700	-	6.250	-		T336	-	.66	IGI050	IZ12
SIR/L 16 Q16	.900	1.000	1.150	-	.650	.900	-	7.250	-		T336	-	1.37	IGI050	IZ12
SIR/L 20 S16	1.200	1.250	1.400	-	.760	1.000	-	10.000	-		T336	-	2.98	IGI050	IZ12
SIR/L 20 S22	1.200	1.250	1.450	-	.850	1.000	-	10.000	-		T336	-	2.98	IGI055	IZ13
SIR/L 20 S22-2**	1.200	1.250	1.000	.950	.650	1.000	-	10.000	3.000	2	✓	2.43	IGI055	IZ14	
SIR/L 24 T22	1.250	1.500	1.750	-	.950	1.450	-	12.000	-		T336	-	5.18	IGI055	IZ13

\*\* With internal coolant

IGI046	TN 11NL..	TN 11NR..
IGI050	TN 16NL..	TN 16NR..
IGI055	TN 22NL..	TN 22NR..

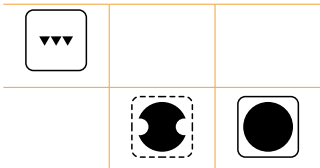
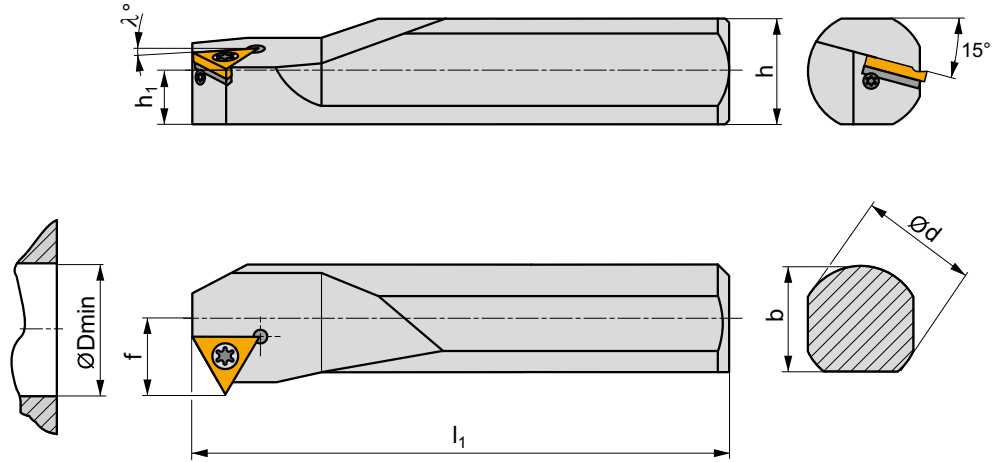
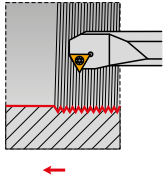
IZ9	US 3510A-T15P	3.0	M3.5	.42	-	-	FLAG T15P	-	P-16
IZ10	US 3510A-T15P	3.0	M3.5	.42	-	-	FLAG T15P	-	-
IZ11	US 2506-T07P	.9	M2.5	.25	-	-	FLAG T07P	-	-
IZ12	US 3512A-T15P	3.0	M3.5	.50	-	HS 0304	FLAG T15P	HXK 2.5	
IZ13	US 4514A-T20	5.0	M4.5	.55	SP 0405	-	FLAG T20	-	
IZ14	US 4514A-T20	5.0	M4.5	.55	-	-	FLAG T20	-	-

# SI(RL)-S

P M K N S H

S

T157-T180



ANSI	b	d	D <sub>min</sub>	f	h	h <sub>1</sub>	l <sub>1</sub>	λ°	lbs		
SIR/L-S 20 S22	1.200	1.250	1.550	.880	1.000	-	10.000	T334	2.87	IGI056	IZ13
SIR/L-S 24 T22	1.250	1.500	1.800	1.020	1.450	-	12.000	T334	5.07	IGI056	IZ13

IGI056	TN 22NN..

IZ13	US 4514A-T20	5.0	M4.5	.55	SP 0405	FLAG T20	T334

**TECHNICAL  
INFORMATION**

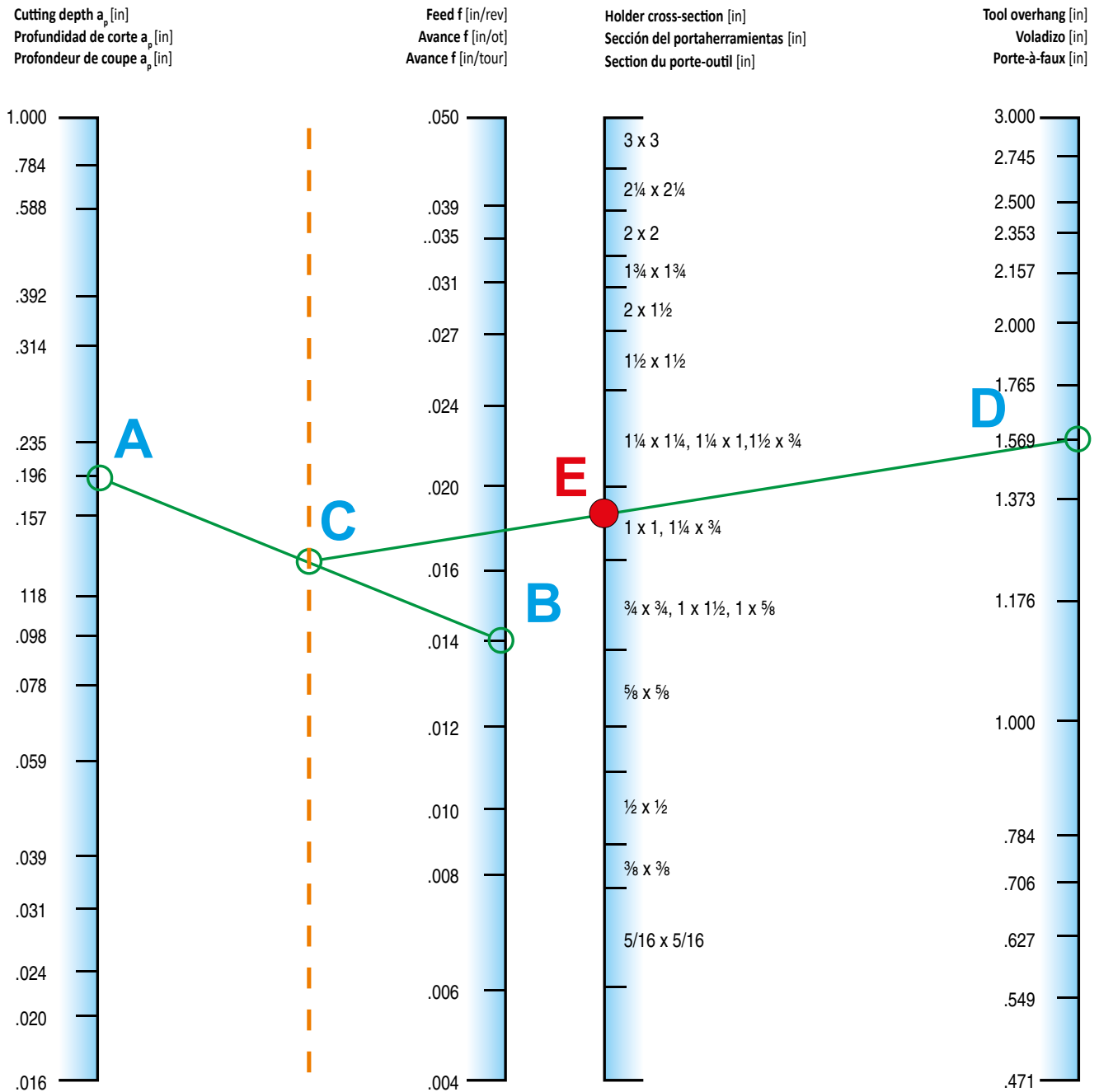
**INFORMACIÓN  
TÉCNICA**

**PARTIE  
TECHNIQUE**

	📖		📖
CHOICE OF CUTTING TOOL SELECCIÓN DE LA HERRAMIENTA DE CORTE CHOIX DE L'OUTIL COUPANT	T255	CERAMICS AND THEIR PRACTICAL APPLICATION CERÁMICAS DE CORTE Y SU APLICACIÓN PRÁCTICA CÉRAMIQUES DE COUPE ET LEURS APPLICATIONS PRATIQUES	T320
GEOMETRY OF CUTTING INSERT - TURNING GEOMETRÍA DE LAS PLAQUITAS - TORNEADO GÉOMÉTRIE DES PLAQUETTES - TOURNAGE	T262	SURFACE QUALITY CALIDAD SUPERFICIAL QUALITÉ DE SURFACE	T324
OVERVIEW OF TURNING INSERTS' GEOMETRIES GEOMETRÍAS DE PLAQUITAS DE TORNEADO GÉOMÉTRIE DES PLAQUETTES - TOURNAGE	T274	WORKING AND CONSTRUCTION ANGLES OF TURNING TOOLS ÁNGULOS DE TRABAJO Y CONSTRUCTIVO DE LA HERRAMIENTA DE TORNEADO ANGLES DE TRAVAIL ET DE CONSTRUCTION DES OUTILS DE TOURNAGE	T327
GEOMETRY OF CUTTING INSERTS - CLAMPING DESIGNATION ISO P, M, D GEOMETRÍA DE PLAQUITAS DE CORTE - TIPO DE FIJACIÓN ISO P, M, D GÉOMÉTRIE DES PLAQUETTES - FIXATION DE TYPE ISO P, M, D	T275	CORRECTION OF X AND Z COORDINATES BY RADIUS AND HOLDER CORRECCIÓN EN COORDENADAS X Y Z SEGÚN EL RADIO Y EL PORTAHERRAMIENTAS CHANGEMENT DE TAILLE (CORRECTION) SUIVANT LE RAYON UTILISÉ	T330
GEOMETRY OF CUTTING INSERTS - CLAMPING DESIGNATION ISO S GEOMETRÍA DE PLAQUITAS DE CORTE - TIPO DE FIJACIÓN ISO S GÉOMÉTRIE DES PLAQUETTES - FIXATION DE TYPE ISO S	T285	THREADING ROSCADO FILETAGE	T334
GEOMETRY OF CUTTING INSERTS - CLAMPING DESIGNATION ISO C GEOMETRÍA DE PLAQUITAS DE CORTE - TIPO DE FIJACIÓN ISO C GÉOMÉTRIE DES PLAQUETTES - FIXATION DE TYPE ISO C	T291	INFEEED DEPTH PROFUNDIDAD DE AVANCE PROFONDEUR DE PÉNÉTRATION	T340
GEOMETRY OF CUTTING INSERTS - CLAMPING DESIGNATION ISO X AND G GEOMETRÍA DE PLAQUITAS DE CORTE - TIPO DE FIJACIÓN ISO X Y G GÉOMÉTRIE DES PLAQUETTES - FIXATION DE TYPE ISO X ET G	T293	RECESSES, PARTING AND COPY TURNING RANURADO, TRONZADO Y TORNEADO EN COPIA TOURNAGE D'ÉVIDEMENTS, TRONÇONNAGE ET COPIAGE	T347
TURNING GRADES CALIDADES PARA TORNEADO NUANCE DE TOURNAGE	T296	TURNING OF SLENDER SHAFTS AND INTERNAL TURNING (BORING) OF DEEP HOLES TORNEADO DE EJES DELGADOS Y TORNEADO INTERIOR (MANDRINADO) DE AGUJEROS PROFUNDOS TOURNAGE D'ÉVIDEMENTS, TRONÇONNAGE ET GORGES	T350
WORKPIECE MATERIALS - CLASSIFICATION CLASIFICACIÓN DE MATERIALES MECANIZADOS	T300	TYPES OF WEAR ON TURNING INSERTS TIPOS DE DESGASTE DE LAS PLAQUITAS DE TORNEADO TYPES D'USURE DES PLAQUETTES DE TOURNAGE	T352
CLASSIFICATION DES GROUPES DE MATÉRIAUX À USINER	T301	TROUBLESHOOTING SOLUCIÓN DE PROBLEMAS PHÉNOMÈNES INDÉSIRABLES	T357
RECOMMENDATIONS FOR FINDING SUITABLE CHIP BREAKER - GRADE COMBINATION RECOMENDACIONES PARA ENCONTRAR LA COMBINACIÓN ROMPEVIRUTAS - CALIDAD ADECUADA RECOMMANDATIONS POUR TROUVER LA BONNE COMBINAISON GÉOMÉTRIE - NUANCE	T302	GENERAL PRINCIPLES PRINCIPIOS GENERALES PRINCIPES GÉNÉRAUX	T361
VERIFYING THE CHOICE OF CHIP BREAKER AND CUTTING GRADE VERIFICAR LA ELECCIÓN DE ROMPEVIRUTAS Y CALIDAD VÉRIFICATION DE LA GÉOMÉTRIE ET DE LA NUANCE DE COUPE	T303	FORMULA FOR CALCULATING CUTTING DATA FÓRMULAS PARA EL CÁLCULO DE LOS PARÁMETROS DE CORTE	T362
RECOMMENDATIONS FOR DETERMINING STARTING CUTTING CONDITIONS RECOMENDACIONES PARA DETERMINAR LAS CONDICIONES DE CORTE INICIALES RECOMMANDATIONS POUR TROUVER LES CONDITIONS DE COUPE DE DÉPART	T305	FORMULES DE CALCUL DES PARAMÈTRES DE COUPE	T363
CHOICE OF INITIAL CUTTING CONDITIONS SELECCIÓN DE CONDICIONES DE CORTE INICIALES CHOIX DES CONDITIONS DE COUPE INTIALES	T309,	RECOMMENDED SCREW TORQUES TORNILLOS DE FIJACIÓN	T364
	T311,	COUPLES DE SERRAGE RECOMMANDÉS	
	T313,	COMPLETE CLAMP SET JUEGO COMPLETO DE FIJACIÓN	T366
	T315,	SET DE BRIDE COMPLET	
	T317, T319		
CHOICE OF INSERT ELECCIÓN DE PLAQUITA CHOIX DE LA PLAQUETTE	T308,	TECHNICAL INFORMATION ON INSERT BOX	T367
	T310,	INFORMACIÓN TÉCNICA IMPRESA EN LA CAJA DE PLAQUITAS	T368
	T312,		
	T314, T316, T318	INFORMATIONS FIGURANT SUR LES BOITES DE PLAQUETTES	T369

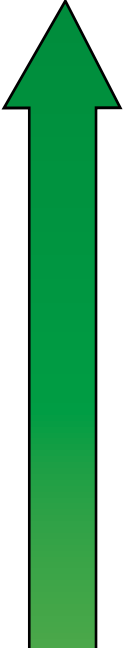





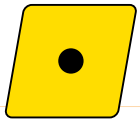
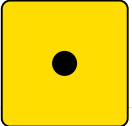
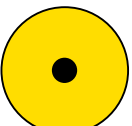
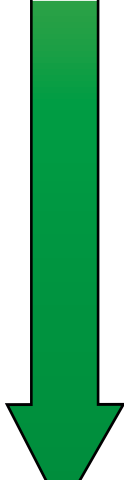
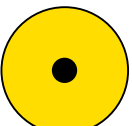
Choosing the cross-section of the tool holder  
Selección de la sección transversal del portaherramientas  
Choix de la section du porte-outil

Picture / Imagen / Image 1



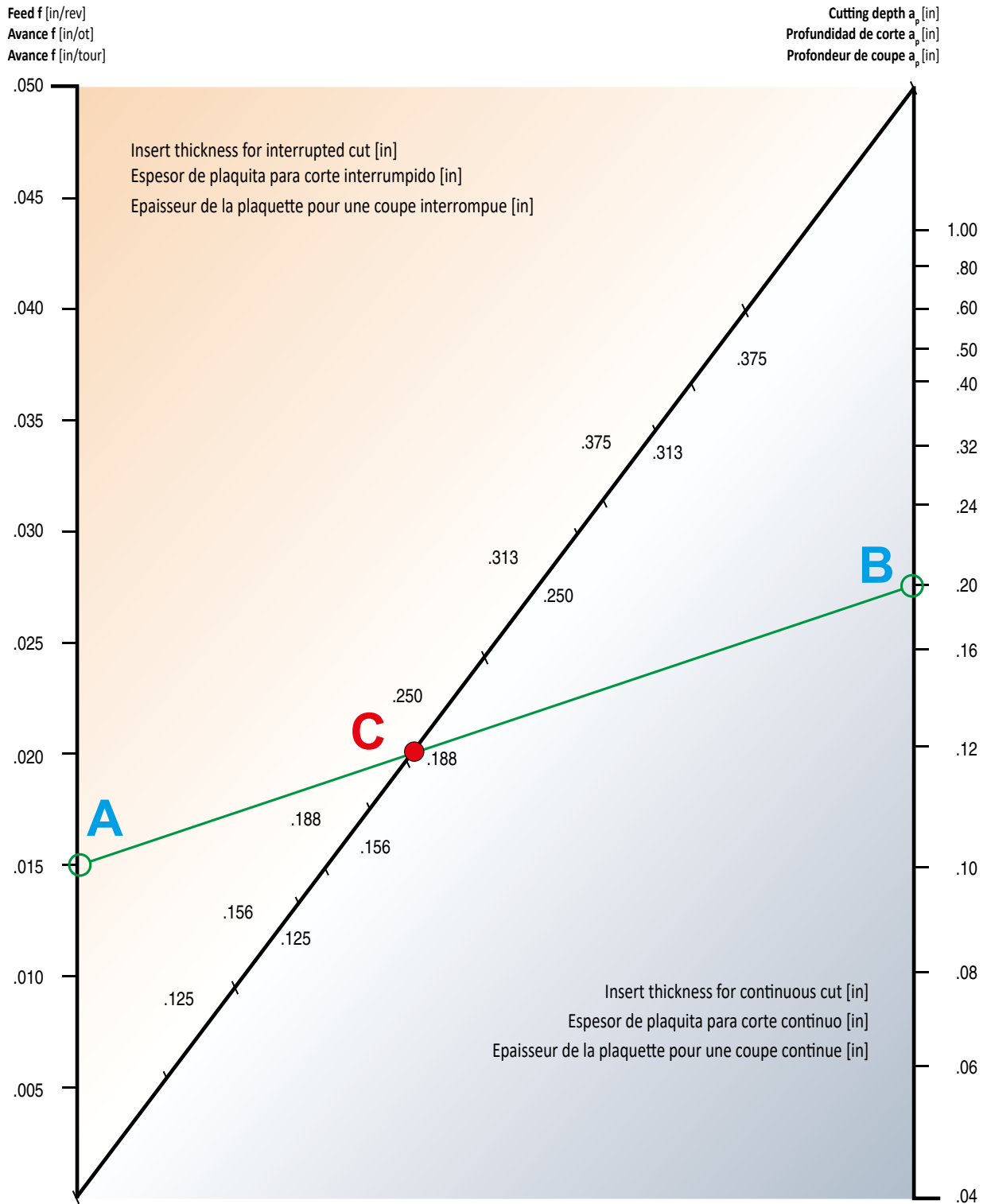
Choosing the shape and size of the insert  
Selección de la forma y el tamaño de la plaqueta de corte  
Choix de la forme et de la dimension de la plaquette

Table / Tabla / Tableau 1

Priority of choice Prioridad de selección Priorité de choix	Insert shape Forma de la plaqueta Forme de plaquette	Insert size Tamaño de la plaqueta Taille de plaquette	Maximum length of cutting edge $L_{max}$ [in] Longitud máxima del filo en corte $L_{max}$ [in] Longueur maximum de l'arête de coupe $L_{max}$ [in]	Length Longitud Longueur	
 <p>Increasing the accessibility of the cutting edge for profiling and fewer vibrations. Mayor accesibilidad del filo de corte para perfilado y menos vibraciones. Adapter l'arête de coupe à certaines formes de pièces et diminuer les vibrations.</p>		V	1/4"	25% of length	.110
		V	3/8"	25% of length	.165
		D	1/4"	25% of length	.079
		D	3/8"		.114
		D	1/2"		.154
		K	3/8"	25% of length	.185
		T	1/4"	33% of length	.142
			3/8"		.217
			1/2"		.287
			5/8"		.358
		W	3/8"	50% of length	.130
			1/2"		.173
		C	1/4"	66% of length	.165
			3/8"		.252
			1/2"		.335
			5/8"		.417
			3/4"		.500
		S	1"	66% of length	.650
			3/8"		.248
			1/2"		.331
5/8"			.409		
	R	3/4"	40% of length	.496	
		1"		.661	
		1.1/4"		.984	
		6mm		.094	
		8mm		.126	
		10mm		.157	
		12mm		.189	
15mm	.236				
 <p>Increasing the strength of the cutting edge and suitability for interrupted cut. Mayor resistencia del filo de corte e idoneidad para cortes interrumpidos. Augmenter la robustesse de l'arête de coupe et la rendre capable de travailler en coupe interrompue.</p>		16mm	.252		
		19mm	.299		
		20mm	.315		
		25mm	.394		
		32mm	.504		

**Choosing the optimum thickness of the insert**  
**Selección del espesor máximo de la plaquita de corte intercambiable**  
**Choix de l'épaisseur optimale de la plaquette de coupe indexable**

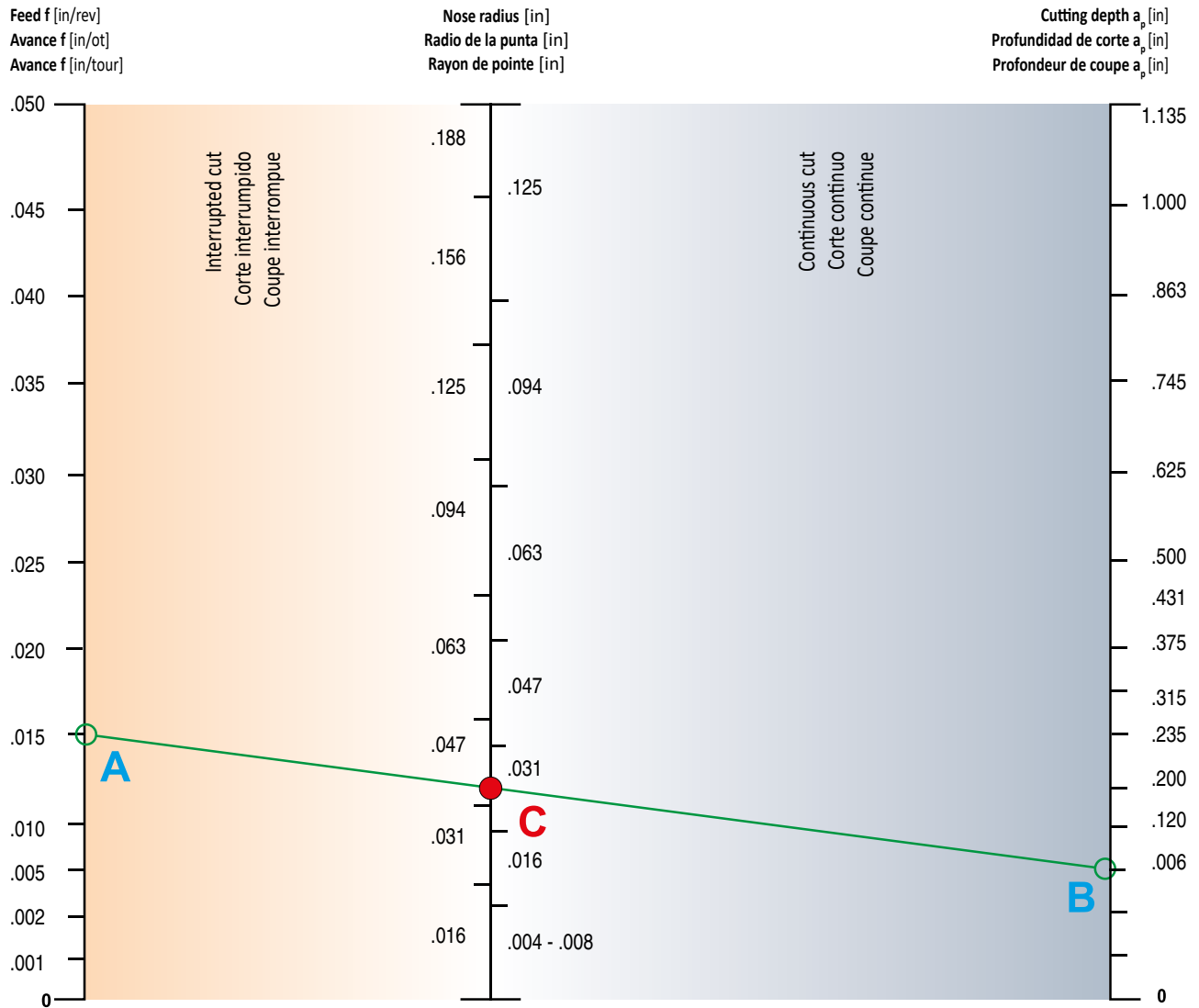
Picture / Imagen / Image 2





**Choosing the nose radius of the insert**  
**Selección del radio de la punta de la plaquita de corte intercambiable**  
**Le choix du rayon de pointe d'une plaquette de coupe**

Picture / Imagen / Image 3



#### Choosing the chip breaker

The shape of the chip depends on several factors – the properties of the machined component, material strength, toughness and microstructure, properties of the insert grade, especially the frictional properties (on the rake face), geometry of cutting edge, cutting conditions and the type of chip breaker, also static and dynamic properties of the machine.

Virtually all of these factors in the cutting process work to combine and determine the shape of the chip (shearing action, flow of the chip, or curled chip – which can gather and clog the machining area). Each chip breaker works in a defined range of feed and depth of cut. The minimum feed at which the chip breaker functions depends on the width of Top Land „x“ and its angle. The maximum feed depends on the distance from the cutting edge to the end of the chip breaker b and the depth of the chip breaker h.

#### Choix de la géométrie

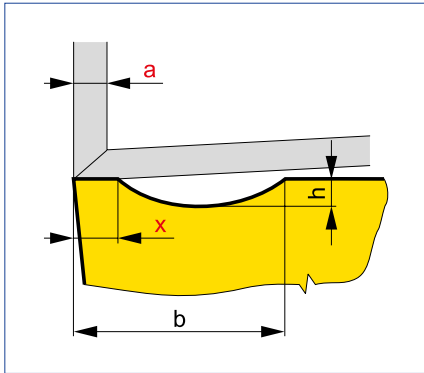
La forme du copeau dépend de plusieurs facteurs – des propriétés du matériau usiné, de la résistance du matériau, de sa tenacité et de sa microstructure, des propriétés du matériau de coupe, spécialement des propriétés de frottement (sur la face de dépouille), des propriétés statique et dynamique de la machine, du lubrifiant, de la géométrie de l'arête de coupe, des conditions de coupe et du type du brise-copeaux. Tous ces facteurs se combinent dans le processus de coupe et déterminent la forme du copeau (son cisaillement, son écoulement, ou son écrasement – qui peut remplir l'espace de travail de la zone usinée).

Chaque brise-copeaux travaille (se fractionne) seulement dans une plage définie d'avances et de profondeurs de coupe. L'avance minimum à laquelle le brise-copeaux fonctionne dépend de la largeur du listel „x“ et de son angle  $\gamma_x$ . L'avance maximum, quand le brise-copeaux agit encore, dépend de la distance „b“ du segment de l'arête de coupe et de la profondeur „h“ de la forme creuse du brise-copeaux.

#### Selección del rompevirutas:

La forma de la viruta depende de varios factores: propiedades del material mecanizado, resistencia, dureza y microestructura del material mecanizado, propiedades de la calidad de corte, especialmente las propiedades de rozamiento (en la cara de desprendimiento), propiedades estáticas y dinámicas de la máquina, refrigerante, geometría del filo de corte, condiciones de corte y el tipo de rompevirutas. Todos estos factores del proceso de corte se combinan para determinar la forma de las virutas (acción de cizallamiento, flujo de la viruta o rizado de la viruta), que pueden acumularse en el espacio de trabajo de la zona de mecanizado. Cada rompevirutas funciona (rompe la viruta) solo en un rango determinado de avance y profundidad de corte. El avance mínimo al que funciona el rompevirutas depende de la anchura de la faceta superior „x“ y su ángulo  $\gamma_x$ . El avance máximo al que sigue funcionando el rompevirutas depende de la distancia desde la salida del filo de corte b y la profundidad de la ranura h del rompevirutas.

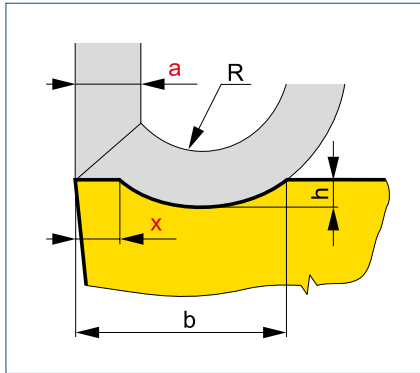
Picture / Imagen / Image 4



If the thickness of layer „a“ cut away (at setting angle  $\kappa_r = 90^\circ$ , equal to the feed) is significantly smaller than the T-land „x“, the chip is only in contact with the chamfer. It cannot enter the chip breaker and therefore it cannot be broken (see picture).

La capa „a“ muestra la profundidad de corte, y si esta es más pequeño que la anchura de la faceta superior „x“ (a un ángulo de posicionamiento  $\kappa_r = 90^\circ$  igual al avance), la viruta no puede alcanzar la cara de formación de virutas de la plaquita. Por lo tanto, la viruta no se romperá (consulte el diagrama de arriba).

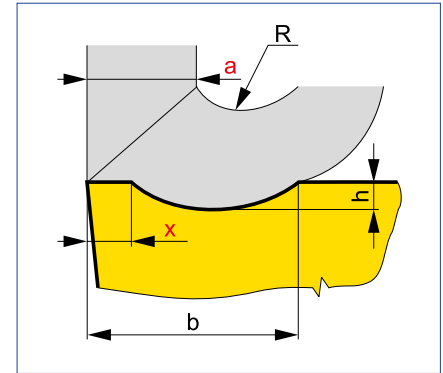
La couche „a“ représente la profondeur de coupe qui, si elle est plus petite que la largeur du listel „x“ (avec un angle d'attaque  $\kappa_r = 90^\circ$  égal à l'avance), alors le copeau ne peut pas atteindre la partie creuse du brise-copeau de la plaquette. Par conséquent le copeau ne sera pas fractionné (voir schéma ci-dessus).



If the feed „f“ is greater (thickness greater than the depth of „a“ and  $x < a$  (f)), the chip enters the chip breaker and is curved at specific values of radius R (see picture).

Cuando se aplica la velocidad de avance correcta (se está cortando una sección transversal de viruta mayor), y por lo tanto  $x < a$  (f), la viruta que se está evacuando entra en el rompevirutas y se perfila y se rompe mediante la formación del radio R (consulte el diagrama de arriba).

Quand la gaine de valeurs d'avance est correctement appliquée, (une plus large section de copeau est coupée), et donc  $x < a$  (f), le copeau est contraint à l'entrée du brise-copeaux puis s'enroule et se fractionne par sa forme de rayon R (voir le schéma au dessus).



If  $x \ll a$  (see picture) the chip is excessively deformed (chip is crushed). If the chip misses the chip breaker it will not be broken.

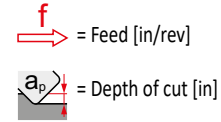
Si la sección transversal de la viruta „a“ es significativamente mayor que la faceta superior de la plaqueta „x“, la rotura de virutas será demasiado dura y el resultado serán virutas „demasiado rotas“ o „trituradas“. Tenga en cuenta el ajuste del radio „R“. Si se aumenta más la velocidad de avance, la viruta no llegará a la zona de formación de virutas de la plaqueta. (consulte el diagrama de arriba).

Si la section du copeau „a“ est trop supérieure à la largeur du listel „x“ de la plaquette, alors le fractionnement sera trop difficile et le copeau sera déformé ou écrasé. Noter que le rayon „R“ est très resserré. Si l'avance est encore augmentée le copeau passera au-dessus de la géométrie brise-copeaux et ne sera pas fractionné. (voir schéma ci-dessus).

All chip breakers work in a defined range of cutting conditions. This is why the chip breaking area is shown as a continuous range in order to define the most commonly used depth of cut and feed combinations (see following picture). The chip breaker application ranges also overlap.

Todos los rompevirutas funcionan en un rango de condiciones de corte definido. Por este motivo, la zona de rotura de virutas se muestra como un rango continuo, lo que permite definir las combinaciones de profundidad de corte y avance que se utilizan con más frecuencia (consulte el esquema siguiente). Además, los rangos de aplicación de los rompevirutas se superponen.

Toutes les géométries fonctionnent pour une plage de conditions de coupe définies. Pour cette raison, le domaine de fractionnement des copeaux se présente coine une plage continue, qui autorise par définition les avances ( $f$ ) et les profondeurs de coupe «  $a_p$  » les plus utilisées (voir image ci-dessous). Pour cette raison, les plages d'applications des géométries se chevauchent.



Picture / Imagen / Image 5

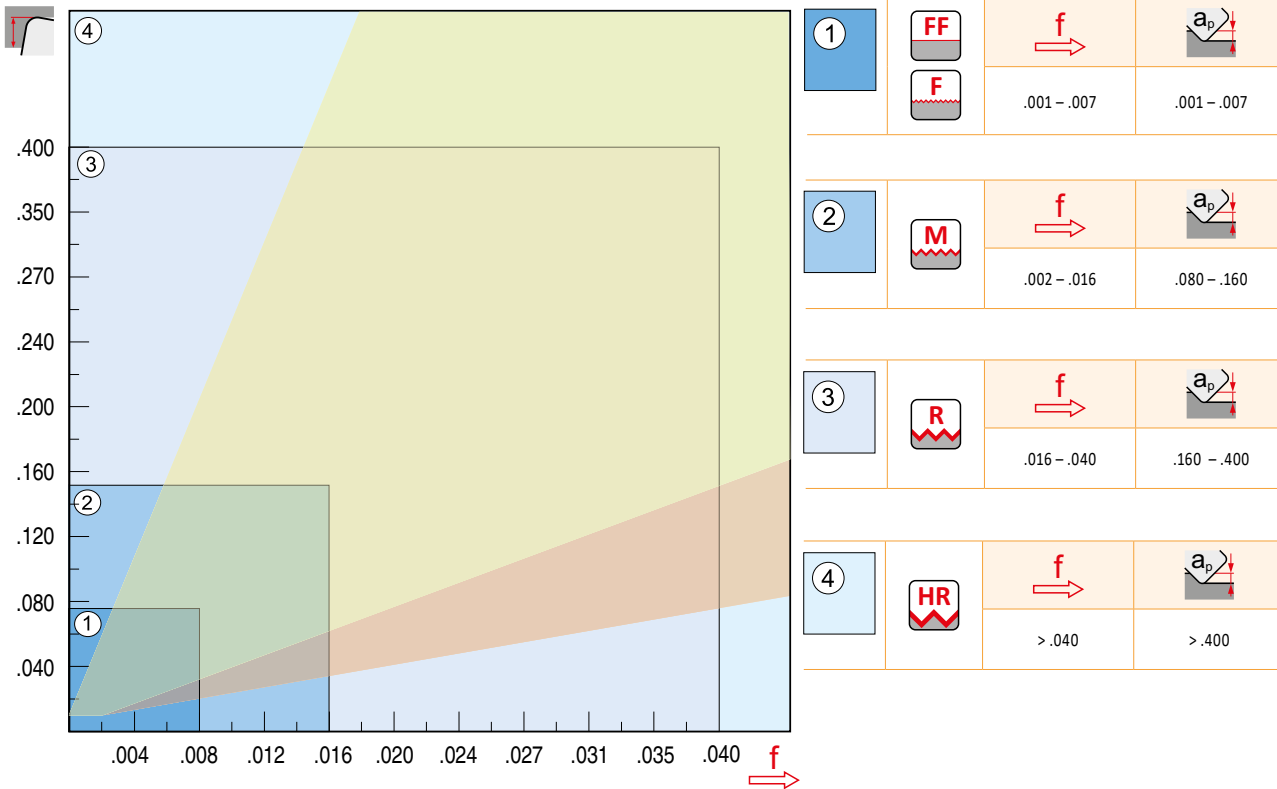


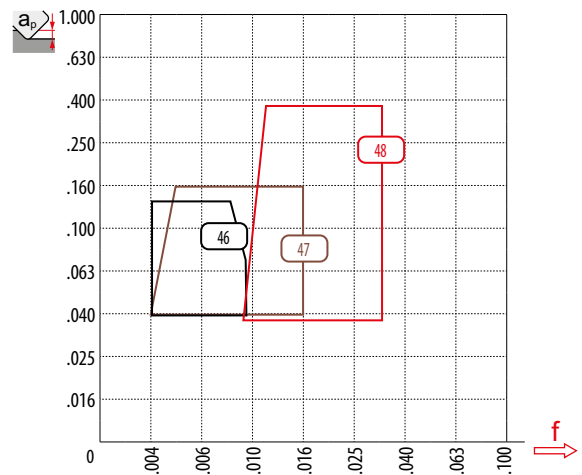
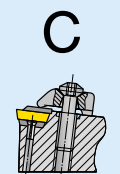
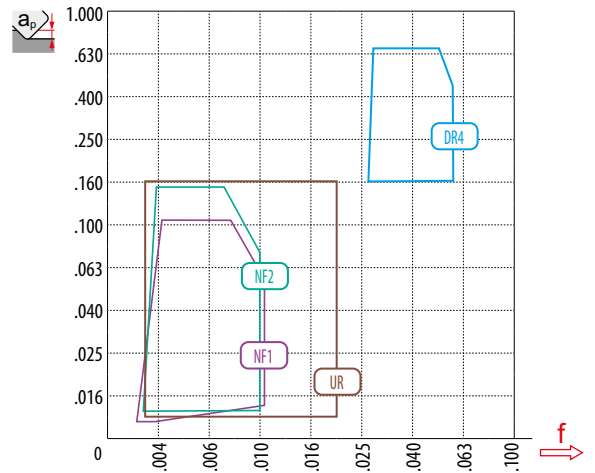
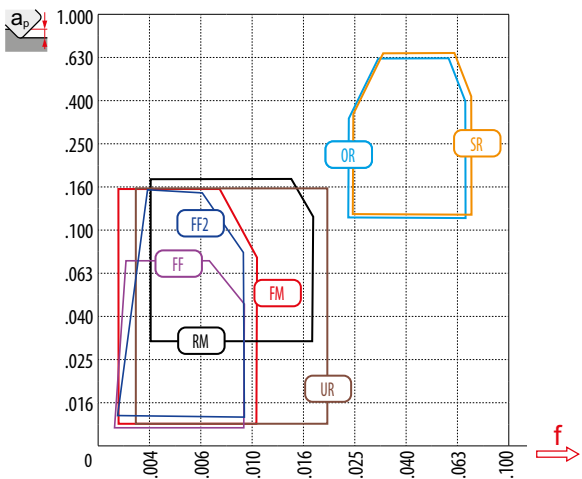
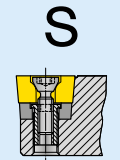
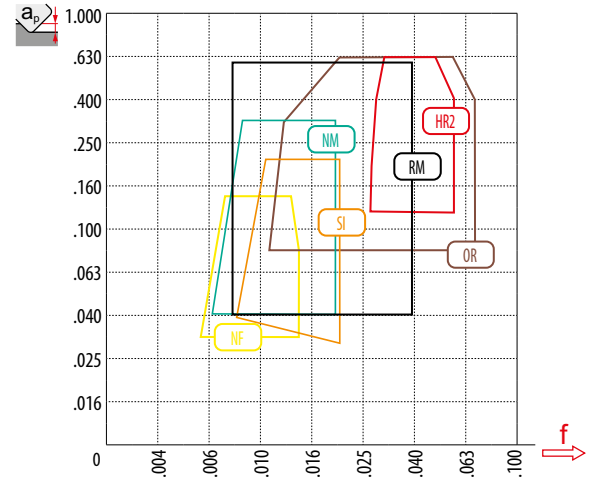
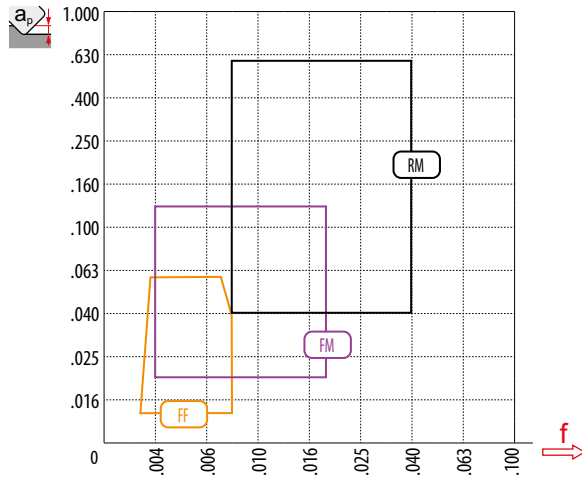
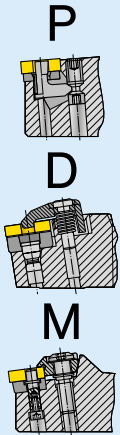
Table 2  
 Tabla 2  
 Tableau 2

GEOMETRY OF CUTTING INSERTS – TURNING  
 GEOMETRIA DE LAS PLAQUITAS – TORNEADO  
 GÉOMÉTRIE DES PLAQUETTES – TOURNAGE



Difficult working conditions  
 Malas condiciones de trabajo  
 Mauvaises conditions de travail

Specific use  
 Uso específico  
 Application spécifique



First choice  
Primera elección  
Premier choix

Low cutting resistance / tough material  
Bajas fuerzas de corte / material difícil  
Forces de coupe / Matériau résistant

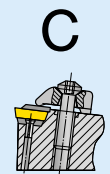
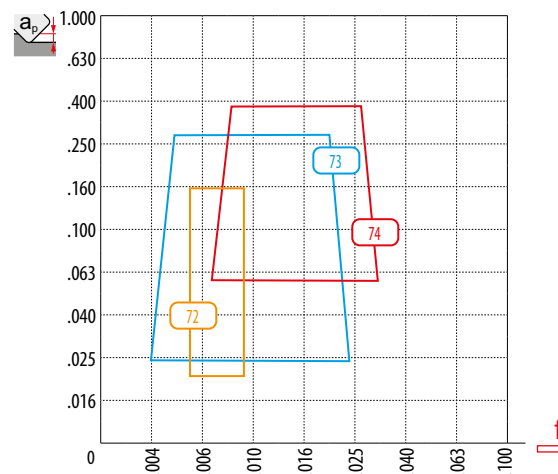
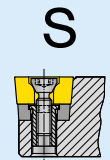
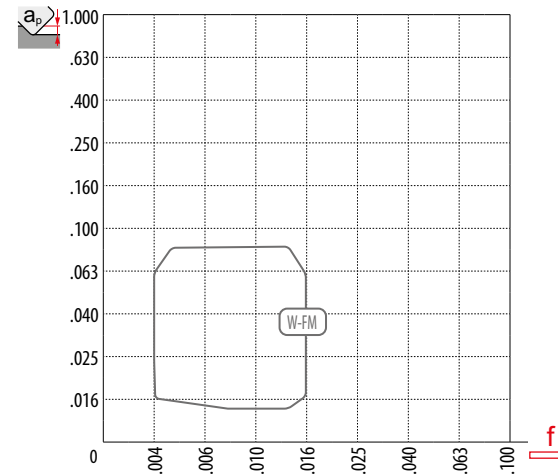
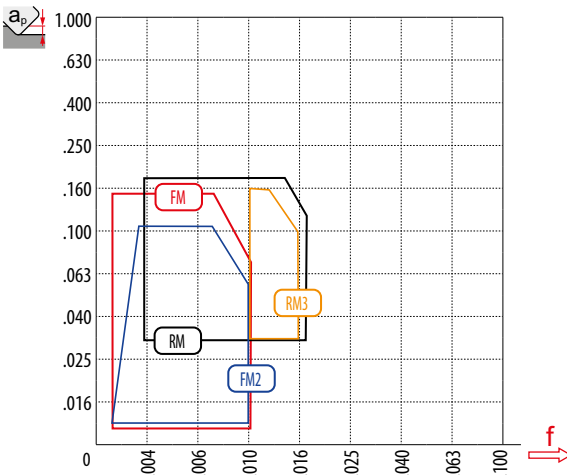
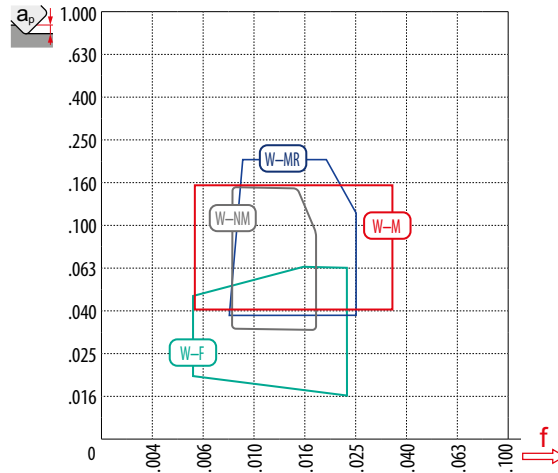
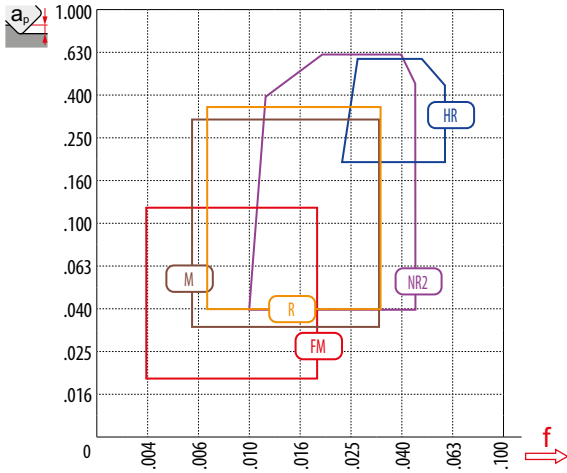


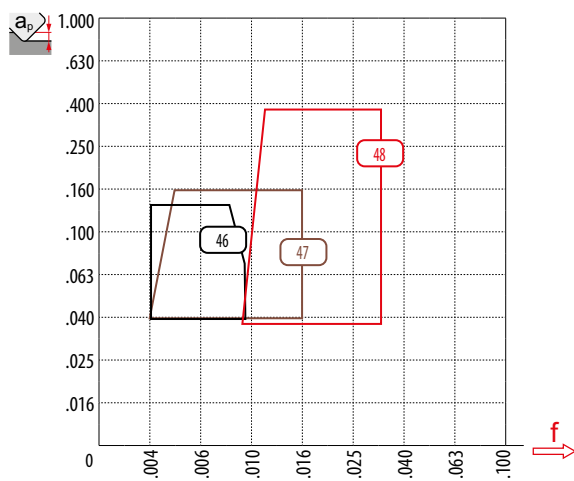
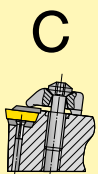
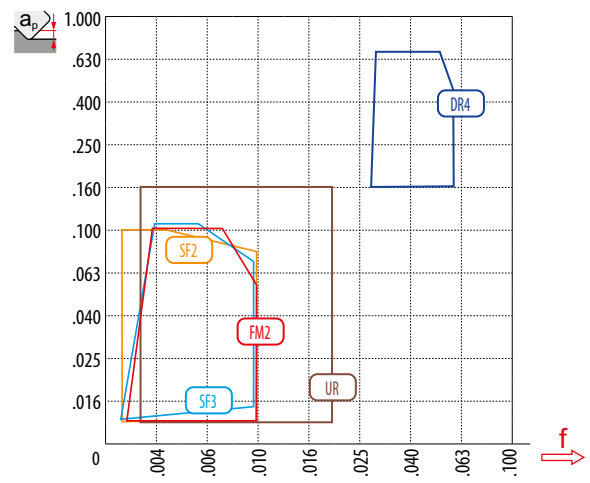
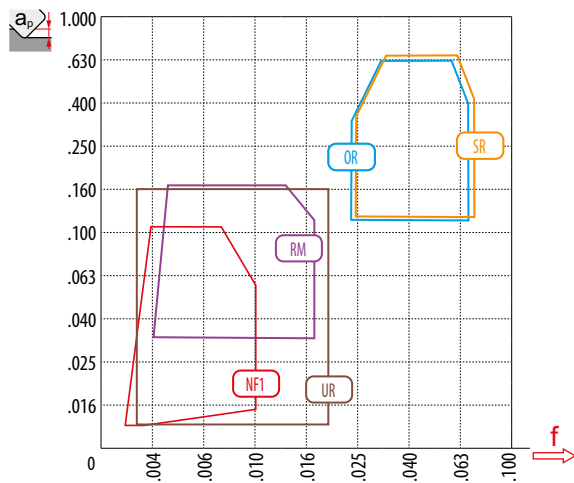
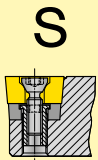
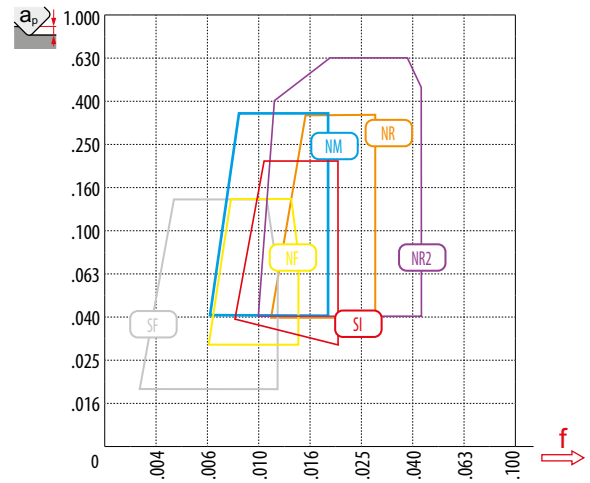
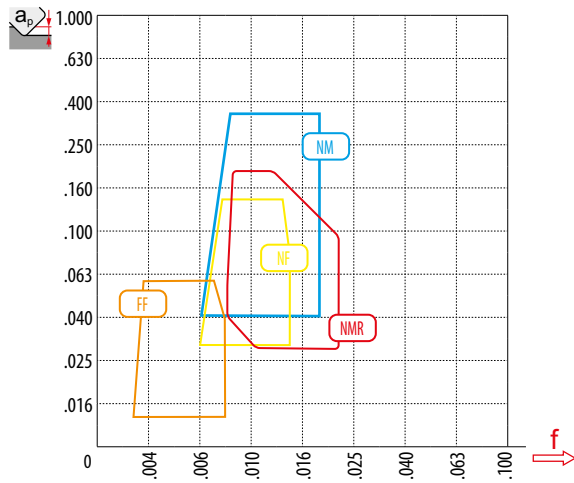
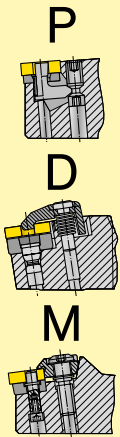
Table 2  
 Tabla 2  
 Tableau 2

GEOMETRY OF CUTTING INSERTS – TURNING  
 GEOMETRIA DE LAS PLAQUITAS – TORNEADO  
 GÉOMÉTRIE DES PLAQUETTES – TOURNAGE



Difficult working conditions  
 Malas condiciones de trabajo  
 Mauvaises conditions de travail

Specific use  
 Uso específico  
 Application spécifique





First choice  
 Primera elección  
 Premier choix

Low cutting resistance / tough material  
 Bajas fuerzas de corte / material difícil  
 Forces de coupe / Matériau résistant

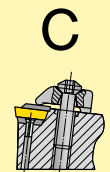
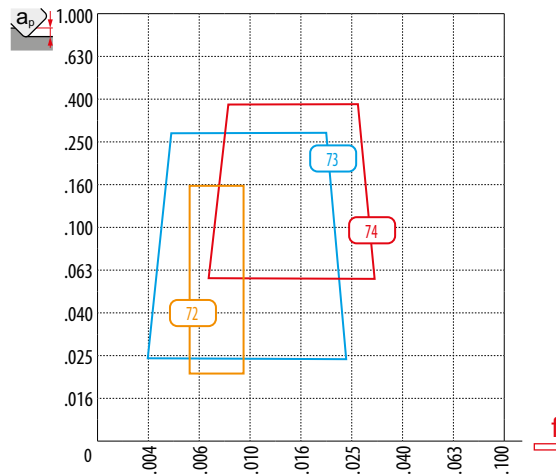
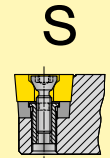
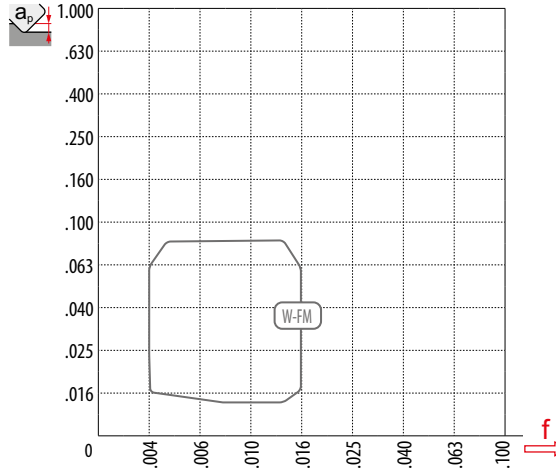
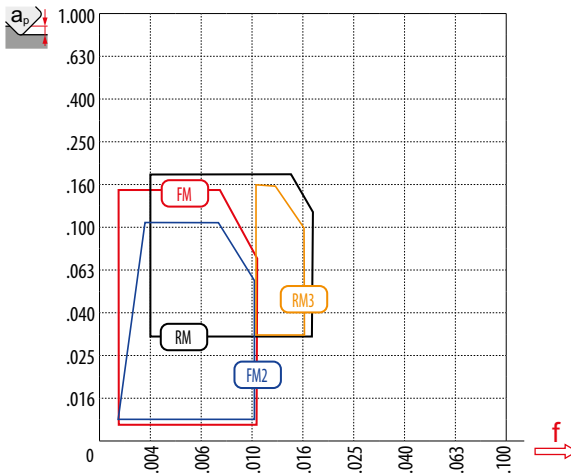
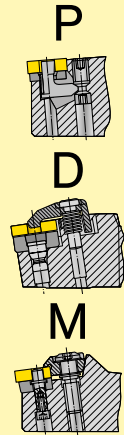
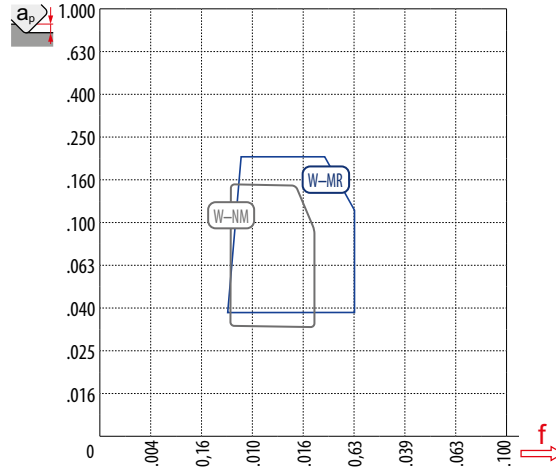
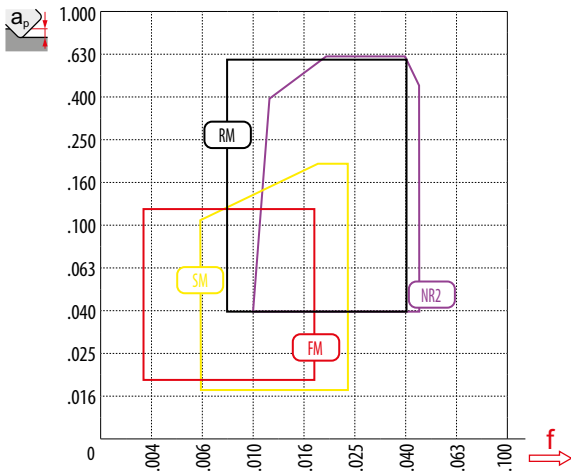




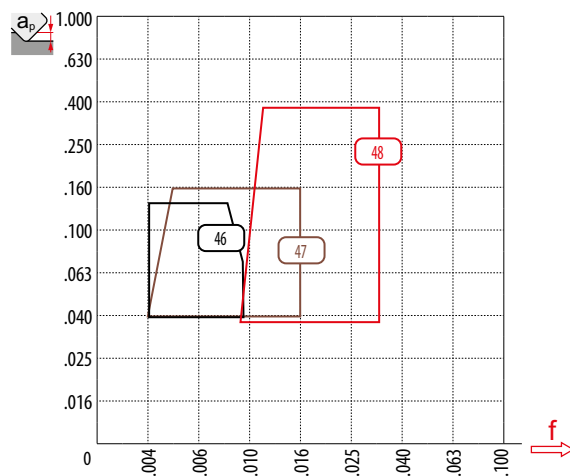
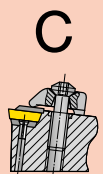
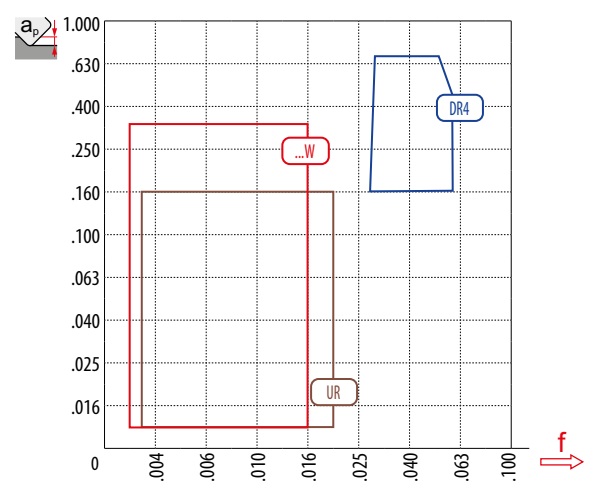
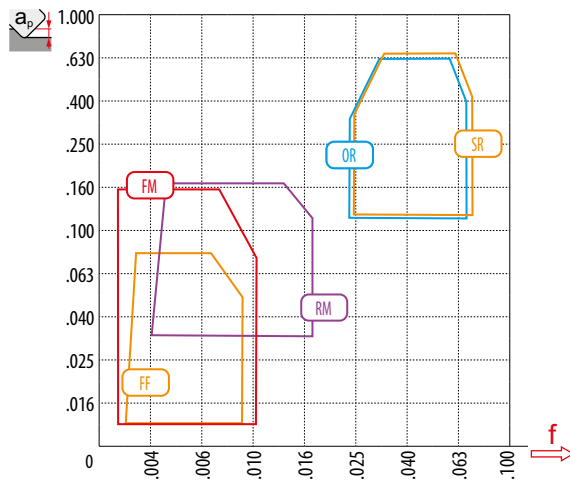
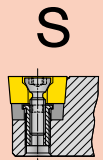
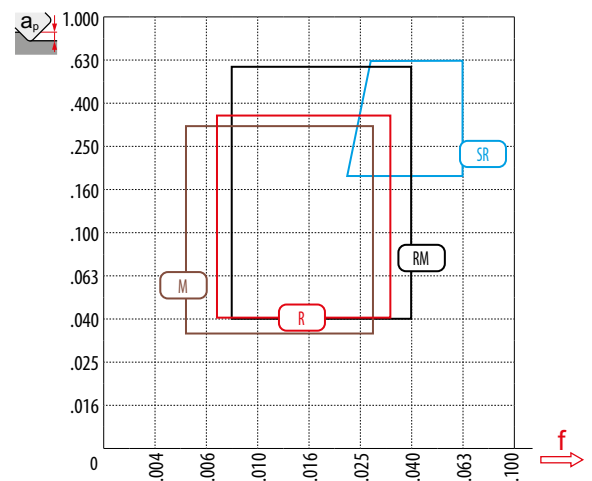
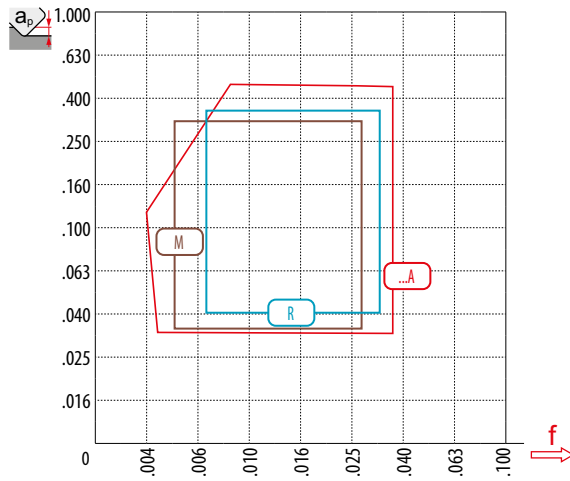
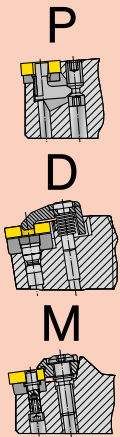
Table 2  
 Tabla 2  
 Tableau 2

GEOMETRY OF CUTTING INSERTS – TURNING  
 GEOMETRIA DE LAS PLAQUITAS – TORNEADO  
 GÉOMÉTRIE DES PLAQUETTES – TOURNAGE

**K**

Difficult working conditions  
 Malas condiciones de trabajo  
 Mauvaises conditions de travail

Specific use  
 Uso específico  
 Application spécifique





First choice  
 Primera elección  
 Premier choix

Low cutting resistance / tough material  
 Bajas fuerzas de corte / material difícil  
 Forces de coupe / Matériau résistant

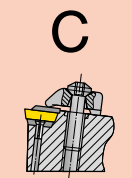
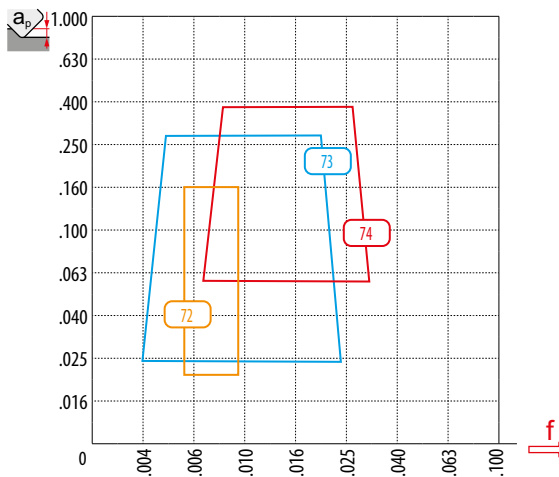
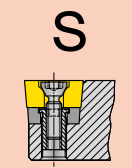
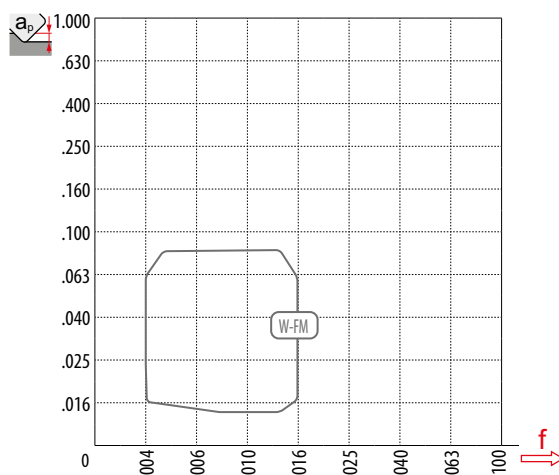
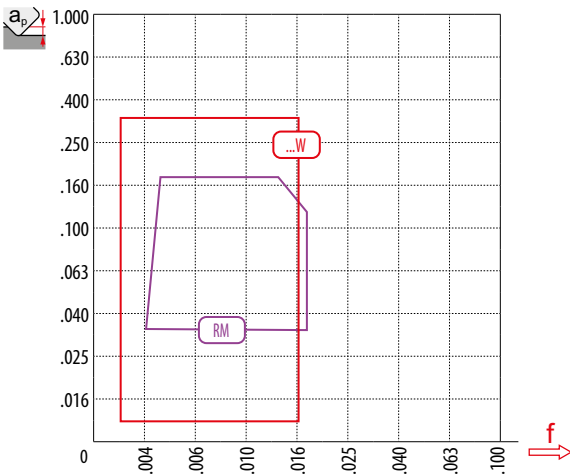
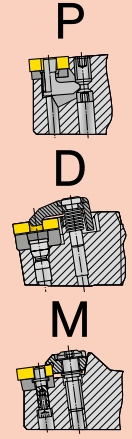
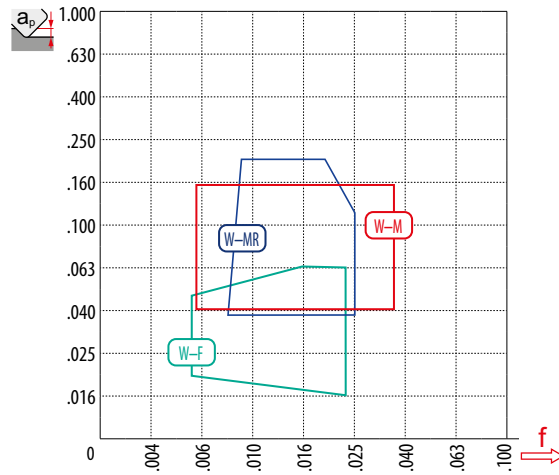
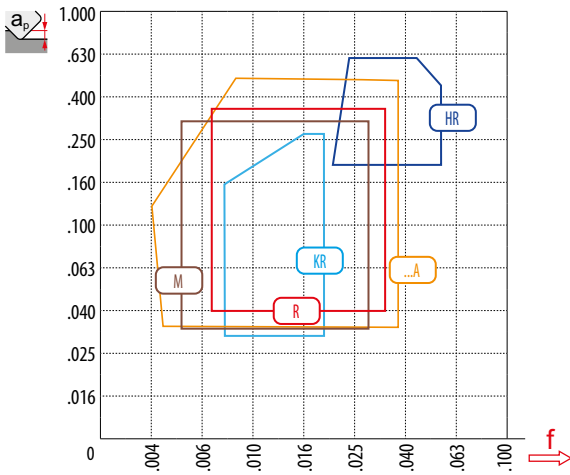


Table 2  
 Tabla 2  
 Tableau 2

**GEOMETRY OF CUTTING INSERTS – TURNING**  
**GEOMETRIA DE LAS PLAQUITAS – TORNEADO**  
**GÉOMÉTRIE DES PLAQUETTES – TOURNAGE**

**N**

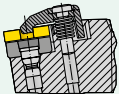
Difficult working conditions  
 Malas condiciones de trabajo  
 Mauvaises conditions de travail

Specific use  
 Uso específico  
 Application spécifique

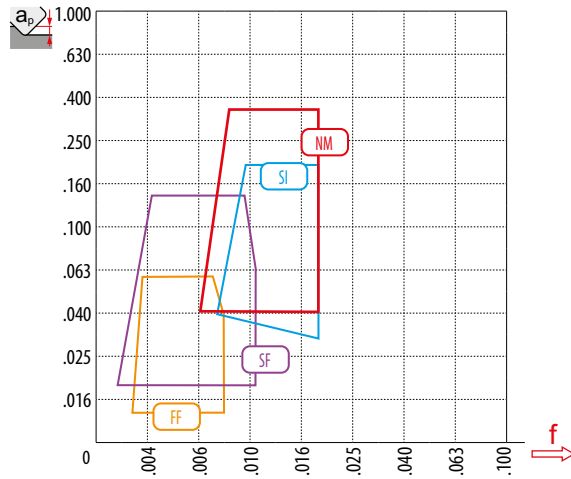
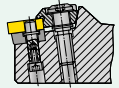
**P**



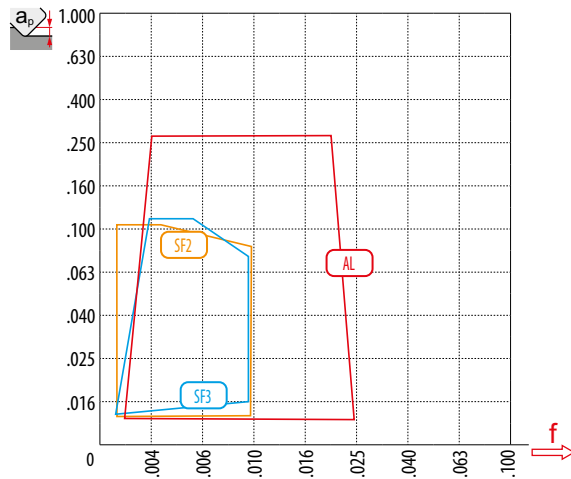
**D**



**M**



**S**



**C**

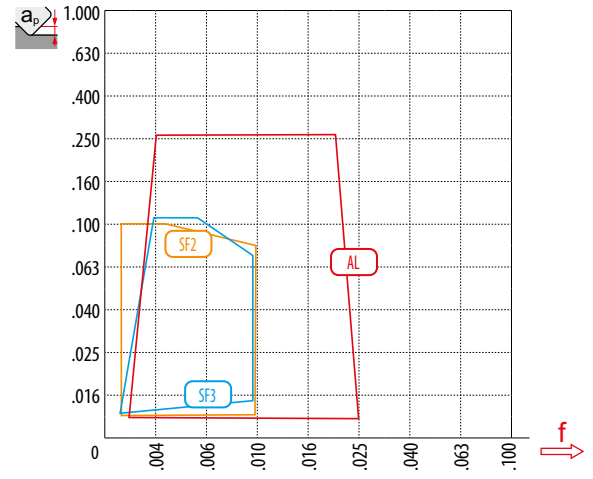




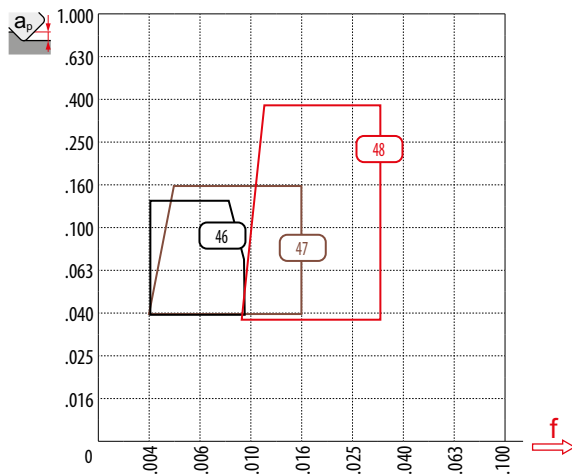
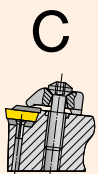
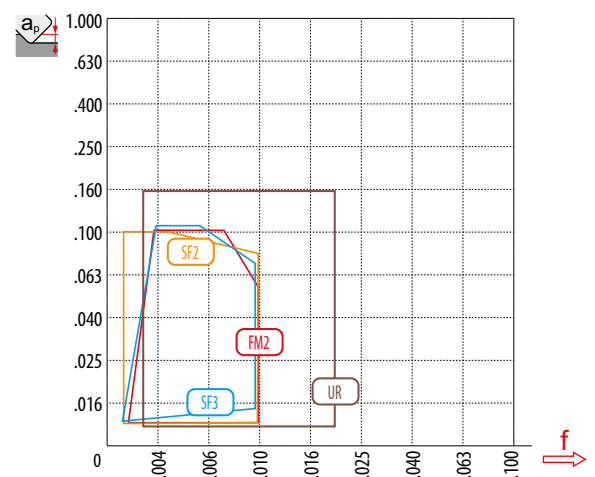
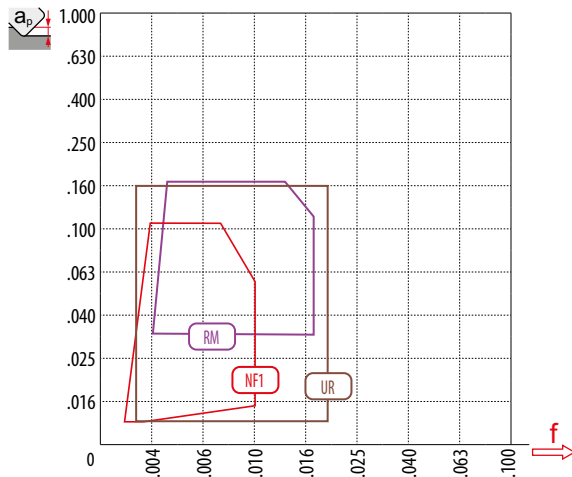
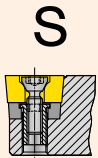
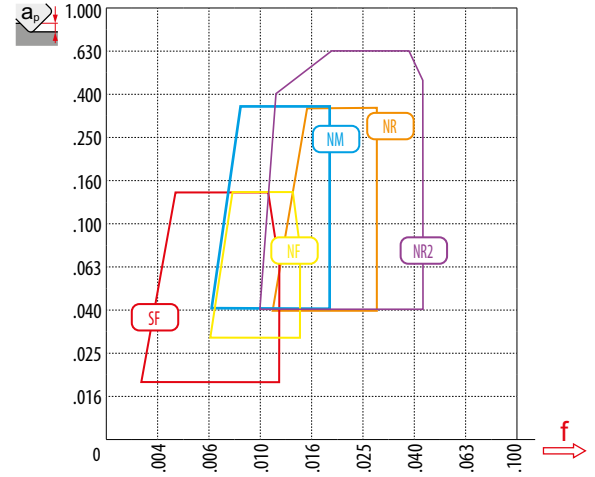
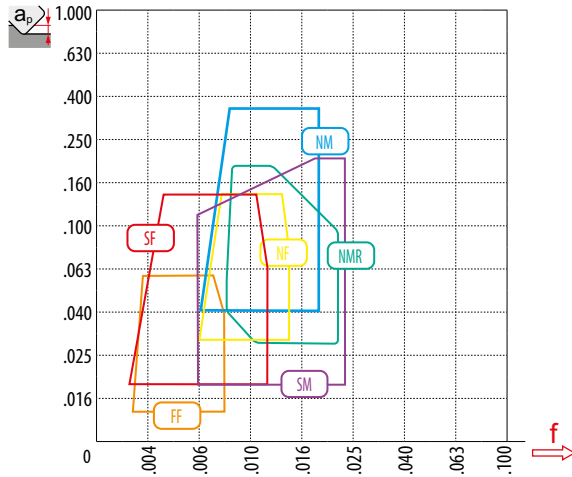
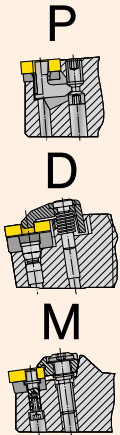
Table 2  
 Tabla 2  
 Tableau 2

GEOMETRY OF CUTTING INSERTS – TURNING  
 GEOMETRIA DE LAS PLAQUITAS – TORNEADO  
 GÉOMÉTRIE DES PLAQUETTES – TOURNAGE

**S**

Difficult working conditions  
 Malas condiciones de trabajo  
 Mauvaises conditions de travail

Specific use  
 Uso específico  
 Application spécifique



First choice  
 Primera elección  
 Premier choix

Low cutting resistance / tough material  
 Bajas fuerzas de corte / material difícil  
 Forces de coupe / Matériau résistant

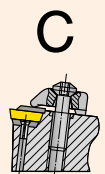
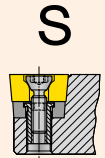
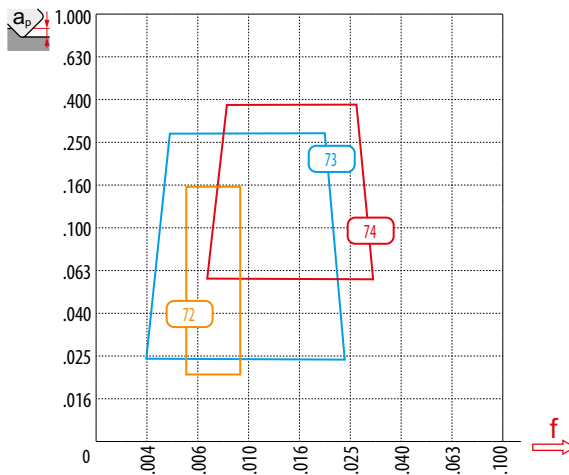
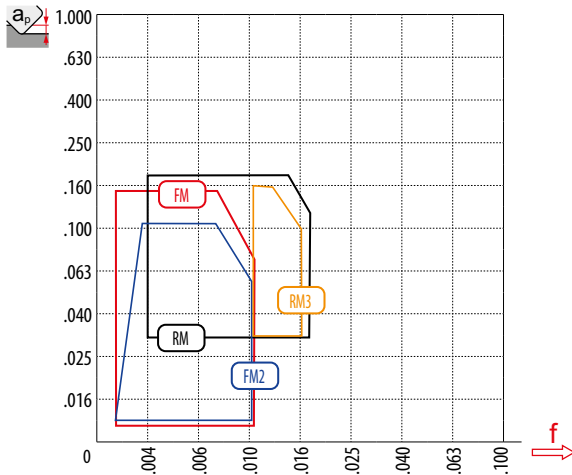
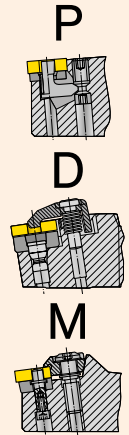
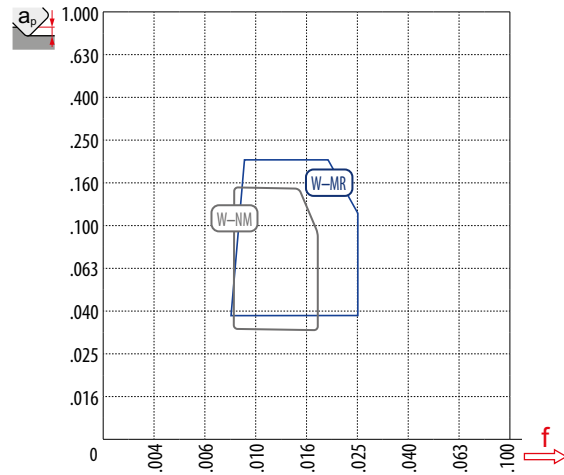
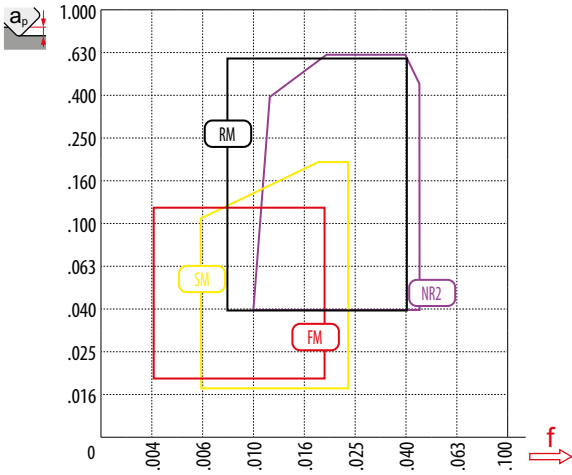


Table 2  
 Tabla 2  
 Tableau 2

GEOMETRY OF CUTTING INSERTS – TURNING  
 GEOMETRIA DE LAS PLAQUITAS – TORNEADO  
 GÉOMÉTRIE DES PLAQUETTES – TOURNAGE

**H**

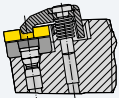
Difficult working conditions  
 Malas condiciones de trabajo  
 Mauvaises conditions de travail

Specific use  
 Uso específico  
 Application spécifique

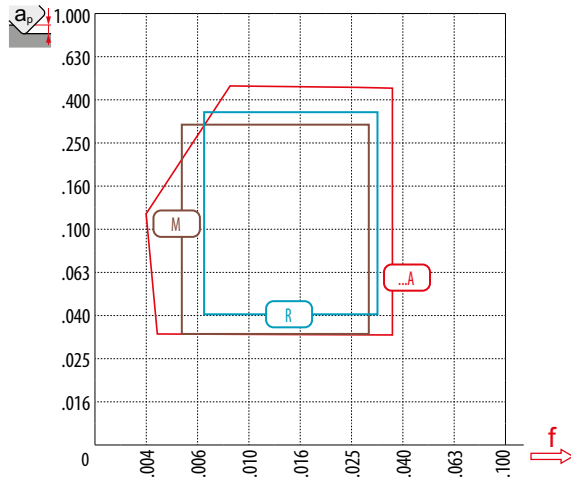
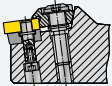
**P**



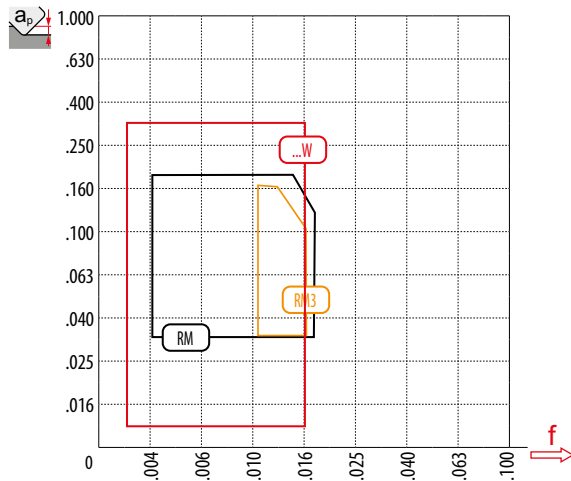
**D**



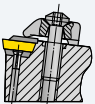
**M**



**S**



**C**







OVERVIEW OF TURNING INSERTS' GEOMETRIES  
 GEOMETRÍAS DE PLAQUITAS DE TORNEADO  
 GÉOMÉTRIE DES PLAQUETTES – TOURNAGE

Clamping designation – ISO P, M, D / Plaquetas – fijación ISO P, M, D Plaquettes - fixation ISO P, M, D	
08 (RNMG)	T272
31 (RCMX)	T272
81 (RNMG)	T272
321 (RCMX)	T272
331 (RCMX)	T273
361 (RCMX)	T273
923	T273
...A	T273
DR	T274
FF	T274
FM	T274
HR	T274
HR2	T275
KR	T275
M	T275
NF	T275
NM	T276
NMR	T276
NR	T276
NR2	T276
OR	T277
OR1	T277
R	T277
RF1 (RCMX)	T277
RM	T278
RM1 (RCMX)	T278
RM2 (RCM.)	T278
RR2 (RCM.)	T278
RR4 (RCMT)	T279
SF	T279
SI	T279
SM	T279
SR	T280
W-MR	T280
W-F	T280
W-M	T280
W-NM	T281
Clamping designation – ISO S / Plaquetas – fijación ISO S Plaquettes - fixation ISO S	
371 (RCMT)	T282
372 (RCMT)	T282
...W	T282
AL	T282

DR4 (SCMT)	T283
FF	T283
FF2	T283
FM	T283
FM (RCMT)	T284
FM2	T284
NF1	T284
NF2	T284
OR (SCMT)	T285
RF	T285
RM	T285
RM3	T285
SF2	T286
SF3	T286
SI	T286
SR (SCMT)	T286
UR (RCMT)	T287
UR	T287
W-FM	T287
W-UR	T287
Clamping designation – ISO C / Plaquetas – fijación ISO C Plaquettes - fixation ISO C	
46	T288
47	T288
48	T288
61	T288
72	T289
73	T289
74	T289
.PUN	T289
Clamping designation – ISO X, G / Plaquetas – fijación ISO X, G Plaquettes - fixation ISO X, G	
13 F (LCM.)	T290
13 MP (LCM.)	T290
16 F (LCM.)	T290
16 M (LCM.)	T290
16 MP (LCM.)	T291
20 F1 (LCMF)	T291
20 M2 (LCMF)	T291
30 F (LCM.)	T291
CM (LCM.)	T292
F1 (LFMX)	T292
F2 (LFMX)	T292
M2 (LFMX)	T292

Table 3  
 Tabla 3  
 Tableau 3

GEOMETRY OF CUTTING INSERTS – CLAMPING DESIGNATION ISO P, M, D  
 GEOMETRÍA DE PLAQUITAS DE CORTE – TIPO DE FIJACIÓN ISO P, M, D  
 GÉOMÉTRIE DES PLAQUETTES – FIXATION DE TYPE ISO P, M, D


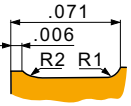
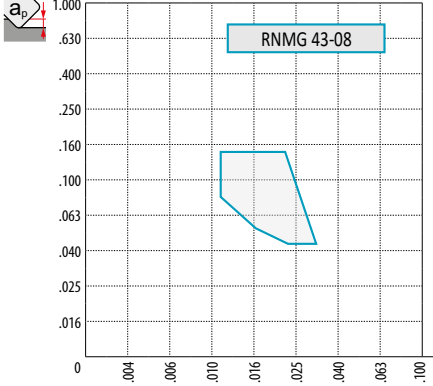







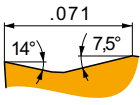
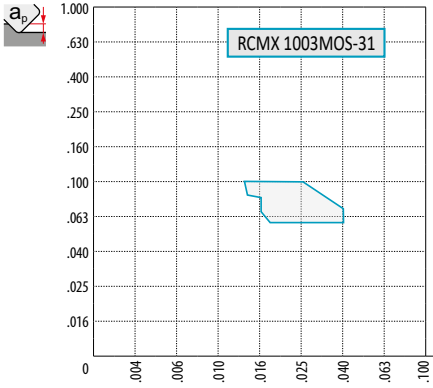







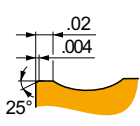
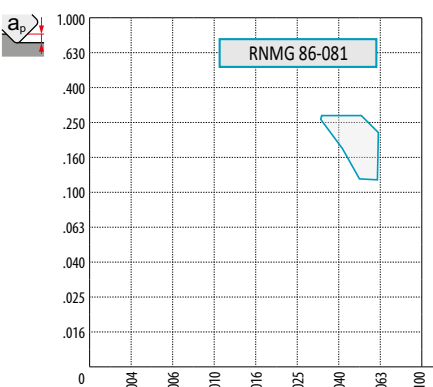







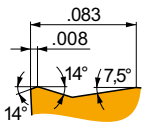
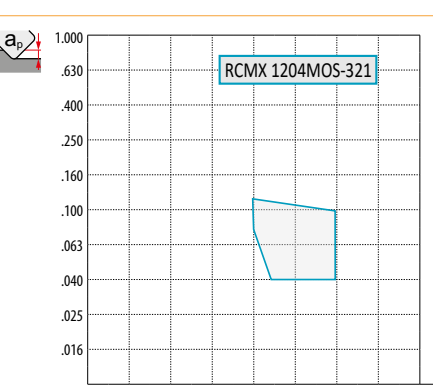






<p><b>08 (RNMG)</b></p>  	 <p>RNMG 43-08</p>	<table border="1"> <thead> <tr> <th>P</th> <th>M</th> <th>K</th> <th>N</th> <th>S</th> <th>H</th> </tr> </thead> <tbody> <tr> <td><input checked="" type="checkbox"/></td> <td></td> <td><input checked="" type="checkbox"/></td> <td></td> <td></td> <td><input checked="" type="checkbox"/></td> </tr> <tr> <td><math>f</math></td> <td colspan="5">.012 – .031</td> </tr> <tr> <td><math>a_p</math></td> <td colspan="5">.039 – .157</td> </tr> <tr> <td colspan="6" style="text-align: center;">  </td> </tr> <tr> <td colspan="6" style="text-align: center;">  </td> </tr> <tr> <td><b>?</b></td> <td colspan="5">RNMG</td> </tr> </tbody> </table>	P	M	K	N	S	H	<input checked="" type="checkbox"/>		<input checked="" type="checkbox"/>			<input checked="" type="checkbox"/>	$f$	.012 – .031					$a_p$	.039 – .157																	<b>?</b>	RNMG				
P	M	K	N	S	H																																							
<input checked="" type="checkbox"/>		<input checked="" type="checkbox"/>			<input checked="" type="checkbox"/>																																							
$f$	.012 – .031																																											
$a_p$	.039 – .157																																											
																																												
																																												
<b>?</b>	RNMG																																											
<p><b>31 (RCMX)</b></p>  	 <p>RCMX 1003MOS-31</p>	<table border="1"> <thead> <tr> <th>P</th> <th>M</th> <th>K</th> <th>N</th> <th>S</th> <th>H</th> </tr> </thead> <tbody> <tr> <td><input checked="" type="checkbox"/></td> <td><input checked="" type="checkbox"/></td> <td><input checked="" type="checkbox"/></td> <td></td> <td></td> <td></td> </tr> <tr> <td><math>f</math></td> <td colspan="5">.016 – .039</td> </tr> <tr> <td><math>a_p</math></td> <td colspan="5">.059 – .098</td> </tr> <tr> <td colspan="6" style="text-align: center;">  </td> </tr> <tr> <td colspan="6" style="text-align: center;">  </td> </tr> <tr> <td><b>?</b></td> <td colspan="5">RCMX</td> </tr> </tbody> </table>	P	M	K	N	S	H	<input checked="" type="checkbox"/>	<input checked="" type="checkbox"/>	<input checked="" type="checkbox"/>				$f$	.016 – .039					$a_p$	.059 – .098																	<b>?</b>	RCMX				
P	M	K	N	S	H																																							
<input checked="" type="checkbox"/>	<input checked="" type="checkbox"/>	<input checked="" type="checkbox"/>																																										
$f$	.016 – .039																																											
$a_p$	.059 – .098																																											
																																												
																																												
<b>?</b>	RCMX																																											
<p><b>81 (RNMG)</b></p>  	 <p>RNMG 86-081</p>	<table border="1"> <thead> <tr> <th>P</th> <th>M</th> <th>K</th> <th>N</th> <th>S</th> <th>H</th> </tr> </thead> <tbody> <tr> <td><input checked="" type="checkbox"/></td> <td><input checked="" type="checkbox"/></td> <td><input checked="" type="checkbox"/></td> <td></td> <td></td> <td></td> </tr> <tr> <td><math>f</math></td> <td colspan="5">.031 – .047</td> </tr> <tr> <td><math>a_p</math></td> <td colspan="5">.118 – .276</td> </tr> <tr> <td colspan="6" style="text-align: center;">  </td> </tr> <tr> <td colspan="6" style="text-align: center;">  </td> </tr> <tr> <td><b>?</b></td> <td colspan="5">RNMG</td> </tr> </tbody> </table>	P	M	K	N	S	H	<input checked="" type="checkbox"/>	<input checked="" type="checkbox"/>	<input checked="" type="checkbox"/>				$f$	.031 – .047					$a_p$	.118 – .276																	<b>?</b>	RNMG				
P	M	K	N	S	H																																							
<input checked="" type="checkbox"/>	<input checked="" type="checkbox"/>	<input checked="" type="checkbox"/>																																										
$f$	.031 – .047																																											
$a_p$	.118 – .276																																											
																																												
																																												
<b>?</b>	RNMG																																											
<p><b>321 (RCMX)</b></p>  	 <p>RCMX 1204MOS-321</p>	<table border="1"> <thead> <tr> <th>P</th> <th>M</th> <th>K</th> <th>N</th> <th>S</th> <th>H</th> </tr> </thead> <tbody> <tr> <td><input checked="" type="checkbox"/></td> <td><input type="checkbox"/></td> <td><input checked="" type="checkbox"/></td> <td></td> <td></td> <td></td> </tr> <tr> <td><math>f</math></td> <td colspan="5">.016 – .039</td> </tr> <tr> <td><math>a_p</math></td> <td colspan="5">.039 – .118</td> </tr> <tr> <td colspan="6" style="text-align: center;">  </td> </tr> <tr> <td colspan="6" style="text-align: center;">  </td> </tr> <tr> <td><b>?</b></td> <td colspan="5">RCMX</td> </tr> </tbody> </table>	P	M	K	N	S	H	<input checked="" type="checkbox"/>	<input type="checkbox"/>	<input checked="" type="checkbox"/>				$f$	.016 – .039					$a_p$	.039 – .118																	<b>?</b>	RCMX				
P	M	K	N	S	H																																							
<input checked="" type="checkbox"/>	<input type="checkbox"/>	<input checked="" type="checkbox"/>																																										
$f$	.016 – .039																																											
$a_p$	.039 – .118																																											
																																												
																																												
<b>?</b>	RCMX																																											

Table 3  
 Tabla 3  
 Tableau 3

GEOMETRY OF CUTTING INSERTS – CLAMPING DESIGNATION ISO P, M, D  
 GEOMETRÍA DE PLAQUITAS DE CORTE – TIPO DE FIJACIÓN ISO P, M, D  
 GÉOMÉTRIE DES PLAQUETTES – FIXATION DE TYPE ISO P, M, D

<p>331 (RCMX)</p>			<table border="1"> <thead> <tr> <th>P</th> <th>M</th> <th>K</th> <th>N</th> <th>S</th> <th>H</th> </tr> </thead> <tbody> <tr> <td>■</td> <td>□</td> <td>■</td> <td></td> <td></td> <td></td> </tr> <tr> <td><math>f</math></td> <td colspan="5">.016 – .047</td> </tr> <tr> <td><math>a_p</math></td> <td colspan="5">.039 – .157</td> </tr> <tr> <td colspan="6" style="text-align: center;"> </td> </tr> <tr> <td colspan="6" style="text-align: center;"> </td> </tr> <tr> <td>?</td> <td colspan="5">RCMX</td> </tr> </tbody> </table>	P	M	K	N	S	H	■	□	■				$f$	.016 – .047					$a_p$	.039 – .157																	?	RCMX				
P	M	K	N	S	H																																								
■	□	■																																											
$f$	.016 – .047																																												
$a_p$	.039 – .157																																												
?	RCMX																																												
<p>361 (RCMX)</p>			<table border="1"> <thead> <tr> <th>P</th> <th>M</th> <th>K</th> <th>N</th> <th>S</th> <th>H</th> </tr> </thead> <tbody> <tr> <td>■</td> <td>□</td> <td>■</td> <td></td> <td></td> <td></td> </tr> <tr> <td><math>f</math></td> <td colspan="5">.031 – .059</td> </tr> <tr> <td><math>a_p</math></td> <td colspan="5">.118 – .315</td> </tr> <tr> <td colspan="6" style="text-align: center;"> </td> </tr> <tr> <td colspan="6" style="text-align: center;"> </td> </tr> <tr> <td>?</td> <td colspan="5">RCMX</td> </tr> </tbody> </table>	P	M	K	N	S	H	■	□	■				$f$	.031 – .059					$a_p$	.118 – .315																	?	RCMX				
P	M	K	N	S	H																																								
■	□	■																																											
$f$	.031 – .059																																												
$a_p$	.118 – .315																																												
?	RCMX																																												
<p>923</p>			<table border="1"> <thead> <tr> <th>P</th> <th>M</th> <th>K</th> <th>N</th> <th>S</th> <th>H</th> </tr> </thead> <tbody> <tr> <td>■</td> <td>■</td> <td>■</td> <td></td> <td></td> <td></td> </tr> <tr> <td><math>f</math></td> <td colspan="5">.018 – .059</td> </tr> <tr> <td><math>a_p</math></td> <td colspan="5">.118 – .512</td> </tr> <tr> <td colspan="6" style="text-align: center;"> </td> </tr> <tr> <td colspan="6" style="text-align: center;"> </td> </tr> <tr> <td>?</td> <td colspan="5">CNMM, SNMM</td> </tr> </tbody> </table>	P	M	K	N	S	H	■	■	■				$f$	.018 – .059					$a_p$	.118 – .512																	?	CNMM, SNMM				
P	M	K	N	S	H																																								
■	■	■																																											
$f$	.018 – .059																																												
$a_p$	.118 – .512																																												
?	CNMM, SNMM																																												
<p>...A</p>			<table border="1"> <thead> <tr> <th>P</th> <th>M</th> <th>K</th> <th>N</th> <th>S</th> <th>H</th> </tr> </thead> <tbody> <tr> <td>■</td> <td>□</td> <td>■</td> <td></td> <td></td> <td>■</td> </tr> <tr> <td><math>f</math></td> <td colspan="5">.004 – .035</td> </tr> <tr> <td><math>a_p</math></td> <td colspan="5">.031 – .472</td> </tr> <tr> <td colspan="6" style="text-align: center;"> </td> </tr> <tr> <td colspan="6" style="text-align: center;"> </td> </tr> <tr> <td>?</td> <td colspan="5">CNMA, DNMA, SNMA, TNMA, WNMA</td> </tr> </tbody> </table>	P	M	K	N	S	H	■	□	■			■	$f$	.004 – .035					$a_p$	.031 – .472																	?	CNMA, DNMA, SNMA, TNMA, WNMA				
P	M	K	N	S	H																																								
■	□	■			■																																								
$f$	.004 – .035																																												
$a_p$	.031 – .472																																												
?	CNMA, DNMA, SNMA, TNMA, WNMA																																												

Table 3  
Tabla 3  
Tableau 3

GEOMETRY OF CUTTING INSERTS – CLAMPING DESIGNATION ISO P, M, D  
 GEOMETRÍA DE PLAQUITAS DE CORTE – TIPO DE FIJACIÓN ISO P, M, D  
 GÉOMÉTRIE DES PLAQUETTES – FIXATION DE TYPE ISO P, M, D

DR				<table border="1"> <thead> <tr> <th>P</th> <th>M</th> <th>K</th> <th>N</th> <th>S</th> <th>H</th> </tr> </thead> <tbody> <tr> <td>■</td> <td>■</td> <td>▣</td> <td>□</td> <td>□</td> <td>□</td> </tr> <tr> <td colspan="6">f → .012 – .033</td> </tr> <tr> <td colspan="6">a<sub>p</sub> ↓ .098 – .354</td> </tr> <tr> <td colspan="6" style="text-align: center;"> </td> </tr> <tr> <td colspan="6" style="text-align: center;"> </td> </tr> <tr> <td colspan="6">? CNMM, DNMM, SNMM, TNMM, WNMM</td> </tr> </tbody> </table>	P	M	K	N	S	H	■	■	▣	□	□	□	f → .012 – .033						a <sub>p</sub> ↓ .098 – .354																		? CNMM, DNMM, SNMM, TNMM, WNMM					
	P	M	K	N	S	H																																								
■	■	▣	□	□	□																																									
f → .012 – .033																																														
a <sub>p</sub> ↓ .098 – .354																																														
? CNMM, DNMM, SNMM, TNMM, WNMM																																														
FF				<table border="1"> <thead> <tr> <th>P</th> <th>M</th> <th>K</th> <th>N</th> <th>S</th> <th>H</th> </tr> </thead> <tbody> <tr> <td>■</td> <td>■</td> <td>▣</td> <td>□</td> <td>□</td> <td>□</td> </tr> <tr> <td colspan="6">f → .002 – .008</td> </tr> <tr> <td colspan="6">a<sub>p</sub> ↓ .012 – .059</td> </tr> <tr> <td colspan="6" style="text-align: center;"> </td> </tr> <tr> <td colspan="6" style="text-align: center;"> </td> </tr> <tr> <td colspan="6">? CNMG, DNMG, TNMG, VNMG, WNMG</td> </tr> </tbody> </table>	P	M	K	N	S	H	■	■	▣	□	□	□	f → .002 – .008						a <sub>p</sub> ↓ .012 – .059																		? CNMG, DNMG, TNMG, VNMG, WNMG					
	P	M	K	N	S	H																																								
■	■	▣	□	□	□																																									
f → .002 – .008																																														
a <sub>p</sub> ↓ .012 – .059																																														
? CNMG, DNMG, TNMG, VNMG, WNMG																																														
FM				<table border="1"> <thead> <tr> <th>P</th> <th>M</th> <th>K</th> <th>N</th> <th>S</th> <th>H</th> </tr> </thead> <tbody> <tr> <td>■</td> <td>■</td> <td>▣</td> <td>□</td> <td>□</td> <td>□</td> </tr> <tr> <td colspan="6">f → .006 – .018</td> </tr> <tr> <td colspan="6">a<sub>p</sub> ↓ .020 – .118</td> </tr> <tr> <td colspan="6" style="text-align: center;"> </td> </tr> <tr> <td colspan="6" style="text-align: center;"> </td> </tr> <tr> <td colspan="6">? CNMG, DNMG, SNMG, TNMG, VNMG, WNMG</td> </tr> </tbody> </table>	P	M	K	N	S	H	■	■	▣	□	□	□	f → .006 – .018						a <sub>p</sub> ↓ .020 – .118																		? CNMG, DNMG, SNMG, TNMG, VNMG, WNMG					
	P	M	K	N	S	H																																								
■	■	▣	□	□	□																																									
f → .006 – .018																																														
a <sub>p</sub> ↓ .020 – .118																																														
? CNMG, DNMG, SNMG, TNMG, VNMG, WNMG																																														
HR				<table border="1"> <thead> <tr> <th>P</th> <th>M</th> <th>K</th> <th>N</th> <th>S</th> <th>H</th> </tr> </thead> <tbody> <tr> <td>■</td> <td>▣</td> <td>■</td> <td>□</td> <td>□</td> <td>□</td> </tr> <tr> <td colspan="6">f → .020 – .055</td> </tr> <tr> <td colspan="6">a<sub>p</sub> ↓ .197 – .551</td> </tr> <tr> <td colspan="6" style="text-align: center;"> </td> </tr> <tr> <td colspan="6" style="text-align: center;"> </td> </tr> <tr> <td colspan="6">? CNMM, SNMM, TNMM</td> </tr> </tbody> </table>	P	M	K	N	S	H	■	▣	■	□	□	□	f → .020 – .055						a <sub>p</sub> ↓ .197 – .551																		? CNMM, SNMM, TNMM					
	P	M	K	N	S	H																																								
■	▣	■	□	□	□																																									
f → .020 – .055																																														
a <sub>p</sub> ↓ .197 – .551																																														
? CNMM, SNMM, TNMM																																														

Table 3  
 Tabla 3  
 Tableau 3

GEOMETRY OF CUTTING INSERTS – CLAMPING DESIGNATION ISO P, M, D  
 GEOMETRÍA DE PLAQUITAS DE CORTE – TIPO DE FIJACIÓN ISO P, M, D  
 GÉOMÉTRIE DES PLAQUETTES – FIXATION DE TYPE ISO P, M, D

<p>HR2</p>		<p>SNMM 866-HR2</p>	<table border="1"> <thead> <tr> <th>P</th> <th>M</th> <th>K</th> <th>N</th> <th>S</th> <th>H</th> </tr> </thead> <tbody> <tr> <td><input checked="" type="checkbox"/></td> <td><input checked="" type="checkbox"/></td> <td><input checked="" type="checkbox"/></td> <td><input type="checkbox"/></td> <td><input type="checkbox"/></td> <td><input type="checkbox"/></td> </tr> <tr> <td colspan="6">  .020 – .055         </td> </tr> <tr> <td colspan="6">  .118 – .630         </td> </tr> <tr> <td colspan="6"> </td> </tr> <tr> <td colspan="6"> </td> </tr> <tr> <td colspan="6">  CNMM, SNMM         </td> </tr> </tbody> </table>	P	M	K	N	S	H	<input checked="" type="checkbox"/>	<input checked="" type="checkbox"/>	<input checked="" type="checkbox"/>	<input type="checkbox"/>	<input type="checkbox"/>	<input type="checkbox"/>	.020 – .055						.118 – .630																		CNMM, SNMM					
P	M	K	N	S	H																																								
<input checked="" type="checkbox"/>	<input checked="" type="checkbox"/>	<input checked="" type="checkbox"/>	<input type="checkbox"/>	<input type="checkbox"/>	<input type="checkbox"/>																																								
.020 – .055																																													
.118 – .630																																													
CNMM, SNMM																																													
<p>KR</p>		<p>CNMG 432-KR</p>	<table border="1"> <thead> <tr> <th>P</th> <th>M</th> <th>K</th> <th>N</th> <th>S</th> <th>H</th> </tr> </thead> <tbody> <tr> <td><input checked="" type="checkbox"/></td> <td><input checked="" type="checkbox"/></td> <td><input checked="" type="checkbox"/></td> <td><input type="checkbox"/></td> <td><input type="checkbox"/></td> <td><input type="checkbox"/></td> </tr> <tr> <td colspan="6">  .008 – .028         </td> </tr> <tr> <td colspan="6">  .031 – .276         </td> </tr> <tr> <td colspan="6"> </td> </tr> <tr> <td colspan="6"> </td> </tr> <tr> <td colspan="6">  CNMG, SNMG, TNMG, WNMG         </td> </tr> </tbody> </table>	P	M	K	N	S	H	<input checked="" type="checkbox"/>	<input checked="" type="checkbox"/>	<input checked="" type="checkbox"/>	<input type="checkbox"/>	<input type="checkbox"/>	<input type="checkbox"/>	.008 – .028						.031 – .276																		CNMG, SNMG, TNMG, WNMG					
P	M	K	N	S	H																																								
<input checked="" type="checkbox"/>	<input checked="" type="checkbox"/>	<input checked="" type="checkbox"/>	<input type="checkbox"/>	<input type="checkbox"/>	<input type="checkbox"/>																																								
.008 – .028																																													
.031 – .276																																													
CNMG, SNMG, TNMG, WNMG																																													
<p>M</p>		<p>CNMG 432-M</p>	<table border="1"> <thead> <tr> <th>P</th> <th>M</th> <th>K</th> <th>N</th> <th>S</th> <th>H</th> </tr> </thead> <tbody> <tr> <td><input checked="" type="checkbox"/></td> <td><input checked="" type="checkbox"/></td> <td><input checked="" type="checkbox"/></td> <td><input type="checkbox"/></td> <td><input type="checkbox"/></td> <td><input type="checkbox"/></td> </tr> <tr> <td colspan="6">  .007 – .031         </td> </tr> <tr> <td colspan="6">  .039 – .315         </td> </tr> <tr> <td colspan="6"> </td> </tr> <tr> <td colspan="6"> </td> </tr> <tr> <td colspan="6">  CNMG, DNMG, SNMG, TNMG, VNMG, WNMG         </td> </tr> </tbody> </table>	P	M	K	N	S	H	<input checked="" type="checkbox"/>	<input checked="" type="checkbox"/>	<input checked="" type="checkbox"/>	<input type="checkbox"/>	<input type="checkbox"/>	<input type="checkbox"/>	.007 – .031						.039 – .315																		CNMG, DNMG, SNMG, TNMG, VNMG, WNMG					
P	M	K	N	S	H																																								
<input checked="" type="checkbox"/>	<input checked="" type="checkbox"/>	<input checked="" type="checkbox"/>	<input type="checkbox"/>	<input type="checkbox"/>	<input type="checkbox"/>																																								
.007 – .031																																													
.039 – .315																																													
CNMG, DNMG, SNMG, TNMG, VNMG, WNMG																																													
<p>NF</p>		<p>CNMG 432-NF</p>	<table border="1"> <thead> <tr> <th>P</th> <th>M</th> <th>K</th> <th>N</th> <th>S</th> <th>H</th> </tr> </thead> <tbody> <tr> <td><input checked="" type="checkbox"/></td> <td><input checked="" type="checkbox"/></td> <td><input checked="" type="checkbox"/></td> <td><input type="checkbox"/></td> <td><input checked="" type="checkbox"/></td> <td><input type="checkbox"/></td> </tr> <tr> <td colspan="6">  .004 – .014         </td> </tr> <tr> <td colspan="6">  .016 – .157         </td> </tr> <tr> <td colspan="6"> </td> </tr> <tr> <td colspan="6"> </td> </tr> <tr> <td colspan="6">  CNMG, DNMG, SNMG, TNMG, VNMG, WNMG         </td> </tr> </tbody> </table>	P	M	K	N	S	H	<input checked="" type="checkbox"/>	<input checked="" type="checkbox"/>	<input checked="" type="checkbox"/>	<input type="checkbox"/>	<input checked="" type="checkbox"/>	<input type="checkbox"/>	.004 – .014						.016 – .157																		CNMG, DNMG, SNMG, TNMG, VNMG, WNMG					
P	M	K	N	S	H																																								
<input checked="" type="checkbox"/>	<input checked="" type="checkbox"/>	<input checked="" type="checkbox"/>	<input type="checkbox"/>	<input checked="" type="checkbox"/>	<input type="checkbox"/>																																								
.004 – .014																																													
.016 – .157																																													
CNMG, DNMG, SNMG, TNMG, VNMG, WNMG																																													

Table 3  
Tabla 3  
Tableau 3

GEOMETRY OF CUTTING INSERTS – CLAMPING DESIGNATION ISO P, M, D  
 GEOMETRÍA DE PLAQUITAS DE CORTE – TIPO DE FIJACIÓN ISO P, M, D  
 GÉOMÉTRIE DES PLAQUETTES – FIXATION DE TYPE ISO P, M, D

NM																																													
				<table border="1"> <thead> <tr> <th>P</th> <th>M</th> <th>K</th> <th>N</th> <th>S</th> <th>H</th> </tr> </thead> <tbody> <tr> <td>■</td> <td>■</td> <td>□</td> <td>□</td> <td>■</td> <td></td> </tr> <tr> <td></td> <td colspan="5">.006 – .020</td> </tr> <tr> <td></td> <td colspan="5">.020 – .315</td> </tr> <tr> <td colspan="6"></td> </tr> <tr> <td colspan="6"> </td> </tr> <tr> <td colspan="6">  CNMG, DNMG, TNMG, VNMG, WNMG                 </td> </tr> </tbody> </table>	P	M	K	N	S	H	■	■	□	□	■			.006 – .020						.020 – .315																	CNMG, DNMG, TNMG, VNMG, WNMG				
P	M	K	N	S	H																																								
■	■	□	□	■																																									
	.006 – .020																																												
	.020 – .315																																												
CNMG, DNMG, TNMG, VNMG, WNMG																																													
NMR																																													
				<table border="1"> <thead> <tr> <th>P</th> <th>M</th> <th>K</th> <th>N</th> <th>S</th> <th>H</th> </tr> </thead> <tbody> <tr> <td>■</td> <td>■</td> <td>□</td> <td>□</td> <td>■</td> <td></td> </tr> <tr> <td></td> <td colspan="5">.007 – .028</td> </tr> <tr> <td></td> <td colspan="5">.016 – .315</td> </tr> <tr> <td colspan="6"></td> </tr> <tr> <td colspan="6"> </td> </tr> <tr> <td colspan="6">  CNMG, DNMG, SNMG, TNMG, VNMG, WNMG                 </td> </tr> </tbody> </table>	P	M	K	N	S	H	■	■	□	□	■			.007 – .028						.016 – .315																	CNMG, DNMG, SNMG, TNMG, VNMG, WNMG				
P	M	K	N	S	H																																								
■	■	□	□	■																																									
	.007 – .028																																												
	.016 – .315																																												
CNMG, DNMG, SNMG, TNMG, VNMG, WNMG																																													
NR																																													
				<table border="1"> <thead> <tr> <th>P</th> <th>M</th> <th>K</th> <th>N</th> <th>S</th> <th>H</th> </tr> </thead> <tbody> <tr> <td>■</td> <td>■</td> <td>□</td> <td>□</td> <td>■</td> <td></td> </tr> <tr> <td></td> <td colspan="5">.010 – .031</td> </tr> <tr> <td></td> <td colspan="5">.039 – .354</td> </tr> <tr> <td colspan="6"></td> </tr> <tr> <td colspan="6"> </td> </tr> <tr> <td colspan="6">  CNMM, DNMM, SNMM, TNMM, WNMM                 </td> </tr> </tbody> </table>	P	M	K	N	S	H	■	■	□	□	■			.010 – .031						.039 – .354																	CNMM, DNMM, SNMM, TNMM, WNMM				
P	M	K	N	S	H																																								
■	■	□	□	■																																									
	.010 – .031																																												
	.039 – .354																																												
CNMM, DNMM, SNMM, TNMM, WNMM																																													
NR2																																													
				<table border="1"> <thead> <tr> <th>P</th> <th>M</th> <th>K</th> <th>N</th> <th>S</th> <th>H</th> </tr> </thead> <tbody> <tr> <td>■</td> <td>■</td> <td>□</td> <td>□</td> <td>■</td> <td></td> </tr> <tr> <td></td> <td colspan="5">.010 – .047</td> </tr> <tr> <td></td> <td colspan="5">.039 – .630</td> </tr> <tr> <td colspan="6"></td> </tr> <tr> <td colspan="6"> </td> </tr> <tr> <td colspan="6">  CNMM, DNMM, SNMM, TNMM, WNMM                 </td> </tr> </tbody> </table>	P	M	K	N	S	H	■	■	□	□	■			.010 – .047						.039 – .630																	CNMM, DNMM, SNMM, TNMM, WNMM				
P	M	K	N	S	H																																								
■	■	□	□	■																																									
	.010 – .047																																												
	.039 – .630																																												
CNMM, DNMM, SNMM, TNMM, WNMM																																													

Table 3  
 Tabla 3  
 Tableau 3

GEOMETRY OF CUTTING INSERTS – CLAMPING DESIGNATION ISO P, M, D  
 GEOMETRÍA DE PLAQUITAS DE CORTE – TIPO DE FIJACIÓN ISO P, M, D  
 GÉOMÉTRIE DES PLAQUETTES – FIXATION DE TYPE ISO P, M, D

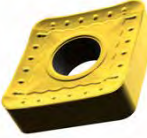
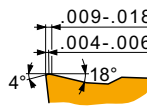
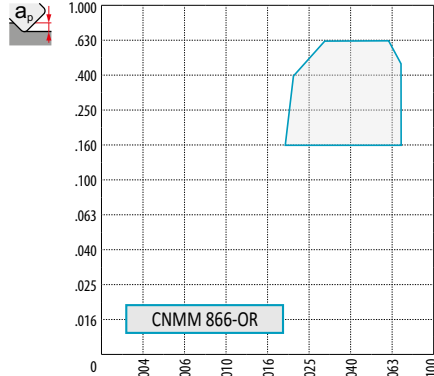







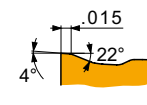
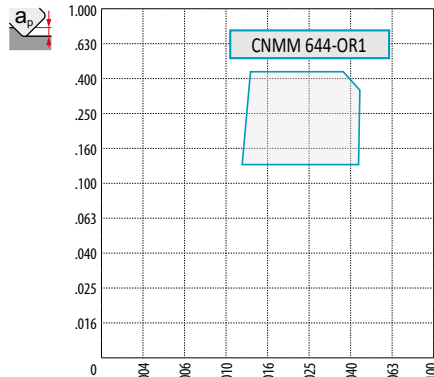







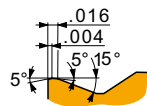
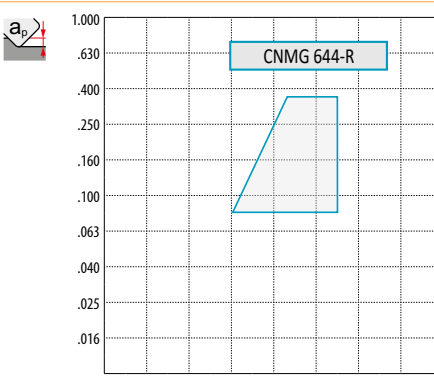







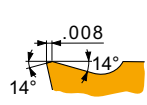
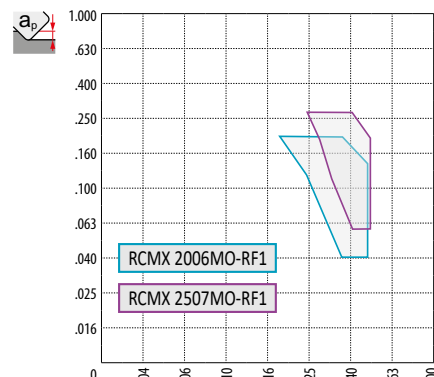






OR	 	 <p>CNMM 866-OR</p>	<table border="1"> <thead> <tr> <th>P</th> <th>M</th> <th>K</th> <th>N</th> <th>S</th> <th>H</th> </tr> </thead> <tbody> <tr> <td>■</td> <td>■</td> <td>▣</td> <td>■</td> <td>□</td> <td>■</td> </tr> <tr> <td><math>f</math></td> <td colspan="5">.010 – .067</td> </tr> <tr> <td><math>a_p</math></td> <td colspan="5">.079 – .630</td> </tr> <tr> <td colspan="6" style="text-align: center;">  </td> </tr> <tr> <td colspan="6" style="text-align: center;">  </td> </tr> <tr> <td>?</td> <td colspan="5">CNMM, DNMM, SNMM, TNMM, WNMM, SCMT</td> </tr> </tbody> </table>	P	M	K	N	S	H	■	■	▣	■	□	■	$f$	.010 – .067					$a_p$	.079 – .630																	?	CNMM, DNMM, SNMM, TNMM, WNMM, SCMT				
P	M	K	N	S	H																																								
■	■	▣	■	□	■																																								
$f$	.010 – .067																																												
$a_p$	.079 – .630																																												
																																													
																																													
?	CNMM, DNMM, SNMM, TNMM, WNMM, SCMT																																												
OR1	 	 <p>CNMM 644-OR1</p>	<table border="1"> <thead> <tr> <th>P</th> <th>M</th> <th>K</th> <th>N</th> <th>S</th> <th>H</th> </tr> </thead> <tbody> <tr> <td>■</td> <td>■</td> <td>▣</td> <td>■</td> <td>□</td> <td>■</td> </tr> <tr> <td><math>f</math></td> <td colspan="5">.015 – .047</td> </tr> <tr> <td><math>a_p</math></td> <td colspan="5">.118 – .394</td> </tr> <tr> <td colspan="6" style="text-align: center;">  </td> </tr> <tr> <td colspan="6" style="text-align: center;">  </td> </tr> <tr> <td>?</td> <td colspan="5">CNMM, SNMM</td> </tr> </tbody> </table>	P	M	K	N	S	H	■	■	▣	■	□	■	$f$	.015 – .047					$a_p$	.118 – .394																	?	CNMM, SNMM				
P	M	K	N	S	H																																								
■	■	▣	■	□	■																																								
$f$	.015 – .047																																												
$a_p$	.118 – .394																																												
																																													
																																													
?	CNMM, SNMM																																												
R	 	 <p>CNMG 644-R</p>	<table border="1"> <thead> <tr> <th>P</th> <th>M</th> <th>K</th> <th>N</th> <th>S</th> <th>H</th> </tr> </thead> <tbody> <tr> <td>■</td> <td>▣</td> <td>■</td> <td>■</td> <td>■</td> <td>□</td> </tr> <tr> <td><math>f</math></td> <td colspan="5">.012 – .031</td> </tr> <tr> <td><math>a_p</math></td> <td colspan="5">.118 – .394</td> </tr> <tr> <td colspan="6" style="text-align: center;">  </td> </tr> <tr> <td colspan="6" style="text-align: center;">  </td> </tr> <tr> <td>?</td> <td colspan="5">CNMG, DNMG, SNMG, TNMG, WNMG</td> </tr> </tbody> </table>	P	M	K	N	S	H	■	▣	■	■	■	□	$f$	.012 – .031					$a_p$	.118 – .394																	?	CNMG, DNMG, SNMG, TNMG, WNMG				
P	M	K	N	S	H																																								
■	▣	■	■	■	□																																								
$f$	.012 – .031																																												
$a_p$	.118 – .394																																												
																																													
																																													
?	CNMG, DNMG, SNMG, TNMG, WNMG																																												
RF1 (RCMX)	 	 <p>RCMX 2006MO-RF1        RCMX 2507MO-RF1</p>	<table border="1"> <thead> <tr> <th>P</th> <th>M</th> <th>K</th> <th>N</th> <th>S</th> <th>H</th> </tr> </thead> <tbody> <tr> <td>■</td> <td>□</td> <td>■</td> <td>■</td> <td>■</td> <td>■</td> </tr> <tr> <td><math>f</math></td> <td colspan="5">.018 (.024) – .047 (.049)</td> </tr> <tr> <td><math>a_p</math></td> <td colspan="5">.039 (.059) – .197 (.276)</td> </tr> <tr> <td colspan="6" style="text-align: center;">  </td> </tr> <tr> <td colspan="6" style="text-align: center;">  </td> </tr> <tr> <td>?</td> <td colspan="5">RCMX 20, RCMX 25</td> </tr> </tbody> </table>	P	M	K	N	S	H	■	□	■	■	■	■	$f$	.018 (.024) – .047 (.049)					$a_p$	.039 (.059) – .197 (.276)																	?	RCMX 20, RCMX 25				
P	M	K	N	S	H																																								
■	□	■	■	■	■																																								
$f$	.018 (.024) – .047 (.049)																																												
$a_p$	.039 (.059) – .197 (.276)																																												
																																													
																																													
?	RCMX 20, RCMX 25																																												



Table 3  
Tabla 3  
Tableau 3

GEOMETRY OF CUTTING INSERTS – CLAMPING DESIGNATION ISO P, M, D  
GEOMETRÍA DE PLAQUITAS DE CORTE – TIPO DE FIJACIÓN ISO P, M, D  
GÉOMÉTRIE DES PLAQUETTES – FIXATION DE TYPE ISO P, M, D


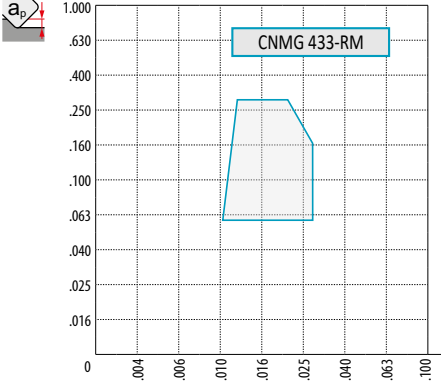










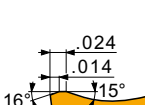
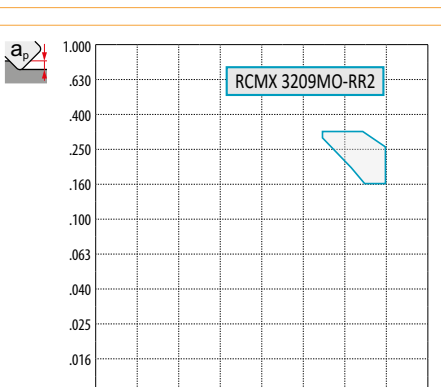






<p><b>RM</b></p>  	 <p>CNMG 433-RM</p>	<table border="1"> <thead> <tr> <th>P</th> <th>M</th> <th>K</th> <th>N</th> <th>S</th> <th>H</th> </tr> </thead> <tbody> <tr> <td>■</td> <td>■</td> <td>■</td> <td>■</td> <td>■</td> <td>□</td> </tr> <tr> <td><math>f</math></td> <td colspan="5">.012 – .031</td> </tr> <tr> <td><math>a_p</math></td> <td colspan="5">.059 – .276</td> </tr> <tr> <td colspan="6" style="text-align: center;">  </td> </tr> <tr> <td colspan="6" style="text-align: center;">  </td> </tr> <tr> <td><b>?</b></td> <td colspan="5">CNMG, DNMG, SNMG, TNMG, WNMG</td> </tr> </tbody> </table>	P	M	K	N	S	H	■	■	■	■	■	□	$f$	.012 – .031					$a_p$	.059 – .276																	<b>?</b>	CNMG, DNMG, SNMG, TNMG, WNMG				
P	M	K	N	S	H																																							
■	■	■	■	■	□																																							
$f$	.012 – .031																																											
$a_p$	.059 – .276																																											
																																												
																																												
<b>?</b>	CNMG, DNMG, SNMG, TNMG, WNMG																																											
<p><b>RM1 (RCMX)</b></p>  	 <p>RCMX 2006MO-RM1 RCMX 2507MO-RM1</p>	<table border="1"> <thead> <tr> <th>P</th> <th>M</th> <th>K</th> <th>N</th> <th>S</th> <th>H</th> </tr> </thead> <tbody> <tr> <td>■</td> <td>□</td> <td>■</td> <td>■</td> <td>■</td> <td>■</td> </tr> <tr> <td><math>f</math></td> <td colspan="5">.020 (.028) – .051 (.055)</td> </tr> <tr> <td><math>a_p</math></td> <td colspan="5">.059 (.079) – .197 (.276)</td> </tr> <tr> <td colspan="6" style="text-align: center;">  </td> </tr> <tr> <td colspan="6" style="text-align: center;">  </td> </tr> <tr> <td><b>?</b></td> <td colspan="5">RCMX 20, RCMX 25</td> </tr> </tbody> </table>	P	M	K	N	S	H	■	□	■	■	■	■	$f$	.020 (.028) – .051 (.055)					$a_p$	.059 (.079) – .197 (.276)																	<b>?</b>	RCMX 20, RCMX 25				
P	M	K	N	S	H																																							
■	□	■	■	■	■																																							
$f$	.020 (.028) – .051 (.055)																																											
$a_p$	.059 (.079) – .197 (.276)																																											
																																												
																																												
<b>?</b>	RCMX 20, RCMX 25																																											
<p><b>RM2 (RCM.)</b></p>  	 <p>RCMX 2507MO-RM2 RCMX 3209MO-RM2</p>	<table border="1"> <thead> <tr> <th>P</th> <th>M</th> <th>K</th> <th>N</th> <th>S</th> <th>H</th> </tr> </thead> <tbody> <tr> <td>■</td> <td>□</td> <td>■</td> <td>■</td> <td>■</td> <td>■</td> </tr> <tr> <td><math>f</math></td> <td colspan="5">.028 (.031) – .051 (.059)</td> </tr> <tr> <td><math>a_p</math></td> <td colspan="5">.079 – .276 (.315)</td> </tr> <tr> <td colspan="6" style="text-align: center;">  </td> </tr> <tr> <td colspan="6" style="text-align: center;">  </td> </tr> <tr> <td><b>?</b></td> <td colspan="5">RCMX 25, RCMX 32, RCMH 32</td> </tr> </tbody> </table>	P	M	K	N	S	H	■	□	■	■	■	■	$f$	.028 (.031) – .051 (.059)					$a_p$	.079 – .276 (.315)																	<b>?</b>	RCMX 25, RCMX 32, RCMH 32				
P	M	K	N	S	H																																							
■	□	■	■	■	■																																							
$f$	.028 (.031) – .051 (.059)																																											
$a_p$	.079 – .276 (.315)																																											
																																												
																																												
<b>?</b>	RCMX 25, RCMX 32, RCMH 32																																											
<p><b>RR2 (RCM.)</b></p>  	 <p>RCMX 3209MO-RR2</p>	<table border="1"> <thead> <tr> <th>P</th> <th>M</th> <th>K</th> <th>N</th> <th>S</th> <th>H</th> </tr> </thead> <tbody> <tr> <td>■</td> <td>□</td> <td>■</td> <td>■</td> <td>■</td> <td>■</td> </tr> <tr> <td><math>f</math></td> <td colspan="5">.031 – .063</td> </tr> <tr> <td><math>a_p</math></td> <td colspan="5">.157 – .315</td> </tr> <tr> <td colspan="6" style="text-align: center;">  </td> </tr> <tr> <td colspan="6" style="text-align: center;">  </td> </tr> <tr> <td><b>?</b></td> <td colspan="5">RCMX 32, RCMH 32</td> </tr> </tbody> </table>	P	M	K	N	S	H	■	□	■	■	■	■	$f$	.031 – .063					$a_p$	.157 – .315																	<b>?</b>	RCMX 32, RCMH 32				
P	M	K	N	S	H																																							
■	□	■	■	■	■																																							
$f$	.031 – .063																																											
$a_p$	.157 – .315																																											
																																												
																																												
<b>?</b>	RCMX 32, RCMH 32																																											



Table 3  
 Tabla 3  
 Tableau 3

GEOMETRY OF CUTTING INSERTS – CLAMPING DESIGNATION ISO P, M, D  
 GEOMETRÍA DE PLAQUITAS DE CORTE – TIPO DE FIJACIÓN ISO P, M, D  
 GÉOMÉTRIE DES PLAQUETTES – FIXATION DE TYPE ISO P, M, D


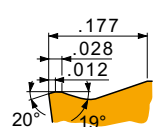
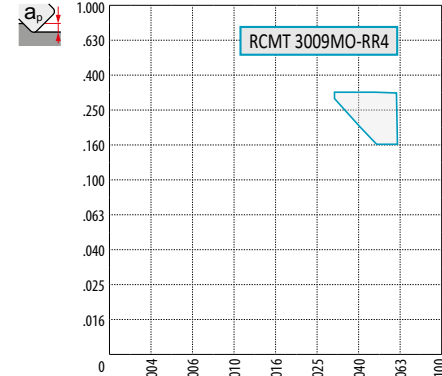







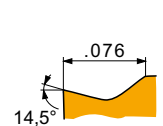
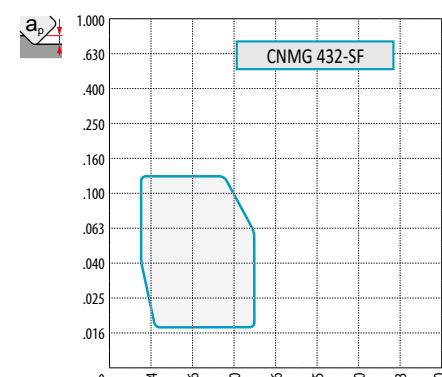







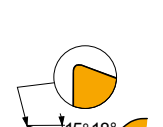
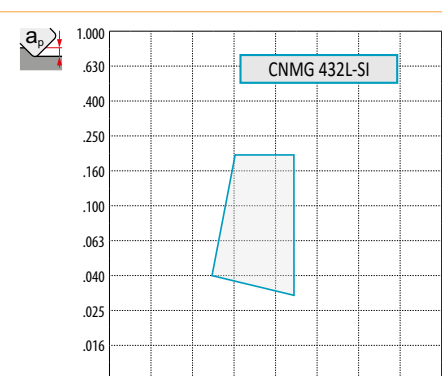








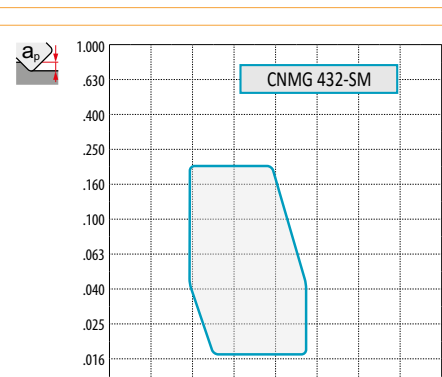






RR4 (RCMT)	 	 <p>RCMT 3009MO-RR4</p>	<table border="1"> <thead> <tr> <th>P</th> <th>M</th> <th>K</th> <th>N</th> <th>S</th> <th>H</th> </tr> </thead> <tbody> <tr> <td><input checked="" type="checkbox"/></td> <td><input type="checkbox"/></td> <td><input checked="" type="checkbox"/></td> <td><input type="checkbox"/></td> <td><input type="checkbox"/></td> <td><input type="checkbox"/></td> </tr> <tr> <td><math>f</math></td> <td colspan="5">.031 – .063</td> </tr> <tr> <td><math>a_p</math></td> <td colspan="5">.059 – .276</td> </tr> <tr> <td colspan="6" style="text-align: center;">  </td> </tr> <tr> <td colspan="6" style="text-align: center;">  </td> </tr> <tr> <td><b>?</b></td> <td colspan="5">RCMT 30</td> </tr> </tbody> </table>	P	M	K	N	S	H	<input checked="" type="checkbox"/>	<input type="checkbox"/>	<input checked="" type="checkbox"/>	<input type="checkbox"/>	<input type="checkbox"/>	<input type="checkbox"/>	$f$	.031 – .063					$a_p$	.059 – .276																	<b>?</b>	RCMT 30				
P	M	K	N	S	H																																								
<input checked="" type="checkbox"/>	<input type="checkbox"/>	<input checked="" type="checkbox"/>	<input type="checkbox"/>	<input type="checkbox"/>	<input type="checkbox"/>																																								
$f$	.031 – .063																																												
$a_p$	.059 – .276																																												
																																													
																																													
<b>?</b>	RCMT 30																																												
SF	 	 <p>CNMG 432-SF</p>	<table border="1"> <thead> <tr> <th>P</th> <th>M</th> <th>K</th> <th>N</th> <th>S</th> <th>H</th> </tr> </thead> <tbody> <tr> <td><input checked="" type="checkbox"/></td> <td><input checked="" type="checkbox"/></td> <td><input type="checkbox"/></td> <td><input type="checkbox"/></td> <td><input checked="" type="checkbox"/></td> <td><input type="checkbox"/></td> </tr> <tr> <td><math>f</math></td> <td colspan="5">.003 – .014</td> </tr> <tr> <td><math>a_p</math></td> <td colspan="5">.008 – .138</td> </tr> <tr> <td colspan="6" style="text-align: center;">  </td> </tr> <tr> <td colspan="6" style="text-align: center;">  </td> </tr> <tr> <td><b>?</b></td> <td colspan="5">CNGG, CNMG, DNMG, SNMG, TNMG, VNMG, WNMG</td> </tr> </tbody> </table>	P	M	K	N	S	H	<input checked="" type="checkbox"/>	<input checked="" type="checkbox"/>	<input type="checkbox"/>	<input type="checkbox"/>	<input checked="" type="checkbox"/>	<input type="checkbox"/>	$f$	.003 – .014					$a_p$	.008 – .138																	<b>?</b>	CNGG, CNMG, DNMG, SNMG, TNMG, VNMG, WNMG				
P	M	K	N	S	H																																								
<input checked="" type="checkbox"/>	<input checked="" type="checkbox"/>	<input type="checkbox"/>	<input type="checkbox"/>	<input checked="" type="checkbox"/>	<input type="checkbox"/>																																								
$f$	.003 – .014																																												
$a_p$	.008 – .138																																												
																																													
																																													
<b>?</b>	CNGG, CNMG, DNMG, SNMG, TNMG, VNMG, WNMG																																												
SI	 	 <p>CNMG 432L-SI</p>	<table border="1"> <thead> <tr> <th>P</th> <th>M</th> <th>K</th> <th>N</th> <th>S</th> <th>H</th> </tr> </thead> <tbody> <tr> <td><input checked="" type="checkbox"/></td> <td><input checked="" type="checkbox"/></td> <td><input type="checkbox"/></td> <td><input type="checkbox"/></td> <td><input checked="" type="checkbox"/></td> <td><input type="checkbox"/></td> </tr> <tr> <td><math>f</math></td> <td colspan="5">.008 – .020</td> </tr> <tr> <td><math>a_p</math></td> <td colspan="5">.031 – .197</td> </tr> <tr> <td colspan="6" style="text-align: center;">  </td> </tr> <tr> <td colspan="6" style="text-align: center;">  </td> </tr> <tr> <td><b>?</b></td> <td colspan="5">CNMG, DNMG, TNMG, WNMG</td> </tr> </tbody> </table>	P	M	K	N	S	H	<input checked="" type="checkbox"/>	<input checked="" type="checkbox"/>	<input type="checkbox"/>	<input type="checkbox"/>	<input checked="" type="checkbox"/>	<input type="checkbox"/>	$f$	.008 – .020					$a_p$	.031 – .197																	<b>?</b>	CNMG, DNMG, TNMG, WNMG				
P	M	K	N	S	H																																								
<input checked="" type="checkbox"/>	<input checked="" type="checkbox"/>	<input type="checkbox"/>	<input type="checkbox"/>	<input checked="" type="checkbox"/>	<input type="checkbox"/>																																								
$f$	.008 – .020																																												
$a_p$	.031 – .197																																												
																																													
																																													
<b>?</b>	CNMG, DNMG, TNMG, WNMG																																												
SM	 	 <p>CNMG 432-SM</p>	<table border="1"> <thead> <tr> <th>P</th> <th>M</th> <th>K</th> <th>N</th> <th>S</th> <th>H</th> </tr> </thead> <tbody> <tr> <td><input checked="" type="checkbox"/></td> <td><input checked="" type="checkbox"/></td> <td><input checked="" type="checkbox"/></td> <td><input type="checkbox"/></td> <td><input checked="" type="checkbox"/></td> <td><input type="checkbox"/></td> </tr> <tr> <td><math>f</math></td> <td colspan="5">.006 – .022</td> </tr> <tr> <td><math>a_p</math></td> <td colspan="5">.016 – .236</td> </tr> <tr> <td colspan="6" style="text-align: center;">  </td> </tr> <tr> <td colspan="6" style="text-align: center;">  </td> </tr> <tr> <td><b>?</b></td> <td colspan="5">CNMG, DNMG, SNMG, TNMG, VNMG, WNMG</td> </tr> </tbody> </table>	P	M	K	N	S	H	<input checked="" type="checkbox"/>	<input checked="" type="checkbox"/>	<input checked="" type="checkbox"/>	<input type="checkbox"/>	<input checked="" type="checkbox"/>	<input type="checkbox"/>	$f$	.006 – .022					$a_p$	.016 – .236																	<b>?</b>	CNMG, DNMG, SNMG, TNMG, VNMG, WNMG				
P	M	K	N	S	H																																								
<input checked="" type="checkbox"/>	<input checked="" type="checkbox"/>	<input checked="" type="checkbox"/>	<input type="checkbox"/>	<input checked="" type="checkbox"/>	<input type="checkbox"/>																																								
$f$	.006 – .022																																												
$a_p$	.016 – .236																																												
																																													
																																													
<b>?</b>	CNMG, DNMG, SNMG, TNMG, VNMG, WNMG																																												

Table 3  
Tabla 3  
Tableau 3

GEOMETRY OF CUTTING INSERTS – CLAMPING DESIGNATION ISO P, M, D  
 GEOMETRÍA DE PLAQUITAS DE CORTE – TIPO DE FIJACIÓN ISO P, M, D  
 GÉOMÉTRIE DES PLAQUETTES – FIXATION DE TYPE ISO P, M, D

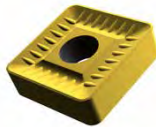
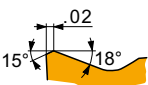
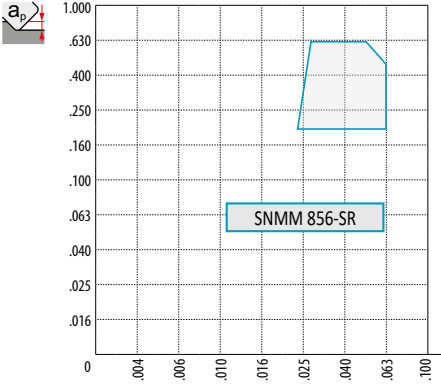






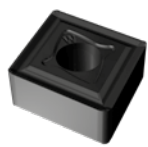
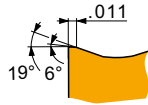
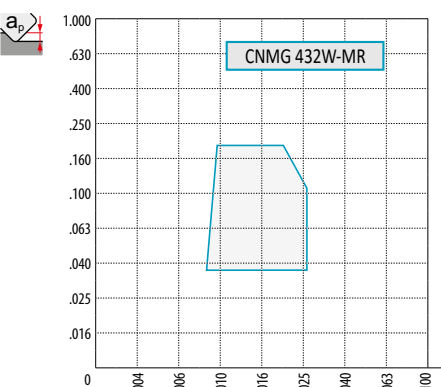






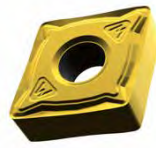
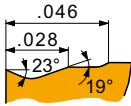








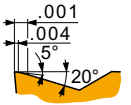
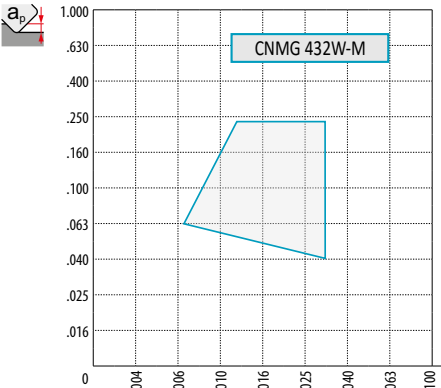






<p><b>SR</b></p>  	 <p>SNMM 856-SR</p>	<table border="1"> <thead> <tr> <th>P</th> <th>M</th> <th>K</th> <th>N</th> <th>S</th> <th>H</th> </tr> </thead> <tbody> <tr> <td>■</td> <td>■</td> <td>■</td> <td></td> <td></td> <td></td> </tr> <tr> <td><math>f</math></td> <td colspan="5">.028 – .063</td> </tr> <tr> <td><math>a_p</math></td> <td colspan="5">.197 – .630</td> </tr> <tr> <td colspan="6" style="text-align: center;">  </td> </tr> <tr> <td colspan="6" style="text-align: center;">  </td> </tr> <tr> <td><b>?</b></td> <td colspan="5">SNMM, SNMX</td> </tr> </tbody> </table>	P	M	K	N	S	H	■	■	■				$f$	.028 – .063					$a_p$	.197 – .630																	<b>?</b>	SNMM, SNMX				
P	M	K	N	S	H																																							
■	■	■																																										
$f$	.028 – .063																																											
$a_p$	.197 – .630																																											
																																												
																																												
<b>?</b>	SNMM, SNMX																																											
<p><b>W-MR</b></p>  	 <p>CNMG 432W-MR</p>	<table border="1"> <thead> <tr> <th>P</th> <th>M</th> <th>K</th> <th>N</th> <th>S</th> <th>H</th> </tr> </thead> <tbody> <tr> <td>■</td> <td>■</td> <td>■</td> <td></td> <td></td> <td></td> </tr> <tr> <td><math>f</math></td> <td colspan="5">.008 – .030</td> </tr> <tr> <td><math>a_p</math></td> <td colspan="5">.020 – .197</td> </tr> <tr> <td colspan="6" style="text-align: center;">  </td> </tr> <tr> <td colspan="6" style="text-align: center;">  </td> </tr> <tr> <td><b>?</b></td> <td colspan="5">CNMG, WNMG, DNMG</td> </tr> </tbody> </table>	P	M	K	N	S	H	■	■	■				$f$	.008 – .030					$a_p$	.020 – .197																	<b>?</b>	CNMG, WNMG, DNMG				
P	M	K	N	S	H																																							
■	■	■																																										
$f$	.008 – .030																																											
$a_p$	.020 – .197																																											
																																												
																																												
<b>?</b>	CNMG, WNMG, DNMG																																											
<p><b>W-F</b></p>  	 <p>CNMG 432W-F</p>	<table border="1"> <thead> <tr> <th>P</th> <th>M</th> <th>K</th> <th>N</th> <th>S</th> <th>H</th> </tr> </thead> <tbody> <tr> <td>■</td> <td></td> <td>■</td> <td></td> <td></td> <td></td> </tr> <tr> <td><math>f</math></td> <td colspan="5">.006 – .024</td> </tr> <tr> <td><math>a_p</math></td> <td colspan="5">.016 – .063</td> </tr> <tr> <td colspan="6" style="text-align: center;">  </td> </tr> <tr> <td colspan="6" style="text-align: center;">  </td> </tr> <tr> <td><b>?</b></td> <td colspan="5">CNMG, WNMG</td> </tr> </tbody> </table>	P	M	K	N	S	H	■		■				$f$	.006 – .024					$a_p$	.016 – .063																	<b>?</b>	CNMG, WNMG				
P	M	K	N	S	H																																							
■		■																																										
$f$	.006 – .024																																											
$a_p$	.016 – .063																																											
																																												
																																												
<b>?</b>	CNMG, WNMG																																											
<p><b>W-M</b></p>  	 <p>CNMG 432W-M</p>	<table border="1"> <thead> <tr> <th>P</th> <th>M</th> <th>K</th> <th>N</th> <th>S</th> <th>H</th> </tr> </thead> <tbody> <tr> <td>■</td> <td>■</td> <td>■</td> <td></td> <td></td> <td></td> </tr> <tr> <td><math>f</math></td> <td colspan="5">.007 – .031</td> </tr> <tr> <td><math>a_p</math></td> <td colspan="5">.039 – .236</td> </tr> <tr> <td colspan="6" style="text-align: center;">  </td> </tr> <tr> <td colspan="6" style="text-align: center;">  </td> </tr> <tr> <td><b>?</b></td> <td colspan="5">CNMG, WNMG</td> </tr> </tbody> </table>	P	M	K	N	S	H	■	■	■				$f$	.007 – .031					$a_p$	.039 – .236																	<b>?</b>	CNMG, WNMG				
P	M	K	N	S	H																																							
■	■	■																																										
$f$	.007 – .031																																											
$a_p$	.039 – .236																																											
																																												
																																												
<b>?</b>	CNMG, WNMG																																											

Table 3  
 Tabla 3  
 Tableau 3

GEOMETRY OF CUTTING INSERTS – CLAMPING DESIGNATION ISO P, M, D  
 GEOMETRÍA DE PLAQUITAS DE CORTE – TIPO DE FIJACIÓN ISO P, M, D  
 GÉOMÉTRIE DES PLAQUETTES – FIXATION DE TYPE ISO P, M, D

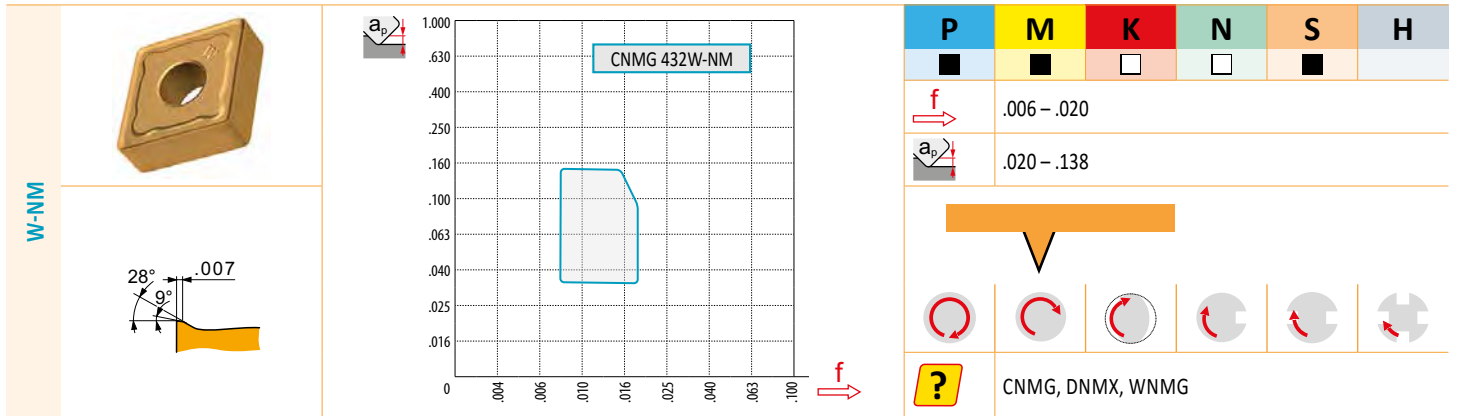


Table 3  
 Tabla 3  
 Tableau 3

**GEOMETRY OF CUTTING INSERTS – CLAMPING DESIGNATION ISO S  
 GEOMETRÍA DE PLAQUITAS DE CORTE – TIPO DE FIJACIÓN ISO S  
 GÉOMÉTRIE DES PLAQUETTES – FIXATION DE TYPE ISO S**


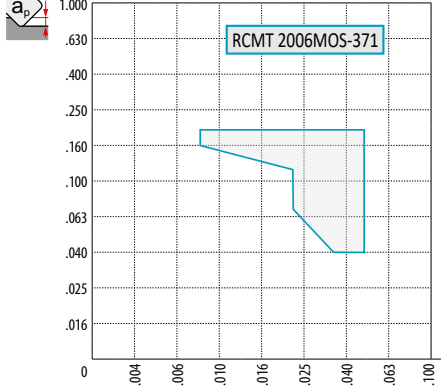







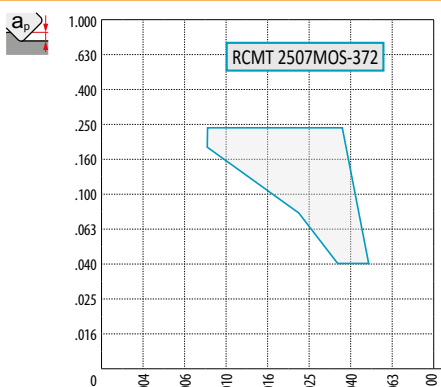







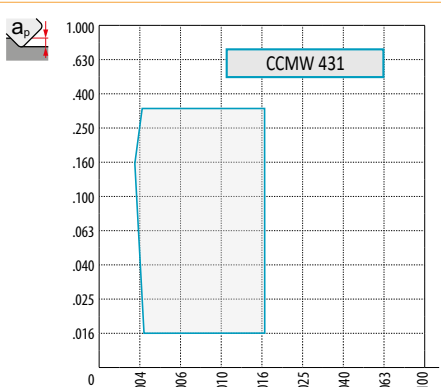







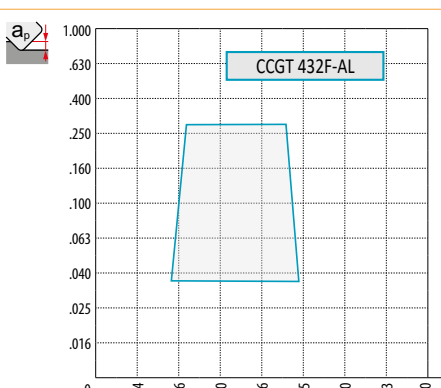






<p><b>371 (RCMT)</b></p> 	 <p>RCMT 2006MOS-371</p>	<table border="1"> <thead> <tr> <th>P</th> <th>M</th> <th>K</th> <th>N</th> <th>S</th> <th>H</th> </tr> </thead> <tbody> <tr> <td>■</td> <td>□</td> <td>■</td> <td>■</td> <td>■</td> <td>■</td> </tr> <tr> <td><math>f</math></td> <td colspan="5">.008 – .047</td> </tr> <tr> <td><math>a_p</math></td> <td colspan="5">.039 – .197</td> </tr> <tr> <td colspan="6" style="text-align: center;">  </td> </tr> <tr> <td colspan="6" style="text-align: center;">  </td> </tr> <tr> <td colspan="6" style="text-align: center;"> <b>?</b> RCMT                 </td> </tr> </tbody> </table>	P	M	K	N	S	H	■	□	■	■	■	■	$f$	.008 – .047					$a_p$	.039 – .197																	<b>?</b> RCMT					
P	M	K	N	S	H																																							
■	□	■	■	■	■																																							
$f$	.008 – .047																																											
$a_p$	.039 – .197																																											
																																												
																																												
<b>?</b> RCMT																																												
<p><b>372 (RCMT)</b></p> 	 <p>RCMT 2507MOS-372</p>	<table border="1"> <thead> <tr> <th>P</th> <th>M</th> <th>K</th> <th>N</th> <th>S</th> <th>H</th> </tr> </thead> <tbody> <tr> <td>■</td> <td>□</td> <td>■</td> <td>■</td> <td>■</td> <td>■</td> </tr> <tr> <td><math>f</math></td> <td colspan="5">.008 – .047</td> </tr> <tr> <td><math>a_p</math></td> <td colspan="5">.039 – .236</td> </tr> <tr> <td colspan="6" style="text-align: center;">  </td> </tr> <tr> <td colspan="6" style="text-align: center;">  </td> </tr> <tr> <td colspan="6" style="text-align: center;"> <b>?</b> RCMT                 </td> </tr> </tbody> </table>	P	M	K	N	S	H	■	□	■	■	■	■	$f$	.008 – .047					$a_p$	.039 – .236																	<b>?</b> RCMT					
P	M	K	N	S	H																																							
■	□	■	■	■	■																																							
$f$	.008 – .047																																											
$a_p$	.039 – .236																																											
																																												
																																												
<b>?</b> RCMT																																												
<p><b>...W</b></p> 	 <p>CCMW 431</p>	<table border="1"> <thead> <tr> <th>P</th> <th>M</th> <th>K</th> <th>N</th> <th>S</th> <th>H</th> </tr> </thead> <tbody> <tr> <td>▣</td> <td>□</td> <td>■</td> <td>■</td> <td>■</td> <td>▣</td> </tr> <tr> <td><math>f</math></td> <td colspan="5">.004 – .016</td> </tr> <tr> <td><math>a_p</math></td> <td colspan="5">.016 – .331</td> </tr> <tr> <td colspan="6" style="text-align: center;">  </td> </tr> <tr> <td colspan="6" style="text-align: center;">  </td> </tr> <tr> <td colspan="6" style="text-align: center;"> <b>?</b> CCMW, DCMW, SCMW, RCMW, TCMW, VCMW                 </td> </tr> </tbody> </table>	P	M	K	N	S	H	▣	□	■	■	■	▣	$f$	.004 – .016					$a_p$	.016 – .331																	<b>?</b> CCMW, DCMW, SCMW, RCMW, TCMW, VCMW					
P	M	K	N	S	H																																							
▣	□	■	■	■	▣																																							
$f$	.004 – .016																																											
$a_p$	.016 – .331																																											
																																												
																																												
<b>?</b> CCMW, DCMW, SCMW, RCMW, TCMW, VCMW																																												
<p><b>AL</b></p> 	 <p>CCGT 432F-AL</p>	<table border="1"> <thead> <tr> <th>P</th> <th>M</th> <th>K</th> <th>N</th> <th>S</th> <th>H</th> </tr> </thead> <tbody> <tr> <td>■</td> <td>■</td> <td>■</td> <td>■</td> <td>■</td> <td>■</td> </tr> <tr> <td><math>f</math></td> <td colspan="5">.002 – .024</td> </tr> <tr> <td><math>a_p</math></td> <td colspan="5">.008 – .276</td> </tr> <tr> <td colspan="6" style="text-align: center;">  </td> </tr> <tr> <td colspan="6" style="text-align: center;">  </td> </tr> <tr> <td colspan="6" style="text-align: center;"> <b>?</b> CCGT, DCGT, SCGT, RCGT, TCGT, VCGT, WCGT                 </td> </tr> </tbody> </table>	P	M	K	N	S	H	■	■	■	■	■	■	$f$	.002 – .024					$a_p$	.008 – .276																	<b>?</b> CCGT, DCGT, SCGT, RCGT, TCGT, VCGT, WCGT					
P	M	K	N	S	H																																							
■	■	■	■	■	■																																							
$f$	.002 – .024																																											
$a_p$	.008 – .276																																											
																																												
																																												
<b>?</b> CCGT, DCGT, SCGT, RCGT, TCGT, VCGT, WCGT																																												

Table 3  
 Tabla 3  
 Tableau 3

GEOMETRY OF CUTTING INSERTS – CLAMPING DESIGNATION ISO S  
 GEOMETRÍA DE PLAQUITAS DE CORTE – TIPO DE FIJACIÓN ISO S  
 GÉOMÉTRIE DES PLAQUETTES – FIXATION DE TYPE ISO S

DR4 (SCMT)			<table border="1"> <thead> <tr> <th>P</th> <th>M</th> <th>K</th> <th>N</th> <th>S</th> <th>H</th> </tr> </thead> <tbody> <tr> <td>■</td> <td>▣</td> <td>■</td> <td>■</td> <td>■</td> <td>■</td> </tr> <tr> <td><math>f</math></td> <td colspan="5">.028 – .055</td> </tr> <tr> <td><math>a_p</math></td> <td colspan="5">.157 – .709</td> </tr> <tr> <td colspan="6" style="text-align: center;"> </td> </tr> <tr> <td colspan="6" style="text-align: center;"> </td> </tr> <tr> <td colspan="6" style="text-align: center;"> <b>?</b> SCMT         </td> </tr> </tbody> </table>	P	M	K	N	S	H	■	▣	■	■	■	■	$f$	.028 – .055					$a_p$	.157 – .709																	<b>?</b> SCMT					
	P	M	K	N	S	H																																							
■	▣	■	■	■	■																																								
$f$	.028 – .055																																												
$a_p$	.157 – .709																																												
<b>?</b> SCMT																																													
FF			<table border="1"> <thead> <tr> <th>P</th> <th>M</th> <th>K</th> <th>N</th> <th>S</th> <th>H</th> </tr> </thead> <tbody> <tr> <td>■</td> <td>■</td> <td>▣</td> <td>□</td> <td>□</td> <td>■</td> </tr> <tr> <td><math>f</math></td> <td colspan="5">.002 – .009</td> </tr> <tr> <td><math>a_p</math></td> <td colspan="5">.008 – .079</td> </tr> <tr> <td colspan="6" style="text-align: center;"> </td> </tr> <tr> <td colspan="6" style="text-align: center;"> </td> </tr> <tr> <td colspan="6" style="text-align: center;"> <b>?</b> CCMT, DCMT         </td> </tr> </tbody> </table>	P	M	K	N	S	H	■	■	▣	□	□	■	$f$	.002 – .009					$a_p$	.008 – .079																	<b>?</b> CCMT, DCMT					
	P	M	K	N	S	H																																							
■	■	▣	□	□	■																																								
$f$	.002 – .009																																												
$a_p$	.008 – .079																																												
<b>?</b> CCMT, DCMT																																													
FF2			<table border="1"> <thead> <tr> <th>P</th> <th>M</th> <th>K</th> <th>N</th> <th>S</th> <th>H</th> </tr> </thead> <tbody> <tr> <td>■</td> <td>▣</td> <td>■</td> <td>■</td> <td>■</td> <td>■</td> </tr> <tr> <td><math>f</math></td> <td colspan="5">.001 – .011</td> </tr> <tr> <td><math>a_p</math></td> <td colspan="5">.006 – .118</td> </tr> <tr> <td colspan="6" style="text-align: center;"> </td> </tr> <tr> <td colspan="6" style="text-align: center;"> </td> </tr> <tr> <td colspan="6" style="text-align: center;"> <b>?</b> CCMT, CCGT, DCGT, DCMT, SCMT, TCMT, VBMT, VCGT, VCGX, WCGT         </td> </tr> </tbody> </table>	P	M	K	N	S	H	■	▣	■	■	■	■	$f$	.001 – .011					$a_p$	.006 – .118																	<b>?</b> CCMT, CCGT, DCGT, DCMT, SCMT, TCMT, VBMT, VCGT, VCGX, WCGT					
	P	M	K	N	S	H																																							
■	▣	■	■	■	■																																								
$f$	.001 – .011																																												
$a_p$	.006 – .118																																												
<b>?</b> CCMT, CCGT, DCGT, DCMT, SCMT, TCMT, VBMT, VCGT, VCGX, WCGT																																													
FM			<table border="1"> <thead> <tr> <th>P</th> <th>M</th> <th>K</th> <th>N</th> <th>S</th> <th>H</th> </tr> </thead> <tbody> <tr> <td>■</td> <td>■</td> <td>▣</td> <td>■</td> <td>□</td> <td>■</td> </tr> <tr> <td><math>f</math></td> <td colspan="5">.003 – .018</td> </tr> <tr> <td><math>a_p</math></td> <td colspan="5">.008 – .157</td> </tr> <tr> <td colspan="6" style="text-align: center;"> </td> </tr> <tr> <td colspan="6" style="text-align: center;"> </td> </tr> <tr> <td colspan="6" style="text-align: center;"> <b>?</b> CCMT, DCMT, SCMT, TCMT, VBMT, WCMT         </td> </tr> </tbody> </table>	P	M	K	N	S	H	■	■	▣	■	□	■	$f$	.003 – .018					$a_p$	.008 – .157																	<b>?</b> CCMT, DCMT, SCMT, TCMT, VBMT, WCMT					
	P	M	K	N	S	H																																							
■	■	▣	■	□	■																																								
$f$	.003 – .018																																												
$a_p$	.008 – .157																																												
<b>?</b> CCMT, DCMT, SCMT, TCMT, VBMT, WCMT																																													

Table 3  
 Tabla 3  
 Tableau 3

GEOMETRY OF CUTTING INSERTS – CLAMPING DESIGNATION ISO S  
 GEOMETRÍA DE PLAQUITAS DE CORTE – TIPO DE FIJACIÓN ISO S  
 GÉOMÉTRIE DES PLAQUETTES – FIXATION DE TYPE ISO S


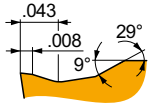
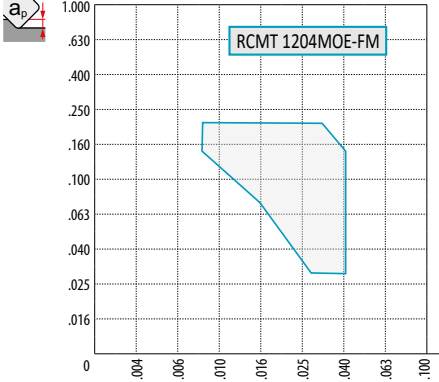






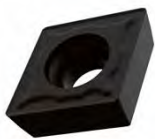
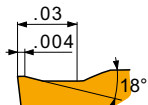
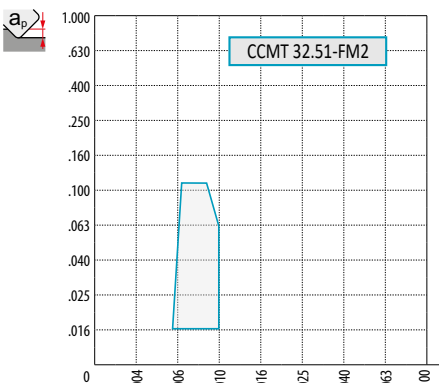







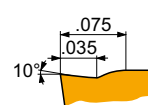
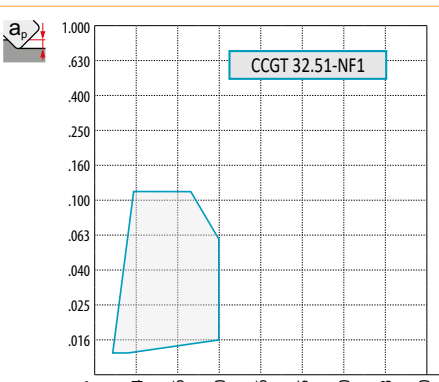








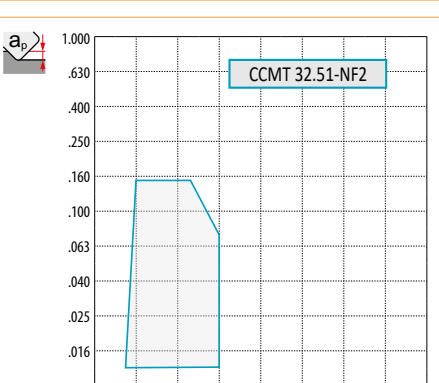






<p><b>FM (RCMT)</b></p>  	 <p>RCMT 1204MOE-FM</p>	<table border="1"> <thead> <tr> <th>P</th> <th>M</th> <th>K</th> <th>N</th> <th>S</th> <th>H</th> </tr> </thead> <tbody> <tr> <td>■</td> <td>■</td> <td>▣</td> <td>■</td> <td>□</td> <td>■</td> </tr> <tr> <td><math>f</math></td> <td colspan="5">.004 – .039</td> </tr> <tr> <td><math>a_p</math></td> <td colspan="5">.012 – .189</td> </tr> <tr> <td colspan="6" style="text-align: center;">  </td> </tr> <tr> <td colspan="6" style="text-align: center;">  </td> </tr> <tr> <td><b>?</b></td> <td colspan="5">RCMT</td> </tr> </tbody> </table>	P	M	K	N	S	H	■	■	▣	■	□	■	$f$	.004 – .039					$a_p$	.012 – .189																	<b>?</b>	RCMT				
P	M	K	N	S	H																																							
■	■	▣	■	□	■																																							
$f$	.004 – .039																																											
$a_p$	.012 – .189																																											
																																												
																																												
<b>?</b>	RCMT																																											
<p><b>FM2</b></p>  	 <p>CCMT 32.51-FM2</p>	<table border="1"> <thead> <tr> <th>P</th> <th>M</th> <th>K</th> <th>N</th> <th>S</th> <th>H</th> </tr> </thead> <tbody> <tr> <td>■</td> <td>▣</td> <td>■</td> <td>■</td> <td>□</td> <td>□</td> </tr> <tr> <td><math>f</math></td> <td colspan="5">.002 – .016</td> </tr> <tr> <td><math>a_p</math></td> <td colspan="5">.008 – .157</td> </tr> <tr> <td colspan="6" style="text-align: center;">  </td> </tr> <tr> <td colspan="6" style="text-align: center;">  </td> </tr> <tr> <td><b>?</b></td> <td colspan="5">CCMT, DCMT, ECMT, SCMT, TCMT, VBMT, VCGT</td> </tr> </tbody> </table>	P	M	K	N	S	H	■	▣	■	■	□	□	$f$	.002 – .016					$a_p$	.008 – .157																	<b>?</b>	CCMT, DCMT, ECMT, SCMT, TCMT, VBMT, VCGT				
P	M	K	N	S	H																																							
■	▣	■	■	□	□																																							
$f$	.002 – .016																																											
$a_p$	.008 – .157																																											
																																												
																																												
<b>?</b>	CCMT, DCMT, ECMT, SCMT, TCMT, VBMT, VCGT																																											
<p><b>NF1</b></p>  	 <p>CCGT 32.51-NF1</p>	<table border="1"> <thead> <tr> <th>P</th> <th>M</th> <th>K</th> <th>N</th> <th>S</th> <th>H</th> </tr> </thead> <tbody> <tr> <td>■</td> <td>■</td> <td>▣</td> <td>■</td> <td>■</td> <td>■</td> </tr> <tr> <td><math>f</math></td> <td colspan="5">.002 – .014</td> </tr> <tr> <td><math>a_p</math></td> <td colspan="5">.012 – .138</td> </tr> <tr> <td colspan="6" style="text-align: center;">  </td> </tr> <tr> <td colspan="6" style="text-align: center;">  </td> </tr> <tr> <td><b>?</b></td> <td colspan="5">CCGT, DCGT, SCGT, TCGT</td> </tr> </tbody> </table>	P	M	K	N	S	H	■	■	▣	■	■	■	$f$	.002 – .014					$a_p$	.012 – .138																	<b>?</b>	CCGT, DCGT, SCGT, TCGT				
P	M	K	N	S	H																																							
■	■	▣	■	■	■																																							
$f$	.002 – .014																																											
$a_p$	.012 – .138																																											
																																												
																																												
<b>?</b>	CCGT, DCGT, SCGT, TCGT																																											
<p><b>NF2</b></p>  	 <p>CCMT 32.51-NF2</p>	<table border="1"> <thead> <tr> <th>P</th> <th>M</th> <th>K</th> <th>N</th> <th>S</th> <th>H</th> </tr> </thead> <tbody> <tr> <td>▣</td> <td>■</td> <td>▣</td> <td>■</td> <td>■</td> <td>■</td> </tr> <tr> <td><math>f</math></td> <td colspan="5">.002 – .018</td> </tr> <tr> <td><math>a_p</math></td> <td colspan="5">.008 – .157</td> </tr> <tr> <td colspan="6" style="text-align: center;">  </td> </tr> <tr> <td colspan="6" style="text-align: center;">  </td> </tr> <tr> <td><b>?</b></td> <td colspan="5">CCMT, EPMT, SCMT, TCMT, VCGT</td> </tr> </tbody> </table>	P	M	K	N	S	H	▣	■	▣	■	■	■	$f$	.002 – .018					$a_p$	.008 – .157																	<b>?</b>	CCMT, EPMT, SCMT, TCMT, VCGT				
P	M	K	N	S	H																																							
▣	■	▣	■	■	■																																							
$f$	.002 – .018																																											
$a_p$	.008 – .157																																											
																																												
																																												
<b>?</b>	CCMT, EPMT, SCMT, TCMT, VCGT																																											

Table 3  
 Tabla 3  
 Tableau 3

GEOMETRY OF CUTTING INSERTS – CLAMPING DESIGNATION ISO S  
 GEOMETRÍA DE PLAQUITAS DE CORTE – TIPO DE FIJACIÓN ISO S  
 GÉOMÉTRIE DES PLAQUETTES – FIXATION DE TYPE ISO S

OR (SCMT)		<p>SCMT 866-OR            SCMT 1268-OR</p>	<table border="1"> <thead> <tr> <th>P</th> <th>M</th> <th>K</th> <th>N</th> <th>S</th> <th>H</th> </tr> </thead> <tbody> <tr> <td>■</td> <td>■</td> <td>■</td> <td>■</td> <td>□</td> <td>□</td> </tr> </tbody> </table>	P	M	K	N	S	H	■	■	■	■	□	□
	P		M	K	N	S	H								
■	■	■	■	□	□										
	<p><math>f</math></p> <p>.024 – .079</p> <p><math>a_p</math></p> <p>.118 – .945</p> <p>SCMT</p>														
RF		<p>CCMT 32.51-RF</p>	<table border="1"> <thead> <tr> <th>P</th> <th>M</th> <th>K</th> <th>N</th> <th>S</th> <th>H</th> </tr> </thead> <tbody> <tr> <td>■</td> <td>■</td> <td>■</td> <td>■</td> <td>□</td> <td>□</td> </tr> </tbody> </table>	P	M	K	N	S	H	■	■	■	■	□	□
	P		M	K	N	S	H								
■	■	■	■	□	□										
<table border="1"> <thead> <tr> <th>I.C.</th> <th>R</th> </tr> </thead> <tbody> <tr> <td>.25</td> <td>.039</td> </tr> <tr> <td>.375</td> <td>.059</td> </tr> <tr> <td>.5</td> <td>.098</td> </tr> </tbody> </table>	I.C.	R	.25	.039	.375	.059	.5	.098	<p><math>f</math></p> <p>.004 – .024</p> <p><math>a_p</math></p> <p>.031 – .315</p> <p>CCMT, DCMT, SCMT, TCMT, WCMT</p>						
I.C.	R														
.25	.039														
.375	.059														
.5	.098														
RM		<p>CCMT 432-RM</p>	<table border="1"> <thead> <tr> <th>P</th> <th>M</th> <th>K</th> <th>N</th> <th>S</th> <th>H</th> </tr> </thead> <tbody> <tr> <td>■</td> <td>■</td> <td>■</td> <td>■</td> <td>■</td> <td>□</td> </tr> </tbody> </table>	P	M	K	N	S	H	■	■	■	■	■	□
	P		M	K	N	S	H								
■	■	■	■	■	□										
	<p><math>f</math></p> <p>.004 – .020</p> <p><math>a_p</math></p> <p>.031 – .177</p> <p>CCMT, DCMT, SCMT, TCMT, VBMT</p>														
RM3		<p>CCMT 432-RM3</p>	<table border="1"> <thead> <tr> <th>P</th> <th>M</th> <th>K</th> <th>N</th> <th>S</th> <th>H</th> </tr> </thead> <tbody> <tr> <td>■</td> <td>■</td> <td>■</td> <td>■</td> <td>□</td> <td>□</td> </tr> </tbody> </table>	P	M	K	N	S	H	■	■	■	■	□	□
	P		M	K	N	S	H								
■	■	■	■	□	□										
	<p><math>f</math></p> <p>.006 – .035</p> <p><math>a_p</math></p> <p>.016 – .236</p> <p>CCMT, SCMT, TCMT, RCMT</p>														

Table 3  
 Tabla 3  
 Tableau 3

GEOMETRY OF CUTTING INSERTS – CLAMPING DESIGNATION ISO S  
 GEOMETRÍA DE PLAQUITAS DE CORTE – TIPO DE FIJACIÓN ISO S  
 GÉOMÉTRIE DES PLAQUETTES – FIXATION DE TYPE ISO S

SF2				<table border="1"> <thead> <tr> <th>P</th> <th>M</th> <th>K</th> <th>N</th> <th>S</th> <th>H</th> </tr> </thead> <tbody> <tr> <td></td> <td>■</td> <td></td> <td>■</td> <td>■</td> <td></td> </tr> <tr> <td><math>f</math></td> <td colspan="5">.001 – .011</td> </tr> <tr> <td><math>a_p</math></td> <td colspan="5">.004 – .098</td> </tr> </tbody> </table>	P	M	K	N	S	H		■		■	■		$f$	.001 – .011					$a_p$	.004 – .098				
	P	M	K	N	S	H																						
	■		■	■																								
$f$	.001 – .011																											
$a_p$	.004 – .098																											
				<table border="1"> <thead> <tr> <th>P</th> <th>M</th> <th>K</th> <th>N</th> <th>S</th> <th>H</th> </tr> </thead> <tbody> <tr> <td></td> <td>■</td> <td></td> <td>■</td> <td>■</td> <td></td> </tr> <tr> <td><math>f</math></td> <td colspan="5">.001 – .014</td> </tr> <tr> <td><math>a_p</math></td> <td colspan="5">.008 – .157</td> </tr> </tbody> </table>	P	M	K	N	S	H		■		■	■		$f$	.001 – .014					$a_p$	.008 – .157				
P	M	K	N	S	H																							
	■		■	■																								
$f$	.001 – .014																											
$a_p$	.008 – .157																											
SF3				<table border="1"> <thead> <tr> <th>P</th> <th>M</th> <th>K</th> <th>N</th> <th>S</th> <th>H</th> </tr> </thead> <tbody> <tr> <td></td> <td>■</td> <td></td> <td>■</td> <td>■</td> <td></td> </tr> <tr> <td><math>f</math></td> <td colspan="5">.001 – .014</td> </tr> <tr> <td><math>a_p</math></td> <td colspan="5">.008 – .157</td> </tr> </tbody> </table>	P	M	K	N	S	H		■		■	■		$f$	.001 – .014					$a_p$	.008 – .157				
	P	M	K	N	S	H																						
	■		■	■																								
$f$	.001 – .014																											
$a_p$	.008 – .157																											
				<table border="1"> <thead> <tr> <th>P</th> <th>M</th> <th>K</th> <th>N</th> <th>S</th> <th>H</th> </tr> </thead> <tbody> <tr> <td>■</td> <td>■</td> <td>□</td> <td>□</td> <td>■</td> <td></td> </tr> <tr> <td><math>f</math></td> <td colspan="5">.003 – .018</td> </tr> <tr> <td><math>a_p</math></td> <td colspan="5">.016 – .157</td> </tr> </tbody> </table>	P	M	K	N	S	H	■	■	□	□	■		$f$	.003 – .018					$a_p$	.016 – .157				
P	M	K	N	S	H																							
■	■	□	□	■																								
$f$	.003 – .018																											
$a_p$	.016 – .157																											
SI				<table border="1"> <thead> <tr> <th>P</th> <th>M</th> <th>K</th> <th>N</th> <th>S</th> <th>H</th> </tr> </thead> <tbody> <tr> <td>■</td> <td>■</td> <td>□</td> <td>□</td> <td>■</td> <td></td> </tr> <tr> <td><math>f</math></td> <td colspan="5">.003 – .018</td> </tr> <tr> <td><math>a_p</math></td> <td colspan="5">.016 – .157</td> </tr> </tbody> </table>	P	M	K	N	S	H	■	■	□	□	■		$f$	.003 – .018					$a_p$	.016 – .157				
	P	M	K	N	S	H																						
■	■	□	□	■																								
$f$	.003 – .018																											
$a_p$	.016 – .157																											
				<table border="1"> <thead> <tr> <th>P</th> <th>M</th> <th>K</th> <th>N</th> <th>S</th> <th>H</th> </tr> </thead> <tbody> <tr> <td>■</td> <td>■</td> <td>■</td> <td></td> <td></td> <td></td> </tr> <tr> <td><math>f</math></td> <td colspan="5">.024 – .079</td> </tr> <tr> <td><math>a_p</math></td> <td colspan="5">.118 – .945</td> </tr> </tbody> </table>	P	M	K	N	S	H	■	■	■				$f$	.024 – .079					$a_p$	.118 – .945				
P	M	K	N	S	H																							
■	■	■																										
$f$	.024 – .079																											
$a_p$	.118 – .945																											
SR (SCMT)				<table border="1"> <thead> <tr> <th>P</th> <th>M</th> <th>K</th> <th>N</th> <th>S</th> <th>H</th> </tr> </thead> <tbody> <tr> <td>■</td> <td>■</td> <td>■</td> <td></td> <td></td> <td></td> </tr> <tr> <td><math>f</math></td> <td colspan="5">.024 – .079</td> </tr> <tr> <td><math>a_p</math></td> <td colspan="5">.118 – .945</td> </tr> </tbody> </table>	P	M	K	N	S	H	■	■	■				$f$	.024 – .079					$a_p$	.118 – .945				
	P	M	K	N	S	H																						
■	■	■																										
$f$	.024 – .079																											
$a_p$	.118 – .945																											
				<table border="1"> <thead> <tr> <th>P</th> <th>M</th> <th>K</th> <th>N</th> <th>S</th> <th>H</th> </tr> </thead> <tbody> <tr> <td>■</td> <td>■</td> <td>■</td> <td></td> <td></td> <td></td> </tr> <tr> <td><math>f</math></td> <td colspan="5">.024 – .079</td> </tr> <tr> <td><math>a_p</math></td> <td colspan="5">.118 – .945</td> </tr> </tbody> </table>	P	M	K	N	S	H	■	■	■				$f$	.024 – .079					$a_p$	.118 – .945				
P	M	K	N	S	H																							
■	■	■																										
$f$	.024 – .079																											
$a_p$	.118 – .945																											



Table 3  
 Tabla 3  
 Tableau 3

GEOMETRY OF CUTTING INSERTS – CLAMPING DESIGNATION ISO S  
 GEOMETRÍA DE PLAQUITAS DE CORTE – TIPO DE FIJACIÓN ISO S  
 GÉOMÉTRIE DES PLAQUETTES – FIXATION DE TYPE ISO S


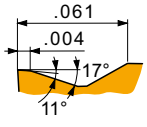
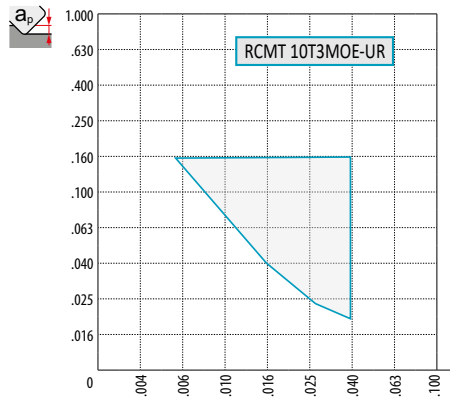






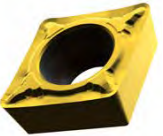
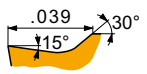
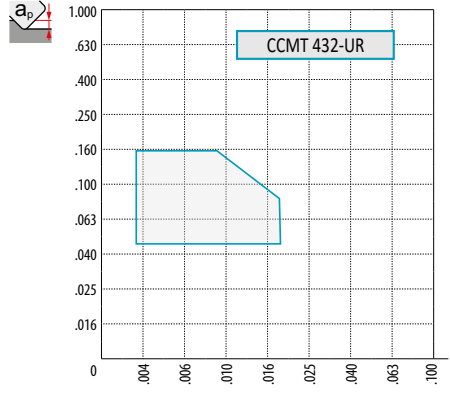







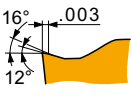
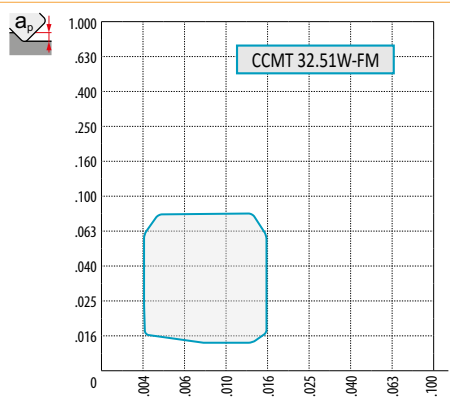






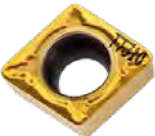
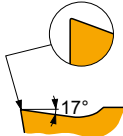
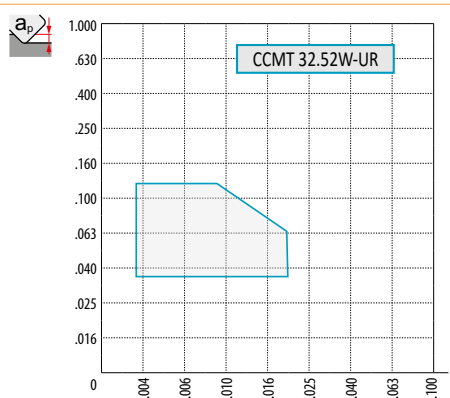






<p>UR (RCMT)</p>  	 <p>RCMT 10T3MOE-UR</p>	<table border="1"> <thead> <tr> <th>P</th> <th>M</th> <th>K</th> <th>N</th> <th>S</th> <th>H</th> </tr> </thead> <tbody> <tr> <td>■</td> <td>■</td> <td>■</td> <td>□</td> <td></td> <td></td> </tr> <tr> <td><math>f</math></td> <td colspan="5">.006 – .039</td> </tr> <tr> <td><math>a_p</math></td> <td colspan="5">.020 – .197</td> </tr> <tr> <td colspan="6" style="text-align: center;">  </td> </tr> <tr> <td colspan="6" style="text-align: center;">  </td> </tr> <tr> <td>?</td> <td colspan="5">RCMT</td> </tr> </tbody> </table>	P	M	K	N	S	H	■	■	■	□			$f$	.006 – .039					$a_p$	.020 – .197																	?	RCMT				
P	M	K	N	S	H																																							
■	■	■	□																																									
$f$	.006 – .039																																											
$a_p$	.020 – .197																																											
																																												
																																												
?	RCMT																																											
<p>UR</p>  	 <p>CCMT 432-UR</p>	<table border="1"> <thead> <tr> <th>P</th> <th>M</th> <th>K</th> <th>N</th> <th>S</th> <th>H</th> </tr> </thead> <tbody> <tr> <td>■</td> <td>■</td> <td>■</td> <td>□</td> <td></td> <td></td> </tr> <tr> <td><math>f</math></td> <td colspan="5">.004 – .016</td> </tr> <tr> <td><math>a_p</math></td> <td colspan="5">.039 – .157</td> </tr> <tr> <td colspan="6" style="text-align: center;">  </td> </tr> <tr> <td colspan="6" style="text-align: center;">  </td> </tr> <tr> <td>?</td> <td colspan="5">CCMT, DCMT, RCMT, SCMT, TCMT, VCMT, VBMT, WCMT</td> </tr> </tbody> </table>	P	M	K	N	S	H	■	■	■	□			$f$	.004 – .016					$a_p$	.039 – .157																	?	CCMT, DCMT, RCMT, SCMT, TCMT, VCMT, VBMT, WCMT				
P	M	K	N	S	H																																							
■	■	■	□																																									
$f$	.004 – .016																																											
$a_p$	.039 – .157																																											
																																												
																																												
?	CCMT, DCMT, RCMT, SCMT, TCMT, VCMT, VBMT, WCMT																																											
<p>W-FM</p>  	 <p>CCMT 32.51W-FM</p>	<table border="1"> <thead> <tr> <th>P</th> <th>M</th> <th>K</th> <th>N</th> <th>S</th> <th>H</th> </tr> </thead> <tbody> <tr> <td>■</td> <td>■</td> <td>□</td> <td></td> <td>□</td> <td></td> </tr> <tr> <td><math>f</math></td> <td colspan="5">.004 – .016</td> </tr> <tr> <td><math>a_p</math></td> <td colspan="5">.012 – .118</td> </tr> <tr> <td colspan="6" style="text-align: center;">  </td> </tr> <tr> <td colspan="6" style="text-align: center;">  </td> </tr> <tr> <td>?</td> <td colspan="5">CCMT, DCMX</td> </tr> </tbody> </table>	P	M	K	N	S	H	■	■	□		□		$f$	.004 – .016					$a_p$	.012 – .118																	?	CCMT, DCMX				
P	M	K	N	S	H																																							
■	■	□		□																																								
$f$	.004 – .016																																											
$a_p$	.012 – .118																																											
																																												
																																												
?	CCMT, DCMX																																											
<p>W-UR</p>  	 <p>CCMT 32.52W-UR</p>	<table border="1"> <thead> <tr> <th>P</th> <th>M</th> <th>K</th> <th>N</th> <th>S</th> <th>H</th> </tr> </thead> <tbody> <tr> <td>■</td> <td>■</td> <td>■</td> <td>□</td> <td></td> <td></td> </tr> <tr> <td><math>f</math></td> <td colspan="5">.003 – .020</td> </tr> <tr> <td><math>a_p</math></td> <td colspan="5">.016 – .118</td> </tr> <tr> <td colspan="6" style="text-align: center;">  </td> </tr> <tr> <td colspan="6" style="text-align: center;">  </td> </tr> <tr> <td>?</td> <td colspan="5">CCMT</td> </tr> </tbody> </table>	P	M	K	N	S	H	■	■	■	□			$f$	.003 – .020					$a_p$	.016 – .118																	?	CCMT				
P	M	K	N	S	H																																							
■	■	■	□																																									
$f$	.003 – .020																																											
$a_p$	.016 – .118																																											
																																												
																																												
?	CCMT																																											

Table 3  
Tabla 3  
Tableau 3

GEOMETRY OF CUTTING INSERTS – CLAMPING DESIGNATION ISO C  
 GEOMETRÍA DE PLAQUITAS DE CORTE – TIPO DE FIJACIÓN ISO C  
 GÉOMÉTRIE DES PLAQUETTES – FIXATION DE TYPE ISO C

46		<p>TPMR 221-46</p>	<table border="1"> <thead> <tr> <th>P</th> <th>M</th> <th>K</th> <th>N</th> <th>S</th> <th>H</th> </tr> </thead> <tbody> <tr> <td>■</td> <td>▣</td> <td>■</td> <td>■</td> <td>■</td> <td>■</td> </tr> <tr> <td colspan="2">f</td> <td colspan="4">.004 – .012</td> </tr> <tr> <td colspan="2">ap</td> <td colspan="4">.039 – .118</td> </tr> <tr> <td colspan="6" style="text-align: center;"> </td> </tr> <tr> <td colspan="6" style="text-align: center;"> </td> </tr> <tr> <td colspan="3"></td> <td colspan="3"> <p><b>?</b> SPMR, TPMR</p> </td> </tr> </tbody> </table>	P	M	K	N	S	H	■	▣	■	■	■	■	f		.004 – .012				ap		.039 – .118																			<p><b>?</b> SPMR, TPMR</p>		
	P			M	K	N	S	H																																					
■	▣	■	■	■	■																																								
f		.004 – .012																																											
ap		.039 – .118																																											
			<p><b>?</b> SPMR, TPMR</p>																																										
47		<p>TPMR 322-47</p>	<table border="1"> <thead> <tr> <th>P</th> <th>M</th> <th>K</th> <th>N</th> <th>S</th> <th>H</th> </tr> </thead> <tbody> <tr> <td>■</td> <td>▣</td> <td>■</td> <td>■</td> <td>■</td> <td>■</td> </tr> <tr> <td colspan="2">f</td> <td colspan="4">.004 – .016</td> </tr> <tr> <td colspan="2">ap</td> <td colspan="4">.031 – .157</td> </tr> <tr> <td colspan="6" style="text-align: center;"> </td> </tr> <tr> <td colspan="6" style="text-align: center;"> </td> </tr> <tr> <td colspan="3"></td> <td colspan="3"> <p><b>?</b> TPMR</p> </td> </tr> </tbody> </table>	P	M	K	N	S	H	■	▣	■	■	■	■	f		.004 – .016				ap		.031 – .157																			<p><b>?</b> TPMR</p>		
	P			M	K	N	S	H																																					
■	▣	■	■	■	■																																								
f		.004 – .016																																											
ap		.031 – .157																																											
			<p><b>?</b> TPMR</p>																																										
48		<p>SPMR 422-48</p>	<table border="1"> <thead> <tr> <th>P</th> <th>M</th> <th>K</th> <th>N</th> <th>S</th> <th>H</th> </tr> </thead> <tbody> <tr> <td>■</td> <td>▣</td> <td>■</td> <td>■</td> <td>■</td> <td>■</td> </tr> <tr> <td colspan="2">f</td> <td colspan="4">.008 – .024</td> </tr> <tr> <td colspan="2">ap</td> <td colspan="4">.039 – .315</td> </tr> <tr> <td colspan="6" style="text-align: center;"> </td> </tr> <tr> <td colspan="6" style="text-align: center;"> </td> </tr> <tr> <td colspan="3"></td> <td colspan="3"> <p><b>?</b> SPMR</p> </td> </tr> </tbody> </table>	P	M	K	N	S	H	■	▣	■	■	■	■	f		.008 – .024				ap		.039 – .315																			<p><b>?</b> SPMR</p>		
	P			M	K	N	S	H																																					
■	▣	■	■	■	■																																								
f		.008 – .024																																											
ap		.039 – .315																																											
			<p><b>?</b> SPMR</p>																																										
61		<p>TPMR 322-61</p>	<table border="1"> <thead> <tr> <th>P</th> <th>M</th> <th>K</th> <th>N</th> <th>S</th> <th>H</th> </tr> </thead> <tbody> <tr> <td>■</td> <td>■</td> <td>■</td> <td>■</td> <td>▣</td> <td>■</td> </tr> <tr> <td colspan="2">f</td> <td colspan="4">.012 – .016</td> </tr> <tr> <td colspan="2">ap</td> <td colspan="4">.039 – .209</td> </tr> <tr> <td colspan="6" style="text-align: center;"> </td> </tr> <tr> <td colspan="6" style="text-align: center;"> </td> </tr> <tr> <td colspan="3"></td> <td colspan="3"> <p><b>?</b> TPMR</p> </td> </tr> </tbody> </table>	P	M	K	N	S	H	■	■	■	■	▣	■	f		.012 – .016				ap		.039 – .209																			<p><b>?</b> TPMR</p>		
	P			M	K	N	S	H																																					
■	■	■	■	▣	■																																								
f		.012 – .016																																											
ap		.039 – .209																																											
			<p><b>?</b> TPMR</p>																																										

Table 3  
Tabla 3  
Tableau 3

GEOMETRY OF CUTTING INSERTS – CLAMPING DESIGNATION ISO C  
GEOMETRÍA DE PLAQUITAS DE CORTE – TIPO DE FIJACIÓN ISO C  
GÉOMÉTRIE DES PLAQUETTES – FIXATION DE TYPE ISO C

72								
73								
74								
.PUN			<p>BASED ON TYPE AND SETTING OF THE CHIP BREAKER</p> <p>BASADO EN EL TIPO Y AJUSTE DEL ROMPEVIRUTAS</p> <p>SELON LE TYPE ET LE CHOIX DU BRISE-COPEAUX</p>					

Table 3  
 Tabla 3  
 Tableau 3

GEOMETRY OF CUTTING INSERTS – CLAMPING DESIGNATION ISO X AND G  
 GEOMETRÍA DE PLAQUITAS DE CORTE – TIPO DE FIJACIÓN ISO X Y G  
 GÉOMÉTRIE DES PLAQUETTES – FIXATION DE TYPE ISO X ET G

<p><b>13 F (LCM.)</b></p>		<table border="1"> <thead> <tr> <th>P</th> <th>M</th> <th>K</th> <th>N</th> <th>S</th> <th>H</th> </tr> </thead> <tbody> <tr> <td>■</td> <td>▣</td> <td>■</td> <td>■</td> <td>■</td> <td>■</td> </tr> <tr> <td colspan="6">  See diagram / Consultar diagrama / Voir diagramme         </td> </tr> <tr> <td colspan="6" style="text-align: center;"> </td> </tr> <tr> <td colspan="6" style="text-align: center;"> </td> </tr> <tr> <td colspan="6">  LCMF, LCMR         </td> </tr> </tbody> </table>	P	M	K	N	S	H	■	▣	■	■	■	■	See diagram / Consultar diagrama / Voir diagramme																		LCMF, LCMR					
P	M	K	N	S	H																																	
■	▣	■	■	■	■																																	
See diagram / Consultar diagrama / Voir diagramme																																						
LCMF, LCMR																																						
<p><b>13 MP (LCM.)</b></p>		<table border="1"> <thead> <tr> <th>P</th> <th>M</th> <th>K</th> <th>N</th> <th>S</th> <th>H</th> </tr> </thead> <tbody> <tr> <td>■</td> <td>▣</td> <td>■</td> <td>■</td> <td>■</td> <td>■</td> </tr> <tr> <td colspan="6">  See diagram / Consultar diagrama / Voir diagramme         </td> </tr> <tr> <td colspan="6" style="text-align: center;"> </td> </tr> <tr> <td colspan="6" style="text-align: center;"> </td> </tr> <tr> <td colspan="6">  LCMF, LCMR         </td> </tr> </tbody> </table>	P	M	K	N	S	H	■	▣	■	■	■	■	See diagram / Consultar diagrama / Voir diagramme																		LCMF, LCMR					
P	M	K	N	S	H																																	
■	▣	■	■	■	■																																	
See diagram / Consultar diagrama / Voir diagramme																																						
LCMF, LCMR																																						
<p><b>16 F (LCM.)</b></p>		<table border="1"> <thead> <tr> <th>P</th> <th>M</th> <th>K</th> <th>N</th> <th>S</th> <th>H</th> </tr> </thead> <tbody> <tr> <td>■</td> <td>▣</td> <td>■</td> <td>■</td> <td>■</td> <td>■</td> </tr> <tr> <td colspan="6">  See diagram / Consultar diagrama / Voir diagramme         </td> </tr> <tr> <td colspan="6" style="text-align: center;"> </td> </tr> <tr> <td colspan="6" style="text-align: center;"> </td> </tr> <tr> <td colspan="6">  LCMF, LCMR         </td> </tr> </tbody> </table>	P	M	K	N	S	H	■	▣	■	■	■	■	See diagram / Consultar diagrama / Voir diagramme																		LCMF, LCMR					
P	M	K	N	S	H																																	
■	▣	■	■	■	■																																	
See diagram / Consultar diagrama / Voir diagramme																																						
LCMF, LCMR																																						
<p><b>16 M (LCM.)</b></p>		<table border="1"> <thead> <tr> <th>P</th> <th>M</th> <th>K</th> <th>N</th> <th>S</th> <th>H</th> </tr> </thead> <tbody> <tr> <td>■</td> <td>▣</td> <td>■</td> <td>■</td> <td>■</td> <td>■</td> </tr> <tr> <td colspan="6">  See diagram / Consultar diagrama / Voir diagramme         </td> </tr> <tr> <td colspan="6" style="text-align: center;"> </td> </tr> <tr> <td colspan="6" style="text-align: center;"> </td> </tr> <tr> <td colspan="6">  LCMF, LCMR         </td> </tr> </tbody> </table>	P	M	K	N	S	H	■	▣	■	■	■	■	See diagram / Consultar diagrama / Voir diagramme																		LCMF, LCMR					
P	M	K	N	S	H																																	
■	▣	■	■	■	■																																	
See diagram / Consultar diagrama / Voir diagramme																																						
LCMF, LCMR																																						


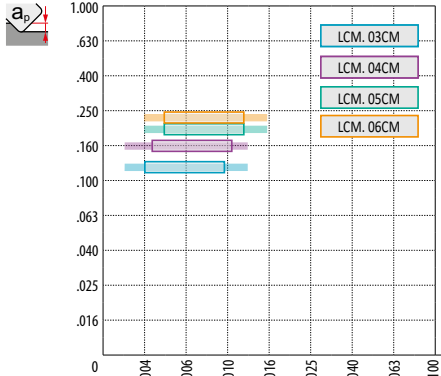
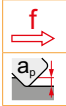
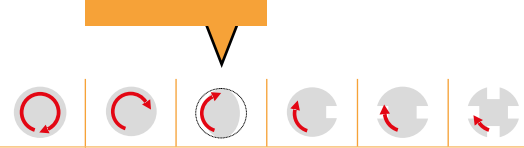

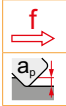
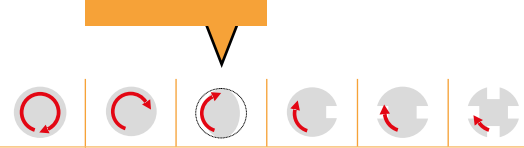

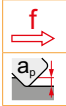
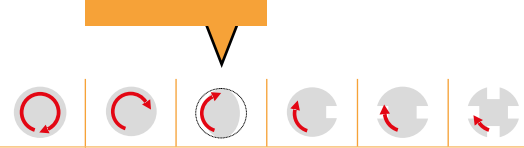


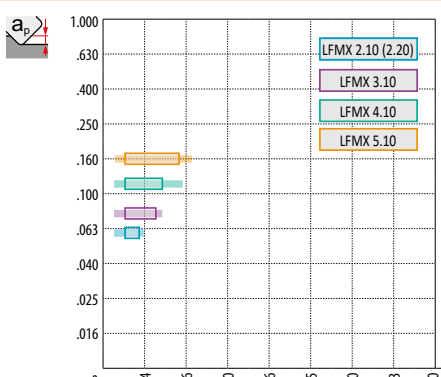
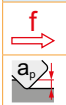
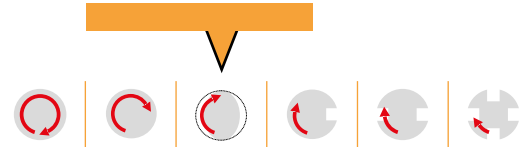

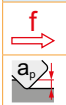
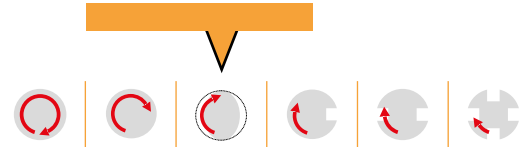

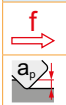
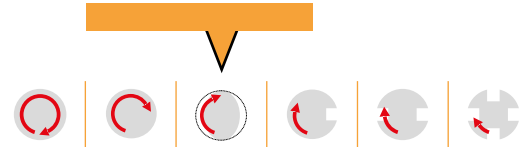


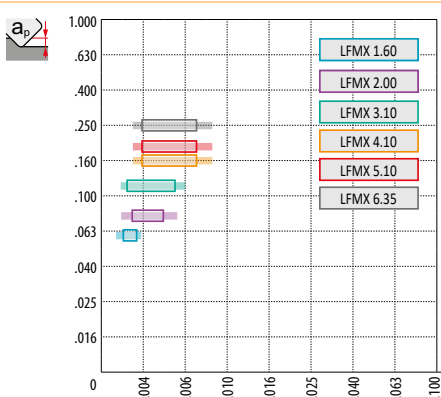
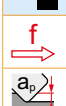
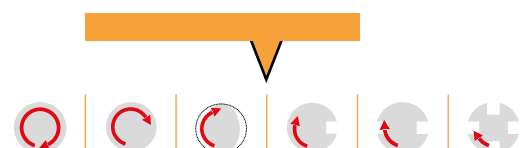

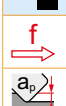
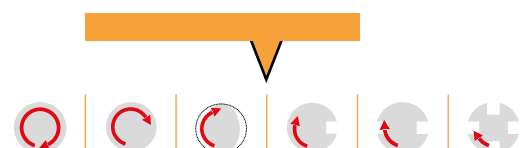

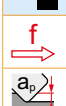
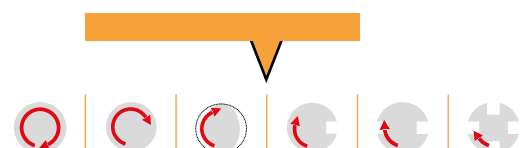


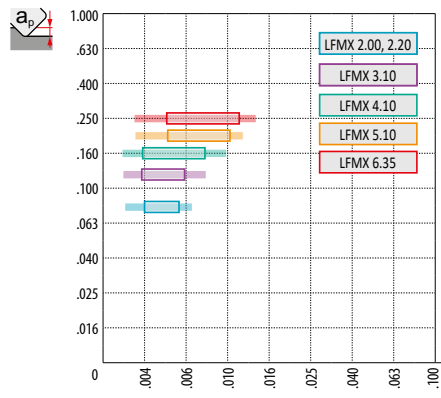

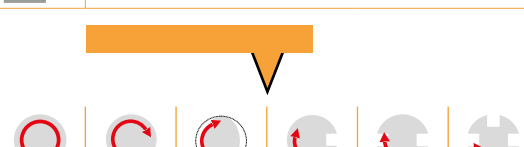


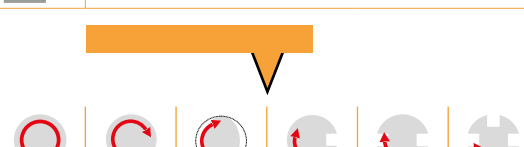


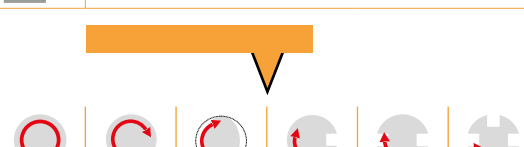

Table 3  
 Tabla 3  
 Tableau 3

GEOMETRY OF CUTTING INSERTS – CLAMPING DESIGNATION ISO X AND G  
 GEOMETRÍA DE PLAQUITAS DE CORTE – TIPO DE FIJACIÓN ISO X Y G  
 GÉOMÉTRIE DES PLAQUETTES – FIXATION DE TYPE ISO X ET G

<p>16 MP (LCM.)</p>			<table border="1"> <thead> <tr> <th>P</th> <th>M</th> <th>K</th> <th>N</th> <th>S</th> <th>H</th> </tr> </thead> <tbody> <tr> <td>■</td> <td>▣</td> <td>■</td> <td></td> <td></td> <td></td> </tr> <tr> <td><math>f</math></td> <td colspan="5">See diagram / Consultar diagrama / Voir diagramme</td> </tr> <tr> <td><math>a_p</math></td> <td colspan="5">See diagram / Consultar diagrama / Voir diagramme</td> </tr> <tr> <td colspan="6" style="text-align: center;"> </td> </tr> <tr> <td colspan="6" style="text-align: center;"> </td> </tr> <tr> <td>?</td> <td colspan="5">LCMF, LCMR</td> </tr> </tbody> </table>	P	M	K	N	S	H	■	▣	■				$f$	See diagram / Consultar diagrama / Voir diagramme					$a_p$	See diagram / Consultar diagrama / Voir diagramme																	?	LCMF, LCMR				
P	M	K	N	S	H																																								
■	▣	■																																											
$f$	See diagram / Consultar diagrama / Voir diagramme																																												
$a_p$	See diagram / Consultar diagrama / Voir diagramme																																												
?	LCMF, LCMR																																												
<p>20 F1 (LCMF)</p>			<table border="1"> <thead> <tr> <th>P</th> <th>M</th> <th>K</th> <th>N</th> <th>S</th> <th>H</th> </tr> </thead> <tbody> <tr> <td>■</td> <td>▣</td> <td>■</td> <td></td> <td></td> <td></td> </tr> <tr> <td><math>f</math></td> <td colspan="5">See diagram / Consultar diagrama / Voir diagramme</td> </tr> <tr> <td><math>a_p</math></td> <td colspan="5">See diagram / Consultar diagrama / Voir diagramme</td> </tr> <tr> <td colspan="6" style="text-align: center;"> </td> </tr> <tr> <td colspan="6" style="text-align: center;"> </td> </tr> <tr> <td>?</td> <td colspan="5">LCMF</td> </tr> </tbody> </table>	P	M	K	N	S	H	■	▣	■				$f$	See diagram / Consultar diagrama / Voir diagramme					$a_p$	See diagram / Consultar diagrama / Voir diagramme																	?	LCMF				
P	M	K	N	S	H																																								
■	▣	■																																											
$f$	See diagram / Consultar diagrama / Voir diagramme																																												
$a_p$	See diagram / Consultar diagrama / Voir diagramme																																												
?	LCMF																																												
<p>20 M2 (LCMF)</p>			<table border="1"> <thead> <tr> <th>P</th> <th>M</th> <th>K</th> <th>N</th> <th>S</th> <th>H</th> </tr> </thead> <tbody> <tr> <td>■</td> <td>■</td> <td>▣</td> <td>□</td> <td>▣</td> <td>□</td> </tr> <tr> <td><math>f</math></td> <td colspan="5">.004 – .009</td> </tr> <tr> <td><math>a_p</math></td> <td colspan="5">.012 – .059</td> </tr> <tr> <td colspan="6" style="text-align: center;"> </td> </tr> <tr> <td colspan="6" style="text-align: center;"> </td> </tr> <tr> <td>?</td> <td colspan="5">LCMF</td> </tr> </tbody> </table>	P	M	K	N	S	H	■	■	▣	□	▣	□	$f$	.004 – .009					$a_p$	.012 – .059																	?	LCMF				
P	M	K	N	S	H																																								
■	■	▣	□	▣	□																																								
$f$	.004 – .009																																												
$a_p$	.012 – .059																																												
?	LCMF																																												
<p>30 F (LCM.)</p>			<table border="1"> <thead> <tr> <th>P</th> <th>M</th> <th>K</th> <th>N</th> <th>S</th> <th>H</th> </tr> </thead> <tbody> <tr> <td>■</td> <td>▣</td> <td>■</td> <td></td> <td></td> <td></td> </tr> <tr> <td><math>f</math></td> <td colspan="5">.010 – .020</td> </tr> <tr> <td><math>a_p</math></td> <td colspan="5">.051 – .236</td> </tr> <tr> <td colspan="6" style="text-align: center;"> </td> </tr> <tr> <td colspan="6" style="text-align: center;"> </td> </tr> <tr> <td>?</td> <td colspan="5">LCMF, LCMR</td> </tr> </tbody> </table>	P	M	K	N	S	H	■	▣	■				$f$	.010 – .020					$a_p$	.051 – .236																	?	LCMF, LCMR				
P	M	K	N	S	H																																								
■	▣	■																																											
$f$	.010 – .020																																												
$a_p$	.051 – .236																																												
?	LCMF, LCMR																																												

Table 3  
Tabla 3  
Tableau 3

**GEOMETRY OF CUTTING INSERTS – CLAMPING DESIGNATION ISO X AND G**  
**GEOMETRÍA DE PLAQUITAS DE CORTE – TIPO DE FIJACIÓN ISO X Y G**  
**GÉOMÉTRIE DES PLAQUETTES – FIXATION DE TYPE ISO X ET G**

<p><b>CM (LCM.)</b></p> 		<table border="1"> <thead> <tr> <th>P</th> <th>M</th> <th>K</th> <th>N</th> <th>S</th> <th>H</th> </tr> </thead> <tbody> <tr> <td>■</td> <td>▣</td> <td>■</td> <td></td> <td></td> <td></td> </tr> <tr> <td colspan="6">  </td> </tr> <tr> <td colspan="6">See diagram / Consultar diagrama / Voir diagramme</td> </tr> <tr> <td colspan="6">  </td> </tr> <tr> <td colspan="6">  LCMF 13 CM, LCMF 16 CM, LCMR 16 CM                 </td> </tr> </tbody> </table>	P	M	K	N	S	H	■	▣	■										See diagram / Consultar diagrama / Voir diagramme												 LCMF 13 CM, LCMF 16 CM, LCMR 16 CM					
P	M	K	N	S	H																																	
■	▣	■																																				
																																						
See diagram / Consultar diagrama / Voir diagramme																																						
																																						
 LCMF 13 CM, LCMF 16 CM, LCMR 16 CM																																						
<p><b>F1 (LFMX)</b></p> 		<table border="1"> <thead> <tr> <th>P</th> <th>M</th> <th>K</th> <th>N</th> <th>S</th> <th>H</th> </tr> </thead> <tbody> <tr> <td>■</td> <td>▣</td> <td>■</td> <td></td> <td></td> <td></td> </tr> <tr> <td colspan="6">  </td> </tr> <tr> <td colspan="6">See diagram / Consultar diagrama / Voir diagramme</td> </tr> <tr> <td colspan="6">  </td> </tr> <tr> <td colspan="6">  LFMX                 </td> </tr> </tbody> </table>	P	M	K	N	S	H	■	▣	■										See diagram / Consultar diagrama / Voir diagramme												 LFMX					
P	M	K	N	S	H																																	
■	▣	■																																				
																																						
See diagram / Consultar diagrama / Voir diagramme																																						
																																						
 LFMX																																						
<p><b>F2 (LFMX)</b></p> 		<table border="1"> <thead> <tr> <th>P</th> <th>M</th> <th>K</th> <th>N</th> <th>S</th> <th>H</th> </tr> </thead> <tbody> <tr> <td>■</td> <td>▣</td> <td>■</td> <td></td> <td>□</td> <td>□</td> </tr> <tr> <td colspan="6">  </td> </tr> <tr> <td colspan="6">See diagram / Consultar diagrama / Voir diagramme</td> </tr> <tr> <td colspan="6">  </td> </tr> <tr> <td colspan="6">  LFMX                 </td> </tr> </tbody> </table>	P	M	K	N	S	H	■	▣	■		□	□							See diagram / Consultar diagrama / Voir diagramme												 LFMX					
P	M	K	N	S	H																																	
■	▣	■		□	□																																	
																																						
See diagram / Consultar diagrama / Voir diagramme																																						
																																						
 LFMX																																						
<p><b>M2 (LFMX)</b></p> 		<table border="1"> <thead> <tr> <th>P</th> <th>M</th> <th>K</th> <th>N</th> <th>S</th> <th>H</th> </tr> </thead> <tbody> <tr> <td>■</td> <td>■</td> <td>▣</td> <td>□</td> <td>▣</td> <td>□</td> </tr> <tr> <td colspan="6">  </td> </tr> <tr> <td colspan="6">See diagram / Consultar diagrama / Voir diagramme</td> </tr> <tr> <td colspan="6">  </td> </tr> <tr> <td colspan="6">  LFMX                 </td> </tr> </tbody> </table>	P	M	K	N	S	H	■	■	▣	□	▣	□							See diagram / Consultar diagrama / Voir diagramme												 LFMX					
P	M	K	N	S	H																																	
■	■	▣	□	▣	□																																	
																																						
See diagram / Consultar diagrama / Voir diagramme																																						
																																						
 LFMX																																						

**T**

**9**

**3**

**1**

**5**

Application  
Aplicación  
Application

Coating/Substrate  
Recubrimiento/Sustrato  
Revêtement/Substrat

Sequence number  
Número de secuencia  
Numéro de séquence

ISO range  
Gama ISO  
Plage ISO



<b>D</b>	Drilling Taladrado Perçage	<b>0 PVD</b> <b>1 CVD</b>	Special application Aplicación especial Application spéciale
<b>M</b>	Milling Fresado Fraisage	<b>2 PVD</b> <b>3 CVD</b>	Free Libre Libre
<b>T</b>	Turning Torneado Tournage	<b>4 PVD</b> <b>5 CVD</b>	Cast iron Fundición Fonte
		<b>6 PVD</b> <b>7 CVD</b>	Group M, S Grupos M, S Groupes M, S
		<b>8 PVD</b> <b>9 CVD</b>	Universal Universal Universel
		<b>B</b>	CBN
		<b>C</b>	Ceramic Cerámica Céramique
		<b>D</b>	PCD
		<b>T</b>	Cermet

**1 – 9**

**01 – 50**

	<b>01 – 05</b>
	<b>05 – 10</b>
	<b>10 – 20</b>
	<b>20 – 30</b>
	<b>30 – 40</b>
	<b>40 – 50</b>

Table 4  
Tabla 4  
Tableau 4

TURNING GRADES  
CALIDADES PARA TORNEADO  
NUANCE DE TOURNAGE

Grade Identification Calidad Désignation de la nuance	Area of Application Área de aplicación Domaine d'application		Feed Avance Avance	Cutting speed Velocidad de corte Vitesse de coupe	Resistance to adverse Working Conditions Resistencia a condiciones de trabajo adversas Résistance aux chocs et aux conditions défavorables	Substrate Sustrato Substrat	Coating Recubrimiento Revêtement	Colour / Color Couleur	Coolant benefit / Refrigerante Bénéfice de l'arrosage Général / General / Général	Parting off / Tronzado / Tronçonnage	Threading / Roscado / Filetage	Heavy roughing / Desbaste pesado Ebauche lourde
	Application / Aplicación / Application											
T9226	P15 - P35	<input type="checkbox"/>				FGM	MT-CVD	Yellow	+++			✓
	M10 - M30	<input type="checkbox"/>										
	K15 - K35	<input checked="" type="checkbox"/>										
	S15 - S25	<input type="checkbox"/>										
T9310	P01 - P15	<input type="checkbox"/>				FGM	MT-CVD	Black	++	✓		
	K05 - K20	<input checked="" type="checkbox"/>										
	H10 - H20	<input checked="" type="checkbox"/>										
T9315	P05 - P25	<input type="checkbox"/>				FGM	MT-CVD	Black	++	✓		✓
	K05 - K25	<input checked="" type="checkbox"/>										
	H10 - H20	<input checked="" type="checkbox"/>										
T9316	P10 - P20	<input type="checkbox"/>				FGM	MT-CVD	Yellow	+++			✓
	M05 - M15	<input checked="" type="checkbox"/>										
	K10 - K30	<input type="checkbox"/>										
T9325	P15 - P35	<input type="checkbox"/>				FGM	MT-CVD	Black	++	✓	✓	✓
	M10 - M30	<input type="checkbox"/>										
	K15 - K35	<input checked="" type="checkbox"/>										
	S10 - S20	<input checked="" type="checkbox"/>										
T9335	P20 - P45	<input type="checkbox"/>				FGM	MT-CVD	Black	+++	✓		✓
	M15 - M40	<input type="checkbox"/>										
	S15 - S25	<input checked="" type="checkbox"/>										
T7325	P15 - P35	<input checked="" type="checkbox"/>				FGM	MT-CVD	Black	+++	✓		✓
	M10 - M25	<input type="checkbox"/>										
	S10 - S25	<input type="checkbox"/>										
T7335	P20 - P40	<input checked="" type="checkbox"/>				FGM	MT-CVD	Black	+++	✓		
	M20 - M40	<input type="checkbox"/>										
	S15 - S25	<input checked="" type="checkbox"/>										
T5305	P05 - P15	<input checked="" type="checkbox"/>				H	MT-CVD	Black	+	✓		✓
	K01 - K15	<input type="checkbox"/>										
	H15 - H20	<input type="checkbox"/>										
T5315	P10 - P25	<input checked="" type="checkbox"/>				H	MT-CVD	Black	+	✓		
	M05 - M15	<input type="checkbox"/>										
	K10 - K25	<input type="checkbox"/>										
6630	P15 - P35	<input type="checkbox"/>				FGM	MT-CVD	Yellow	+++	✓		✓
	M10 - M30	<input type="checkbox"/>										
	K20 - K30	<input checked="" type="checkbox"/>										
	S15 - S25	<input type="checkbox"/>										
6640	P20 - P40	<input type="checkbox"/>				H	MT-CVD	Yellow	+++	✓	✓	✓
	M20 - M35	<input type="checkbox"/>										
	K25 - K40	<input checked="" type="checkbox"/>										
	S20 - S30	<input type="checkbox"/>										



Table 4  
Tabla 4  
Tableau 4

TURNING GRADES  
CALIDADES PARA TORNEADO  
NUANCE DE TOURNAGE

Grade Identification Calidad Désignation de la nuance	Area of Application Área de aplicación Domaine d'application	Application / Aplicación / Application	Feed Avance Avance	Cutting speed Velocidad de corte Vitesse de coupe	Resistance to adverse Working Conditions Resistencia a condiciones de trabajo adversas Résistance aux chocs et aux conditions défavorables	Substrate Sustrato Substrat	Coating Recubrimiento Revêtement	Colour / Color Couleur	Coolant benefit / Refrigerante Bénéfice de l'arrosage	General / General / Général	Parting off / Tronzado / Tronçonnage	Threading / Roscado / Filetage	Heavy roughing / Desbaste pesado Ébauche lourde
T6310	P05 - P15	<input checked="" type="checkbox"/>				ultra submicron H	PVD		+++	✓			
	M01 - M15	<input checked="" type="checkbox"/>											
	K05 - K15	<input checked="" type="checkbox"/>											
	N01 - N15	<input checked="" type="checkbox"/>											
	S01 - S15	<input checked="" type="checkbox"/>											
H01 - H15	<input checked="" type="checkbox"/>												
T8310	P05 - P15	<input type="checkbox"/>				ultra submicron H	PVD		++	✓			
	M01 - M15	<input checked="" type="checkbox"/>											
	K05 - K15	<input type="checkbox"/>											
	N01 - N15	<input checked="" type="checkbox"/>											
	S01 - S15	<input checked="" type="checkbox"/>											
H01 - H15	<input checked="" type="checkbox"/>												
T8315	P05 - P20	<input checked="" type="checkbox"/>				submicron H	PVD		++	✓			
	M05 - M20	<input checked="" type="checkbox"/>											
	K05 - K25	<input checked="" type="checkbox"/>											
	N05 - N25	<input checked="" type="checkbox"/>											
	S05 - S15	<input type="checkbox"/>											
H05 - H15	<input checked="" type="checkbox"/>												
T8330	P25 - P40	<input checked="" type="checkbox"/>				submicron H	PVD		+++	✓	✓	✓	
	M20 - M35	<input checked="" type="checkbox"/>											
	K20 - K40	<input checked="" type="checkbox"/>											
	N15 - N30	<input type="checkbox"/>											
	S15 - S25	<input checked="" type="checkbox"/>											
H15 - H25	<input type="checkbox"/>												
T8345	P30 - P50	<input checked="" type="checkbox"/>				submicron H	PVD		+++	✓		✓	
	M20 - M40	<input checked="" type="checkbox"/>											
	K30 - K40	<input checked="" type="checkbox"/>											
	S20 - S30	<input checked="" type="checkbox"/>											
T8030	P25 - P40	<input checked="" type="checkbox"/>				submicron H	PVD		+++		✓		
	M20 - M35	<input checked="" type="checkbox"/>											
	K20 - K40	<input checked="" type="checkbox"/>											
	N15 - N30	<input checked="" type="checkbox"/>											
	S15 - S25	<input checked="" type="checkbox"/>											
H15 - H25	<input checked="" type="checkbox"/>												
T0315	N05 - N30	<input checked="" type="checkbox"/>				submicron H	PVD		++	✓			
HF7	M10 - M20	<input type="checkbox"/>				submicron H	X		++	✓			
	K10 - K25	<input checked="" type="checkbox"/>											
	N10 - N25	<input checked="" type="checkbox"/>											
	S10 - S20	<input checked="" type="checkbox"/>											
H10 - H20	<input type="checkbox"/>												
H07	M05 - M15	<input checked="" type="checkbox"/>				H	X		++	✓			
	K10 - K25	<input checked="" type="checkbox"/>											
	N10 - N30	<input checked="" type="checkbox"/>											
S01 - S20	<input checked="" type="checkbox"/>												

Table 4  
Tabla 4  
Tableau 4

TURNING GRADES  
CALIDADES PARA TORNEADO  
NUANCE DE TOURNAGE

Grade Identification Calidad Désignation de la nuance	Area of Application Área de aplicación Domaine d'application	Application / Aplicación / Application	Feed Avance Avance	Cutting speed Velocidad de corte Vitesse de coupe	Resistance to adverse Working Conditions Resistencia a condiciones de trabajo adversas Résistance aux chocs et aux conditions défavorables	Substrate Sustrato Substrat	Coating Recubrimiento Revêtement	Colour / Color Couleur	Coolant benefit / Refrigerante Bénéfice de l'arrosage	General / General / Général	Parting off / Tronzado / Tronçonnage	Threading / Roscado / Filetage	Heavy roughing / Desbaste pesado Ébauche lourde
TT310	P10 - P25	■				cermet	PVD		+ / -	✓			
	M15 - M25	■											
TT010	P01 - P10	■				cermet	X		+ / -	✓			
	M01 - M15	■											
TC100	K01 - K15	■				ceramics	X		-	✓			
	S01 - S05	□											
	H05 - H20	□											
SN100	K05 - K15	■				ceramics	X		+ / -	✓			
TB310	H01 - H10	■				CBN	X		-	✓			
PD1	N05 - N25	■				PKD	X		-	✓			
PC30	N01 - N10	■				PKD	X		-	✓			
D720	N05 - N15	■				PKD	X		-	✓			

Substrate / Sustrato / Substrat

H	WC-Co based substrate	Sustrato de base WC-Co	Substrat de base WC-Co
submicron H	WC-Co based substrate fine grained (< 39.37 µm)	Sustrato de base WC-Co de grano fino (< 39.37 µm)	Substrat à grains fins base WC-Co (< 39.37 µm)
ultra submicron H	WC-Co based substrate very fine grained (< 19.69 µm)	Sustrato de base WC-Co de grano muy fino (< 19.69 µm)	Substrat à grains très fins base WC-Co (< 19.69 µm)
FGM	Functionally graded substrate	Sustrato de grado funcional	Substrat gradient fonctionnel
cermet	Cemented carbide without WC	Carburo sin WC	Carbure cémenté sans WC
ceramics	Cutting ceramics	Cerámica de corte	Céramique
PCD	Polycrystalline Diamond	Diamante policristalino	Diamant polycristallin
CBN	Cubic Boron Nitride	Nitruro de Boro Cúbico	Nitru de Bore cubique
HSS	High speed steel	Acero rápido	Acier rapide

Coating / Recubrimiento / Revêtement

MT-CVD	Medium-temperature chemical method of coating	Método de recubrimiento químico a media temperatura	Méthode de revêtement par dépôt chimique à moyenne température
PVD	Low-temperature physical method of coating	Método de recubrimiento físico a baja temperatura	Méthode de revêtement par dépôt physique à basse température
X	Uncoated grade	Sin recubrimiento	Nuance non revêtue

**WORKPIECE MATERIALS – CLASSIFICATION**  
**CLASIFICACIÓN DE MATERIALES MECANIZADOS**

Correctly identifying the machined material is one of the most important factors when choosing the tool and the initial machining conditions. To facilitate this, the machined materials are divided into six basic groups, or into twenty-four subgroups, combining materials that qualitatively cause the same type of loading (pressure) on the cutting edge and therefore a similar type of wear.

Thus the first step is to assign the workpiece material to one of the (sub)groups – see table 5. below.

Table 5

Identificar correctamente el material mecanizado es uno de los factores más importantes al momento de elegir la herramienta y la condiciones iniciales de mecanizado. Para facilitar esto, los materiales mecanizados se dividen en seis grupos básicos, o en veinticuatro subgrupos, combinando materiales que cualitativamente pueden causar el mismo tipo de carga (esfuerzo) en la arista de de corte y por lo tanto un tipo similar de desgaste. Así, el primer paso es asignar el material de la pieza a uno de los (sub) grupos - véase la tabla 5. a continuación.

Tabla 5

Subgroup Sub-grupo	DORMER AMG	Subgroup definition	Definición de sub-grupo	Example Ejemplo	Correction factor Factor de corrección	
<b>P</b>	<b>P1</b>	1.1, 1.2	Steel and cast steel with very good (enhanced) machinability; automatic steel and low-carbon steel	Acero y fundición de acero con muy buena (mejorado) mecanización, acero automático y de acero bajo en carbono	95Mn28	1.33
	<b>P2</b>	1.3	Non-alloy and low-alloy cast steel and steel with a medium carbon content (0.25 < C < 0.55); rigidity of up to 900 MPa and hardness of 160 – 255 HB	Sin alea y de baja aleación de acero fundido y acero con un contenido de carbono medio (0,25 < C < 0,55); rigidez de hasta 900 MPa y una dureza de 160 – 255 HB	C45	1.00
	<b>P3</b>	1.4	Less machinable non-alloy and low-alloy cast steel and steel with a medium carbon content; rigidity of up to 1000 MPa and hardness of up to 300 HB	Menos mecanizable sin alea y de acero fundido de baja aleación y acero con un contenido de carbono medio; rigidez de hasta 1000 MPa y una dureza de hasta 300 HB	41CrAlMo7	0.80
	<b>P4</b>	1.5	Medium – to high-alloy cast steel and steel (usually with a carbon content of 0.55 < C); rigidity of up to 1270 MPa and hardness of up to 375 HB (resp. 40 HRC)	Medio – alto-aleación de acero fundido y acero (normalmente con un contenido de carbono de 0,55 < C); rigidez de hasta 1270 MPa y una dureza de hasta 375HB (resp. 40 HRC)	X210Cr12	0.60
<b>M</b>	<b>M1</b>	2.1	Ferritic corrosion-resistant steel	Acero resistente a la corrosión ferrítico	X6Cr17	1.09
	<b>M2</b>	(2.1, 2.4)	Martensitic corrosion-resistant steel	Acero resistente a la corrosión martensítico	X 45CrSi 9.3	1.06
	<b>M3</b>	2.2	Austenitic corrosion-resistant steel	Acero resistente a la corrosión austenítico	X 6CrNiTi 18 10	1.00
	<b>M4</b>	2.3, 2.4	Ferritic-austenitic (duplex) and super-austenitic corrosion-resistant steel	Ferrítico-austenítico (dúplex) y super-austenítico acero resistente a la corrosión	X 53 CrMnNiN21 9	0.93
<b>K</b>	<b>K1</b>	3.1, 3.2	Grey cast iron	Gris hierro fundido	GG-25	1.00
	<b>K2</b>	3.1, 3.2	Tempered cast iron	Hierro fundido templado	GTS 45-06	0.95
	<b>K3</b>	3.3	Ductile cast iron ferritic and ferrite-pearlite	Fundición ferrítico hierro y ferrita-perlita	GGG40	0.90
	<b>K4</b>	3.4	Ductile cast iron pearlite-ferritic, pearlite-sorbite and pearlite	Fundición dúctil de perlita y ferrita, perlita-sorbite y perlita	GGG-70	0.85
<b>N</b>	<b>N1</b>	7.1	Aluminium and its soft alloys (with a low Si content), particularly formed and cast (non-hardened); hardness of up to 100 HB	Aluminio y sus aleaciones blandas (con bajo contenido de Si), especialmente formado y yeso (no resistente); dureza de hasta 100 HB	AlMgSi1	1.00
	<b>N2</b>	7.2, 7.3, 7.4	Hard Al alloys, particularly cast and hardened (with a high Si content)	Duro aleaciones de Al, en particular emitidos y endurecidos (con un alto contenido de Si)	G-AlSi11	0.65
	<b>N3</b>	6.1, 6.2, 6.3	Soft Cu alloys, automatic brass and other types of soft brass and bronze	Aleaciones Cu suaves, latón automática y otros tipos de latón blando y bronce	G-CuSn5Zn5Pb	0.60
	<b>N4</b>	6.4	Less machinable and hard Cu alloys	Aleaciones Cu menos mecanizables y duros	G-CuAl10Fe	0.40
<b>S</b>	<b>S1</b>	4.1, 4.2, 4.3	Technically pure Ti, alloys $\alpha$ , $\alpha+\beta$ and $\beta$ , refined and aged alloys	Técnicamente ti puro, aleaciones $\alpha$ , $\alpha+\beta$ y $\beta$ , refinado y aleaciones viejas	TiAl6V4	1.75
	<b>S2</b>	(9.1)	Fe-based alloys	Aleaciones a base de hierro	X10NiCrAlTi3221	1.20
	<b>S3</b>	5.1, 5.2, 5.3	Ni-based alloys	Aleaciones a base de níquel	INCONEL 718	1.20
	<b>S4</b>	(9.1)	Co-based alloys	Aleaciones a base de cobalto	Haynes 25	0.75
<b>H</b>	<b>H1</b>	1.6	Highly rigid and hard tool steel and hardened and refined steel with a hardness of 40 – 50 HRC	Muy rígido y duro y acero para herramientas endurecido y acero refinado, con una dureza de 40 – 50 HRC	X30WCrV9.3	1.15
	<b>H2</b>	-	Hardened and white cast iron 350 – 600 HV	Hierro fundido templado y blanco 350 – 600 HV	G-X 260 NiCr 4 2	1.10
	<b>H3</b>	1.7	Hardened and refined steel with hardness in the 50 – 55 HRC range	Acero templado y refinada con dureza en el 50 – 55 gama HRC	X38CrMoV5.1	1.00
	<b>H4</b>	1.8	Hardened and refined (mostly tool) steel with hardness of more than 55 HRC	Endurecido y refinado (en su mayoría de la herramienta) de acero con dureza de más de 55 HRC	X210Cr12	0.95

## CLASSIFICATION DES GROUPES DE MATÉRIAUX À USINER

L'identification du matériau à usiner est l'un des facteurs les plus importants pour choisir l'outil et les conditions de coupe de départ. Pour simplifier ce choix, les matériaux usinés sont divisés en six groupes de base, ou vingt quatre sous-groupes. Dans chacun sont associés

des matériaux qui causent le même type de charge sur l'arête de coupe et également un type d'usure similaire. C'est pourquoi la première étape consiste à identifier le matériau à usiner parmi les (sous-)groupes référencés - voir tableau N°5 ci-dessous.

Tableau 5

Subgrupo Sous-groupe	DORMER AMG	Définition du sous-groupe	Exemplo Exemple	Correção Standard Correction à la norme
<b>P</b>	<b>P1</b>	1.1, 1.2 Acier et acier coulé avec une usinabilité améliorée ; acier de construction et acier à faible teneur en carbone	9SMn28	1.33
	<b>P2</b>	1.3 Acier et acier coulé non allié et faiblement allié à moyenne teneur en carbone (0,25 < C < 0,55); résistance jusqu'à 900 MPa et dureté de 160 – 255 HB	C45	1.00
	<b>P3</b>	1.4 Acier et acier coulé non allié et faiblement allié à moyenne teneur en carbone plus difficiles à usiner; résistance jusqu'à 1000 MPa et dureté jusqu'à 300 HB	41CrAlMo7	0.80
	<b>P4</b>	1.5 Acier et acier coulé moyennement et fortement allié (généralement avec une teneur en carbone 0,55 < C); résistance jusqu'à 1270 MPa et dureté jusqu'à 375 HB HRC)	X210Cr12	0.60
<b>M</b>	<b>M1</b>	2.1 Aciers inoxydables ferritiques résistants à la corrosion	X6Cr17	1.09
	<b>M2</b>	(2.1, 2.4) Aciers inoxydables martensitiques résistants à la corrosion	X 45CrSi 9.3	1.06
	<b>M3</b>	2.2 Aciers inoxydables austénitiques résistants à la corrosion	X 6CrNiTi 18 10	1.00
	<b>M4</b>	2. , 2.4 Aciers inoxydables ferritiques-austénitiques (duplex) et super austénitiques résistants à la corrosion	X 53 CrMnNiN21 9	0.93
<b>K</b>	<b>K1</b>	3.1, 3.2 Fontes grises	GG-25	1.00
	<b>K2</b>	3.1, 3.2 Fontes trempées	GTS 45-06	0.95
	<b>K3</b>	3.3 Fontes ductiles ferritiques et ferritiques-perlitiques	GGG40	0.90
	<b>K4</b>	3.4 Fontes ductiles perlites-ferrites, perlites et de perlites sorbitiques	GGG-70	0.85
<b>N</b>	<b>N1</b>	7.1 L'aluminium et ses alliages doux (à faible teneur en Si), en particulier formés et coulés (non trempé); dureté jusqu'à 100 HB	AlMgSi1	1.00
	<b>N2</b>	7.2, 7.3, 7.4 Alliages Al durs, en particulier coulés et traités (à haute teneur en Si)	G-AlSi11	0.65
	<b>N3</b>	6.1, 6.2, 6.3 Alliages Cu doux, laiton automatique et autres types de laiton et de bronze tendre	G-CuSn5Zn5Pb	0.60
	<b>N4</b>	6.4 Alliages moins faciles à usiner et alliages durs Cu	G-CuAl10Fe	0.40
<b>S</b>	<b>S1</b>	4.1, 4.2, 4.3 Ti techniquement pur, alliages $\alpha$ , $\alpha+\beta$ et $\beta$ , alliages affinés et vieillis	TiAl6V4	1.75
	<b>S2</b>	(9.1) Alliages base Fe	X10NiCrAlTi3221	1.20
	<b>S3</b>	5.1, 5.2, 5.3 Alliages base Ni	INCONEL 718	1.00
	<b>S4</b>	(9.1) Alliages base Co	Haynes 25	0.75
<b>H</b>	<b>H1</b>	1.6 Aciers à outils très résistants durs, trempés, affinés avec une dureté de 40 – 50 HRC	X30WCrV9.3	1.15
	<b>H2</b>	- Fontes trempées et blanches 350 – 600 HV	G-X 260 NiCr 4 2	1.10
	<b>H3</b>	1.7 Aciers trempés et affinés avec une dureté dans la plage 50 – 55 HRC	X38CrMoV5.1	1.00
	<b>H4</b>	1.8 Aciers trempés et affinés (principalement acier à outil) avec une dureté de plus de 55 HRC	X210Cr12	0.95

**RECOMMENDATIONS FOR FINDING SUITABLE CHIP BREAKER – GRADE COMBINATION**  
**RECOMENDACIONES PARA ENCONTRAR LA COMBINACIÓN ROMPEVIRUTAS – CALIDAD ADECUADA**  
**RECOMMANDATIONS POUR TROUVER LA BONNE COMBINAISON GÉOMÉTRIE - NUANCE**

The choice of insert shape depends on the choice of tool holder. The following procedure will help you to not only choose an optimal product, but to also determine the correct starting conditions.

La elección de la forma de la plaquita depende de la elección del portaherramientas. El siguiente procedimiento le ayudará, no sólo a elegir un producto óptimo, sino también a determinar las condiciones de corte iniciales.

**Example: finding a suitable chip breaker – grade combination for machining steel using tool PCLNR 2020M12 with insert CN.. 12.., cutting conditions  $a_p = .039$  in,  $f = .006$  in/rev**

**Ejemplo: encontrar la combinación rompevirutas - calidad adecuada para mecanizar acero utilizando una herramienta PCLNR 2020M12 con una plaquita CN..12.., condiciones de corte  $a_p = .039$  in,  $f = .006$  in/rev**

1. Classify machined material into one of six groups according to ISO 513, see Table 5. Result: P – steel.
2. Select the grade and geometry based on insert type and operation type from Tables 6a - 11a (pgs T396-T407). Only variants with the highest probability of successful application upon first deployment are included.

1. Clasificar el material dentro de uno de los seis grupos según ISO 513, ver tabla 5. Resultado: P - acero.
2. Seleccionar calidad y geometría, en base a la forma de la plaquita y el tipo de operación, de las Tablas 6a - 11a (pgs T396-T407). Sólo se incluyen las variantes con la más alta probabilidad de éxito en la aplicación desde el principio.

Le choix de la forme de plaquette dépend du choix du porte-outil. La procédure suivante vous aidera non seulement à choisir le produit optimum, mais aussi à déterminer correctement les valeurs initiales de conditions de travail.

**Exemple : trouver la bonne combinaison géométrie - nuance pour l'usinage de l'acier en utilisant un outil PCLNR 2020M12 avec une plaquette CN.. 12.., conditions de coupe  $a_p = .039$  in,  $f = .006$  in/tour**

1. Trouver la matière à usiner dans l'un des six groupes ISO 513, voir Table 5. Résultat: P – acier.
2. Sélectionner la nuance et la géométrie selon le type de plaquette et d'opération dans les tables 6a - 11a (pgs T396-T407). Seules sont incluses les variantes ayant la plus grande probabilité de réussir l'application dès le premier essai.

Picture / Imagen / Image 6

Cutting inserts type according to ISO		FF		F		M		
		$f$	.002 - .004	$f$	.004 - .008	$f$	.008 - .016	
		$a_p$	.008 - .039	$a_p$	.031 - .079	$a_p$	.059 - .157	
		●	⚙	●	⚙	●	⚙	
P	..A	CNMA, CNMM, CNMG,	T8315	T8315	TT310	T8315	T9315	T9325
	..M	DNMA, DNMM, DNMG,	I	I	I	I	I	I
	..G	DNMU, SNMA, SNMM,	FF	FF	E FM	FM(SF)	W-M	M (W-MR)
	..U	SNMG, SNMX, TNMA,	T6310	T8330	T9315	T8330	T9315	T9325
	..N	TNMM, TNMG, VNMU,	II	II	II	II	II	II
		RNMA, RNMM, RNMG,	SF	NF	FM	FM(SF)	FM(SM)	FM(SM)
		WNMA, WNMM, WNMG	T8330	T8330	T9315	T9325	T9325	T8330
			III	III	III	III	III	III
			SF	FM	W-F	W-F	NM(SM)	NM(SM)

**RECOMMENDATIONS FOR FINDING SUITABLE CHIP BREAKER – GRADE COMBINATION**  
**RECOMENDACIONES PARA ENCONTRAR LA COMBINACIÓN ROMPEVIRUTAS – CALIDAD ADECUADA**  
**RECOMMANDATIONS POUR TROUVER LA BONNE COMBINAISON GÉOMÉTRIE - NUANCE**

**Example – legend: / Ejemplo - leyenda / Exemple - Légende :**

<b>A</b>	Find blue table (steel – P) - Table 6a Encontrar la tabla azul (acero - P) - Tabla 6a Trouver le tableau bleu (acier – P) - Table 6a
<b>B</b>	Find group with the chosen insert (CN..) Encontrar el grupo con la plaquita elegida (CN..) Trouver le groupe avec la plaquette choisie (CN..)
<b>C</b>	Find operation type based on input parameters ( $a_p, f$ ) Encontrar el tipo de operación en base a los parametros dados ( $a_p, f$ ) Trouver le type d'opération selon les paramètres de base ( $a_p, f$ )
<b>D</b>	Choose cut type based on planned operation (continuous) Elegir el tipo de corte en base a la operación (continuo) Choisir le type de coupe pour l'opération à réaliser (continue)
<b>E</b>	Result = First choice: grade TT310, chip breaker FM / Second choice: grade T9315, chip breaker FM / Third choice: grade T9315, chip breaker W-F Resultado = Primera elección: calidad TT310, rompevirutas FM / Segunda elección: calidad T9315, rompevirutas FM / Tercera elección: calidad T9315, rompevirutas W-F Résultat = Premier choix : nuance TT310, géométrie FM / Second choix : nuance T9315, géométrie FM / Troisième choix : nuance T9315, géométrie W-F

Note: the choices are graded so that the first variant offers the best power and the third highest operational reliability (it is necessary to always take into consideration the specific conditions).

You can verify the correct choice of chip breaker or grade in the section dedicated to the description of geometry or grades in the technical section for turning.

Note : Les choix sont classés de sorte que la première variante offre la meilleure performance et la troisième la plus grande fiabilité de fonctionnement (il est nécessaire de toujours prendre en compte les conditions spécifiques).

Vous pouvez vérifier le choix correct de la géométrie et de la nuance dans la partie technique de tournage comprenant les descriptions des géométries ou des nuances.

Nota: las elecciones estan graduadas de forma que la primera variante ofrece las mejores prestaciones y la tercera la mejor fiabilidad operacional (es necesario siempre tomar en consideración las condiciones específicas).

Se puede verificar la correcta elección de rompevirutas o calidad en el capítulo dedicado a la descripción de geometrías o calidades en la sección técnica para torneado.

**VERIFYING THE CHOICE OF CHIP BREAKER AND CUTTING GRADE**  
**VERIFICAR LA ELECCIÓN DE ROMPEVIRUTAS Y CALIDAD**  
**VÉRIFICATION DE LA GÉOMÉTRIE ET DE LA NUANCE DE COUPE**

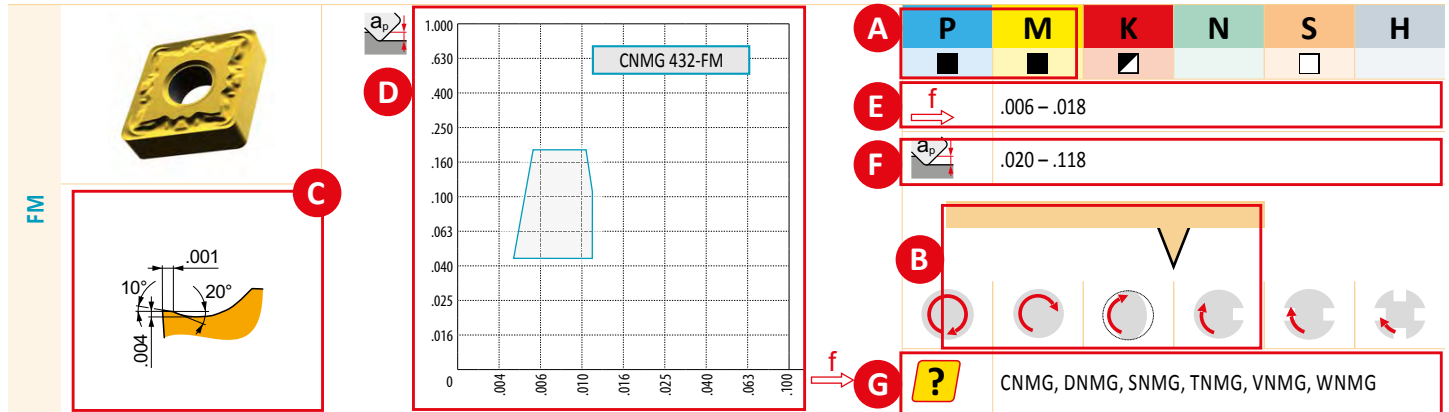
You can verify the correct choice of chip breaker or grade in the section dedicated to the description of geometry or grades – Tables 3 and 4.

Se puede verificar la correcta elección de rompevirutas o calidad en el capítulo dedicado a la descripción de geometrías o calidades - Tablas 3 y 4

Vous pouvez vérifier le choix correct de la géométrie et de la nuance dans la partie technique de tournage présentant les descriptions des géométries ou des nuances – Tables 3 et 4.

VERIFYING THE CHOICE OF CHIP BREAKER AND CUTTING GRADE  
 VERIFICAR LA ELECCIÓN DE ROMPEVIRUTAS Y CALIDAD  
 VÉRIFICATION DE LA GÉOMÉTRIE ET DE LA NUANCE DE COUPE

Picture / Imagen / Image 7



**Verification result:**

Chip breaker FM is primarily recommended for machining of, among others, common steels (A) and its geometry is suitable for machining, among others, on medium speeds with slightly worse cutting conditions and fluctuating depth of cut (B). The above corresponds to the assignment – workpiece with skin. In addition, we have obtained the information about the main cutting edge (C), the depth/feed areas where the given geometry does the forming (D), the maximum feed range (E), the maximum range for depth of cut (F) and the insert shapes where this chip breaker can be found (G).

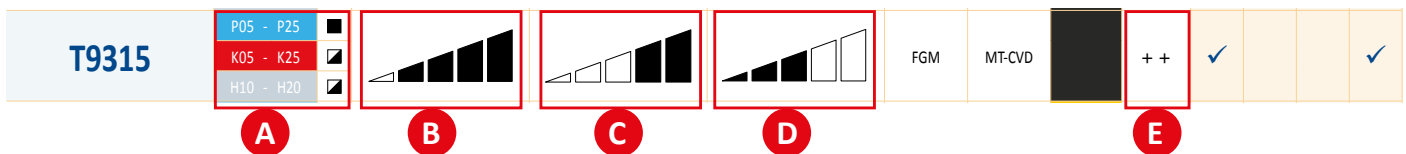
**Resultado de la verificación:**

El rompevirutas FM es la primera recomendación para el mecanizado de, entre otros, aceros normales (A) y su geometría es adecuada para mecanizar, entre otros, a velocidades medias en condiciones ligeramente desfavorables y una profundidad de corte con fluctuaciones (B). Esto corresponde a la pieza. Adicionalmente, hemos obtenido la información sobre el filo de corte principal (C), el área de aplicación de profundidad y avance en el que esta geometría conforma la viruta (D), el avance máximo (E), la profundidad de corte máxima (F) y las formas de plaqueta en las que este rompevirutas está disponible (G).

**Vérification du résultat:**

La géométrie (brise-copeaux) FM est principalement recommandée, entre autre, pour l'usinage de l'acier (A) et sa géométrie convient pour usiner, entre autre, avec une avance moyenne dans des conditions de travail légèrement défavorables et avec des profondeurs de coupe variables (B). Ce qui précède correspond à l'état de la pièce - pièce avec croûte. En complément, nous vous donnons l'information du profil de l'arête de coupe principale (C), Les graphes profondeur / avance donnent les valeurs pour lesquelles la géométrie fractionne le copeau (D), la plage d'avances (E), la plage de profondeurs de coupe (F) et les types de plaquettes disponibles avec cette géométrie.

Picture / Imagen / Image 8



**Verification result:**

Grade T9315 is recommended for machining, among others, common steels (A), for the full range of feeds with the exception of the smallest ones (B), i.e. smaller than 0.15, and further for the band of high and very high cutting speeds (C) and for stable to worse cutting conditions (D). These values comply with the conditions of our example. The resulting productivity of the operation can be further increased by using cutting fluid, which in this case will have a positive effect on the durability of the edge (E).

**Resultado de la verificación:**

La calidad T9315 esta recomendada para mecanizar, entre otros, aceros normales (A), para toda la gama de avances exceptuando los más bajos (B), es decir, menores de 0,15, además para la gama de velocidades de corte altas y muy altas (C) y para condiciones de corte estables a ligeramente desfavorables (D). Estos valores cumplen con las condiciones de nuestro ejemplo. La productividad resultante de la operación se puede incrementar mediante el uso de refrigerante, que en este caso tiene un efecto positivo en la duración del filo de corte (E).

**Vérification du résultat:**

La nuance T9315 est recommandée, entre autre, pour l'usinage de l'acier (A) pour une gamme étendue d'avances à l'exception des plus petites (B), par exemple inférieure à 0.15, et également pour une plage de vitesses de coupe élevées à très élevées (C) et pour des conditions de travail favorables à plus mauvaises (D). Ces valeurs sont conformes aux conditions de notre exemple. La productivité résultante de l'opération peut encore être améliorée en utilisant du fluide de coupe, lequel peut dans ce cas avoir un effet positif sur la durée de vie de l'arête (E).

**RECOMMENDATIONS FOR DETERMINING STARTING CUTTING CONDITIONS**  
**RECOMENDACIONES PARA DETERMINAR LAS CONDICIONES DE CORTE INICIALES**  
**RECOMMANDATIONS POUR TROUVER LES CONDITIONS DE COUPE DE DÉPART**

Example: to continue with the example, we shall work with the second option – grade T9315, chip breaker FM – which offers a compromise between power and operational reliability.  
 3. In Tables 6b - 11b (pgs T397-T407) select starting cutting speed:

Ejemplo: para continuar con el ejemplo, trabajaremos con la segunda opción - calidad T9315, rompevirutas FM - que ofrece un compromiso entre prestaciones y fiabilidad.  
 3. En las Tablas 6b - 11b (pgs T397-T407) seleccionar la velocidad de corte inicial:

Exemple : pour continuer avec cet exemple, nous travaillerons avec la deuxième option – nuance T9315, brise-copeaux FM – qui offrent un compromis entre la performance et la fiabilité de fonctionnement.  
 3. Dans les Tables 6b - 11b (pgs T397-T407), sélectionner la vitesse de coupe de départ:

Picture / Imagen / Image 9

		P																				
		f	a <sub>p</sub>	6630	6640	T5305	T5315	T7325	T7335	T9310	T9315	T9325	T9335	T9316	T9226	T6310	T8030	T8310	T8315	T8330	T8345	
FF	I	.002	.020	-	-	1394	1164	-	-	-	-	-	-	-	-	1525	886	1328	1214	902	-	20
	II	.003	.020	-	-	1197	1033	-	-	-	-	-	-	-	-	1263	754	1148	1050	804	-	10
	III	.004	.020	-	-	1115	968	-	-	-	-	-	-	-	-	1164	689	1066	968	754	-	10
F	I	.004	.060	935	836	1000	870	-	-	-	-	-	-	-	-	1033	623	968	869	672	623	10
	II	.006	.060	820	738	918	820	853	853	1050	1000	977	787	-	-	935	574	902	820	640	574	10
	III	.008	.060	820	738	934	836	869	853	1082	1050	1000	820	-	-	918	574	902	820	672	574	10

**Example – legend: / Ejemplo - leyenda: / Exemple - Légende:**

<b>A</b>	Find blue table (steel – P) - Table 6b Encontrar la tabla azul (acero - P) - Tabla 6b Trouver le tableau bleu (acier – P) - Table 6b	The initial cutting speeds are set for 15 minutes (45 minutes for heavy roughing) without cooling. These speeds are listed for threading, parting and grooving inserts with the use of cutting fluid.
<b>B</b>	Find operation type (operation F, f = .006 in/rev, a <sub>p</sub> - closest value – .059 in) Buscar el tipo de operación (operación F, f = .006 in/rev, a <sub>p</sub> - valor más cercano - .059 in) Trouver le type d'opération (opération F, f = .006 in/tour, a <sub>p</sub> - valeur la plus proche – .059 in)	La velocidad de corte inicial se da para 15 minutos (45 minutos para desbaste pesado) sin refrigerante. Estas velocidades estan indicadas para plaquitas de roscado, tronzado y ranurado con uso de refrigerante.
<b>C</b>	Find the chosen material (T9315) Buscar la calidad elegida (T9315) Trouver la nuance choisie (T9315)	Les vitesses de coupe initiales sont données pour 15 minutes (45 minutes pour l'ébauche lourde) sans arrosage. Ces vitesses sont données pour le filetage, les plaquettes pour tronçonnage et gorges avec l'utilisation de fluide de coupe.
<b>D</b>	Result = starting cutting speed 1000 SFM Resultado = velocidad de corte inicial 1000 SFM Résultat = vitesse de coupe de départ 1000 SFM	



**RECOMMENDATIONS FOR DETERMINING STARTING CUTTING CONDITIONS**  
**RECOMENDACIONES PARA DETERMINAR LAS CONDICIONES DE CORTE INICIALES**  
**RECOMMANDATIONS POUR TROUVER LES CONDITIONS DE COUPE DE DÉPART**

4. Tables 6b - 11b, see the previous step, are supplemented with correction coefficients for converting the cutting speeds for turning to take into account the condition of the machine, the tool durability required, the material and the hardness of the workpiece. Therefore, where necessary, use these correction coefficients to calculate the final starting speed.

**Example: specify with regard to the blank – sandblasted forging with crust, medium carbon steel with hardness 240 HB – and the working conditions – required durability of insert 20 minutes and poor condition of the machine.**

4. Tablas 6b - 11b, ver paso previo, estan complementadas con coeficientes de corrección para modificar las velocidades de corte teniendo en cuenta las condiciones de la máquina, la durabilidad requerida, el material de la pieza y su dureza. Por tanto, si es necesario, utilizar estos coeficientes de corrección para calcular la velocidad de corte inicial definitiva.

**Ejemplo: especificar en función de la pieza - forja chorreada con arena con cascarilla, acero de medio contenido en carbono con una dureza de 240 HB - y las condiciones de trabajo - una duración del filo de 20 minutos y una máquina en malas condiciones.**

4. Les tables 6b - 11b (voir étape précédente) sont complétées par des coefficients correcteurs pour convertir les vitesses de coupe de tournage en prenant en compte la condition de la machine, la durabilité de l'outil demandée, la matière et la dureté de la pièce. Cependant, si nécessaire, utiliser ces facteurs de correction pour calculer la vitesse de coupe finale.

**Exemple : spécifier l'état brut de la pièce – avec croûte de forge ou de fonderie, acier à moyenne teneur en carbone d'une dureté de 240 HB – et les conditions de travail – durabilité souhaitée de la plaquette 20 minutes et mauvaises conditions machine.**

Picture / Imagen 10

CORRECTION $v_c$				
Subgroup	P1	P2	P3	P4
Hardness	$k_{vHB} - P1$	$k_{vHB} - P2$	$k_{vHB} - P3$	$k_{vHB} - P4$
120	1.53	1.18	.94	.71
140	1.46	1.12	.90	.67
160	1.37	1.05	.84	.63
180	1.30	1.00	.80	.60
200	1.24		.76	.57
220	1.17		.72	.54
240	1.12	0.86	.69	.52
260	1.07	.82	.66	.49
280	1.04	.80	.64	.48
300	1.00	.77	.62	.46
320	.96	.74	.59	.44
340	.92	.71	.57	.43
360	.88	.68	.54	.41
375	.85	.65	.52	.39
$k_{VT(GM)}$				
10			30	.84
15			45	.76
20		0.93	60	.71
$k_{VT(HM)}$				
30			60	
45				
Skin of forging and casting				.70 - .80
Internal turning				.75 - .85
$k_{vx}$				
Interrupted cut				.80 - .90
Stable machine conditions				.80 - .90
Unstable machine conditions				.85 - .95
$k_{vi}$				
Insert shape				1.00
S... C... W...				1.00
V... L... (parting and grooving)				1.00
R... L... (heavy roughing)				1.10

**Example – legend:**

- A** Find blue table (correction for steels – P) - Table 6b  
Encontrar la tabla azul (correcciones para acero - P) - Tabla 6b
- A1** Find subgroup P2 (steels with medium carbon content)  
Buscar subgrupo P2 (aceros de medio contenido en carbono)
- A2** Find required hardness (240 HB)  
Buscar la dureza (240 HB)
- A3** Result = correction coefficient for machined material of required hardness (0.86  $k_{vHB}$ )  
Resultado = coeficiente de corrección para mecanizar un material con la dureza requerida (0.86  $k_{vHB}$ )
- B1** Find durability table for general machining (GM)  
Buscar la tabla de durabilidad para mecanizado general (GM)
- B2** Find required durability (20 min)  
Buscar la duración requerida (20 min)
- B3** Result = correction coefficient for required durability (0.93  $k_{VT}$  (GM))  
Resultado = coeficiente de corrección para la dureza requerida (0.93  $k_{VT}$  (GM))
- C1** Find correction for skin of the forging  
Buscar la corrección para corteza de forja
- C2** Result  $k_{vx1} = 0.8$  (choose the higher value from the range offered, since we are dealing with sandblasted forgings with smoother surface)  
Resultado  $k_{vx1} = 0.8$  (elegir el valor más alto de la gama indicada ya que estamos trabajando con forja chorreada con arena y con cascarilla)
- C3** Find correction for machine condition (poor)  
Buscar la corrección para el estado de la máquina (malo)
- C4** Result  $k_{vx2} = 0.85$  (choose the lower from the range offered)  
Resultado  $k_{vx2} = 0.85$  (elegir el valor más pequeño de la gama indicada)
- D1** Find correction for insert shape (C..)  
Buscar la corrección para la forma de la plaquita (C..)
- D2** Result  $k_{vi} = 1.00$   
Resultado  $k_{vi} = 1.00$

**RECOMMENDATIONS FOR DETERMINING STARTING CUTTING CONDITIONS**  
**RECOMENDACIONES PARA DETERMINAR LAS CONDICIONES DE CORTE INICIALES**  
**RECOMMANDATIONS POUR TROUVER LES CONDITIONS DE COUPE DE DÉPART**

Image 10

<b>A CORRECTION <math>v_c</math></b>				
Subgroup	P <b>A1</b>	P2	P3	P4
Hardness	$k_{vHB} - P1$	$k_{vHB} - P2$	$k_{vHB} - P3$	$k_{vHB} - P4$
120	1.53	1.18	.94	.71
140	1.46	1.12	.90	.67
160	1.37	1.05	.84	.63
180	1.30	1.00	.80	.60
200	1.24	.96	.76	.57
220	1.17	.92	.72	.54
240	1.12	.86	.69	.52
260	1.07	.82	.66	.49
280	1.04	.80	.64	.48
300	1.00	.77	.62	.46
320	.96	.74	.59	.44
340	.92	.71	.57	.43
360	.88	.68	.54	.41
375	.85	.65	.52	.39
$k_{VT(GM)}$	10	30	.84	
	15	45	.76	
	20	60	.71	
$k_{VT(HM)}$	30	1.10	60	
	45	1.00		
$k_{vx}$	Skin of forging and casting			.70 - .80
	Internal turning			.75 - .85
	Interrupted cut			.80 - .90
	Stable machine conditions			1.00
Unstable machine conditions			.85 - .95	
$k_{vi}$	Insert shape S... C... W...			1.00
	V... L... (parting and grooving)			1.00
	R... L... (heavy roughing)			1.10

**Example – legend:**

- A** Trouver le tableau bleu (correction pour les aciers – P) - Table 6b
- A1** Trouver le sous-groupe P2 (aciers à moyenne teneur en carbone)
- A2** Trouver la dureté requise (240 HB)
- A3** Résultat = coefficient correcteur pour la matière à usiner avec la dureté requise ( $0.86 k_{vHB}$ )
- B1** Trouver la table de durabilité pour l'usage général (GM)
- B2** Trouver la durabilité souhaitée (20 min)
- B3** Résultat = coefficient correcteur pour la durabilité souhaitée  $0.93 k_{VT}$  (GM)
- C1** Trouver la correction pour croûte de forge ou de fonderie
- C2** Résultat  $k_{vx1} = 0.8$  (choisir la valeur la plus élevée dans la plage, puisque l'état du brut de la pièce comprend de la croûte de forge ou de fonderie)
- C3** Trouver la correction pour les conditions de la machine (mauvaises)
- C4** Résultat  $k_{vx2} = 0.85$  (choisir la plus basse de la plage)
- D1** Trouver la correction pour la forme de la plaquette (C..)
- D2** Résultat  $k_{vi} = 1.00$

$$v_c = v_{15} \cdot k_{vx} \cdot k_{VT} \cdot k_{vHB} \cdot (k_{vN})$$

$$v_c = 305 \times 0.86 \times 0.93 \times 0.80 \times 0.85 \times 1.00 = 166$$

**Cutting speed determined in this way is the initial (default) value defining the basic level of cutting speed for a given operation.**

The variance in machinability of the machined material, above all, often causes the need to adjust the cutting speed to a certain extent in case we need to adhere relatively precisely to the economical durability of the edge.

**La velocidad de corte determinada de esta forma es el valor inicial y define el nivel básico de velocidad de corte para una operación determinada.**

La variación en la maquinabilidad del material a mecanizar, en general, hace necesario ajustar la velocidad de corte en cierta medida si tenemos que determinar de manera precisa la durabilidad económica del filo.

**La valeur de la vitesse de coupe déterminée de cette façon est une valeur initiale (par défaut) représentant une vitesse de base pour une opération donnée.**

C'est avant-tout la variation d'usabilité de la matière usinée qui nécessite d'avoir à ajuster la vitesse de coupe dans le cas où l'on recherche un peu plus précisément une durabilité économique de l'arête.



Table 6b  
Tabla 6b  
Tableau 6b

CHOICE OF INSERT  
ELECCIÓN DE PLAQUITA  
CHOIX DE LA PLAQUETTE

CORRECTION / CORRECCIÓN / CORRECTION V <sub>c</sub>									
Subgroup / Sous-groupe	P1	P2	P3	P4					
Hardness / Dureza / Dureté	K <sub>vHB</sub> - P1	K <sub>vHB</sub> - P2	K <sub>vHB</sub> - P3	K <sub>vHB</sub> - P4					
120	1.53	1.18	.94	.71					
140	1.46	1.12	.90	.67					
160	1.37	1.05	.84	.63					
180	1.30	1.00	.80	.60					
200	1.24	.95	.76	.57					
220	1.17	.90	.72	.54					
240	1.12	.86	.69	.52					
260	1.07	.82	.66	.49					
280	1.04	.80	.64	.48					
300	.90	.77	.62	.46					
320	.96	.74	.59	.44					
340	.92	.71	.57	.43					
360	.88	.68	.54	.41					
375	.85	.65	.52	.39					
k <sub>vHB</sub>									
Ⓛ					k <sub>vT</sub>				
10					30				
15					45				
20					60				
Ⓛ					Ⓛ				
30					60				
45					1.00				
Skin of forging and casting / Revestimiento de piezas forjadas y fundidas / Croûte de forge et de fonderie					.70 - .80				
Internal turning / Torneado interno / Tournage intérieur					.75 - .85				
Interrupted cut / Corte interrumpido / Coupe interrompue					.80 - .90				
Stable machine conditions / Condiciones de máquina estables / Bonnes conditions machine					1.05 - 1.20				
Unstable machine conditions / Condiciones de máquina inestables / Mauvaises conditions machine					.85 - .95				
Insert shape / Forma de la plaquita / Forme de plaquette					k <sub>vHD</sub>				
S..., C..., W...					1.00				
T..., D..., K...					.95				
V..., L... (parting and grooving / tronchado y ranurado) (trouçonnage et gorges)					.88				
R..., L... (heavy roughing / desbaste pesado) (ébauche lourde)					1.10				
k <sub>vT</sub> (GM)									
k <sub>vT</sub> (HM)									
k <sub>vX</sub>									
k <sub>vI</sub>									

P	f	a <sub>p</sub>	V <sub>15</sub> [m]										V <sub>45</sub> [m]												
			630	640	T5305	T5315	T7325	T7335	T9310	T9315	T9325	T9335	T9316	T9226	T6310	T8030	T8310	T8315	T8330	T8430	T8435	T7010	T1310		
I	.002	.020	-	-	1394	1164	-	-	-	-	-	-	-	-	1525	886	1328	1214	902	1230	-	-	2000	1509	
II	.003	.020	-	-	1197	1033	-	-	-	-	-	-	-	-	1263	754	1148	1050	804	1017	-	-	1689	1296	
III	.004	.020	-	-	1115	968	-	-	-	-	-	-	-	-	1164	689	1066	968	754	935	-	-	1574	1214	
I	.004	.060	935	836	1000	870	-	-	-	-	-	-	-	-	1033	623	968	869	672	837	623	-	-	1492	1082
II	.006	.060	820	738	918	820	853	1050	1000	977	787	-	-	-	935	574	902	820	640	771	574	-	-	1361	1000
III	.008	.060	820	738	934	836	869	853	1082	1050	1000	820	-	-	918	574	902	820	672	738	574	-	-	-	-
I	.008	.328	771	689	886	787	820	804	1033	1000	951	771	-	-	886	541	869	787	623	705	541	-	-	-	-
II	.012	.328	640	574	771	705	722	689	918	918	869	705	-	-	738	476	754	689	574	607	476	-	-	-	-
III	.016	.328	607	541	738	689	705	640	902	918	853	689	-	-	705	459	738	672	544	574	459	-	-	-	-
I	.016	.200	525	476	656	607	623	574	804	804	754	607	787	590	623	394	656	590	492	492	394	-	-	-	-
II	.024	.200	443	394	574	541	541	492	705	754	689	558	738	508	525	344	574	525	443	427	344	-	-	-	-
III	.031	.200	394	361	525	492	508	426	656	705	640	508	705	476	459	312	525	476	410	377	312	-	-	-	-
I	.031	.500	279	361	295	344	377	328	410	508	476	361	525	328	-	-	-	-	295	230	197	-	-	-	-
II	.040	.500	246	230	262	328	361	295	394	492	459	344	508	312	-	-	-	-	279	197	180	-	-	-	-
III	.050	.500	230	197	246	295	328	262	361	476	426	312	476	295	-	-	-	-	262	180	164	-	-	-	-
	.004	-	-	-	-	-	-	-	-	-	771	-	-	-	-	-	-	-	525	-	-	-	-	-	-
	.006	-	-	-	-	-	-	-	-	-	754	-	-	-	-	-	-	-	492	-	-	-	-	-	-
	.008	-	-	-	-	-	-	-	-	-	705	-	-	-	-	-	-	-	459	-	-	-	-	-	-
	.012	-	-	-	-	-	-	-	-	-	640	-	-	-	-	-	-	-	426	-	-	-	-	-	-
	.004	-	-	-	-	-	-	-	-	-	623	-	-	-	-	-	-	-	410	-	-	-	-	-	-
	.006	-	-	-	-	-	-	-	-	-	590	-	-	-	-	-	-	-	394	-	-	-	-	-	-
	.008	-	-	-	-	-	-	-	-	-	558	-	-	-	-	-	-	-	361	-	-	-	-	-	-
	.012	-	-	-	-	-	-	-	-	-	508	-	-	-	-	-	-	-	344	-	-	-	-	-	-

Figures in blue are valid for machining with coolant. / Las cifras en azul son válidas para mecanizado con refrigerante. / Valeurs en bleu pour usinage avec arrosage.

Table 7a  
 Tabla 7a  
 Tableau 7a

CHOICE OF INITIAL CUTTING CONDITIONS  
 SELECCIÓN DE CONDICIONES DE CORTE INICIALES  
 CHOIX DES CONDITIONS DE COUPE INTIALES

Cutting inserts type according to ISO Tipo de plaqueta ISO Tipo de Pastilha ISO Type de plaquettes de coupe définies par la norme ISO	FF		F		M		R		HR		P+G		T
	$f$	$a_p$	$f$	$a_p$	$f$	$a_p$	$f$	$a_p$	$f$	$a_p$	$f$	$a_p$	
..A CNMA, CNMM, ..M CNMG, DNMA, DNMM, ..G DNMG, DNML, SNMA, ..U SNMM, SNMG, SNMX, ..N TNMA, TNMM, TNMG, VNML, RNMA, RNMM, RNMG, WNMA, WNMM, WNMG	T8315	T8315	TT310	T8315	T7325	T7335	T9325	T8315	T9226 (T9325)	T9335	-	-	-
	FF	FF	FM	NF	SM (W-MR)	SM	RM (W-MR)	RM	NR2 (OR)	NR2 (OR)	-	-	-
	T6310	T8330	T6310	T8330	T9325	T7335	T7335	T7335	T7335	T7335	-	-	-
	SF	SF	SF	SM	NM (S)	FM	NR	R	NR2 (OR)	SR(HR2)	-	-	-
	-	-	T9315	T8330	T8330	T8330	T7335	T8330	T8330	T8345	-	-	-
	-	-	NF	FM	NM (S)	FM	RM	NR2 (OR)	NR2 (OR)	SR(HR2)	-	-	-
	-	-	T9325	T9335	6640	6640	6640	6640	T9310	T9315 (T9325)	-	-	-
	-	-	72	72	73	73	73	73	-	-	-	-	-
	-	-	-	-	T9325	T9335	6640	6640	T9315	T9325 (T9335)	-	-	-
	-	-	-	-	72	72	74	74	-	-	-	-	-
	-	-	-	-	T9315	T9315	T9315	-	T9315	T9325	-	-	-
	..W CCMW, CCMT, SCMW, ..T SCMT, DCMW, DCMT, TCMW, TCMT, VCMW, VCMT, WCMW, WCVMT, RCMW, RCMT, RCMX	TT310	T8315	TT310	T8315	T9315	T9315	-	-	T9315	T9325	-	-
UR	FF(NF2)	UR	FF(NF2)	UR(RM)	UR(RM)	RM	-	-	OR	OR	-	-	-
TT010	T8330	TT010	T9325	T9315	T9325	T9325	-	-	T9325	T9335	-	-	-
FF2	FF(F2)	FF2	FM(FM2)	RM	RM	RM	-	-	SR	DR4	-	-	-
T6310	-	T9315	T8330	T9325	T8330	T8330	-	-	T9316	T9335	-	-	-
A(SF3)	-	FM(FM2)	FM	RM(RM3)	RM(RM3)	RM(RM3)	-	-	RM1	SR	-	-	-
..R SPWR, SPGR, SPUN, ..N SPGN, TPGR, TPGR, TPUN, TPGN	-	T9325	T9325	T9335	T9325	T9335	-	-	-	-	-	-	-
-	-	46	46	46	46	46	-	-	-	-	-	-	-
-	-	T9325	T9335	T9325	T9335	T9335	-	-	-	-	-	-	-
-	-	47	47	47	47	47	-	-	-	-	-	-	-
-	-	T9325	T9335	T9325	T9335	T9335	-	-	-	-	-	-	-
-	-	48	48	48	48	48	-	-	-	-	-	-	-
..X LFMA, LFUX, LOM(R), TN11Z, TN16Z, TN22 Z, TN11 R, TN16 R, TN22 R	T9325	T8330	T9325	T8330	-	-	-	-	-	-	T9325	T8330	-
-	-	-	-	-	-	-	-	-	-	-	-	-	-
-	-	T8330	T8330	-	-	-	-	-	-	-	T9325	T9325 (6640)	-
-	-	-	-	-	-	-	-	-	-	-	-	-	-
TM11., TM16., TN 22	-	-	-	-	-	-	-	-	-	-	-	-	T8030

M

Table 7b  
Tabla 7b  
Tableau 7b

CHOICE OF INSERT  
ELECCIÓN DE PLAQUITA  
CHOIX DE LA PLAQUETTE

CORRECTION / CORRECCIÓN / CORRECTION $v_c$								
Subgroup / Subgrupo Sous-groupe	M1		M2		M3		M4	
	$k_{VHB} - M1$		$k_{VHB} - M2$		$k_{VHB} - M3$		$k_{VHB} - M4$	
Hardness / Dureza Dureté	120	135	131	124	124	118	115	115
140	128	124					1.10	1.10
160	122	118					1.04	1.04
180	114	111					.98	.98
200	109	106					.93	.93
220	103	100					.88	.88
240	.98	.95					.84	.84
260	.93	.91					.80	.80
280	.89	.87					.76	.76
300	.87	.84					.74	.74
320	.84	.81					.72	.72
340	.80	.78					.69	.69
360	.77	.75					.66	.66
375	.74	.72					.63	.63
	$k_{VT}$		$k_{VT}$		$k_{VT}$		$k_{VT}$	
	10		30		30		.84	
	15		45		45		.76	
	20		60		60		.71	
	$k_{VT}$		$k_{VT}$		$k_{VT}$		$k_{VT}$	
	30		60		60		.93	
	45		1.00		1.00		.70 - .80	
	Skin of forging and casting / Revestimiento de piezas forjadas y fundidas Croûte de forge et de fonderie							
	Internal turning / Torneado interno Tournage intérieur							
	Interrupted cut / Corte interrumpido Coupe interrompue							
	Stable machine conditions / Condiciones de máquina estables Bonnes conditions machine							
	Unstable machine conditions / Condiciones de máquina inestables Mauvaises conditions machine							
	Insert shape / Forma de la plaquita / Forme de plaquette							
	S..., C..., W...							
	T..., D..., K...							
	V..., L... (parting and grooving / tronizado y ranurado) (tronzage et gorges)							
	R..., L... (heavy roughing / desbaste pesado) (ébauche lourde)							
	$k_{VT} (GM)$		$k_{VT} (HM)$		$k_{Vx}$		$k_{Vi}$	

M																				
f	$a_p$	$V_{15} [m]$																		
		690	690	690	690	690	690	690	690	690	690									
I	.002	.020	-	-	-	-	-	-	-	-	-	-	-	-	-	-	-	-	-	-
II	.003	.020	-	-	-	-	-	-	-	-	-	-	-	-	-	-	-	-	-	-
III	.004	.020	-	-	-	-	-	-	-	-	-	-	-	-	-	-	-	-	-	-
I	.004	.060	558	492	508	-	-	-	-	-	-	-	-	-	-	-	-	-	-	-
II	.006	.060	492	443	492	574	508	574	476	-	-	-	-	-	-	-	-	-	-	-
III	.008	.060	492	443	492	590	508	590	492	-	-	-	-	-	-	-	-	-	-	-
I	.008	.328	459	410	476	574	476	574	459	-	-	-	-	-	-	-	-	-	-	-
II	.012	.328	377	344	426	508	410	508	410	-	-	-	-	-	-	-	-	-	-	-
III	.016	.328	361	328	410	508	377	508	410	-	-	-	-	-	-	-	-	-	-	-
I	.016	.200	312	279	361	443	344	443	361	476	344	-	-	-	-	-	-	-	-	-
II	.024	.200	262	230	328	410	295	410	328	443	312	-	-	-	-	-	-	-	-	-
III	.031	.200	230	197	295	377	262	377	312	427	279	-	-	-	-	-	-	-	-	-
I	.031	.500	164	148	197	279	197	279	197	312	197	-	-	-	-	-	-	-	-	-
II	.040	.500	148	131	197	262	180	262	197	295	180	-	-	-	-	-	-	-	-	-
III	.050	.500	131	115	180	246	164	246	180	279	164	-	-	-	-	-	-	-	-	-
	.004	-	-	-	-	459	-	459	-	-	-	-	-	-	-	-	-	-	-	-
	.006	-	-	-	-	443	-	443	-	-	-	-	-	-	-	-	-	-	-	-
	.008	-	-	-	-	410	-	410	-	-	-	-	-	-	-	-	-	-	-	-
	.012	-	-	-	-	377	-	377	-	-	-	-	-	-	-	-	-	-	-	-
	.004	-	-	-	-	361	-	361	-	-	-	-	-	-	-	-	-	-	-	-
	.006	-	-	-	-	36	-	36	-	-	-	-	-	-	-	-	-	-	-	-
	.008	-	-	-	-	328	-	328	-	-	-	-	-	-	-	-	-	-	-	-
	.012	-	-	-	-	312	-	312	-	-	-	-	-	-	-	-	-	-	-	-

Figures in blue are valid for machining with coolant. / Las cifras en azul son válidas para mecanizado con refrigerante.  
Valeurs en bleu pour usinage avec arrosage.











Table 10a  
 Tabla 10a  
 Tableau 10a

CHOICE OF INITIAL CUTTING CONDITIONS  
 SELECCIÓN DE CONDICIONES DE CORTE INICIALES  
 CHOIX DES CONDITIONS DE COUPE INTIALES

Cutting inserts type according to ISO Tipo de plaqueta ISO Tipo de Pastilha ISO Type de plaquettes de coupe définies par la norme ISO	FF		F		M		R		HR		P+G		T
	.002 - .004	.020 - .040	.004 - .008	.040 - .080	.008 - .016	.080 - .160	.016 - .040	.160 - .400	> .040	> .400	.002 - .012		
..A CNUM, CNMM, CNMG, DNMA, DNMM, ..M DNMG, DNML, SNMA, ..G SNMM, SNMG, SNMX, ..U TNMA, TNMM, TNMG, ..N VNUL, RNMA, RNMM, RNMG, WNMA, WNMM, WNMG	T8315 I	T8315 I	T8315 I	T8315 I	T7335 I	T9325 I	T8315 I	T9325 I	T9226 (T9325) I	T9335 I	-	-	-
..X KNUX	-	-	-	-	-	-	-	-	-	-	-	-	-
..W COMW, CCMT, SCMW, ..T SCMT, DCMW, DCMT, TCMW, TCMT, VCMW, VCMT, WCMW, WCMT, RCMW, RCMT, RCMX	T8315 I	T8315 I	T8315 I	T8315 I	T9325 I	T9315 I	T8315 I	T9315 I	T9315 I	T9325 I	-	-	-
..R SPMR, SPGR, SPUN, ..N SPGN, TPMB, TPGR, TPUN, TPGN	-	-	-	-	-	-	-	-	-	-	-	-	-
..X LFMX, LFUX, LCMF(R), TN11 Z, TN16 Z, TN22 Z, TN11 R, TN16 R, TN22 R	T8315 I	T8315 I	T8315 I	T8315 I	T9325 I	T9325 I	T8315 I	T9325 I	T9325 I	T9325 I	T9325 I	T8330 I	T8330 I
TN11.., TN16.., TN 22	-	-	-	-	-	-	-	-	-	-	-	-	-





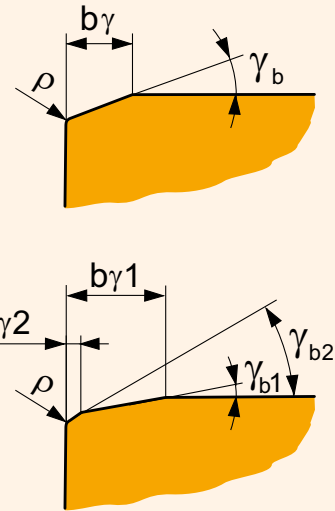


Edge finishing  
 Preparación del filo  
 Préparation d'arête

**T00820** ⇒

$b_\gamma$  ( $b_{\gamma 1}$ )

$\gamma_b$  ( $b_{\gamma 2} \times \gamma_{b2}$  dependent on  $b_{\gamma 1} \times \gamma_{b1}$ )  
 $\gamma_b$  ( $b_{\gamma 2} \times \gamma_{b2}$  dependiente de  $b_{\gamma 1} \times \gamma_{b1}$ )  
 $\gamma_b$  ( $b_{\gamma 2} \times \gamma_{b2}$  dépend de  $b_{\gamma 1} \times \gamma_{b1}$ )



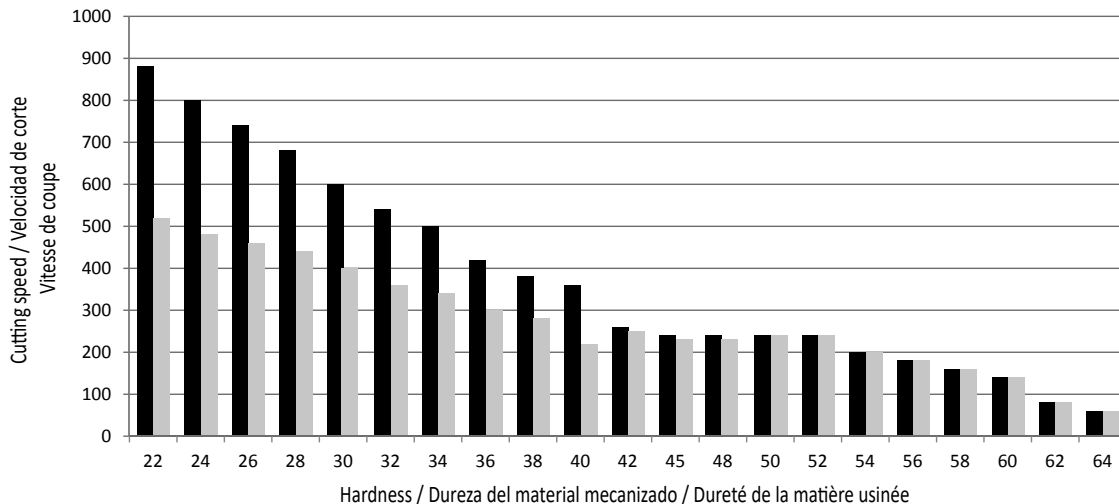
Example: **CNGA 432 T00820** – insert CNGA 120404 with T-land (cutting edge design T) width .008 in and angle  $-20^\circ$   
 Ejemplo: **CNGA 432 T00820** – plaquita CNGA 120404 con faceta en T (filo de corte con diseño T) ancho .008 in y ángulo  $-20^\circ$   
 Exemple: **CNGA 432 T00820** – plaquette CNGA 120404 avec listel T (arête coupante de forme T) largeur .008 in et angle  $-20^\circ$

Ceramics are materials that have one of the highest levels of thermal stability. During their practical application, however, it is necessary to reduce the cutting speed with regard to the hardness of the machined material and its other characteristics. For illustration purposes, we have provided a concrete example of a round insert used for finishing.

Las cerámicas de corte son materiales con uno de los límites de estabilidad térmica más elevados. No obstante, durante su uso efectivo, también es necesario reducir la velocidad de corte según la dureza y otras características del material mecanizado. A modo de ilustración, facilitamos un ejemplo concreto de una plaquita redonda que se utiliza para el torneado de acabado.

Les céramiques de coupe sont des matériaux qui possèdent les limites de stabilité thermique les plus élevées. Pendant son utilisation pratique, cependant, il est nécessaire de réduire la vitesse de coupe en rapport avec la dureté et les autres caractéristiques de la matière usinée. Voici un exemple concret pour une plaquette ronde utilisée en tournage de finition.

Cutting speed for / Velocidad de corte para / Velocidade de corte para / Vitesse de coupe pour RNGN ( $a_p = .059$  in)



Homogenous material / Material homogéneo / Matériau homogène  
 Forged materials, cold rolled materials, etc. / Materiales forjados, materiales laminados en frío, etc.  
 Matériaux forgés, matériaux laminés à froid, etc.

The following table provides further parameters that need to be taken into account when selecting the cutting speed to use.

La tabla siguiente indica otros parámetros que se deben tener en cuenta cuando se selecciona la velocidad de corte

La table suivante fait état d'autres paramètres qui doivent être pris en compte au moment de sélectionner la vitesse de coupe résultante

Table / Tabla / Tableau 12

<b>Point radius / Radio de la punta / Rayon de plaquette</b>	.016	.031	.047	.063	.094	.118
Reduction $v_c$ by / Reducción de la $v_c$ / Réduction de $v_c$ de	20%	16%	12%	10%	5%	2%
<b>Reduction / Reducción de Kr / Réduction Kr</b>	90°	75°	60°	45°	30°	< 15°
Reduction $v_c$ by / Reducción de la $v_c$ / Réduction de $v_c$ de	0%	5%	8%	12%	15%	18%
<b>Insert shape / Forma de la plaquita / Forme de plaquette</b>	V	D	T	C, W	S	R
<b>Point angle / Ángulo de la punta / Angle de pointe</b>	35°	55°	60°	80°	90°	
Reduction $v_c$ by / Reducción de la $v_c$ / Réduction de $v_c$ de	17%	12%	10%	6%	4%	0%
<b>Depth of cut / Profundidad de corte / Profondeur de coupe [mm]</b>	<.055	.118	.236	.394	.512	.787
Reduction $v_c$ by / Reducción de la $v_c$ / Réduction de $v_c$ de	5%	8%	13%	16%	18%	20%

As previously stated, ceramics are materials that have one of the highest levels of abrasion resistance, yet they also have one of the lowest levels of strength.

With regard to rigidity, it is therefore also necessary to take into account other limiting criteria when selecting the right insert.

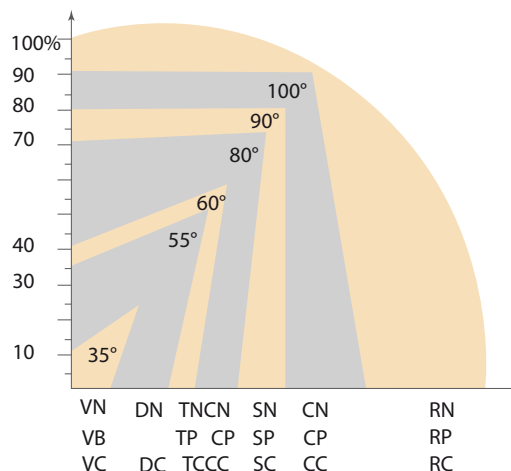
Como se mencionó anteriormente, las cerámicas de corte son materiales con una resistencia a la abrasión muy elevada, pero al mismo tiempo, su dureza es una de las más bajas. Por lo tanto, con respecto a la rigidez, es necesario tener en cuenta también otros criterios limitadores a la hora de seleccionar la plaquita adecuada..

Comme déjà mentionné, les céramiques de coupe sont des matériaux possédant l'une des plus hautes résistances à l'abrasion, cependant, dans le même temps, elles possèdent une des moins bonnes tenacités.

En ce qui concerne la rigidité, il est donc nécessaire de prendre en compte d'autres critères limitatifs pour la sélection de la plaquette appropriée.

**Rigidity in relation to insert shape / Rigidez en relación con la forma de la plaquita / Rigidité en relation avec la forme de plaquette**

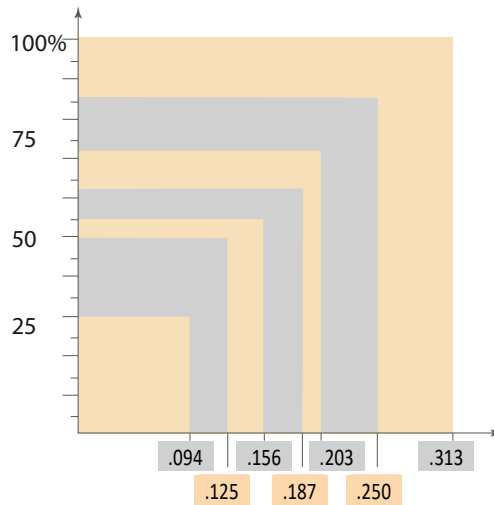
Picture 11  
 Imagen 11  
 Image 11





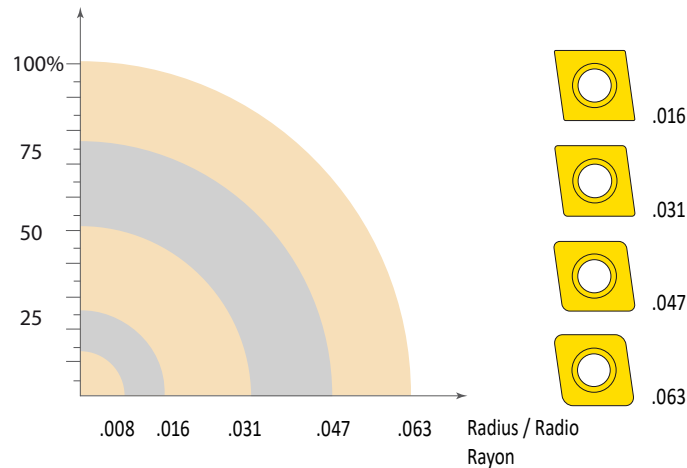
Rigidity in relation to insert thickness / Rigidez en relación con el grosor de la plaquita / Rigidité en relation avec l'épaisseur de plaquette

Picture 12  
 Imagen 12  
 Image 12



Rigidity in relation to insert radius / Rigidez en relación con el radio de la plaquita / Rigidité en relation avec le rayon de plaquette

Picture 13  
 Imagen 13  
 Image 13



Finally, we would like to give some recommendations regarding practical application:

1) Burrs at the output of the tool can result in chipped edges and damage the whole insert. It is therefore necessary to bevel the edge to eliminate the burrs first.

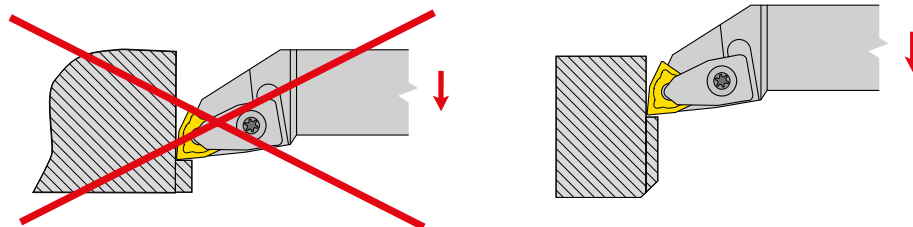
Finalmente, nos gustaría hacer algunas recomendaciones de aplicación práctica:

1) Las rebabas en la salida de la herramienta pueden producir la rotura del filo de corte y la destrucción de toda la plaquita. Por lo tanto, es necesario en primer lugar hacer un chaflán en la pieza para eliminar las rebabas.

Enfin, nous vous donnons quelques recommandations pour une application pratique:

1) Les bavures en sortie de pièce peuvent endommager l'arête de coupe, et parfois détruire entièrement la plaquette. Donc, il est nécessaire de réaliser en premier un chanfrein sur la pièce pour éviter les bavures.

Picture 14  
Imagen 14  
Image 14

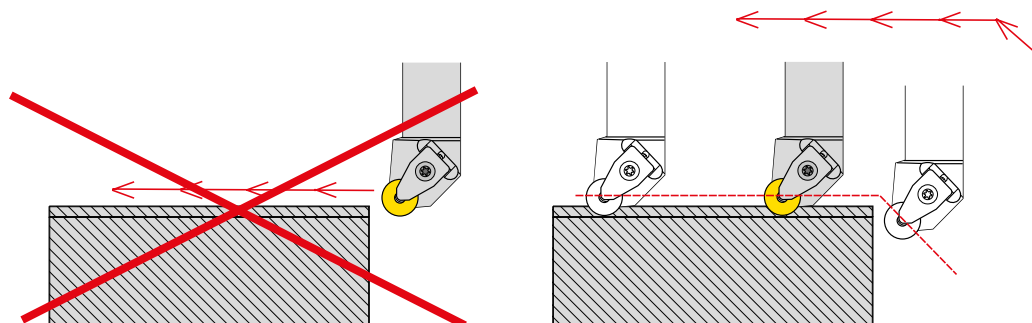


2) It is advisable to modify the standard program (adding the material) as this slows down the creation of burrs on the edge, which increases the durability of the edge and also eliminates the need to bevel the edge.

2) Se recomienda modificar el programa estándar (introduciendo el material); de este modo, se ralentiza la creación de rebabas y se prolonga la duración del filo. Así también se elimina la operación de biselar el filo.

2) Il est recommandé de modifier le programme standard (engagement dans la matière); ceci ralentit la création de bavures sur la pièce et prolonge la durée de vie de l'arête de coupe; cette opération permet également d'éviter l'opération de chanfreinage sur la pièce.

Picture 15  
Imagen 15  
Image 15

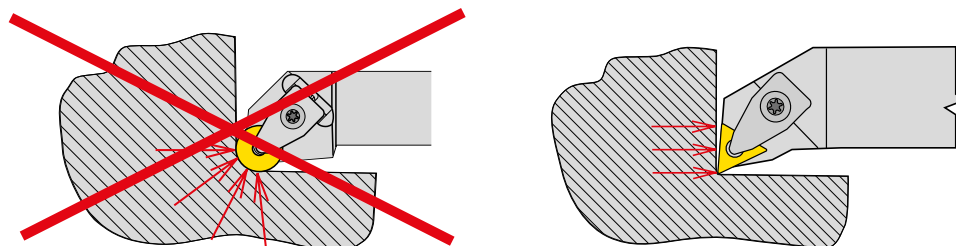


3) If there is a risk of problems occurring as a result of tool vibration, it is better to use inserts with a smaller radius to eliminate radial forces.

3) Si hay riesgo de problemas debido a las vibraciones de la herramienta, deben utilizarse plaquitas con un radio más pequeño para eliminar las fuerzas radiales.

3) Si il y a un risque de problèmes liés aux vibrations de l'outil, il est préférable d'utiliser une plaquette avec un plus petit rayon pour éliminer les forces radiales.

Picture 16  
Imagen 16  
Image 16



Surface quality in turning  $R_{max}$  / Calidad de la superficie por torneado  $R_{max}$  / Qualité de surface en tournage  $R_{max}$

Table 13a  
Tabla 13a  
Tableau 13a

$$R_{max} = \frac{f^2}{8 \cdot r_\epsilon} \cdot 1000$$

f	0.1	0.2	0.4	0.5	0.8	1.0	1.2	1.5	1.6	2.0	2.4	2.5	3.0	3.2	3.5	4.0	5.0	6.0	8.0
0.05	3.13	1.56	0.78	0.63	0.39	0.31	0.26	0.21	0.20	0.16	0.13	0.13	0.10	0.10	0.09	0.08	0.06	0.05	0.04
0.07	6.1	3.06	1.53	1.23	0.77	0.61	0.51	0.41	0.38	0.31	0.26	0.25	0.20	0.19	0.18	0.15	0.12	0.10	0.08
0.08	8.0	4.0	2.00	1.60	1.00	0.80	0.67	0.53	0.50	0.40	0.33	0.32	0.27	0.25	0.23	0.20	0.16	0.13	0.10
0.10		6.3	3.13	2.50	1.56	1.25	1.04	0.83	0.78	0.63	0.52	0.50	0.42	0.39	0.36	0.31	0.25	0.21	0.16
0.12		9.0	4.50	3.60	2.25	1.80	1.50	1.20	1.13	0.90	0.75	0.72	0.60	0.56	0.51	0.45	0.36	0.30	0.23
0.15		14	7.0	5.6	3.52	2.81	2.34	1.88	1.76	1.41	1.17	1.13	0.94	0.88	0.80	0.70	0.56	0.47	0.35
0.16		16	8.0	6.4	4.00	3.20	2.67	2.13	2.00	1.60	1.33	1.28	1.07	1.00	0.91	0.80	0.64	0.53	0.40
0.18		20	10.1	8.1	5.1	4.05	3.38	2.70	2.53	2.03	1.69	1.62	1.35	1.27	1.16	1.01	0.81	0.68	0.51
0.20			13	10.0	6.3	5.0	4.17	3.33	3.13	2.50	2.08	2.00	1.67	1.56	1.43	1.25	1.00	0.83	0.63
0.22			15	12.1	7.6	6.1	5.0	4.03	3.78	3.03	2.52	2.42	2.02	1.89	1.73	1.51	1.21	1.01	0.76
0.25			20	16	9.8	7.8	6.5	5.2	4.88	3.91	3.26	3.13	2.60	2.44	2.23	1.95	1.56	1.30	0.98
0.27			23	18	11.4	9.1	7.6	6.1	5.7	4.56	3.80	3.65	3.04	2.85	2.60	2.28	1.82	1.52	1.14
0.30			28	23	14	11.3	9.4	7.5	7.0	5.6	4.69	4.50	3.75	3.52	3.21	2.81	2.25	1.88	1.41
0.32			32	26	16	13	10.7	8.5	8.0	6.4	5.3	5.1	4.27	4.00	3.66	3.20	2.56	2.13	1.60
0.35			38	31	19	15	13	10.2	9.6	7.7	6.4	6.1	5.1	4.79	4.38	3.83	3.06	2.55	1.91
0.37			43	34	21	17	14	11.4	10.7	8.6	7.1	6.8	5.7	5.3	4.89	4.28	3.42	2.85	2.14
0.40				40	25	20	17	13	13	10.0	8.3	8.0	6.7	6.3	5.7	5.0	4.00	3.33	2.50
0.45				51	32	25	21	17	16	13	10.5	10.1	8.4	7.9	7.2	6.3	5.1	4.22	3.16
0.50					39	31	26	21	20	16	13	13	10.4	9.8	8.9	7.8	6.3	5.2	3.91
0.55					47	38	32	25	24	19	16	15	13	11.8	10.8	9.5	7.6	6.3	4.73
0.60					56	45	38	30	28	23	19	18	15	14	13	11.3	9.0	7.5	5.6
0.65					66	53	44	35	33	26	22	21	18	17	15	13	10.6	8.8	6.6
0.70					77	61	51	41	38	31	26	25	20	19	18	15	12.3	10.2	7.7
0.75					88	70	59	47	44	35	29	28	23	22	20	18	14	11.7	8.8
0.80						80	67	53	50	40	33	32	27	25	23	20	16	13	10.0
0.85						90	75	60	56	45	38	36	30	28	26	23	18	15	11.3
0.90						101	84	68	63	51	42	41	34	32	29	25	20	17	13
0.95						113	94	75	71	56	47	45	38	35	32	28	23	19	14
1.00							104	83	78	63	52	50	42	39	36	31	25	21	16
1.20								120	113	90	75	72	60	56	51	45	36	30	23
1.30								141	132	106	88	85	70	66	60	53	42	35	26
1.40								163	153	123	102	98	82	77	70	61	49	41	31
1.50									176	141	117	113	94	88	80	70	56	47	35
1.60										160	133	128	107	100	91	80	64	53	40
1.70										181	151	145	120	113	103	90	72	60	45
1.80										203	169	162	135	127	116	101	81	68	51
1.90										226	188	181	150	141	129	113	90	75	56
2.00											208	200	167	156	143	125	100	83	63
2.20											252	242	202	189	173	151	121	101	76
2.50													260	244	223	195	156	130	98

Surface quality in turning  $R_a$  / Calidad de la superficie por torneado  $R_a$  / Qualité de surface en tournage  $R_a$

Table 13b  
Tabla 13b  
Tableau 13b

$$R_a = 33337 \cdot \frac{f_z^{1,88}}{r_\epsilon^{0,97}} \text{ [}\mu\text{in]}$$

f	$r_\epsilon$ Radius [in]																
	.004	.008	.016	.031	.039	.047	.063	.071	.078	.094	.118	.125	.137	.157	.196	.235	.314
	Surface $R_a$ [μin]																
.002	58.5	29.9	15.2	7.8	6.3	5.3	4.0	3.5	3.2	2.7	2.2	2.0	1.9	1.6	1.3	1.1	0.8
.003	110.1	56.2	28.7	14.6	11.8	9.9	7.5	6.7	6.0	5.0	4.1	3.8	3.5	3.1	2.5	2.1	1.6
.003	141.5	72.2	36.9	18.8	15.2	12.7	9.6	8.6	7.7	6.5	5.2	4.9	4.5	4.0	3.2	2.7	2.0
.004	-	109.9	56.1	28.6	23.1	19.3	14.6	13.0	11.8	9.9	7.9	7.5	6.8	6.0	4.8	4.1	3.1
.005	-	154.8	79.0	40.3	32.5	27.2	20.6	18.4	16.6	13.9	11.2	10.5	9.6	8.5	6.8	5.7	4.3
.006	-	235.5	120.2	61.4	49.4	41.4	31.3	28.0	25.2	21.1	17.0	16.0	14.7	12.9	10.4	8.7	6.6
.006	-	265.9	135.7	69.3	55.8	46.8	35.4	31.6	28.5	23.9	19.2	18.1	16.6	14.5	11.7	9.8	7.4
.007	-	331.8	169.4	86.5	69.6	58.4	44.1	39.4	35.6	29.8	24.0	22.5	20.7	18.2	14.6	12.2	9.3
.008	-	-	206.5	105.4	84.9	71.1	53.8	48.0	43.3	36.3	29.2	27.5	25.2	22.1	17.8	14.9	11.3
.009	-	-	247.0	126.1	101.6	85.1	64.4	57.4	51.8	43.4	35.0	32.9	30.1	26.5	21.3	17.9	13.5
.010	-	-	314.1	160.4	129.2	108.2	81.9	73.0	65.9	55.2	44.5	41.8	38.3	33.7	27.1	22.7	17.2
.011	-	-	363.0	185.3	149.3	125.1	94.6	84.4	76.2	63.8	51.4	48.3	44.3	38.9	31.3	26.3	19.9
.012	-	-	442.6	225.9	182.0	152.5	115.3	102.9	92.9	77.8	62.7	58.9	54.0	47.4	38.2	32.0	24.2
.013	-	-	499.6	255.1	205.4	172.1	130.2	116.2	104.9	87.9	70.8	66.5	60.9	53.5	43.1	36.1	27.3
.014	-	-	591.3	301.9	243.1	203.7	154.1	137.5	124.1	104.0	83.8	78.7	72.1	63.4	51.0	42.8	32.3
.015	-	-	656.4	335.1	269.9	226.1	171.1	152.6	137.8	115.4	93.0	87.3	80.1	70.3	56.6	47.5	35.9
.016	-	-	-	388.0	312.5	261.8	198.1	176.7	159.5	133.7	107.7	101.1	92.7	81.4	65.6	55.0	41.6
.018	-	-	-	484.2	390.0	326.7	247.2	220.5	199.1	166.8	134.3	126.2	115.7	101.6	81.8	68.6	51.9
.020	-	-	-	590.3	475.4	398.3	301.3	268.8	242.7	203.3	163.8	153.8	141.0	123.9	99.8	83.6	63.2
.022	-	-	-	706.1	568.7	476.5	360.5	321.5	290.3	243.2	195.9	184.0	168.7	148.2	119.4	100.0	75.7
.024	-	-	-	831.6	669.7	561.2	424.5	378.7	341.9	286.5	230.7	216.7	198.7	174.5	140.6	117.8	89.1
.025	-	-	-	966.6	778.5	652.3	493.5	440.2	397.4	333.0	268.2	251.9	230.9	202.9	163.4	136.9	103.6
.027	-	-	-	1111.1	894.9	749.8	567.2	506.0	456.8	382.8	308.3	289.6	265.5	233.2	187.8	157.4	119.1
.029	-	-	-	1265.0	1018.8	853.7	645.8	576.1	520.1	435.8	351.0	329.7	302.2	265.5	213.8	179.2	135.5
.031	-	-	-	-	1150.2	963.8	729.1	650.4	587.2	492.0	396.3	372.2	341.2	299.8	241.4	202.3	153.0
.033	-	-	-	-	1289.1	1080.1	817.1	728.9	658.1	551.4	444.1	417.1	382.4	336.0	270.6	226.7	171.5
.035	-	-	-	-	1435.3	1202.7	909.8	811.6	732.7	614.0	494.5	464.5	425.8	374.1	301.3	252.4	191.0
.037	-	-	-	-	1588.9	1331.3	1007.2	898.4	811.1	679.7	547.4	514.2	471.4	414.1	333.5	279.4	211.4
.039	-	-	-	-	-	1466.1	1109.1	989.4	893.3	748.5	602.8	566.2	519.1	456.0	367.3	307.7	232.8
.047	-	-	-	-	-	-	1562.6	1393.9	1258.5	1054.5	849.2	797.7	731.3	642.4	517.4	433.5	328.0

**SURFACE ROUGHNESS CONVERSION CHART**

$R_a$ (micrometers)	$R_a$ (microinches)	RMS	CLA (N)	$R_{max}$	$R_a$ (micrometers)	$R_a$ (microinches)	RMS	CLA (N)	$R_{max}$
0.025	1	1.1	1	0.3	1.6	63	64.3	63	8.0
0.05	2	2.2	2	0.5	3.2	125	137.5	125	13
0.1	4	4.4	4	0.8	6.3	250	275	250	25
0.2	8	8.8	8	1.2	12.5	500	550	500	50
0.4	16	17.6	16	2.0	25.0	1000	1100	1000	100
0.8	32	32.5	32	4.0	50.0	2000	2200	2000	200

$R_a$  = Roughness Average in micrometers or microinches.  
RMS = Root Mean Square in microinches.

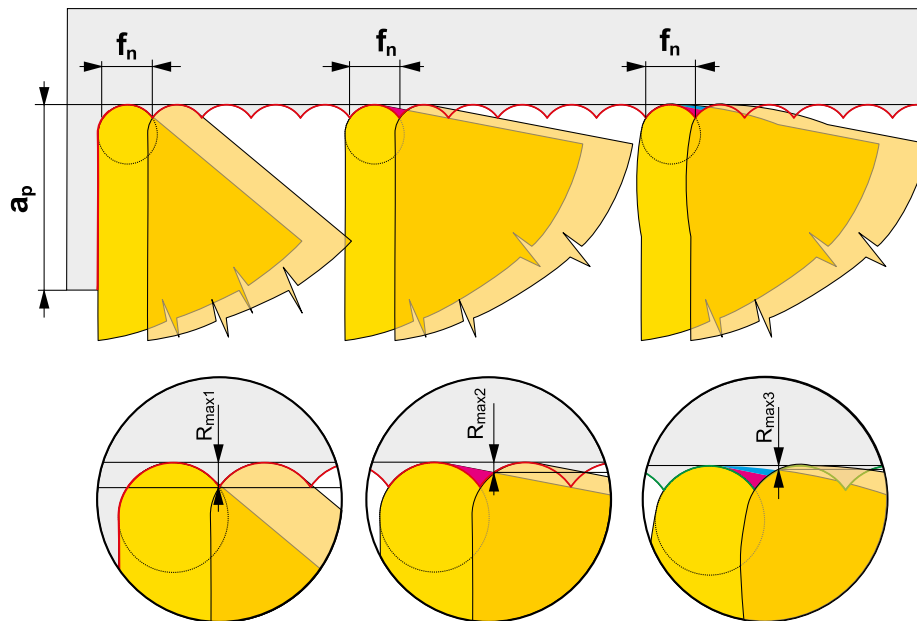
CLA = Center Line Average in microinches.  
 $R_{max}$  = Roughness T total in microns

Values of surface finish  $R_a$  stated in this table apply for turning by cutting indexable inserts with bigger setting angles of minor cutting edge  $\kappa_r'$  (inserts shapes **T...**, **S...**, **D....**, **K...**, **V...**). The surface finish  $R_a$  is better than values mentioned in previous tables, with insert shapes **C...**, **W...** and primarily by inserts with WIPER geometry (tools with setting angle  $\kappa_r = 90 - 95^\circ$ ). The reason is the low value of setting angles of minor cutting edge  $\kappa_r'$ . In this case the value of max. height of profile  $R_{max}$  is reduced to  $R_{max3} < R_{max2} < R_{max1}$  as you can see in picture no. 17 below.

Los valores de acabado de superficie  $R_a$  que se indican en esta tabla se aplican al torneado mediante plaquitas de corte intercambiables con ángulos de posicionamiento mayores del filo de corte secundario  $\kappa_r'$  (plaquitas con formas **T...**, **S...**, **D....**, **K...**, **V...**). El acabado superficial  $R_a$  es mejor que los valores indicados en la tabla en el torneado mediante plaquitas de corte con las formas **C...**, **W...** y principalmente mediante plaquitas con geometría de rascadora (herramientas con ángulo de posicionamiento  $\kappa_r = 90 \div 95^\circ$ ). El motivo es el bajo valor de los ángulos de posicionamiento del filo de corte secundario  $\kappa_r'$ . En este caso, el valor de altura máxima del perfil  $R_{max}$  se reduce a  $R_{max3} < R_{max2} < R_{max1}$  como se puede ver en la imagen n-º 17 siguiente.

Les valeurs de surface  $R_a$  indiquées dans ce tableau s'appliquent pour le tournage par plaquettes de coupe indexables avec de grands angles d'attaque  $\kappa_r'$  de l'arête de coupe secondaire (formes plaquettes **T...**, **S...**, **D....**, **K...**, **V...**). La qualité de surface  $R_a$  est meilleure que les valeurs mentionnées dans le tableau avec des plaquettes de coupe **C...**, **W...** notamment avec des plaquettes WIPER (outils avec un angle d'attaque  $\kappa_r = 90 \div 95^\circ$ ). La raison est la faible valeur des angles d'attaque  $\kappa_r'$  sur l'arête secondaire. Dans ce cas, la valeur maxi de la hauteur du profil  $R_{max}$  est réduite à  $R_{max3} < R_{max2} < R_{max1}$  comme vous pouvez le voir sur l'Image 17.

Picture / Imagen / Image 17



**WORKING AND CONSTRUCTION ANGLES OF TURNING TOOLS**  
**ÁNGULOS DE TRABAJO Y CONSTRUCTIVO DE LA HERRAMIENTA DE TORNEADO**  
**ANGLES DE TRAVAIL ET DE CONSTRUCTION DES OUTILS DE TOURNAGE**

The position and orientation of the cutting edge in relation to the workpiece and its geometric shape determine the cutting angle characteristics.

The angles on the cutting edge are determined by a two coordinate system:

- a) tool
- b) working

**a) tool coordinate system (stationary)**, which is used to determine the cutting edge geometry during design, production and checking. All angles defined in this system are called tool cutting angles. All angles defined by ISO standards according to the insert shape belong in this group.

La posición del filo de corte considerando la pieza de trabajo y su forma geométrica se determinan mediante los ángulos formados por la superficie funcional y los planos auxiliares. Los ángulos del filo de corte se determinan en dos sistemas de coordenadas:

- a) herramienta
- b) trabajo

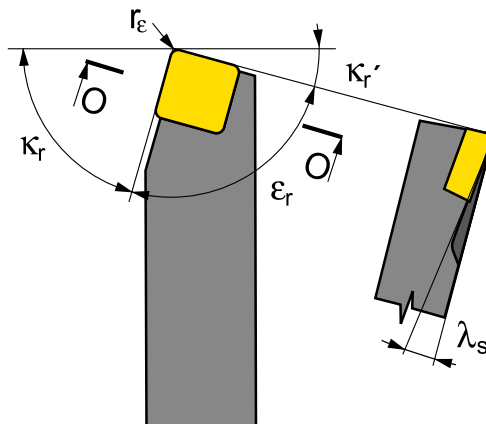
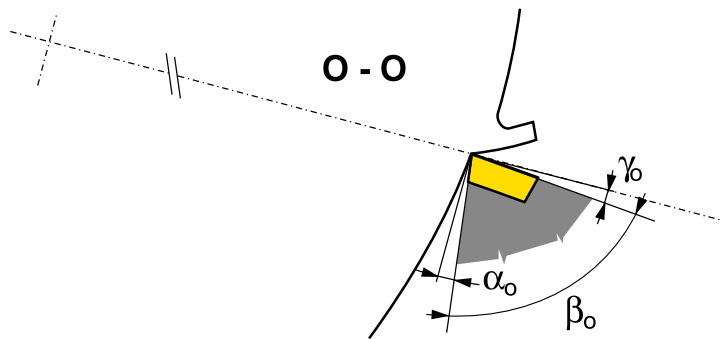
**a) Sistema de coordenadas de herramienta (estacionario)**: se utiliza para la determinación de la geometría del filo de corte en el diseño, la producción y la verificación. Todos los ángulos definidos en este sistema se llaman ángulos de corte de herramienta. Todos los ángulos que se definen según la norma ISO de acuerdo con la forma de la plaqueta pertenecen a este grupo.

La position de l'arête de coupe sur la pièce à usiner et sa forme géométrique sont déterminées par les angles formés par la surface fonctionnelle et les plans auxiliaires. Les angles sur l'arête de coupe sont déterminés sur deux systèmes de coordonnées :

- a) référentiel outil
- b) référentiel de travail

**a) Le système de coordonnées de l'outil (fixe)**, est utilisé pour déterminer la géométrie de l'arête de coupe à la conception, la production et la vérification. Tous les angles définis dans ce système sont appelés angles de coupe de l'outil. Tous les angles définis par la norme ISO, selon la forme de plaquette, rentrent dans ce groupe.

Picture / Imagen / Image 18



**WORKING AND CONSTRUCTION ANGLES OF TURNING TOOLS**  
**ÁNGULOS DE TRABAJO Y CONSTRUCTIVO DE LA HERRAMIENTA DE TORNEADO**  
**ANGLES DE TRAVAIL ET DE CONSTRUCTION DES OUTILS DE TOURNAGE**

**b) working coordinate system**, used to determine the cutting edge geometry during the machining process. These angles are called working angles and they depend on the position of the insert clamped into the tool holder. For example, the cutting insert SNUN ..... has a tool clearance angle  $\alpha = 0^\circ$  and a rake angle  $\gamma = 0^\circ$ , however the insert is clamped in the tool holder to give a working clearance angle  $\alpha_o = 6^\circ$  and a working rake angle  $\gamma_o = -6^\circ$ . The working angles affect the tool angles with pre-formed chip breakers. However the most important are the working angles for the cutting process.

The basic tool angles are indicated in the picture in the basic tool plane (interlaid by the bearing surface of the tool holder) and in the normal tool plane (interlaid across to cutting edge – cut O-O).

We are concerned with the following angles:

**The rake angle  $\gamma_o$**  – substantially affects the cutting process. Its size determines the progress and the intensity of plastic deformation during chip forming; it also determines the value of the cutting forces and the thermal stress on the cutting edge. The range of rake angles is wide, from  $\gamma_o = +25^\circ$  to  $-15^\circ$  for cutting tools with indexable cutting inserts for milling and turning. A positive rake angle improves the chip forming conditions, reduces the cutting forces and reduces the cutting temperature level. A negative rake angle improves the strength of the cutting edge, however it increases plastic deformation during chip forming and thereby also the cutting forces and temperatures.

**Clearance angle  $\alpha_o$**  affects the value of friction between the flank and the machined surface. Increasing the clearance angle  $\alpha_o$  reduces this friction and thereby flank wear as well.

**Wedge angle  $\beta_o$**  is the angle of the cutting insert's wedge. Increasing angle  $\beta_o$  increases the strength of the cutting edge (resistance against shock), however it also increases the cutting resistance.

**Inclination angle of main cutting edge  $\lambda_s$**  – determines the point of first contact between the cutting edge and the workpiece, which is important for interrupted cut. If  $\lambda_s$  is positive, the point of contact is close to the nose of the cutting insert. The negative angle  $\lambda_s$  moves the point of first contact far from the nose and thereby affects the resistance of the cutting edge against mechanical stress. Furthermore,  $\lambda_s$  affects the direction of chip evacuation. If  $\lambda_s$  is negative, the direction of chip evacuation is towards the machined surface. Whereas if  $\lambda_s$  is positive, the direction of chip evacuation is away from the machined surface.

**Setting angle of main cutting edge  $\kappa_r$**  affects the shape of the chip cross-section. Reducing angle  $\kappa_r$  makes the chip thinner at a given feed  $f$  and depth of cut  $a_p$ . Whereas if  $\kappa_r = 90^\circ$  the chip thickness  $h = f$  and the chip width  $b = a_p$  becomes wider.

**Setting angle of minor cutting edge  $\kappa_l$**  together with nose radius  $r_n$  define the final surface quality.

**b) Sistema de coordenadas de trabajo:** se utiliza para la determinación de la geometría del filo de corte durante el proceso de mecanizado. Estos ángulos se llaman algunos de trabajo y dependen de la posición de la plaquita fijada en el portaherramientas. Por ejemplo, el ángulo de separación de la herramienta de la plaquita de corte SNUN .....  $\alpha^\circ = 0^\circ$ , ángulo de desprendimiento  $\gamma = 0^\circ$ . Sin embar  $\gamma_o$ , la plaquita está fijada en el portaherramientas por debajo del ángulo, y por lo tanto, se determinan el ángulo de separación operativo  $\alpha^\circ = 6^\circ$  y el ángulo de desprendimiento operativo  $\gamma_o = -6^\circ$ .

Los ángulos de trabajo afectan a los ángulos de herramienta con formadores de virutas preformados. No obstante, los más importantes son los ángulos de trabajo del proceso de corte.

Los ángulos básicos de la herramienta se indican en parte en el plano básico de la herramienta (superficie del cojinete del portaherramientas) y en parte en el plano normal de la herramienta (filo de corte – corte O-O).

Hablamos de los ángulos siguientes:

**El ángulo de desprendimiento  $\gamma_o$ :** afecta sustancialmente al proceso de corte. El progreso y la extensión de la deformación plástica durante la formación de virutas depende de su dimensión, ya que determina el valor de las fuerzas de corte y la fatiga térmica del filo de corte. La dimensión del ángulo de desprendimiento está en el intervalo  $\gamma_o = +25^\circ$  a  $-15^\circ$  para herramientas de corte con plaquitas de corte intercambiables para fresado y torneado. El ángulo de desprendimiento positivo mejora las condiciones de formación de virutas, reduce la fuerza de corte y el nivel de la temperatura de corte. El ángulo de desprendimiento negativo mejora la resistencia del filo de corte, aunque aumenta la deformación plástica en la formación de virutas y por lo tanto, las fuerzas de corte y las temperaturas.

**Ángulo de separación  $\alpha_o$ :** afecta al valor de fricción entre el flanco y la superficie mecanizada. Con un ángulo de separación  $\alpha_o$  mayor se reduce la fricción y también el desgaste del flanco.

**Ángulo de cuña  $\beta_o$ :** es el ángulo incluido de la plaquita de corte. Con un ángulo  $\beta_o$  mayor aumenta la resistencia del filo de corte (resistencia a los golpes), aunque al mismo tiempo aumenta la resistencia de corte.

**Ángulo de inclinación del filo de corte principal  $\lambda_s$ :** determina el primer punto de contacto del filo de corte con la pieza de trabajo, muy importante para el corte interrumpido. Si el  $\lambda_s$  es positivo, el punto de contacto está cerca de la punta de la plaquita de corte. El ángulo  $\lambda_s$  desplaza el primer punto de contacto lejos de la punta y por lo tanto, afecta a la resistencia de filo a la fatiga mecánica. Además,  $\lambda_s$  afecta a la dirección de evacuación de las virutas. Si  $\lambda_s$  es negativo, la dirección de evacuación de las virutas es hacia la superficie mecanizada. Si  $\lambda_s$  es positivo, la dirección de evacuación de las virutas es hacia fuera de la superficie mecanizada.

**Ángulo de posicionamiento del filo de corte principal  $\kappa_r$ :** afecta a la forma de la sección transversal de las virutas. Con un ángulo  $\kappa_r$  más pequeño, la viruta es más ancha y delgada a un avance  $f$  y una profundidad de corte  $a_p$  determinados. Por otro lado, con  $\kappa_r = 90^\circ$  el espesor de las virutas  $h = f$  y la anchura de las virutas  $b = a_p$ .

**„Ángulo de posicionamiento del filo de corte secundario  $\kappa_l$ :** junto con el radio de punta  $r_n$  define la calidad final de la superficie.“

**b) Le système de coordonnées de travail**, est utilisé pour déterminer la géométrie de l'arête de coupe pendant le processus d'usinage. Ces angles sont appelés angles de travail, ils dépendent de la position de la plaquette fixée dans le porte-outil. Par exemple, une plaquette de coupe SNUN possède un angle de dépouille  $\alpha = 0^\circ$  et un angle de coupe  $\gamma = 0^\circ$ . Toutefois cette plaquette une fois serrée dans le porte-outil conçu avec un angle déterminé, transforme les angles qui deviennent alors: angle de dépouille réel  $\alpha_o = 6^\circ$  et angle de coupe réel  $\gamma_o = -6^\circ$ . Les angles de travail affectent les angles de l'outil équipé de plaquettes à géométrie pressée. Cependant le plus important pour le processus de coupe reste les angles de travail.

Les angles de base de l'outil sont indiqués dans le plan de base de l'outil (à partir de la surface d'appui de l'outil) dans le plan normal à l'outil (suivant le plan de coupe O-O).

Nous parlons des angles suivants :

**L'angle de coupe**  $\gamma_o$  affecte substantiellement le processus de coupe. La propagation et l'importance de la déformation plastique durant la formation du copeau dépend de sa dimension et détermine la valeur de la force de coupe et de la contrainte thermique de l'arête de coupe. La valeur de l'angle de coupe se situe dans un intervalle  $\gamma_o = +25^\circ - 15^\circ$  pour les outils de coupe à plaquettes de coupe indexables pour le fraisage et le tournage. Un angle de coupe positif améliore les conditions de formation du copeau, réduit la force de coupe et le niveau de température de coupe. Un angle de coupe négatif améliore la résistance de l'arête de coupe mais augmente cependant la déformation plastique lors de la formation du copeau, les efforts de coupe et les températures.

**L'angle de dépouille**  $\alpha_o$  affecte les valeurs de frottement entre le flanc et la surface usinée. Avec une augmentation de l'angle de dépouille  $\alpha$  le frottement diminue et ainsi l'usure en dépouille également.

**L'angle de taillant**  $\beta_o$  est l'angle résultant sur la plaquette. Plus l'angle  $\beta_o$  est grand, plus l'arête de coupe est robuste (résistance aux chocs), mais dans le même temps la résistance à la coupe augmente.

**L'angle d'inclinaison de l'arête de coupe principale**  $\lambda_s$  détermine le point de contact de l'arête de coupe avec la pièce à usiner, c'est important pour la coupe interrompue. Si l'angle  $\lambda_s$  est positif, le point de contact est proche de la pointe de la plaquette de coupe. Un angle  $\lambda_s$  négatif déplace le premier point de contact loin de la pointe et agit sur la résistance de l'arête de coupe aux contraintes mécaniques. La modification de l'angle  $\lambda_s$  change la direction de l'évacuation des copeaux. Si  $\lambda_s$  est négatif, l'évacuation des copeaux s'effectue vers la surface usinée. Alors que si  $\lambda_s$  est positif, la direction de l'évacuation des copeaux s'effectue à partir de la surface usinée.

**L'angle d'attaque**  $\kappa_r$  de l'arête de coupe principale affecte la forme de la section du copeau. Avec un plus petit angle  $\kappa_r$  le copeau est plus large et plus fin avec des valeurs d'avance  $f$  et de profondeur de coupe  $a_p$  données. Avec un angle  $\kappa_r = 90^\circ$  l'épaisseur du copeau  $h = f$  et la largeur du copeau  $b = a_p$ .

**L'angle d'attaque**  $\kappa_f$  de l'arête de coupe secondaire et le rayon de pointe  $r_\epsilon$  définissent ensemble la qualité de surface finale.



**CORRECTION OF X AND Z COORDINATES BY RADIUS AND HOLDER**  
**CORRECCIÓN EN COORDENADAS X Y Z SEGÚN EL RADIO Y EL PORTAHERRAMIENTAS**  
**CHANGEMENT DE TAILLE (CORRECTION) SUIVANT LE RAYON UTILISÉ**

**Correction of X and Z coordinates by radius and holder:**  
**Corrección en coordenadas X y Z según el radio y el portaherramientas:**  
**Changement de taille (correction) suivant le rayon utilisé:**

Picture / Imagen / Image 19

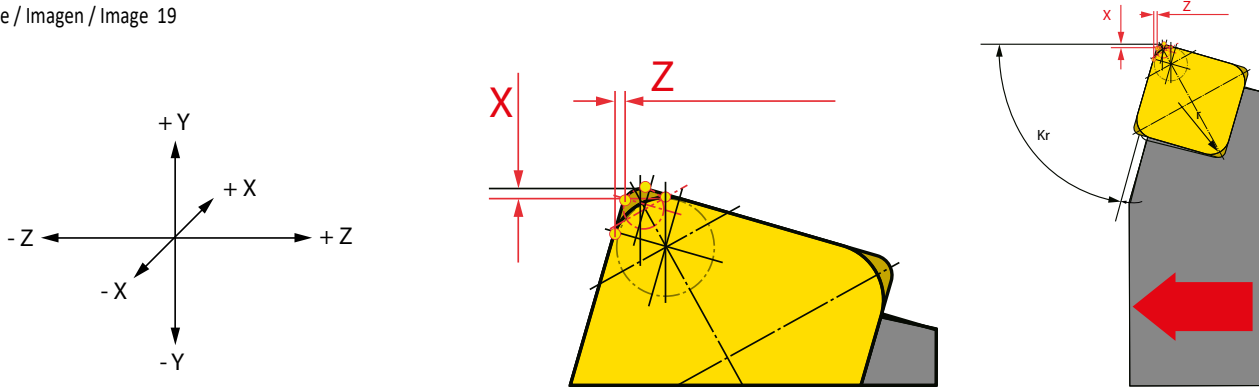


Table / Tabla / Tableau 14

**ATTENTION** – the data is valid for right-hand holders oriented as shown in picture 19. For internal holders, left-hand holders or other orientations it is necessary to correct or mark +/- (to substitute values X/Z)

**ATENCIÓN** – los datos son válidos para el portaherramientas del lado derecho orientado según la Imagen 19. Para los portaherramientas internos, es necesaria la orientación hacia el lado izquierdo o de otro tipo para hacer la corrección de las marcas +/- (para sustituir los valores X/Z)

**ATTENTION** – Les valeurs dans le tableau sont valables pour des outils orientés à droite comme sur l'Image 19. Pour les outils intérieurs, à gauche ou avec d'autres orientations, il est nécessaire de corriger les valeurs avec les signes +/- (pour substituer les valeurs X/Z)

Holder Portaherramientas Outil		Coordinates Coordenadas Coordonnées	Radius .020 Radio .020 Rayon .020	Radius .039 Radio .039 Rayon .039	Radius .059 Radio .059 Rayon .059				
External holder Portaherramientas externo Outils extérieurs	CKJNR/L	x	0.443	0.000	-0.433				
		z	-0.050	0.000	0.050				
Holder Portaherramientas Outil		Coordinates Coordenadas Coordonnées	Radius .008 Radio .008 Rayon .008	Radius .016 Radio .016 Rayon .016	Radius .031 Radio .031 Rayon .031	Radius .047 Radio .047 Rayon .047	Radius .063 Radio .063 Rayon .063	Radius .094 Radio .094 Rayon .094	Radius .125 Radio .125 Rayon .125
External holder Portaherramientas externo Outils extérieurs	DCLNR/L	x	0.00236	0.00157	0.00000	-0.00157	-0.00315	-0.00630	-0.00945
		z	-0.00244	-0.00165	0.00000	0.00165	0.00327	0.00654	0.00980
	DDJNR/L	x	0.02031	0.01366	0.00000	-0.01295	-0.02626	-0.05287	-0.07949
		z	-0.00220	-0.00161	0.00000	0.00087	0.00213	0.00461	0.00709
	DSBNR/L	x	0.00992	0.00669	0.00000	-0.00622	-0.01268	-0.02555	-0.03846
		z	0.01661	0.01102	0.00000	-0.01122	-0.02236	-0.04465	-0.06693
	DSDNN	x	0.00000	0.00000	0.00000	0.00000	0.00000	0.00000	0.00000
		z	0.00972	0.00650	0.00000	-0.00650	-0.01299	-0.02594	-0.03894
	DSKNR/L	x	0.00528	0.00350	0.00000	-0.00350	-0.00701	-0.01409	-0.02114
		z	-0.00657	-0.00437	0.00000	0.00437	0.00874	0.01748	0.02626
	DSSNR/L	x	0.00000	0.00000	0.00000	0.00000	0.00000	0.00000	0.00000
		z	0.00965	0.00638	0.00000	-0.00657	-0.01268	-0.02606	-0.03906
	DTFNR/L	x	0.01677	0.01118	0.00000	-0.01118	-0.02240	-0.04476	-0.06713
		z	0.00114	0.00075	0.00000	-0.00075	-0.00157	-0.00307	-0.00461

**CORRECTION OF X AND Z COORDINATES BY RADIUS AND HOLDER**  
**CAMBIO DE TAMAÑO (CORRECCIÓN) SEGÚN EL RADIO UTILIZADO**  
**CHANGEMENT DE TAILLE (CORRECTION) SUIVANT LE RAYON UTILISÉ**

Holder Portaherramientas Outil		Coordinates Coordenadas Coordonnées	Radius .008 Radio .008 Rayon .008	Radius .016 Radio .016 Rayon .016	Radius .031 Radio .031 Rayon .031	Radius .047 Radio .047 Rayon .047	Radius .063 Radio .063 Rayon .063	Radius .094 Radio .094 Rayon .094	Radius .125 Radio .125 Rayon .125	
External holder Portaherramientas externo Outils extérieurs	DTGNR/L	x	0.01720	0.01157	0.00000	-0.01091	-0.02213	-0.04461	-0.06705	
		z	0.00000	0.00000	0.00000	0.00000	0.00000	0.00000	0.00000	
	DVJNR/L	x	0.00248	0.00165	0.00000	-0.00165	-0.00331	-0.00665	-0.00996	
		z	0.04858	0.03240	0.00000	-0.03240	-0.06480	-0.12957	-0.19437	
	DVPNR/L	x	0.03110	0.02075	0.00000	-0.02075	-0.04150	-0.08299	-0.12445	
		z	0.03283	0.02181	0.00000	-0.02181	-0.04366	-0.08728	-0.13094	
DWLNR/L	x	0.00240	0.00173	0.00000	-0.00102	-0.00240	-0.00516	-0.00787		
	z	-0.00248	-0.00177	0.00000	0.00106	0.00244	0.00528	0.00811		
Internal holder Portaherramientas interno Outils intérieurs	DCLNR/L	x	-0.00209	-0.00138	0.00000	0.00138	0.00276	0.00551	0.00827	
		z	-0.00236	-0.00157	0.00000	0.00157	0.00315	0.00626	0.00941	
	DDUNR/L	x	-0.02016	-0.01343	0.00000	0.00134	0.02689	0.05374	0.08059	
		z	-0.00287	-0.00193	0.00000	0.00193	0.00382	0.00768	0.01150	
	DTFNR/L	x	-0.01673	-0.01138	0.00000	0.01000	0.02071	0.04209	0.06350	
		z	0.00000	0.00000	0.00000	0.00000	0.00000	0.00000	0.00000	
	DVUNR/L	x	0.04937	-0.03291	0.00000	0.03291	0.06579	0.13161	0.19740	
		z	-0.00508	-0.00339	0.00000	0.00339	0.00677	0.01354	0.02031	
	DWLNR/L	x	-0.00209	-0.00138	0.00000	0.00138	0.00276	0.00551	0.00827	
		z	-0.00236	-0.00157	0.00000	0.00157	0.00315	0.00626	0.00941	
	External holder Portaherramientas externo Outils extérieurs	MTJNR/L	x	0.01720	0.01157	0.00000	-0.01091	-0.02213	-0.04461	-0.06705
			z	0.00000	0.00000	0.00000	0.00000	0.00000	0.00000	0.00000
MVJNR/L		x	0.04972	0.03335	0.00000	-0.03224	-0.06500	-0.13059	-0.19614	
		z	-0.00295	-0.00217	0.00000	0.00098	0.00256	0.00575	0.00890	
MWLNR/L		x	0.02398	0.00173	0.00000	-0.00102	-0.00240	-0.00516	-0.00787	
		z	-0.00248	-0.00177	0.00000	0.00106	0.00244	0.00528	0.00811	
PCBNR/L		x	0.00177	0.00130	0.00000	-0.00063	-0.00157	-0.00346	-0.00539	
		z	0.00504	0.00327	0.00000	-0.00378	-0.00728	-0.01433	-0.02138	
PCKNR/L		x	0.00673	0.00453	0.00000	-0.00433	-0.00878	-0.01764	-0.02646	
		z	0.02697	0.01799	0.00000	-0.01799	-0.03598	-0.07193	-0.10791	
PCLNR/L		x	0.00240	0.00173	0.00000	-0.00102	-0.00240	-0.00516	-0.00787	
		z	-0.00248	-0.00177	0.00000	0.00106	0.00244	0.00528	0.00811	
PDJNR/L		x	0.02031	0.01366	0.00000	-0.01295	-0.02626	-0.05287	-0.07949	
		z	-0.00220	-0.00161	0.00000	0.00087	0.00213	0.00461	0.00709	
PDNNR/L		x	0.02752	0.01846	0.00000	-0.01783	-0.03602	-0.07232	-0.10862	
		z	0.02063	0.01370	0.00000	-0.01406	-0.02795	-0.05571	-0.08346	
PDXNR/L		x	0.01783	0.01201	0.00000	-0.01134	-0.02299	-0.04634	-0.06969	
		z	-0.00614	-0.00421	0.00000	0.00346	0.00728	0.01496	0.02264	
PLBNR/L		x	0.00539	0.00370	0.00000	-0.00307	-0.00642	-0.01319	-0.01996	
		z	0.00602	0.00394	0.00000	-0.00433	-0.00866	-0.01705	-0.02543	
PSBNR/L		x	0.00539	0.00370	0.00000	-0.00307	-0.00642	-0.01319	-0.01996	
		z	0.00602	0.00394	0.00000	-0.00433	-0.00866	-0.01705	-0.02543	
PSDNN		x	0.00992	0.00669	0.00000	-0.00622	-0.01268	-0.02555	-0.03846	
		z	0.01661	0.01102	0.00000	-0.01122	-0.02236	-0.04465	-0.06689	
PSKNR/L		x	0.00551	0.00370	0.00000	-0.00354	-0.00598	-0.01441	-0.02165	
		z	0.02260	0.01508	0.00000	-0.01512	-0.03020	-0.06035	-0.09055	
PSSNR/L		x	0.00969	0.00646	0.00000	-0.00646	-0.01291	-0.02583	-0.03870	
		z	0.01669	0.01114	0.00000	-0.01114	-0.02228	-0.04453	-0.06681	
PTFNR/L		x	0.00000	0.00000	0.00000	0.00000	0.00000	0.00000	0.00000	
		z	-0.01618	-0.00957	0.00000	0.01689	0.03012	0.05657	0.08307	
PTGNR/L		x	0.01720	0.01157	0.00000	-0.01091	-0.02213	-0.04461	-0.06705	
		z	0.00000	0.00000	0.00000	0.00000	0.00000	0.00000	0.00000	
PTTNR/L		x	0.02366	0.01587	0.00000	-0.01531	-0.03087	-0.06201	-0.09319	
		z	0.02043	0.01358	0.00000	-0.01394	-0.02768	-0.05516	-0.08264	
PWLNR/L		x	0.02398	0.00173	0.00000	-0.00102	-0.00240	-0.00516	-0.00787	
		z	-0.00248	-0.00177	0.00000	0.00106	0.00244	0.00528	0.00811	

**CORRECTION OF X AND Z COORDINATES BY RADIUS AND HOLDER  
CAMBIO DE TAMAÑO (CORRECCIÓN) SEGÚN EL RADIO UTILIZADO  
CHANGEMENT DE TAILLE (CORRECTION) SUIVANT LE RAYON UTILISÉ**

Holder Portaherramientas Outil		Coordinates Coordenadas Coordonnées	Radius .008 Radio .008 Rayon .008	Radius .016 Radio .016 Rayon .016	Radius .031 Radio .031 Rayon .031	Radius .047 Radio .047 Rayon .047	Radius .063 Radio .063 Rayon .063	Radius .094 Radio .094 Rayon .094	Radius .125 Radio .125 Rayon .125
Internal holder Portaherramientas interno Outils intérieurs	PCLNR/L	x	-0.00240	-0.00181	0.00000	0.00047	0.00157	0.00386	0.00614
		z	-0.00244	-0.00185	0.00000	0.00059	0.00181	0.00630	0.00665
	PDUNR/L	x	-0.01969	-0.01335	0.00000	0.01201	0.02469	0.05004	0.07539
		z	-0.00205	-0.00157	0.00000	0.00024	0.00114	0.00299	0.00480
	PSKNR/L	x	-0.00602	-0.00382	0.00000	0.00248	0.00563	0.01193	0.01823
		z	0.00539	0.00386	0.00000	-0.00488	-0.00921	-0.01795	-0.02665
	PTFNR/L	x	-0.01673	-0.01138	0.00000	0.01000	0.02071	0.04209	0.06350
		z	0.00000	0.00000	0.00000	0.00000	0.00000	0.00000	0.00000
	PWLNR/L	x	-0.00236	-0.00181	0.00000	0.00047	0.00169	0.00386	0.00614
		z	-0.00256	-0.00193	0.00000	0.00047	0.00157	0.00413	0.00654
	SCACR/L	x	0.00453	0.00303	0.00000	-0.00303	-0.00602	-0.01209	-0.01811
		z	0.00000	0.00000	0.00000	0.00000	0.00000	0.00000	0.00000
SCBCR/L	x	0.00165	0.00110	0.00000	-0.00110	-0.00217	-0.00437	-0.00654	
	z	0.00512	0.00343	0.00000	-0.00343	-0.00685	-0.01366	-0.02051	
SCDCR/L	x	0.00000	0.00000	0.00000	0.00000	0.00000	0.00000	0.00000	
	z	-0.01098	-0.00732	0.00000	0.00732	0.01465	0.02933	0.04398	
SCFCR/L	x	0.00000	0.00000	0.00000	0.00000	0.00000	0.00000	0.00000	
	z	-0.00488	-0.00327	0.00000	0.00327	0.00654	0.01303	0.01957	
SCLCR/L	x	0.00236	0.00157	0.00000	-0.00157	-0.00315	-0.00630	-0.00945	
	z	-0.00244	-0.00165	0.00000	0.00165	0.00327	0.00654	0.00980	
SDJCR/L	x	0.02047	0.01362	0.00000	-0.01362	-0.02728	-0.05457	-0.08181	
	z	-0.00236	-0.00157	0.00000	0.00157	0.00315	0.00634	0.00949	
SDNCN	x	0.02752	0.01835	0.00000	-0.01835	-0.03673	-0.07343	-0.11016	
	z	0.00000	0.00000	0.00000	0.00000	0.00000	0.00000	0.00000	
SEGCR/L	x	0.00000	0.00000	0.00000	0.00000	0.00000	0.00000	0.00000	
	z	-0.00717	-0.00476	0.00000	0.00476	0.00957	0.01909	0.02866	
SSBCR/L	x	0.00531	0.00354	0.00000	-0.00354	-0.00709	-0.01417	-0.02122	
	z	0.00610	0.00409	0.00000	-0.00409	-0.00815	-0.01630	-0.02445	
SSDCN	x	0.00980	0.00654	0.00000	-0.00654	-0.01303	-0.02610	-0.03913	
	z	0.00000	0.00000	0.00000	0.00000	0.00000	0.00000	0.00000	
SSKCR/L	x	-0.01480	-0.02035	0.00000	-0.04264	-0.05378	-0.07602	-0.09831	
	z	-0.00531	-0.00354	0.00000	0.00354	0.00709	0.01417	0.02122	
STCFR/L	x	0.00000	0.00000	0.00000	0.00000	0.00000	0.00000	0.00000	
	z	-	-	0.00000	-	-	-	-	
STJCR/L	x	0.01598	0.01067	0.00000	-0.01067	-0.02134	-0.04268	-0.06402	
	z	-0.00213	-0.00142	0.00000	0.00142	0.00280	0.00563	-0.00843	
SVACR/L	x	00/0	.004/-0.004	-	-	-	-	-	
	z	00/0	.004/-0.004	-	-	-	-	-	
SVGCR/L	x	0.00000	0.00000	0.00000	0.00000	0.00000	0.00000	0.00000	
	z	-0.05130	-0.03421	0.00000	0.03421	0.06839	0.13681	0.20520	
SVHBR/L	x	0.04071	0.02717	0.00000	-0.02717	-0.05429	-0.10862	-0.16291	
	z	-0.02142	-0.01429	0.00000	0.01429	0.02858	0.05717	0.08575	
SVHCR/L	x	0.04071	0.02717	0.00000	-0.02717	-0.05429	-0.10862	-0.16291	
	z	-0.02142	-0.01429	0.00000	0.01429	0.02858	0.05717	0.08575	
SVJBR/L	x	0.04996	0.03331	0.00000	-0.03331	-0.06661	-0.13323	-0.19984	
	z	-0.00390	-0.00260	0.00000	0.00260	0.00520	0.01035	0.01555	
SVJCR/L	x	0.04996	0.03331	0.00000	-0.03331	-0.06661	-0.13323	-0.19984	
	z	-0.00390	-0.00260	0.00000	0.00260	0.00520	0.01035	0.01555	
SVPBR/L	x	0.03193	0.02130	0.00000	-0.02130	-0.04256	-0.08512	-0.12772	
	z	-0.03193	-0.02130	0.00000	0.02130	0.04256	0.08512	0.12772	
SVPCR/L	x	0.03193	0.02130	0.00000	-0.02130	-0.04256	-0.08512	-0.12772	
	z	-0.03193	-0.02130	0.00000	0.02130	0.04256	0.08512	0.12772	
SVVBN	x	0.05492	0.03661	0.00000	-0.03661	-0.07323	-0.14650	-0.21972	
	z	0.00000	0.00000	0.00000	0.00000	0.00000	0.00000	0.00000	

**CORRECTION OF X AND Z COORDINATES BY RADIUS AND HOLDER**  
**CAMBIO DE TAMAÑO (CORRECCIÓN) SEGÚN EL RADIO UTILIZADO**  
**CHANGEMENT DE TAILLE (CORRECTION) SUIVANT LE RAYON UTILISÉ**

Holder Portaherramientas Outil		Coordinates Coordenadas Coordonnées	Radius .008 Radio .008 Rayon .008	Radius .016 Radio .016 Rayon .016	Radius .031 Radio .031 Rayon .031	Radius .047 Radio .047 Rayon .047	Radius .063 Radio .063 Rayon .063	Radius .094 Radio .094 Rayon .094	Radius .125 Radio .125 Rayon .125
External holder Portaherramientas externo Outils extérieurs	SVVCN	x	0.05492	0.03661	0.00000	-0.03661	-0.07323	-0.14650	-0.21972
		z	0.00000	0.00000	0.00000	0.00000	0.00000	0.00000	0.00000
	SVXBR/L	x	0.04728	0.03154	0.00000	-0.00315	-0.06303	-0.12606	-0.18913
		z	-0.01020	-0.00681	0.00000	0.00681	0.01358	0.02720	0.04079
	SVXCR/L	x	0.04728	0.03154	0.00000	-0.00315	-0.06303	-0.12606	-0.18913
		z	-0.01020	-0.00681	0.00000	0.00681	0.01358	0.02720	0.04079
	SWLCR/L	x	0.00236	0.00157	0.00000	-0.00157	-0.00315	-0.00630	-0.00945
		z	-0.00236	-0.00157	0.00000	0.00157	0.00315	0.00630	0.00945
	SCFCR/L	x	-0.01654	-0.01102	0.00000	0.01102	0.02205	0.04413	0.06618
		z	0.00000	0.00000	0.00000	0.00000	0.00000	0.00000	0.00000
SCKCR/L	x	-0.00157	-0.00106	0.00000	0.00106	0.00213	0.00425	0.00634	
	z	0.00512	0.00343	0.00000	-0.00343	-0.00685	-0.01370	0.02051	
SCLCR/L	x	-0.00228	-0.00154	0.00000	0.00154	0.00307	0.00610	0.00917	
	z	-0.00244	-0.00165	0.00000	0.00165	0.00327	0.00654	0.00980	
SCXCR/L	x	-0.00701	-0.00469	0.00000	0.00469	0.00933	0.01866	0.02799	
	z	0.00000	0.00000	0.00000	0.00000	0.00000	0.00000	0.00000	
SDQCR/L	x	-0.01217	-0.00764	0.00000	0.00811	0.01622	0.03248	0.04870	
	z	-0.01220	-0.00811	0.00000	0.01055	0.01965	0.03783	0.05602	
SDUCR/L	x	-0.01984	-0.01323	0.00000	0.01323	0.02646	0.05291	0.07937	
	z	-0.00232	-0.00154	0.00000	0.00161	0.00323	0.00638	0.00953	
SDZCR/L	x	-0.02047	-0.01362	0.00000	0.01362	0.02728	0.0547	0.08181	
	z	0.00232	0.00154	0.00000	-0.00161	-0.00323	-0.00638	-0.00953	
SELPR/L	x	-0.00496	-0.00331	0.00000	0.00331	0.00661	0.01327	0.02021	
	z	-0.00260	-0.00173	0.00000	0.00173	0.00346	0.00693	0.01039	
SEUCR/L	x	-0.00587	-0.00390	0.00000	0.00390	0.00783	0.01563	0.02346	
	z	-0.00161	-0.00106	0.00000	0.00106	0.00209	0.00421	0.00630	
SEUPR/L	x	-0.00583	-0.00390	0.00000	0.00390	0.00780	0.01559	0.02335	
	z	-0.00157	-0.00106	0.00000	0.00106	0.00209	0.00421	0.00630	
SEXPR/L	x	-0.01512	-0.01008	0.00000	0.01008	0.02016	0.04031	0.06051	
	z	0.00000	0.00000	0.00000	0.00000	0.00000	0.00000	0.00000	
SSSCR/L	x	-0.00980	-0.00654	0.00000	0.00654	0.01303	0.02610	0.03913	
	z	0.00000	0.00000	0.00000	0.00000	0.00000	0.00000	0.00000	
STFCR/L	x	-0.01705	-0.01138	0.00000	0.01138	0.02272	0.04543	0.06815	
	z	0.00000	0.00000	0.00000	0.00000	0.00000	0.00000	0.00000	
SVLCR/L	x	-0.04894	-0.03260	0.00000	0.03260	0.06524	0.13047	0.19571	
	z	0.00941	0.02724	0.00000	-0.00425	-0.00846	-0.01693	-0.02539	
SVQBR/L	x	-0.04043	-0.02693	0.00000	0.02717	0.05390	0.10780	0.16165	
	z	-0.02146	-0.01429	0.00000	0.01429	0.02858	0.05717	0.08575	
SVQCR/L	x	-0.04043	-0.02693	0.00000	0.02717	0.05390	0.10780	0.16165	
	z	-0.02146	-0.01429	0.00000	0.01429	0.02858	0.05717	0.08575	
SVUBR/L	x	-0.04957	-0.03307	0.00000	0.03307	0.06610	0.13220	0.19831	
	z	0.00390	-0.00260	0.00000	0.00260	0.00520	0.01035	0.01555	
SVUCR/L	x	-0.04957	-0.03307	0.00000	0.03307	0.06610	0.13220	0.19831	
	z	0.00390	-0.00260	0.00000	0.00260	0.00520	0.01035	0.01555	
SVXCR/L	x	-0.03610	-0.02406	0.00000	0.02406	0.04811	0.09626	0.14437	
	z	-0.02740	-0.01827	0.00000	0.01827	0.03654	0.07307	0.10957	
SWLCR/L	x	-0.00236	-0.00154	0.00000	0.00154	0.00311	0.00622	0.00933	
	z	-0.00236	-0.00157	0.00000	0.00157	0.00315	0.00630	0.00945	
SWUCR/L	x	-0.00315	-0.00209	0.00000	0.00209	0.00421	0.00839	0.01256	
	z	-0.00134	-0.00094	0.00000	0.00094	0.00193	0.00386	0.00575	

**ATTENTION** – the data is valid for right-hand holders oriented as shown in picture 19. For internal holders, left-hand holders or other orientations it is necessary to correct or mark +/- (to substitute values X/Z)

**ATENCIÓN** – los datos son válidos para el portaherramientas del lado derecho orientado según la Imagen 19. Para los portaherramientas internos, es necesaria la orientación hacia el lado izquierdo o de otro tipo para hacer la corrección de las marcas +/- (para sustituir los valores X/Z)

**ATTENTION** – Les valeurs dans le tableau sont valables pour des outils orientés à droite comme sur l'Image 19. Pour les outils intérieurs, à gauche ou avec d'autres orientations, il est nécessaire de corriger les valeurs avec les signes +/- (pour substituer les valeurs X/Z)

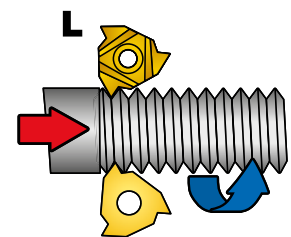
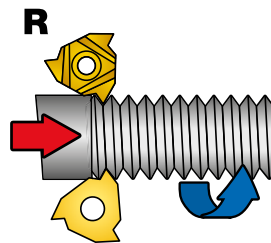
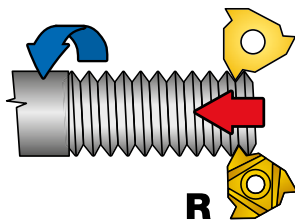
The choice of production method is influenced by the workpiece and the machine. Workpiece – external or internal thread, right- or left-hand thread. Machine – right- or left-hand tool. For guidance, you can use table 15 below.

La pieza de trabajo y la máquina influyen en la elección del método de producción. Pieza de trabajo: rosca interna o externa, a derecha o a izquierda. Máquina: herramienta a derecha o a izquierda. Puede utilizar la Tabla 15 siguiente.

Le choix de la méthode d'usinage est guidé par la pièce à réaliser et la machine. Pièce avec filetage extérieur ou intérieur, sens des filets à droite ou à gauche. Tourelle placée à l'avant ou à l'arrière. Vous pouvez utiliser les tableaux N° 15.

Table / Tabla / Tableau 15a

**EXTERNAL THREAD, RIGHT-HAND / ROSCA EXTERNA, DERECHA / FILETAGE EXTÉRIEUR À DROITE**



**EXTERNAL THREAD, LEFT-HAND / ROSCA EXTERNA, IZQUIERDA / FILETAGE EXTÉRIEUR À GAUCHE**

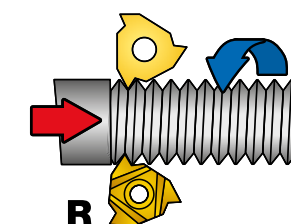
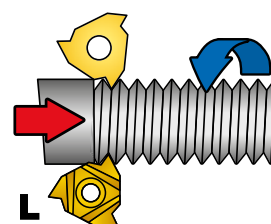
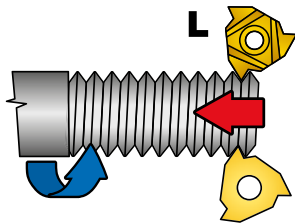
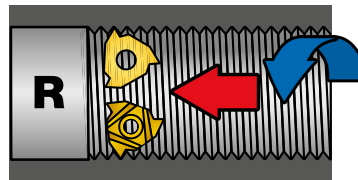
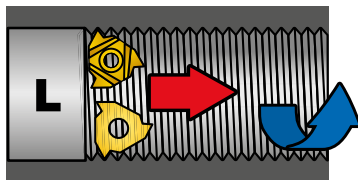


Table / Tabla / Tableau 15b

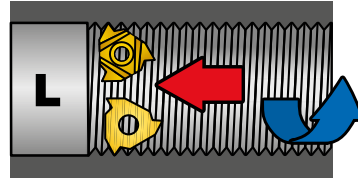
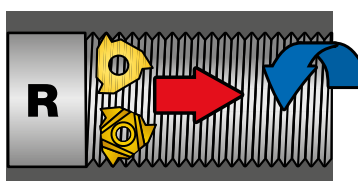
**INTERNAL THREAD, RIGHT-HAND / ROSCA INTERNA, DERECHA / FILETAGE INTÉRIEUR À DROITE**



Movement of the workpiece  
Movimiento de la pieza  
Mouvement de la pièce

Tool movement  
Movimiento de la herramienta  
Mouvement de l'outil

**INTERNAL THREAD, LEFT-HAND / ROSCA INTERNA, IZQUIERDA / FILETAGE INTÉRIEUR À GAUCHE**



**L / R** Insert design  
Tipo de inserto  
Sens de coupe plaquette

The following formula can be used to calculate the helix angle:

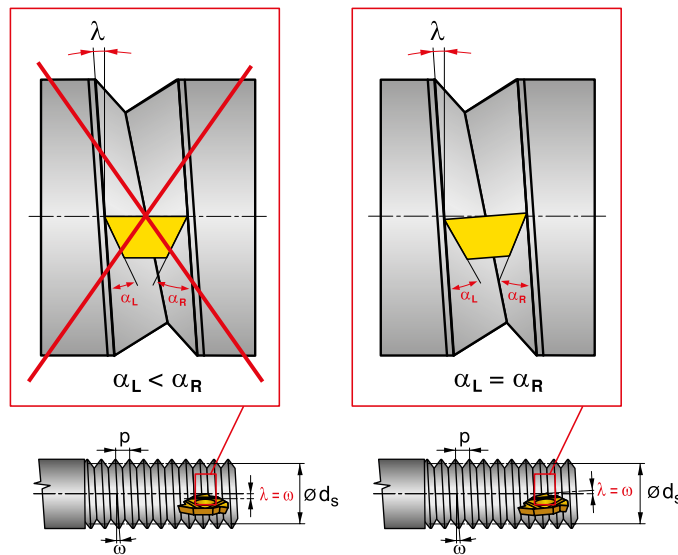
Se puede utilizar la siguiente fórmula para calcular el ángulo de hélice:

La formule suivante est à utiliser pour le calcul de l'angle d'hélice :

$$\operatorname{tg} \omega = \frac{P}{d_s \cdot \pi}$$

$\omega$	helix angle	[°]	P	pitch	[in]	$d_s$	pitch diameter	[in]
$\omega$	ángulo de hélice	[°]	P	paso	[in]	$d_s$	diámetro de paso	[in]
$\omega$	ângulo da hélice	[°]	P	passo	[in]	$d_s$	diâmetro do passo	[in]
$\omega$	angle d'hélice	[°]	P	pas	[in]	$d_s$	diamètre du pas	[in]

Picture / Imagen / Image 20



To generate the correct shape on the thread and uniform wear on the insert, the cutting edge helix angle should be equal to the thread lead angle.

Tool holders are usually supplied with a helix angle  $\lambda = 1.5^\circ$ . A different helix angle can be selected by changing the anvil.

Use the following graph (picture 21) or table (table 16) to choose the correct anvil.

Pour réaliser la forme correcte du filet et obtenir une usure régulière sur l'arête de coupe, l'angle d'hélice de l'arête doit être égal à l'angle d'inclinaison du filet.

Les outils sont généralement fournis avec un angle d'hélice  $\lambda = 1,5^\circ$ . Un angle d'hélice différent peut être choisi en changeant la cale.

Voir le graphique ou le tableau ci-dessous pour choisir la bonne cale pentée. Tableau 16 et Image 21.

Para generar la forma correcta de la rosca y un desgaste uniforme en la plaquita el ángulo de hélice del filo de corte debe ser igual al ángulo de inclinación base de la rosca.

Normalmente los portaherramientas se suministran con un ángulo de hélice  $\lambda = 1,5^\circ$ . Se puede seleccionar un ángulo de hélice diferente cambiando la base.

Utilice el gráfico o la tabla siguientes para elegir la base correcta. Tabla 16 y gráfica en Imagen 21.

Table 16. – Choice of shim  
Tabla 16 – Selección de la base  
Tableau 16 – Choix de l'assise

Helix angle $\lambda$ Ángulo de hélice $\lambda$ Angle d'hélice $\lambda$	Positive Positivo Positive					Negative Negativo Négative		for grooving inserts Para placas de ranurado Pour plaquettes à gorge TN16... ZZ, TN22... ZZ
	4.5°	3.5°	2.5°	1.5°	0.5°	-0.5°	-1.5°	
Tool holder / Portaherramientas Porte-outil	Anvil specification / Especificación de la base Spécification de base							
SER .... .16; SIL .... .16	PE16+4.5	PE16+3.5	PE16+2.5	PE16+1.5	PE16+0.5	PE16-0.5	PE16-1.5	PE16ZZ
SEL .... .16; SIR .... .16	PI16+4.5	PI16+3.5	PI16+2.5	PI16+1.5	PI16+0.5	PI16-0.5	PI16-1.5	PI16ZZ
SER .... .22; SIL .... .22	PE22+4.5	PE22+3.5	PE22+2.5	PE22+1.5	PE22+0.5	PE22-0.5	PE22-1.5	PE22ZZ
SEL .... .22; SIR .... .22	PI22+4.5	PI22+3.5	PI22+2.5	PI22+1.5	PI22+0.5	PI22-0.5	PI22-1.5	PI22ZZ
SER-S .... .22; SIL-S .... .22	PE22S+4.5	PE22S+3.5	PE22S+2.5	PE22S+1.5	PE22S+0.5	PE22S-0.5	PE22S-1.5	-
SEL-S .... .22; SIR-S .... .22	PI22S+4.5	PI22S+3.5	PI22S+2.5	PI22S+1.5	PI22S+0.5	PI22S-0.5	PI22S-1.5	-

Tool holders are usually supplied with a helix angle  $\lambda = 1.5^\circ$ . A different helix angle can be selected by changing the anvil.

Shims for holders SER-S .... .., SIR-S .... .. are marked with „S“

Nota: Normalmente los portaherramientas se suministran con un ángulo de hélice  $\lambda = 1.5^\circ$ . Se puede seleccionar un ángulo de hélice diferente cambiando la base. Las bases para portaherramientas SER-S .... .., SIR-S .... .. están marcadas con una „S“

Les outils sont généralement fournis avec un angle d'hélice  $\lambda = 1.5^\circ$ . Un angle d'hélice différent peut être choisi en changeant la cale.

Les assises pour porte-outils SER-S .... .., SIR-S .... .. sont marquées avec un „S“

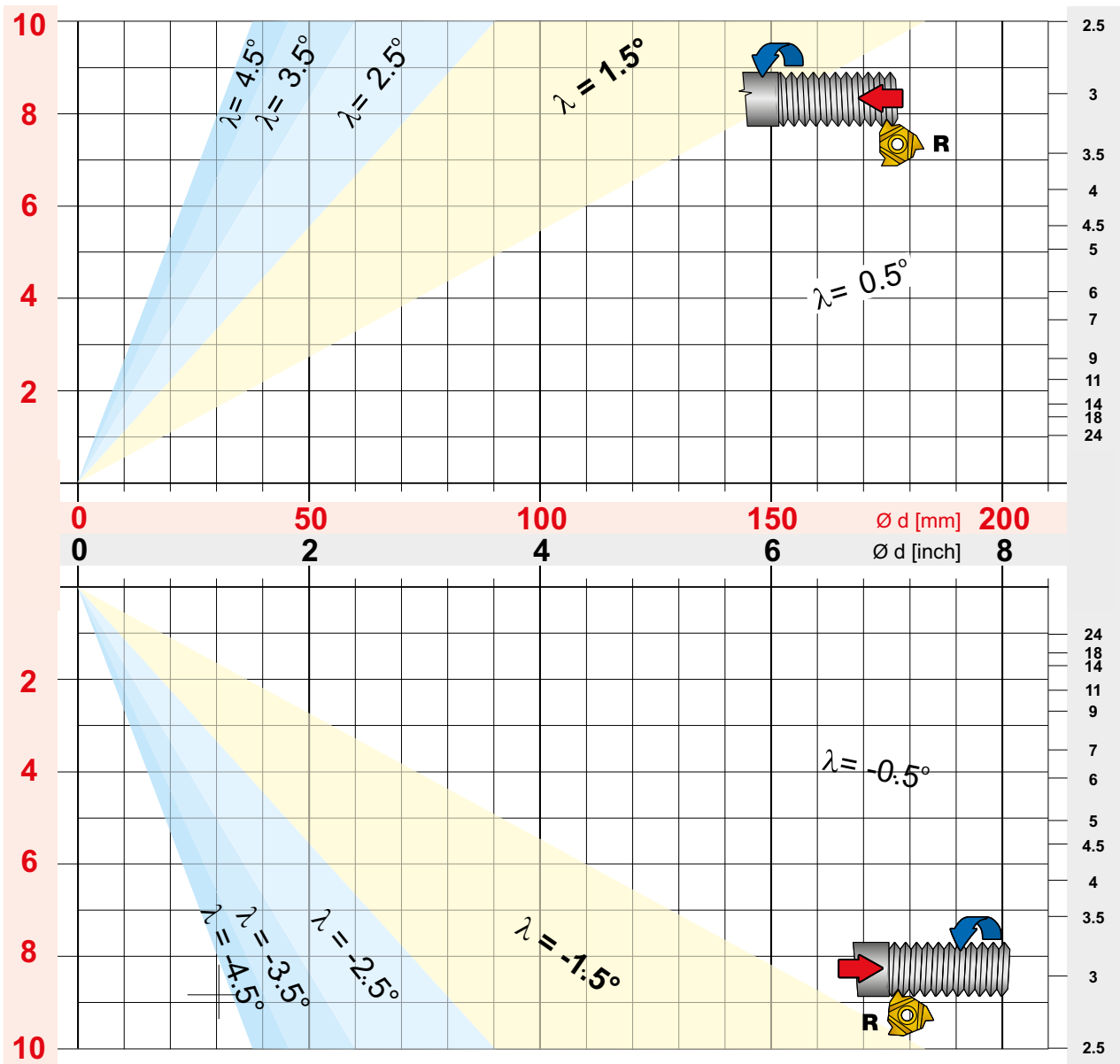
Picture 21. – Graph for shim selection

Imagen 21 – Selección de la base

Image N° 21 – Graphique pour sélection des assises

Thread pitch P [in]  
Paso de rosca P [in]  
Pas P [in]

No. of threads / 1"  
N.º de roscas / 1"  
Nb de filets / 1"



■ Movement of the workpiece  
Movimiento de la pieza  
Mouvement de la pièce

■ Tool movement  
Movimiento de la herramienta  
Mouvement de l'outil

**L / R** Insert design  
Tipo de inserto  
Sens de coupe plaquette



### Infeed method and depth

The choice of infeed method is most important for long chipping materials to ensure good chip control.

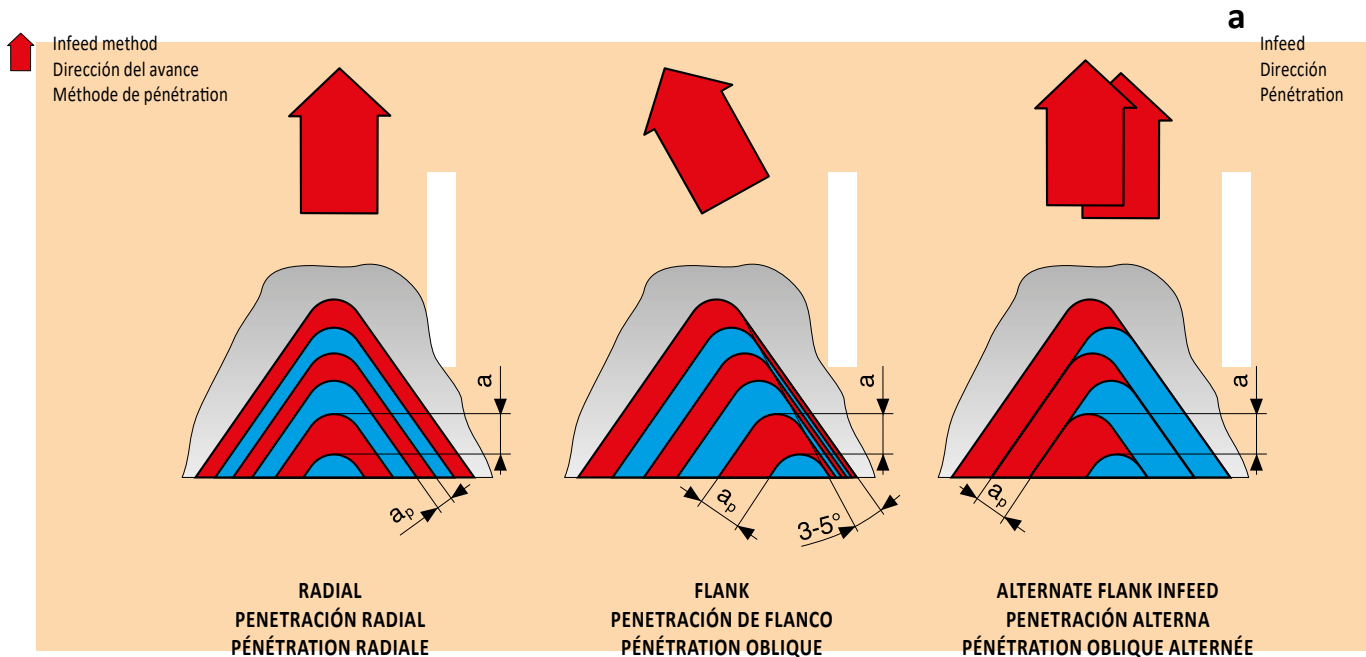
### Método de avance y profundidad

La selección del método de avance es muy importante con materiales de viruta larga para garantizar un buen control de las virutas.

### Méthode de pénétration et profondeur

Le choix de la méthode de pénétration est important pour assurer une bonne maîtrise des matériaux à copeaux longs.

Picture / Imagen / Image 22



The choice depends on the machine type, the machined material and the pitch.

**Radial infeed** – the most simple and the most used. The infeed is perpendicular to the axis of rotation of the workpiece. It contributes to good chip formation and uniform wear on the cutting edge. Suitable for threads with a small pitch ( $p < .059''$ ). There is a risk of vibration at higher feeds. First choice for working on hard materials (e.g. austenitic stainless steels, steels with low carbon content).

**Flank infeed** – reduces thermal stress on the cutting edge and thereby wear. Good chip control. Suitable for threads with a pitch of  $p > .059''$  for TR threads. Flank infeed with deviation 3-5° eliminates friction on the thread flank.

**Alternate flank infeed** – recommended for coarse threads and materials with poor chip formation. Long tool life. For CNC machines, higher demand on CNC programming.

**Infeed method and number of passes** depend on the thread pitch. The tables give basic recommendations and apply to all geometries. If the insert fractures, the infeed value should be decreased and the number of passes should be increased. The infeed depth should not be less than  $.059''/\text{pass}$ . On austenitic and soft steels the infeed depth per pass should be greater than  $.003''$ .

La selección depende del tipo de máquina, el material mecanizado y el paso.

**Avance radial:** sencillo, el más utilizado. El avance es perpendicular al eje de rotación de la pieza de trabajo. Buena formación de virutas, desgaste uniforme del filo de corte. Adecuado para roscas de paso pequeño ( $p < .059''$ ). Riesgo de vibraciones con avances mayores. Primera opción para materiales endurecidos (por ejemplo, aceros inoxidable austeníticos, aceros con bajo contenido de carbono).

**Avance de flanco:** reduce la fatiga térmica del filo de corte y por lo tanto, el desgaste. Excelente control de virutas. Adecuado para roscas con paso  $p > .059''$  para roscas TR. El avance de flanco con desviación de 3-5° elimina la fricción en el flanco de la rosca.

**Avance de flanco alternativo:** se recomienda para roscas de paso grande y materiales con mala formación de virutas. Larga vida útil de la herramienta. Para máquinas CNC, demanda alta de programación CNC

**El método de avance y el número de pasadas** dependen del paso de rosca. Las tablas ofrecen recomendaciones básicas y son aplicables a todas las geometrías. Si se produce una fractura de la plaquita, debe aumentarse el número de pasadas. la profundidad de avance no debe ser inferior a  $.059''/\text{pasada}$ . En los aceros austeníticos y blandos la profundidad de avance por pasada debe ser superior a  $.003''$ .

Le choix dépend du type de machine, du matériau à usiner et du pas.

**Pénétration radiale** – simple et la plus généralement utilisée. La pénétration est perpendiculaire à l'axe de rotation de la pièce. La formation du copeau est bonne, l'usure de l'arête de coupe est uniforme. Convient pour les filets TR avec un petit pas ( $p < .059''$ ). Risque de vibrations avec des vitesses élevées. Premier choix pour les matières difficiles à travailler (ex: aciers inoxydables austénitiques, aciers bas carbone).

**Pénétration oblique** – Réduit les contraintes thermiques sur l'arête de coupe et donc l'usure. Bon contrôle des copeaux. Convient pour les filets avec un pas  $p > .059''$  pour les filets TR. La pénétration oblique suivant un angle de 3,5° élimine le frottement sur le flanc de filet.

**Pénétration oblique alternée** – recommandée pour les gros filets et les matériaux avec une formation de copeaux difficile. Longue durée de vie. Pour les machines CNC, plus grande demande pour la programmation CNC.

**La méthode de pénétration et le nombre de passes** dépendent de la valeur du pas de filetage. Les tableaux donnent des recommandations de base et sont applicables à toutes les géométries. Dans le cas d'une casse de plaquette, le nombre de passes doit être augmenté. La profondeur de pénétration ne doit pas être inférieure à  $.059''$  par passe. Pour les aciers doux et les austénitiques la profondeur doit être supérieure à  $.003''$ .

Table / Tabla / Tableau 17

Tubular cylindrical thread profile corresponds with W (WHITWORTH 55°)  
 El perfil de rosca cilíndrico tubular corresponde a W (WHITWORTH 55°)  
 Profil de filet tubulaire cylindrique correspondant à W (WHITWORTH 55°)

Thread marking Marcado de rosca Marquage du filet	No. of threads / 1" N.º de roscas / 1" No. de filets / 1"	Thread pitch P Paso de rosca P Pas P [in]	Nominal diameter of thread Diámetro nominal de rosca Diamètre nominal de filet [in]	Small diameter of thread Diámetro pequeño de rosca Petit diamètre de filet [in]	Thread insert marking Marcado de plaquita de rosca Marquage du filet sur plaquette
G 1/16"	28	.0357	.304	.258	<b>TN xxxx280W</b>
G 1/8"			.383	.337	
G 1/4"	19	.0526	.518	.450	<b>TN xxxx190W</b>
G 3/8"			.656	.588	
G 1/2"	14	.0714	.825	.733	<b>TN xxxx140W</b>
G 5/8"			.902	.810	
G 3/4"			1.041	.949	
G 7/8"			1.189	1.097	
G 1"	11	.0909	1.309	1.192	<b>TN xxxx110W</b>
G1 1/8"			1.492	1.376	
G1 1/4"			1.650	1.534	
G1 1/2"			1.882	1.767	
G1 3/4"			2.216	1.999	
G 2"			2.347	2.231	
G2 1/4"			2.587	2.471	
G2 1/2"			2.960	2.844	
G2 3/4"			3.210	3.094	
G3"			3.460	3.344	
G3 1/2"			3.950	3.834	
G4"			4.450	4.334	
G4 1/2"			4.950	4.834	
G5"			5.450	5.334	
G5 1/2"			5.950	5.834	
G6"			6.450	6.334	

Example: for right-hand external thread on 1 1/2" tube use thread insert TN 16ER110W; 8030

Ejemplo: para una rosca externa derecha en un tubo de 1 1/2" utilice la plaquita de rosca TN 16ER110W; 8030

Exemple: Pour un filetage extérieur à droite sur un tube 1 1/2" utiliser la plaquette de filetage TN 16ER110W; 8030

**INFEEED DEPTH**  
**PROFUNDIDAD DE AVANCE**  
**PROFONDEUR DE PÉNÉTRATION**

Table 18a: M – metric 60° – external / Tabla 18a: M – métrica 60° – externa / Tableau 18a : M – métrique 60° – extérieur

Number of passes Número de pasadas Nombre de passes	REDUCE THE CUTTING SPEED PROPORTIONALLY TO INCREASING THE THREAD PITCH REDUZCA LA VELOCIDAD DE CORTE PROPORCIONALMENTE AL AUMENTO DEL PASO DE ROSCA RÉDUIRE LA VITESSE DE COUPE PROPORTIONNELLEMENT AVEC L'AUGMENTATION DU PAS														
	Pitch [mm] / Paso [mm] / Pas [mm]														
	6.0	5.5	5.0	4.5	4.0	3.5	3.0	2.5	2.0	1.75	1.5	1.25	1.0	0.75	0.50
1	.018	.017	.016	.015	.003	.013	.011	.011	.009	.008	.008	.008	.008	.006	.005
2	.017	.016	.015	.013	.013	.012	.010	.009	.009	.008	.008	.007	.006	.006	.004
3	.014	.013	.013	.011	.010	.010	.008	.008	.007	.007	.007	.006	.005	.004	.003
4	.012	.011	.011	.009	.009	.008	.007	.007	.006	.006	.006	.004	.004	.003	.002
5	.011	.010	.010	.009	.008	.008	.007	.006	.006	.005	.005	.004	.003		
6	.010	.009	.009	.008	.007	.007	.006	.006	.005	.004	.003	.003			
7	.009	.008	.009	.008	.007	.006	.006	.005	.004	.003					
8	.009	.008	.008	.007	.006	.006	.005	.004	.003	.003					
9	.009	.007	.007	.007	.006	.006	.005	.004							
10	.008	.007	.007	.006	.005	.005	.004	.003							
11	.007	.007	.006	.006	.005	.004	.004								
12	.006	.006	.006	.005	.004	.003	.003								
13	.006	.006	.005	.005	.004										
14	.006	.005	.004	.004	.003										
15	.005	.005													
16	.004	.004													
Total infeed depth Profundidad de avance total Profondeur totale de pénétration	.151	.139	.126	.113	.100	.088	.076	.063	.049	.044	.037	.032	.026	.019	.014

Table 18b: M – Metric 60° – internal / Tabla 18b: M – métrica 60° – interna / Tableau 18B : M – métrique 60° – intérieur

Number of passes Número de pasadas Nombre de passes	REDUCE THE CUTTING SPEED PROPORTIONALLY TO INCREASING THE THREAD PITCH REDUZCA LA VELOCIDAD DE CORTE PROPORCIONALMENTE AL AUMENTO DEL PASO DE ROSCA RÉDUIRE LA VITESSE DE COUPE PROPORTIONNELLEMENT AVEC L'AUGMENTATION DU PAS														
	Pitch [mm] / Paso [mm]/ Pas [mm]														
	6.0	5.5	5.0	4.5	4.0	3.5	3.0	2.5	2.0	1.75	1.5	1.25	1.0	0.75	0.50
1	.018	.017	.017	.015	.013	.013	.011	.010	.009	.009	.008	.007	.007	.006	.004
2	.017	.016	.016	.013	.012	.012	.010	.010	.008	.007	.007	.007	.006	.005	.003
3	.014	.013	.013	.011	.009	.009	.008	.007	.007	.006	.006	.006	.004	.004	.003
4	.012	.010	.010	.009	.008	.007	.006	.006	.006	.005	.005	.004	.004	.003	.002
5	.010	.009	.009	.008	.007	.007	.006	.005	.005	.004	.004	.003	.003		
6	.009	.008	.008	.007	.007	.006	.005	.005	.004	.004	.003	.003			
7	.008	.007	.007	.006	.006	.006	.005	.004	.003	.003					
8	.007	.006	.006	.006	.005	.005	.004	.004	.003	.003					
9	.007	.006	.006	.006	.005	.005	.004	.004							
10	.006	.006	.006	.005	.005	.004	.004	.003							
11	.006	.006	.005	.005	.004	.004	.004								
12	.006	.006	.005	.005	.004	.003	.003								
13	.005	.005	.005	.004	.004										
14	.005	.005	.004	.004	.003										
15	.005	.004													
16	.004	.004													
Total infeed depth Profundidad de avance total Profondeur totale de pénétration	.139	.128	.117	.104	.092	.081	.070	.058	.045	.041	.033	.030	.024	.018	.012

Table 19: W – Whitworth 55° – external and internal / Tabla 19: W – Whitworth 55° – externa e interna / Tableau 19 : W – Whitworth 55° – intérieur et extérieur

Number of passes Número de pasadas Nombre de passes	REDUCE THE CUTTING SPEED PROPORTIONALLY TO INCREASING THE THREAD PITCH REDUZCA LA VELOCIDAD DE CORTE PROPORCIONALMENTE AL AUMENTO DEL PASO DE ROSCA RÉDUIRE LA VITESSE DE COUPE PROPORTIONNELLEMENT AVEC L'AUGMENTATION DU PAS																
	Pitch [no of thread/in] / Paso [fpp] / Pas [Nombre de filets/pouce]																
	4	4.5	5	6	7	8	9	10	11	12	14	16	18	19	20	26	28
1	0.019	0.018	0.018	0.015	0.015	0.013	0.012	0.011	0.011	0.011	0.009	0.009	0.009	0.009	0.008	0.007	0.007
2	0.018	0.017	0.017	0.014	0.014	0.012	0.011	0.011	0.010	0.010	0.009	0.009	0.009	0.009	0.008	0.007	0.007
3	0.015	0.015	0.015	0.012	0.011	0.009	0.009	0.009	0.009	0.009	0.007	0.007	0.007	0.007	0.007	0.006	0.006
4	0.014	0.013	0.013	0.010	0.010	0.008	0.008	0.007	0.007	0.007	0.006	0.006	0.006	0.006	0.006	0.005	0.005
5	0.013	0.011	0.011	0.009	0.009	0.007	0.007	0.007	0.006	0.006	0.005	0.005	0.005	0.005	0.004	0.003	0.003
6	0.012	0.010	0.010	0.008	0.007	0.007	0.006	0.006	0.006	0.006	0.004	0.004	0.003	0.003			
7	0.011	0.009	0.009	0.007	0.007	0.006	0.006	0.006	0.005	0.005	0.004	0.003					
8	0.011	0.009	0.008	0.007	0.006	0.006	0.005	0.005	0.005	0.003	0.003						
9	0.009	0.008	0.007	0.006	0.006	0.005	0.005	0.005	0.003								
10	0.009	0.007	0.007	0.006	0.006	0.005	0.005	0.003									
11	0.008	0.007	0.007	0.006	0.005	0.005	0.003										
12	0.007	0.006	0.006	0.006	0.003	0.003											
13	0.007	0.006	0.005	0.005													
14	0.006	0.006	0.004	0.004													
15	0.005	0.005															
16	0.004	0.004															
Total infeed depth Profundidad de avance total Profondeur totale de pénétration	0.169	0.150	0.135	0.114	0.098	0.085	0.076	0.069	0.062	0.057	0.047	0.044	0.040	0.038	0.036	0.028	0.027

Table 20a: UN – UN 60° – external / Tabla 20a: UN 60° – externa / Tableau 20a : UN – UN 60° – extérieur

Number of passes Número de pasadas Nombre de passes	REDUCE THE CUTTING SPEED PROPORTIONALLY TO INCREASING THE THREAD PITCH REDUZCA LA VELOCIDAD DE CORTE PROPORCIONALMENTE AL AUMENTO DEL PASO DE ROSCA RÉDUIRE LA VITESSE DE COUPE PROPORTIONNELLEMENT AVEC L'AUGMENTATION DU PAS																	
	Pitch [no of thread/in] / Paso [fpp] / Pas [Nombre de filets/pouce]																	
	4	4.5	5	6	7	8	9	10	11	12	13	14	16	18	20	24	28	32
1	0.019	0.018	0.017	0.014	0.014	0.012	0.011	0.011	0.011	0.011	0.010	0.009	0.009	0.009	0.008	0.007	0.007	0.007
2	0.017	0.016	0.016	0.013	0.013	0.011	0.010	0.010	0.010	0.010	0.009	0.009	0.008	0.008	0.007	0.007	0.006	0.006
3	0.016	0.015	0.014	0.011	0.010	0.010	0.008	0.008	0.008	0.008	0.007	0.007	0.006	0.006	0.006	0.006	0.004	0.005
4	0.014	0.012	0.012	0.009	0.009	0.008	0.008	0.007	0.007	0.007	0.007	0.006	0.006	0.006	0.005	0.005	0.004	0.003
5	0.013	0.010	0.010	0.009	0.008	0.007	0.007	0.006	0.006	0.006	0.006	0.005	0.005	0.005	0.004	0.003	0.003	
6	0.011	0.009	0.009	0.008	0.007	0.006	0.006	0.006	0.006	0.005	0.005	0.004	0.004	0.003	0.003			
7	0.010	0.008	0.008	0.007	0.007	0.006	0.006	0.006	0.005	0.005	0.004	0.004	0.003					
8	0.009	0.008	0.007	0.006	0.006	0.005	0.005	0.005	0.004	0.003	0.003	0.003						
9	0.009	0.007	0.007	0.006	0.006	0.005	0.005	0.004	0.003									
10	0.008	0.007	0.007	0.006	0.005	0.005	0.004	0.003										
11	0.007	0.006	0.007	0.005	0.004	0.004	0.003											
12	0.007	0.006	0.006	0.005	0.003	0.003												
13	0.006	0.006	0.005	0.004														
14	0.006	0.006	0.004	0.004														
15	0.005	0.005																
16	0.004	0.004																
Total infeed depth Profundidad de avance total Profondeur totale de pénétration	0.160	0.143	0.130	0.107	0.092	0.082	0.072	0.065	0.060	0.055	0.051	0.047	0.041	0.037	0.033	0.028	0.024	0.021

**INFEED DEPTH  
PROFUNDIDAD DE AVANCE  
PROFONDEUR DE PÉNÉTRATION**

Table 20b: UN - UN 60° – internal / Tabla 20a: UN 60° – interna / Tableau 20b : UN 60° – intérieur

Number of passes Número de pasadas Nombre de passes	REDUCE THE CUTTING SPEED PROPORTIONALLY TO INCREASING THE THREAD PITCH REDUZCA LA VELOCIDAD DE CORTE PROPORCIONALMENTE AL AUMENTO DEL PASO DE ROSCA RÉDUIRE LA VITESSE DE COUPE PROPORTIONNELLEMENT AVEC L'AUGMENTATION DU PAS																	
	Pitch [no of thread/in] / Paso [fpp] / Pas [Nombre de filets/pouce]																	
	4	4.5	5	6	7	8	9	10	11	12	13	14	16	18	20	24	28	32
1	0.017	0.016	0.017	0.014	0.013	0.012	0.011	0.011	0.011	0.011	0.010	0.009	0.009	0.009	0.008	0.007	0.007	0.007
2	0.016	0.015	0.015	0.013	0.013	0.011	0.010	0.010	0.009	0.009	0.008	0.007	0.007	0.007	0.006	0.006	0.006	0.006
3	0.015	0.013	0.013	0.010	0.009	0.009	0.007	0.007	0.007	0.007	0.006	0.006	0.006	0.006	0.005	0.005	0.004	0.004
4	0.013	0.011	0.011	0.008	0.008	0.007	0.006	0.006	0.006	0.006	0.005	0.005	0.005	0.005	0.004	0.004	0.003	0.003
5	0.011	0.009	0.009	0.007	0.007	0.006	0.006	0.005	0.005	0.005	0.004	0.004	0.004	0.004	0.003	0.003		
6	0.009	0.008	0.008	0.006	0.006	0.005	0.005	0.005	0.004	0.004	0.004	0.004	0.004	0.003	0.003			
7	0.009	0.007	0.007	0.006	0.006	0.005	0.005	0.004	0.004	0.004	0.004	0.004	0.003					
8	0.008	0.007	0.007	0.006	0.005	0.004	0.004	0.004	0.004	0.003	0.003	0.003						
9	0.008	0.007	0.006	0.005	0.005	0.004	0.004	0.004	0.003									
10	0.007	0.006	0.006	0.005	0.005	0.004	0.004	0.003										
11	0.007	0.006	0.006	0.005	0.004	0.004	0.003											
12	0.006	0.006	0.006	0.004	0.003	0.003												
13	0.006	0.006	0.005	0.004														
14	0.006	0.005	0.004	0.004														
15	0.005	0.005																
16	0.004	0.004																
Total infeed depth Profundidad de avance total Profondeur totale de pénétration	0.147	0.131	0.118	0.097	0.084	0.074	0.065	0.059	0.054	0.049	0.045	0.042	0.037	0.033	0.030	0.025	0.022	0.019

Table 21: NPT 60° – internal and external / Tabla 21: NPT 60° – interna ed externa / Tabela 21. NPT 60° – interna e externa / Tableau 21 : NPT 60° – intérieur et extérieur

Number of passes Número de pasadas Nombre de passes	REDUCE THE CUTTING SPEED PROPORTIONALLY TO INCREASING THE THREAD PITCH REDUZCA LA VELOCIDAD DE CORTE PROPORCIONALMENTE AL AUMENTO DEL PASO DE ROSCA RÉDUIRE LA VITESSE DE COUPE PROPORTIONNELLEMENT AVEC L'AUGMENTATION DU PAS				
	Pitch [no of thread/in] / Paso [fpp] / Pas [Nombre de filets/pouce]				
	8	11.5	14	18	27
1	0.011	0.010	0.009	0.009	0.007
2	0.010	0.009	0.009	0.007	0.006
3	0.009	0.007	0.007	0.006	0.005
4	0.007	0.006	0.006	0.006	0.004
5	0.007	0.006	0.006	0.005	0.004
6	0.007	0.006	0.005	0.005	0.003
7	0.007	0.006	0.005	0.004	
8	0.007	0.005	0.004	0.003	
9	0.006	0.005	0.004		
10	0.006	0.004	0.003		
11	0.006	0.004			
12	0.005	0.003			
13	0.005				
14	0.004				
15	0.003				
Total infeed depth Profundidad de avance total Profondeur totale de pénétration	0.100	0.069	0.057	0.044	0.030

Table 22a: RD – RD 30° – external / Tabla 22a: RD – RD 30° – externa / Tableau 22a : RD – RD 30° – extérieur

Number of passes Número de pasadas Nombre de passes	REDUCE THE CUTTING SPEED PROPORTIONALLY TO INCREASING THE THREAD PITCH REDUZCA LA VELOCIDAD DE CORTE PROPORCIONALMENTE AL AUMENTO DEL PASO DE ROSCA RÉDUIRE LA VITESSE DE COUPE PROPORTIONNELLEMENT AVEC L'AUGMENTATION DU PAS			
	Pitch [no of thread/in] / Paso [fpp] / Pas [Nombre de filets/pouce]			
	4	6	8	10
1	0.017	0.013	0.011	0.010
2	0.016	0.011	0.010	0.010
3	0.013	0.010	0.008	0.009
4	0.013	0.009	0.007	0.008
5	0.011	0.008	0.007	0.006
6	0.010	0.007	0.006	0.005
7	0.009	0.006	0.006	0.004
8	0.009	0.006	0.005	0.003
9	0.008	0.006	0.004	
10	0.007	0.005	0.003	
11	0.007	0.004		
12	0.006	0.003		
13	0.005			
14	0.004			
Total infeed depth Profundidad de avance total Profondeur totale de pénétration	0.135	0.088	0.068	0.055

Table 22b : RD – RD 30° – internal / Tabla 22b: RD – RD 30° – interna / Tableau 22b : RD – RD 30° – intérieur

Number of passes Número de pasadas Nombre de passes	REDUCE THE CUTTING SPEED PROPORTIONALLY TO INCREASING THE THREAD PITCH REDUZCA LA VELOCIDAD DE CORTE PROPORCIONALMENTE AL AUMENTO DEL PASO DE ROSCA RÉDUIRE LA VITESSE DE COUPE PROPORTIONNELLEMENT AVEC L'AUGMENTATION DU PAS			
	Pitch [no of thread/in] / Paso [fpp] / Passo (nº de fios / polegada) / Pas [Nombre de filets/pouce]			
	4	6	8	10
1	0.018	0.015	0.010	0.011
2	0.017	0.013	0.009	0.010
3	0.016	0.012	0.008	0.010
4	0.014	0.010	0.007	0.009
5	0.012	0.008	0.007	0.007
6	0.010	0.007	0.006	0.005
7	0.009	0.007	0.006	0.004
8	0.009	0.006	0.005	0.003
9	0.008	0.006	0.004	
10	0.007	0.005	0.003	
11	0.007	0.004		
12	0.006	0.003		
13	0.005			
14	0.004			
Total infeed depth Profundidad de avance total Profondeur totale de pénétration	0.141	0.096	0.065	0.059

**INFEED DEPTH  
PROFUNDIDAD DE AVANCE  
PROFONDEUR DE PÉNÉTRATION**

Table 23a: TR 30° external / Tabla 23a: TR – TR 30° – externa / Tableau 23a : TR – Trapèze 30° – extérieur

Number of passes Número de pasadas Nombre de passes	REDUCE THE CUTTING SPEED PROPORTIONALLY TO INCREASING THE THREAD PITCH REDUZCA LA VELOCIDAD DE CORTE PROPORCIONALMENTE AL AUMENTO DEL PASO DE ROSCA RÉDUIRE LA VITESSE DE COUPE PROPORTIONNELLEMENT AVEC L'AUGMENTATION DU PAS											
	Pitch [mm] / Paso [mm] / Pas [mm]											
	14.0	12.0	1.0	9.0	8.0	7.0	6.0	5.0	4.0	3.0	2.0	1.5
1	.40	.38	.38	.38	.37	.37	.37	.34	.31	.27	.25	.23
2	.37	.36	.36	.35	.35	.34	.35	.33	.28	.25	.24	.22
3	.36	.34	.34	.34	.34	.33	.32	.27	.24	.21	.20	.18
4	.36	.34	.34	.33	.33	.31	.29	.25	.20	.17	.17	.14
5	.35	.32	.32	.31	.31	.29	.27	.23	.19	.15	.14	.12
6	.35	.32	.32	.30	.29	.26	.25	.21	.18	.13	.13	.08
7	.34	.30	.31	.29	.28	.26	.23	.20	.16	.13	.11	
8	.34	.30	.29	.28	.27	.26	.22	.20	.15	.12	.09	
9	.34	.30	.28	.26	.25	.24	.22	.18	.15	.12		
10	.33	.29	.27	.25	.24	.23	.20	.16	.15	.10		
11	.33	.29	.25	.24	.23	.22	.18	.15	.14	.10		
12	.32	.29	.24	.23	.21	.22	.17	.14	.13	.08		
13	.32	.28	.23	.22	.20	.20	.17	.13	.10			
14	.31	.27	.22	.21	.19	.19	.16	.10				
15	.31	.25	.22	.21	.19	.17	.14					
16	.30	.25	.20	.19	.18	.16	.12					
17	.30	.24	.19	.18	.17	.12						
18	.29	.22	.18	.16	.15							
19	.28	.20	.17	.15	.13							
20	.27	.20	.16	.15								
21	.23	.19	.15	.13								
22	.23	.18	.15									
23	.21	.17	.13									
24	.19	.16										
25	.17	.15										
26	.16	.13										
27	.16											
28	.15											
29	.13											
Total infeed depth Profundidad de avance total Profondeur totale de pénétration	8.2	6.72	5.7	5.16	4.68	4.17	3.66	2.89	2.38	1.83	1.33	.97

Table 23b: TR - TR 30° – internal / Tabla 23b: TR - TR 30° – interna / Tableau 23b : TR – Trapèze 30° – intérieur

Number of passes Número de pasadas Nombre de passes	REDUCE THE CUTTING SPEED PROPORTIONALLY TO INCREASING THE THREAD PITCH REDUZCA LA VELOCIDAD DE CORTE PROPORCIONALMENTE AL AUMENTO DEL PASO DE ROSCA RÉDUIRE LA VITESSE DE COUPE PROPORTIONNELLEMENT AVEC L'AUGMENTATION DU PAS											
	Pitch [mm] / Paso [mm] / Pas [mm]											
	14.0	12.0	1.0	9.0	8.0	7.0	6.0	5.0	4.0	3.0	2.0	1.5
1	.40	.38	.38	.38	.37	.37	.37	.34	.31	.27	.25	.23
2	.37	.36	.36	.35	.35	.34	.34	.33	.28	.25	.24	.22
3	.36	.34	.34	.34	.34	.33	.32	.27	.24	.22	.21	.19
4	.36	.34	.34	.33	.33	.31	.29	.25	.20	.17	.17	.14
5	.35	.32	.32	.31	.31	.29	.27	.23	.19	.15	.14	.12
6	.35	.32	.32	.31	.29	.26	.25	.21	.18	.14	.13	.08
7	.34	.30	.31	.29	.28	.26	.23	.20	.16	.13	.11	
8	.34	.30	.29	.29	.27	.26	.22	.20	.15	.12	.09	
9	.34	.30	.28	.26	.25	.24	.22	.18	.15	.12		
10	.33	.29	.27	.25	.24	.23	.20	.16	.15	.10		
11	.33	.29	.25	.24	.23	.22	.18	.15	.14	.10		
12	.32	.28	.24	.23	.21	.22	.17	.14	.13	.08		
13	.32	.28	.23	.22	.20	.20	.17	.13	.10			
14	.31	.27	.22	.21	.19	.19	.16	.10				
15	.31	.25	.22	.21	.19	.17	.14					
16	.30	.25	.20	.20	.18	.16	.12					
17	.30	.24	.19	.18	.17	.12						
18	.29	.22	.18	.16	.15							
19	.28	.20	.17	.15	.13							
20	.27	.20	.16	.15								
21	.27	.19	.15	.13								
22	.23	.18	.15									
23	.23	.17	.13									
24	.21	.16										
25	.19	.15										
26	.17	.13										
27	.16											
28	.16											
29	.15											
30	.13											
Total infeed depth Profundidad de avance total Profondeur totale de pénétration	8.47	6.71	5.7	5.19	4.68	4.17	3.65	2.89	2.38	1.85	1.34	.98

Table 24: BSPT 55° – internal and external / Tabla 24: BSPT 55° – interna ed externa / Tableau 24: BSPT 55° – intérieur et extérieur

Number of passes Número de pasadas Nombre de passes	REDUCE THE CUTTING SPEED PROPORTIONALLY TO INCREASING THE THREAD PITCH REDUZCA LA VELOCIDAD DE CORTE PROPORCIONALMENTE AL AUMENTO DEL PASO DE ROSCA RÉDUIRE LA VITESSE DE COUPE PROPORTIONNELLEMENT AVEC L'AUGMENTATION DU PAS			
	Pitch [mm] / Paso [mm] / Passo [mm] / Pas [mm]			
	11	14	19	28
1	0.22	0.19	0.19	0.15
2	0.21	0.18	0.18	0.14
3	0.20	0.17	0.17	0.13
4	0.19	0.16	0.15	0.12
5	0.18	0.15	0.13	0.08
6	0.16	0.14	0.08	
7	0.15	0.12		
8	0.13	0.08		
9	0.08			
Total infeed depth Profundidad de avance total Profondeur totale de pénétration	1.52	1.19	0.90	0.62



**INFEEED DEPTH**  
**PROFUNDIDAD DE AVANCE**  
**PROFONDEUR DE PÉNÉTRATION**

Table 25a: ACME – ACME 29° – external / Tabla 25a: ACME – ACME 29° – externa / Tableau 25a : ACME – ACME 29° – extérieur

Number of passes Número de pasadas Nombre de passes	REDUCE THE CUTTING SPEED PROPORTIONALLY TO INCREASING THE THREAD PITCH REDUZCA LA VELOCIDAD DE CORTE PROPORCIONALMENTE AL AUMENTO DEL PASO DE ROSCA RÉDUIRE LA VITESSE DE COUPE PROPORTIONNELLEMENT AVEC L'AUGMENTATION DU PAS							
	Pitch [no of thread/in] / Paso [fpp] / Pas [Nombre de filets/pouce]							
	4	5	6	8	10	12	14	16
1	0.015	0.013	0.001	0.000	0.011	0.010	0.009	0.009
2	0.013	0.001	0.011	0.010	0.009	0.009	0.008	0.008
3	0.012	0.010	0.009	0.008	0.008	0.007	0.007	0.007
4	0.011	0.009	0.008	0.007	0.007	0.006	0.006	0.006
5	0.010	0.009	0.007	0.006	0.006	0.005	0.005	0.005
6	0.009	0.008	0.007	0.005	0.005	0.005	0.004	0.003
7	0.008	0.007	0.006	0.005	0.005	0.004	0.003	
8	0.008	0.007	0.006	0.005	0.004	0.004		
9	0.008	0.007	0.006	0.005	0.004			
10	0.007	0.006	0.006	0.004	0.004			
11	0.007	0.006	0.006	0.004				
12	0.006	0.006	0.005	0.004				
13	0.006	0.005	0.004					
14	0.006	0.004						
15	0.006							
16	0.005							
Total infeed depth Profundidad de avance total Profondeur totale de pénétration	0.136	0.111	0.095	0.074	0.062	0.048	0.042	0.038

Table 25b: ACME – ACME 29° – internal / Tabla 25b: ACME – ACME 29° – interna / Tabela 25b: ACME – ACME 29° – interna / Tableau 25b : ACME – ACME 29° – intérieur

Number of passes Número de pasadas Nombre de passes	REDUCE THE CUTTING SPEED PROPORTIONALLY TO INCREASING THE THREAD PITCH REDUZCA LA VELOCIDAD DE CORTE PROPORCIONALMENTE AL AUMENTO DEL PASO DE ROSCA RÉDUIRE LA VITESSE DE COUPE PROPORTIONNELLEMENT AVEC L'AUGMENTATION DU PAS							
	Pitch [no of thread/in] / Paso [fpp] / Pas [Nombre de filets/pouce]							
	4	5	6	8	10	12	14	16
1	0.015	0.013	0.001	0.000	0.011	0.010	0.009	0.009
2	0.013	0.012	0.011	0.010	0.009	0.009	0.008	0.008
3	0.012	0.010	0.009	0.008	0.008	0.007	0.007	0.007
4	0.011	0.009	0.008	0.007	0.007	0.006	0.006	0.006
5	0.010	0.009	0.007	0.006	0.006	0.005	0.005	0.005
6	0.009	0.008	0.007	0.006	0.005	0.005	0.004	0.003
7	0.008	0.007	0.006	0.005	0.005	0.004	0.003	
8	0.008	0.007	0.006	0.005	0.004	0.004		
9	0.008	0.007	0.006	0.005	0.004			
10	0.007	0.006	0.006	0.005	0.004			
11	0.007	0.006	0.006	0.004				
12	0.006	0.006	0.005	0.004				
13	0.006	0.005	0.004					
14	0.006	0.004						
15	0.006							
16	0.005							
Total infeed depth Profundidad de avance total Profondeur totale de pénétration	0.135	0.109	0.094	0.075	0.063	0.048	0.042	0.037

**Recesses, parting and copy turning.**

Pramet offers a comprehensive range of tools for turning shallow and deep recesses, both radially and axially (face grooving). Circular/copy profile turning can also be performed through side cutting.

The Pramet range of tools for recessing, grooving, profiling and parting are shown in picture 23 below.

**Tournage d'évidements, tronçonnage et copiage.**

Nous vous offrons un programme complet d'outils de tournage pour le tournage productif d'évidements profonds et peu profonds, radiaux et axiaux (gorges frontales). De plus, nous proposons des plaquettes pour le copiage de profils réalisables avec l'arête de coupe latérale.

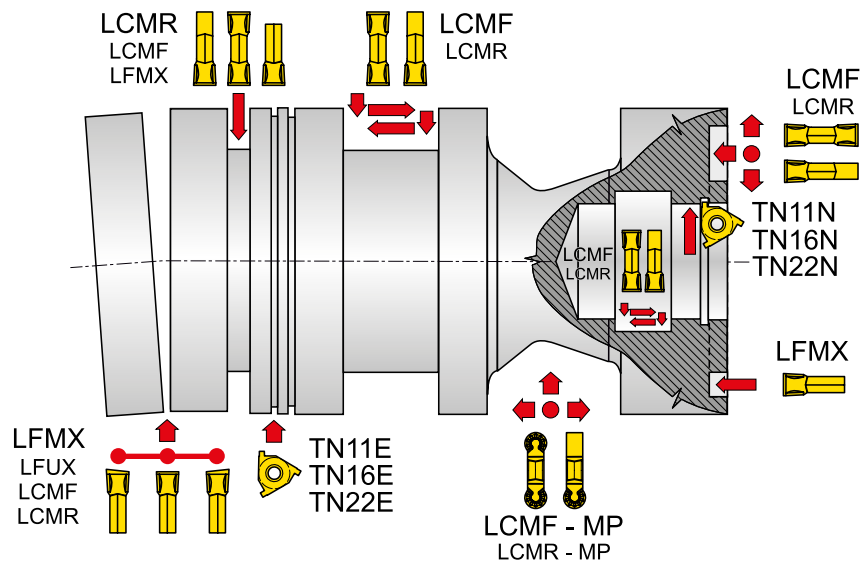
Notre gamme d'outils pour les évidements, le rainurage, le profilage et le tronçonnage est représentée schématiquement dans le tableau ci-dessous. Image 23.

**Torneado de ranuras, tronzado y torneado en copia**

Pramet Tools ofrece una gama completa de herramientas de torneado para el torneado productivo de rebajes superficiales y profundos, tanto radiales como axiales (ranurado frontal). Además, se puede realizar un torneado circular / de copias mediante el corte lateral.

La gama de herramientas de Pramet Tools para rebaje, ranurado, perfilado y corte se muestra de forma esquemática en el gráfico siguiente. Imagen 23.

Picture / Imagen /Image 23



**Recommendation for practical usage:**

The procedure for turning a recess (deepening and widening) is shown in the following illustration – picture 24.

**Recomendación para uso práctico:**

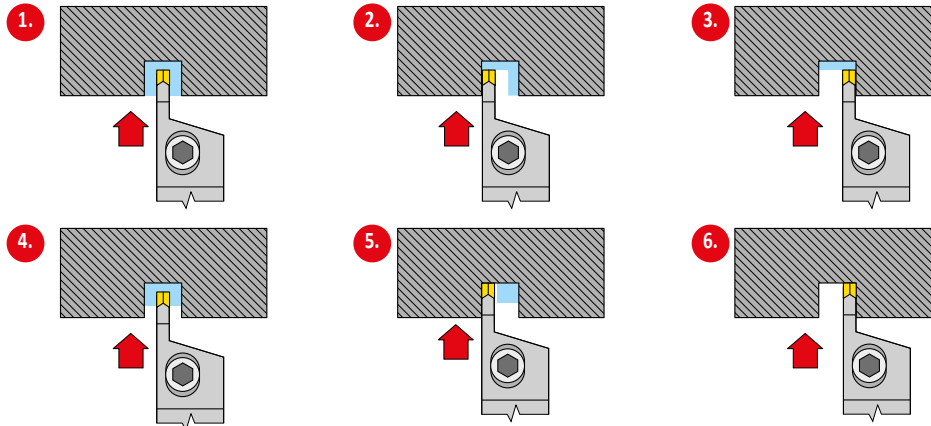
El procedimiento de torneado (profundización y ensanchamiento) de rebaje se describe de forma esquemática en la Imagen 24 siguiente.

**Recommandation pour utilisation pratique :**

La procédure de tournage (pour approfondir et élargir) un évidement est schématisée sur l'image suivante N° 24.

**RECESSES, PARTING AND COPY TURNING**  
**TORNEADO DE REBAJES, TRONZADO Y TORNEADO EN COPIADO**  
**TOURNAGE D'ÉVIDEMENTS, TRONÇONNAGE ET COPIAGE**

Picture / Imagen / Image 24



Note: To create a flat seating surface, use insert **type LCMF** with chip breaker **F**. The outboard radial grooving passes should overlap the central pass by two times the insert corner radius.

Nota: Para generar una superficie de asiento plana, utilice el tipo de **plaqueta LCMF** con rompevirutas **F**. Las pasadas de ranurado radial de la parte exterior deben superponerse con la pasada central en 2 veces el radio de esquina de la plaqueta.

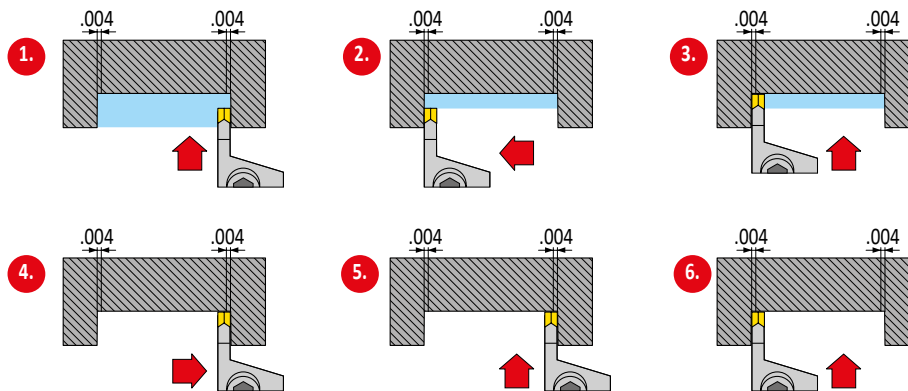
Remarque : Pour générer une face d'appui plane, utiliser une plaquette de **type LCMF** avec géométrie **F**. Les passes de rainurage des flancs doivent chevaucher la passe centrale d'au moins 2 fois le rayon de pointe de la plaquette.

When machining a wide recess, follow the procedure shown in the following illustration – picture 25.

Cuando mecanice un rebaje ancho siga el procedimiento que se describe de forma esquemática en la imagen 25 siguiente.

Pour usiner un large évidement, suivre la procédure d'usinage représentée sur l'image suivante N° 25.

Picture / Imagen / Image 25



Note: Use the cutting insert LCMF with chip breaker **M**. You must consider the tool's deformation "y":

Nota: Utilice las plaquetas de corte LCMF con rompevirutas **M**. Debe tener en cuenta la deformación de la herramienta "y"

	– for $f = .006$ in/rev;	$a_p = .118$ in	$y = .003$ in
	– for $f = .010$ in/rev;	$a_p = .118$ in	$y = .003$ in
	– for $f = .014$ in/rev;	$a_p = .118$ in	$y = .004$ in

	– para $f = .006$ in/rev;	$a_p = .118$ in	$y = .003$ in
	– para $f = .010$ in/rev;	$a_p = .118$ in	$y = .003$ in
	– para $f = .014$ in/rev;	$a_p = .118$ in	$y = .004$ in

Note: Utiliser la plaquette LCMF avec une géométrie **M**. Vous devez tenir compte de la déformation de l'outil "y"

	– pour $f = .006$ in/tr;	$a_p = .118$ in	$y = .003$ in
	– pour $f = .010$ in/tr;	$a_p = .118$ in	$y = .003$ in
	– pour $f = .014$ in/tr;	$a_p = .118$ in	$y = .004$ in

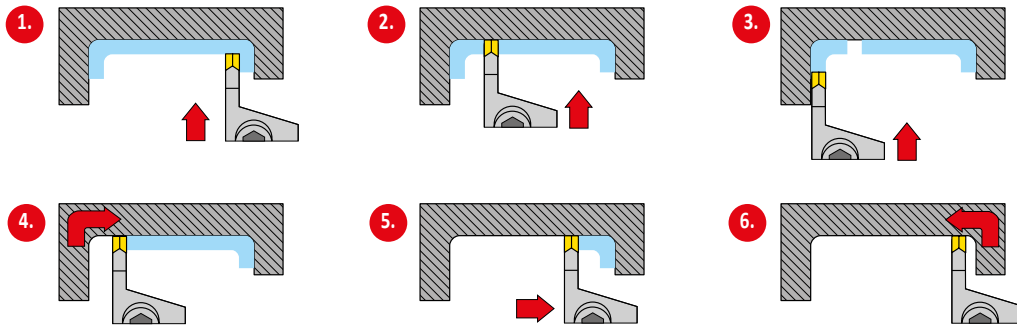
**RECESSES, PARTING AND COPY TURNING**  
**TORNEADO DE REBAJES , TRONZADO Y TORNEADO EN COPIADO**  
**TOURNAGE D'ÉVIDEMENTS, TRONÇONNAGE ET COPIAGE**

When opening up or deepening a contour using side turning, use the procedure shown in picture 26.

Cuando abra o profundice un contorno utilizando el torneado lateral utilice el procedimiento indicado en la Imagen 26.

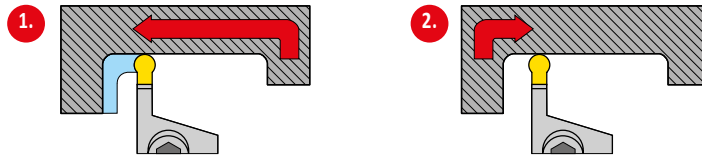
Pour ouvrir ou approfondir un contour en utilisant la coupe latérale utiliser la procédure indiquée sur l'Image 26.

Picture / Imagen / Image 26



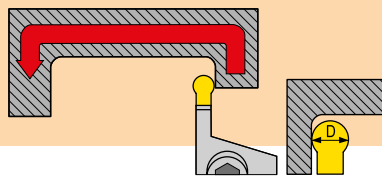
**Roughing of contour (insert with round cutting edge) / Desbaste de contorno (plaquita con filo de corte redondo)**  
**Ebauche du contour (plaquette avec arête de coupe ronde)**

Picture / Imagen / Image 27



**Finishing of contour (insert with round cutting edge) / Acabado de contorno (plaquita con filo de corte redondo)**  
**Finition du contour (plaquette avec arête de coupe ronde)**

Picture / Imagen / Image 28



D [in]	a <sub>p</sub> [in]
.118	.006
.157	.008
.197	.009
.236	.010
.315	.016

**TURNING OF SLENDER SHAFTS AND INTERNAL TURNING (BORING) OF DEEP HOLES  
TORNEADO DE EJES DELGADOS Y TORNEADO INTERIOR (MANDRINADO) DE AGUJEROS PROFUNDOS  
TOURNAGE D'ÉVIDEMENTS, TRONÇONNAGE ET GORGES**

When copy turning using indexable inserts with a round cutting edge, the maximum depth of cut is 50% of the diameter of the insert.

Choose the tool holder with the maximum cross-section and minimum tool overhang to eliminate vibrations.

The longitudinal axis of the cutting insert must be perpendicular to the axis of rotation of the workpiece (at radial recesses).

The cutting edge must be on centerline within a tolerance of  $\pm .004''$

Coolant must be applied directly onto the cutting edge, and onto the support area of the tool holder under the insert cutting edge, in sufficient quantities to guarantee effective cooling of the insert.

When face grooving it is necessary to select a tool holder with the correct range of diameters for the groove to be machined. The tool must be set parallel to the axis of rotation of the workpiece (perpendicular to the face of the groove). Otherwise there is a risk of rubbing against the wall(s) of the groove during machining.

In the event of the tool rubbing against the outer wall of the groove, it may be necessary to raise the cutting edge above centre (see example A in picture 29).

„Cuando realice torneado de copias con plaquitas intercambiables de filo de corte redondo, la profundidad máxima de corte es del 50% del diámetro de la plaquita redonda.“

Elija el portaherramientas con sección transversal máxima y voladizo de herramienta mínimo para eliminar las vibraciones.

El eje longitudinal de la plaquita de corte debe ser perpendicular al eje de rotación de la pieza de trabajo (en rebajes radiales).

El filo de corte debe estar sobre la línea central con una tolerancia de  $\pm .004''$

Se debe aplicar refrigerante sobre el filo de corte en un volumen suficiente, y también en la zona de soporte del portaherramientas debajo del filo de corte de la plaquita.

En el ranurado frontal es necesario seleccionar un portaherramientas con el rango de diámetros correcto para la ranura que se va a mecanizar. La herramienta debe posicionarse en paralelo al eje de rotación de la pieza de trabajo (perpendicular a la parte frontal de la ranura). De lo contrario, existe riesgo de rozamiento contra las paredes de la ranura durante el mecanizado.

En caso de rozamiento de la herramienta contra la pared exterior de la ranura, puede ser necesario elevar el filo de corte por encima del centro (consulte el ejemplo A en la imagen 29).

Pour le copiage avec des plaquettes avec arête de coupe ronde, la profondeur de coupe maximum est de 50% de la valeur du diamètre de l'arête de coupe ronde.

Choisir le porte-outil avec une section maximum et un porte-à-faux minimum pour éliminer les vibrations.

L'axe longitudinal de la plaquette doit être perpendiculaire à l'axe de rotation de la pièce (évidements radiaux).

L'arête de coupe doit être sur l'axe central avec une tolérance de  $\pm .004''$

L'arrosage doit être dirigé sur la zone de coupe et de façon abondante, et aussi sur la zone du porte-outil située sous l'arête de coupe.

Pour l'usinage d'une gorge frontale, il est nécessaire de sélectionner un porte-outil ayant une plage de diamètres correspondant à la gorge à usiner. L'outil doit être réglé parallèlement à l'axe de rotation de la pièce à usiner (perpendiculaire à la face de la gorge). Sinon, il y a un risque de frottement sur le flanc de la gorge usinée.

Dans le cas où l'outil frotte contre le flanc extérieur de la gorge, il peut être nécessaire de régler l'arête de coupe au-dessus de l'axe de rotation (voir exemple A sur l'image 29).

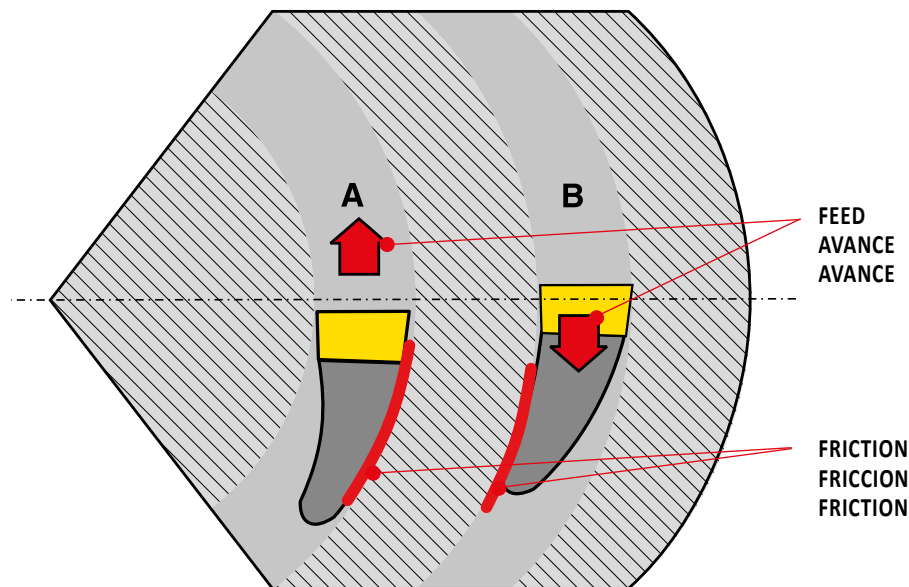
**TURNING OF SLENDER SHAFTS AND INTERNAL TURNING (BORING) OF DEEP HOLES**  
**TORNEADO DE REBAJES , TRONZADO Y TORNEADO DE COPIAS**  
**TOURNAGE D'ÉVIDEMENTS, TRONÇONNAGE ET GORGES**

When face grooving, the tool must be set to be perpendicular to the face of the workpiece with high accuracy, otherwise the side of the tool will rub against the groove being created.

En el ranurado frontal, la herramienta debe posicionarse con gran precisión para que quede perpendicular a la parte frontal de la pieza de trabajo; en caso contrario, el lateral de la herramienta rozará con la ranura que se está generando.

Pour l'usinage d'une gorge frontale, l'outil doit être réglé avec une grande précision pour être perpendiculaire à la face de la pièce, autrement le côté de l'outil frottera contre la gorge en cours d'usinage.

Picture / Imagen / Image 29



**Using effective coolant, applied directly to the cutting edge in sufficient quantities,** is very important. Cooling reduces the temperature of the cutting edge and also the lower part of the tool holder, in which the cutting insert is seated.

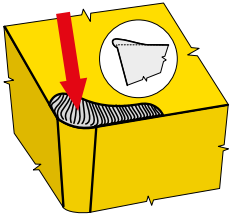







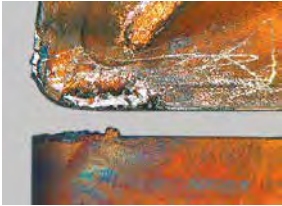
**Es muy importante el uso de un refrigerante de corte eficaz,** dirigido directamente al filo de corte en un volumen suficiente. El refrigerante debe reducir la temperatura del filo de corte y también de la parte subyacente del portaherramientas con el asiento para la plaquita de corte.

**L'utilisation d'un liquide de coupe (arrosage) doit être efficace et dirigé directement sur l'arête de coupe en quantité suffisante.** Le refroidissement permet de réduire la température de l'arête de coupe et de la partie du porte-outil supportant la plaquette.

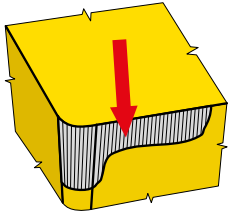







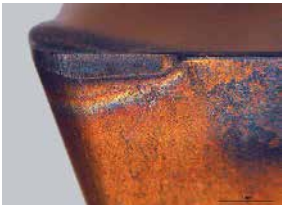
Table 26  
Tabla 26  
Tableau 26

TYPES OF WEAR ON TURNING INSERTS  
TIPOS DE DESGASTE DE LAS PLAQUITAS DE TORNEADO  
TYPES D'USURE DES PLAQUETTES DE TOURNAGE

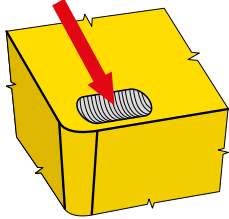
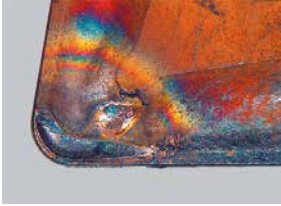







BUILT-UP EDGE / FILO DE APORTACIÓN  
ARÊTE RAPPORTÉE

			<p>it has no influence No influye N'a aucune influence</p>
		++	<p>any coating (decisive factor is anti-adhesion effect) Cualquier recubrimiento (el factor decisivo es el efecto anti-adherente) Tout revêtement (le facteur décisif est l'effet anti-adhérence)</p>
		↑	<p>The higher the feed rate the less probability of built-up edge creation. Cuanto mayor sea el avance menor probabilidad de formación de filo de aportación Plus l'avance est forte, moins la probabilité de générer une arête rapportée est grande</p>
		↓↑	<p>Change (generally increase) the cutting speed. Cambiar (generalmente aumentar) la velocidad de corte Modifier (souvent en l'augmentant) la vitesse de coupe</p>
			<p>it has no influence No influye N'a aucune influence</p>
		↓↑	<p>Use more positive geometry (built up edge is not created when the rake angle is more than 40°) Utilizar una geometría más positiva (el filo de aportación no se crea cuando el ángulo de desprendimiento es mayor de 40°) Utiliser une géométrie plus positive (Une arête rapportée n'apparaît jamais sur des angles de coupe de plus de 40°)</p>
	-	<p>Use a coolant with more effective anti-sticking properties (or no coolant at all) Usar un refrigerante con propiedades anti-adherencia más efectivas (o no utilizar ningún refrigerante) Utiliser un arrosage plus efficace quant à ses propriétés anti-adhérentes (ou pas du tout d'arrosage)</p>	
			

FLANK WEAR / DESGASTE EN FLANCO (EN INCIDENCIA)  
USURE EN DÉPOUILLE

		↑	<p>use a more wear resistant substrate (H) Utilizar un sustrato más resistente al desgaste (H) Utiliser un substrat plus résistant à l'usure (H)</p>
		++	<p>any coating (decisive factor is hardness - TiC, TiCN) Cualquier recubrimiento (el factor decisivo es la dureza - TiC, TiCN) Tout revêtement (le facteur décisif est sa dureté - TiC, TiCN)</p>
		↑	<p>increase feed (especially if it is under .004") Incrementar el avance (especialmente si está por debajo de .004") Augmenter l'avance (particulièrement quand elle est inférieure à .004")</p>
		↓	<p>decrease cutting speed Reducir la velocidad de corte Diminuer la vitesse de coupe</p>
			<p>It has no influence No influye N'a aucune influence</p>
		↑	<p>increase the clearance angle Lo más importante es aumentar el ángulo de incidencia Le plus important est d'augmenter l'angle de dépouille</p>
	+	<p>use a coolant or increase its intensity Usar refrigerante o incrementar su intensidad Utiliser l'arrosage ou augmenter son débit</p>	
			

**CRATERING / CRÁTER  
USURE EN CRATÈRE**

 		↑	use a more wear resistant substrate (S) Utilizar un sustrato más resistente al desgaste (S) Utiliser un substrat plus résistant à l'usure (S)
		++	any coating (decisive factor is thermal resistance - $\alpha \text{Al}_2\text{O}_3$ ) Cualquier recubrimiento (el factor decisivo es la resistencia térmica - $\alpha \text{Al}_2\text{O}_3$ ) Tout revêtement (le facteur décisif est sa résistance à la température - $\alpha \text{Al}_2\text{O}_3$ )
		↑	feed has influence on shape and position of crater El avance influye en la forma y la posición del cráter L'avance influe sur la forme et la position du cratère
		↓	decrease cutting speed Reducir la velocidad de corte Diminuer la vitesse de coupe
		↓	minimal effect Mínimo efecto Effet minime
		↑	use more positive cutting geometry Utilizar una geometría de corte más positiva Utiliser une géométrie de coupe plus positive
		++	use coolant or increase its intensity Usar refrigerante o incrementar su intensidad Utiliser l'arrosage ou augmenter son débit

**OXIDATION GROOVE ON THE MINOR EDGE / ENTALLA POR OXIDACIÓN  
ENTAILLE PAR OXYDATION SUR L'ARÊTE SECONDAIRE**

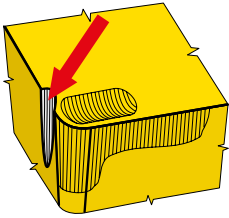
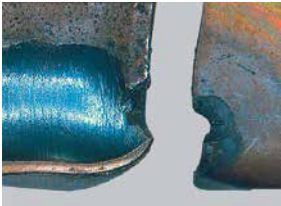







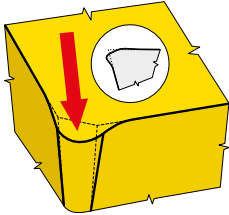
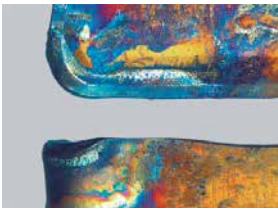







 		↑	use a more wear resistant substrate (S) Utilizar un sustrato más resistente al desgaste (S) Utiliser un substrat plus résistant à l'usure (S)
		++	any coating (decisive factor is oxidation resistance - $\alpha \text{Al}_2\text{O}_3$ ) Cualquier recubrimiento (el factor decisivo es la resistencia a la oxidación - $\alpha \text{Al}_2\text{O}_3$ ) Tout revêtement (le facteur décisif est sa résistance à l'oxydation - $\alpha \text{Al}_2\text{O}_3$ )
		↓	feed has influence on shape and position of groove El avance influye en la forma y la posición de la entalla L'avance influe sur la forme et la position de l'entaille
		↓	decrease cutting speed Reducir la velocidad de corte Diminuer la vitesse de coupe
		↓	minimal effect Mínimo efecto Effet minime
		↑	use another (more positive) cutting geometry Utilizar otra (más positiva) geometría de corte Utiliser une autre géométrie de coupe (plus positive)
		++	use coolant or increase its intensity Usar refrigerante o incrementar su intensidad Utiliser l'arrosage ou augmenter son débit



Table 26  
Tabla 26  
Tableau 26

TYPES OF WEAR ON TURNING INSERTS  
TIPOS DE DESGASTE DE LAS PLAQUITAS DE TORNEADO  
TYPES D'USURE DES PLAQUETTES DE TOURNAGE

PLASTIC DEFORMATION / DEFORMACIÓN PLÁSTICA  
DÉFORMATION PLASTIQUE

 		↑	use a more wear resistant grade (decisive factor is content of Co) Utilizar un sustrato más resistente al desgaste (el factor decisivo es el contenido en Co) Utiliser un substrat plus résistant à l'usure (le taux de cobalt est décisif)
		+	any coating (decisive factor is friction) Cualquier recubrimiento (el factor decisivo es la fricción) Tout revêtement (le facteur décisif est le frottement)
		↓	decrease feed rate Reducir el avance Diminuer l'avance
		↓	decrease cutting speed Reducir la velocidad de corte Diminuer la vitesse de coupe
		↓	minimal effect Mínimo efecto Effet minime
		↑	use another (more positive) cutting geometry Utilizar otra (más positiva) geometría de corte Utiliser une autre géométrie de coupe (plus positive)
		++	use coolant or increase its intensity Usar refrigerante o incrementar su intensidad Utiliser l'arrosage ou augmenter son débit

SIDE FLANK NOTCH - REMEDY / ENTALLA LATERAL - REMEDIO  
USURE EN ENTALLE

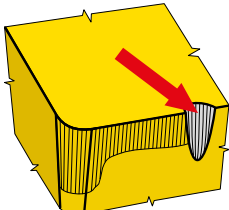
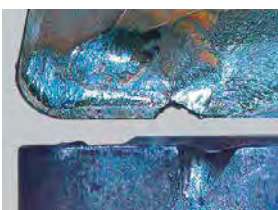







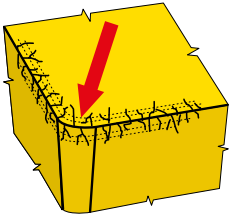
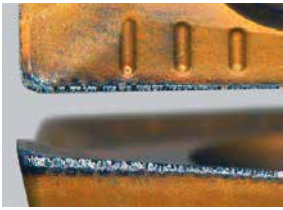







 		↑ ↓	it depends on the character of the damage (abrasive - use more wear resistant substrate; breaking - use tougher substrate) Depende del caracter del problema (abrasivo - usar un sustrato más resistente al desgaste; rotura - usar un sustrato más tenaz) Dépend de la cause de l'usure (abrasion - utiliser un substrat plus résistant à l'usure; rupture - utiliser un substrat plus tenace)
		++	CVD coating (decisive factor is oxidation resistance - $\alpha$ Al <sub>2</sub> O <sub>3</sub> ) Recubrimiento CVD (el factor decisivo es la resistencia a la oxidación - $\alpha$ Al <sub>2</sub> O <sub>3</sub> ) Revêtement CVD (le facteur décisif est sa résistance à l'oxydation - $\alpha$ Al <sub>2</sub> O <sub>3</sub> )
		↓	feed has influence on intensity, but less than the cutting speed El avance influye en la intensidad, pero menos que la velocidad de corte L'avance influe sur l'intensité, mais moins que la vitesse de coupe
		↓	decrease cutting speed Reducir la velocidad de corte Diminuer la vitesse de coupe
		↑ ↓	use unequal depth of cut Utilizar una profundidad de corte desigual Faire varier la profondeur de coupe
		↓	use less positive cutting geometry Utilizar una geometría de corte menos positiva Utiliser une géométrie moins positive
		+	use coolant or increase its intensity Usar refrigerante o incrementar su intensidad Utiliser l'arrosage ou augmenter son débit
			use tool with smaller setting angle Utilizar una herramienta con menor ángulo de posición Utiliser un outil avec un angle d'attaque plus petit

Table 26  
Tabla 26  
Tableau 26

TYPES OF WEAR ON TURNING INSERTS  
TIPOS DE DESGASTE DE LAS PLAQUITAS DE TORNEADO  
TYPES D'USURE DES PLAQUETTES DE TOURNAGE

CREATION OF RACK CRACKS / MICRO-FISURAS  
USURE EN PEIGNE (FISSURES)

 		↓	(H) grain has a great influence El sustrato (H) tiene un papel muy importante Choisir un substrat à grains plus gros (H)
		++	PVD coating recommended Se recomienda recubrimiento PVD Un revêtement PVD est recommandé
		↓	feed has influence on intensity, but less than the cutting speed El avance influye en la intensidad, pero menos que la velocidad de corte L'avance influe sur l'intensité, mais moins que la vitesse de coupe
		↓	lower speed means lower temperature Menor velocidad significa menor temperatura Vitesse plus basse veut dire température moins élevée
			it has no influence No influye N'a aucune influence
		↓	use less positive cutting geometry Utilizar una geometría de corte menos positiva Utiliser une géométrie moins positive
		---	no coolant (it is possible to use air to remove chips from cutting area) Sin refrigeración (se puede utilizar aire para evacuar virutas de la zona de corte) Pas d'arrosage (utiliser de l'air pour évacuer les copeaux hors de la zone de coupe)

BRITTLE CRACKS AT THE CUTTING EDGE / ASTILLAMIENTO DEL FILO DE CORTE  
ÉCAILLAGE DE L'ARÊTE DE COUPE

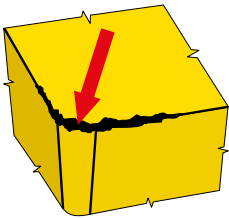
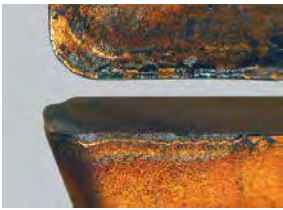







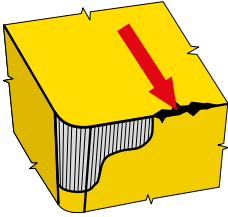








 		↓	(H) grain has a great influence El sustrato (H) tiene un papel muy importante Choisir un substrat à grains plus gros (H)
		+	PVD coating recommended Se recomienda recubrimiento PVD Un revêtement PVD est recommandé
		↓	Good swarf control is very important Es muy importante una rotura de virutas correcta Un bon fractionnement du copeau est très important
		↑ ↓	it is about swarf control and vibration Influye en la rotura de virutas y las vibraciones Il s'agit d'évacuation copeaux et de vibrations
		↓	reduces the force load (important for machining with long overhangs) Reduce la carga mecánica en el filo de corte (importante cuando se mecaniza con voladizos largos) Réduire la charge (important pour l'usinage avec de longs porte-à-faux)
		↓	use less positive cutting geometry Utilizar una geometría de corte menos positiva Utiliser une géométrie moins positive
			it has no influence No influye N'a aucune influence

Table 26  
Tabla 26  
Tableau 26

TYPES OF WEAR ON TURNING INSERTS  
TIPOS DE DESGASTE DE LAS PLAQUITAS DE TORNEADO  
TYPES D'USURE DES PLAQUETTES DE TOURNAGE

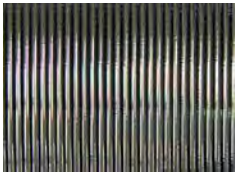
FAILURE OF CUTTING EDGE / DESPRENDIMIENTO DEL FILO POR MARTILLO DE VIRUTAS  
AFFAIBLISSEMENT DE L'ARÊTE DE COUPE

		↓	(H) grain has a great influence El sustrato (H) tiene un papel muy importante Choisir un substrat à grains plus gros (H)
		+	PVD coating recommended Se recomienda recubrimiento PVD Un revêtement PVD est recommandé
		↑ ↓	Good swarf control is very important Es muy importante una rotura de virutas correcta Un bon fractionnement du copeau est très important
		↑ ↓	it is about swarf control and vibration Influye en la rotura de virutas y las vibraciones Il s'agit d'évacuation copeaux et de vibrations
		↑ ↓	Good swarf control is very important Es muy importante una rotura de virutas correcta Un bon fractionnement du copeau est très important
		↓	use less positive cutting geometry Utilizar una geometría de corte menos positiva Utiliser une géométrie moins positive
			it has no influence No influye N'a aucune influence
			problem is poor swarf control or evacuation of chips El problema es una mala rotura de virutas, evacuación de virutas o arranque de viruta Le problème est un mauvais fractionnement du copeau, une mauvaise évacuation des copeaux

INSERT FRACTURE / ROTURA DE PLAQUITA  
RUPTURE DE PLAQUETTE

		↓	(H) grain has a great influence El sustrato (H) tiene un papel muy importante Choisir un substrat à grains plus gros (H)
		+	PVD coating recommended Se recomienda recubrimiento PVD Un revêtement PVD est recommandé
		↓	reduces the force load Reduce la carga mecánica en el filo de corte Réduire la charge
		↑ ↓	it is about swarf control and vibration Influye en la evacuación de viruta y vibraciones Il s'agit d'évacuation copeaux et de vibrations
		↓	reduces the force load Reduce la carga mecánica en el filo de corte Réduire la charge
		↓	use less positive cutting geometry Utilizar una geometría de corte menos positiva Utiliser une géométrie moins positive
			it has no influence No influye N'a aucune influence
			Use better working conditions Mejorar las condiciones de trabajo Utiliser de meilleures conditions de travail

**POOR SURFACE QUALITY / MALA CALIDAD DE LA SUPERFICIE  
QUALITÉ DE SURFACE MAUVAISE**



**Description and cause:**

Numerous causes depending on the workpiece material, cutting conditions (feed rate and cutting speed), the condition of the cutting edge, the extent and type of wear, and the condition and rigidity of the machine–tool–workpiece assembly.

- incorrect tool chosen
- incorrect chip thickness
- incorrect cutting speed
- coolant is needed
- high feed rate

**Corrective measures:**

- use a wiper insert
- use a cutting insert with the right geometry
- reduce the feed rate
- change (usually increase) the cutting speed
- use a coolant
- improve the stability of the tool and workpiece
- change the chip cross section
- select a more easy-cutting chip breaker
- increase the nose radius

**Descripción y causa:**

Las causas son diversas, en función del material de la pieza de trabajo, las condiciones de corte (avance y velocidad de corte), la condición del filo de corte, la extensión y el tipo de desgaste, la condición y la rigidez de la pieza de trabajo mecanizada.

- elección incorrecta de herramienta
- espesor de viruta inadecuado
- velocidad de corte inadecuada
- se necesita refrigerante
- velocidad de avance alta

**Solución del problema:**

- utilizar una plaquita rascadora (wiper)
- utilizar plaquita de corte con la geometría adecuada
- reducir la velocidad de avance
- cambiar (normalmente aumentar) la velocidad de corte
- utilizar un refrigerante
- mejorar la estabilidad de la herramienta y la pieza de trabajo
- cambiar la sección transversal de la viruta
- seleccionar un rompevirutas que corte con más facilidad
- aumentar el radio de punta

**Description et cause:**

Les causes sont nombreuses, elles dépendent du matériau à usiner, des conditions de coupe (avance et vitesse de coupe), de la condition de l'arête de coupe, du niveau et du type d'usure, de l'état et de la rigidité de la machine.

- mauvais choix d'outil
- mauvaise épaisseur du copeau
- mauvaise vitesse de coupe
- arrosage nécessaire
- vitesse d'avance élevée

**Solution:**

- utiliser une plaquette racluse (Wiper)
- utiliser une plaquette avec une géométrie correcte
- réduire la vitesse d'avance
- changer (en général augmenter) la vitesse de coupe
- utiliser l'arrosage
- améliorer la stabilité de l'outil et de la pièce et à usiner
- changer la section du copeau
- sélectionner une géométrie plus coupante
- utiliser une plaquette avec un plus gros rayon de pointe

VIBRATIONS / VIBRACIONES  
VIBRATIONS

**Description and cause:**

This is a very common problem, which is mainly caused by an unbalanced workpiece or tool, unstable fixing of the workpiece, high cutting forces or tool overhang.

**Corrective measures:**

- improve the stability of the tool and workpiece
- reduce the depth of cut
- minimize tool overhang
- reduce the cutting speed
- use a tool with smaller setting angle
- reduce the chip cross section
- use a tool with a low cutting resistance
- increase the feed rate
- select a more easy-cutting chip breaker
- increase the nose radius

**Descripción y causa:**

Son muy frecuentes. Los principales motivos son el desequilibrio de la pieza de trabajo o la herramienta, la estabilidad de la pieza de trabajo, las fuerzas de corte elevadas o el voladizo de la herramienta.



**Solución del problema:**

- mejorar la estabilidad de la herramienta y la pieza de trabajo
- reducir la profundidad de corte
- minimizar el voladizo de la herramienta
- reducir la velocidad de corte
- utilizar una herramienta con un ángulo de posicionamiento más pequeño
- reducir la sección transversal de la viruta
- utilizar una herramienta con una baja resistencia de corte
- aumentar la velocidad de avance
- seleccionar un rompevirutas que corte con más facilidad
- aumentar el radio de punta

**Description et cause:**

Ceci est très fréquent. Les principales raisons sont le déséquilibre de la pièce ou de l'outil, la mauvaise stabilité de la pièce, des forces de coupe très fortes, du porte-à-faux de l'outil.

**Solution:**

- améliorer la stabilité de l'outil et de la pièce et à usiner
- réduire la profondeur de coupe
- diminuer le porte-à-faux de l'outil
- réduire la vitesse de coupe
- utiliser un outil avec un angle d'attaque plus petit
- réduire la section copeaux
- utiliser un outil avec une plus faible résistance à la coupe
- augmenter la vitesse d'avance
- sélectionner une géométrie plus coupante
- utiliser une plaquette avec un plus gros rayon de pointe

**BURRS / REBABAS  
BAVURE**

	<p><b>Description and cause:</b> This usually occurs on soft steels and plastic materials.</p>	<p><b>Corrective measures:</b></p> <ul style="list-style-type: none"> <li>- use a cutting insert with a sharp cutting edge</li> <li>- use a cutting insert with positive geometry</li> <li>- use a tool with a smaller setting angle</li> </ul>
	<p><b>Descripción y causa:</b> Suelen aparecer en el mecanizado de aceros blandos y materiales plásticos.</p>	<p><b>Solución del problema:</b></p> <ul style="list-style-type: none"> <li>- utilizar una plaquita de corte con filo de corte afilado</li> <li>- utilizar una plaquita de corte con geometría positiva</li> <li>- utilizar una herramienta con un ángulo de posicionamiento más pequeño</li> </ul>
	<p><b>Description et cause:</b> Ceci apparaît régulièrement en usinage de matériaux doux ou de matières plastiques.</p>	<p><b>Solution:</b></p> <ul style="list-style-type: none"> <li>- utiliser une plaquette avec une arête vive</li> <li>- utiliser une plaquette avec une géométrie positive</li> <li>- utiliser un outil avec un angle d'attaque plus petit</li> </ul>

**ERRORS IN DIMENSIONS AND SHAPE OF WORKPIECE / ERRORES EN DIMENSIONES Y FORMA DE LA PIEZA  
INEXACTITUDE DES DIMENSIONS ET DE LA FORME DE LA PIÈCE**

	<p><b>Description and cause:</b> Depends on a number of factors.</p>	<p><b>Corrective measures:</b></p> <ul style="list-style-type: none"> <li>- use a wear-resistant cutting insert</li> <li>- improve the stability of the cutter and workpiece</li> <li>- minimize tool overhang</li> <li>- use a workpiece with a suitable machining allowance</li> </ul>
	<p><b>Descripción y causa:</b> Depende de diversos factores.</p>	<p><b>Solución del problema:</b></p> <ul style="list-style-type: none"> <li>- utilizar una plaquita de corte resistente al desgaste</li> <li>- mejorar la estabilidad de la herramienta y la pieza de trabajo, minimizar el voladizo</li> <li>- utilizar una pieza de trabajo con un margen de mecanizado adecuado</li> </ul>
	<p><b>Description et cause:</b> Dépend d'un certain nombres de facteurs.</p>	<p><b>Solution:</b></p> <ul style="list-style-type: none"> <li>- utiliser une plaquette résistante à l'usure</li> <li>- améliorer la stabilité de l'outil et de la pièce usinée, diminuer le porte-à-faux de l'outil</li> <li>- utiliser une pièce avec une surépaisseur d'usinage mieux appropriée</li> </ul>

**INADEQUATE CHIP FORMATION / FORMACIÓN INADECUADA DE VIRUTA  
MAÎTRISE DES COPEAUX INACCEPTABLE**

**Description and cause:**

Producing a chip with a suitable shape is very important to insert durability and service life of the tool. The workpiece material, the feed rate, the depth of cut and the cutting geometry all have an effect on chip forming. A chip that is too long is unacceptable for various reasons, while a chip that is too short is undesirable as it overloads the cutting edge and causes vibrations.

**Corrective measures:**

- change the feed rate and depth of cut
- use a more suitable cutting geometry
- change the cutting conditions

**Descripción y causa:**

Una forma adecuada de la viruta es un criterio importante, igual que la durabilidad (vida útil de la herramienta). El material de la pieza de trabajo, el avance, la profundidad de corte y la geometría de corte adecuada (rompevirutas) afectan a la formación correcta de las virutas. Una viruta larga es inaceptable, pero una viruta demasiado corta (triturada) tampoco es deseable, ya que indica una sobrecarga del filo y causa vibraciones.

**Solución del problema:**

- cambiar el avance y la profundidad de corte
- utilizar una geometría de corte más adecuada
- cambiar las condiciones de corte



**Description et cause:**

Une forme de copeau convenable est un critère important, comme la durée de vie de l'outil. Le matériau de la pièce à usiner, l'avance, la profondeur de coupe, la géométrie de coupe adaptée (brise-copeaux) agissent sur la forme correcte du copeau. Un copeau long est inacceptable cependant qu'un copeau trop court (écrasé) n'est pas souhaitable, ceci indique une trop forte charge sur l'arête et génère des vibrations.

**Solution:**

- changer l'avance et la profondeur de coupe
- utiliser une plaquette avec une géométrie correcte
- changer les conditions de coupe

GENERAL PRINCIPLES / PRINCIPIOS GENERALES  
PRINCÍPIOS GERAIS / PRINCIPES GÉNÉRAUX

**Check the seat condition of the cutting insert**

Before clamping a new cutting insert or changing the edge, it is necessary to clean the seat and check its condition or the condition of the anvil and wedge (especially the damage under the corner of the cutting insert).

**Check and service the clamping parts**

It is also important to check the clamping parts, including clamping levers, screws, wedges and clamps. Only use original, undamaged parts (found in the catalogue). Regularly lubricate the threads and the binding surface of screws, for example using heat-resistant lubricant (Molykote G.). For assembly and disassembly, only use screwdrivers and wrenches specified in our catalogue or recommended by the tool manufacturer. Pay attention to the correct tightening (proportional) – it is advisable to use a torque wrench.

**Check the tightening**

Before tightening, check the fit of the cutting insert on the whole of the binding surface and in the radial and axial directions. Cutting inserts and tools must always be clean and undamaged.

**Comprobar el estado del asiento de la plaquita:**

Antes de montar una plaquita nueva o cambiar el filo de corte, es necesario limpiar el asiento y comprobar el estado de la plaquita de apoyo, especialmente la esquina que está bajo el filo de corte.

**Comprobar el mantenimiento de los elementos de fijación:**

Compruebe los elementos de fijación: palancas de fijación, tornillos, cuñas, abrazaderas. Utilice solo piezas sin daños, utilice solo las piezas originales que se encuentran en el catálogo. Lubrique regularmente las roscas y las superficies de unión de los tornillos, por ejemplo, con un lubricante resistente al calor (Molykote G.). Para el montaje y el desmontaje, utilice solo los destornilladores y las llaves recomendados en nuestro catálogo por el fabricante de la herramienta. Preste atención al apriete adecuado (proporcional), se recomiendan llaves dinamométricas.

**Comprobar el apriete:**

Antes de apretar, comprobar la forma en que la plaquita asienta en el portaherramientas, tanto en la superficie plana bajo el filo como en las paredes axial y radial del asiento. Herramientas y plaquitas deben estar siempre limpias y sin daños.

**Vérification de l'état correct des logements de plaquettes:**

Avant le serrage d'une nouvelle plaquette ou avant de changer une arête (indexage ou rotation de la plaquette) il est nécessaire de nettoyer le logement, de vérifier l'état du système de fixation de la plaquette et du corps d'outil (particulièrement l'endroit sous la pointe de la plaquette).

**Vérification et maintenance des pièces de fixation:**

La vérification des pièces de fixation (leviers, vis, coins, brides) est importante. Utiliser uniquement des pièces d'origine et en bon état (vous les trouvez dans le catalogue). Graisser régulièrement les filets et les surfaces de contact des vis, par exemple avec de la graisse résistante à haute température (Molykote G.). Pour le montage et le démontage, utiliser seulement les clés et les tournevis comme sur le catalogue ou recommandés par le fabricant d'outil. Porter attention au couple de serrage, nous recommandons l'usage d'un tournevis dynamométrique.

**Vérification du serrage:**

Au serrage, vérifier l'appui de la plaquette sur la surface de contact avec le trou et dans les directions radiale et axiale. Les plaquettes et les outils doivent rester propres et intacts.



Table 28  
Tabla 28

FORMULA FOR CALCULATING CUTTING DATA  
FÓRMULAS PARA EL CÁLCULO DE LOS PARÁMETROS DE CORTE

Value / Valor	Formula / Fórmula	Unit / Unidad	Note / Nota
Number of revolutions Número de revoluciones	$n = \frac{v_c \cdot 12}{D \cdot \pi}$	[1.min <sup>-1</sup> ] [rpm]	n Number of revolutions [1.min <sup>-1</sup> ] D Diameter [in] (of tool or workpiece) v <sub>c</sub> Cutting speed [ft.min <sup>-1</sup> ] f <sub>rev</sub> Feed per revolution [in.rev] f <sub>min</sub> Feed per minute [in.min] (Linear Feedrate)
Cutting speed Velocidad de corte	$v_c = \frac{\pi \cdot D \cdot n}{12}$	[ft.min]	n Número de revoluciones [rpm] D Diámetro [in] (de herramienta o pieza de trabajo) v <sub>c</sub> Velocidad de corte [m.min <sup>-1</sup> ] f <sub>rev</sub> Avance por revolución [in.rot] f <sub>min</sub> Avance por minuto [in.min <sup>-1</sup> ] (Velocidad de avance lineal)
Feed per revolution Avance por revolución	$f_{rev} = \frac{f_{min}}{n} = f_z \cdot z$	[in.rev]	
Feed per minute (Linear Feedrate) Avance por minuto	$f_{min} = v_f = f_{ot} \cdot n$	[in.min]	
Max. height of profile R <sub>max</sub> Altura máx. del perfil R <sub>max</sub>	$R_{max} = 127000 \cdot \frac{f^2}{r_\epsilon}$	[µin]	R <sub>max</sub> max. height of profile [µin] R <sub>a</sub> surface finish [µin] f <sub>rev</sub> feed per revolution [in.rev] r <sub>ε</sub> nose radius [in]
Surface finish R <sub>a</sub> Acabado superficial R <sub>a</sub>	$R_a = 33337 \cdot \frac{f_z^{1,88}}{r_\epsilon^{,97}}$	[µin]	R <sub>max</sub> Altura máx. del perfil [in] R <sub>a</sub> Acabado de superficie [in] f <sub>rev</sub> Avance por revolución [in/rot] r <sub>ε</sub> Radio de la punta [in]
Chip cross section Sección transversal de viruta	$A = f_{rev} \cdot a_p$	[in <sup>2</sup> ]	A Chip cross section [in <sup>2</sup> ] f <sub>rev</sub> Feed per revolution [in.rev] a <sub>p</sub> Axial depth of cut [in] κ <sub>r</sub> Primary edge setting angle [°] h Chip thickness [in] v <sub>c</sub> Cutting speed [in.min] f <sub>min</sub> Feed per minute [in.min] (Linear Feedrate)
Chip thickness (For insert with straight edge) Espesor de viruta	$h = f \cdot \sin \kappa_r$	[in]	Q Material removal rate per minute [in <sup>3</sup> .min]
Chip thickness (For round cutting insert) Espesor de viruta	$h = f_z \cdot \sqrt{\frac{a_p}{D}}$	[in]	A Sección transversal de viruta [in <sup>2</sup> ] f <sub>rev</sub> Avance por revolución [in/rev] a <sub>p</sub> Profundidad de corte axial [in] κ <sub>r</sub> Ángulo de posicionamiento del filo principal [°] h Espesor de viruta [in] v <sub>c</sub> Velocidad de corte [m.min] f <sub>min</sub> Avance por minuto [in.min] (Velocidad de avance lineal)
Metal removal rate Caudal de Viruta	$Q = 12 \cdot a_p \cdot f_{ot} \cdot v_c$	[in <sup>3</sup> /min]	Q Tasa de arranque de material por minuto [in <sup>3</sup> .min]

Material Material	Steel Acero	Cast iron Fundición	Al
Coefficient x Coeficiente x	20	25	100

Tableau 28

## FORMULES DE CALCUL DES PARAMÈTRES DE COUPE

Valeur	Formule	Unité	Note
Vitesse de rotation	$n = \frac{v_c \cdot 12}{D \cdot \pi}$	[1.min <sup>-1</sup> ]	n Vitesse de rotation [1.min <sup>-1</sup> D Diamètre [in] (de l'outil ou de la pièce à usiner) v <sub>c</sub> Vitesse de coupe [ft.min <sup>-1</sup> f <sub>rev</sub> Avance par tour [in.tr] f <sub>min</sub> Avance par minute [in.min] (Avance linéaire)
Vitesse de coupe	$v_c = \frac{\pi \cdot D \cdot n}{12}$	[ft.min]	
Avance par tour	$f_{rev} = \frac{f_{min}}{n} = f_z \cdot z$	[in.U]	
Avance par minute (Avance linéaire)	$f_{min} = v_f = f_{ot} \cdot n$	[in.min]	
Hauteur maximum du profil R <sub>max</sub>	$R_{max} = 127000 \cdot \frac{f^2}{r_\epsilon}$	[µin]	R <sub>max</sub> Hauteur maximum du profil [in] R <sub>a</sub> Etat de surface [in] f <sub>rev</sub> Avance par tour [in.tr] r <sub>ε</sub> Rayon de pointe [in]
Etat de surface R <sub>a</sub>	$R_a = 33337 \cdot \frac{f_z^{1,88}}{r_\epsilon^{,97}}$	[µin]	
Section copeau	$A = f_{rev} \cdot a_p$	[in <sup>2</sup> ]	A Section copeau [in <sup>2</sup> f <sub>rev</sub> Avance par tour [in.tr] a <sub>p</sub> Angle d'attaque principal [in] κ <sub>r</sub> Angle d'attaque principal κ <sub>r</sub> [°] h Epaisseur copeau [in]
Epaisseur copeau (Pour plaquette avec arête droite)	$h = f \cdot \sin \kappa_r$	[in]	v <sub>c</sub> Vitesse de coupe [in.min] f <sub>min</sub> Avance par minute [in.min] (Avance linéaire) Q Taux d'enlèvement de matière par minute [in <sup>3</sup> .min]
Epaisseur copeau (Pour plaquette ronde)	$h = f_z \cdot \sqrt{\frac{a_p}{D}}$	[in]	
Taux d'enlèvement de matière	$Q = 12 \cdot a_p \cdot f_{ot} \cdot v_c$	[in <sup>3</sup> /min]	Matière Acier Fonte Al Coefficient x

### CLAMPING SCREW / TORNILLO DE FIJACIÓN / VIS DE FIXATION

Screw designation / Tipo de tornillo / Désignation de la vis	Screwdriver / Destornillador / Tournevis	Torque [Nm]* / Par de apriete [Nm]* / Couple [Nm]*
28588	MA2-8304	0.8
28992	MA2-8304	0.8
416.1-832	PT-8002	3.6
5513 020-01	PT-8004	3.6
5513 020-03	PT-8001	0.8
5513 020-04	PT-8003	1.5
5513 020-05	PT-8001	0.8
5513 020-14	TX 225PLUS	8.5
5513 020-24	PT-8002	1.5
5513 020-27	PT-8000	0.6
5513 020-28	PT-8000	0.6
5513 021-03	DMN 3124	13
CS 8601-T09P	SDR T09P	1.7
CS 8601-T15P	SDR T15P	3.9
CS 8601-T20P	SDR T20P	6.4
CS 8601-T25P	SDR T25P	9.5
DVF 0573	PT-8002	1.5
DVF 2260	TX 215PLUS	3.6
DVF 3584	DMD 1650	0.6
DVF 3593	TX 207PLUS	0.8
HS 0408	HXX 3	5
HS 0520C	HXX 4	5
HS 0616C	HXX 5	8
HS 0620	HXX 5	6
HS 0620C	HXX 5	6
HS 0625	HXX 5	6
HS 0625C	HXX 5	6
HS 0630	HXX 5	6
HS 0825	HXX 6	10
HS 0830	HXX 6	10
HS 0835	HXX 6	10
HS 0840	HXX 8	11
HS 1030	HXX 8	8
HS 1060	HXX 6	10
HS 93	HXX 5	8
HS 94	HXX 5	8
HSI 1020	HXX 6	8
PS 0512	HXX 2	2
PS 0512-A	HXX 2	2
PS 0616	HXX 2,5	4
PS 12040	HXX 5	8
PS 6026-709P	SRD T09P	2
PS 8290	HXX 2	2
SR 14	HXX 10	10
SR 85011-T15P	SDR T15P	5
SR 85017-T09P	SDR T09P	2
SR 85020-T15P	SDR T15P	3
SR 86025-T20P	SRD T20P	5
T20.037	DMD 1650	0.6
UP 0909-T09P	SRD T09P	2
UP 1515-T15P	SDR T15P	8
US 2505-T07P	SDR T07P	0.9
US 2506-T07P	SDR T07P	0.9
US 3007-T09P	SDR T09P	2
US 34	HXX 3	5
US 35	HXX 4	6
US 3508-T15P	SDR T15P	3
US 3510A-T15P	SDR T15P	3
US 3510-T15P	SDR T15P	3

### CLAMPING SCREW / TORNILLO DE FIJACIÓN / VIS DE FIXATION

Screw designation / Tipo de tornillo / Désignation de la vis	Screwdriver / Destornillador / Tournevis	Torque [Nm]* / Par de apriete [Nm]* / Couple [Nm]*
US 3512A-T15P	SDR T15P	3
US 3512-T15P	SDR T15P	3
US 36	HXX 4	6
US 38	HXX 5	8
US 39	HXX 5	8
US 40	HXX 4	6
US 4008-T15P	SDR T15P	3.5
US 4011-T15P	SDR T15P	3.5
US 41	HXX 4	6
US 42	HXX 4	6
US 45013-T20P	SDR T20P	5
US 4512-T15P	SDR T15P	5
US 4514A-T20	SDR T20	5
US 46	HXX 3	5
US 46017-T20P	SDR T20P	5
US 47	HXX 5	8
US 5012-T15P	SDR T15P	5
US 5015-T20P	SDR T20P	5
US 5018-T20P	SDR T20P	5
US 6020-T25P	SDR T25P	6
US 64518-T15P	SDR T15P	5
US 8025-T30P	SDR T20P	13
US 83	HXX 4	6
US 95	HXX 4	10

### TORQUE SCREWDRIVERS / DESTORNILLADORES DINAMOMÉTRICOS TOURNEVIS DYNAMOMÉTRIQUES

Torque handle / Mango de apriete / Tige dynamométrique	Torque (Nm) / Par de apriete (Nm) / Couple (Nm)	Clamping screw thread / Rosca del tornillo de apriete / Pas de la vis de fixation
MR-0.8-2.0 vario	0.5 - 2.0	M 2 - M 3
MR-1.0-5.0 vario	0.8 - 5.0	M 2.5 - M 5
MR-0.9 fix	0.9	M 2
MR-2.0 fix	2.0	M 3
MR-3.0 fix	3.0	M 3.5
MR-3.5 fix	3.5	M 4
MR-5.0 fix	5.0	M 5

### REPLACEABLE SHANKS / VÁSTAGOS SUSTITUIBLES POIGNÉES REMPLAÇABLES

Replaceable shanks / Vástagos sustituibles / Poignées remplaçables

D-T6
D-T6P
D-T7
D-T7P
D-T8
D-T8P
D-T9
D-T9P
D-T15
D-T15P
D-T20
D-T20P

### SCREW LUBRICATION

Insert clamping screws are subject to high thermal stresses. It is recommended that all screws be lubricated with a high quality paste such as MOLYKOTE 1000. This paste can be ordered in the same way as any other spare part from Dormer Pramet.

### LUBRICACIÓN DE TORNILLOS

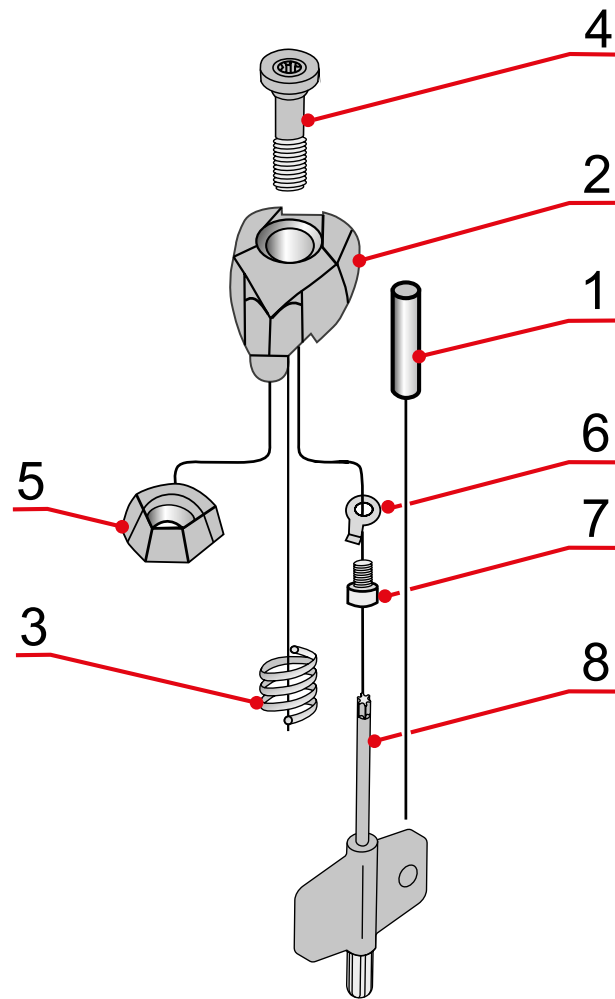
Los tornillos de fijación de las plaquitas están sometidos a tensiones térmicas elevadas. Se recomienda lubricar todos los tornillos con una pasta de alta calidad como MOLYKOTE 1000. Esta pasta se puede pedir de la misma forma que cualquier otro recambio.

### LUBRIFICATION DES VIS

Dans le respect des contraintes thermiques élevées des vis de serrage, il est recommandé de les lubrifier avec une pâte haute qualité MOLYKOTE 1000. Cette pâte peut être commandée de la même façon que les pièces détachées.

Picture 30  
Imagen 30  
Image 30

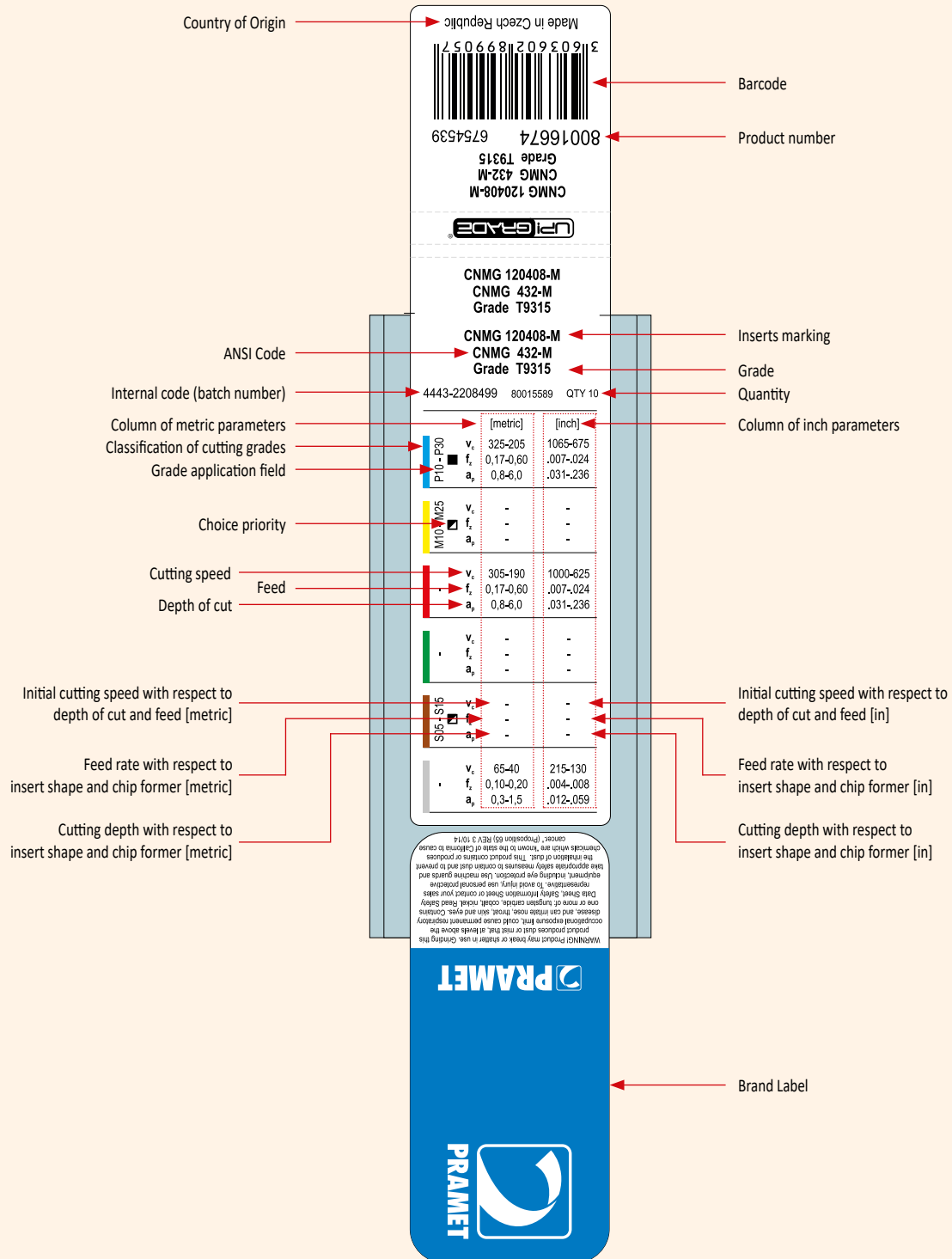
COMPLETE CLAMP SET  
JUEGO COMPLETO DE FIJACIÓN  
SET DE BRIDE COMPLET



	1	2	3	4		5	6	7	8
DCS 09	CP 3055	CD 09	PR 0157	CS 8601-T09P	1.7	-	-	-	-
DCS 12	CP 3007	CD 12	PR 0158	CS 8602-T15P	3.9	-	-	-	-
DCS 16	CP 3007	CD 16	PR 0159	CS 8603-T20P	6.4	-	-	-	-
DCS 19	CP 3007	CD 19	PR 0159	CS 8603-T20P	6.4	-	-	-	-
DCS 25	CP 3007	CD 25	PR 0101	CS 8604-T25P	9.5	-	-	-	-
DCS 16V	CP 3007	CD 16V	PR 0158	CS 8602-T15P	3.9	-	-	-	-
DCS 12C2	CP 3007	CD 12C2	PR 0158	CS 8602-T15P	3.9	PP 3002	H 1201	US 9701-T07P	FLAG T07P
DCS 16C2	CP 3007	CD 16C2	PR 0159	CS 8603-T20P	6.4	PP 3003	H 1201	US 9701-T07P	FLAG T07P
DCS 12C4	CP 3007	CD 12C4	PR 0158	CS 8602-T15P	3.9	PP 3002	H 1201	US 9701-T07P	FLAG T07P
DCS 16C4	CP 3007	CD 16C4	PR 0159	CS 8603-T20P	6.4	PP 3003	H 1201	US 9701-T07P	FLAG T07P

Picture 31.

TECHNICAL INFORMATION ON INSERT BOX



**Made in Czech Republic**

316036021899057

80016674 6754539

CNMG 120408-M  
CNMG 432-M  
Grade T9315

**UP1 GRADE**

CNMG 120408-M  
CNMG 432-M  
Grade T9315

CNMG 120408-M  
CNMG 432-M  
Grade T9315

4443-2208499 80015589 QTY 10

	[metric]	[inch]
P10 - P30	$v_c$ 325-205	1085-675
	$f_r$ 0,17-0,60	.007-.024
	$a_p$ 0,8-6,0	.031-.236
M10 VM25	$v_c$ -	-
	$f_r$ -	-
	$a_p$ -	-
S15 S15	$v_c$ 305-190	1000-625
	$f_r$ 0,17-0,60	.007-.024
	$a_p$ 0,8-6,0	.031-.236
S15 S15	$v_c$ -	-
	$f_r$ -	-
	$a_p$ -	-
S15 S15	$v_c$ 65-40	215-130
	$f_r$ 0,10-0,20	.004-.008
	$a_p$ 0,3-1,5	.012-.059

**PRAMET**

Pais de origen

Código de barras

Número de producto

Código ANSI

Código ISO

Código interno (número de lote)

Calidad

Cantidad

Parámetros métricos

Parámetros en pulgadas

Clasificación de calidades de corte según ISO 513

Campo de aplicación de la calidad

Prioridad de selección

Velocidad de corte

Avance

Profundidad de corte

Velocidad de corte inicial con respecto a la profundidad de corte y el avance (métrico)

Velocidad de avance con respecto a la forma de la plaquita y el formador de virutas (métrico)

Profundidad de corte con respecto a la forma de la plaquita y el formador de virutas (métrico)

Velocidad de corte inicial con respecto a la profundidad de corte y el avance (pulgadas)

Velocidad de avance con respecto a la forma de la plaquita y el formador de virutas (pulgadas)

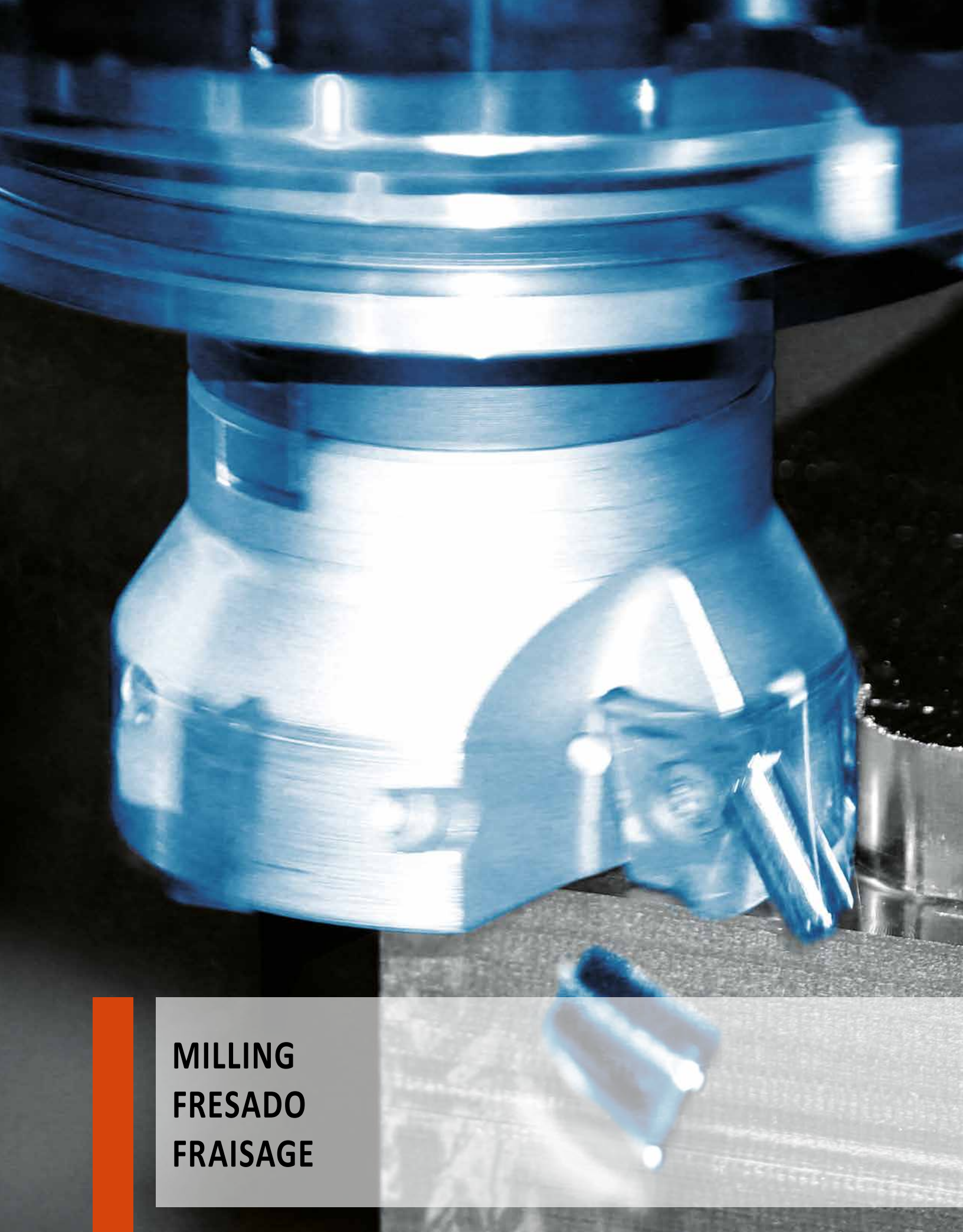
Profundidad de corte con respecto a la forma de la plaquita y el formador de virutas (pulgadas)

Etiqueta de Marca









**MILLING**  
**FRESADO**  
**FRAISAGE**

INSTRUCTIONS  
INSTRUCCIONES  
INSTRUCTIONS

 M4 – M13

NAVIGATOR  
NAVEGADOR  
NAVIGATEUR

 M14 – M25

MILLING CUTTERS + INSERTS + PLAQUITAS / FRAISES ET PLAQUETTES

FACE MILLING  
PLANEADO  
SURFAÇAGE

 M26 – M73

SQUARE SHOULDER MILLING  
ESCUADRADO  
FRAISAGE D'ÉPAULEMENTS

 M74 – M115

DEEP SHOULDER MILLING  
ESCUADRADO CON FILO LARGO  
FRAISAGE D'ÉPAULEMENTS PROFONDS

 M116 – M126

SLOT MILLING  
RANURADO  
RAINURAGE

 M127 – M132

COPY MILLING  
COPIADO  
COPIAGE

 M133 – M137

SPECIAL APPLICATIONS  
APLICACIONES ESPECIALES  
APPLICATIONS SPÉCIALES

 M138 – M148

OTHER INSERTS  
OTRAS PLAQUITAS  
AUTRES PLAQUETTES




 M149 – M180

TECHNICAL INFORMATION  
SECCIÓN TÉCNICA  
PARTIE TECHNIQUE

 M181 – M244



IFSB22X	M71
IS90SN	M128
ISAD11E	M75
ISAD16E	M83
ISBN10	M96
ISHN06C	M26
ISHN09C	M31
ISLN12	M107
ISOD05	M56
ISOE06Z	M36
ISOE09Z	M43
ISPD09	M65
ISPN13	M52
ISRC10	M134
ISSD09	M139
ISSE09	M48
ISSN11	M102
ISSO09	M113
ISTN10	M91
J(T)-ISAD11E	M117
J(T)-ISAD16E	M122
J(T)-ISXP16	M143

					
ADEX 07 FA	M150	RDEW	M160	SNHQ AZ	M129
ADEX 07 HF	M150	RDEX	M160	SNHQ TRL	M130
ADEX 11-FA	M79, M120	RDGT 07	M161	SOMT 09	M114
ADEX 11-HF	M78	RDGT 10	M161	SPG	M176
ADEX 16	M86, M124	RDGT 12	M162	SPKN	M177
ADEX 16-FA	M87	RDGT 12IM	M58	SPKR	M177
ADEX 16-HF	M86	RDGT 16	M162	TNGX 10	M92, M106
ADKT 15	M151	RDHT 07-FA	M163	TNGX 10-FA	M93
ADKX 15	M151	RDHT 10-FA	M163	TPKN	M178
ADMX 07	M152	RDHT 12-FA	M164	TPKR	M178
ADMX 11	M76, M118	RDHT 16-FA	M164	TPU	M179
ADMX 16	M84, M123	RDHX 07	M165	XEHT 06	M38
ANHX 10	M98	RDHX 10	M165	XEHT 09	M44
APET 16-FA	M152	RDHX 12	M166	XNGX 06	M28
APKT 10	M153	RDHX 16	M166	XNGX 09	M33
APKT 10-FA	M153	RDMT 07	M167	XPHT 16	M144
APKT 16	M154	RDMT 10	M167	XPHT 16-FA	M144
APMT 16	M155	RDMT 12	M168	ZDCW 07	M179
BNGX 10	M97	RDMT 12IM	M59	ZDCW 09	M180
HNEF 09	M156	RDMT 16	M168	ZDEW 12	M180
HNGX 06	M27	RDMX 10	M169		
HNGX 09	M32	RDMX 12	M169		
HNMF 09	M156	RDMX 16	M170		
LNGU 12	M109	REHT 16	M39		
LNGU 16	M157	REHT 24	M45		
LNGX 12	M108	RPET 12	M171		
LNGX 12-FA	M110	RPEW 12	M171		
LNMU 16	M158	SBKX 22	M72		
ODKT 05IM	M57	SBMR 22	M72		
ODMT 05IM	M57	SDEW 09	M140		
OEHT 06	M37	SDEX 09	M140		
OEHT 06-FA	M38	SDKT 12IM	M59		
OEHT 09	M44	SDMT 12	M172		
OFKR 07	M159	SDMT 12IM	M60		
PDKT 09	M67	SEEN	M173		
PDKX 09	M66	SEER	M174		
PDMW 09	M68	SEET 09	M49		
PDMX 09	M66	SEET 12-PM	M175		
PNMQ 13	M53	SEMT 09	M50		
PNMU 13	M53	SNGX 11	M103		
RCMT10	M135	SNHF	M175		
RDET	M159	SNHN	M176		

**1 ISAD11E**

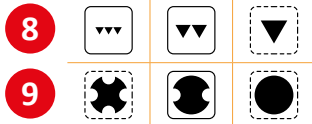
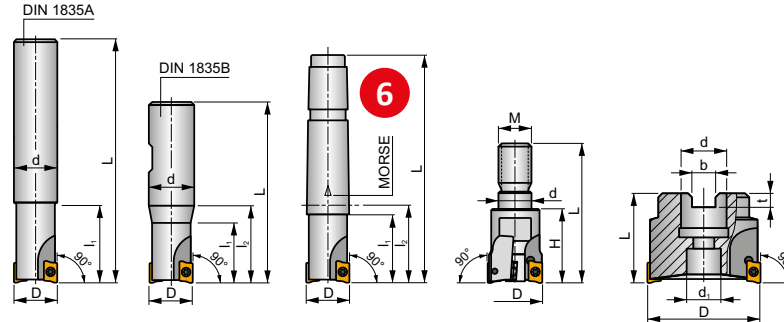
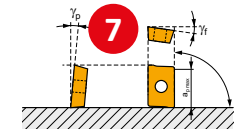
**P M K N S H 2**

**S 3**

**FORCE AD**



**5**  $\kappa_r$  90°  
 $a_{max}$  .354



ANSI	D	L	d	d <sub>1</sub>	l <sub>1</sub>	l <sub>2</sub>	H	M	b	t	$\gamma_r$	$\gamma_p$					
<b>12</b> 062A2R094C062-ISAD11E-C	.625	5.315	.625	-	.945	-	-	-	-	-	-12.8	4	<b>15</b>	30100	.44	IGI169	<b>21</b>
062A2R197C062-ISAD11E-C	.625	5.315	.625	-	1.969	-	-	-	-	-	-12.6	4	-	30100	.44	IGI169	ISOQ20
075A2R114C075-ISAD11E-C	.750	5.906	.750	-	-	-	-	-	-	-	-11.5	5	2	27000	.66	IGI169	ISOQ20
<b>13</b> 075A2R270C075-ISAD11E-C	.750	5.906	.750	-	-	-	-	-	-	-	-11.5	5	2	27000	.66	IGI169	ISOQ20
075A3R114C075-ISAD11E-C	.750	5.906	.750	-	1.142	-	-	-	-	-	-11.5	5	3	27000	.66	IGI169	ISOQ25
<b>14</b> 100A3R134C100-ISAD11E-C	1.000	6.693	1.000	-	1.339	-	-	-	-	-	-1.2	5	3	-	1.10	IGI169	ISOQ20
100A3R315C100-ISAD11E-C	1.000	6.693	1.000	-	3.150	-	-	-	-	-	-1.2	5	3	-	1.10	IGI169	ISOQ20

GI169	ADMX 11T3..	ADEX 11T3..

SQ020	US 62506-T07P	1,2	M 2,5	6	-	-	Flag T07P
SQ021	US 62506-T07P	1,2	M 2,5	6	D-T07P/T09P	FG-15	-
SQ022	US 62506-T07P	1,2	M 2,5	6	D-T07P/T09P	FG-15	HS 0830C
SQ023	US 62506-T07P	1,2	M 2,5	6	D-T07P/T09P	FG-15	HS 1030C
SQ025	US 62505-T07P	1,2	M 2,5	5	-	-	Flag T07P

Typical page with milling cutter displayed – specific page details will differ.  
 Page typique illustrant une fraise – la page finale peut varier avec des détails spécifiques.

Típica página con una fresa mostrada – los detalles específicos en cada página son diferentes.

<b>1</b>	Designation of cutter Designación de la fresa Désignation de la fraise
<b>2</b>	Material group recommendations Gupos de material Groupes de matériaux pour lesquels l'outil est indiqué
<b>3</b>	Clamping system of insert Sistema de fijación de la plaquita Système de fixation de la plaquette

<b>4</b>	Illustrative picture Esquema Ilustrativo Image pour illustration
<b>5</b>	Setting angle and maximal theoretical depth of cut [inch] Ángulo de posición y máxima profundidad de corte teórica [inch] Profondeur de coupe maximale théorique [inch]
<b>6</b>	Schematic drawing of tool Esquema de la herramienta Dessin schématique de l'outil

<b>7</b>	Tool geometry Geometría de la herramienta Géométrie de l'outil	<b>15</b>	Number of teeth Número de dientes Nombre de dents
<b>8</b>	Achievable quality of surface Calidad superficial alcanzable État de surface pouvant être atteint	<b>16</b>	Irregular teeth pitch Paso irregular Pas irrégulier
<b>9</b>	Character of cut/working conditions Condiciones de corte/trabajo Caractère de la coupe/conditions de travail	<b>17</b>	Maximum revolutions of cutter Máximas revoluciones de la fresa Tours maximum de la fraise
<b>10</b>	Maximum range of mean chip thickness [inch] for end milling cutters and/or shell milling cutters Gama máxima de espesor medio de viruta [inch] para fresas con mango y/o fresas para montaje en cono Plage d'épaisseur de copeaux maximum [inch] pour les fraises à queue et/ou à alésage	<b>18</b>	Internal supply of coolant Refrigeración interna Arrosage interne
<b>11</b>	Possible applications Posibilidades tecnológicas de la herramienta Possibilités technologiques de l'outil	<b>19</b>	Weight [lbs] Peso [lbs] Poids [lbs]
<b>12</b>	Shank type Tipo de mango Type de queue	<b>20</b>	Group of compatible inserts <sup>2)</sup> Grupo de plaquitas compatibles <sup>2)</sup> Groupe de plaquettes compatibles <sup>2)</sup>
<b>13</b>	ANSI code of cutter Codificación ANSI para fresas Code ANSI de la fraise	<b>21</b>	Group of spare parts <sup>2)</sup> Grupo de repuestos <sup>2)</sup> Groupe de pièces de rechange <sup>2)</sup>
<b>14</b>	Dimensions [inch], angles <sup>1)</sup> [°] and type of tool clamping Dimensiones [inch], ángulos <sup>1)</sup> [°] y tipo de montaje de la herramienta Dimensions [inch], angles <sup>1)</sup> [°] et système de fixation de la fraise	<b>22</b>	Compatible inserts Plaquitas compatibles Plaquettes compatibles
		<b>23</b>	Spare parts Repuestos Pièces de rechange

<sup>1)</sup>  $\gamma_f$  = radial rake angle (see technical section)

$\gamma_p$  = axial rake angle (see technical section)

<sup>2)</sup> Spare parts and special accessories icons are designed schematically for their ease of understanding. They aren't included in the list of icons. Screws are, in some cases, completed with info on torque value in Nm, length of screw and size of thread.

<sup>1)</sup>  $\gamma_f$  = angle de coupe radial (voir partie technique)

$\gamma_p$  = angle de coupe axial (voir partie technique)

<sup>2)</sup> Les icônes des pièces de rechange et des accessoires spéciaux sont schématisées pour une compréhension simple. Elles ne sont pas incluses dans la liste des icônes. Les vis, dans certains cas, sont complétées avec l'information du couple de serrage Nm, de la longueur de vis et du diamètre du filetage.

<sup>1)</sup>  $\gamma_f$  = ángulo de desprendimiento radial (ver sección técnica)

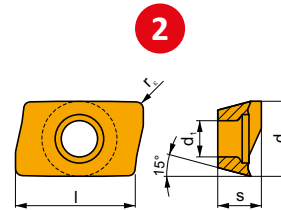
$\gamma_p$  = ángulo de desprendimiento axial (ver sección técnica)

<sup>2)</sup> Los iconos de los repuestos y accesorios especiales están diseñados esquemáticamente para su fácil comprensión. No están incluidos en la lista de iconos. En algunos casos, la información de los tornillos se completa con el par de apriete en Nm, longitud y tamaño de rosca.

**1**

**ADMX 11**

	d	d <sub>1</sub>	l	s
11T3	.257	.315	.433	.156



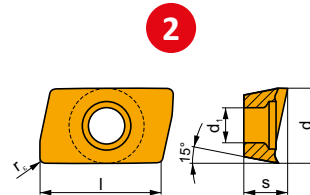
**4** **5** **6** **7** **8** **9** **10** **11** **12**

ANSI		P	M	K	N	S	H			r <sub>c</sub>	f <sub>min</sub>	f <sub>max</sub>	a <sub>p min</sub>	a <sub>p max</sub>
ADMX 11T304SR-F	M9340	█	█	█	█	█	█	●	---	.016	.003	.004	.008	.354
	M8310	█	█	█	█	█	█	●	-	.016	.003	.005	.008	.354
	M8340	█	█	█	█	█	█	●	+/-	.016	.003	.005	.008	.354
ADMX 11T308SR-F	M9340	█	█	█	█	█	█	●	---	.031	.003	.004	.008	.354
	M8340	█	█	█	█	█	█	●	+/-	.031	.003	.005	.008	.354
	8215	█	█	█	█	█	█	●	-	.031	.003	.005	.008	.354
	8230	█	█	█	█	█	█	●	-	.031	.003	.005	.008	.354

**1**

**ADEX 11-FA**

	d	d <sub>1</sub>	l	s
11T3	.254	.315	.382	.154



**4** **5** **6** **7** **8** **9** **10** **11** **12**

ANSI		P	M	K	N	S	H			r <sub>c</sub>	f <sub>min</sub>	f <sub>max</sub>	a <sub>p min</sub>	a <sub>p max</sub>
ADEX 11T304FR-FA	M0315	█	█	█	█	█	█	●	++	.016	.001	.012	.016	.354
	HF7	█	█	█	█	█	█	●	+/-	.016	.001	.012	.008	.354
ADEX 11T308FR-FA	M0315	█	█	█	█	█	█	●	---	.031	.001	.012	.008	.354
ADEX 11T312FR-FA	M0315	█	█	█	█	█	█	●	---	.031	.001	.012	.008	.354
ADEX 11T316FR-FA	HF7	█	█	█	█	█	█	●	+/-	.047	.001	.012	.008	.354
	HF7	█	█	█	█	█	█	●	+/-	.063	.001	.012	.008	.354

ISO	f <sub>min</sub>	f <sub>max</sub>	M0315	M0315	M0325	M0340	M0315	M0330	M0310	M0340	M0345	8215	8230	HF7	
P	●	.0028	.0071	1280	1247	1198	1033	-	935	1066	951	689	1033	935	-
	●	.0028	.0059	1181	1148	1083	919	-	837	968	837	591	886	820	-
	✘	.0028	.0039	1083	1033	951	820	-	738	869	722	492	755	705	-
M	●	.0028	.0071	-	-	722	607	-	607	640	574	410	607	558	-
	●	.0028	.0059	-	-	640	558	-	541	574	492	344	525	492	-
	✘	.0028	.0039	-	-	574	476	-	459	509	427	295	443	427	-
K	●	.0028	.0071	1214	1181	-	-	-	-	1017	886	-	968	886	-
	●	.0028	.0059	1132	1083	-	-	-	-	919	787	-	853	771	-
	✘	.0028	.0039	1033	984	-	-	-	-	820	689	-	722	673	-
N	●	.0028	.0071	-	-	-	-	2231	-	-	-	-	2592	2362	1001
	●	.0028	.0059	-	-	-	-	2001	-	-	-	-	2247	2083	886
	✘	.0028	.0039	-	-	-	-	1755	-	-	-	-	1919	1788	771
S	●	.0028	.0071	-	-	344	295	-	295	312	279	197	295	279	-
	●	.0028	.0059	-	-	312	279	-	262	279	246	164	262	246	-
	✘	.0028	.0039	-	-	279	230	-	230	246	197	148	213	197	-
H	●	.0028	.0071	246	246	-	-	-	-	197	-	-	197	164	-
	●	.0028	.0059	230	213	-	-	-	-	180	-	-	164	148	-
	✘	.0028	.0039	197	197	-	-	-	-	148	-	-	148	131	-



Typical page with milling inserts displayed – specific page details will differ. Most of inserts can be found in this catalogue just immediately after the relevant milling cutter or, alternatively, in the separate inserts chapter.

La mayoría de plaquitas de este catálogo se pueden encontrar en la página contigua a la de la fresa correspondiente. Existe un capítulo separado que incluye sólo plaquitas, sin información de la fresa.

Page typique illustrant les plaquettes de fraisage – la page finale peut contenir des détails spécifiques. La plupart des plaquettes peuvent être trouvées dans ce catalogue immédiatement après la fraise correspondante. Les chapitres sur les plaquettes séparées incluent seulement les plaquettes sans fraise compatible dans notre offre.

1	Designation of insert Designación Désignation de la plaquette	8	Application area of insert Área de aplicación Domaine d'application de la plaquette
2	Schematic drawing of insert Esquema de la plaquita Dessin schématique de la plaquette	9	Suitability of insert use with respect to specific working conditions Uso de plaquitas en función de las condiciones de trabajo Possibilité d'utilisation de la plaquette en fonction des conditions de travail spécifiques
3	Table with insert sizes [in] Tabla con tamaños de plaquita [in] Tableau des tailles de plaquettes [in]	10	Influence of use of cutting fluids in continual cut Influencia del uso de fluidos de corte en corte continuo Influence de l'usage du fluide en coupe continue
4	Icons – specific features, cutting edge type and picture of representative insert Iconos – características específicas, tipo de filo de corte y foto representativa de la plaquita Icônes – caractéristiques spécifiques, type d'arête de coupe et photo d'une plaquette représentative	11	Insert radii [in] Radio de plaquita [in] Rayon de plaquette [in]
5	Profile of main cutting edge Perfil del filo de corte Profil de l'arête de coupe principale	12	Maximum range of feed [mm/tooth] and cutting depth [in] Gama máxima de avance [mm/diente] y profundidad de corte [in] Plage de avances [mm/dent] et profondeurs de passe [in]
6	ANSI code of insert Codificación ANSI de plaquitas Code ANSI de la plaquette	13	Table of starting cutting speeds for grades, which the insert is available in <sup>1)</sup> Tabla de velocidades de corte iniciales para calidades, plaquitas disponibles <sup>1)</sup> Tableau des vitesses de coupe de départ des nuances pour lesquelles la plaquette est disponible <sup>1)</sup>
7	Grade Calidad Nuance		

<sup>1)</sup> Recommendations for cutting speed corrections can be found at the end of Milling chapter in the technical section.

<sup>1)</sup> Les recommandations pour les corrections de la vitesse de coupe se trouvent à la fin du chapitre Fraisage dans la partie technique.

<sup>1)</sup> Las recomendaciones de corrección para la velocidad de corte se pueden encontrar al final del capítulo de fresado en la sección técnica.




Technical information follows immediately after the milling cutter pages, their compatible inserts and info on starting cutting speeds. These will help you to use the tools in the correct way. If you are unsure how to use or interpret this information, either refer to the technical section at the end of the milling chapter or contact your Dormer Pramet representative.




Las informaciones técnicas están disponibles después de las páginas de fresas y sus plaquitas compatibles, así como información con velocidades de corte iniciales. Deben servir de guía para utilizar las herramientas de forma correcta. Si no se tiene la seguridad de haber comprendido o interpretado bien las informaciones técnicas, se recomienda estudiar la sección técnica disponible al final del capítulo de fresado o contactar con representantes de nuestra compañía.



Les informations techniques se trouvent juste après les pages des fraises, des plaquettes compatibles et des conditions de coupe de départ. Elles vous aideront à utiliser les outils correctement. Si vous n'êtes pas certain de la compréhension ou de l'interprétation des informations techniques, étudiez la partie technique à la fin du chapitre Fraisage ou contactez les représentants de notre société.

 Priority use  
 Uso prioritario  
 Utilisation prioritaire








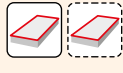
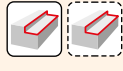
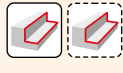
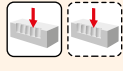



 Possible use  
 Uso posible  
 Utilisation possible

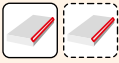
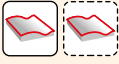

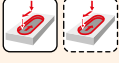
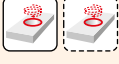


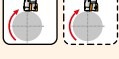
Icon absence – tool is not recommended for specific operation or group of materials or it does not have specific feature.

Ausencia de icono – la herramienta no se recomienda para la operación específica, grupo de materiales o no tiene ninguna característica específica

Absence d'icône – outil non recommandé pour l'opération spécifique ou pour le groupe de matériaux ou parce qu'il ne possède pas de caractéristiques spécifiques

Icons – milling cutters / Iconos – fresas / Icônes – Porte-outils

General features of tools / Características generales de las herramientas / Icônes – Porte – outils			
	Material groups	Grupos de materiales	Groupe de matériaux
	Finishing – very good surface quality	Acabado – calidad superficial muy buena	Finition – très bonne qualité de surface
	Medium machining – good surface quality	Mecanizado medio – calidad superficial buena	Usinage moyen – bonne qualité de surface
	Roughing – unlimited surface roughness	Desbaste – rugosidad superficial ilimitada	Ébauche – Rugosité de surface non limitée
	Stable working conditions	Condiciones estables	Conditions de travail stables
	Unstable working conditions	Condiciones inestables	Conditions de travail instables
	Very unstable working conditions	Condiciones muy inestables	Conditions de travail très instables
Possible applications / Posibilidades tecnológicas de la herramienta / Possibilités technologiques des outils			
	Face milling	Planeado	Surfaçage
	Shallow shoulder milling	Escuadrado	Fraisage de petits épaulements
	Deep shoulder milling	Escuadrado profundo	Fraisage de grands épaulements
	Plunge milling	Fresado axial (plunging)	Tréflage
	Shallow slot milling	Ranurado	Fraisage de rainures peu profondes
	Deep slot milling	Ranurado profundo	Fraisage de rainures profondes
	T slot milling	Ranurado en T	Fraisage de rainures en T











	Chamfer milling	Achaflanado	Fraisage de chanfreins
	Shape surfaces milling (copy milling)	Copiado	Fraisage de formes (copiage)
	Ramping	Fresado en rampa	Fraisage en pente
	Progressive plunging	Fresado progresivo	Tréflage progressif
	Helical interpolation	Interpolación helicoidal	Fraisage en interpolation hélicoïdale
	Drilling	Taladrado	Perçage
	Rear face milling	Fresado trasero	Fraisage par dessous
	Turn-milling	Torno-fresado	Tournage – fraisage

**Shank type / Tipo de mango / Type de queue**

 DIN 1835B	End mill cutter with WELDON shank	Fresa con mango Weldon	Queue WELDON
 DIN 1835A	End mill cutter with cylindrical shank	Fresa con mango cilíndrico	Queue cylindrique
 DIN 228A	MORSE shank	Cono MORSE	Cône morse
 DIN 1835E	WHISTLE NOTCH shank	Mango WHISTLE NOTCH	Queue WISTLE NOTCH
 MODULAR	Modular clamping system	Sistema modular	Système de fixation modulaire
 ISO 297	ISO 297 shank	Mango cono ISO 297	Cône ISO 297
 ISO/DIS 7388-1	ISO/DIS 7388-1 shank	Mango cono ISO/DIS 7388-1	Cône ISO/DIS 7388-1
 CAPTO	CAPTO shank	CAPTO	Cône CAPTO
 HSK	HSK shank	HSK	Cône HSK
 JIS B 6339	JIS B 6339 shank	Mango cono JIS B 6339	Cône JIS B 6339

	Standard shell cutter	Montaje portafresas estándar	Alésage standard
	Disc mill cutter	Fresa de disco	Fraise disque
	Helical milling cutter	Fresa de filo largo (helicoidal)	Fraise hérisson
<b>Others / Otros / Autres</b>			
	Number of teeth (helical cutters)	Número de dientes (fresas de filo largo)	Nombre de dents (fraises hérisson)
	Taper size [in]	Tamaño de cono [in]	Taille de cône [in]
	Effective number of teeth	Número de dientes efectivos	Nombre de dents effectif
	Clamping torque of screw [Nm]	Par de apriete del tornillo [Nm]	Couple de serrage de la vis [Nm]

Icons and symbols – inserts / Iconos y símbolos – plaquitas / Icônes et symboles - plaquettes

<b>Features / Características / Caractéristiques</b>			
	First choice	Primera elección	Premier choix
	Universal wide range option	Gama completa universal	Large gamme de solutions universelles
	Thin-walled and slim workpieces	Piezas delgadas y de paredes delgadas	Parois fines et pièces minces
	Heavy working conditions	Condiciones de trabajo pesadas	Conditions de travail très difficiles
	Large overhang	Gran voladizo	Long porte-à-faux
	Large overhang (turning inserts)	Gran voladizo (plaquitas de torneado)	Long porte-à-faux (opération de tournage – fraisage)
	High Feed Cutting	Alto avance	Usinage grande avance
	High Speed Cutting	Alta velocidad	Usinage grande vitesse
	Insert with Wiper geometry	Plaquita con geometría rascadora (Wiper)	Plaquette avec géométrie Wiper
	For short chipping materials	Para materiales de viruta corta	Pour matériaux à copeaux courts

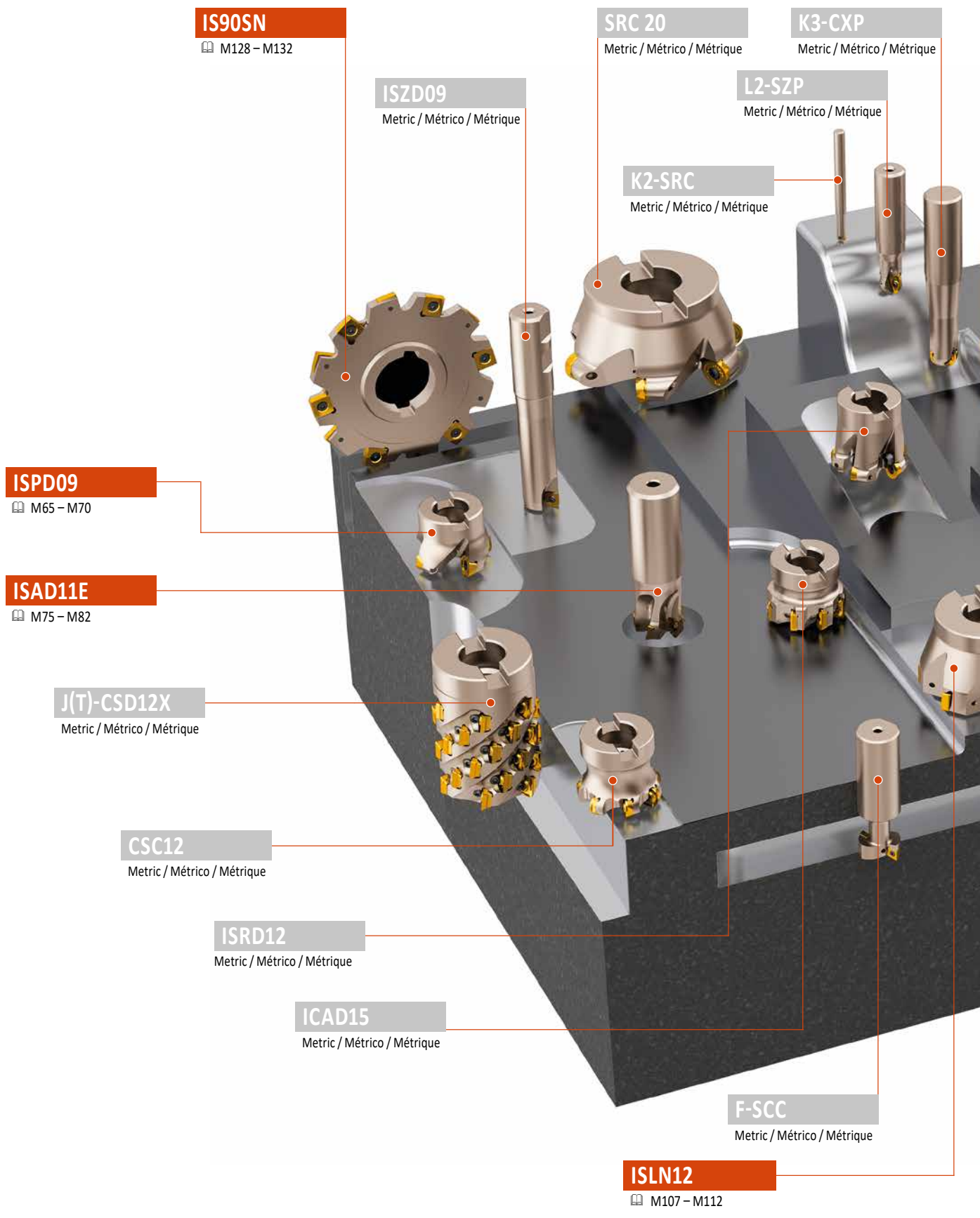
	For tough materials (long chipping)	Para materiales difíciles (viruta larga)	Pour matériaux tenaces (copeaux longs)
	Sharp edge	Filo vivo	Arête vive
	Rounded edge	Filo redondeado	Arête arrondie
	Edge with facet	Filo con faceta	Arête avec listel
	Rounded edge with facet	Filo redondeado con faceta	Arête arrondie avec listel
	Edge with double facet	Filo con doble faceta	Arête avec double listel
	Rounded edge with double facet	Filo redondeado con doble faceta	Arête arrondie avec double listel
<b>Conditions of use / Condiciones de uso / Conditions d'utilisation</b>			
	Main application	Aplicación principal	Appllication principale
	Secondary application	Aplicación secundaria	Application secondaire
	Supplementary application	Aplicación suplementaria	Application supplémentaire
	Stable working conditions	Condiciones estables	Conditions de travail stables
	Unstable working conditions	Condiciones inestables	Conditions de travail instables
	Very unstable working conditions	Condiciones muy inestables	Conditions de travail très instables
---	Very negative effect on tool life – cooling is not recommended	Efecto muy negativo en la vida de filo – no se recomienda refrigerante	Effet très négatif sur la durée de vie de l'outil – l'arrosage n'est pas recommandé
--	Negative effect on tool life – cooling is not recommended	Efecto negativo en la vida de filo – no se recomienda refrigerante	Effet négatif sur la durée de vie de l'outil – l'arrosage n'est pas recommandé
-	Slightly negative effect on tool life	Efecto ligeramente negativo en la vida de filo	Effet légèrement négatif sur la durée de vie de l'outil
+/-	Influence of cooling may be both positive and negative – decisive factor is specific working conditions	La influencia del refrigerante puede ser positiva o negativa – depende de las condiciones de trabajo	L'influence de l'arrosage peut être positive ou négative – le facteur décisif est les conditions spécifiques de travail
+	Slightly positive effect on tool life	Efecto ligeramente positivo en la vida de filo	Effet légèrement positif sur la durée de vie de l'outil

++	Positive effect on tool life – cooling is recommended	Efecto positivo en la vida de filo – se recomienda refrigerante	Effet positif sur la durée de vie de l'outil – l'arrosage est recommandé
+++	Very positive effect on tool life – cooling is recommended	Efecto muy positivo en la vida de filo – se recomienda refrigerante	Effet très positif sur la durée de vie de l'outil – l'arrosage est recommandé

Icons – technical pages / Iconos – sección técnica / Icônes – partie technique

	Multiplication factor for cutting speed	Factor de multiplicación para la velocidad de corte	Coefficient multiplicateur pour la vitesse de coupe
	Multiplication factor for feed	Factor de multiplicación para el avance	Coefficient multiplicateur pour l'avance
	Multiplication factor for feed (machining on center line)	Factor de multiplicación para el avance (mecanizado con la fresa centrada)	Coefficient multiplicateur pour l'avance (usinage avec fraise centrée)
	Multiplication factor for feed (machining off center line)	Factor de multiplicación para el avance (mecanizado con la fresa descentrada)	Coefficient multiplicateur pour l'avance (usinage avec fraise non centrée)
	Radius of insert [in]	Radio de plaquita [in]	Rayon de plaquette [in]
	Size of smoothing segment [in]	Tamaño de faceta [in]	Longueur du plat de planage [in]
	Approach angle [°]	Ángulo de posición [°]	Angle d'attaque [°]
	Depth of cut [in]	Profundidad de corte [in]	Profondeur de coupe [in]
	Feed [mm/tooth]	Avance [mm/diente]	Avance [mm/dent]
	Starting feed [mm/tooth]	Avance inicial [mm/diente]	Avance de départ [mm/dent]
	Diameter of cutter [in]	Diámetro de la fresa [in]	Diamètre de coupe [in]
	Effective diameter of cutter [in]	Diámetro efectivo de la fresa [in]	Diamètre effectif de coupe [in]
	Maximal angle for ramping [°]	Máximo ángulo de rampa [°]	Angle maximum de ramping [°]
	Maximum cutting depth in direction of cutting [in]	Máxima profundidad en la dirección del corte [in]	Profondeur de coupe maximum en fraisage en pente [in]
	Waviness of machined surface [μm]	Ondulación de la superficie [μm]	Rugosité de la surface usinée [μm]
	Step of conventional milling [in]	Paso para fresado convencional [in]	Pas en fraisage conventionnel [in]

	Step of cross milling [inch]	Paso para fresado cruzado [inch]	Pas en fraisage transversal ou tréflage [inch]
	$s_{max}$ for $d_{min}$ [in]	$s_{max}$ para $d_{min}$ [in]	$s_{max}$ pour $d_{min}$ [in]
	$s_{max}$ for $d_{max}$ [in]	$s_{max}$ para $d_{max}$ [in]	$s_{max}$ pour $d_{max}$ [in]
	Number of edges in use	Número de filos en uso	Nombre d'arêtes à utiliser
	Effective working length of tool [in]	Longitud de trabajo de la herramienta [in]	Longueur de travail de l'outil [in]
	Effective reach of tool [in]	Ancho de trabajo de la herramienta [in]	Largeur de travail de l'outil [in]
	Maximal width of machined area [in]	Ancho máximo de la superficie mecanizada [in]	Largeur maximum de la surface usinée [in]
	Durability [min]	Durabilidad [min]	Durabilité [min]
	Grade	Calidad	Nuance
	Coating	Recubrimiento	Revêtement
	Cutting speed	Velocidad de corte	Vitesse de coupe
	Cutting edge profile	Perfil del filo de corte	Profil de l'arête de coupe
	Cooling	Refrigerante	Arrosage
	Very high cutting speed, excellent system rigidity (stable working conditions)	Velocidad de corte muy alta, excelente rigidez del sistema (condiciones estables)	Vitesse de coupe très élevée, excellente rigidité du système (conditions de travail stables)
	High cutting speed, high system rigidity (stable working conditions)	Velocidad de corte alta, alta rigidez del sistema (condiciones estables)	Vitesse de coupe élevée, bonne rigidité du système (conditions de travail stables)
	High cutting speed, system rigidity slightly limited (depth of cut changing)	Velocidad de corte alta, rigidez del sistema ligeramente limitada (profundidad de corte variable)	Vitesse de coupe élevée, rigidité du système légèrement limité (variation de la profondeur de coupe)
	Medium cutting speed, system rigidity limited (slightly interrupted cut)	Velocidad de corte media, rigidez del sistema limitada (corte ligeramente interrumpido)	Vitesse de coupe moyenne, rigidité du système limitée (coupe légèrement interrompue)
	Low cutting speed, low system rigidity (interrupted cut)	Velocidad de corte baja, rigidez del sistema baja (corte interrumpido)	Vitesse de coupe faible, mauvaise rigidité du système (coupe interrompue)
	Very low cutting speed, very low system rigidity (very unstable working conditions)	Velocidad de corte muy baja, rigidez del sistema muy baja (condiciones muy inestables)	Vitesse de coupe faible, mauvaise rigidité du système (coupe interrompue)



**IS90SN**  
M128 – M132

**ISZD09**  
Metric / Métrico / Métrique

**SRC 20**  
Metric / Métrico / Métrique

**K3-CXP**  
Metric / Métrico / Métrique

**L2-SZP**  
Metric / Métrico / Métrique

**K2-SRC**  
Metric / Métrico / Métrique

**ISPD09**  
M65 – M70

**ISAD11E**  
M75 – M82

**J(T)-CSD12X**  
Metric / Métrico / Métrique

**CSC12**  
Metric / Métrico / Métrique

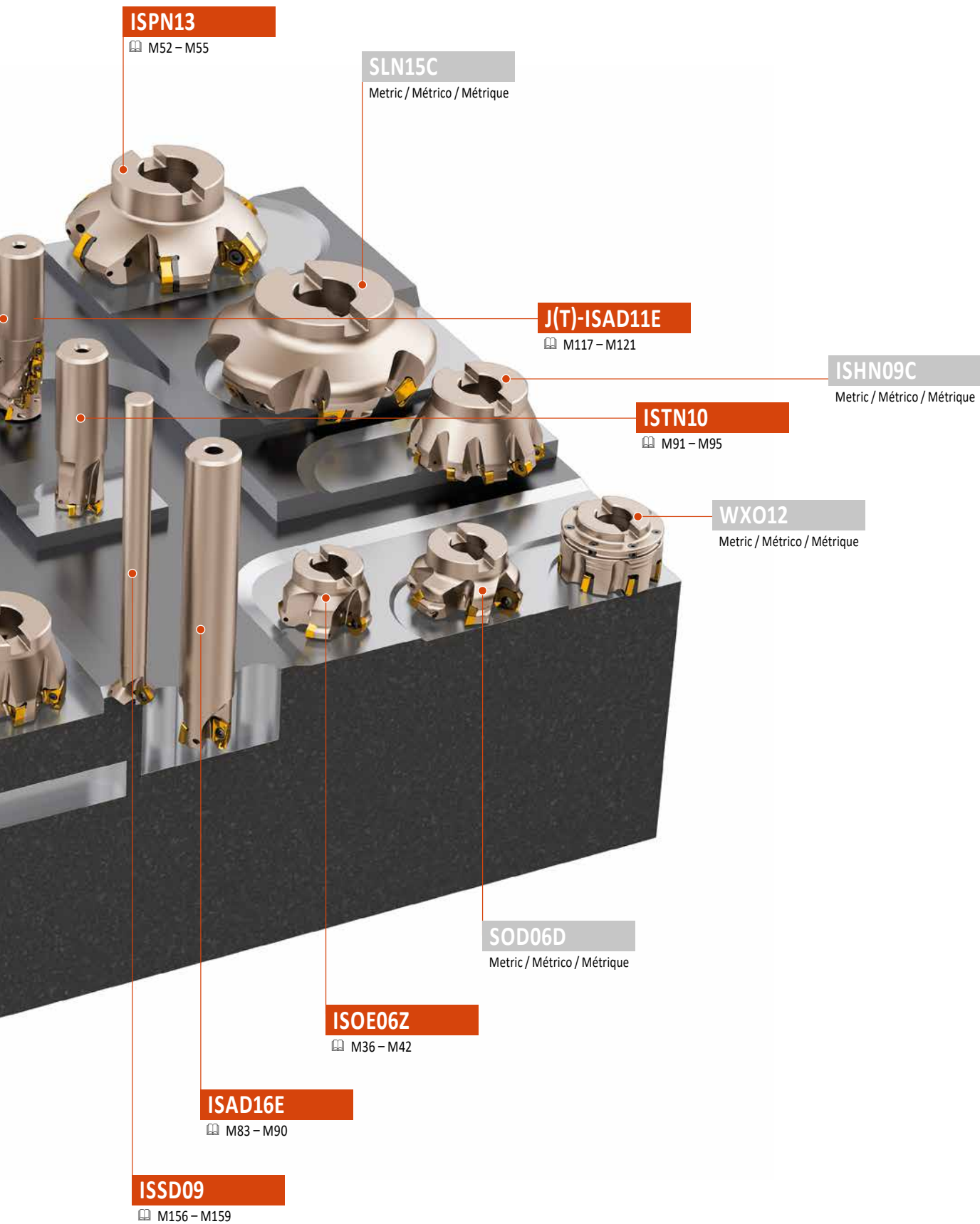
**ISRD12**  
Metric / Métrico / Métrique

**ICAD15**  
Metric / Métrico / Métrique

**F-SCC**  
Metric / Métrico / Métrique

**ISLN12**  
M107 – M112





**ISPN13**

M52 – M55

**SLN15C**

Metric / Métrico / Métrique

**J(T)-ISAD11E**

M117 – M121

**ISHN09C**

Metric / Métrico / Métrique

**ISTN10**

M91 – M95

**WX012**

Metric / Métrico / Métrique

**SOD06D**

Metric / Métrico / Métrique

**ISOE06Z**

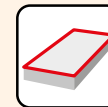
M36 – M42

**ISAD16E**

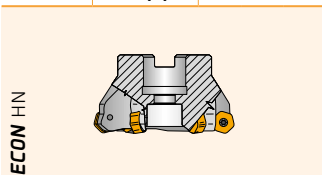
M83 – M90

**ISSD09**

M156 – M159

MILLING FLAT SURFACES  
 PLANEADO  
 FRAISAGE DE SURFACES PLANES

**ISHN06C**

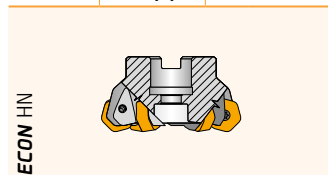
45°	$a_{p\max}$ [in]	.118
	$\phi D$ [in]	1.000 – 5.000



	HN 0604	P	M	K
	XN 0604	N		H
M26 – M30				

**ISHN09C**

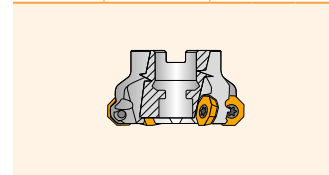
45°	$a_{p\max}$ [in]	.197
	$\phi D$ [in]	2.000-12.000



	HN.. 0906	P	M	K
	XN.. 0906	N		H
M31 – M35				

**ISOE06Z**

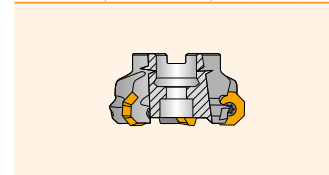
43°	$a_{p\max}$ [in]	.130 (.390)
	$\phi D$ [in]	2.000 – 8.000



	OE 0604	P	M	
	REHT 16	N	S	
XEHT 06 M36 – M42				

**ISOE09Z**

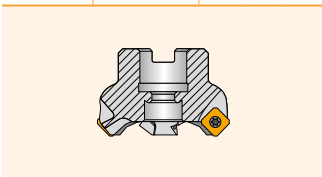
43°	$a_{p\max}$ [in]	.197 (.555)
	$\phi D$ [in]	3.000 – 12.000



	OE 0906	P	M	
	REHT 24	N	S	
XEHT 09 M43 – M47				

**ISSE09**

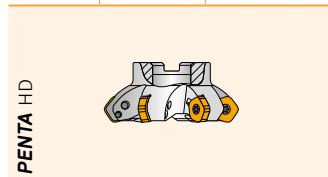
45°	$a_{p\max}$ [in]	.177
	$\phi D$ [in]	.750 – 6.000



	SE 09T3	P	M	K
		N	S	
M48 – M51				

**ISPN13**

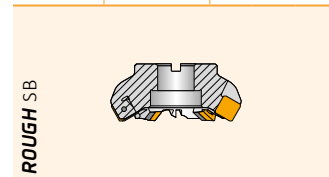
57°	$a_{p\max}$ [in]	.394
	$\phi D$ [in]	4.000 – 12.000



	PN 1308	P	M	K
		S	H	
M52 – M55				

**IFSB22X**

60°	$a_{p\max}$ [in]	.591
	$\phi D$ [in]	5.000 – 12.000



	SB 2207	P	M	K
M71 – M73				

**ISRC10**

-	$a_{p\max}$ [in]	.097
	$\phi D$ [in]	1.000 – 1.500



	RC.. 10T3	P	M	K
		N	S	H
M134 – M137				

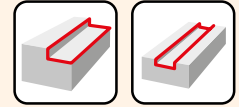
MILLING FLAT SURFACES  
 PLANEADO  
 FRAISAGE DE SURFACES PLANES


ISPD09								
<b>19°</b>	$a_{p\ max}$ [in]	.079						
	$\phi D$ [in]	1.250 – 4.000						
PENTA HF 								
	PD 0905	<table border="1"> <tr> <td>P</td> <td>M</td> <td>K</td> </tr> <tr> <td>N</td> <td>S</td> <td>H</td> </tr> </table>	P	M	K	N	S	H
P	M	K						
N	S	H						
		<table border="1"> <tr> <td colspan="3">M65 – M70</td> </tr> </table>	M65 – M70					
M65 – M70								

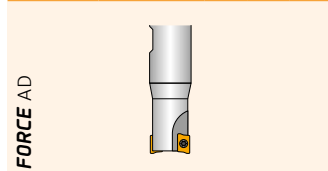
ISBN10								
<b>20°</b>	$a_{p\ max}$ [in]	.039						
	$\phi D$ [in]	.0625 – 1.500						
	BN.. 10T3	<table border="1"> <tr> <td>P</td> <td>M</td> <td>K</td> </tr> <tr> <td></td> <td>S</td> <td>H</td> </tr> </table>	P	M	K		S	H
P	M	K						
	S	H						
	AN.. 10T3	<table border="1"> <tr> <td colspan="3">M96 – M101</td> </tr> </table>	M96 – M101					
M96 – M101								

ISOD05								
<b>45°</b>	$a_{p\ max}$ [in]	.118 (.394)						
	$\phi D$ [in]	1.250 – 5.000						
	OD.. 0505	<table border="1"> <tr> <td>P</td> <td>M</td> <td>K</td> </tr> <tr> <td>N</td> <td>S</td> <td></td> </tr> </table>	P	M	K	N	S	
P	M	K						
N	S							
	RD..1205	<table border="1"> <tr> <td colspan="3">M56 – M64</td> </tr> </table>	M56 – M64					
M56 – M64								
	SD..1205							

ISSN11								
<b>18°</b>	$a_{p\ max}$ [in]	.067						
	$\phi D$ [in]	1.500 – 4.000						
	SN 1104..	<table border="1"> <tr> <td>P</td> <td>M</td> <td>K</td> </tr> <tr> <td></td> <td>S</td> <td>H</td> </tr> </table>	P	M	K		S	H
P	M	K						
	S	H						
		<table border="1"> <tr> <td colspan="3">M102 – M106</td> </tr> </table>	M102 – M106					
M102 – M106								

**MILLING SHALLOW SHOULDERS AND SLOTS**  
**ESCUADRADO Y RANURADO**  
**FRAISAGE DE PETITS ÉPAULEMENTS ET DE RAINURES**

**ISAD11E**

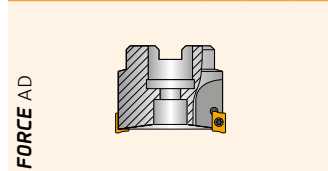
90°	$a_{p\max}$ [in]	.354
	$\phi D$ [in]	.625 – 5.000



	AD 11T3	P	M	K
		N	S	H
M75 – M82				

**ISAD16E**

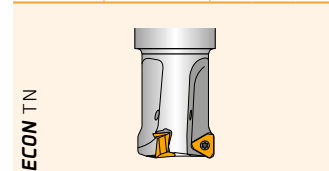
90°	$a_{p\max}$ [in]	.512
	$\phi D$ [in]	1.000 – 6.000



	AD 1606	P	M	K
		N	S	H
M83 – M90				

**ISTN10**

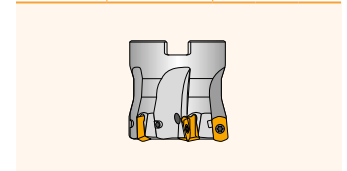
90°	$a_{p\max}$ [in]	.197
	$\phi D$ [in]	.750 – 3.000



	TN 1004	P	M	K
		N	S	
M91 – M95				

**ISBN10**

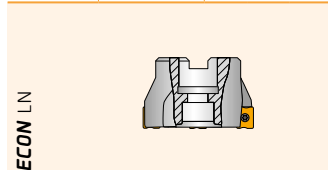
20°	$a_{p\max}$ [in]	.039
	$\phi D$ [in]	.0625 – 1.500



	BN.. 10T3	P	M	K
	AN.. 10T3		S	H
M96 – M101				

**ISLN12**

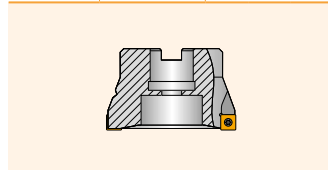
90°	$a_{p\max}$ [in]	.354
	$\phi D$ [in]	1.000 – 5.000



	LN 1205	P	M	K
		N	S	H
M107 – M112				

**ISSO09**

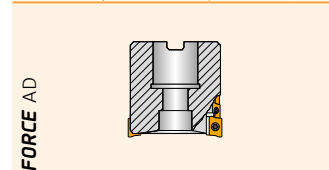
90°	$a_{p\max}$ [in]	.315
	$\phi D$ [in]	1.000 – 5.000



	SO 09T3	P	M	K
		N	S	
M113 – M115				

**J(T)-ISAD11E**

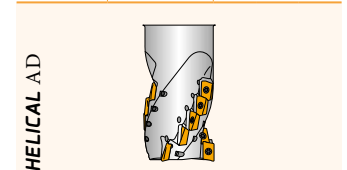
90°	$a_{p\max}$ [in]	1.456–2.205
	$\phi D$ [in]	1.000 – 2.000



	AD 11T3	P	M	K
M117 – M121				

**J(T)-ISAD16E**

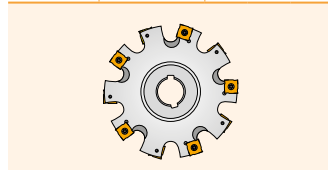
90°	$a_{p\max}$ [in]	2.126 – 4.252
	$\phi D$ [in]	2.000 – 4.000



	AD.. 1606	P	M	K
M122 – M126				

**IS90SN**

90°	$a_{p\max}$ [in]	.156 – .375
	$\phi D$ [in]	3.000 – 6.000

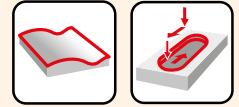


	SN 11	P	M	K
	SN 12	N	S	H
M128 – M132				

**MILLING SHAPED SURFACES (COPY MILLING)**

COPIADO

FRAISAGES DE FORMES (COPIAGE)

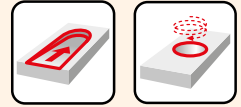


ISBN10		
<b>20°</b>	$a_{p\max}$ [in]	.039
	$\phi D$ [in]	.0625 – 1.500
	BN.. 10T3	<b>P</b> <b>M</b> <b>K</b>
	AN.. 10T3	<b>S</b> <b>H</b>
M96 – M101		

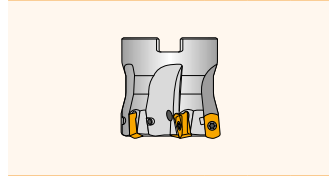
ISRC10		
-	$a_{p\max}$ [in]	.097
	$\phi D$ [in]	1.000 – 1.500
	RC.. 10T3	<b>P</b> <b>M</b> <b>K</b>
		<b>N</b> <b>S</b> <b>H</b>
M134 – M137		

ISPD09		
<b>19°</b>	$a_{p\max}$ [in]	.079
	$\phi D$ [in]	1.250 – 4.000
PENTA HF		
		PD 0905
		<b>N</b> <b>S</b> <b>H</b>
M65 – M70		

ISSN11		
<b>18°</b>	$a_{p\max}$ [in]	.067
	$\phi D$ [in]	1.500 – 4.000
	SN 1104..	<b>P</b> <b>M</b> <b>K</b>
		<b>S</b> <b>H</b>
M102 – M106		

**RAMPING AND HELICAL INTERPOLATION**  
**INTERPOLACIÓN HELICOIDAL Y RAMPA**  
**FRAISAGE EN PENTE (RAMPING) ET INTERPOLATION HELICOÏDALE**

**ISBN10**

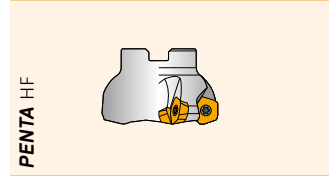
20°	$a_{p\max}$ [in]	.039
	$\phi D$ [in]	.0625 – 1.500



	BN.. 10T3	P	M	K
	AN.. 10T3		S	H
		M96 – M101		

**ISPD09**

19°	$a_{p\max}$ [in]	.079
	$\phi D$ [in]	1.250 – 4.000



	PD 0905	P	M	K
		N	S	H
		M65 – M70		

**ISRC10**

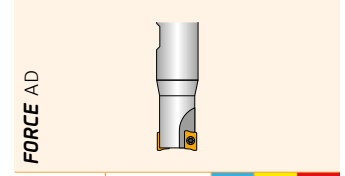
-	$a_{p\max}$ [in]	.097
	$\phi D$ [in]	1.000 – 1.500



	RC.. 10T3	P	M	K
		N	S	H
		M134 – M137		

**ISAD11E**

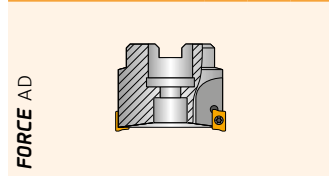
90°	$a_{p\max}$ [in]	.354
	$\phi D$ [in]	.625 – 5.000



	AD 11T3	P	M	K
		N	S	H
		M75 – M82		

**ISAD16E**

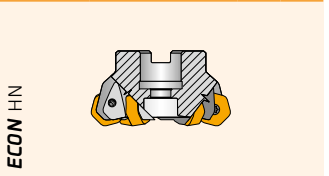
90°	$a_{p\max}$ [in]	.512
	$\phi D$ [in]	1.000 – 6.000



	AD 1606	P	M	K
		N	S	H
		M83 – M90		

**ISHN09**

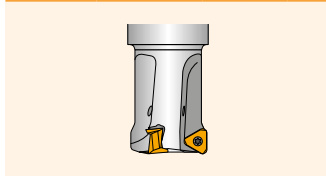
45°	$a_{p\max}$ [in]	.197
	$\phi D$ [in]	2.000 – 12.000



	HN 0906	P	M	K
	XN 0906	N		H
		M31 – M35		

**ISTN10**

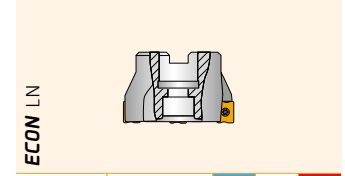
90°	$a_{p\max}$ [in]	.197
	$\phi D$ [in]	.750 – 3.000



	TN 1004	P	M	K
		N	S	
		M91 – M95		

**ISLN12**

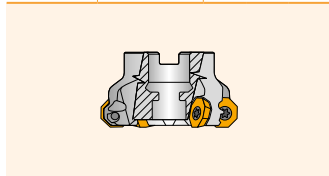
90°	$a_{p\max}$ [in]	.354
	$\phi D$ [in]	1.000 – 5.000



	LN 1205	P	M	K
		N	S	H
		M107 – M112		

**ISOE06Z**

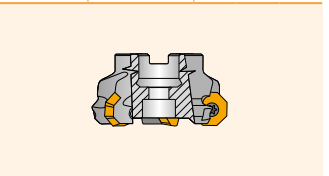
43°	$a_{p\max}$ [in]	.130 (.390)
	$\phi D$ [in]	2.000 – 8.000



	OE 0604	P	M	
	REHT 16	N	S	
	XEHT 06	M36 – M42		

**ISOE09Z**

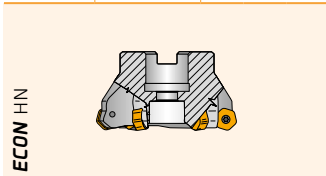
43°	$a_{p\max}$ [in]	.197 (.555)
	$\phi D$ [in]	3.000 – 12.000



	OE 0906	P	M	
	REHT 24	N	S	
	XEHT 09	M43 – M47		

**ISHN06C**

45°	$a_{p\max}$ [in]	.118
	$\phi D$ [in]	1.000 – 5.000



	HN 0604	P	M	K
	XN 0604	N		H
		M26 – M30		

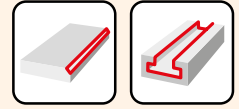
**ISSN11**

18°	$a_{p\max}$ [in]	.067
	$\phi D$ [in]	1.500 – 4.000



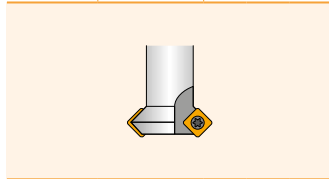
	SN 1104..	P	M	K
			S	H
		M102 – M106		

CHAMFER MILLING AND T-SLOTS  
ACHAFLANADO Y RANURAS EN T  
FRAISAGE DE CHANFREINS ET DE RAINURES EN T



**ISSD09**

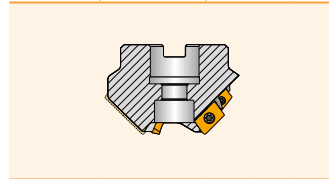
<b>45°</b>	$a_{p\max}$ [in]	.177
	$\phi D$ [in]	.375 – 1.000



	SD 0903	P	M	K
		N	S	H
		M139 – M142		

**J(T)-ISXP16**

<b>15 – 75°</b>	$a_{p\max}$ [in]	.276 – 1.102
	$\phi D$ [in]	1.500 – 2.000



	XP 1604	P	M	K
		N		
		M143 – M147		

<b>ISO</b>	1	2	3	4	5	6	7	8	9	10	11	12	
	63	A	06	R	-		S	90	A	D	16	E	
<b>ANSI</b>	1	2	3	4	5	6	7	8	9	10	11	12	
	300	F	04	N	-	I	S	90	S	N	12	N	4

<b>1</b>	<b>1</b>	<b>2</b>	<b>2</b>	<b>3</b>	<b>3</b>	<b>5</b>	<b>6</b>	<b>6</b>	<b>7</b>	<b>7</b>		
Cutting diameter Diámetro de corte Diamètre de coupe		Cutting type, designation and/or size of clamping Tipo de fresa, designación y/o tamaño de amarre Diamètre de coupe, désignation et/ou taille de la fixation			No. of working edges Nº de filos Nombre de dents		Standard Sist. de medida Standard		Clamping designation Tipo de fijación Système de fixation		Setting angle Ángulo de posición Angle d'attaque	
		<p>A ISO 6462/A DIN 8030/A    B ISO 6462/B DIN 8030/B    C ISO 6462/C DIN 8030/C</p> <p>F <math>\phi d = 27 \text{ mm}</math>    <math>\phi d = 1.000</math>                  G <math>\phi d = 32 \text{ mm}</math>    <math>\phi d = 1.250</math>                  H <math>\phi d = 40 \text{ mm}</math>    -                  J <math>\phi d = 50 \text{ mm}</math>    -                  K <math>\phi d = 60 \text{ mm}</math>    -                  M <math>\phi d = 80 \text{ mm}</math>    -</p> <p>T </p>			<p>4    4</p> Direction of cut Dirección del corte Sens de la coupe <p>R </p> <p>L </p> <p>N </p>		<p>I    ["]</p>		<p>C </p> <p>S </p> <p>W </p> <p>F </p>		<p><math>K_r</math> 90° </p> <p><math>K_r</math> 75° </p> <p><math>K_r</math> 60° </p> <p><math>K_r</math> 45° </p> <p><math>K_r</math> MO </p>	

<b>8</b>	<b>8</b>		
Insert shape Forma de plaqueta Forme de la plaquette			
H	O	P	R
S	T	C	D
E	M	V	W
L	A	B	K

<b>9</b>	<b>9</b>
Clearance angle Ángulo de incidencia de plaqueta Angle de dépeuille	
A	B
C	D
E	F
G	N
P	O Special Especial Spécial

<b>10</b>	<b>10</b>												
Cutting edge length Longitud del filo de corte Longueur d'arête de coupe													
d = I.C.	H	O	P	S	T	C	D	E	M	V	W	R	K
[mm]													
3,97				03	06		04			06	02		
5/32"							1.2						
4,76				04	08	04	05	04	04	08	L3		
3/16"							1.5						
5,56				05	09	05	06	05	05	09	03		
7/32"							1.8						
6,35	03	02	04	08	11	06	07	08	08	11	04	06	
1/4"							2						
7,94	04	03	05	07	13	08	09	06	07	13	05	07	
5/16"							2.5						
9,525	05	04	07	09	16	09	11	09	09	16	06	09	19
3/8"							3						
12,7	07	05	09	12	22	12	15	13	12	22	08	12	
1/2"							4						
15,875	09	06	11	15	27	16	19	16	15	27	10	15	
5/8"							5						
19,05	11	07	13	19	33	19	23	19	19	33	13	19	
3/4"							6						
25,4	14	10	18	25	44	25	31	26	25	44	17	25	
1"							8						
31,75	18	13	23	31	54	32	38	32	31	54	21	31	
1 1/4"							10						

<b>11</b>	<b>11</b>	
Clearance angle Ángulo de incidencia Angle de dépeuille secondaire		
N $\alpha'_N = 0^\circ$	C $\alpha'_N = 7^\circ$	P $\alpha'_N = 11^\circ$
D $\alpha'_N = 15^\circ$	E $\alpha'_N = 20^\circ$	F $\alpha'_N = 25^\circ$

<b>12</b>	<b>12</b>												
Cutting edge length (width) Longitud de filo (ancho) Longueur d'arête de coupe (largeur)													
B [mm]/["]	<table border="1"> <tr> <td>B</td><td>1/16"</td></tr> <tr> <td>.156</td><td>2.5</td></tr> <tr> <td>.187</td><td>3</td></tr> <tr> <td>.250</td><td>4</td></tr> <tr> <td>.313</td><td>5</td></tr> <tr> <td>.375</td><td>6</td></tr> </table>	B	1/16"	.156	2.5	.187	3	.250	4	.313	5	.375	6
B	1/16"												
.156	2.5												
.187	3												
.250	4												
.313	5												
.375	6												



ISO/ANSI CODE DESIGNATION – SHOULDER END MILLING CUTTERS  
 CODIFICACIÓN ISO/ANSI – FRESAS DE RANURAR / ESCUADRAR  
 CODIFICATION ISO/ANSI – FRAISES A ALÉSAGE

<b>ISO</b>	<b>1</b>	<b>2</b>	<b>3</b>	<b>4</b>	<b>5</b>	<b>6</b>	<b>7</b>	-	<b>8</b>	<b>9</b>	<b>10</b>	<b>11</b>	<b>12</b>	<b>13</b>
	32	A	4	R	042	B	32	-		S	A	D	11	E
<b>ANSI</b>	<b>1</b>	<b>2</b>	<b>3</b>	<b>4</b>	<b>5</b>	<b>6</b>	<b>7</b>	-	<b>8</b>	<b>9</b>	<b>10</b>	<b>11</b>	<b>12</b>	<b>13</b>
	125	A	4	R	150	W	125	-	I	S	A	D	11	E

<b>1</b>	<b>1</b>	<b>2</b>					<b>5</b>		<b>6</b>			<b>7</b>																																																															
Cutting diameter Diámetro de corte Diamètre de coupe		Cutter type and setting angle Tipo de fresa y ángulo de posición Type de fraise et angle d'attaque					Overhang Voladizo Porte-à-faux		Shank designation Mango Désignation de l'attache			Shank size Tamaño de mango Taille de l'attache																																																															
		<table border="1"> <tr> <td>A</td> <td>E</td> <td>J</td> <td>N</td> <td>H</td> <td>K</td> </tr> <tr> <td></td> <td></td> <td></td> <td></td> <td></td> <td></td> </tr> </table>					A	E	J	N	H	K							[mm] ["]		<table border="1"> <tr> <td>A</td> <td>C</td> <td>DIN 1835A</td> </tr> <tr> <td>B</td> <td>W</td> <td>ISO 3338-2, DIN 1835B</td> </tr> <tr> <td>E</td> <td>-</td> <td>ISO 296, DIN 228-1</td> </tr> <tr> <td>G</td> <td>-</td> <td>ISO 297, DIN 208-1</td> </tr> <tr> <td>H</td> <td>-</td> <td>ISO/DIS 7388-1, DIN 69871-1</td> </tr> <tr> <td>N</td> <td>-</td> <td>ISO 12 164-1, DIN 69893</td> </tr> <tr> <td>-</td> <td>R8</td> <td>R8</td> </tr> <tr> <td>X</td> <td>-</td> <td>MAS BT</td> </tr> <tr> <td>XC</td> <td>-</td> <td>CAPTO</td> </tr> <tr> <td>-</td> <td>CA</td> <td>ANSI B5.50</td> </tr> </table>			A	C	DIN 1835A	B	W	ISO 3338-2, DIN 1835B	E	-	ISO 296, DIN 228-1	G	-	ISO 297, DIN 208-1	H	-	ISO/DIS 7388-1, DIN 69871-1	N	-	ISO 12 164-1, DIN 69893	-	R8	R8	X	-	MAS BT	XC	-	CAPTO	-	CA	ANSI B5.50	<table border="1"> <tr> <td>6-40</td> <td>.250" - 1.250"</td> </tr> <tr> <td>6-50</td> <td>.375" - 2.000"</td> </tr> <tr> <td>1-6</td> <td>-</td> </tr> <tr> <td>40-50</td> <td>-</td> </tr> <tr> <td>30-50</td> <td>-</td> </tr> <tr> <td>25-100</td> <td>-</td> </tr> <tr> <td>-</td> <td>1.250"</td> </tr> <tr> <td>30-50</td> <td>-</td> </tr> <tr> <td>3-10</td> <td>-</td> </tr> <tr> <td>-</td> <td>40/50</td> </tr> </table>		6-40	.250" - 1.250"	6-50	.375" - 2.000"	1-6	-	40-50	-	30-50	-	25-100	-	-	1.250"	30-50	-	3-10	-	-	40/50
A	E	J	N	H	K																																																																						
A	C	DIN 1835A																																																																									
B	W	ISO 3338-2, DIN 1835B																																																																									
E	-	ISO 296, DIN 228-1																																																																									
G	-	ISO 297, DIN 208-1																																																																									
H	-	ISO/DIS 7388-1, DIN 69871-1																																																																									
N	-	ISO 12 164-1, DIN 69893																																																																									
-	R8	R8																																																																									
X	-	MAS BT																																																																									
XC	-	CAPTO																																																																									
-	CA	ANSI B5.50																																																																									
6-40	.250" - 1.250"																																																																										
6-50	.375" - 2.000"																																																																										
1-6	-																																																																										
40-50	-																																																																										
30-50	-																																																																										
25-100	-																																																																										
-	1.250"																																																																										
30-50	-																																																																										
3-10	-																																																																										
-	40/50																																																																										
		<b>3</b>		<b>3</b>		<b>8</b>																																																																					
		No. of working edges Nº de filos Nombre de dents		Standard Sist. de medida Standard		I		["]																																																																			

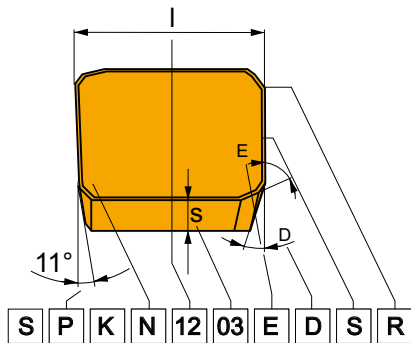
<b>8</b>				<b>8</b>				<b>9</b>		<b>9</b>		<b>10</b>											<b>10</b>																																																																																																																																																																																																																																																																																																																																																																																																													
Insert shape Forma de plaqueta Forme de la plaquette				Clearance angle Ángulo de incidencia de plaqueta Angle de dépeuille								Cutting edge length Longitud del filo de corte Longueur d'arête de coupe																																																																																																																																																																																																																																																																																																																																																																																																																								
<table border="1"> <tr> <td>H</td> <td>O</td> <td>P</td> <td>R</td> </tr> <tr> <td></td> <td></td> <td></td> <td></td> </tr> <tr> <td>S</td> <td>T</td> <td>C</td> <td>D</td> </tr> <tr> <td></td> <td></td> <td></td> <td></td> </tr> <tr> <td>E</td> <td>M</td> <td>V</td> <td>W</td> </tr> <tr> <td></td> <td></td> <td></td> <td></td> </tr> <tr> <td>L</td> <td>A</td> <td>B</td> <td>K</td> </tr> <tr> <td></td> <td></td> <td></td> <td></td> </tr> </table>				H	O	P	R					S	T	C	D					E	M	V	W					L	A	B	K					<table border="1"> <tr> <td>A</td> <td>B</td> </tr> <tr> <td></td> <td></td> </tr> <tr> <td>C</td> <td>D</td> </tr> <tr> <td></td> <td></td> </tr> <tr> <td>E</td> <td>F</td> </tr> <tr> <td></td> <td></td> </tr> <tr> <td>G</td> <td>N</td> </tr> <tr> <td></td> <td></td> </tr> <tr> <td>P</td> <td>O</td> </tr> <tr> <td></td> <td>Special Especial Spécial</td> </tr> </table>		A	B			C	D			E	F			G	N			P	O		Special Especial Spécial			<table border="1"> <tr> <td>d = I.C.</td> <td>H</td> <td>O</td> <td>P</td> <td>S</td> <td>T</td> <td>C</td> <td>D</td> <td>E</td> <td>M</td> <td>V</td> <td>W</td> <td>R</td> <td>K</td> </tr> <tr> <td>[mm]</td> <td></td> <td></td> <td></td> <td></td> <td></td> <td></td> <td></td> <td></td> <td></td> <td></td> <td></td> <td></td> <td></td> </tr> <tr> <td>3,97</td> <td></td> <td></td> <td></td> <td>03</td> <td>06</td> <td></td> <td>04</td> <td></td> <td></td> <td>06</td> <td>02</td> <td></td> <td></td> </tr> <tr> <td></td> <td></td> <td></td> <td></td> <td></td> <td></td> <td></td> <td>1.2</td> <td></td> <td></td> <td></td> <td></td> <td></td> <td></td> </tr> <tr> <td>4,76</td> <td></td> <td></td> <td></td> <td>04</td> <td>08</td> <td>04</td> <td>05</td> <td>04</td> <td>04</td> <td>08</td> <td>L3</td> <td></td> <td></td> </tr> <tr> <td></td> <td></td> <td></td> <td></td> <td></td> <td></td> <td></td> <td>1.5</td> <td></td> <td></td> <td></td> <td></td> <td></td> <td></td> </tr> <tr> <td>5,56</td> <td></td> <td></td> <td></td> <td>05</td> <td>09</td> <td>05</td> <td>06</td> <td>05</td> <td>05</td> <td>09</td> <td>03</td> <td></td> <td></td> </tr> <tr> <td></td> <td></td> <td></td> <td></td> <td></td> <td></td> <td></td> <td>1.8</td> <td></td> <td></td> <td></td> <td></td> <td></td> <td></td> </tr> <tr> <td>6,35</td> <td>03</td> <td>02</td> <td>04</td> <td>08</td> <td>11</td> <td>06</td> <td>07</td> <td>08</td> <td>08</td> <td>11</td> <td>04</td> <td>06</td> <td></td> </tr> <tr> <td></td> <td></td> <td></td> <td></td> <td></td> <td></td> <td></td> <td>2</td> <td></td> <td></td> <td></td> <td></td> <td></td> <td></td> </tr> <tr> <td>7,94</td> <td>04</td> <td>03</td> <td>05</td> <td>07</td> <td>13</td> <td>08</td> <td>09</td> <td>06</td> <td>07</td> <td>13</td> <td>05</td> <td>07</td> <td></td> </tr> <tr> <td></td> <td></td> <td></td> <td></td> <td></td> <td></td> <td></td> <td>2.5</td> <td></td> <td></td> <td></td> <td></td> <td></td> <td></td> </tr> <tr> <td>9,525</td> <td>05</td> <td>04</td> <td>07</td> <td>09</td> <td>16</td> <td>09</td> <td>11</td> <td>09</td> <td>09</td> <td>16</td> <td>06</td> <td>09</td> <td>19</td> </tr> <tr> <td></td> <td></td> <td></td> <td></td> <td></td> <td></td> <td></td> <td>3</td> <td></td> <td></td> <td></td> <td></td> <td></td> <td></td> </tr> <tr> <td>12,7</td> <td>07</td> <td>05</td> <td>09</td> <td>12</td> <td>22</td> <td>12</td> <td>15</td> <td>13</td> <td>12</td> <td>22</td> <td>08</td> <td>12</td> <td></td> </tr> <tr> <td></td> <td></td> <td></td> <td></td> <td></td> <td></td> <td></td> <td>4</td> <td></td> <td></td> <td></td> <td></td> <td></td> <td></td> </tr> <tr> <td>15,875</td> <td>09</td> <td>06</td> <td>11</td> <td>15</td> <td>27</td> <td>16</td> <td>19</td> <td>16</td> <td>15</td> <td>27</td> <td>10</td> <td>15</td> <td></td> </tr> <tr> <td></td> <td></td> <td></td> <td></td> <td></td> <td></td> <td></td> <td>5</td> <td></td> <td></td> <td></td> <td></td> <td></td> <td></td> </tr> <tr> <td>19,05</td> <td>11</td> <td>07</td> <td>13</td> <td>19</td> <td>33</td> <td>19</td> <td>23</td> <td>19</td> <td>19</td> <td>33</td> <td>13</td> <td>19</td> <td></td> </tr> <tr> <td></td> <td></td> <td></td> <td></td> <td></td> <td></td> <td></td> <td>6</td> <td></td> <td></td> <td></td> <td></td> <td></td> <td></td> </tr> <tr> <td>25,4</td> <td>14</td> <td>10</td> <td>18</td> <td>25</td> <td>44</td> <td>25</td> <td>31</td> <td>26</td> <td>25</td> <td>44</td> <td>17</td> <td>25</td> <td></td> </tr> <tr> <td></td> <td></td> <td></td> <td></td> <td></td> <td></td> <td></td> <td>8</td> <td></td> <td></td> <td></td> <td></td> <td></td> <td></td> </tr> <tr> <td>31,75</td> <td>18</td> <td>13</td> <td>23</td> <td>31</td> <td>54</td> <td>32</td> <td>38</td> <td>32</td> <td>31</td> <td>54</td> <td>21</td> <td>31</td> <td></td> </tr> <tr> <td></td> <td></td> <td></td> <td></td> <td></td> <td></td> <td></td> <td>10</td> <td></td> <td></td> <td></td> <td></td> <td></td> <td></td> </tr> <tr> <td></td> <td></td> <td></td> <td></td> <td></td> <td></td> <td></td> <td>11/4"</td> <td></td> <td></td> <td></td> <td></td> <td></td> <td></td> </tr> </table>											d = I.C.	H	O	P	S	T	C	D	E	M	V	W	R	K	[mm]														3,97				03	06		04			06	02										1.2							4,76				04	08	04	05	04	04	08	L3										1.5							5,56				05	09	05	06	05	05	09	03										1.8							6,35	03	02	04	08	11	06	07	08	08	11	04	06									2							7,94	04	03	05	07	13	08	09	06	07	13	05	07									2.5							9,525	05	04	07	09	16	09	11	09	09	16	06	09	19								3							12,7	07	05	09	12	22	12	15	13	12	22	08	12									4							15,875	09	06	11	15	27	16	19	16	15	27	10	15									5							19,05	11	07	13	19	33	19	23	19	19	33	13	19									6							25,4	14	10	18	25	44	25	31	26	25	44	17	25									8							31,75	18	13	23	31	54	32	38	32	31	54	21	31									10														11/4"						
H	O	P	R																																																																																																																																																																																																																																																																																																																																																																																																																																	
S	T	C	D																																																																																																																																																																																																																																																																																																																																																																																																																																	
E	M	V	W																																																																																																																																																																																																																																																																																																																																																																																																																																	
L	A	B	K																																																																																																																																																																																																																																																																																																																																																																																																																																	
A	B																																																																																																																																																																																																																																																																																																																																																																																																																																			
C	D																																																																																																																																																																																																																																																																																																																																																																																																																																			
E	F																																																																																																																																																																																																																																																																																																																																																																																																																																			
G	N																																																																																																																																																																																																																																																																																																																																																																																																																																			
P	O																																																																																																																																																																																																																																																																																																																																																																																																																																			
	Special Especial Spécial																																																																																																																																																																																																																																																																																																																																																																																																																																			
d = I.C.	H	O	P	S	T	C	D	E	M	V	W	R	K																																																																																																																																																																																																																																																																																																																																																																																																																							
[mm]																																																																																																																																																																																																																																																																																																																																																																																																																																				
3,97				03	06		04			06	02																																																																																																																																																																																																																																																																																																																																																																																																																									
							1.2																																																																																																																																																																																																																																																																																																																																																																																																																													
4,76				04	08	04	05	04	04	08	L3																																																																																																																																																																																																																																																																																																																																																																																																																									
							1.5																																																																																																																																																																																																																																																																																																																																																																																																																													
5,56				05	09	05	06	05	05	09	03																																																																																																																																																																																																																																																																																																																																																																																																																									
							1.8																																																																																																																																																																																																																																																																																																																																																																																																																													
6,35	03	02	04	08	11	06	07	08	08	11	04	06																																																																																																																																																																																																																																																																																																																																																																																																																								
							2																																																																																																																																																																																																																																																																																																																																																																																																																													
7,94	04	03	05	07	13	08	09	06	07	13	05	07																																																																																																																																																																																																																																																																																																																																																																																																																								
							2.5																																																																																																																																																																																																																																																																																																																																																																																																																													
9,525	05	04	07	09	16	09	11	09	09	16	06	09	19																																																																																																																																																																																																																																																																																																																																																																																																																							
							3																																																																																																																																																																																																																																																																																																																																																																																																																													
12,7	07	05	09	12	22	12	15	13	12	22	08	12																																																																																																																																																																																																																																																																																																																																																																																																																								
							4																																																																																																																																																																																																																																																																																																																																																																																																																													
15,875	09	06	11	15	27	16	19	16	15	27	10	15																																																																																																																																																																																																																																																																																																																																																																																																																								
							5																																																																																																																																																																																																																																																																																																																																																																																																																													
19,05	11	07	13	19	33	19	23	19	19	33	13	19																																																																																																																																																																																																																																																																																																																																																																																																																								
							6																																																																																																																																																																																																																																																																																																																																																																																																																													
25,4	14	10	18	25	44	25	31	26	25	44	17	25																																																																																																																																																																																																																																																																																																																																																																																																																								
							8																																																																																																																																																																																																																																																																																																																																																																																																																													
31,75	18	13	23	31	54	32	38	32	31	54	21	31																																																																																																																																																																																																																																																																																																																																																																																																																								
							10																																																																																																																																																																																																																																																																																																																																																																																																																													
							11/4"																																																																																																																																																																																																																																																																																																																																																																																																																													

<b>4</b>		<b>4</b>		<b>9</b>				<b>9</b>				<b>13</b>				<b>13</b>																													
Direction of cut Dirección del corte Sens de la coupe				Clamping designation Tipo de fijación Système de fixation								Clearance angle Ángulo de incidencia Angle de dépeuille secondaire																																	
<table border="1"> <tr> <td>R</td> <td></td> </tr> <tr> <td>L</td> <td></td> </tr> <tr> <td>N</td> <td></td> </tr> </table>		R		L		N				<table border="1"> <tr> <td>C</td> <td></td> <td>W</td> <td></td> </tr> <tr> <td>S</td> <td></td> <td>F</td> <td></td> </tr> </table>				C		W		S		F						<table border="1"> <tr> <td>N</td> <td><math>\alpha'_N = 0^\circ</math></td> <td>C</td> <td><math>\alpha'_N = 7^\circ</math></td> <td>P</td> <td><math>\alpha'_N = 11^\circ</math></td> </tr> <tr> <td>D</td> <td><math>\alpha'_N = 15^\circ</math></td> <td>E</td> <td><math>\alpha'_N = 20^\circ</math></td> <td>F</td> <td><math>\alpha'_N = 25^\circ</math></td> </tr> </table>				N	$\alpha'_N = 0^\circ$	C	$\alpha'_N = 7^\circ$	P	$\alpha'_N = 11^\circ$	D	$\alpha'_N = 15^\circ$	E	$\alpha'_N = 20^\circ$	F	$\alpha'_N = 25^\circ$				
R																																													
L																																													
N																																													
C		W																																											
S		F																																											
N	$\alpha'_N = 0^\circ$	C	$\alpha'_N = 7^\circ$	P	$\alpha'_N = 11^\circ$																																								
D	$\alpha'_N = 15^\circ$	E	$\alpha'_N = 20^\circ$	F	$\alpha'_N = 25^\circ$																																								

1				1			
Insert shape Forma de plaquita Forme de la plaquette							
H	O	P	R				
S	T	C	D				
E	M	V	W				
L	A	B	K				

2		2	
Clearance angle Ángulo de incidencia de plaquita Angle de dépeuille			
A	3°	B	5°
C	7°	D	15°
E	20°	F	25°
G	30°	N	0°
P	11°	O	Special Especial Spécial

4		4	
Insert type Tipo de plaquita Type de plaquette			
N			
R			
F			
A			
M			
G			
W	40–60°		
T			
Q			
U			
B	70–90°		
H			
C			
J			
X	Special / Especial / Spécial		

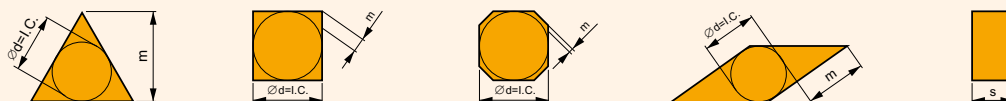


ISO
S
S

ANSI
S
S

1	2	3	4
S	P	G	N
S	P	K	N
1	2	3	4
S	P	G	
S	P	K	N

3		3					
Tolerances / Tolerancia / Tolérances							
	[mm]			["]			
	m (±)	s (±)	d = l.C. (±)	m (±)	s (±)	d = l.C. (±)	
A	0,005	0,025	0,025	.0002"	.001"	.0010"	
F	0,005	0,025	0,013	.0002"	.001"	.0005"	
C	0,013	0,025	0,025	.0005"	.001"	.0010"	
H	0,013	0,025	0,013	.0005"	.001"	.0005"	
E	0,025	0,025	0,025	.0010"	.001"	.0010"	
G	0,025	0,130	0,025	.0010"	.005"	.0010"	
J	0,005	0,025	0,05–0,13	.0002"	.001"	.002"–.005"	
K	0,013	0,025	0,05–0,13	.0005"	.001"	.002"–.005"	
L	0,025	0,025	0,05–0,13	.0010"	.001"	.002"–.005"	
M	0,08–0,18	0,130	0,05–0,13	.003"–.007"	.005"	.002"–.005"	
N	0,08–0,18	0,025	0,05–0,13	.003"–.007"	.001"	.002"–.005"	
U	0,05–0,38	0,130	0,05–0,13	.005"–.015"	.005"	.003"–.010"	



5													
Cutting edge length / Longitud del filo de corte / Longueur d'arête de coupe													
d = I.C.	H	O	P	S	T	C	D	E	M	V	W	R	K
[mm]													
3,97				03	06		04				06	02	
	5/32"						1.2						
4,76				04	08	04	05	04	04	08	L3		
	3/16"						1.5						
5,56				05	09	05	06	05	05	09	03		
	7/32"						1.8						
6,35	03	02	04	08	11	06	07	08	08	11	04	06	
	1/4"						2						
7,94	04	03	05	07	13	08	09	06	07	13	05	07	
	5/16"						2.5						
9,525	05	04	07	09	16	09	11	09	09	16	06	09	19
	3/8"						3						
12,7	07	05	09	12	22	12	15	13	12	22	08	12	
	1/2"						4						
15,875	09	06	11	15	27	16	19	16	15	27	10	15	
	5/8"						5						
19,05	11	07	13	19	33	19	23	19	19	33	13	19	
	3/4"						6						
25,4	14	10	18	25	44	25	31	26	25	44	17	25	
	1"						8						
31,75	18	13	23	31	54	32	38	32	31	54	21	31	
	1 1/4"						10						

6		
Thickness Espesor / Épaisseur		
Symbol	s	
	[mm]	["]
01	1,59	1/16"
T1	1,98	5/64"
02	2,38	3/32"
03	3,18	1/8"
T3	3,97	5/32"
04	4,76	3/16"
05	5,56	7/32"
06	6,35	1/4"
07	7,94	5/16"
09	9,52	3/8"

7			
Cutting edge angles Ángulo de corte Angle d'attaque	Clearance angle Ángulo de incidencia de corte Angle de dépouille		
	$\chi_r$		
	$\alpha'_n$		
A	45°		
D	60°		
E	75°		
F	85°		
P	90°		
Z	Special Especial Spécial	F	25°
		G	30°
		N	0°
		P	11°
		Z	Special Especial Spécial
		ZZ - Special/Especial/Spécial	

5
12
12
5a
4
4

6
03
03
6a
2
2

7
08
ED
7a
2
ED

8
S
8
S

9
R
9
R

10
-
10
-

ANSI		
5a	6a	7a
Inscribed circle Círculo inscrito / Cercle inscrit	Thickness Espesor / Épaisseur	Nose radius Radio de punta Rayon de pointe
Symbol	Symbol	Symbol
1	1	0
1.2	1.2	0.5
1.5	1.5	1
1.8	2	2
2	2.5	3
2.5	3	3.5
3	3.5	4
3.5	4	5
4	4	6
5	5	7
6	6	8
7	7	10
8	8	12
10	9	14
12	10	16

8	
Cutting edge design / Diseño del filo / Conception d'arête de coupe	
	F Sharp edges Filo vivo Arêtes vives
	T Edges with facet Filo vivo con faceta Arêtes avec listel
	K Edges with double facet Filo con doble faceta Arêtes avec double listel
	E Rounded edges Filo redondeado Arêtes rayonnées
	S Rounded edges with facet Filo redondeado con faceta Arêtes rayonnées avec listel
	P Rounded edges with double facet Filo redondeado con doble faceta Arêtes rayonnées avec double listel

9	
Feed direction / Dirección del avance / Direction d'avance	
R	
L	
N	

10	
Chip breaker designation / Designación del rompevirutas / Désignation de géométrie	

**ISHN06C**

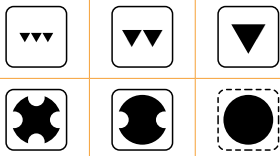
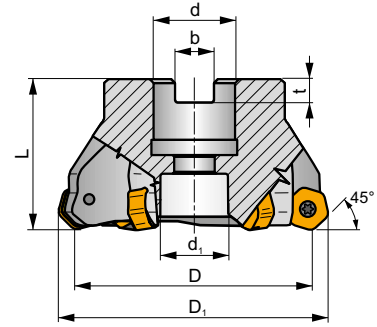
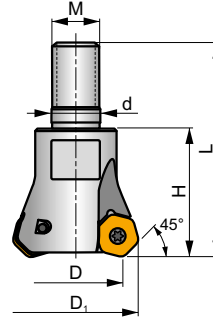
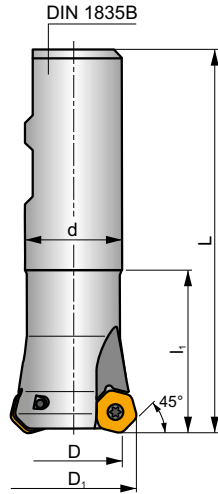
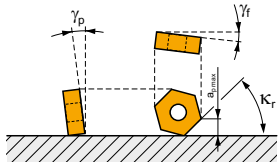
**P M K N H**

**S**

**ECON HN**



$K_r$	45°
$a_{pmax}$	.118



.0016-.0031

.0016-.0024



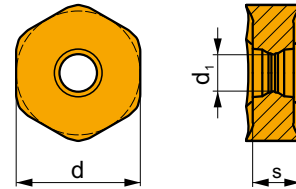
ANSI	D	D <sub>1</sub>	L	d	d <sub>1</sub>	l <sub>1</sub>	H	M	b	t	$\gamma_r^\circ$	$\gamma_p^\circ$			max.		lbs		
100N2R138M12-ISHN06C-C	1.000	1.283	2.244	.492	-	-	1.378	M12	-	-	-7	-7	2	-	-	✓	.22	GI204	IFA010
125N3R169M16-ISHN06C-C	1.250	1.537	2.598	.669	-	-	1.693	M16	-	-	-7	-7	3	-	-	✓	.49	GI204	IFA010
150N4R169M16-ISHN06C-C	1.500	1.787	2.598	.669	-	-	1.693	M16	-	-	-7	-7	4	✓	-	✓	.60	GI204	IFA010
150A05R-IS45HN06C-C	1.500	1.787	1.575	.500	.433	-	-	-	.258	.165	-7	-7	5	✓	13800	✓	.55	GI204	IFA012
200A04R-IS45HN06C-C	2.000	2.287	1.575	.750	.630	-	-	-	.321	.193	-7	-7	4	✓	12300	✓	.93	GI204	IFA013
250A06R-IS45HN06C-C	2.500	2.287	1.575	.750	.630	-	-	-	.321	.193	-7	-7	6	✓	11000	✓	1.21	GI204	IFA013
300A07R-IS45HN06C-C	3.000	3.268	1.969	1.000	.827	-	-	-	.382	.224	-7	-7	7	✓	9700	✓	2.40	GI204	IFA014
400A08R-IS45HN06C-C	4.000	4.280	1.969	1.500	1.260	-	-	-	.630	.382	-7	-7	8	✓	8700	✓	3.99	GI204	IFA015
500A16R-IS45HN06C-C	5.000	5.283	2.480	1.500	1.260	-	-	-	.630	.382	-7	-7	16	✓	7800	✓	7.30	GI204	IFA019

GI204	HNGX 0604AN..	XNGX 0604AN..

IFA010	US 3007-T09P	2.0	M 3	.280	-	-	Flag T09P	-
IFA012	US 3007-T09P	2.0	M 3	.280	D-T07P/T09P	FG-15	-	HS 025100
IFA013	US 3007-T09P	2.0	M 3	.280	D-T07P/T09P	FG-15	-	HS 037100
IFA014	US 3007-T09P	2.0	M 3	.280	D-T07P/T09P	FG-15	-	HS 050125
IFA015	US 3007-T09P	2.0	M 3	.280	D-T07P/T09P	FG-15	-	HCS 075200
IFA019	US 3007-T09P	2.0	M 3	.280	D-T07P/T09P	FG-15	-	HS 075125

## HNGX 06

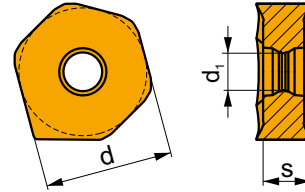
	d	d <sub>1</sub>	s
0604	.413	.146	.187



		ANSI		P	M	K	N	S	H			r <sub>c</sub>	f <sub>min</sub>	f <sub>max</sub>	a <sub>p min</sub>	a <sub>p max</sub>		
    	 	HNGX 0604ANSN-F	M9340	█	█					☹	---	-	.003	.007	.012	.118		
			M6330	█	█						☹	-	-	.003	.007	.012	.118	
			M8310	█	█	□						☹	-	-	.003	.007	.012	.118
			M8330	█	█	□	□					☹	-	-	.003	.007	.012	.118
			M8340	█	█	□						☹	+/-	-	.003	.007	.012	.118
			8215	█	█	□	□					☹	-	-	.003	.007	.012	.118
   	 	HNGX 0604ANSN-M	M5315	█		█			□	☹	---	-	.005	.010	.024	.118		
			M9315	█		█			□	☹	---	-	.005	.010	.024	.118		
			M9325	█	█						☹	---	-	.005	.010	.024	.118	
			M9340	█	█						☹	---	-	.005	.010	.024	.118	
			M6330	█	█						☹	-	-	.005	.010	.024	.118	
			M8310	█	█	█				□	☹	-	-	.005	.010	.024	.118	
			M8330	█	█	█	□			□	☹	-	-	.005	.010	.024	.118	
			M8340	█	█	█					☹	+/-	-	.005	.010	.024	.118	
8215	█	█	█	□			□	☹	-	-	.005	.010	.024	.118				
  	 	HNGX 0604ANSN-R	M5315	█		█			█	☹	---	-	.007	.012	.039	.118		
			M9315	█		█			█	☹	---	-	.007	.012	.039	.118		
			M9325	█	█					☹	---	-	.007	.012	.039	.118		
			M8310	█	█	█				█	☹	-	-	.007	.012	.039	.118	
			M8330	█	█	█				█	☹	-	-	.007	.012	.039	.118	
			M8340	█	█	█					☹	+/-	-	.007	.012	.039	.118	
			8215	█	█	█				█	☹	-	-	.007	.012	.039	.118	

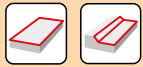
# XNGX 06

	d	d <sub>1</sub>	s
0604	.413	.146	.187



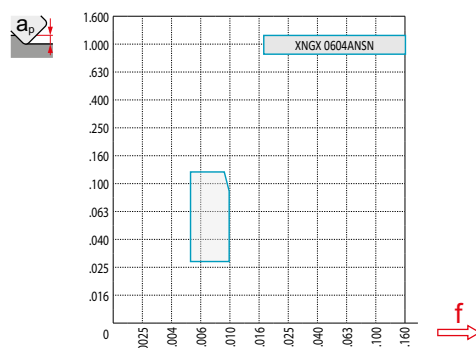
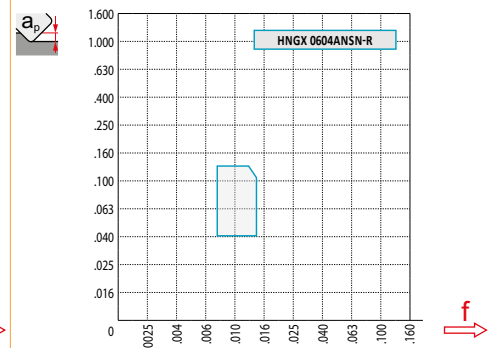
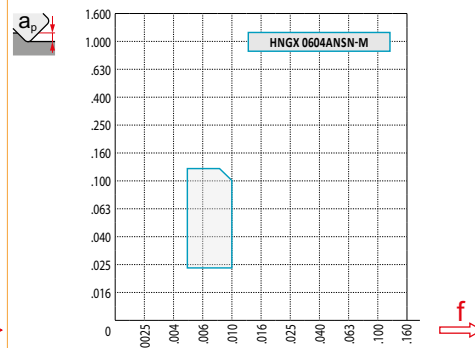
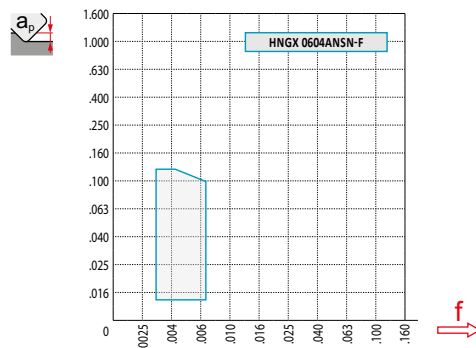
		ANSI		P	M	K	N	S	H			r <sub>c</sub>	f <sub>min</sub>	f <sub>max</sub>	a <sub>p min</sub>	a <sub>p max</sub>
		XNGX 0604ANSN	8215								-	-	.005	.010	.028	.118
		.005														

ISO	f <sub>min</sub>	f <sub>max</sub>	M5315	M9315	M9325	M9340	M8310	M8340	8215	M8330	
P		.0039	.0118	1640	1604	1549	1339	1378	1227	1322	1207
		.0039	.0098	1529	1473	1398	1188	1247	1076	1152	1056
		.0039	.0059	1398	1322	1227	1056	1112	925	981	906
M		.0039	.0118	-	-	925	794	830	735	794	719
		.0039	.0098	-	-	830	719	735	643	679	643
		.0039	.0059	-	-	735	623	659	548	584	548
K		.0039	.0118	1565	1529	-	-	1302	1152	1247	1152
		.0039	.0098	1453	1398	-	-	1188	1020	1096	1001
		.0039	.0059	1339	1263	-	-	1056	886	925	869
N		.0039	.0118	-	-	-	-	-	-	3320	3038
		.0039	.0098	-	-	-	-	-	-	2887	2680
		.0039	.0059	-	-	-	-	-	-	2470	2303
H		.0039	.0079	322	322	-	-	266	-	266	226
		.0039	.0063	302	282	-	-	246	-	226	207
		.0039	.0047	266	266	-	-	207	-	190	171






$a_p/D$	.05	.10	.15	.20	.25	.30	.40	.50	.60	.70	.75	.80	.90	1.00
	1.48	1.35	1.27	1.22	1.19	1.16	1.11	1.08	1.05	1.03	1.02	1.01	.99	.98
	2.87	2.05	1.69	1.48	1.33	1.23	1.09	.75	.94	.90	.89	.88	.88	1.00
	.64	.64	.64	.64	.64	.65	.65	.67	.68	.71	.72	.74	.79	1.00

	HNGX 06-F	HNGX 06-M	HNGX 06-R	XNGX 06
$r_\epsilon$	-	-	-	-
$a$	.044	.031	.031	.163




$D$	$X.V$	$f_{max}$
1.000	1.31	.009
1.250	1.36	.011
1.500	1.40	.012
2.000	1.45	.014
2.500	1.49	.015
3.000	1.54	.017
4.000	1.59	.019
5.000	1.64	.022



	$\alpha_{\max}^{\circ}$ 	$a_p/l$ 
1.00	2.7	.12/2.5
1.25	1.9	.12/3.5
1.50	1.5	.1/4.0
2.00	1.1	.075/4.0
2.50	.9	.06/4.0
3.00	.6	.045/4.0
4.00	.5	.03/4.0
5.00	.4	.025/4.0



$a_p$ 
.035



ISHN09C

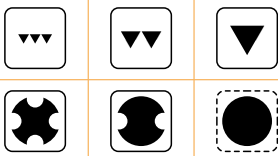
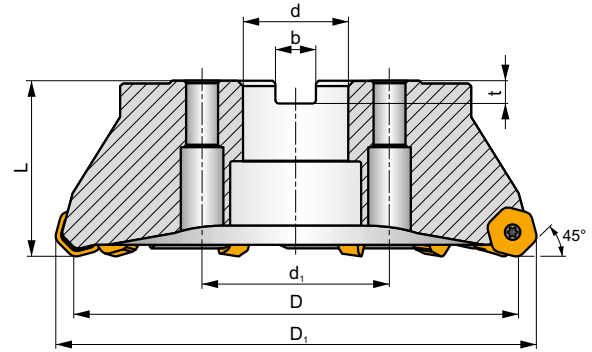
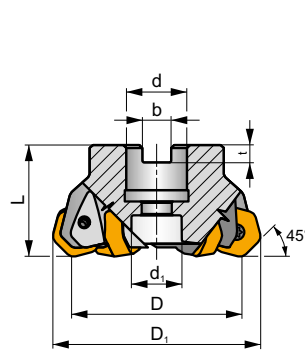
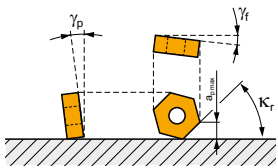
P M K N H

S

ECON HN



$\kappa_r$	45°
$a_{pmax}$	.197



$h_m$  .0031-.0098



ANSI	D	D <sub>1</sub>	L	d	d <sub>1</sub>	b	t	$\gamma_f^\circ$	$\gamma_p^\circ$								
200A04R-IS45HN09C-CF	2.000	2.461	1.575	.750	.630	.321	.193	-7	-7	4	✓	7900	✓	.77	IGI252	IFA023	
250A06R-IS45HN09C-CF	2.500	2.961	1.575	.750	.630	.321	.193	-7	-7	6	✓	7000	✓	1.08	IGI252	IFA023	
300A06R-IS45HN09C-CF	3.000	3.461	1.969	1.000	.827	.382	.224	-7	-7	6	✓	6200	✓	2.34	IGI252	IFA024	
300A08R-IS45HN09C-CF	3.000	3.461	1.969	1.000	.827	.382	.224	-7	-7	8	✓	6200	✓	2.34	IGI252	IFA024	
400A06R-IS45HN09C-CF	4.000	4.461	1.969	1.500	1.260	.630	.382	-7	-7	6	✓	5600	✓	3.84	IGI252	IFA025	
400A08R-IS45HN09C-CF	4.000	4.461	1.969	1.500	1.260	.630	.382	-7	-7	8	✓	5600	✓	3.84	IGI252	IFA025	
400A10R-IS45HN09C-CF	4.000	4.461	1.969	1.500	1.260	.630	.382	-8	-7	10	-	5600	✓	3.84	IGI252	IFA025	
500A06R-IS45HN09C-CF	5.000	5.461	2.480	1.500	1.260	.630	.382	-7	-7	6	✓	5000	✓	7.14	IGI252	IFA020	
500A10R-IS45HN09C-CF	5.000	5.461	2.480	1.500	1.260	.630	.382	-7	-7	10	✓	5000	✓	7.14	IGI252	IFA020	
500A12R-IS45HN09C-CF	5.000	5.461	2.480	1.500	1.260	.630	.382	-8	-7	12	-	5000	✓	7.14	IGI252	IFA020	
600B08R-IS45HN09CF	6.000	6.461	2.480	2.000	3.465	.756	.445	-7	-7	8	✓	4400	-	12.57	IGI252	IFA021	
600B12R-IS45HN09CF	6.000	6.461	2.480	2.000	3.465	.756	.445	-7	-7	12	✓	4400	-	12.57	IGI252	IFA021	
800C10R-IS45HN09CF	8.000	8.461	2.480	2.500	4.000	1.000	.559	-7	-7	10	✓	3900	-	19.84	IGI252	IFA021	
1000C14R-IS45HN09CF	10.000	1.461	2.480	2.500	4.000	1.000	.559	-7	-7	14	✓	3500	-	28.22	IGI252	IFA021	
1200C16R-IS45HN09CF	12.000	12.461	3.150	2.500	4.000	1.000	.559	-7	-7	16	✓	3100	-	7.99	IGI252	IFA021	



IGI252



HNGX 0906AN..

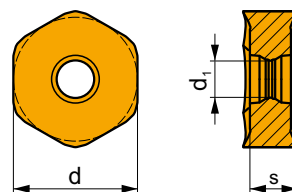


XNGX 0906AN..

IFA020	US 54511-T15P	5.0	M 4.5	.445	D-T08P/T15P	FG-15	-	HS 075125	-	-	-	-
IFA021	US 54511-T15P	5.0	M 4.5	.445	D-T08P/T15P	FG-15	-	-	-	-	-	-
IFA023	US 54511-T15P	5.0	M 4.5	.445	D-T08P/T15P	FG-15	-	HS 037100	-	-	-	-
IFA024	US 54511-T15P	5.0	M 4.5	.445	D-T08P/T15P	FG-15	-	HS 050125	-	-	-	-
IFA025	US 54511-T15P	5.0	M 4.5	.445	D-T08P/T15P	FG-15	-	HCS 075200	-	-	-	-

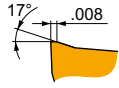
## HNGX 09

	d	d <sub>1</sub>	s
0906	.650	.193	.250



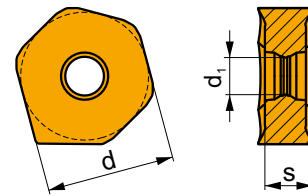
	ANSI		P	M	K	N	S	H			r <sub>ε</sub>	f <sub>min</sub>	f <sub>max</sub>	a <sub>p min</sub>	a <sub>p max</sub>	
    	HNGX 0906ANEN-FF	M9340	█	█					●	---	-	.002	.008	.020	.197	
		8215	█	█	□	□				●	-	-	.002	.008	.020	.197
		8230	█	█	□	□				●	-	-	.002	.008	.020	.197
		M8330	█	█	□	□				●	-	-	.002	.008	.020	.197
    	HNGX 0906ANSN-F	M9340	█	█					●	---	-	.004	.008	.020	.197	
		M6330	█	█						●	-	-	.004	.008	.020	.197
		M8310	█	█	□					●	-	-	.004	.008	.020	.197
		M8330	█	█	□	□				●	-	-	.004	.008	.020	.197
		M8340	█	█	□					●	+/-	-	.004	.008	.020	.197
		8215	█	█	□	□				●	-	-	.004	.008	.020	.197
		8230	█	█	□	□				●	-	-	.004	.008	.020	.197
    	HNGX 0906ANSN-M	M5315	█		█			□	●	---	-	.007	.014	.031	.197	
		M9315	█		█			□	●	---	-	.007	.014	.031	.197	
		M9325	█	█						●	---	-	.007	.014	.031	.197
		M9340	█	█						●	---	-	.007	.014	.031	.197
		M6330	█	█						●	-	-	.007	.014	.031	.197
		M8310	█	█	█				□	●	-	-	.007	.014	.031	.197
		M8330	█	█	█	□			□	●	-	-	.007	.014	.031	.197
		M8340	█	█	█					●	+/-	-	.007	.014	.031	.197
		8215	█	█	█	□			□	●	-	-	.007	.014	.031	.197
		8230	█	█	█	□			□	●	-	-	.007	.014	.031	.197

i	ANSI		P	M	K	N	S	H			$r_e$	$f_{min}$	$f_{max}$	$a_{p\ min}$	$a_{p\ max}$	
  	 <b>HNGX 0906ANSN-R</b>		M5315	☑		☑		☑	✘	---	-	.012	.020	.039	.197	
			M9315	☑		☑		☑	✘	---	-	.012	.020	.039	.197	
			M9325	☑	☑					✘	---	-	.012	.020	.039	.197
			M8310	☑	☑	☑			☑	✘	-	-	.012	.020	.039	.197
			M8330	☑	☑	☑			☑	✘	-	-	.012	.020	.039	.197
			M8340	☑	☑	☑				✘	+/-	-	.012	.020	.039	.197
			8215	☑	☑	☑			☑	✘	-	-	.012	.020	.039	.197

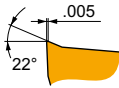


## XNGX 09

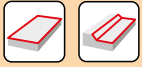
	d	d <sub>1</sub>	s
0906	.650	.193	.250



i	ANSI		P	M	K	N	S	H			$r_e$	$f_{min}$	$f_{max}$	$a_{p\ min}$	$a_{p\ max}$
  	 <b>XNGX 0906ANSN</b>		M8330	☑	☑	☑			✘	-	-	.007	.020	.031	.197
			8215	☑	☑	☑				✘	-	-	.007	.020	.031

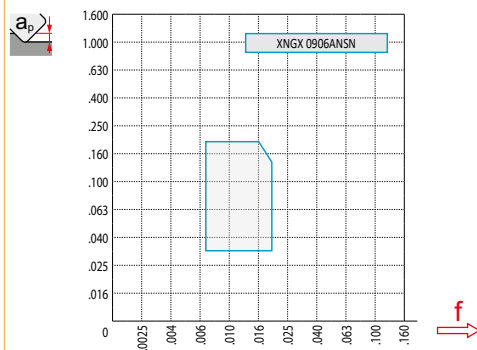
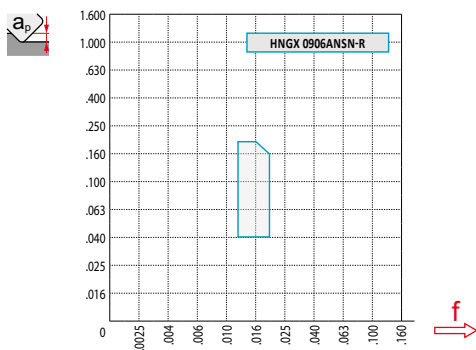
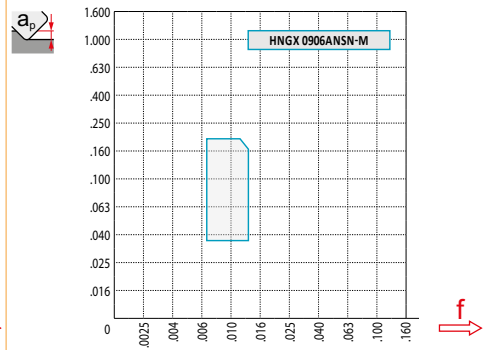
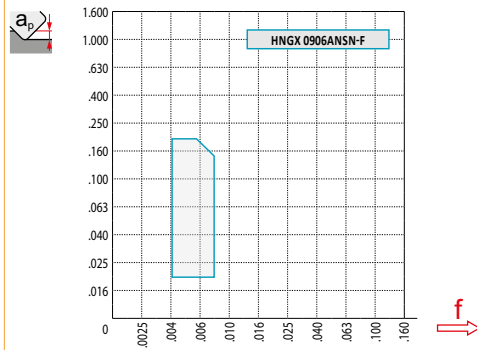
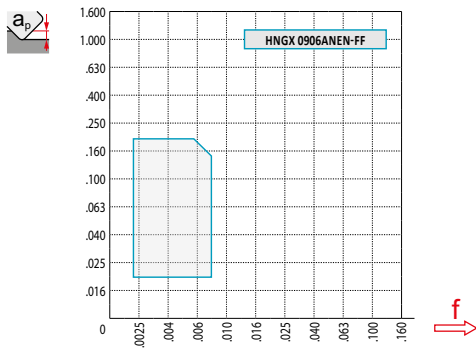


ISO	$f_{min}$	$f_{max}$	M5315	M9315	M9325	M9340	M6330	M8310	M8340	8215	M8330	
P	●	.0039	.0157	1640	1604	1549	1339	1207	1378	1227	1322	1207
	☑	.0039	.0118	1529	1473	1398	1188	1076	1247	1076	1152	1056
	✘	.0039	.0079	1398	1322	1227	1056	945	1112	925	981	906
M	●	.0039	.0138	-	-	925	794	794	830	735	794	719
	☑	.0039	.0098	-	-	830	719	699	735	643	679	643
	✘	.0039	.0059	-	-	735	623	604	659	548	584	548
K	●	.0039	.0157	1565	1529	-	-	-	1302	1152	1247	1152
	☑	.0039	.0118	1453	1398	-	-	-	1188	1020	1096	1001
	✘	.0039	.0079	1339	1263	-	-	-	1056	886	925	869
N	●	.0039	.0157	-	-	-	-	-	-	-	3320	3038
	☑	.0039	.0118	-	-	-	-	-	-	-	2887	2680
	✘	.0039	.0079	-	-	-	-	-	-	-	2470	2303
H	●	.0039	.0098	322	322	-	-	-	266	-	266	226
	☑	.0039	.0079	302	282	-	-	-	246	-	226	207
	✘	.0039	.0059	266	266	-	-	-	207	-	190	171



$a_e/D$	.05	.10	.15	.20	.25	.30	.40	.50	.60	.70	.75	.80	.90	1.00
$X.V$	1.48	1.35	1.27	1.22	1.19	1.16	1.11	1.08	1.05	1.03	1.02	1.01	.99	.98
$X.f$	2.87	2.05	1.69	1.48	1.33	1.23	1.09	.75	.94	.90	.89	.88	.88	1.00
$X.f$	.64	.64	.64	.64	.64	.65	.65	.67	.68	.71	.72	.74	.79	1.00

	HNGX 09-FF	HNGX 09-F	HNGX 09-M	HNGX 09-R	XNGX 09
$r_\epsilon$	-	-	-	-	-
$a$	.059	.046	.046	.046	.296



$D$	$X.V$	$f_{max}$
2.00	1.35	.014
2.50	1.39	.016
3.00	1.44	.018
4.00	1.48	.020
5.00	1.53	.022
6.00	1.58	.025
8.00	1.63	.028
10.00	1.68	.031
12.00	1.74	.035



$D$	$\alpha_{max}$	$a_p/l$
2.00	2.1	.140/4.00
2.50	1.5	.100/4.00
3.00	1.1	.070/4.00
4.00	.9	.060/4.00
5.00	.7	.045/4.00
6.00	.5	.030/4.00



.075

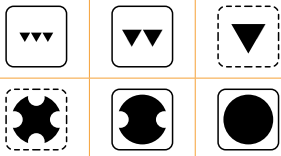
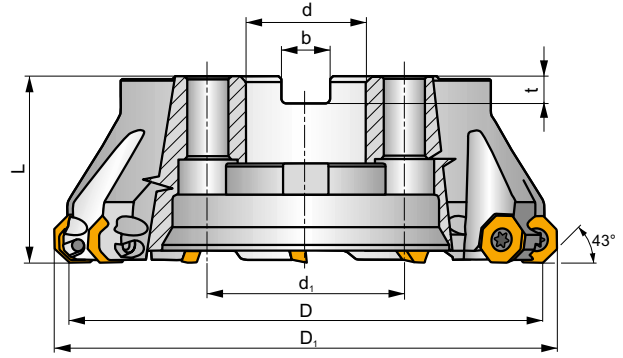
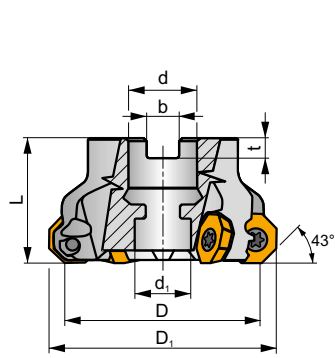
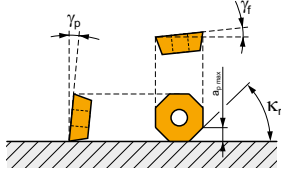
**ISOE06Z**

**P M N S**

**S**



$K_r$	43°
$a_{pmax}$	.130 (.390)



$h_m$  .0024-.0079



ANSI	D	D <sub>1</sub>	L	d	d <sub>1</sub>	b	t	$\gamma_r^\circ$	$\gamma_p^\circ$								
200A04R-IS45OE06Z-C	2.000	2.402	1.575	.750	.630	.321	.193	6	10		✓	10700	✓	.82	IGI283	IFA053	
200A05R-IS45OE06Z-C	2.000	2.394	1.575	.750	.630	.321	.193	1	10		✓	10700	✓	.82	IGI283	IFA053	
250A04R-IS45OE06Z-C	2.500	2.902	1.575	.750	.630	.321	.193	6	10		✓	9600	✓	1.04	IGI283	IFA053	
250A06R-IS45OE06Z-C	2.500	2.894	1.575	.750	.630	.321	.193	1	10		✓	9600	✓	1.10	IGI283	IFA053	
300A05R-IS45OE06Z-C	3.000	3.402	1.969	1.000	.827	.382	.224	6	10		✓	8500	✓	2.18	IGI283	IFA054	
300A06R-IS45OE06Z-C	3.000	3.402	1.969	1.000	.827	.382	.224	6	10		✓	8500	✓	2.25	IGI283	IFA054	
400A06R-IS45OE06Z-C	4.000	4.402	1.969	1.500	1.417	.630	.382	6	10		✓	7600	✓	4.25	IGI283	IFA055	
400A08R-IS45OE06Z-C	4.000	4.390	1.969	1.500	1.417	.630	.382	1	10		✓	7600	✓	4.30	IGI283	IFA055	
500A07R-IS45OE06Z-C	5.000	5.402	2.480	1.500	1.260	.630	.382	6	10		✓	6800	✓	7.72	IGI283	IFA050	
500A09R-IS45OE06Z-C	5.000	5.390	2.480	1.500	1.260	.630	.382	1	10		✓	6800	✓	7.72	IGI283	IFA050	
600A09R-IS45OE06Z-C	6.000	6.402	2.480	2.000	1.654	.756	.445	6	10		✓	6000	✓	12.92	IGI283	IFA056	
600A12R-IS45OE06Z-C	6.000	6.390	2.480	2.000	1.654	.756	.445	1	10		✓	6000	✓	13.03	IGI283	IFA056	
800C11R-IS45OE06Z-C	8.000	8.402	2.480	2.500	4.000	1.000	.559	6	10		✓	5300	✓	18.43	IGI283	IFA057	
800C14R-IS45OE06Z-C	8.000	8.390	2.480	2.500	4.000	1.000	.559	1	10		✓	5300	✓	18.65	IGI283	IFA057	



IGI283



OEHT 0604AE..



REHT 1604M..

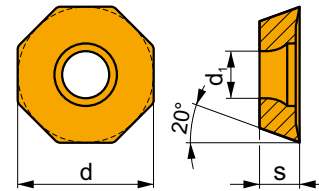


XEHT 0604AE..

IFA050	US 5011-T20P	5.0	M 5	.445	SDR T20P-T	HS 075125	-	-	-
IFA053	US 5011-T20P	5.0	M 5	.445	SDR T20P-T	HS 037100	-	-	-
IFA054	US 5011-T20P	5.0	M 5	.445	SDR T20P-T	HS 050125	-	-	-
IFA055	US 5011-T20P	5.0	M 5	.445	SDR T20P-T	HCS 075200	-	-	-
IFA056	US 5011-T20P	5.0	M 5	.445	SDR T20P-T	HS 100150	CAC 160C	HSD 0825C	HXX 5
IFA057	US 5011-T20P	5.0	M 5	.445	SDR T20P-T	-	CAC 200C	HSD 1025C	HXX 7

## OEHT 06

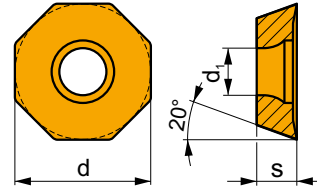
	d	d <sub>1</sub>	s
0604	.632	.217	.187



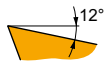
		ANSI		P	M	K	N	S	H			r <sub>c</sub>	f <sub>min</sub>	f <sub>max</sub>	a <sub>p min</sub>	a <sub>p max</sub>
		OEHT 0604AEER-MF	M6330	█	█			█		⊕	-	-	.003	.008	.020	.130
			M8330	█	█		□	□		⊕	-	-	0,08	0,20	0,5	3,3
			M8340	█	█			█		⊕	+/-	-	.003	.008	.020	.130
		OEHT 0604AEER-MM	M9325	█	█			█		⊕	---	-	.003	.008	.020	.130
			M9340	█	█			█		⊕	---	-	.003	.008	.020	.130
			M6330	█	█			█		⊕	-	-	.003	.010	.020	.130
			M8330	█	█		□	□		⊕	-	-	0,08	0,25	0,5	3,3
			M8340	█	█			█		⊕	+/-	-	.003	.010	.020	.130
			M8345	█	█			█		⊕	+/-	-	.003	.010	.020	.130
		OEHT 0604AESR-M	M9325	█	█			█		⊕	---	-	.003	.012	.020	.130
			M9340	█	█			█		⊕	---	-	.003	.012	.020	.130
			M6330	█	█			█		⊕	-	-	.003	.014	.020	.130
			M8310	█	█			█		⊕	-	-	.003	.014	.020	.130
			M8330	█	█		□	□		⊕	-	-	0,08	0,35	0,5	3,3
			M8340	█	█			█		⊕	+/-	-	.003	.014	.020	.130

## OEHT 06-FA

	d	d <sub>1</sub>	s
0604	.632	.217	.187

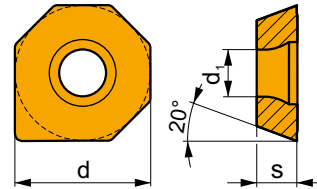


i	ANSI	M0315 HF7	P	M	K	N	S	H	?	+	r <sub>c</sub>	f <sub>min</sub>	f <sub>max</sub>	a <sub>p min</sub>	a <sub>p max</sub>
						■						●	+	-	.003
1	OEHT 0604AEFR-FA	HF7				■			●	+	-	.003	.008	.020	.130
F						■			●	+/-	-	.003	.008	.020	.130

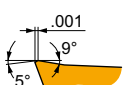


## XEHT 06

	d	d <sub>1</sub>	s
0604	.632	.217	.187



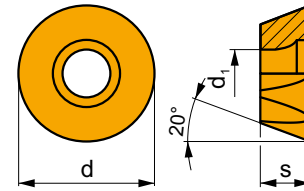
i	ANSI	M8310 M8330	P	M	K	N	S	H	?	-	r <sub>c</sub>	f <sub>min</sub>	f <sub>max</sub>	a <sub>p min</sub>	a <sub>p max</sub>
				□			□					⊛	-	-	.003
W	XEHT 0604AESR	M8310	■	□			□		⊛	-	-	.003	.014	.004	.130
S		M8330	■	□			□		⊛	-	-	.003	.014	.004	.130





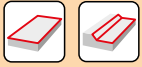
## REHT 16

	d	d <sub>1</sub>	s
1604	.630	.217	.187



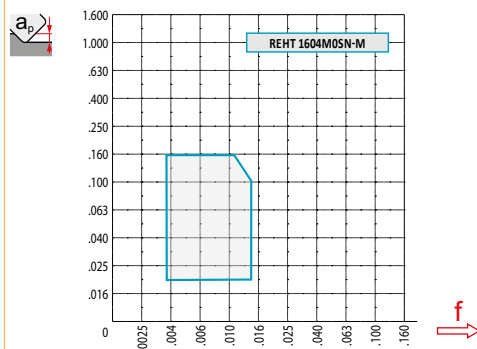
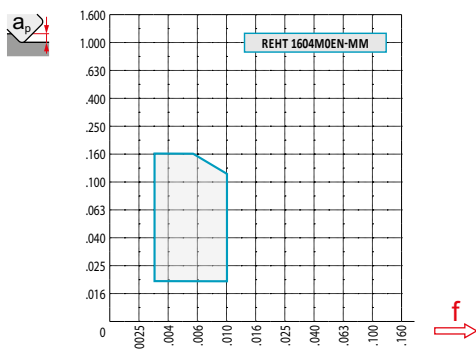
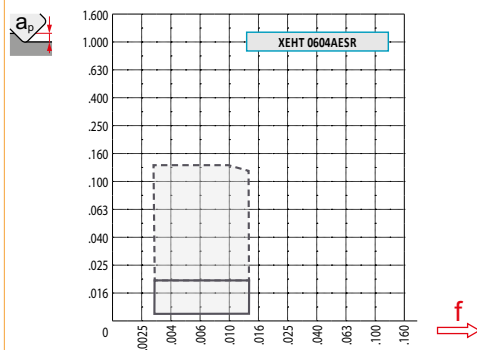
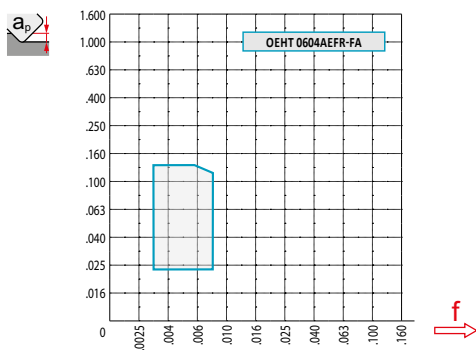
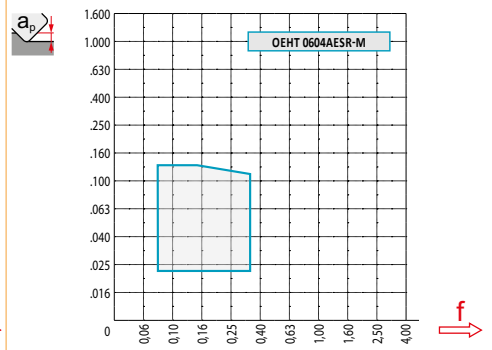
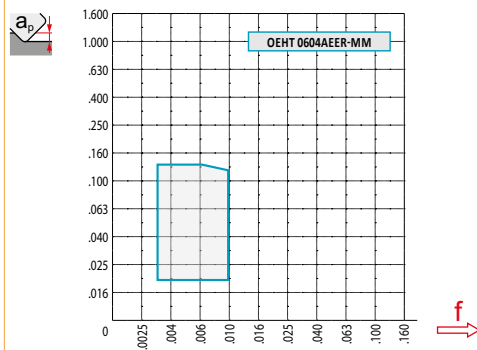
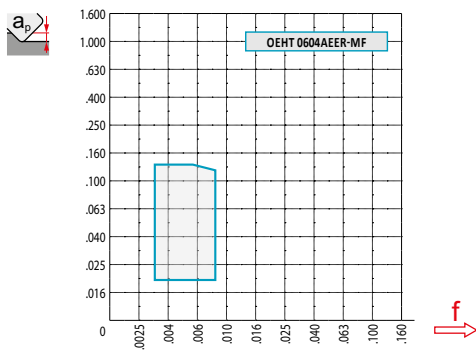
		ANSI		P	M	K	N	S	H			r <sub>c</sub>	f <sub>min</sub>	f <sub>max</sub>	a <sub>p min</sub>	a <sub>p max</sub>
		REHT 1604M0EN-MM	M9325	█	█			█		☹	---	-	.003	.008	.020	.157
		M9340	█	█			█		☹	---	-	.003	.008	.020	.157	
		M6330	█	█			█		☹	-	-	.003	.010	.020	.157	
		M8330	█	█		□	□		☹	-	-	.003	.010	.020	.157	
		M8340	█	█			█		☹	+/-	-	.003	.010	.020	.157	
		M8345	█	█			█		☹	+/-	-	.003	.010	.020	.157	
		REHT 1604M0SN-M	M9325	█	█			█		☹	---	-	.003	.012	.020	.157
		M8310	█	█			█		☹	-	-	.003	.014	.020	.157	
		M8330	█	█			□		☹	-	-	.003	.014	.020	.157	
		M8340	█	█			█		☹	+/-	-	.003	.014	.020	.157	

ISO	f <sub>min</sub>	f <sub>max</sub>	M9325	M9340	M0315	M6330	M8310	M8340	M8345	M8330	HF7	
P	●	.0039	.0118	1414	1224	-	1102	1257	1119	810	1102	-
	☹	.0039	.0098	1276	1086	-	981	1138	981	689	965	-
	✘	.0039	.0059	1119	965	-	863	1017	843	587	827	-
M	●	.0039	.0118	843	725	-	725	758	673	482	656	-
	☹	.0039	.0098	758	656	-	636	673	587	413	587	-
	✘	.0039	.0059	673	568	-	551	604	499	344	499	-
N	●	.0039	.0118	-	-	2618	-	-	-	-	2772	1171
	☹	.0039	.0098	-	-	2343	-	-	-	-	2448	1050
	✘	.0039	.0059	-	-	2051	-	-	-	-	2103	912
S	●	.0039	.0098	413	361	-	361	381	328	243	328	-
	☹	.0039	.0079	381	328	-	312	328	292	207	292	-
	✘	.0039	.0059	328	276	-	276	292	243	174	243	-



$a_e/D$	.05	.10	.15	.20	.25	.30	.40	.50	.60	.70	.75	.80	.90	1.00
	1.48	1.35	1.27	1.22	1.19	1.16	1.11	1.08	1.05	1.03	1.02	1.01	.99	.98
	2.87	2.05	1.69	1.48	1.33	1.23	1.09	.75	.94	.90	.89	.88	.88	1.00
	.64	.64	.64	.64	.64	.65	.65	.67	.68	.71	.72	.74	.79	1.00

	OEHT 06-MF	OEHT 06-MM	OEHT 06-M	OEHT 06-FA	XEHT 06	REHT 16-MM	REHT 16-M
$r_\epsilon$	-	-	-	-	-	.315	.315
$a$	.054	.054	.054	.054	.390	-	-



			.000	.020	.030	.049	.059	.079	.098	.118	.157
2.00	2.396		1.728	1.948	1.994	2.067	2.096	2.145	2.186	2.220	2.274
2.50	2.893		2.240	2.459	2.506	2.578	2.607	2.657	2.698	2.732	2.786
3.00	3.371		2.909	3.129	3.176	3.248	3.277	3.326	3.367	3.401	3.455
3.50	3.881		3.299	3.519	3.565	3.637	3.667	3.716	3.757	3.791	3.845
4.00	4.396		3.697	3.916	3.963	4.035	4.064	4.113	4.154	4.189	4.243
5.00	5.396		4.681	4.900	4.947	5.019	5.048	5.098	5.139	5.173	5.227
6.00	6.371		6.059	6.278	6.325	6.397	6.426	6.476	6.517	6.551	6.605
8.00	8.396		7.634	7.853	7.900	7.972	8.001	8.050	8.091	8.126	8.180



		$f_{max}$
2.00	1.43	.013
2.50	1.47	.015
3.00	1.52	.017
4.00	1.57	.019
5.00	1.62	.020
6.00	1.68	.023
8.00	1.73	.026



		$\alpha_{max}^{\circ}$	$a_p/l$
2.00	2.396	4.9	.30/4.00
2.50	2.893	3.6	.25/4.00
3.00	3.371	2.6	.20/4.00
4.00	4.396	2	.15/4.00
5.00	5.396	1.5	.10/4.00

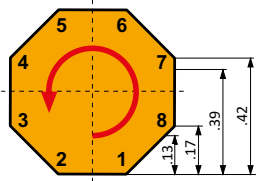


		$d_{min}$	$d_{max}$	$d_{min}^{S_{max}}$	$d_{max}^{S_{max}}$	$d_{min}$	$d_{max}$	$d_{min}^{S_{max}}$	$d_{max}^{S_{max}}$
2.00	2.396	3.602	4.724	.232	.232	3.602	4.705	.232	.232
2.50	2.893	4.622	5.748	.232	.232	4.646	5.728	.232	.232
3.00	3.371	5.961	7.087	.232	.232	5.965	7.067	.232	.232
4.00	4.396	7.535	8.661	.232	.232	7.539	8.642	.232	.232
5.00	5.396	9.500	1.630	.232	.232	9.508	1.610	.232	.232



.122

.118



-> .13	8
-> .17	7
-> .39	4
-> .42	2

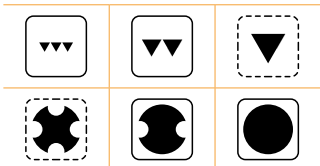
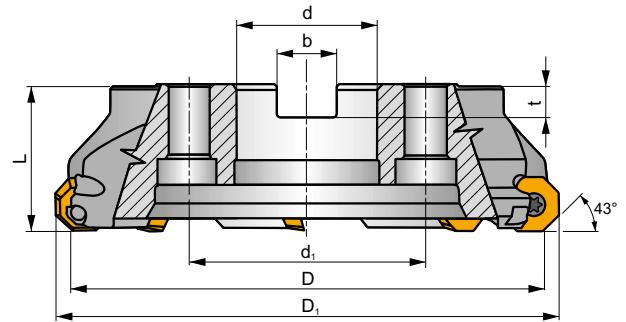
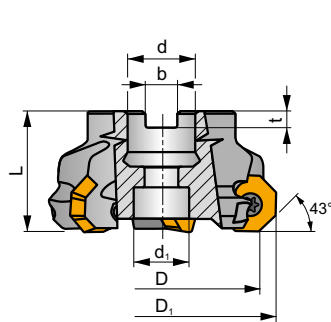
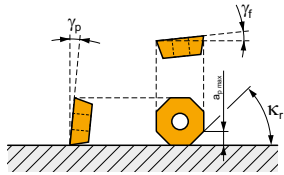
# ISOE09Z

**P** **M** **N** **S**

**S**



$\kappa_r$	43°
$a_{pmax}$	.197 (.555)



$h_m$  .0035-.0098



ANSI	D	D <sub>1</sub>	L	d	d <sub>1</sub>	b	t	$\gamma_r^\circ$	$\gamma_p^\circ$							
<b>300A05R-IS45OE09Z-C</b>	3.000	3.604	1.969	1.000	.827	.382	.224	6	10	5	✓	6100	✓	2.01	IGI293	IFA064
<b>500A05R-IS45OE09Z-C</b>	5.000	5.602	2.480	1.500	1.260	.630	.382	6	10	5	✓	4800	✓	7.87	IGI293	IFA060
<b>500A07R-IS45OE09Z-C</b>	5.000	5.602	2.480	1.500	1.260	.630	.382	6	10	7	✓	4800	✓	7.63	IGI293	IFA060
<b>600A08R-IS45OE09Z-C</b>	6.000	6.602	2.480	2.000	1.654	.756	.445	6	10	8	✓	4300	✓	12.19	IGI293	IFA066
<b>800C10R-IS45OE09Z-C</b>	8.000	8.586	2.480	2.500	4.000	1.000	.559	1	10	10	✓	3800	✓	18.34	IGI293	IFA067
<b>1000C12R-IS45OE09Z-C</b>	10.000	1.586	2.480	2.500	4.000	1.000	.559	1	10	12	✓	3400	✓	32.39	IGI293	IFA068
<b>1200C14R-IS45OE09Z-C</b>	12.000	12.585	3.150	2.500	4.000	1.000	.559	1	10	14	✓	3000	✓	6.67	IGI293	IFA069

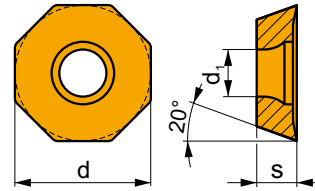


IGI293	OEHT 0906AE..	REHT 2406M..	XEHT 0906AE..

IFA060	US 68020-T30P	15.0	M 8	.780	SDR T30P-T	HS 075125	-	-	-	-	-
IFA064	US 68020-T30P	15.0	M 8	.780	SDR T30P-T	HS 050125	-	-	-	-	-
IFA065	US 68020-T30P	15.0	M 8	.780	SDR T30P-T	HCS 075175	-	-	-	-	-
IFA066	US 68020-T30P	15.0	M 8	.780	SDR T30P-T	HS 100150	CAC 160C	HSD 0825C	HXK 5	-	-
IFA067	US 68020-T30P	15.0	M 8	.780	SDR T30P-T	-	CAC 200C	HSD 1025C	HXK 7	-	-
IFA068	US 68020-T30P	15.0	M 8	.780	SDR T30P-T	-	CAC 250C	HSD 1025C	HXK 7	-	-
IFA069	US 68020-T30P	15.0	M 8	.780	SDR T30P-T	-	CAC 315C	HSD 1035C	HXK 7	CACP 315C	RRH 34

## OEHT 09

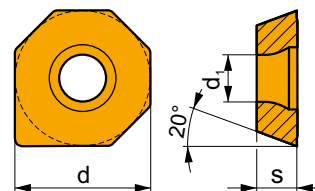
	d	d <sub>1</sub>	s
0906	.949	.339	.281



i	ANSI	Material	P	M	K	N	S	H	Surface	Coating	r <sub>ε</sub>	f <sub>min</sub>	f <sub>max</sub>	a <sub>p min</sub>	a <sub>p max</sub>
  	OEHT 0906AEER-MM	M9325	█	█			█		☉	---	-	.005	.012	.039	.197
	M8330	█	█		□	□			☉	-	-	.005	.014	.039	.197
	M8340	█	█			█			☉	+/-	-	.005	.014	.039	.197
 	OEHT 0906AESR-M	M9325	█	█			█		☉	---	-	.005	.015	.047	.197
	M8310	█	█			█			☉	-	-	.005	.018	.047	.197
	M8330	█	█		□	□			☒	-	-	.005	.018	.047	.197
	M8340	█	█			█			☒	+/-	-	.005	.018	.047	.197

## XEHT 09

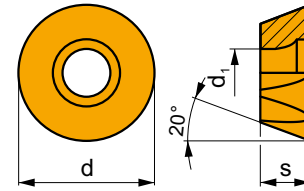
	d	d <sub>1</sub>	s
0906	.949	.339	.281



i	ANSI	Material	P	M	K	N	S	H	Surface	Coating	r <sub>ε</sub>	f <sub>min</sub>	f <sub>max</sub>	a <sub>p min</sub>	a <sub>p max</sub>
  	XEHT 0906AESR	M8310	█	█			█		☉	-	-	.005	.018	.020	.197

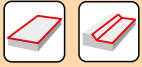
## REHT 24

	d	d <sub>1</sub>	s
2406	.945	.339	.281



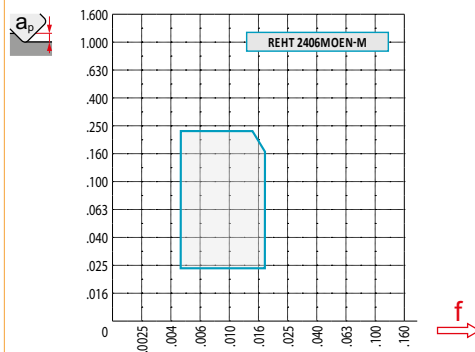
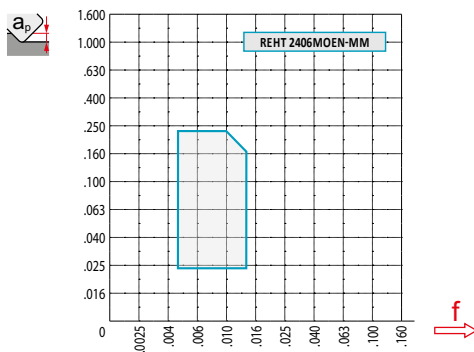
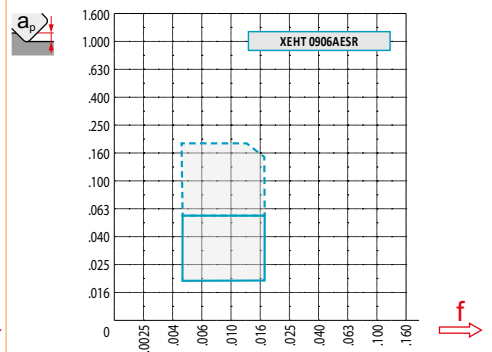
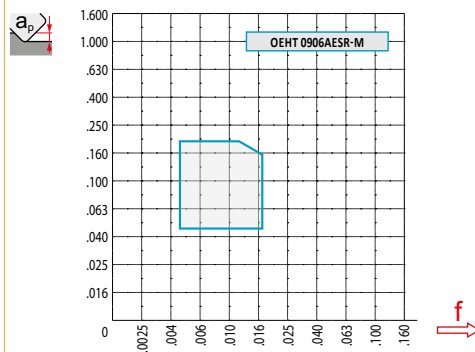
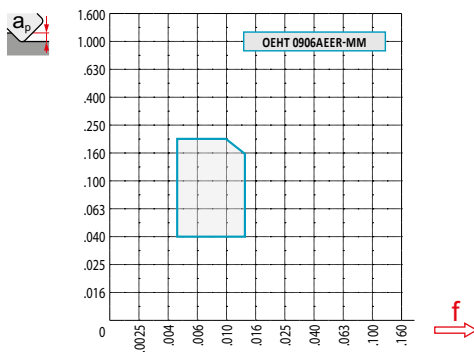
		ANSI		P	M	K	N	S	H			r <sub>c</sub>	f <sub>min</sub>	f <sub>max</sub>	a <sub>p min</sub>	a <sub>p max</sub>
		XEHT	M8310	■	■			■		⚙	-	-	.005	.014	.024	.236
			M8330	■	■		□	□		⚙	-	-	.005	.014	.024	.236
			M8340	■	■			■		✘	+/-	-	.005	.014	.024	.236
		REHT 2406MOSN-M	M9325	■	■			■		✘	---	-	.005	.015	.020	.236
			M8310	■	■			■		✘	-	-	.005	.018	.020	.236
			M8330	■	■		□	□		✘	-	-	.005	.018	.020	.236
			M8340	■	■			■		✘	+/-	-	.005	.018	.020	.236

ISO	f <sub>min</sub>	f <sub>max</sub>	M9325	M8310	M8340	8230	
P	●	.0047	.0157	1414	1257	1119	1102
	⚙	.0047	.0118	1276	1138	981	965
	✘	.0047	.0071	1119	1017	843	827
M	●	.0047	.0118	843	758	673	656
	⚙	.0047	.0098	758	673	587	587
	✘	.0047	.0067	673	604	499	499
N	●	.0047	.0157	-	-	-	2772
	⚙	.0047	.0118	-	-	-	2448
	✘	.0047	.0071	-	-	-	2103
S	●	.0047	.0118	413	381	328	328
	⚙	.0047	.0098	381	328	292	292
	✘	.0047	.0067	328	285	243	243



$a_p/D$	.05	.10	.15	.20	.25	.30	.40	.50	.60	.70	.75	.80	.90	1.00
X.V	1.48	1.35	1.27	1.22	1.19	1.16	1.11	1.08	1.05	1.03	1.02	1.01	.99	.98
X.f	2.87	2.05	1.69	1.48	1.33	1.23	1.09	.75	.94	.90	.89	.88	.88	1.00
X.f	.64	.64	.64	.64	.64	.65	.65	.67	.68	.71	.72	.74	.79	1.00

$r_\epsilon$	OEHT 09-MM	OEHT 09-M	XEHT 09	REHT 24-MM	REHT 24-M
	-	-	-	.472	.472
$a$	.079	.079	.583	-	-



$D$	<b>O</b>	<b>R</b>
	3.00	3.559
	4.00	4.596
	5.00	5.596
	6.00	6.559
	8.00	8.596
	1.00	1.584
	12.00	12.556

$R$	<b>R</b>										
$a_p$	.000	.020	.030	.049	.059	.079	.098	.118	.157	.197	.236
	2.791	3.061	3.120	3.211	3.249	3.314	3.369	3.416	3.496	3.559	3.609
	3.579	3.849	3.907	3.999	4.036	4.101	4.156	4.204	4.283	4.346	4.397
$D_{eff}$	4.563	4.833	4.892	4.983	5.020	5.085	5.140	5.188	5.267	5.330	5.381
	5.941	6.211	6.270	6.361	6.398	6.463	6.518	6.566	6.645	6.708	6.759
	7.516	7.786	7.844	7.936	7.973	8.038	8.093	8.141	8.220	8.283	8.334
	9.472	9.743	9.801	9.893	9.930	9.995	1.050	1.097	1.177	1.240	1.291
	12.031	12.302	12.360	12.452	12.489	12.554	12.609	12.656	12.736	12.799	12.850





		$f_{max}$
3.00	1.44	.020
4.00	1.48	.022
5.00	1.53	.025
6.00	1.58	.028
8.00	1.63	.031
1.00	1.68	.035
12.00	1.74	.040



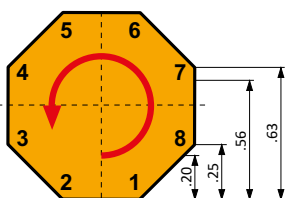
		$\alpha_{max}$	$a_p/l$	$\alpha_{max}$	$a_p/l$	$\alpha_{max}$	$a_p/l$
3.00	3.558	4.9	.33/4.00	5	.35/4.00		
4.00	4.596	3.7	.25/4.00	3.7	.25/4.00		
5.00	5.596	2.8	.20/4.00	2.8	.20/4.00		
6.00	6.559	2.1	.15/4.00	2.1	.15/4.00		
8.00	8.596	1.6	.10/4.00	1.6	.10/4.00		



		$d_{min}$	$d_{max}$	$d_{min}^{S_{max}}$	$d_{max}^{S_{max}}$	$d_{min}$	$d_{max}$	$d_{min}^{S_{max}}$	$d_{max}^{S_{max}}$
3.00	3.559	5.75	7.48	.35	.35	5.75	7.44	.45	.45
4.00	4.596	7.32	9.06	.35	.35	7.32	9.02	.45	.45
5.00	5.596	9.29	11.02	.35	.35	9.29	1.98	.45	.45
6.00	6.559	12.05	13.78	.35	.35	12.05	13.74	.45	.45
8.00	8.596	15.20	16.93	.35	.35	15.20	16.89	.45	.45



$a_p$	$a_p$
.217	.213



$a_p$	
→ .20	8
→ .25	7
→ .56	4
→ .63	2

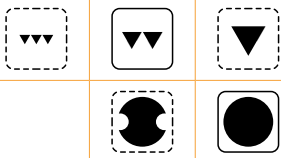
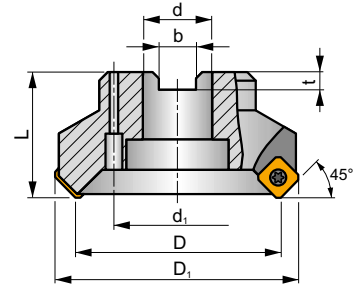
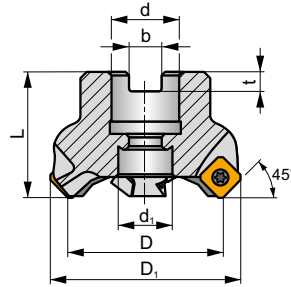
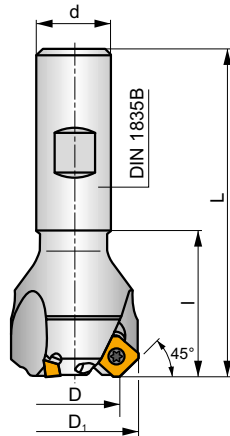
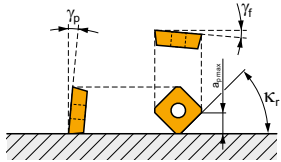
**ISSE09**


**P M K N S**

**S**













$K_r$	45°
$a_{pmax}$	.177






 .0023-.0078



 .0023-.0070

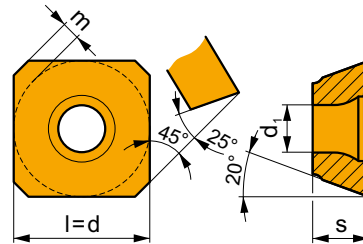
ANSI	D	D <sub>1</sub>	L	d	d <sub>1</sub>	l	b	t	$\gamma_f$	$\gamma_p$							
 075N2R126W075-ISSE09-C	.750	1.136	3.331	.750	-	1.260	-	-	-5	20	2	-	24600	✓	.22	IGI147	IFA010
100N3R128W100-ISSE09-C	1.000	1.386	3.819	1.000	-	1.280	-	-	-5	20	3	-	22000	✓	.66	IGI147	IFA010
125N4R150W125-ISSE09-C	1.250	1.644	4.039	1.250	-	1.500	-	-	-5	20	4	-	19400	✓	1.32	IGI147	IFA010
150A04R-IS45SE09F-C	1.500	1.878	1.575	.500	.433	-	.258	.165	-5	20	4	✓	17400	✓	.75	IGI147	IFA012
200A05R-IS45SE09F-C	2.000	2.378	1.575	.750	.630	-	.321	.193	-5	20	5	✓	15600	✓	.84	IGI147	IFA013
250A05R-IS45SE09F-C	2.500	2.878	1.575	.750	.630	-	.321	.193	-5	20	5	✓	13900	✓	1.19	IGI147	IFA013
250A06R-IS45SE09F-C	2.500	2.878	1.575	.750	.630	-	.321	.193	-5	20	6	✓	13900	✓	1.23	IGI147	IFA013
300A06R-IS45SE09F-C	3.000	3.378	1.969	1.000	.827	-	.382	.224	-5	20	6	✓	12300	✓	2.20	IGI147	IFA014
 300A08R-IS45SE09F-C	3.000	3.378	1.969	1.000	.827	-	.382	.224	-5	20	8	✓	12300	✓	2.43	IGI147	IFA014
400A08R-IS45SE09F-C	4.000	4.394	1.969	1.500	1.260	-	.630	.382	-5	20	8	✓	11000	✓	3.04	IGI147	IFA015
400A10R-IS45SE09F-C	4.000	4.394	1.969	1.500	1.260	-	.630	.382	-5	20	10	✓	10900	✓	3.37	IGI147	IFA015
500A09R-IS45SE09F-C	5.000	5.374	2.480	1.500	1.260	-	.630	.382	-5	20	9	✓	9800	✓	6.02	IGI147	IFA019
500A12R-IS45SE09F-C	5.000	5.374	2.480	1.500	1.260	-	.630	.382	-5	20	12	✓	9800	✓	6.88	IGI147	IFA019
600B10R-IS45SE09F	6.000	6.378	2.480	2.000	3.465	-	.756	.445	-5	20	10	✓	8700	-	1.43	IGI147	IFA011
600B14R-IS45SE09F	6.000	6.378	2.480	2.000	3.465	-	.756	.445	-5	20	14	✓	8700	-	11.24	IGI147	IFA011

		
IGI147	SEET 09T3AF.	SEMT 09T3AF.

IFA010	US 3007-T09P	2.0	M 3	.280	-	-	Flag T09P	-
IFA011	US 3007-T09P	2.0	M 3	.280	D-T07P/T09P	FG-15	-	-
IFA012	US 3007-T09P	2.0	M 3	.280	D-T07P/T09P	FG-15	-	HS 025100
IFA013	US 3007-T09P	2.0	M 3	.280	D-T07P/T09P	FG-15	-	HS 037100
IFA014	US 3007-T09P	2.0	M 3	.280	D-T07P/T09P	FG-15	-	HS 050125
IFA015	US 3007-T09P	2.0	M 3	.280	D-T07P/T09P	FG-15	-	HCS 075200
IFA019	US 3007-T09P	2.0	M 3	.280	D-T07P/T09P	FG-15	-	HS 075125

## SEET 09

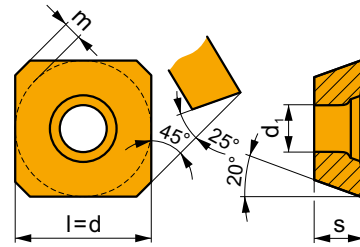
	d	d <sub>1</sub>	l	m	s
09T3	.375	.138	.375	.048	.156



		ANSI		P	M	K	N	S	H			r <sub>ε</sub>	f <sub>min</sub>	f <sub>max</sub>	a <sub>p min</sub>	a <sub>p max</sub>
		SEET 09T3AFEN	M9325	■	▣				▣	●	---	-	.003	.010	.012	.177
			M9340	▣	■				■	●	---	-	.003	.010	.012	.177
			M6330	▣	■				■	●	-	-	.003	.012	.012	.177
			M8330	■	▣		□	□		●	-	-	.003	.012	.012	.177
			M8340	■	■				■	●	+/-	-	.003	.012	.012	.177
			8215	■	▣		▣	▣		●	-	-	.003	.012	.012	.177

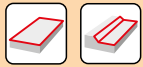
## SEMT 09

	d	d <sub>1</sub>	l	m	s
09T3	.375	.138	.375	.048	.156



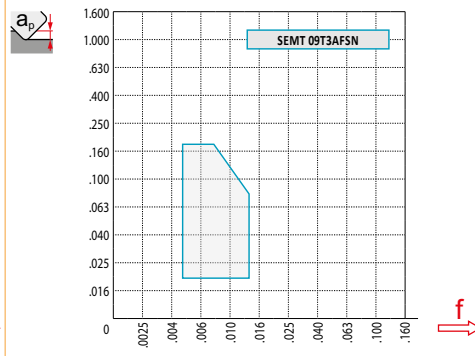
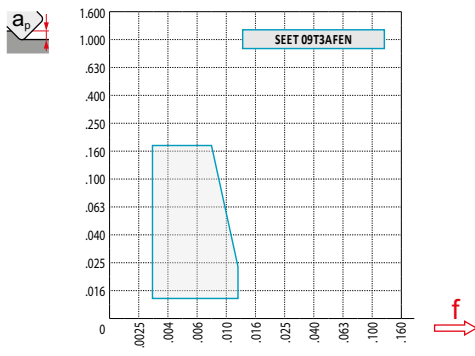
i	ANSI	M9325	P	M	K	N	S	H	?	r <sub>ε</sub>	f <sub>min</sub>	f <sub>max</sub>	a <sub>p min</sub>	a <sub>p max</sub>	
															SEMT 09T3AFSN
	M9325	●	■						●	---	---	.005	.010	.020	.177
	M9340	■	■						●	---	---	.005	.010	.020	.177
	M8330	●	■	■	□	□			●	-	-	.005	.014	.020	.177
	M8340	■	■	■		□			●	+/-	-	.005	.014	.020	.177
	8215	■	■	■	□	□			●	-	-	.005	.014	.020	.177

ISO	f <sub>min</sub>	f <sub>max</sub>	M9325	M9340	M6330	M8340	8215	M8330	
P	●	.0039	.0118	1280	1106	997	1014	1093	997
	●	.0039	.0098	1155	981	889	889	951	873
	✱	.0039	.0059	1014	873	781	764	810	748
M	●	.0039	.0098	764	656	656	607	656	594
	●	.0039	.0079	686	594	577	531	561	531
	✱	.0039	.0059	607	515	499	453	482	453
K	●	.0039	.0118	-	-	-	951	1030	951
	●	.0039	.0098	-	-	-	843	906	827
	✱	.0039	.0059	-	-	-	732	764	719
N	●	.0039	.0118	-	-	-	-	2743	2510
	●	.0039	.0098	-	-	-	-	2385	2215
	✱	.0039	.0059	-	-	-	-	2041	1903
S	●	.0039	.0098	374	328	328	295	328	295
	●	.0039	.0079	344	295	282	266	282	266
	✱	.0039	.0059	295	249	249	220	233	220



$a_p/D$	.05	.10	.15	.20	.25	.30	.40	.50	.60	.70	.75	.80	.90	1.00
	1.48	1.35	1.27	1.22	1.19	1.16	1.11	1.08	1.05	1.03	1.00	1.00	1.00	1.00
	2.87	2.05	1.69	1.48	1.33	1.23	1.09	.75	.94	.90	.89	.88	.88	1.00
	.64	.64	.64	.64	.64	.65	.65	.67	.68	.71	.72	.74	.79	1.00

	SEET 09	SEMT 09
	-	-
	.050	.049



$D$	$X.V$	$f_{max}$
.75	1.20	.007
1.00	1.24	.008
1.25	1.29	.009
1.50	1.33	.010
2.00	1.37	.011
2.50	1.41	.013
3.00	1.46	.014
4.00	1.50	.016
5.00	1.55	.018
6.00	1.60	.020

**ISPN13**

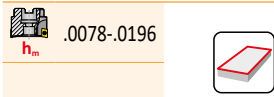
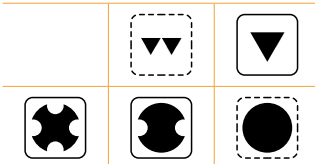
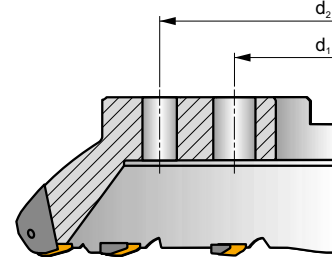
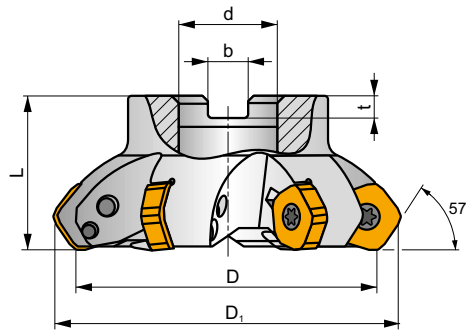
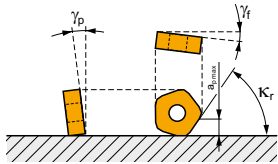
**P M K**   **S H**

**S**

**PENTA HD**



$K_r$	57°
$a_{pmax}$	.394



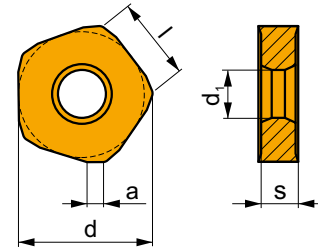
ANSI	D	D <sub>1</sub>	L	d	d <sub>1</sub>	d <sub>2</sub>	b	t	$\gamma_r^\circ$	$\gamma_f^\circ$							
<b>400A05R-IS57PN13</b>	4.000	4.629	1.969	1.500	-	-	.630	.382	-8.2	-4	5	-	3400	-	2.62	IGI261	IFA085
<b>500B06R-IS57PN13</b>	5.000	5.629	2.480	1.500	2.205	-	.630	.382	-7	-4	6	-	3100	-	5.03	IGI261	IFA081
<b>600B08R-IS57PN13</b>	6.000	6.628	2.480	2.000	3.465	-	.756	.445	-6	-4	8	-	2700	-	7.03	IGI261	IFA081
<b>800C10R-IS57PN13</b>	8.000	8.627	2.480	2.500	4.000	-	1.000	.559	-5	-4	10	-	2400	-	14.73	IGI261	IFA081
<b>1000C12R-IS57PN13</b>	10.000	1.627	2.480	2.500	4.000	-	1.000	.559	-5	-4	12	-	2200	-	27.54	IGI261	IFA081
<b>1200C14R-IS57PN13</b>	12.000	1.627	3.150	2.500	4.000	7.000	1.000	.559	-5	-4	14	-	1900	-	45.50	IGI261	IFA081

IGI261	PNMU 1308DN..	PNMQ 1308DN..

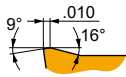
IFA081	SPN 13T3DN	US 64010-T15P	SDR T15P	US 68026-T30P	15.0	M 8	1.020	SDR T30P-T
IFA085	SPN 13T3DN	US 64010-T15P	SDR T15P	US 68026-T30P	15.0	M 8	1.020	SDR T30P-T

## PNMU 13

	a	d	d <sub>1</sub>	l	s
1308	.118	.961	.394	.512	.313

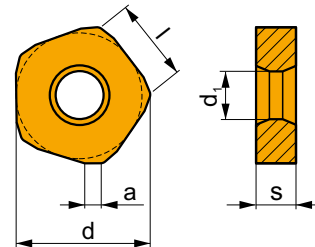


i	ANSI	M9315	M9340	M8330	M8345	8215	?	r <sub>c</sub>	f <sub>min</sub>	f <sub>max</sub>	a <sub>p min</sub>	a <sub>p max</sub>	
													P
	PNMU 1308DNSR-M												
		■	■	■	■	■	■	---	-	.010	.024	.020	.394
		■	■	■	■	■	■	---	-	.010	.024	.020	.394
		■	■	■	■	■	■	-	-	.010	.028	.020	.394
		■	■	■	■	■	■	+/-	-	.010	.028	.020	.394
		■	■	■	■	■	■	-	-	.010	.028	.020	.394

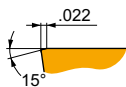


## PNMQ 13

	a	d	d <sub>1</sub>	l	s
1308	.118	.961	.394	.512	.313

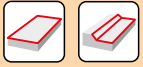


i	ANSI	M9315	M8330	M8345	?	r <sub>c</sub>	f <sub>min</sub>	f <sub>max</sub>	a <sub>p min</sub>	a <sub>p max</sub>		
											P	M
	PNMQ 1308DNSN											
		□	■	■	■	■	---	-	.012	.024	.020	.394
		■	■	■	■	■	-	-	.012	.028	.020	.394
		□	■	■	■	■	+/-	-	.012	.028	.020	.394



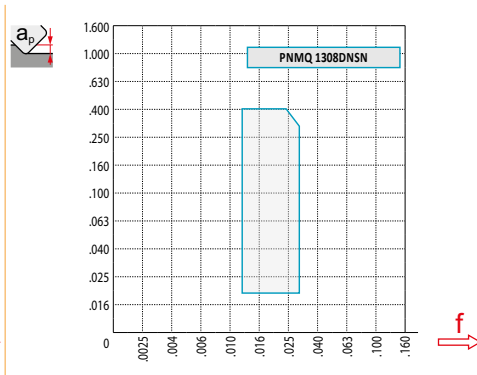
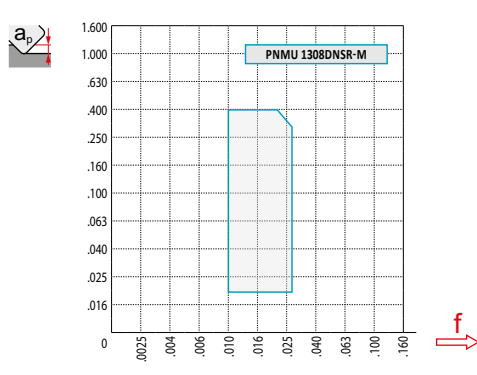
ISO		$f_{\min}$	$f_{\max}$	M9315	M9340	M8345	8215	M8330
P	●	.0098	.0197	1535	1283	850	1263	1155
	●	.0098	.0157	1407	1138	722	1102	1010
	✘	.0098	.0118	1263	1010	614	938	866
M	●	.0098	.0197	-	758	505	758	686
	●	.0098	.0157	-	686	433	650	614
	✘	.0098	.0118	-	597	361	561	525
K	●	.0098	.0197	1463	-	-	1191	1102
	●	.0098	.0157	1335	-	-	1047	958
	✘	.0098	.0118	1211	-	-	886	830
S	●	.0098	.0177	-	381	253	381	344
	●	.0098	.0157	-	344	217	325	308
	✘	.0098	.0118	-	289	180	272	253
H	●	.0079	.0138	308	-	-	253	217
	●	.0079	.0118	272	-	-	217	200
	✘	.0079	.0098	253	-	-	180	164



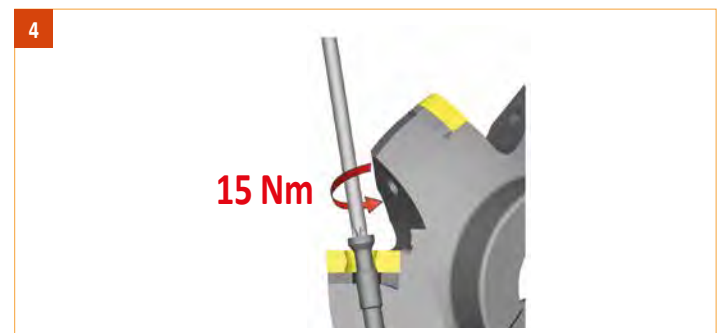
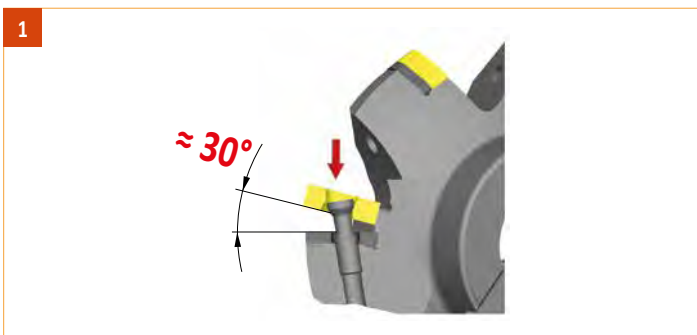


$a_p/D$	.05	.10	.15	.20	.25	.30	.40	.50	.60	.70	.75	.80	.90	1.00
	1.48	1.35	1.27	1.22	1.19	1.16	1.11	1.08	1.05	1.03	1.00	1.00	1.00	1.00
	2.87	2.05	1.69	1.48	1.33	1.23	1.09	.75	.94	.90	.89	.88	.88	1.00
	.64	.64	.64	.64	.64	.65	.65	.67	.68	.71	.72	.74	.79	1.00

	PNMU 13-M	PNMQ 13
	-	-
	.118	.118



# i



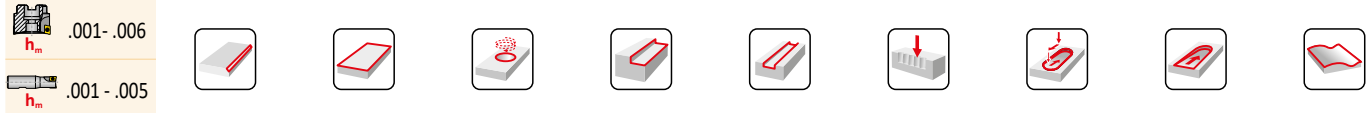
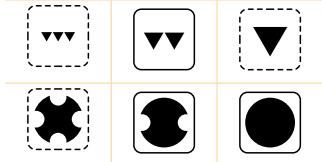
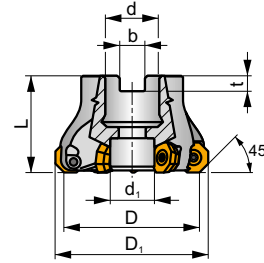
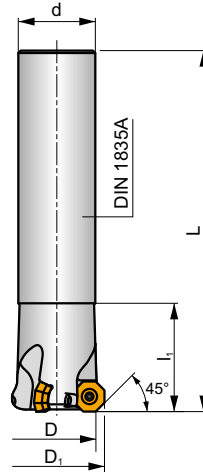
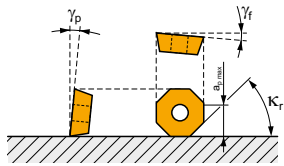
**ISOD05**

**P M K N S**

**S**



$\kappa_r$	45°
$a_{pmax}$	.118 (.394)



ISO	D	D <sub>1</sub>	L	d	d <sub>1</sub>	l <sub>1</sub>	κ <sub>r</sub>	b	t	γ <sub>r</sub> °	γ <sub>p</sub> °								
125N3R177C100-ISOD05-C	0.961	1.250	5.000	1.000	-	1.772	45°	-	-	-10	8	3	-	17700		0.904	GI326	FA049	-
150N3R177C125-ISOD05-C	1.209	1.500	6.000	1.250	-	1.772	45°	-	-	-7	8	3	-	15800		1.830	GI326	FA040	-
200A04R-IS45OD05-C	1.709	2.000	1.575	.750	.630	-	45°	.321	.193	-7	8	4	-	14100		0.353	GI326	IFA043	-
200A05R-IS45OD05-C	1.709	2.000	1.575	.750	.630	-	45°	.321	.193	-7	8	5	-	14100		0.529	GI326	IFA043	-
250A05R-IS45OD05-C	2.209	2.500	1.575	.750	.630	-	45°	.321	.193	-7	8	5	-	12600		0.551	GI326	IFA043	-
250A06R-IS45OD05-C	2.209	2.500	1.575	.750	.630	-	45°	.321	.193	-7	8	6	-	12600		0.794	GI326	IFA043	-
300A06R-IS45OD05-C	2.709	3.000	1.969	1.000	.827	-	45°	.382	.224	-7	8	6	-	11100		0.794	GI326	IFA044	-
300A08R-IS45OD05-C	2.709	3.000	1.969	1.000	.827	-	45°	.382	.224	-7	8	8	-	11100		1.367	GI326	IFA044	AC001
400A07R-IS45OD05-C	3.709	4.000	1.969	1.500	1.417	-	45°	.630	.382	-7	8	7	-	10000		1.433	GI326	IFA045	AC001
500A08R-IS45OD05-C	4.709	5.000	2.480	1.500	1.260	-	45°	.630	.382	-7	8	8	-	8900		2.337	GI326	IFA046	AC002

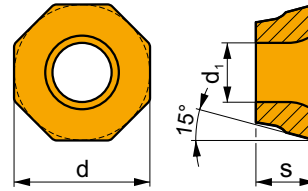
GI326	OD.. 0505..	RD.. 1205..	SDKT 1205..	SDMT 1205..SN

FA040	US 45014-T20P	5	M 5	.512	Flag T20P	-	-
FA041	US 45014-T20P	5	M 5	.512	-	SDR T20P-T	-
FA042	US 45014-T20P	5	M 5	.512	-	SDR T20P-T	HS 90835
FA043	US 45014-T20P	5	M 5	.512	-	SDR T20P-T	HS 1030C
FA049	US 45011-T20P	5	M 5	.433	Flag T20P	-	-

AC001	KS 1230	K.FMH27
AC002	KS 1635	K.FMH32
AC003	KS 2040	K.FMH40

### ODKT 05IM

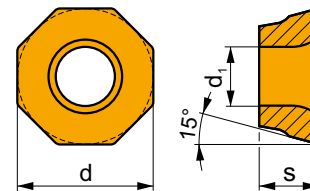
	d	d <sub>1</sub>	s
0505	.500	.217	.219



		ISO		P	M	K	N	S	H			r <sub>e</sub>	f <sub>min</sub>	f <sub>max</sub>	a <sub>p min</sub>	a <sub>p max</sub>
		ODKT 0505ADFR-F	M8310	■	▣			□		●	-	.031	.002	.010	.008	.106
		ODKT 0505ADSR-FM	M9340	▣	■			□		●	---	.031	.007	.010	.012	.106
			M8310	■	▣	▣		□		●	-	.031	.007	.014	.012	.106
			M8345	■	▣	▣		□		●	+/-	.031	.007	.014	.012	.106
			M8330	■	▣	▣		□		●	-	.031	.007	.014	.012	.106

### ODMT 05IM

	d	d <sub>1</sub>	s
0505	.500	.217	.219

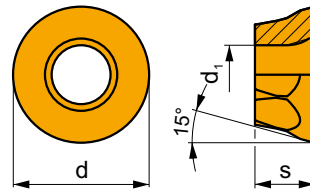


		ISO		P	M	K	N	S	H			r <sub>e</sub>	f <sub>min</sub>	f <sub>max</sub>	a <sub>p min</sub>	a <sub>p max</sub>
		ODMT 0505ADSR-FM	M9340	▣	■			□		●	---	.031	.007	.010	.012	.118
			M8340	■	▣	▣		□		●	+/-	.031	.007	.014	.012	.118

		ISO		P	M	K	N	S	H			$r_e$	$f_{min}$	$f_{max}$	$a_{p min}$	$a_{p max}$
		ODMT 050508SN-R	M9340	<input checked="" type="checkbox"/>						<input checked="" type="checkbox"/>	---	.031	.009	.013	.012	.118
			M8330	<input checked="" type="checkbox"/>		<input checked="" type="checkbox"/>				<input checked="" type="checkbox"/>	-	.031	.009	.018	.012	.118

## RDGT 12IM

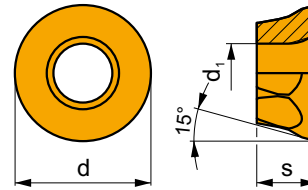
	d	$d_1$	s
1205	.500	.217	.219



		ISO		P	M	K	N	S	H			$r_e$	$f_{min}$	$f_{max}$	$a_{p min}$	$a_{p max}$
		RDGT 120500FN-F	M8310	<input checked="" type="checkbox"/>	<input checked="" type="checkbox"/>			<input type="checkbox"/>		<input checked="" type="checkbox"/>	-	-	.002	.010	.008	.236
		RDGT 120500SN-FM	M8345	<input checked="" type="checkbox"/>	<input checked="" type="checkbox"/>			<input type="checkbox"/>		<input checked="" type="checkbox"/>	+/-	-	.005	.014	.008	.236
			M8330	<input checked="" type="checkbox"/>	<input checked="" type="checkbox"/>	<input checked="" type="checkbox"/>		<input type="checkbox"/>		<input checked="" type="checkbox"/>	-	-	.005	.014	.008	.236

## RDMT 12IM

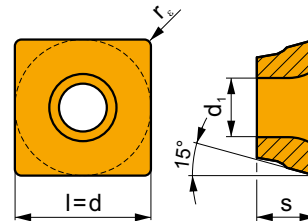
	d	d <sub>i</sub>	s
1205	.500	.217	.219



		ISO		P	M	K	N	S	H			r <sub>e</sub>	f <sub>min</sub>	f <sub>max</sub>	a <sub>p min</sub>	a <sub>p max</sub>	
  		RDMT 120500SN-R	M9340	■							---	-	.007	.013	.012	.236	
			M8340	■		■						+/-	-	.007	.018	.012	.236
			M8330	■	■				□			---	-	.007	.018	.012	.236

## SDKT 12IM

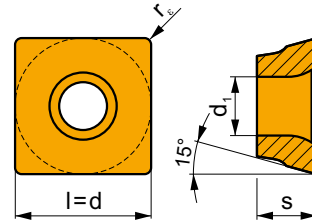
	d	d <sub>i</sub>	l	s
1205	.500	.217	.500	.219



		ISO		P	M	K	N	S	H			r <sub>e</sub>	f <sub>min</sub>	f <sub>max</sub>	a <sub>p min</sub>	a <sub>p max</sub>
 		SDKT 1205PDFR-F	8215	■	■		■	□			-	.031	.002	.010	.008	.394
			SDKT 1205PDSR-FM	M8345	■	■			□			+/-	.031	.006	.014	.008
   			M8330	■	■	■		□			-	.031	.006	.014	.008	.394
			SDKT 1205AESN-FM	M8345	■	■			□			+/-	-	.006	.014	.008
			M8330	■	■	■		□			-	-	.006	.014	.008	.394

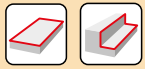
# SDMT 12IM

	d	d <sub>1</sub>	l	s
1205	.500	.217	0.500	0.219



		ISO		P	M	K	N	S	H			r <sub>c</sub>	f <sub>min</sub>	f <sub>max</sub>	a <sub>p min</sub>	a <sub>p max</sub>
		SDMT 120508SN-F	M8310	■	▣			□			-	.031	.006	.012	.012	.394
				M8330	■	▣		□	□		-	.031	.006	.012	.012	.394
		SDMT 120508SN-FM	M8345	■	▣			□			+/-	.031	.006	.014	.012	.394
		SDMT 120508SN-R	M9340	▣							---	.031	.007	.013	.012	.394
				M8345	■						+/-	.031	.007	.018	.012	.394
		SDMT 1205AESN-R	M8340	■		■					-	.031	.007	.018	.012	.394
				M8330	■	■					+/-	-	.007	.018	.012	.394
		SDMT 1205AESN-R	M8340	■		■					-	-	.007	.018	.012	.394
				M8330	■	■					-	-	.007	.018	.012	.394

ISO	f <sub>min</sub>	f <sub>max</sub>	M9340	M8310	M8340	M8345	8215	M8330	
P	●	.003	.012	1050	1079	961	696	1033	945
	●	.003	.010	932	974	843	591	902	827
	✘	.003	.006	827	873	725	502	768	709
M	●	.003	.010	620	650	577	413	620	561
	●	.003	.008	561	577	502	354	531	502
	✘	.003	.006	489	518	430	295	459	430
K	●	.003	.012	-	1020	902	-	974	902
	●	.003	.010	-	932	797	-	856	784
	✘	.003	.006	-	827	696	-	725	679
N	●	.003	.012	-	-	-	-	2598	2379
	●	.003	.010	-	-	-	-	2260	2096
	✘	.003	.006	-	-	-	-	1936	1801
S	●	.003	.010	312	325	282	207	312	282
	●	.003	.008	282	282	253	177	266	253
	✘	.003	.006	236	253	207	148	223	207

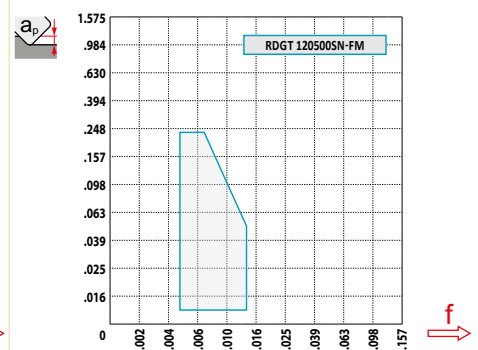
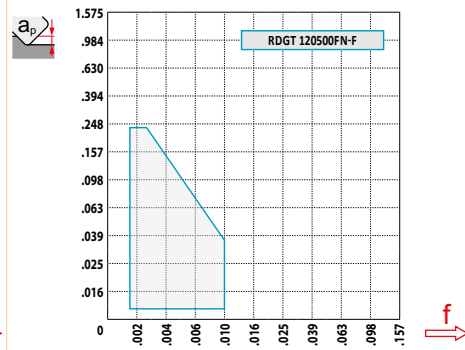
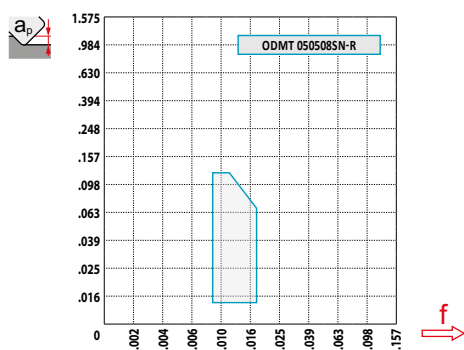
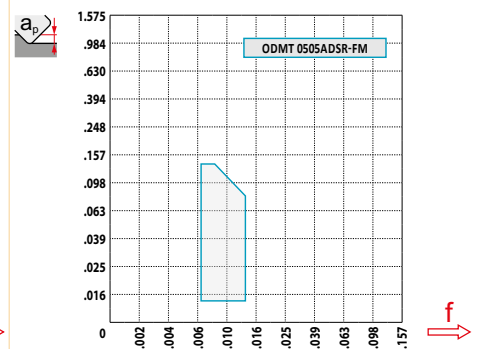
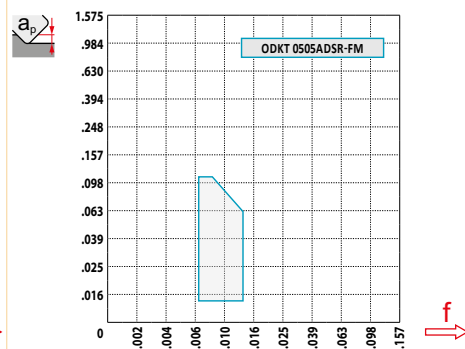
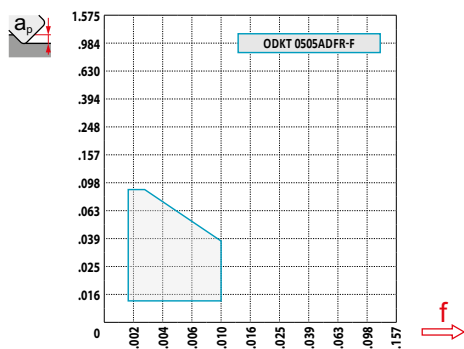


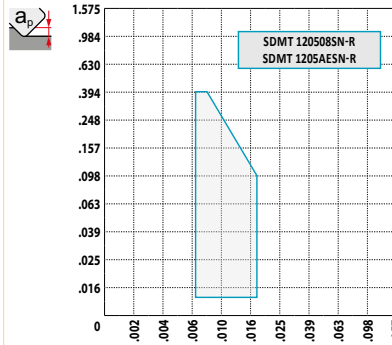
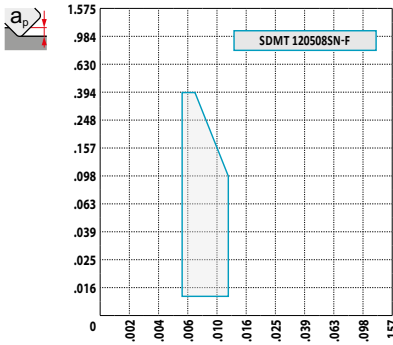
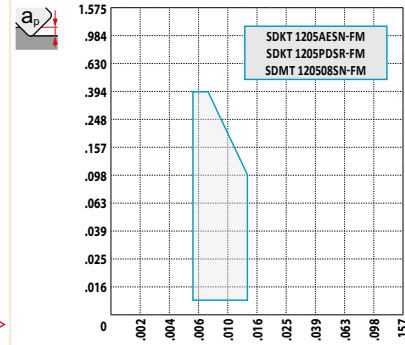
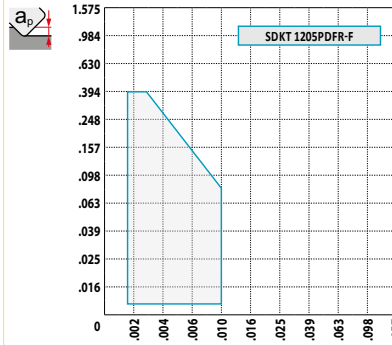
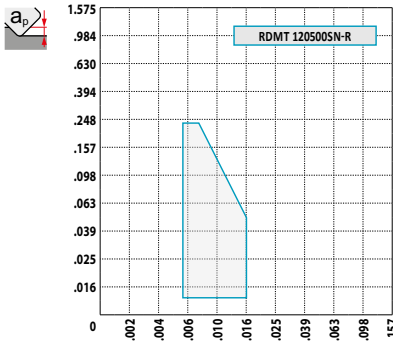
$a_p/D$	0.05	0.10	0.15	0.20	0.25	0.30	0.40	0.50	0.60	0.70	0.75	0.80	0.90	1.00
$X.V$	1.48	1.35	1.27	1.22	1.19	1.16	1.11	1.08	1.05	1.03	1.00	1.00	1.00	1.00
$X.f$	2.87	2.05	1.69	1.48	1.33	1.23	1.09	0.75	0.94	0.90	0.89	0.88	0.88	1.00
$X.f$	0.64	0.64	0.64	0.64	0.64	0.65	0.65	0.67	0.68	0.71	0.72	0.74	0.79	1.00

	ODKT 05-F	ODKT 05-FM	ODMT 05-FM	ODMT 05-R
$r_\epsilon$	.016	.031	.031	.031
$a$	.039	.039	-	-

	RDGT 12-F	RDGT 12-FM	RDGT 12-R
$r_\epsilon$	.250	.250	.250
$a$	-	-	-

	SDKT 12-F	SDKT 12-FM	SDMT 12-F	SDMT 12-R
$r_\epsilon$	.031	.031	.031	.031
$a$	.091	.091	-	-





	0.010	0.020	0.024	0.028	0.031	0.039	0.049	0.059	0.079	0.118	0.157	0.197	0.236
32	0.922	0.976	0.993	1.009	1.023	1.048	1.076	1.100	1.139	1.196	1.233	1.253	1.260
40	1.237	1.291	1.308	1.324	1.338	1.363	1.391	1.415	1.454	1.511	1.548	1.568	1.575
50	1.631	1.685	1.702	1.717	1.732	1.757	1.785	1.809	1.848	1.905	1.941	1.962	1.969
63	2.143	2.197	2.214	2.229	2.244	2.269	2.296	2.320	2.360	2.417	2.453	2.474	2.480
80	2.812	2.866	2.883	2.898	2.913	2.938	2.966	2.990	3.029	3.086	3.122	3.143	3.150
100	3.600	3.654	3.670	3.686	3.700	3.726	3.753	3.777	3.817	3.874	3.910	3.930	3.937
125	4.584	4.638	4.655	4.670	4.685	4.710	4.737	4.761	4.801	4.858	4.894	4.915	4.921



1.250	1.36	.011
1.500	1.40	.012
2.000	1.43	.013
2.500	1.47	.015
3.000	1.52	.017
4.000	1.57	.019
5.000	1.62	.020



10.0





S



.039    .197    .394



.014    .008    .006



O

$\alpha_{max}^\circ$      $a_p/l$

R

$\alpha_{max}^\circ$      $a_p/l$

2.000	4.1	.278/3.94	3.8	.244/3.74
2.500	2.7	.181/3.94	2.5	.167/3.94
3.000	1.8	.118/3.94	1.7	.112/3.94
4.000	1.7	.112/3.94	1.6	.104/3.94
5.000	0.7	.043/3.94	0.3	.016/3.94



O

$d_{min}$      $d_{max}$      $\frac{J_{S_{max}}}{D_{max}}$      $\frac{J_{S_{max}}}{d_{max}}$

R

$d_{min}$      $d_{max}$      $\frac{J_{S_{max}}}{D_{max}}$      $\frac{J_{S_{max}}}{d_{max}}$

2.000	3.071	3.937	0.177	0.177	3.071	3.937	0.177	0.177
2.000	3.071	3.937	0.177	0.177	3.071	3.937	0.177	0.177
2.500	4.134	4.961	0.177	0.177	4.134	4.961	0.177	0.177
2.500	4.134	4.961	0.177	0.177	4.134	4.961	0.177	0.177
3.000	5.433	6.299	0.177	0.177	5.433	6.299	0.177	0.177
3.000	5.433	6.299	0.177	0.177	5.433	6.299	0.177	0.177
4.000	7.008	7.874	0.177	0.177	7.008	7.874	0.177	0.177
5.000	9.016	9.843	0.157	0.177	9.055	9.843	0.157	0.177



O

R



.094    .091



	$\mu\text{m}$	3	5	10	15	20	30	40	50	60	80	100
1.500		0.024	0.031	0.045	0.055	0.063	0.077	0.089	0.100	0.109	0.126	0.141
1.750		0.027	0.035	0.050	0.061	0.070	0.086	0.100	0.111	0.122	0.141	0.157
2.000		0.031	0.039	0.056	0.068	0.079	0.096	0.111	0.124	0.136	0.157	0.176
2.500		0.034	0.044	0.062	0.077	0.088	0.108	0.125	0.140	0.153	0.177	0.198
3.000		0.039	0.050	0.070	0.086	0.100	0.122	0.141	0.157	0.173	0.199	0.223
4.000		0.043	0.056	0.079	0.096	0.111	0.136	0.157	0.176	0.193	0.223	0.249
5.000		0.048	0.062	0.088	0.108	0.124	0.152	0.176	0.197	0.216	0.249	0.278
	$\mu\text{m}$	3	5	10	15	20	30	40	50	60	80	100
.236		0.015	0.019	0.027	0.033	0.039	0.047	0.055	0.061	0.067	0.077	0.086

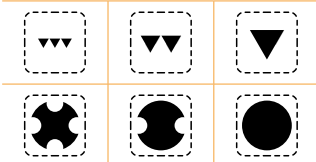
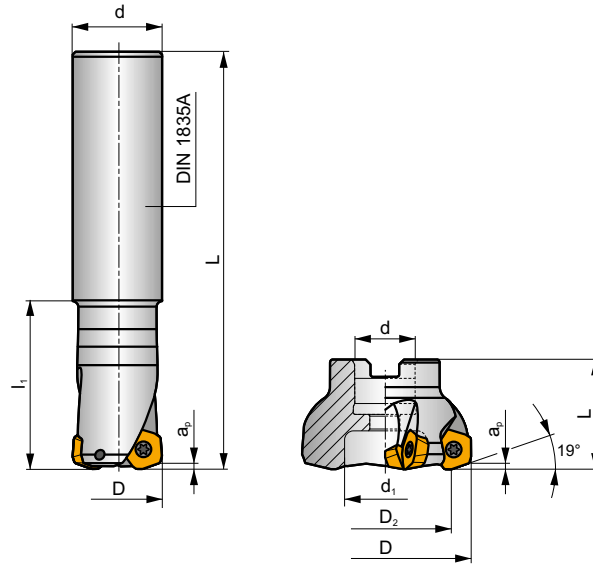
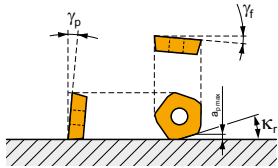
	ODKT 05	ODMT 05
	  -> .106 8 -> .134 7 -> .299 4 -> .335 2	
		  -> .118 8 -> .335 4

**ISPD09**

**P M K N S H**



$K_r$	19°
$a_{pmax}$	.079



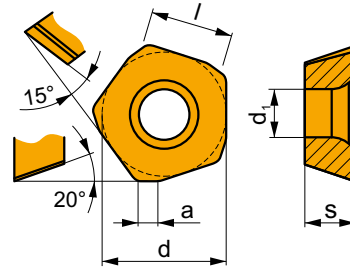
ANSI	D	D <sub>2</sub>	L	d	d <sub>1</sub>	l <sub>1</sub>	$\gamma_r^\circ$	$\gamma_p^\circ$							
<b>125E2R236C125-ISPD09-C</b>	1.250	-	9.843	1.250	-	2.362	-24	10	2	-	13100	✓	3.13	IGI245	ICO340
<b>150E3R236C125-ISPD09-C</b>	1.500	-	9.843	1.250	-	2.362	-11	10	3	-	11700	✓	3.31	IGI245	ICO340
<b>200A04R-IS19PD09-C</b>	2.000	1.433	1.575	.750	.630	-	-3	10	4	-	10500	✓	.51	IGI245	ICO343
<b>250A05R-IS19PD09-C</b>	2.500	1.931	1.575	.750	.630	-	-1	10	5	-	9400	✓	.68	IGI245	ICO343
<b>300A05R-IS19PD09-C</b>	3.000	2.432	1.969	1.000	.827	-	-1	10	5	-	8300	✓	1.83	IGI245	ICO344
<b>400A06R-IS19PD09-C</b>	4.000	3.431	1.969	1.500	1.417	-	-1	10	6	-	7400	✓	3.09	IGI245	ICO345
<b>400A08R-IS19PD09-C</b>	4.000	3.431	1.969	1.500	1.417	-	-1	10	8	-	7400	✓	3.04	IGI245	ICO345

IGI245	PD.X 0905ZE..	PDKT 0905..	PDMW 0905..

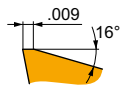
ICO340	US 45011-T20P	5	M 5	.430	-	-	Flag T20P
ICO343	US 45011-T20P	5	M 5	.430	SDR T20P-T	HS 037100	-
ICO344	US 45011-T20P	5	M 5	.430	SDR T20P-T	HS 050125	-
ICO345	US 45011-T20P	5	M 5	.430	SDR T20P-T	HCS 075175	-

## PDKX 09

	a	d	d <sub>1</sub>	l	s
0905	.079	.531	.217	.354	.215

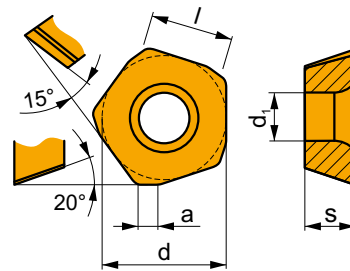


		ANSI		P	M	K	N	S	H			r <sub>ε</sub>	f <sub>min</sub>	f <sub>max</sub>	a <sub>p min</sub>	a <sub>p max</sub>	
  		PDKX 0905ZEER-FM	M9340	<input checked="" type="checkbox"/>	<input checked="" type="checkbox"/>			<input type="checkbox"/>			---	-	.020	.069	.012	.079	
		M6330	<input checked="" type="checkbox"/>	<input checked="" type="checkbox"/>			<input type="checkbox"/>					-	-	.020	.098	.012	.079
		M8345	<input checked="" type="checkbox"/>	<input checked="" type="checkbox"/>			<input type="checkbox"/>					+/-	-	.020	.098	.012	.079

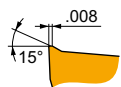


## PDMX 09

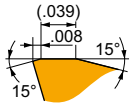
	a	d	d <sub>1</sub>	l	s
0905	.079	.531	.217	.354	.215



		ANSI		P	M	K	N	S	H			r <sub>ε</sub>	f <sub>min</sub>	f <sub>max</sub>	a <sub>p min</sub>	a <sub>p max</sub>	
   		PDMX 0905ZEER-M	M9340	<input checked="" type="checkbox"/>	<input checked="" type="checkbox"/>			<input type="checkbox"/>			---	-	.020	.069	.012	.079	
		M8330	<input checked="" type="checkbox"/>	<input checked="" type="checkbox"/>	<input checked="" type="checkbox"/>	<input type="checkbox"/>	<input type="checkbox"/>					-	-	.020	.098	.012	.079
		M8345	<input checked="" type="checkbox"/>	<input checked="" type="checkbox"/>			<input type="checkbox"/>					+/-	-	.020	.098	.012	.079
		8215	<input checked="" type="checkbox"/>	<input checked="" type="checkbox"/>	<input checked="" type="checkbox"/>	<input type="checkbox"/>	<input type="checkbox"/>					-	-	.020	.098	.012	.079

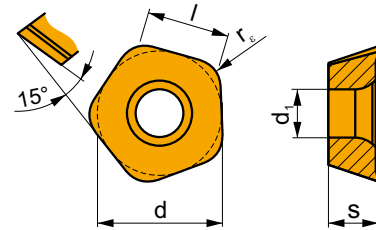


i	ANSI		Material						?		$r_c$	$f_{min}$	$f_{max}$	$a_{p\ min}$	$a_{p\ max}$		
			P	M	K	N	S	H									
  	PDMX 0905ZESR-R		M9325	<input checked="" type="checkbox"/>	<input type="checkbox"/>						---	-	.020	.069	.012	.079	
			M8330	<input checked="" type="checkbox"/>	<input type="checkbox"/>	<input checked="" type="checkbox"/>			<input checked="" type="checkbox"/>			-	-	.020	.098	.012	.079
			M8345	<input checked="" type="checkbox"/>	<input type="checkbox"/>							+/-	-	.020	.098	.012	.079
			8215	<input checked="" type="checkbox"/>	<input type="checkbox"/>	<input checked="" type="checkbox"/>				<input checked="" type="checkbox"/>		-	-	.020	.098	.012	.079

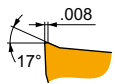


## PDKT 09

	d	d <sub>1</sub>	l	s
0905	.531	.217	.354	.215

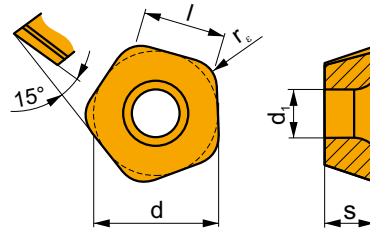


i	ANSI		Material						?		$r_c$	$f_{min}$	$f_{max}$	$a_{p\ min}$	$a_{p\ max}$		
			P	M	K	N	S	H									
   	PDKT 090530ER-FM		M9325	<input checked="" type="checkbox"/>	<input checked="" type="checkbox"/>			<input type="checkbox"/>			---	.118	.020	.069	.012	.079	
			M6330	<input checked="" type="checkbox"/>	<input checked="" type="checkbox"/>			<input type="checkbox"/>			-	.118	.020	.098	.012	.079	
			M8310	<input checked="" type="checkbox"/>	<input checked="" type="checkbox"/>	<input checked="" type="checkbox"/>			<input type="checkbox"/>			-	.118	.020	.098	.012	.079
			M8330	<input checked="" type="checkbox"/>	<input checked="" type="checkbox"/>	<input checked="" type="checkbox"/>	<input type="checkbox"/>	<input type="checkbox"/>				-	.118	.020	.098	.012	.079
			M8345	<input checked="" type="checkbox"/>	<input checked="" type="checkbox"/>	<input checked="" type="checkbox"/>		<input type="checkbox"/>				+/-	.118	.020	.098	.012	.079
			8215	<input checked="" type="checkbox"/>	<input checked="" type="checkbox"/>	<input checked="" type="checkbox"/>	<input type="checkbox"/>	<input type="checkbox"/>				-	.118	.020	.098	.012	.079

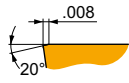


## PDMW 09

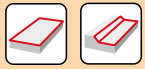
	d	d <sub>1</sub>	l	s
0905	.531	.217	.354	.215



i	ANSI	M9325	M	K	N	S	H	?	r <sub>ε</sub>	f <sub>min</sub>	f <sub>max</sub>	a <sub>p min</sub>	a <sub>p max</sub>	
														PDMW 090530SR
HFC		M9325	☑	☐	☐	☐	☐	☒	---	.118	.020	.069	.012	.079
S		M8310	☑	☐	☐	☐	☐	☒	-	.118	.020	.098	.012	.079
		M8345	☑	☐	☐	☐	☐	☒	+/-	.118	.020	.098	.012	.079

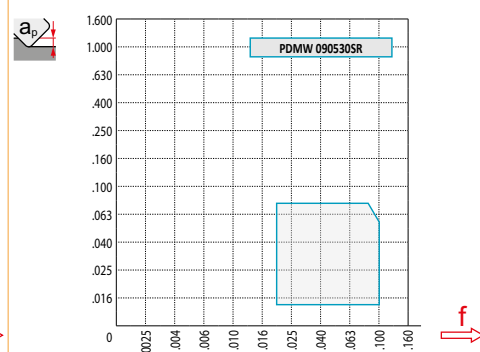
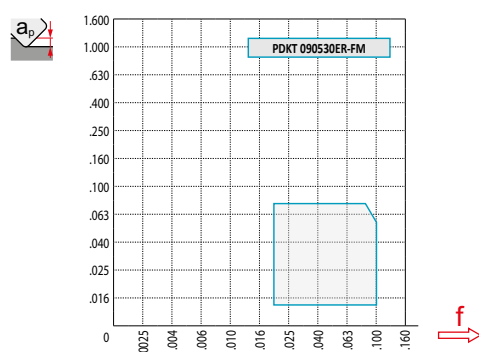
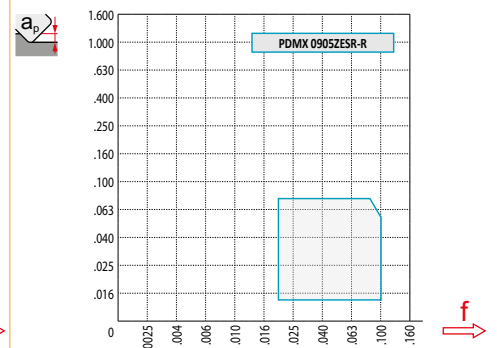
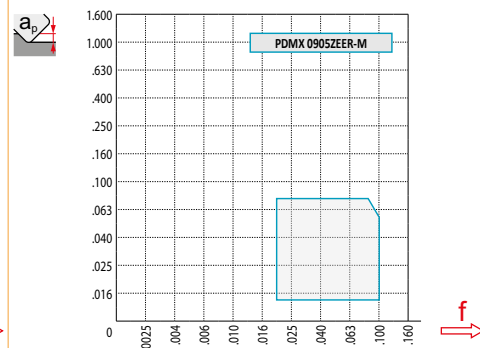
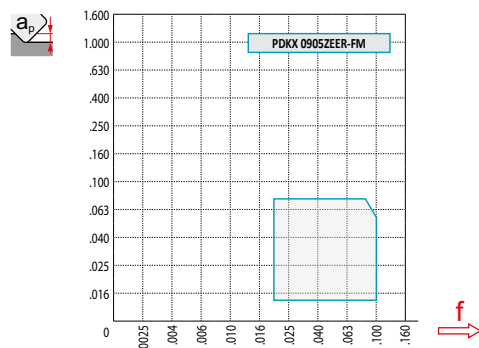


ISO	f <sub>min</sub>	f <sub>max</sub>	M9315	M9325	M9340	M6330	M8310	M8345	8215	M8330	
P	●	.0197	.0984	1535	1480	1283	1155	1319	850	1263	1155
	●	.0197	.0787	1407	1335	1138	1030	1191	722	1102	1010
	☒	.0197	.0591	1263	1175	1010	902	1066	614	938	866
M	●	.0197	.0984	-	886	758	758	794	505	758	686
	●	.0197	.0787	-	794	686	669	705	433	650	614
	☒	.0197	.0591	-	705	597	577	633	361	561	525
K	●	.0197	.0984	1463	-	-	-	1247	-	1191	1102
	●	.0197	.0787	1335	-	-	-	1138	-	1047	958
	☒	.0197	.0591	1211	-	-	-	1010	-	886	830
N	●	.0197	.0984	-	-	-	-	-	-	3176	2907
	●	.0197	.0787	-	-	-	-	-	-	2762	2562
	☒	.0197	.0591	-	-	-	-	-	-	2365	2201
S	●	.0197	.0846	-	433	381	381	397	253	381	344
	●	.0197	.0709	-	397	344	325	344	217	325	308
	☒	.0197	.0551	-	344	289	289	308	180	272	253
H	●	.0197	.0787	308	-	-	-	253	-	253	217
	●	.0197	.063	272	-	-	-	236	-	217	200
	☒	.0197	.0472	253	-	-	-	200	-	180	164



$a_p/D$	.05	.10	.15	.20	.25	.30	.40	.50	.60	.70	.75	.80	.90	1.00
	1.48	1.35	1.27	1.22	1.19	1.16	1.11	1.08	1.05	1.03	1.00	1.00	1.00	1.00
	2.87	2.05	1.69	1.48	1.33	1.23	1.09	.75	.94	.90	.89	.88	.88	1.00
	.64	.64	.64	.64	.64	.65	.65	.67	.68	.71	.72	.74	.79	1.00

	PDKX 09-FM	PDMX 09-M	PDMX 09-R	PDKT 09-FM	PDMW 09
$r_\epsilon$	-	-	-	.118	.118
$a_p$	.079	.079	.079	-	-



$D_{ef}$	$a_p$	.000	.012	.016	.020	.024	.028	.031	.035	.039	.049	.059	.079
1.25		.724	.791	.815	.839	.862	.886	.906	.929	.953	1.012	1.067	1.181
1.50		1.004	1.071	1.094	1.118	1.142	1.165	1.185	1.209	1.232	1.291	1.346	1.461
2.00	$D_{ef}$	1.390	1.457	1.480	1.504	1.528	1.551	1.571	1.594	1.618	1.677	1.732	1.846
2.50		1.898	1.965	1.988	2.012	2.035	2.059	2.079	2.102	2.126	2.185	2.240	2.354
3.00		2.571	2.638	2.661	2.685	2.709	2.732	2.752	2.776	2.799	2.858	2.913	3.028
4.00		3.358	3.425	3.449	3.472	3.496	3.520	3.539	3.563	3.587	3.646	3.701	3.815

$a_p$	.000	.012	.016	.020	.024	.028	.031	.035	.039	.049	.059	.079
	-	.118	.118	.114	.110	.106	.102	.098	.094	.089	.059	.059



Follow instructions provided for flat surface milling. When milling close to vertical surfaces, decrease feed per tooth ( $f_z$ ) by 50 % to prevent vibrations and damage of the cutting edge.  
 Seguir las instrucciones para fresado de superficies planas (planeado). En caso de mecanizar cerca de una superficie vertical, reducir el avance por diente ( $f_z$ ) al 50% para evitar vibraciones y daños en el filo de corte.

Suivre les instructions indiquées pour le fraisage de surfaces planes. Dans le cas de fraisage proche d'une surface verticale, diminuer l'avance par dent ( $f_z$ ) de 50 % pour éviter les vibrations et la casse de l'arête.



$D$		$f_{max}$
1.25	.197	.008
1.50	.197	.008
2.00	.236	.008
2.50	.276	.010
3.00	.315	.012
4.00	.315	.012



HFC			
$a_p$	.020	.039	.079
	.118	.091	.059



$D$	$\alpha_{max}$	$a_p/l$
1.50	8.0	.071/.630
2.00	8.0	.079/.630
2.50	7.0	.079/.710
3.00	5.0	.079/.710
4.00	3.0	.079/.575

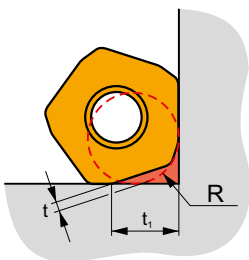


$D$	$d_{min}$	$d_{max}$	$S_{min}$	$S_{max}$
1.50	2.508	3.150	.079	.079
2.00	3.280	3.937	.079	.079
2.50	4.299	4.961	.079	.079
3.00	5.642	6.299	.079	.079
4.00	7.217	7.874	.079	.079



$D$	$a_p$	$f_{max}$
1.25	.071	.008
1.50	.071	.008
2.00	.079	.008
2.50	.079	.010
3.00	.079	.012
4.00	.079	.012

# i



$D$	R	t	$t_1$
1.25	.177	.043	.268
1.5-6	.177	.043	.287



**IFSB22X**

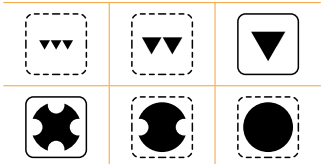
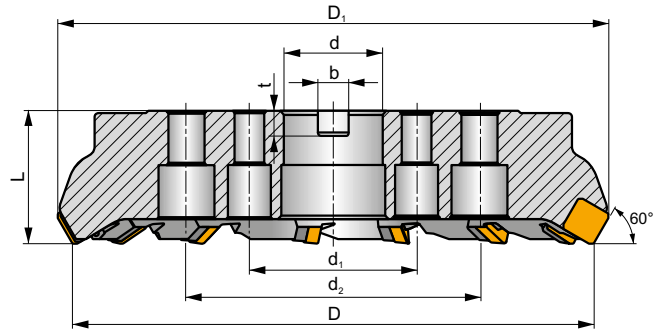
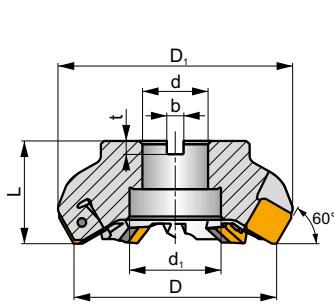
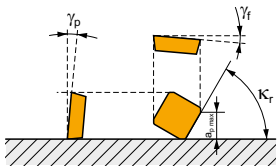
**P M K**

**F**

**ROUGH SB**



$\kappa_r$	60°
$a_{pmax}$	.591



$h_m$  .006-.197



ANSI	D	D <sub>1</sub>	L	d	d <sub>1</sub>	d <sub>2</sub>	b	t	$\gamma_r$	$\gamma_p$					lbs		
<b>500B07R-IF60SB22X</b>	5.000	5.764	2.480	1.500	2.205	-	.630	.382	-9	9	7	✓	-	-	7.05	GI144	FA111
<b>600B08R-IF60SB22X</b>	6.000	6.736	2.480	2.000	3.465	-	.756	.445	-9	9	8	✓	-	-	12.57	GI144	FA111
<b>800C10R-IF60SB22X</b>	8.000	8.705	2.480	2.500	4.000	-	1.000	.559	-9	9	10	✓	-	-	19.40	GI144	FA111
<b>1000C12R-IF60SB22X</b>	10.000	1.685	2.480	2.500	4.000	-	1.000	.559	-9	9	12	✓	-	-	33.51	GI144	FA111
<b>1200C14R-IF60SB22X</b>	12.000	12.661	3.150	2.500	4.000	7.000	1.000	.559	-9	9	14	✓	-	-	73.19	GI144	FA111

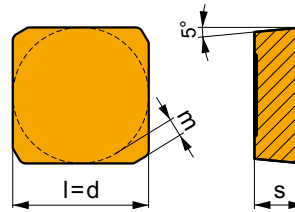


GI144	SBKX 2207DZ..	SBMR 2207DZ..

FA111	LNx 220616	US 6013-T20P	SDR T20P-T	KU SBMR 2207	DS 01Z	KL 04	-

## SBMR 22

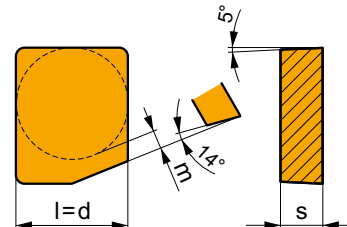
	d	l	m	s
2207	.866	.866	.111	.315



i	ANSI	Material	Grade					Chip	Coolant	r <sub>c</sub>	f <sub>min</sub>	f <sub>max</sub>	a <sub>p min</sub>	a <sub>p max</sub>
			P	M	K	N	S							
  	SBMR 2207DZSR	M9325	■	■					---	-	.014	.031	.059	.591
			■	□	□				---	-	.014	.031	.059	.591
			■	■					+/-	-	.014	.031	.059	.591
 	SBMR 2207DZSR-R	M5326	■		■				---	-	.014	.031	.059	.591
			■	□	□				-	-	.014	.031	.059	.591
			■	■					+/-	-	.014	.031	.059	.591

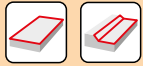
## SBKX 22

	d	l	m	s
2207	.866	.866	.127	.315



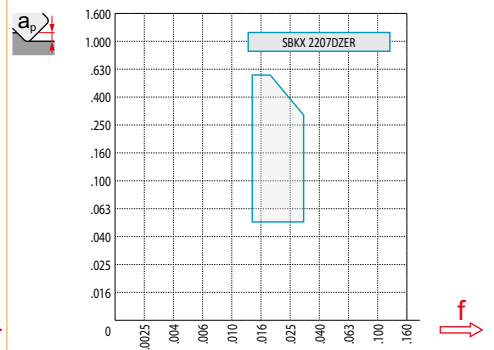
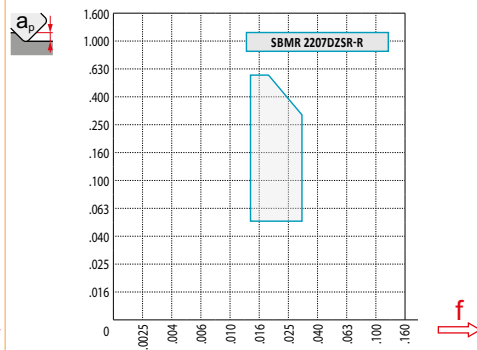
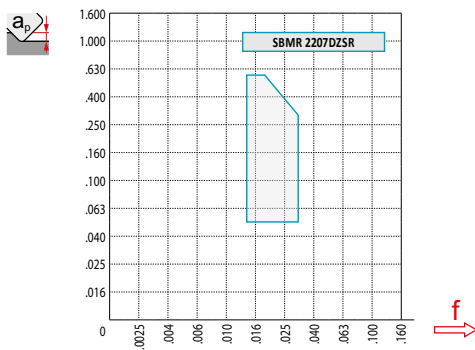
i	ANSI	Material	Grade					Chip	Coolant	r <sub>c</sub>	f <sub>min</sub>	f <sub>max</sub>	a <sub>p min</sub>	a <sub>p max</sub>
			P	M	K	N	S							
 	SBKX 2207DZER	M8326	■	□	□				-	-	.014	.031	.059	.591

ISO	$f_{min}$	$f_{max}$	M5326	M9325	M8326	M8346	
P	●	.0138	.0236	1184	1145	810	656
	●	.0138	.0197	1089	1033	725	558
	✘	.0138	.0157	978	906	643	476
M	●	.0138	.0217	-	682	489	390
	●	.0138	.0177	-	614	433	335
	✘	.0138	.0157	-	545	390	279
K	●	.0138	.0236	1129	-	768	-
	●	.0138	.0197	1033	-	699	-
	✘	.0138	.0157	935	-	614	-



$a_e/D$	.05	.10	.15	.20	.25	.30	.40	.50	.60	.70	.75	.80	.90	1.00
	1.48	1.35	1.27	1.22	1.19	1.16	1.11	1.08	1.05	1.03	1.00	1.00	1.00	1.00
	2.87	2.05	1.69	1.48	1.33	1.23	1.09	.75	.94	.90	.89	.88	.88	1.00
	.64	.64	.64	.64	.64	.65	.65	.67	.68	.71	.72	.74	.79	1.00

	SBMR 22	SBMR 22-R	SBKX 22
$r_\epsilon$	-	-	-
$a$	.078	.078	.466





# ISAD11E

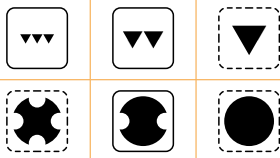
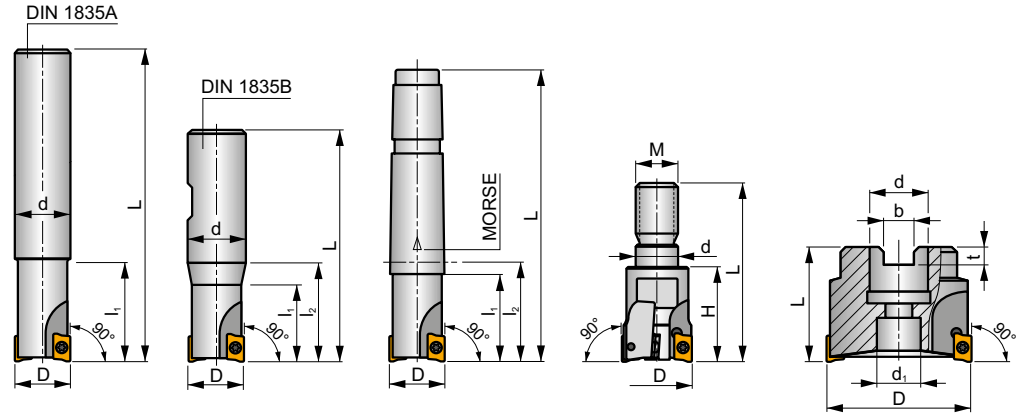
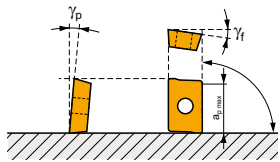
P M K N S H

S

FORCE AD



$\kappa_r$	90°
$a_{pmax}$	.354



.0031-.0062  
 .0023-.0051



ANSI	D	L	d	d <sub>1</sub>	l <sub>1</sub>	l <sub>2</sub>	H	M	b	t	$\gamma_r$	$\gamma_p$					lbs		
062A2R094C062-ISAD11E-C	.625	5.315	.625	-	.945	-	-	-	-	-	-12.8	4	2	-	30100	✓	.44	IGI169	ISQ025
062A2R197C062-ISAD11E-C	.625	5.315	.625	-	1.969	-	-	-	-	-	-12.6	4	2	-	30100	✓	.44	IGI169	ISQ025
075A2R114C075-ISAD11E-C	.750	5.906	.750	-	1.142	-	-	-	-	-	-11.5	5	2	-	27000	✓	.66	IGI169	ISQ020
075A2R276C075-ISAD11E-C	.750	5.906	.750	-	2.756	-	-	-	-	-	-11.5	5	2	-	27000	✓	.66	IGI169	ISQ020
075A3R114C075-ISAD11E-C	.750	5.906	.750	-	1.142	-	-	-	-	-	-11.5	5	3	-	27000	✓	.66	IGI169	ISQ025
100A3R134C100-ISAD11E-C	1.000	6.693	1.000	-	1.339	-	-	-	-	-	-1.2	5	3	-	24100	✓	1.10	IGI169	ISQ020
100A3R315C100-ISAD11E-C	1.000	6.693	1.000	-	3.150	-	-	-	-	-	-1.2	5	3	-	24100	✓	1.10	IGI169	ISQ020
100A4R134C100-ISAD11E-C	1.000	6.693	1.000	-	1.339	-	-	-	-	-	-1.2	5	4	-	24100	✓	1.10	IGI169	ISQ025
125A3R354C125-ISAD11E-C	1.250	7.677	1.250	-	3.543	-	-	-	-	-	-9	5	3	-	21300	✓	1.98	IGI169	ISQ020
125A5R134C125-ISAD11E-C	1.250	7.677	1.250	-	1.339	-	-	-	-	-	-9	8	5	-	21300	✓	1.98	IGI169	ISQ025
062A2R106W062-ISAD11E-C	.625	2.969	.625	-	1.063	-	-	-	-	-	-12.8	4	2	-	30100	✓	.22	IGI169	ISQ025
075A2R126W075-ISAD11E-C	.750	3.291	.750	-	1.260	-	-	-	-	-	-11.5	5	2	-	27000	✓	.44	IGI169	ISQ020
075A3R126W075-ISAD11E-C	.750	3.291	.750	-	1.260	-	-	-	-	-	-11.5	5	3	-	27000	✓	.44	IGI169	ISQ025
100A3R128W100-ISAD11E-C	1.000	3.780	1.000	-	1.280	-	-	-	-	-	-1.2	5	3	-	24100	✓	.66	IGI169	ISQ020
100A4R128W100-ISAD11E-C	1.000	3.780	1.000	-	1.280	-	-	-	-	-	-1.2	5	4	-	24100	✓	.66	IGI169	ISQ025
125A4R150W125-ISAD11E-C	1.250	4.000	1.250	-	1.500	-	-	-	-	-	-9	8	4	-	21300	✓	.88	IGI169	ISQ020
125A5R150W125-ISAD11E-C	1.250	4.000	1.250	-	1.500	-	-	-	-	-	-9	8	5	-	21300	✓	.88	IGI169	ISQ025
062A2R094M08-ISAD11E-C	.625	1.496	.335	-	-	.945	M8	-	-	-	-12.8	4	2	-	-	✓	.22	IGI169	ISQ025
075A2R102M10-ISAD11E-C	.750	1.772	.413	-	-	1.024	M10	-	-	-	-11.5	5	2	-	-	✓	.22	IGI169	ISQ020
075A3R102M10-ISAD11E-C	.750	1.772	.413	-	-	1.024	M10	-	-	-	-11.5	5	3	-	-	✓	.22	IGI169	ISQ025
100A3R138M12-ISAD11E-C	1.000	2.244	.492	-	-	1.378	M12	-	-	-	-1.2	5	3	-	-	✓	.22	IGI169	ISQ020
100A4R138M12-ISAD11E-C	1.000	2.244	.492	-	-	1.378	M12	-	-	-	-1.2	5	4	-	-	✓	.22	IGI169	ISQ025
125A4R169M16-ISAD11E-C	1.250	2.598	.669	-	-	1.693	M16	-	-	-	-9	8	4	-	-	✓	.22	IGI169	ISQ020
125A5R169M16-ISAD11E-C	1.250	2.598	.669	-	-	1.693	M16	-	-	-	-9	8	5	-	-	✓	.22	IGI169	ISQ025
150A4R169M16-ISAD11E-C	1.500	2.598	.669	-	-	1.693	M16	-	-	-	-8.1	11	4	-	-	✓	.44	IGI169	ISQ020
150A6R169M16-ISAD11E-C	1.500	2.598	.669	-	-	1.693	M16	-	-	-	-8.1	11	6	-	-	✓	.44	IGI169	ISQ020
150A04R-IS90AD11E-C	1.500	1.575	.500	.433	-	-	-	.258	.165	-	-8.1	11	4	✓	19000	✓	.44	IGI169	ISQ022
150A06R-IS90AD11E-C	1.500	1.575	.500	.433	-	-	-	.258	.165	-	-8.1	11	6	✓	19100	✓	.44	IGI169	ISQ022

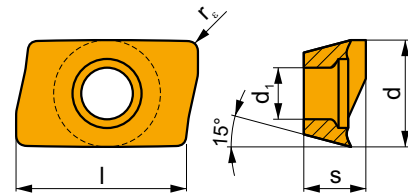
ANSI	D	L	d	d <sub>1</sub>	l <sub>1</sub>	l <sub>2</sub>	H	M	b	t	γ <sub>f</sub> °	γ <sub>p</sub> °						
200A05R-IS90AD11E-C	2.000	1.575	.750	.630	-	-	-	-	.321	.193	-7.2	12	5	✓	17000	✓	.66	IGI169 ISQ023
200A07R-IS90AD11E-C	2.000	1.575	.750	.630	-	-	-	-	.321	.193	-7.2	12	7	✓	17000	✓	.66	IGI169 ISQ023
250A06R-IS90AD11E-C	2.500	1.575	.750	.630	-	-	-	-	.321	.193	-6.5	12	6	✓	15200	✓	1.10	IGI169 ISQ023
250A09R-IS90AD11E-C	2.500	1.575	.750	.630	-	-	-	-	.321	.193	-6.5	12	9	✓	15200	✓	1.10	IGI169 ISQ023
300A10R-IS90AD11E-C	3.000	1.969	1.000	.827	-	-	-	-	.382	.224	-6	12	10	✓	13500	✓	2.20	IGI169 ISQ024
400A11R-IS90AD11E-C	4.000	1.969	1.500	1.260	-	-	-	-	.630	.382	-5.5	12	11	✓	12100	✓	3.75	IGI169 ISQ025
500A12R-IS90AD11E-C	5.000	2.480	1.500	1.260	-	-	-	-	.630	.382	-5.2	12	12	✓	10800	✓	7.72	IGI169 ISQ025

IGI169	ADMX 11T3..	ADEX 11T3..

				.240 icon"/>				
ISQ020	US 62506-T07P	1.2	M 2.5	.240	-	-	Flag T07P	-
ISQ022	US 62506-T07P	1.2	M 2.5	.240	D-T07P/T09P	FG-15	-	HS 025100
ISQ023	US 62506-T07P	1.2	M 2.5	.240	D-T07P/T09P	FG-15	-	HS 037100
ISQ024	US 62506-T07P	1.2	M 2.5	.240	D-T07P/T09P	FG-15	-	HS 050125
ISQ025	US 62505-T07P	1.2	M 2.5	.200	-	-	Flag T07P	-

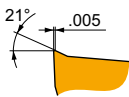
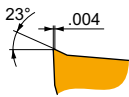
## ADMX 11

	d	d <sub>1</sub>	l	s
11T3	.257	.114	.433	.156



			P	M	K	N	S	H			r <sub>c</sub>	f <sub>min</sub>	f <sub>max</sub>	a <sub>p min</sub>	a <sub>p max</sub>	
	ADMX 11T304SR-F	M9340	█	█	█	█	█	█	●	---	.016	.003	.004	.008	.354	
		M8310	█	█	█	█	█	█	●	-	.016	.003	.005	.008	.354	
		M8330	█	█	█	□	□	█	█	●	-	.016	.003	.005	.008	.354
		M8340	█	█	█	█	█	█	█	●	+/-	.016	.003	.005	.008	.354
		8215	█	█	█	█	█	█	█	●	-	.016	.003	.005	.008	.354
	ADMX 11T308SR-F	M9340	█	█	█	█	█	█	●	---	.031	.003	.004	.008	.354	
		M8330	█	█	█	□	□	█	█	●	-	.031	.003	.005	.008	.354
		M8340	█	█	█	█	█	█	█	●	+/-	.031	.003	.005	.008	.354
		8215	█	█	█	█	█	█	█	●	-	.031	.003	.005	.008	.354

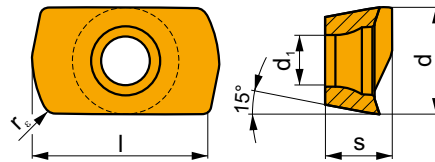
i	ANSI		P	M	K	N	S	H			r <sub>c</sub>	f <sub>min</sub>	f <sub>max</sub>	a <sub>p min</sub>	a <sub>p max</sub>	
	ADMX 11T302SR-M	M8330	■	▣	■		□		●	-	.008	.004	.006	.008	.354	
		M8340	■	■	▣		▣		●	+/-	.008	.004	.006	.008	.354	
	ADMX 11T304SR-M	M9325	■	▣			▣		●	---	.016	.004	.006	.008	.354	
		M9340	▣	■			▣		●	---	.016	.004	.006	.008	.354	
		M8310	■	▣	■		▣		●	-	.016	.004	.007	.008	.354	
		M8330	■	▣	■		□		●	-	.016	.004	.007	.008	.354	
		M8340	■	■	▣		▣		●	+/-	.016	.004	.007	.008	.354	
		8215	■	▣	■		▣		●	-	.016	.004	.007	.008	.354	
	ADMX 11T308SR-M	M5315	▣		■				●	---	.031	.004	.006	.008	.354	
		M9315	■		▣				●	---	.031	.004	.006	.008	.354	
		M9325	■	▣			▣		●	---	.031	.004	.006	.008	.354	
		M9340	▣	■			▣		●	---	.031	.004	.006	.008	.354	
		M8310	■	▣	■		▣		●	-	.031	.004	.007	.008	.354	
		M8330	■	▣	■		□		●	-	.031	.004	.007	.008	.354	
		M8340	■	■	▣		▣		●	+/-	.031	.004	.007	.008	.354	
		8215	■	▣	■		▣		●	-	.031	.004	.007	.008	.354	
	ADMX 11T310SR-M	M8330	■	▣	■		□		✘	-	.039	.004	.009	.008	.354	
		M8340	■	■	▣		▣		✘	+/-	.039	.004	.009	.008	.354	
	ADMX 11T312SR-M	M8330	■	▣	■		□		✘	-	.047	.004	.009	.008	.354	
		M8340	■	■	▣		▣		✘	+/-	.047	.004	.009	.008	.354	
		8215	■	▣	■		▣		●	-	.047	.004	.009	.008	.354	
	ADMX 11T316SR-M	M6330	▣	■			▣		✘	-	.063	.004	.009	.008	.354	
		M8310	■	▣	■		▣		●	-	.063	.004	.009	.008	.354	
		M8330	■	▣	■		□		✘	-	.063	.004	.009	.008	.354	
		M8340	■	■	▣		▣		✘	+/-	.063	.004	.009	.008	.354	
		8215	■	▣	■		▣		●	-	.063	.004	.009	.008	.354	
	ADMX 11T320SR-M	M6330	▣	■			▣		✘	-	.079	.004	.009	.008	.354	
		M8330	■	▣	■		□		✘	-	.079	.004	.009	.008	.354	
		M8340	■	■	▣		▣		✘	+/-	.079	.004	.009	.008	.354	
	ADMX 11T325SR-M	M6330	▣	■			▣		✘	-	.098	.004	.009	.008	.354	
		M8340	■	■	▣		▣		✘	+/-	.098	.004	.009	.008	.354	
	ADMX 11T330SR-M	M6330	■	■	■		▣		✘	-	.118	.004	.009	.008	.354	
		M8330	■	■	■		▣		✘	-	.118	.004	.009	.008	.354	
		M8340	■	■	▣		▣		✘	+/-	.118	.004	.009	.008	.354	
	ADMX 11T308PR-R	M5315	▣		■			▣	●	---	.031	.006	.008	.031	.354	
		M9315	■		▣			▣	●	---	.031	.006	.008	.031	.354	
		M9325	■	▣			▣		✘	---	.031	.006	.008	.031	.354	
		M8310	■	▣	■		▣	▣	✘	-	.031	.006	.010	.031	.354	
		M8830	■	▣	■		□	▣	✘	-	.031	.006	.010	.031	.354	
		M8340	■	▣	▣		▣		✘	+/-	.031	.006	.010	.031	.354	
		8215	■	▣	■		▣	▣	✘	-	.031	.006	.010	.031	.354	
	ADMX 11T316PR-R	M9325	■	▣			▣		✘	---	.063	.006	.008	.031	.354	
		M8330	■	▣	■		□	▣	✘	-	.063	.006	.010	.031	.354	
		8215	■	▣	■		▣	▣	✘	-	.063	.006	.010	.031	.354	



i	ANSI		P	M	K	N	S	H			$r_c$	$f_{min}$	$f_{max}$	$a_{p min}$	$a_{p max}$	
   	ADMX 11T304SR-MF	M6330	█	█			█		●	-	.016	.002	.006	.008	.354	
		M8340	█	█			█		●	+/-	.016	.002	.006	.008	.354	
	ADMX 11T308SR-MF	M9340	█	█			█		●	---	.031	.002	.005	.008	.354	
		M6330	█	█			█		●	-	.031	.002	.006	.008	.354	
			M8340	█	█			█		●	+/-	.031	.002	.006	.008	.354
	   	ADMX 11T304SR-MM	M9340	█	█			█		●	---	.016	.004	.006	.008	.354
			M6330	█	█			█		●	-	.016	.004	.007	.008	.354
			M8340	█	█			█		●	+/-	.016	.004	.007	.008	.354
ADMX 11T308SR-MM		M9340	█	█			█		●	---	.031	.004	.006	.008	.354	
		M6330	█	█			█		●	-	.031	.004	.007	.008	.354	
		M8340	█	█			█		●	+/-	.031	.004	.007	.008	.354	
ADMX 11T312SR-MM		M8345	█	█			█		●	+/-	.031	.004	.007	.008	.354	
		M9340	█	█			█		●	---	.047	.004	.006	.008	.354	
		M6330	█	█			█		●	-	.047	.004	.007	.008	.354	
			M8340	█	█			█		●	+/-	.047	.004	.007	.008	.354

## ADEX 11-HF

	d	d <sub>1</sub>	l	s
11T3	.254	.114	.420	.150

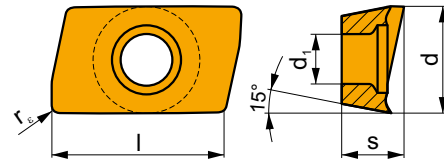


i	ANSI		P	M	K	N	S	H			$r_c$	$f_{min}$	$f_{max}$	$a_{p min}$	$a_{p max}$	
  	ADEX 11T308SR-HF	M9340	█	█			█		●	---	.031	.016	.044	.004	.024	
		M6330	█	█			█		●	-	.031	.016	.051	.004	.024	
		M8310	█	█	□		█	□		●	-	.031	.016	.051	.004	.024
		M8330	█	█	□		█	□		●	-	.031	.016	.051	.004	.024
		M8340	█	█	□		█			●	+/-	.031	.016	.051	.004	.024
		8215	█	█	□		█	□		●	-	.031	.016	.051	.004	.024
  	ADEX 11T308SR-HF2	M9325	█	█			□		●	---	.031	.016	.046	.006	.024	
		M9340	█	█			□		●	---	.031	.016	.046	.006	.024	
		M8310	█	█	█		□	█		●	-	.031	.016	.051	.006	.024
		M8330	█	█	█		□	█		●	-	.031	.016	.051	.006	.024
		M8340	█	█	█		□			●	+/-	.031	.016	.051	.006	.024
				M8340	█	█	█		□		●	+/-	.031	.016	.051	.006



## ADEX 11-FA

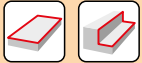
	d	d <sub>1</sub>	l	s
11T3	.254	.114	.382	.154



i	ANSI	M	P	K	N	S	H	?	r <sub>c</sub>	f <sub>min</sub>	f <sub>max</sub>	a <sub>p min</sub>	a <sub>p max</sub>	
														Material
	ADEX 11T304FR-FA	M0315			■			●	++	.016	.001	.012	.016	.354
		HF7			■			●	+/-	.016	.001	.012	.008	.354
	ADEX 11T308FR-FA	M0315			■			●	++	.031	.001	.012	.008	.354
		HF7			■			●	+/-	.031	.001	.012	.008	.354
	ADEX 11T312FR-FA	HF7			■			●	+/-	.047	.001	.012	.008	.354
	ADEX 11T316FR-FA	HF7			■			●	+/-	.063	.001	.012	.008	.354

ISO	f <sub>min</sub>	f <sub>max</sub>	M5315	M9315	M9325	M9340	M0315	M6330	M8310	M8340	M8345	8215	M8330	HF7	
P	●	.0028	.0071	1280	1247	1198	1033	-	935	1066	951	689	1033	935	-
	●	.0028	.0059	1181	1148	1083	919	-	837	968	837	591	886	820	-
	✘	.0028	.0039	1083	1033	951	820	-	738	869	722	492	755	705	-
M	●	.0028	.0071	-	-	722	607	-	607	640	574	410	607	558	-
	●	.0028	.0059	-	-	640	558	-	541	574	492	344	525	492	-
	✘	.0028	.0039	-	-	574	476	-	459	509	427	295	443	427	-
K	●	.0028	.0071	1214	1181	-	-	-	-	1017	886	-	968	886	-
	●	.0028	.0059	1132	1083	-	-	-	-	919	787	-	853	771	-
	✘	.0028	.0039	1033	984	-	-	-	-	820	689	-	722	673	-
N	●	.0028	.0071	-	-	-	-	2231	-	-	-	-	2592	2362	1001
	●	.0028	.0059	-	-	-	-	2001	-	-	-	-	2247	2083	886
	✘	.0028	.0039	-	-	-	-	1755	-	-	-	-	1919	1788	771
S	●	.0028	.0071	-	-	344	295	-	295	312	279	197	295	279	-
	●	.0028	.0059	-	-	312	279	-	262	279	246	164	262	246	-
	✘	.0028	.0039	-	-	279	230	-	230	246	197	148	213	197	-
H	●	.0028	.0071	246	246	-	-	-	-	197	-	-	197	164	-
	●	.0028	.0059	230	213	-	-	-	-	180	-	-	164	148	-
	✘	.0028	.0039	197	197	-	-	-	-	148	-	-	148	131	-

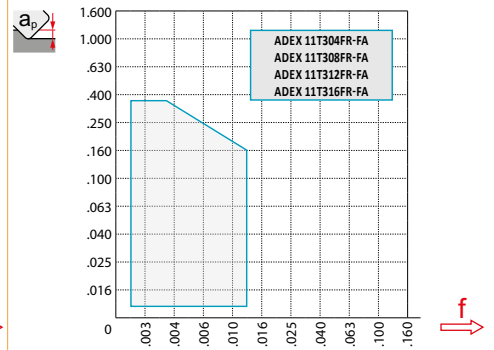
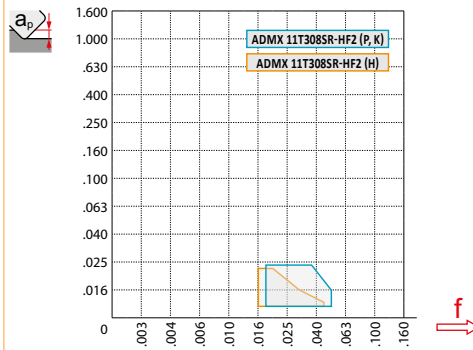
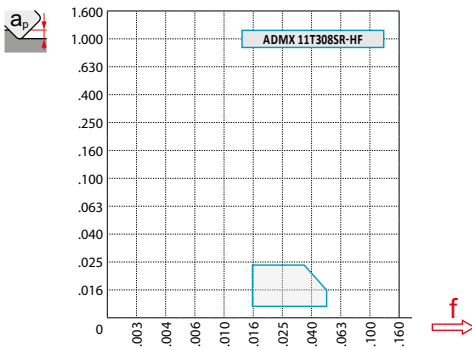
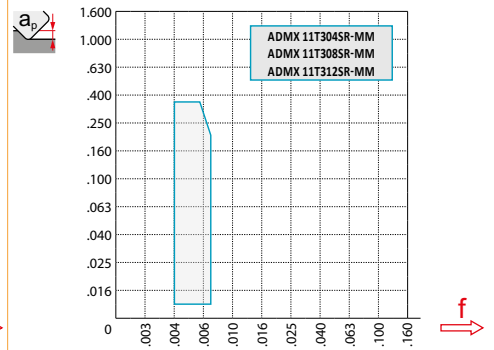
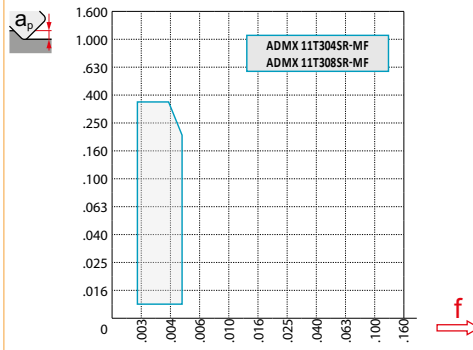
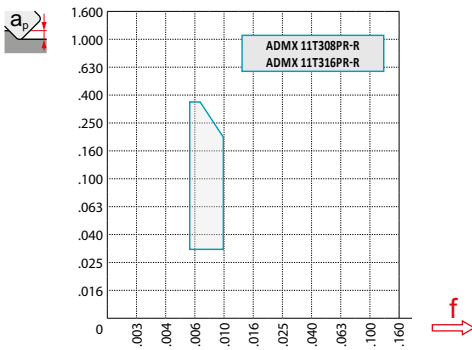
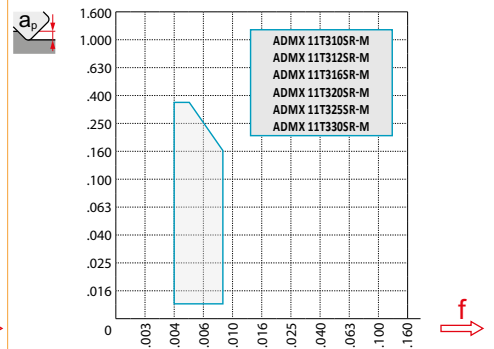
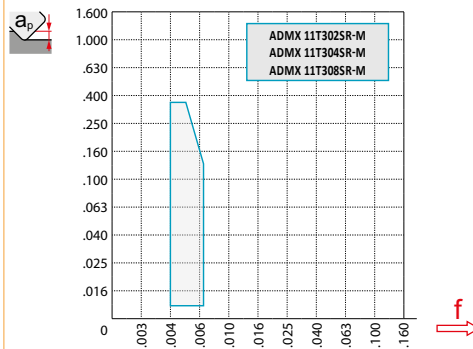
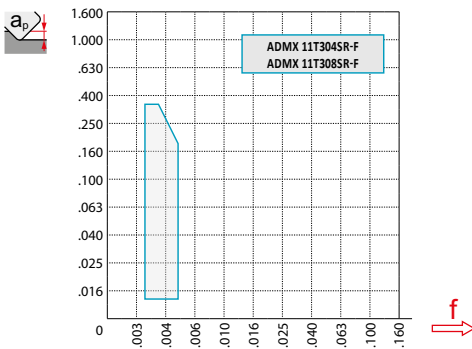
HFC		$f_{min}$	$f_{max}$	M8325	M8340	M8310	M8340	8215	M8330
P	●	.0177	.0492	1066	918	951	853	918	836
	●	.0177	.0394	968	820	853	738	787	722
	✘	.0177	.0315	853	722	771	640	672	623
M	●	.0177	.0492	640	541	574	508	541	492
	●	.0177	.0394	574	492	508	443	459	443
	✘	.0177	.0315	508	426	459	377	394	377
K	●	.0177	.0492	-	-	902	787	853	787
	●	.0177	.0394	-	-	820	705	754	689
	✘	.0177	.0315	-	-	722	607	640	590
N	●	.0177	.0492	-	-	-	-	2296	2099
	●	.0177	.0394	-	-	-	-	2001	1853
	✘	.0177	.0315	-	-	-	-	1706	1591
S	●	.0177	.0472	312	262	279	246	262	246
	●	.0177	.0394	279	246	246	213	230	213
	✘	.0177	.0315	246	197	213	180	197	180
H	●	.0157	.0394	-	-	180	-	180	148
	●	.0157	.0315	-	-	164	-	148	131
	✘	.0157	.0236	-	-	131	-	131	115



$\frac{a_e}{D}$	.05	.10	.15	.20	.25	.30	.40	.50	.60	.70	.75	.80	.90	1.00
	1.48	1.35	1.27	1.22	1.19	1.16	1.11	1.08	1.05	1.03	1.00	1.00	1.00	1.00
	2.87	2.05	1.69	1.48	1.33	1.23	1.09	.75	.94	.90	.89	.88	.88	1.00
	.64	.64	.64	.64	.64	.65	.65	.67	.68	.71	.72	.74	.79	1.00

	ADMX 11-F		ADMX 11-M								ADMX 11-R		ADMX 11-MF		
	.016	.031	.008	.016	.031	.039	.047	.063	.079	.098	.118	.031	.063	.016	.031
	.074	.058	.082	.074	.058	.050	.043	.027	.063	.044	.026	.058	.027	.074	.058

	ADMX 11-MM				ADEX 11-HF	ADEX 11-HF2	ADEX 11-FA			
	.016	.031	.047	.063	.031	.031	.016	.031	.047	.063
	.074	.058	.043	.024	.007	.007	.070	.055	.039	.024



.177



.040    .197    .354



.008    .005    .004



			HFC		
$\varnothing D$	$\alpha_{max}^\circ$	$a_p/l$	$\alpha_{max}^\circ$	$\alpha_{max}^\circ$	$a_p/l$
.625	13.5	.354/1.575	4.1	5.7	.024/.315
.750	9.0	.354/2.323	2.8	4.3	.024/.591
1.00	6.0	.354/3.425	2.3	6.7	.024/1.024
1.25	5.3	.354/3.898	1.3	4.3	.024/1.929
1.50	3.8	.256/4.000	.7	2.9	.024/4.000
2.00	2.8	.185/4.000	.3	2.1	.024/4.000
2.50	1.8	.118/4.000	.1	-	-
3.00	1.6	.102/4.000	-	-	-



					HFC			
$\varnothing D$	$d_{min}$	$d_{max}$	$\frac{S_{max}}{d_{min}}$	$\frac{S_{max}}{d_{max}}$	$d_{min}$	$d_{max}$	$\frac{S_{max}}{d_{min}}$	$\frac{S_{max}}{d_{max}}$
.625	1.063	1.260	.327	.354	.827	1.260	.024	.024
.750	1.378	1.575	.295	.354	1.142	1.575	.024	.024
1.00	1.772	1.969	.256	.295	1.535	1.969	.024	.024
1.25	2.323	2.520	.157	.177	2.087	2.520	.024	.024
1.50	2.953	3.150	.059	.079	2.697	3.150	.024	.024
2.00	-	-	-	-	3.484	3.937	.024	.024



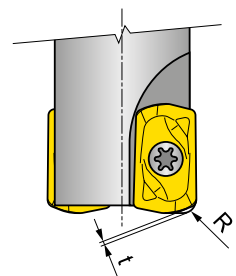
$a_p/l$
.067

**i**



ADMX/ADEX 11	R
ADMX 11T320SR-M	.039
ADMX 11T325SR-M	.071
ADMX 11T330SR-M	.071
ADEX 11T308SR-HF	.055
ADEX 11T308SR-HF2	.055

**i**



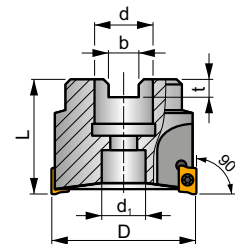
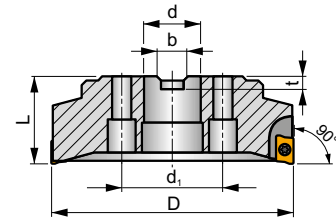
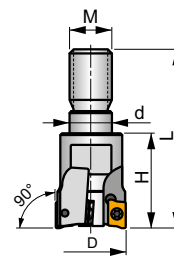
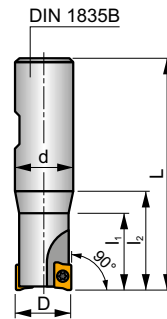
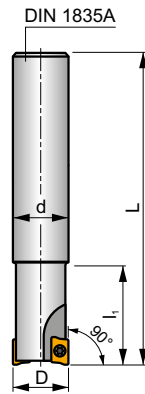
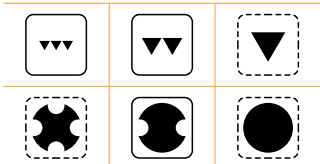
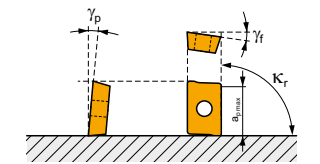
ADEX 11	R	t
	[in]	[in]
ADEX 11T308SR-HF	.056	.014
ADEX 11T308SR-HF2	.053	.015

**ISAD16E**

**P M K N S H**



$\kappa_r$	90°
$a_{pmax}$	.512



.0031-.0086

.0023-.0070



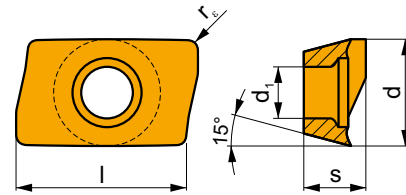
	ANSI	D	L	d	d <sub>1</sub>	l <sub>1</sub>	l <sub>2</sub>	H	M	b	t	$\gamma_r$	$\gamma_p$					lbs		
	<b>100A2R130C100-ISAD16E-C</b>	1.000	6.496	1.000	-	1.300	-	-	-	-	-	-13	5	2	-	18700	✓	1.10	IGI165	ISQ030
	<b>125A3R130C125-ISAD16E-C</b>	1.250	7.677	1.250	-	1.300	-	-	-	-	-	-12	7	3	-	18700	✓	1.98	IGI165	ISQ030
	<b>100A2R128W100-ISAD16E-C</b>	1.000	3.780	1.000	-	1.280	-	-	-	-	-	-13	5	2	-	18700	✓	.66	IGI165	ISQ030
	<b>125A3R150W125-ISAD16E-C</b>	1.250	4.000	1.250	-	1.500	-	-	-	-	-	-12	7	3	-	16500	✓	1.10	IGI165	ISQ030
	<b>150A3R160W125-ISAD16E-C</b>	1.500	4.350	1.250	-	1.600	-	-	-	-	-	-8.2	1.5	3	-	14800	✓	1.32	IGI165	ISQ030
	<b>150A4R160W125-ISAD16E-C</b>	1.500	4.350	1.250	-	1.600	-	-	-	-	-	-8.2	1.5	4	-	14800	✓	1.32	IGI165	ISQ030
	<b>125A3R169M16-ISAD16E-C</b>	1.250	2.596	.669	-	-	-	1.690	M16	-	-	-12	7	3	-	-	✓	.46	IGI165	ISQ030
	<b>150A4R169M16-ISAD16E-C</b>	1.500	2.596	.669	-	-	-	1.690	M16	-	-	-8.2	1.5	4	-	-	✓	.60	IGI165	ISQ030
	<b>150A04R-IS90AD16E-C</b>	1.500	1.575	.500	.433	-	-	-	.258	.165	.165	-8.2	1.5	4	-	14700	✓	.44	IGI165	ISQ032
	<b>200A03R-IS90AD16E-C</b>	2.000	1.575	.750	.630	-	-	-	.321	.193	.193	-7	11	3	-	13200	✓	.66	IGI165	ISQ033
	<b>200A05R-IS90AD16E-C</b>	2.000	1.575	.750	.630	-	-	-	.321	.193	.193	-7	11	5	✓	13200	✓	.66	IGI165	ISQ033
	<b>250A04R-IS90AD16E-C</b>	2.500	1.575	.750	.630	-	-	-	.321	.193	.193	-6	12	4	✓	11800	✓	1.10	IGI165	ISQ033
	<b>250A06R-IS90AD16E-C</b>	2.500	1.575	.750	.630	-	-	-	.321	.193	.193	-6	12	6	✓	11800	✓	1.10	IGI165	ISQ033
	<b>300A05R-IS90AD16E-C</b>	3.000	1.969	1.000	.827	-	-	-	.382	.224	.224	-5	12	5	✓	10400	✓	2.20	IGI165	ISQ034
	<b>300A07R-IS90AD16E-C</b>	3.000	1.969	1.000	.827	-	-	-	.382	.224	.224	-5	13	7	✓	10400	✓	2.20	IGI165	ISQ034
	<b>400A06R-IS90AD16E-C</b>	4.000	1.969	1.500	1.260	-	-	-	.630	.382	.382	-4	12	6	✓	9300	✓	3.97	IGI165	ISQ035
	<b>400A08R-IS90AD16E-C</b>	4.000	1.969	1.500	1.260	-	-	-	.630	.382	.382	-4	12	8	✓	9300	✓	3.75	IGI165	ISQ035
	<b>500A09R-IS90AD16E-C</b>	5.000	2.480	1.500	1.260	-	-	-	.630	.382	.382	-3.8	12	9	✓	8400	✓	7.72	IGI165	ISQ035
	<b>600B10R-IS90AD16E</b>	6.000	2.480	2.000	3.465	-	-	-	.756	.445	.445	-3.8	10	10	✓	7300	✓	12.57	IGI165	ISQ031

IGI165	ADMX 1606..	ADEX 1606..

ISQ030	US 4008-T15P	3.5	M 4	.310	-	-	Flag T15P	-
ISQ031	US 4011-T15P	3.5	M 4	.430	D-T08P/T15P	FG-15	-	-
ISQ032	US 4008-T15P	3.5	M 4	.310	D-T08P/T15P	FG-15	-	HS 025100
ISQ033	US 4011-T15P	3.5	M 4	.430	D-T08P/T15P	FG-15	-	HS 037100
ISQ034	US 4011-T15P	3.5	M 4	.430	D-T08P/T15P	FG-15	-	HS 050125
ISQ035	US 4011-T15P	3.5	M 4	.430	D-T08P/T15P	FG-15	-	HS 075125

## ADMX 16

	d	d <sub>1</sub>	l	s
1606	.392	.177	.630	.246

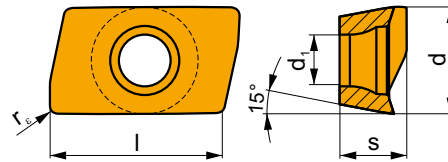


		ANSI		P	M	K	N	S	H			r <sub>c</sub>	f <sub>min</sub>	f <sub>max</sub>	a <sub>p min</sub>	a <sub>p max</sub>	
   	 .004	ADMX 160608SR-F	M9340	█	█					☹	---	.031	.003	.005	.012	.512	
			M8310	█	█	█		█			☹	-	.031	.003	.006	.012	.512
			M8330	█	█	█	□	□			☹	-	.031	.003	.006	.012	.512
			M8340	█	█	█		█			☹	+/-	.031	.003	.006	.012	.512
			8215	█	█	█	█	□			☹	-	.031	.003	.006	.012	.512
   	 .007	ADMX 160604SR-M	M8330	█	█	█		□		☹	-	.016	.004	.010	.012	.512	
			M8340	█	█	█		█		☹	+/-	.016	.004	.010	.012	.512	
			8215	█	█	█		█		●	-	.016	.004	.010	.012	.512	
		ADMX 160608SR-M	M5315				█				☹	---	.031	.004	.008	.012	.512
			M9315	█		█					☹	---	.031	.004	.008	.012	.512
			M9325	█	█			█			☹	---	.031	.004	.008	.012	.512
			M9340	█	█				█		☹	---	.031	.004	.008	.012	.512
			M8310	█	█	█		█			☹	-	.031	.004	.010	.012	.512
			M8330	█	█	█		□			☹	-	.031	.004	.010	.012	.512
			M8340	█	█	█		█			☹	+/-	.031	.004	.010	.012	.512
8215	█	█	█		█			☹	-	.031	.004	.010	.012	.512			
ADMX 160616SR-M	M9325	█	█			█			☹	---	.063	.004	.009	.012	.512		
	M8310	█	█	█		█			☹	-	.063	.004	.012	.012	.512		
	M8330	█	█	█		□			☹	-	.063	.004	.012	.012	.512		
	M8340	█	█	█		█			☹	+/-	.063	.004	.012	.012	.512		
	8215	█	█	█		█			☹	-	.063	.004	.012	.012	.512		
ADMX 160620SR-M	M8340	█	█	█		█			☹	+/-	.079	.004	.012	.012	.512		
	M6330	█	█			█			☹	-	.079	.004	.012	.012	.512		
	M8330	█	█	█		□			☹	-	.079	.004	.012	.012	.512		

i	ANSI		P	M	K	N	S	H			r <sub>c</sub>	f <sub>min</sub>	f <sub>max</sub>	a <sub>p min</sub>	a <sub>p max</sub>	25° .007		
   	ADMX 160630SR-M	M8330	■	▣	■		□		✘	-	.118	.004	.012	.012	.512			
		M8340	■	■	▣		▣		✘	+/-	.118	.004	.012	.012	.512			
	ADMX 160632SR-M	M9325	■	▣			▣		✘	---	.126	.004	.009	.012	.512			
		M6330	▣	■			▣		✘	-	.126	.004	.012	.012	.512			
		M8330	■	▣	■		□		✘	-	.126	.004	.012	.012	.512			
		M8340	■	■	▣		▣		✘	+/-	.126	.004	.012	.012	.512			
		8215	■	▣	■		▣		✘	-	.126	.004	.012	.012	.512			
	ADMX 160640SR-M	M6330	▣	■			▣		✘	-	.157	.004	.012	.012	.512			
		M8330	■	▣	■		□		✘	-	.157	.004	.012	.012	.512			
		M8340	■	■	▣		▣		✘	+/-	.157	.004	.012	.012	.512			
	ADMX 160650SR-M	M8330	■	▣	■		□		✘	-	.197	.004	.012	.012	.512			
		M8340	■	■	▣		▣		✘	+/-	.197	.004	.012	.012	.512			
  	ADMX 160608PR-R	M5315			■				✘	---	.031	.007	.011	.039	.512			
		M9315	■		▣			▣	✘	---	.031	.007	.011	.039	.512			
		M9325	■	▣			▣		✘	---	.031	.007	.011	.039	.512			
		M8310	■	▣	■		▣	▣	✘	-	.031	.007	.014	.039	.512			
		M8330	■	▣	■		□	▣	✘	-	.031	.007	.014	.039	.512			
		M8340	■	▣	▣		▣		✘	+/-	.031	.007	.014	.039	.512			
		8215	▣	▣	■		□	▣	✘	-	.031	.007	.014	.039	.512			
	ADMX 160616PR-R	M5315			■					✘	---	.063	.007	.011	.039	.512		
		M9315	■		▣			▣	✘	---	.063	.007	.011	.039	.512			
		M9325	■	▣			▣		✘	---	.063	.007	.011	.039	.512			
		M8330	■	▣	■		□	▣	✘	-	.063	.007	.014	.039	.512			
		M8340	■	▣	▣		▣		✘	+/-	.063	.007	.014	.039	.512			
8215	▣	▣	■		□	▣	✘	-	.063	.007	.014	.039	.512					
  	ADMX 160608SR-MF	M9340	▣	■		■			✘	---	.031	.002	.006	.012	.512			
		M6330	▣	■			■			✘	-	.031	.002	.006	.012	.512		
		M8340	■	■			■			✘	+/-	.031	.002	.006	.012	.512		
	8215	▣	▣	■		■			✘	---	.031	.002	.006	.012	.512			
  	ADMX 160604SR-MM	M6330	▣	■		■			✘	-	.016	.006	.009	.012	.512			
		M8340	■	■			■			✘	+/-	.016	.006	.009	.012	.512		
	ADMX 160608SR-MM	M9340	▣	■			■			✘	---	.031	.006	.007	.012	.512		
		M6330	▣	■			■			✘	-	.031	.006	.009	.012	.512		
		M8340	■	■			■			✘	+/-	.031	.006	.009	.012	.512		
	ADMX 160616SR-MM	M8345	■	■			■			✘	+/-	.031	.006	.009	.012	.512		
		M9340	▣	■			■			✘	---	.063	.006	.007	.012	.512		
		M6330	▣	■			■			✘	-	.063	.006	.009	.012	.512		
		M8340	■	■			■			✘	+/-	.063	.006	.009	.012	.512		
	8215	■	■			■			✘	+/-	.063	.006	.009	.012	.512			

## ADEX 16

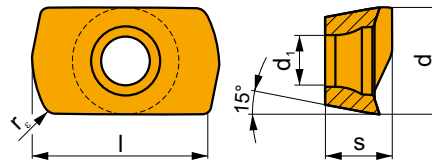
	d	d <sub>1</sub>	l	s
1606	.392	.177	.630	.246



		ANSI		P	M	K	N	S	H			r <sub>ε</sub>	f <sub>min</sub>	f <sub>max</sub>	a <sub>p min</sub>	a <sub>p max</sub>	
 		M9325		■	▣			▣			---	.031	.004	.008	.012	.512	
		M9340		▣	■			▣			---	.031	.004	.008	.012	.512	
		M8330		■	▣	■			□			-	.031	.004	.010	.012	.512
		M8340		■	■	▣			▣			+/-	.031	.004	.010	.012	.512
		8215		■	▣	■			▣			-	.031	.004	.010	.012	.512

## ADEX 16-HF

	d	d <sub>1</sub>	l	s
1606	.392	.177	.630	.231

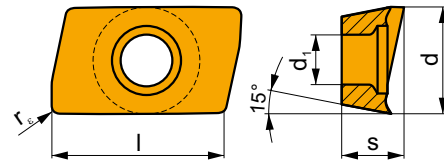


		ANSI		P	M	K	N	S	H			r <sub>ε</sub>	f <sub>min</sub>	f <sub>max</sub>	a <sub>p min</sub>	a <sub>p max</sub>		
  		M9340		▣	■			▣			---	.047	.024	.044	.010	.051		
		M8310		■	▣	□		▣	□			-	.047	.024	.051	.010	.051	
		M8330		■	▣	□			□	□			-	.047	.024	.051	.010	.051
		M8340		■	■	□			▣			+/-	.047	.024	.051	.010	.051	
		8215		■	▣	□			▣	□			-	.047	.024	.051	.010	.051
  		M9325		■	▣			□			---	.047	.024	.046	.010	.051		
		M9340		▣	▣			□			---	.047	.024	.046	.010	.051		
		M8310		■	▣	■			□	■		-	.047	.024	.051	.010	.051	
		M8330		■	▣	■			□	▣		*	.047	.024	.051	.010	.051	
		M8340		■	▣	▣			□			+/-	.047	.024	.051	.010	.051	



## ADEX 16-FA

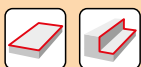
	d	d <sub>1</sub>	l	s
1606	.394	.177	.630	.243



i	ANSI	Material	Grade					Surface	Coating	r <sub>c</sub>	f <sub>min</sub>	f <sub>max</sub>	a <sub>p min</sub>	a <sub>p max</sub>
			P	M	K	N	S							
	ADEX 160604FR-FA	M0315 HF7				■		●	++	.016	.002	.014	.012	.512
	ADEX 160608FR-FA	M0315 HF7				■		●	++	.031	.002	.014	.012	.512
	ADEX 160616FR-FA	HF7				■		●	+/-	.031	.002	.014	.012	.512
	ADEX 160630FR-FA	HF7				■		●	+/-	.063	.002	.014	.012	.512
	ADEX 160630FR-FA	HF7				■		●	+/-	.118	.002	.014	.012	.512

ISO	f <sub>min</sub>	f <sub>max</sub>	M5315	M9315	M9325	M9340	M0315	M6330	M8310	M8340	M8345	8215	M8330	HF7	
P	●	.0039	.0118	1427	1394	1345	1165	-	1050	1198	1066	771	1148	1050	-
	●	.0039	.0098	1329	1280	1214	1033	-	935	1083	935	656	1001	919	-
	✘	.0039	.0059	1214	1148	1066	919	-	820	968	804	558	853	787	-
M	●	.0039	.0098	-	-	804	689	-	689	722	640	459	689	623	-
	●	.0039	.0079	-	-	722	623	-	607	640	558	394	591	558	-
	✘	.0039	.0047	-	-	640	541	-	525	574	476	328	509	476	-
K	●	.0039	.0118	1362	1329	-	-	-	1132	1001	-	1083	1001	-	
	●	.0039	.0098	1263	1214	-	-	-	1033	886	-	951	869	-	
	✘	.0039	.0059	1165	1099	-	-	-	919	771	-	804	755	-	
N	●	.0039	.0118	-	-	-	-	2493	-	-	-	2887	2641	1115	
	●	.0039	.0098	-	-	-	-	2231	-	-	-	2510	2329	1001	
	✘	.0039	.0059	-	-	-	-	1952	-	-	-	2149	2001	869	
S	●	.0039	.0098	-	-	394	344	-	344	361	312	230	344	312	-
	●	.0039	.0079	-	-	361	312	-	295	312	279	197	295	279	-
	✘	.0039	.0047	-	-	312	262	-	262	279	230	164	246	230	-
H	●	.0039	.0098	279	279	-	-	-	230	-	-	230	197	-	
	●	.0039	.0079	262	246	-	-	-	213	-	-	197	180	-	
	✘	.0039	.0047	230	230	-	-	-	180	-	-	164	148	-	

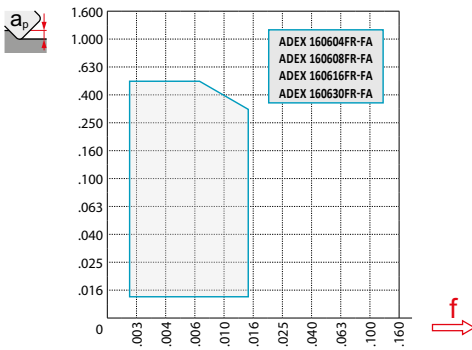
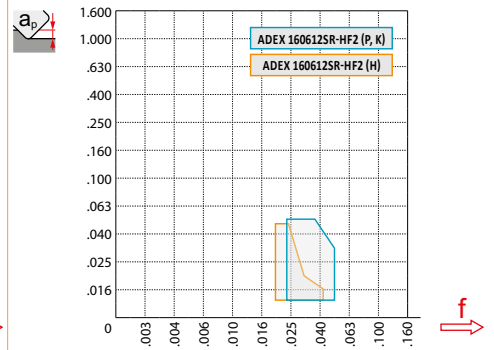
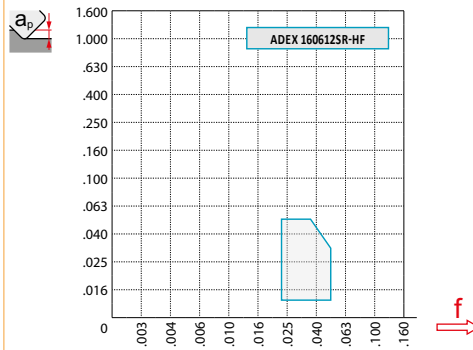
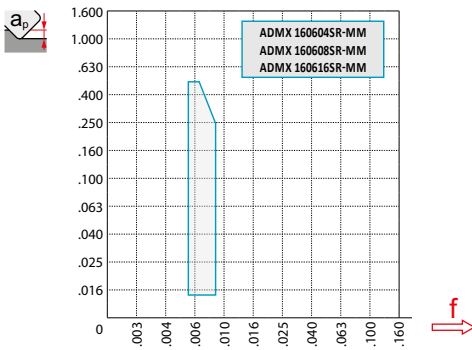
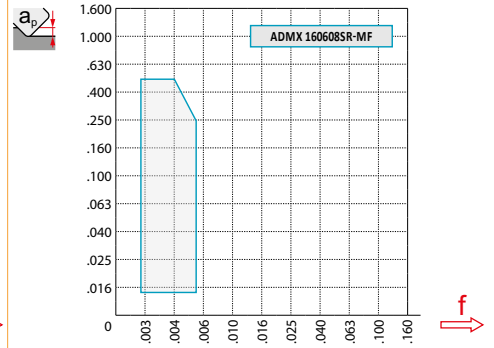
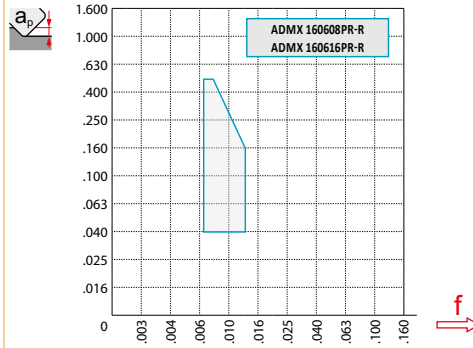
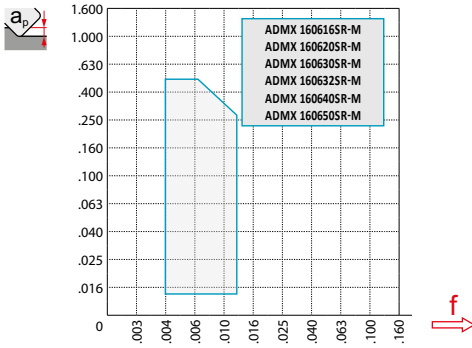
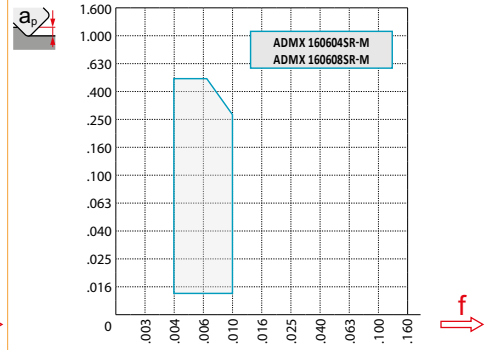
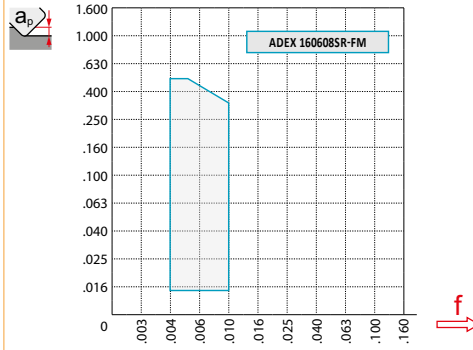
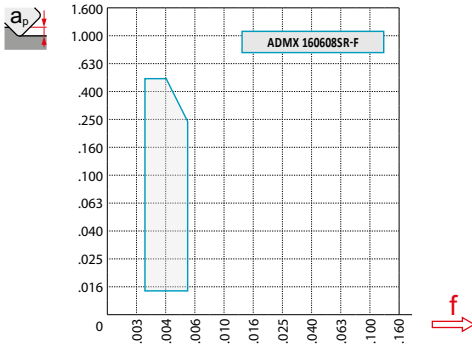
HFC		$f_{min}$	$f_{max}$	M9325	M9340	M9310	M8340	8215	M8330
P	●	.0217	.0492	1132	984	1017	902	968	886
	●	.0217	.0394	1017	869	918	787	836	771
	✘	.0217	.0315	902	771	820	672	722	656
M	●	.0217	.0492	672	574	607	541	574	525
	●	.0217	.0394	607	525	541	459	492	459
	✘	.0217	.0315	541	459	476	394	426	394
K	●	.0217	.0492	-	-	951	836	918	836
	●	.0217	.0394	-	-	869	738	804	738
	✘	.0217	.0315	-	-	771	640	672	640
N	●	.0217	.0492	-	-	-	-	2444	2230
	●	.0217	.0394	-	-	-	-	2132	1968
	✘	.0217	.0315	-	-	-	-	1820	1689
S	●	.0217	.0472	328	279	295	262	279	262
	●	.0217	.0394	295	262	262	230	246	230
	✘	.0217	.0315	262	213	230	180	197	180
H	●	.0197	.0394	-	-	180	-	180	164
	●	.0197	.0315	-	-	180	-	164	148
	✘	.0197	.0236	-	-	148	-	131	115



$\frac{a_e}{D}$	.05	.10	.15	.20	.25	.30	.40	.50	.60	.70	.75	.80	.90	1.00
	1.48	1.35	1.27	1.22	1.19	1.16	1.11	1.08	1.05	1.03	1.00	1.00	1.00	1.00
	2.87	2.05	1.69	1.48	1.33	1.23	1.09	.75	.94	.90	.89	.88	.88	1.00
	.64	.64	.64	.64	.64	.65	.65	.67	.68	.71	.72	.74	.79	1.00

	ADMX 16-F	ADEX 16-FM	ADMX 16-M								ADMX 16-R	
	.031	.031	.016	.031	.063	.079	.118	.126	.157	.197	.031	.063
	.118	.086	.133	.118	.064	.048	.011	.004	.106	.060	.118	.064

	ADMX 16-MF	ADMX 16-MM		ADEX 16-HF	ADEX 16-HF2	ADEX 16-FA				
	.031	.016	.031	.063	.047	.047	.016	.031	.063	.118
	.118	.133	.118	.064	.020	.020	.112	.096	.065	.027



.295



	.039	.236	.512
--	------	------	------

	.011	.007	.004
--	------	------	------



			HFC		
$\varnothing D$	$\alpha_{max}^\circ$	$a_p/l$	$\alpha_{max}^\circ$	$\alpha_{max}^\circ$	$a_p/l$
1.00	12.5	.512/2.362	4.0	8.0	.051/1.748
1.25	7.5	.512/4.000	2.0	7.5	.051/1.500
1.50	5.0	.339/4.000	1.2	4.5	.051/2.559
2.00	3.5	.236/4.000	.8	3.0	1,3/4.000
2.50	2.5	.165/4.000	.5	2.0	0,8/4.000
3.00	2.0	.130/4.000	.4	1.5	0,6/4.000

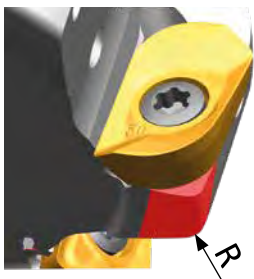


					HFC			
$\varnothing D$	$d_{min}$	$d_{max}$	$\frac{S_{max}}{d_{min}}$	$\frac{S_{max}}{d_{max}}$	$d_{min}$	$d_{max}$	$\frac{S_{max}}{d_{min}}$	$\frac{S_{max}}{d_{max}}$
1.00	1.654	1.969	.394	.492	1.654	1.969	.051	.051
1.25	2.165	2.520	.256	.354	2.165	2.520	.051	.051
1.50	2.835	3.150	.197	.315	2.835	3.150	.051	.051
2.00	3.622	3.937	.177	.236	3.622	3.937	.051	.051
2.50	4.646	4.961	.157	.197	4.646	4.961	.051	.051
3.00	5.354	6.299	.059	.079	5.354	6.299	.051	.051



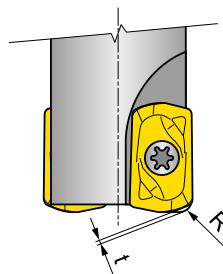
	.098
--	------

**i**



ADMX/ADEX 16	R
ADMX 160630SR-M	.098
ADMX 160632SR-M	.098
ADMX 160640SR-M	.157
ADMX 160650SR-M	.177
ADEX 160612SR-HF	.118
ADEX 160612SR-HF2	.118

**i**



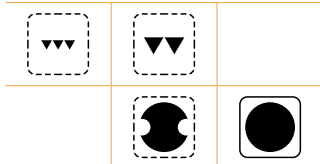
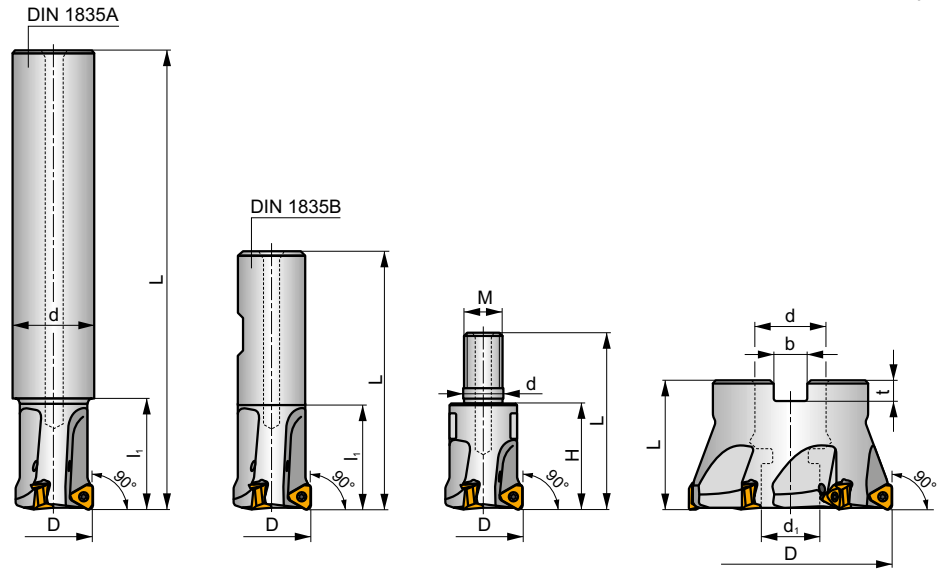
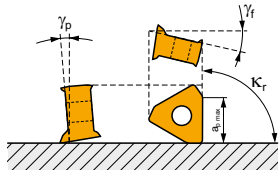
ADEX 16	R	t
	[in]	[in]
ADEX 160612SR-HF	.102	.022
ADEX 160612SR-HF2	.098	.022

ISTN10

P M K N S



$k_r$	90°
$a_{pmax}$	.197



	ANSI	D	L	d	d <sub>1</sub>	l <sub>1</sub>	H	M	b	t	$\gamma_r^\circ$	$\gamma_p^\circ$			max.		lbs		
	075A2R114C075-ISTN10-C	.750	5.906	.750	-	1.142	-	-	-	-	-16.5	-11	2	-	27600	✓	.64	IGI292	ISQ300
	075A3R114C075-ISTN10-C	.750	5.906	.750	-	1.142	-	-	-	-	-16.5	-11	3	-	27600	✓	.62	IGI292	ISQ300
	100A3R140C100-ISTN10-C	1.000	6.693	1.000	-	1.339	-	-	-	-	-16	-11	3	-	24700	✓	1.28	IGI292	ISQ300
	100A4R140C100-ISTN10-C	1.000	6.693	1.000	-	1.339	-	-	-	-	-16	-11	4	✓	24700	✓	1.28	IGI292	ISQ300
	125A4R146C125-ISTN10-C	1.250	7.677	1.250	-	1.457	-	-	-	-	-16	-11	4	✓	21800	✓	2.31	IGI292	ISQ300
	125A5R146C125-ISTN10-C	1.250	7.677	1.250	-	1.457	-	-	-	-	-16	-11	5	✓	21800	✓	2.31	IGI292	ISQ300
	075A2R125W075-ISTN10-C	.750	3.500	.750	-	1.250	-	-	-	-	-16.5	-11	2	-	27600	✓	.33	IGI292	ISQ300
	075A3R125W075-ISTN10-C	.750	3.500	.750	-	1.250	-	-	-	-	-16.5	-11	3	-	27600	✓	.33	IGI292	ISQ300
	100A3R150W100-ISTN10-C	1.000	4.000	1.000	-	1.500	-	-	-	-	-16	-11	3	-	24700	✓	.68	IGI292	ISQ300
	100A4R150W100-ISTN10-C	1.000	4.000	1.000	-	1.500	-	-	-	-	-16	-11	4	✓	24700	✓	.68	IGI292	ISQ300
	125A4R150W125-ISTN10-C	1.250	4.331	1.250	-	1.500	-	-	-	-	-16	-11	4	✓	21800	✓	1.21	IGI292	ISQ300
	125A5R150W125-ISTN10-C	1.250	4.331	1.250	-	1.500	-	-	-	-	-16	-11	5	✓	21800	✓	1.19	IGI292	ISQ300
	075A2R102M10-ISTN10-C	.750	1.772	.413	-	-	1.024	M10	-	-	-16.5	-11	2	-	-	✓	.09	IGI292	ISQ300
	075A3R102M10-ISTN10-C	.750	1.772	.413	-	-	1.024	M10	-	-	-16.5	-11	3	-	-	✓	.09	IGI292	ISQ300
	100A3R130M12-ISTN10-C	1.000	2.165	.492	-	-	1.300	M12	-	-	-16	-11	3	-	-	✓	.18	IGI292	ISQ300
	100A4R130M12-ISTN10-C	1.000	2.165	.492	-	-	1.300	M12	-	-	-16	-11	4	✓	-	✓	.18	IGI292	ISQ300
	125A4R169M16-ISTN10-C	1.250	2.598	.669	-	-	1.693	M16	-	-	-16	-11	4	✓	-	✓	.44	IGI292	ISQ300
	125A5R169M16-ISTN10-C	1.250	2.598	.669	-	-	1.693	M16	-	-	-16	-11	5	✓	-	✓	.44	IGI292	ISQ300
	150A04R-IS90TN10-C	1.500	1.575	.500	.433	-	-	-	.258	.165	-15	-11	4	✓	19500	✓	.49	IGI292	ISQ302
	150A06R-IS90TN10-C	1.500	1.575	.500	.433	-	-	-	.258	.165	-15	-11	6	✓	19500	✓	.46	IGI292	ISQ302
	200A05R-IS90TN10-C	2.000	1.575	.750	.630	-	-	-	.321	.193	-15	-11	5	✓	17400	✓	.84	IGI292	ISQ303
	200A07R-IS90TN10-C	2.000	1.575	.750	.630	-	-	-	.321	.193	-15	-11	7	✓	17400	✓	.86	IGI292	ISQ303
	250A06R-IS90TN10-C	2.500	1.575	.750	.630	-	-	-	.321	.193	-15	-11	6	✓	15500	✓	1.15	IGI292	ISQ303
	250A09R-IS90TN10-C	2.500	1.575	.750	.630	-	-	-	.321	.193	-15	-11	9	✓	15500	✓	1.15	IGI292	ISQ303
	300A10R-IS90TN10-C	3.000	1.969	1.000	.827	-	-	-	.224	.394	-15	-11	10	✓	13800	✓	2.34	IGI292	ISQ304



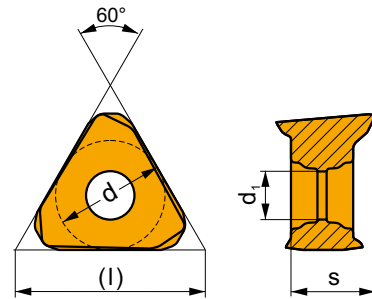
IGI292

TNGX 1004..

ISQ300	US 52506-T07P	.8	M 2.5	.240	-	-	Flag T07P	-
ISQ302	US 52506-T07P	.8	M 2.5	.240	D-T07P/T09P	FG-15	-	HS 025100
ISQ303	US 52506-T07P	.8	M 2.5	.240	D-T07P/T09P	FG-15	-	HS 037100
ISQ304	US 52506-T07P	.8	M 2.5	.240	D-T07P/T09P	FG-15	-	HS 050125

## TNGX 10

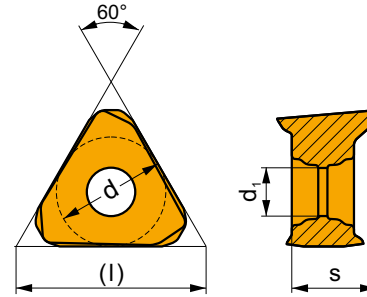
	d	d <sub>1</sub>	l	s
1004	.236	.110	.409	.185



i	ANSI	Material	P	M	K	N	S	H	?	Drop	r <sub>c</sub>	f <sub>min</sub>	f <sub>max</sub>	a <sub>p min</sub>	a <sub>p max</sub>
  .002	TNGX 100402SR-F	M8330	■	■	■	□			●	-	.008	.001	.004	.004	.197
		M8340	■	■	■	■			●	+/-	.008	.001	.004	.004	.197
		8230	■	■	■	■			●	-	.008	.001	.004	.004	.197
	TNGX 100404SR-F	M9340	■	■	■	■			●	---	.016	.001	.004	.004	.197
		M6330	■	■	■	■			●	-	.016	.001	.004	.004	.197
		M8330	■	■	■	□			●	-	.016	.001	.004	.004	.197
		M8340	■	■	■	■			●	+/-	.016	.001	.004	.004	.197
		8215	■	■	■	■			●	-	.016	.001	.004	.004	.197
		8230	■	■	■	■			●	-	.016	.001	.004	.004	.197
TNGX 100408SR-F	M9340	■	■	■	■			●	---	.031	.001	.004	.004	.197	
	M6330	■	■	■	■			●	-	.031	.001	.004	.004	.197	
	M8330	■	■	■	□			●	-	.031	.001	.004	.004	.197	
	M8340	■	■	■	■			●	+/-	.031	.001	.004	.004	.197	
	8215	■	■	■	■			●	-	.031	.001	.004	.004	.197	
	8230	■	■	■	■			●	-	.031	.001	.004	.004	.197	
	TNGX 100404SR-M	M9340	■	■	■	■			●	---	.016	.002	.005	.012	.197
M6330		■	■	■	■			●	-	.016	.002	.006	.012	.197	
M8330		■	■	■	□			●	-	.016	.002	.006	.012	.197	
M8340		■	■	■	■			●	+/-	.016	.002	.006	.012	.197	
M8345		■	■	■	■			●	+/-	.016	.002	.006	.012	.197	
8215		■	■	■	■			●	-	.016	.002	.006	.012	.197	
8230		■	■	■	■			●	-	.016	.002	.006	.012	.197	
TNGX 100408SR-M		M9340	■	■	■	■			●	---	.031	.002	.005	.012	.197
		M6330	■	■	■	■			●	-	.031	.002	.006	.012	.197
		M8310	■	■	■	■			●	-	.031	.002	.006	.012	.197
	M8330	■	■	■	□			●	-	.031	.002	.006	.012	.197	
	M8340	■	■	■	■			●	+/-	.031	.002	.006	.012	.197	
	M8345	■	■	■	■			●	+/-	.031	.002	.006	.012	.197	
	8215	■	■	■	■			●	-	.031	.002	.006	.012	.197	
8230	■	■	■	■			●	-	.031	.002	.006	.012	.197		

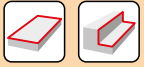
## TNGX 10-FA

	d	d <sub>1</sub>	l	s
1004	.236	.110	.409	.185



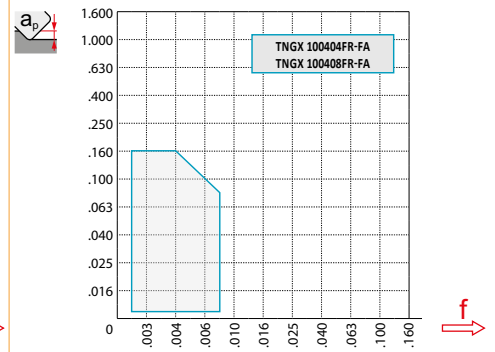
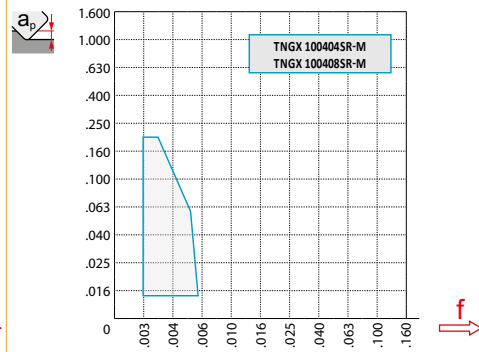
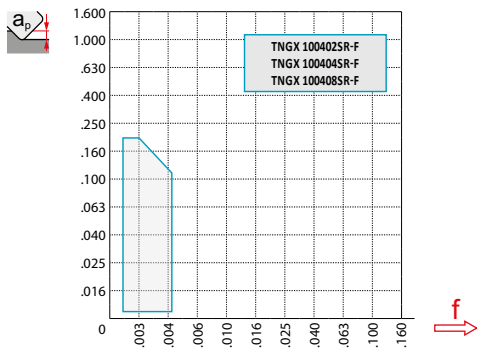
		ANSI		P	M	K	N	S	H			r <sub>c</sub>	f <sub>min</sub>	f <sub>max</sub>	a <sub>p min</sub>	a <sub>p max</sub>
		TNGX 100404FR-FA	M0315				■			●	++	.016	.001	.008	.004	.157
		TNGX 100408FR-FA	HF7				■			●	+/-	.016	.001	.008	.004	.157
		TNGX 100408FR-FA	M0315				■			●	++	.031	.001	.008	.004	.157
			HF7				■			●	+/-	.031	.001	.008	.004	.157

ISO	f <sub>min</sub>	f <sub>max</sub>	M9340	M0315	M6330	M8310	M8340	M8345	8215	M8330	HF7	
P	●	.0020	.0059	817	-	735	840	748	541	804	735	-
	⊗	.0020	.0043	725	-	656	758	656	459	702	643	-
	✘	.0020	.0031	643	-	574	679	564	390	597	551	-
M	●	.0020	.0047	482	-	482	505	449	322	482	436	-
	⊗	.0020	.0020	436	-	427	449	390	276	413	390	-
	✘	.0020	.0024	381	-	367	404	335	230	358	335	-
K	●	.0020	.0059	-	-	-	794	702	-	758	702	-
	⊗	.0020	.0039	-	-	-	725	620	-	666	610	-
	✘	.0020	.0031	-	-	-	643	541	-	564	528	-
N	●	.0020	.0079	-	1745	-	-	-	-	-	-	781
	⊗	.0020	.0059	-	1562	-	-	-	-	-	-	702
	✘	.0020	.0039	-	1368	-	-	-	-	-	-	610
S	●	.0020	.0047	243	-	243	253	220	161	243	220	-
	⊗	.0020	.0031	220	-	207	220	197	138	207	197	-
	✘	.0020	.0024	184	-	184	197	161	115	174	161	-



$a_e/D$	.05	.10	.15	.20	.25	.30	.40	.50	.60	.70	.75	.80	.90	1.00
$X.V$	1.48	1.35	1.27	1.22	1.19	1.16	1.11	1.08	1.05	1.03	1.00	1.00	1.00	1.00
$X.f$	2.87	2.05	1.69	1.48	1.33	1.23	1.09	.75	.94	.90	.89	.88	.88	1.00
$X.f$	.64	.64	.64	.64	.64	.65	.65	.67	.68	.71	.72	.74	.79	1.00

	TNGX 10-F			TNGX 10-M			TNGX 10-FA		
$r_\epsilon$	.008	.016	.031	.016	.031	.016	.031	.016	.031
$a$	.060	.053	.036	.053	.036	.052	.037		



.059



$a_p$	.039	.118	.197
$f$	.004	.003	.002





	$\alpha_{max}^{\circ}$	$a_p/l$
.750	1.60	.106/4.00
1.00	1.00	.067/4.00
1.25	.80	.051/4.00
1.50	.60	.035/4.00
2.00	.50	.028/4.00
2.50	.40	.020/4.00
3.00	.25	.012/4.00



	$d_{min}$	$d_{max}$	$\frac{J}{d_{max}} S_{max}$	$\frac{J}{d_{max}} S_{max}$
.750	1.457	1.575	.047	.047
1.00	1.850	1.969	.039	.039
1.25	2.402	2.520	.039	.039
1.50	3.031	3.150	.035	.035
2.00	3.819	3.937	.035	.035
2.50	4.843	4.961	.035	.035
3.00	6.181	6.299	.035	.035



$a_p$
.008

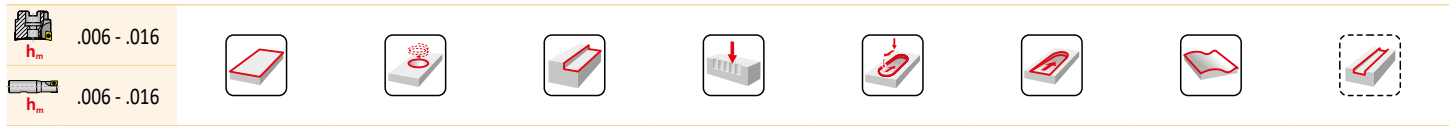
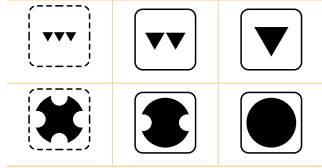
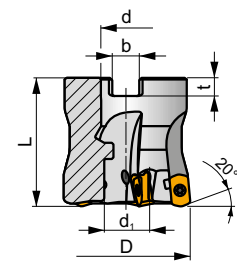
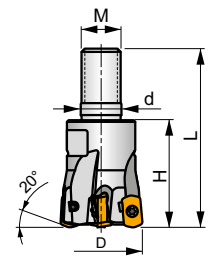
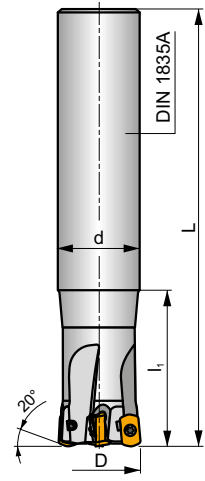
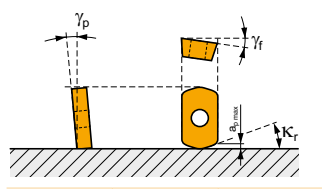
**ISBN10**

**P M K S H**

**S**



$\kappa_r$	20°
$a_{pmax}$	.039



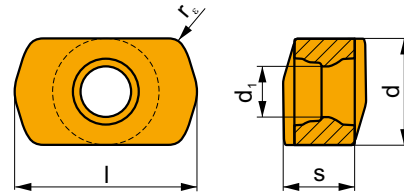
ANSI	D	D <sub>2</sub>	L	d	d <sub>1</sub>	l <sub>1</sub>	H	M	b	t	$\gamma_r^\circ$	$\gamma_p^\circ$							
<b>062E2R118C062-ISBN10-C</b>	.625	-	3.937	.625	-	1.181	-	-	-	-	-10	-12	2	-	31100	✓	.26	GI329	ICO310
<b>062E2R197C062-ISBN10-C</b>	.625	-	5.906	.625	-	1.969	-	-	-	-	-10	-12	2	-	31100	✓	.40	GI329	ICO310
<b>075E3R157C075-ISBN10-C</b>	.750	-	5.118	.750	-	1.575	-	-	-	-	-10	-10,5	3	-	28400	✓	.49	GI329	ICO310
<b>075E3R315C075-ISBN10-C</b>	.750	-	6.299	.750	-	3.150	-	-	-	-	-10	-10,5	3	-	28400	✓	.57	GI329	ICO310
<b>100E4R197C100-ISBN10-C</b>	1.00	-	5.512	1.00	-	1.969	-	-	-	-	-10	-9	4	✓	24600	✓	.95	GI329	ICO310
<b>100E4R394C100-ISBN10-C</b>	1.00	-	7.087	1.00	-	3.937	-	-	-	-	-10	-9	4	✓	24600	✓	1.17	GI329	ICO310
<b>100E4R472C100-ISBN10-C</b>	1.00	-	8.661	1.00	-	4.724	-	-	-	-	-10	-9	4	✓	24600	✓	1.43	GI329	ICO310
<b>100E5R197C100-ISBN10-C</b>	1.00	-	5.512	1.00	-	1.969	-	-	-	-	-10	-9	5	-	24600	✓	.97	GI329	ICO310
<b>125E5R276C125-ISBN10-C</b>	1.25	-	5.906	1.25	-	2.756	-	-	-	-	-10	-8	5	✓	22000	✓	1.57	GI329	ICO310
<b>125E6R276C125-ISBN10-C</b>	1.25	-	5.906	1.25	-	2.756	-	-	-	-	-10	-8	6	✓	22000	✓	1.59	GI329	ICO310
<b>125E5R472C125-ISBN10-C</b>	1.25	-	7.874	1.25	-	4.724	-	-	-	-	-10	-8	5	✓	22000	✓	2.03	GI329	ICO310
<b>100E4R130M12-ISBN10-C</b>	1.00	-	2.165	.492	-	-	1.299	M12	-	-	-10	-9	4	✓	24600	✓	.18	GI329	ICO310
<b>100E5R130M12-ISBN10-C</b>	1.00	-	2.165	.492	-	-	1.299	M12	-	-	-10	-9	5	-	24600	✓	.18	GI329	ICO310
<b>125E5R157M16-ISBN10-C</b>	1.25	-	2.480	.669	-	-	1.575	M16	-	-	-10	-8	5	✓	22000	✓	.42	GI329	ICO310
<b>125E6R157M16-ISBN10-C</b>	1.25	-	2.480	.669	-	-	1.575	M16	-	-	-10	-8	6	✓	22000	✓	.42	GI329	ICO310
<b>150A05R-ISMOBN10-C</b>	1.50	-	1.575	.500	.433	-	-	-	.258	.165	-10	-7	5	✓	20100	✓	.46	GI329	ICO312
<b>150A07R-ISMOBN10-C</b>	1.50	-	1.575	.500	.433	-	-	-	.258	.165	-10	-7	7	-	20100	✓	.46	GI329	ICO312

GI329	BNGX 10T3..	ANHX 10T3..

ICO310	US42507-T07P	0,9	M 2,5	.275	-	-	Flag T07P	-
ICO312	US42507-T07P	0,9	M 2,5	.275	D-T07P/T09P	FG-15	-	HS025100

# BNGX 10

	d	d <sub>1</sub>	l	s
10T3	.228	.109	.391	.154

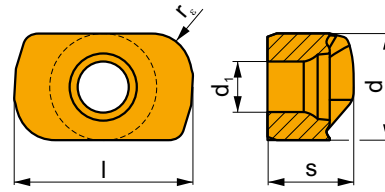


i	ANSI	Material	Material						Coating	Coolant	r <sub>c</sub>	f <sub>min</sub>	f <sub>max</sub>	a <sub>p min</sub>	a <sub>p max</sub>
			P	M	K	N	S	H							
	BNGX 10T308SR-M	M9325	■	□					●	---	.031	.008	.041	.012	.039
		M6330	▣	■			■		●	-	.031	.008	.055	.012	.039
		M8310	■	□	■			▣	●	-	.031	.008	.055	.012	.039
		M8330	■	□	■			▣	●	-	.031	.008	.055	.012	.039
		M8340	■	□	▣				✘	+/-	.031	.008	.055	.012	.039
		M8345	■	□				▣	✘	+/-	.031	.008	.055	.012	.039
		8215	■	□	■			▣	●	-	.031	.008	.055	.012	.039
	BNGX 10T308SR-MM	M9325	▣	▣			▣	●	---	.031	.008	.033	.012	.039	
		M9340	▣	■			■		●	---	.031	.008	.033	.012	.039
		M6330	▣	■			■		●	-	.031	.010	.043	.012	.039
		M8310	▣	▣	□			□	●	-	.031	.010	.043	.012	.039
		M8330	▣	▣	□	□	□		●	-	.031	.010	.043	.012	.039
		M8340	▣	■	□		■		●	+/-	.031	.010	.043	.012	.039
		M8345	▣	■			■		●	+/-	.031	.010	.043	.012	.039
	BNGX 10T308SR-HM	M8310	□		■		■	✘	-	.031	.004	.039	.004	.039	
		M8330	□		■		▣	✘	-	.031	.004	.039	.004	.039	
		8215	□		■		■	✘	-	.031	.004	.039	.004	.039	

ISO	f <sub>min</sub>	f <sub>max</sub>	M9325	M9340	M6330	M8310	M8330	M8340	M8345	8215	
P	●	.008	.055	971	867	694	876	800	727	580	842
	●	.008	.046	893	798	638	806	736	669	533	774
	✘	.008	.037	767	685	548	672	613	574	458	636
M	●	.008	.043	487	509	487	417	450	432	340	465
	●	.008	.035	448	469	448	384	414	397	312	428
	✘	.008	.026	385	402	385	330	356	341	268	367
K	●	.008	.059	-	-	-	829	753	683	-	794
	●	.008	.049	-	-	-	763	693	628	-	730
	✘	.008	.039	-	-	-	655	595	539	-	627
S	●	.008	.035	221	236	214	192	207	192	155	-
	●	.008	.030	204	217	197	177	190	177	143	-
	✘	.004	.026	175	187	169	152	163	152	122	-
H	●	.002	.028	-	-	-	173	159	-	-	166
	●	.002	.022	-	-	-	160	146	-	-	153
	✘	.002	.017	-	-	-	137	125	-	-	131

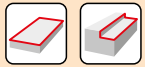
# ANHX 10

	d	d <sub>1</sub>	l	s
10T3	.228	.109	.383	.185



i	ANSI	M8310	P	M	K	N	S	H	?	r <sub>e</sub>	f <sub>min</sub>	f <sub>max</sub>	a <sub>p min</sub>	a <sub>p max</sub>
	ANHX 10T320SR-F	M8310	■	■	□	□	□	■	●	.079	.002	.006	.004	.118
		M8330	■	■	□	□	□	■	✘	.079	.002	.006	.004	.118

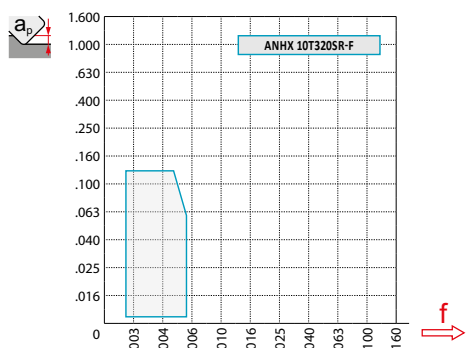
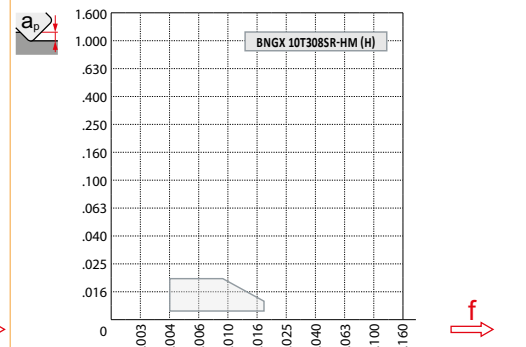
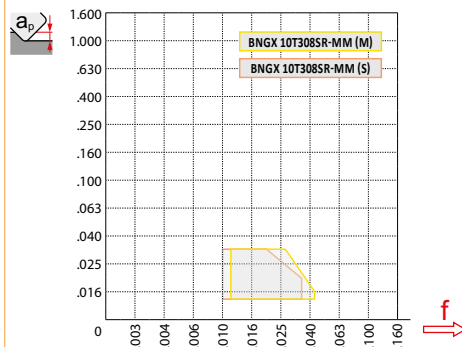
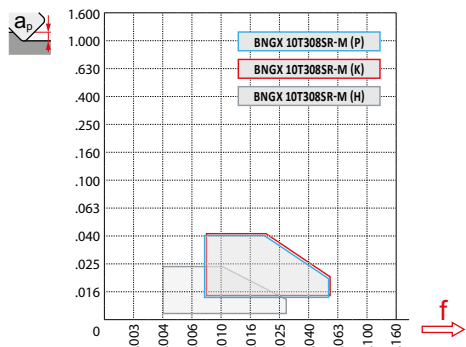
ISO	f <sub>min</sub>	f <sub>max</sub>	M8310	M8330	M8340
P	●	.002	1312	1058	1058
	●	.002	1207	973	973
	✘	.002	1037	836	836
M	●	.002	664	623	697
	●	.002	611	574	641
	✘	.002	525	492	551
K	●	.002	1239	993	1116
	●	.002	1139	913	1026
	✘	.002	978	784	881
S	●	.002	295	279	312
	●	.002	272	257	287
	✘	.002	233	220	246
H	●	.002	254	230	-
	●	.002	234	211	-
	✘	.002	201	181	-



$a_p/D$	.05	.10	.15	.20	.25	.30	.40	.50	.60	.70	.75	.80	.90	1.00
$X.V$	1.48	1.35	1.27	1.22	1.19	1.16	1.11	1.08	1.05	1.03	1.00	1.00	1.00	1.00
$X.f$	2.87	2.05	1.69	1.48	1.33	1.23	1.09	.75	.94	.90	.89	.88	.88	1.00
$X.f$	.64	.64	.64	.64	.64	.65	.65	.67	.68	.71	.72	.74	.79	1.00

	BNGX 10-M	BNGX 10-MM	BNGX 10-HM
$r_\epsilon$	.031	.031	.031
$a$	-	-	-

	ANHX 10 - F
$r_\epsilon$	.079
$a$	.036



**BNGX 10 (HFC)**

		.000	.012	.016	.020	.024	.028	.031	.035	.039
.625		.365	.501	.521	.539	.554	.568	.581	.593	.604
.75		.490	.626	.646	.664	.679	.693	.706	.718	.729
1		.740	.876	.896	.914	.929	.943	.956	.968	.979
1.25		.990	1.126	1.146	1.164	1.179	1.193	1.206	1.218	1.229
1.5		1.240	1.376	1.396	1.414	1.429	1.443	1.456	1.468	1.479

	.000	.012	.016	.020	.024	.028	.031	.035	.039
	-	.051	.043	.035	.031	.028	.027	.026	.020


**BNGX 10**

.625	.138	.005
.750	.157	.005
1.000	.157	.006
1.250	.157	.006
1.500	.157	.007


**BNGX 10 (HFC)**

	.012	.024	.039
	.043	.024	.012


**BNGX 10 (HFC)**

	$\alpha_{max}^{\circ}$	$a_p/l$
.625	4.0	.0393/629
.750	4.0	.0393/629
1.000	2.6	.0393/945
1.250	1.9	.0393/1.260
1.500	1.5	.0393/1.575

**ANHX 10**

	$\alpha_{max}^{\circ}$	$a_p/l$
.625	1.6	.104/3.937
.750	1.2	.077/3.937
1.000	.8	.049/3.937
1.250	.5	.030/3.937
1.500	.4	.016/3.937


**BNGX 10 (HFC)**

.625	.016	.006
.750	.028	.006
1.000	.028	.008
1.250	.028	.008
1.500	.028	.008

**BNGX 10 (HFC)**

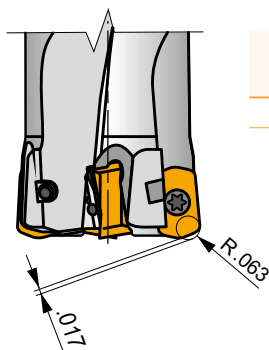
	$d_{min}$	$d_{max}$		
.625	.870	1.240	.020	.020
.750	1.087	1.492	.020	.020
1.000	1.583	1.992	.020	.020
1.250	2.083	2.492	.020	.020
1.500	2.583	2.992	.020	.020



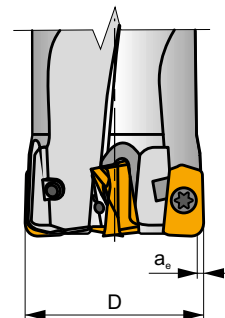
		.118	.197	.394	.591	.787	1.181	1.575	1.969	2.362	3.150	3.937
.625		.017	.022	.031	.038	.044	.054	.063	.070	.077	.089	.099
.750		.019	.024	.034	.042	.049	.060	.069	.077	.084	.097	.109
1.000		.022	.028	.040	.049	.056	.069	.079	.089	.097	.112	.125
1.250		.024	.031	.044	.054	.063	.077	.089	.099	.109	.125	.140
1.500		.027	.034	.049	.060	.069	.084	.097	.109	.119	.137	.154

**ANHX 10**

		.118	.197	.394	.591	.787	1.181	1.575	1.969	2.362	3.150	3.937
.079		.009	.011	.016	.019	.022	.027	.031	.035	.039	.045	.050

**i**


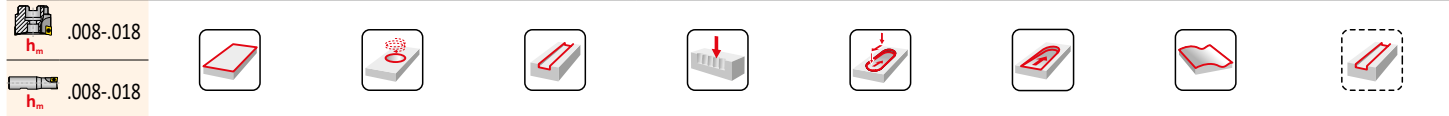
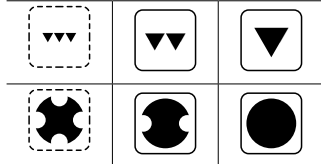
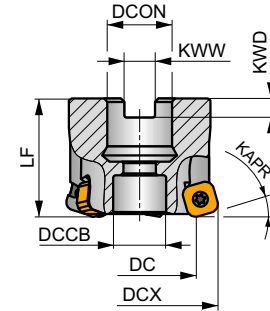
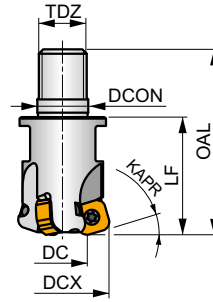
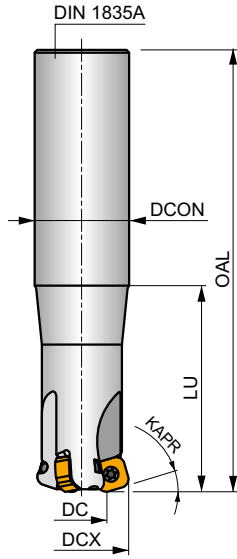
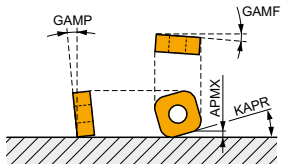
	R	t
<b>BNGX 10T308</b>	.063	.017



	max $a_e/D$
<b>ANHX 10T320</b>	.05



KAPR	18°
APMX	.067 in



ANSI	DCX	DC	LF	DCON MS	DCCB	KWW	KWD	GAMP	GAMF										
	[in]	[in]	[in]	[in]	[in]	[in]	[in]	[°]	[°]										
<b>150A04R-ISMOSN11-C</b>	1.500	0.957	1.575	0.500	0.409	0.258	0.165	-10	-10.5	4	✓	16100	✓	0.18	G1339	IC0316	-	-	-
<b>200A05R-ISMOSN11-C</b>	2.000	1.453	1.575	0.750	0.630	0.321	0.193	-10	-10	5	✓	13900	✓	0.34	G1339	IC0318	-	-	-
<b>200A06R-ISMOSN11-C</b>	2.000	1.453	1.575	0.750	0.630	0.321	0.193	-10	-10	6	✓	13900	✓	0.34	G1339	IC0318	-	-	-
<b>250A06R-ISMOSN11-C</b>	2.500	1.953	1.575	0.750	0.630	0.321	0.193	-10	-10	6	✓	12400	✓	0.49	G1339	IC0318	-	-	-
<b>250A08R-ISMOSN11-C</b>	2.500	1.953	1.575	0.750	0.630	0.321	0.193	-10	-10	8	✓	12400	✓	0.49	G1339	IC0318	-	-	-
<b>300A07R-ISMOSN11-C</b>	3.000	2.453	1.969	1.000	0.827	0.382	0.224	-10	-10	7	✓	11400	✓	1.02	G1339	IC0320	-	-	-
<b>300A09R-ISMOSN11-C</b>	3.000	2.453	1.969	1.000	0.827	0.382	0.224	-10	-10	9	✓	11400	✓	1.01	G1339	IC0320	-	-	-
<b>400A08R-ISMOSN11-C</b>	4.000	3.453	1.969	1.500	1.417	0.630	0.382	-10	-10	8	✓	9800	✓	1.93	G1339	IC0322	-	-	-

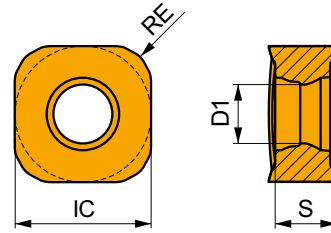
	G1339		SNGX 1104..
--	-------	--	-------------

IC0316	US 44012-T15P	3.5	M4	.472	D-T08P/T15P	FG-15	HCS025150C
IC0318	US 44012-T15P	3.5	M4	.472	D-T08P/T15P	FG-15	HS037100C
IC0320	US 44012-T15P	3.5	M4	.472	D-T08P/T15P	FG-15	HS050125C
IC0322	US 44012-T15P	3.5	M4	.472	D-T08P/T15P	FG-15	HCS075175C



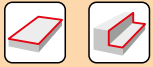
# SNGX 11

	IC	D1	S
1104	.417	.180	.187



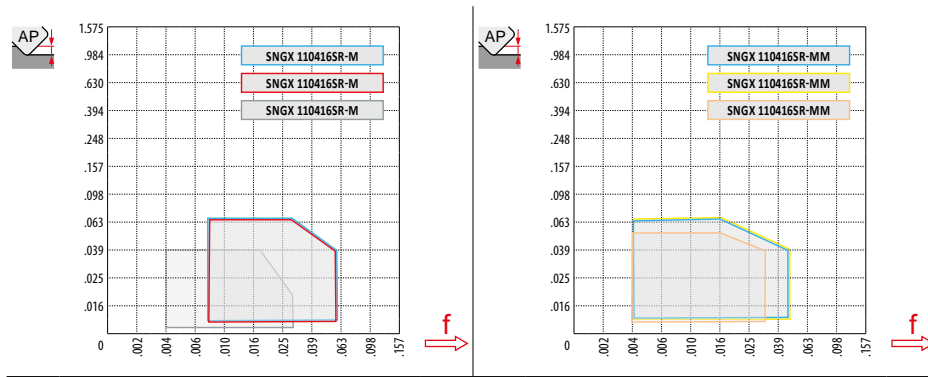
	ANSI		P	M	K	N	S	H			RE	FN	FX	APMN	APMX
    	<b>SNGX 110416SR-M</b>	<b>M9325</b>	■						●	---	.063	.008	.044	.008	.067
	<b>M9340</b>	■							✘	---	.063	.008	.044	.008	.067
	<b>M8310</b>	■		▣				▣	✘	-	.063	.008	.059	.008	.067
	<b>M8330</b>	■		▣				▣	✘	-	.063	.008	.059	.008	.067
	<b>M8340</b>	■		▣					✘	+/-	.063	.008	.059	.008	.067
	<b>8215</b>	■		▣				▣	✘	-	.063	.008	.059	.008	.067
   	<b>SNGX 110416SR-MM</b>	<b>M9340</b>	▣	■			■		●	---	.063	.004	.035	.008	.067
	<b>M6330</b>	▣	■				■		✘	-	.063	.004	.047	.008	.067
	<b>M8340</b>	▣	■				■		✘	+/-	.063	.004	.047	.008	.067
	<b>M8345</b>	▣	■				■		✘	+/-	.063	.004	.047	.008	.067

ANSI	FN	FX	M9325	M9340	M6330	M8310	M8330	M8340	M8345	8215	
P	●	.008	.059	1099	980	755	951	896	808	632	902
	●	.008	.049	1011	902	694	875	824	743	581	830
	✘	.008	.039	868	774	596	752	705	638	499	713
M	●	.004	.047	-	574	533			468	369	-
	●	.004	.039	-	528	491			430	340	-
	✘	.004	.031	-	454	421			369	292	-
K	●	.008	.059	-	-	-	902	846	779	-	853
	●	.008	.049	-	-	-	830	778	717	-	785
	✘	.008	.039	-	-	-	713	666	616	-	674
S	●	.004	.033	-	262	238	-	-	205	164	-
	●	.004	.027	-	241	219	-	-	189	151	-
	✘	.004	.024	-	207	188	-	-	162	130	-
H	●	.004	.030	-	-	-	189	174	-	-	172
	●	.004	.024	-	-	-	174	157	-	-	158
	✘	.004	.018	-	-	-	149	135	-	-	136



$a_e$ DCX	.05	.10	.15	.20	.25	.30	.40	.50	.60	.70	.75	.80	.90	1.00
	1.48	1.35	1.27	1.22	1.19	1.16	1.11	1.08	1.05	1.03	1.02	1.01	.99	.98
	2.87	2.05	1.69	1.48	1.33	1.23	1.09	.75	.94	.90	.89	.88	.88	1.00
	.64	.64	.64	.64	.64	.65	.65	.67	.68	.71	.72	.74	.79	1.00

	SNGX 11 - M	SNGX 11 - MM
	.063	.063
	-	-



HFC														
DCX	AP	.000	.008	.016	.024	.031	.039	.043	.047	.051	.055	.059	.063	.067
1.500		.957	1.005	1.054	1.102	1.151	1.199	1.223	1.247	1.272	1.296	1.320	1.344	1.369
2.000		1.453	1.501	1.550	1.598	1.647	1.695	1.719	1.744	1.768	1.792	1.816	1.840	1.865
2.500		1.953	2.001	2.050	2.098	2.147	2.195	2.219	2.244	2.268	2.292	2.316	2.340	2.365
3.000		2.453	2.501	2.550	2.598	2.647	2.695	2.719	2.744	2.768	2.792	2.816	2.840	2.865
4.000		3.453	3.501	3.550	3.598	3.647	3.695	3.719	3.744	3.768	3.792	3.816	3.840	3.865



SNGX		
DCX	FX	
1.500	.204	.012
2.000	.208	.012
2.500	.212	.012
3.000	.216	.014
4.000	.216	.014



SNGX (HFC)		
DCX	RPMX	APMX/I
1.500	.8	.047/3.937
2.000	.8	.035/3.937
2.500	.7	.028/3.937
3.000	.7	.020/3.937
4.000	.5	.012/3.937



SNGX (HFC)		
DCX	AP	FX
1.500	.008	.012
2.000	.012	.016
2.500	.012	.016
3.000	.012	.016
4.000	.012	.016



	$\mu\text{m}$	.118	.197	.394	.591	.787	1.181	1.575	1.969	2.352	3.150	3.937
1.500		.027	.034	.049	.060	.069	.084	.097	.109	.119	.137	.154
2.000		.031	.040	.056	.069	.079	.097	.112	.125	.137	.159	.177
2.500		.034	.044	.063	.077	.089	.109	.125	.140	.154	.177	.198
3.000		.038	.049	.069	.084	.097	.119	.137	.154	.168	.194	.217
4.000		.043	.056	.079	.097	.112	.137	.159	.177	.194	.224	.251

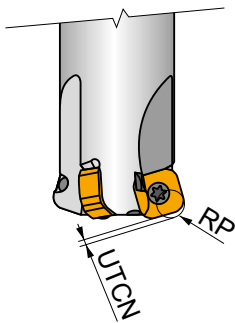


SNGX				
	.008	.020	.039	.067
	.047	.039	.020	.010



SNGX (HFC)				
	$d_{\min}$	$d_{\max}$		
1.500	2.362	2.984	.033	.057
2.000	3.346	3.992	.037	.055
2.500	4.331	4.992	.040	.055
3.000	5.354	5.984	.039	.049
4.000	7.323	7.992	.036	.044

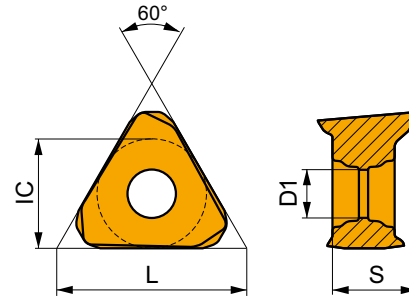
**i**



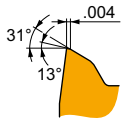
SNGX	RP	UTCN
	[in]	[in]
SNGX 110416	.181	.036

## TNGX 10

	IC	D1	L	S
100412	.236	.110	.409	.181
100416	.236	.110	.409	.179



i	ANSI	M8330	P	M	K	N	S	H	?	RE	FN	FX	APMN	APMX	
															RE
1	TNGX 100412SR-M	M8330	■	▣	▣	▣	▣	▣	●	-	.047	.002	.006	.012	.197
		M8340	■	■	▣	▣	▣	▣	●	+/-	.047	.002	.006	.012	.197
U	TNGX 100416SR-M	M8310	■	▣	▣	▣	▣	▣	●	-	.063	.002	.006	.012	.197
		M8330	■	▣	▣	▣	▣	▣	●	-	.063	.002	.006	.012	.197
S		M8340	■	■	▣	▣	▣	▣	●	+/-	.063	.002	.006	.012	.197

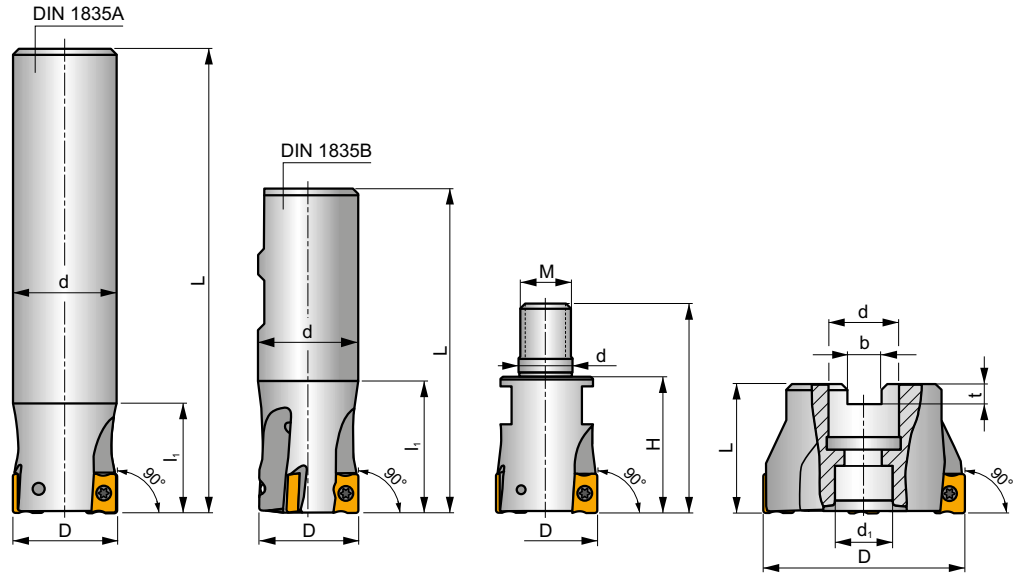
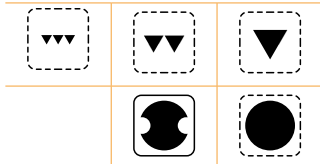
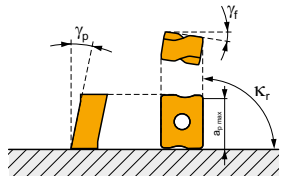


ISLN12

P M K N S H



$\kappa_r$	90°
$a_{pmax}$	.354



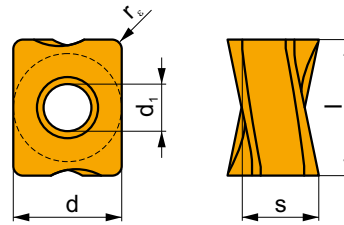
ANSI	D	L	d	d <sub>1</sub>	l <sub>1</sub>	H	M	b	t	$\gamma_r^\circ$	$\gamma_p^\circ$			max.		lbs		
100A2R134C100-ISLN12-C	1.000	6.693	1.000	-	1.340	-	-	-	-	-23	-8	2	-	19500	✓	1.10	IGI205	ISQ340
100A2R315C100-ISLN12-C	1.000	6.693	1.000	-	3.150	-	-	-	-	-23	-8	2	-	19500	✓	1.10	IGI205	ISQ340
125A2R134C125-ISLN12-C	1.250	7.677	1.250	-	1.340	-	-	-	-	-15	-6	2	-	17300	✓	1.98	IGI205	ISQ340
125A2R354C125-ISLN12-C	1.250	7.677	1.250	-	3.543	-	-	-	-	-15	-6	2	-	17300	✓	1.98	IGI205	ISQ340
100A2R128W100-ISLN12-C	1.000	3.819	1.000	-	1.280	-	-	-	-	-23	-8	2	-	19500	✓	.22	IGI205	ISQ340
125A3R150W125-ISLN12-C	1.250	4.039	1.250	-	1.500	-	-	-	-	-15	-6	3	-	17300	✓	1.10	IGI205	ISQ340
150A4R160W125-ISLN12-C	1.500	4.389	1.250	-	1.600	-	-	-	-	-15	-6	4	✓	15500	✓	1.32	IGI205	ISQ340
100A2R138M12-ISLN12-C	1.000	2.244	.492	-	-	1.378	-	-	-	-22	-6	2	✓	-	✓	.22	IGI205	ISQ340
125A2R169M16-ISLN12-C	1.250	2.598	.669	-	-	1.693	-	-	-	-15	-6	2	✓	-	✓	.44	IGI205	ISQ340
125A3R169M16-ISLN12-C	1.250	2.598	.669	-	-	1.693	-	-	-	-15	-6	3	✓	-	✓	.44	IGI205	ISQ340
150A3R169M16-ISLN12-C	1.500	2.598	.669	-	-	1.693	-	-	-	-15	-6	3	✓	-	✓	.44	IGI205	ISQ340
150A04R-IS90LN12-C	1.500	1.575	.500	.433	-	-	.258	.165	-	-15	-6	4	✓	15500	✓	.44	IGI205	ISQ342
200A04R-IS90LN12-C	2.000	1.575	.750	.630	-	-	-	.321	.193	-14.5	-6	4	✓	13800	✓	.66	IGI205	ISQ343
200A05R-IS90LN12-C	2.000	1.575	.750	.630	-	-	-	.321	.193	-14.5	-6	5	✓	13800	✓	.66	IGI205	ISQ343
250A04R-IS90LN12-C	2.500	1.575	.750	.630	-	-	-	.321	.193	-14	-6	4	✓	12300	✓	1.10	IGI205	ISQ343
250A06R-IS90LN12-C	2.500	1.575	.750	.630	-	-	-	.321	.193	-14	-6	6	✓	12300	✓	1.10	IGI205	ISQ343
300A05R-IS90LN12-C	3.000	1.969	1.000	.827	-	-	-	.382	.224	-14	-6	5	✓	10900	✓	2.20	IGI205	ISQ344
300A07R-IS90LN12-C	3.000	1.969	1.000	.827	-	-	-	.382	.224	-14	-6	7	✓	10900	✓	2.20	IGI205	ISQ344
400A06R-IS90LN12-C	4.000	1.969	1.500	1.260	-	-	-	.630	.382	-14	-6	6	✓	9800	✓	3.75	IGI205	ISQ345
400A08R-IS90LN12-C	4.000	1.969	1.500	1.260	-	-	-	.630	.382	-14	-6	8	✓	9800	✓	3.75	IGI205	ISQ345
500A07R-IS90LN12-C	5.000	2.480	1.500	1.260	-	-	-	.630	.382	-14	-6	7	✓	8700	✓	7.05	IGI205	ISQ349
500A09R-IS90LN12-C	5.000	2.480	1.500	1.260	-	-	-	.630	.382	-14	-6	9	✓	8700	✓	7.05	IGI205	ISQ349

IGI205	LNGX 1205..	LNGU 1205..

ISQ340	US 44012-T15P	3.5	M 4	.470	-	-	Flag T15P	-
ISQ342	US 44012-T15P	3.5	M 4	.470	D-T08P/T15P	FG-15	-	HS 025100
ISQ343	US 44012-T15P	3.5	M 4	.470	D-T08P/T15P	FG-15	-	HS 037100
ISQ344	US 44012-T15P	3.5	M 4	.470	D-T08P/T15P	FG-15	-	HS 050125
ISQ345	US 44012-T15P	3.5	M 4	.470	D-T08P/T15P	FG-15	-	HCS 075200
ISQ349	US 44012-T15P	3.5	M 4	.470	D-T08P/T15P	FG-15	-	HS 075125

## LNGX 12

	d	d <sub>1</sub>	l	s
1205	.374	.177	.472	.235

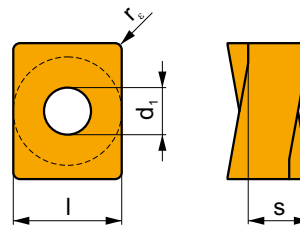


		ANSI		P	M	K	N	S	H			r <sub>c</sub>	f <sub>min</sub>	f <sub>max</sub>	a <sub>p min</sub>	a <sub>p max</sub>
		LNGX 120504ER-F		M8330	■	■	■	□	□	●	-	.016	.002	.006	.008	.354
				M8340	■	■	■	□	□	●	+/-	.016	.002	.006	.008	.354
				8215	■	■	■	□	□	●	-	.016	.002	.006	.008	.354
		LNGX 120508ER-F		M8310	■	■	■	□	□	●	-	.031	.002	.006	.008	.354
				M8330	■	■	■	□	□	●	-	.031	.002	.006	.008	.354
				M8340	■	■	■	□	□	●	+/-	.031	.002	.006	.008	.354
				8215	■	■	■	□	□	●	-	.031	.002	.006	.008	.354
		LNGX 120504ER-M		M8340	■	□	■	□	□	●	+/-	.016	.002	.010	.008	.354
				M8330	■	□	■	□	□	●	-	.016	.002	.010	.008	.354
		LNGX 120508ER-M		M9315	■	□	■	□	□	●	---	.031	.002	.006	.008	.354
				M9325	■	□	□	□	□	●	---	.031	.002	.006	.008	.354
				M9340	■	□	□	□	□	●	---	.031	.002	.006	.008	.354
				M8310	■	□	■	□	□	●	-	.031	.002	.010	.008	.354
				M8330	■	□	■	□	□	●	-	.031	.002	.010	.008	.354
				M8340	■	□	■	□	□	●	+/-	.031	.002	.010	.008	.354
		LNGX 120510ER-M		M8330	■	□	■	□	□	●	-	.039	.002	.010	.008	.354
				M8340	■	□	■	□	□	●	+/-	.039	.002	.010	.008	.354
		LNGX 120512ER-M		M8330	■	□	■	□	□	●	-	.047	.002	.010	.008	.354
				M8340	■	□	■	□	□	●	+/-	.047	.002	.010	.008	.354
		LNGX 120516ER-M		M8330	■	□	■	□	□	●	-	.063	.002	.010	.008	.354
				M8340	■	□	■	□	□	●	+/-	.063	.002	.010	.008	.354
		LNGX 120520ER-M		M8310	■	□	■	□	□	●	-	.079	.002	.010	.008	.354
				M8330	■	□	■	□	□	●	-	.079	.002	.010	.008	.354
				M8340	■	□	■	□	□	●	+/-	.079	.002	.010	.008	.354
		LNGX 120508SR-R		M5315	■	□	■	□	□	●	---	.031	.006	.011	.039	.354
				M9315	■	□	■	□	□	●	---	.031	.006	.011	.039	.354
				M9325	■	□	□	□	□	●	---	.031	.006	.011	.039	.354
				M9340	■	□	□	□	□	●	---	.031	.006	.011	.039	.354
				M8310	■	□	■	□	□	●	-	.031	.006	.014	.039	.354
				M8340	■	□	■	□	□	●	+/-	.031	.006	.014	.039	.354
		LNGX 120508SR-R		8215	■	□	■	□	□	●	-	.031	.006	.014	.039	.354

i	ANSI		P	M	K	N	S	H			r <sub>c</sub>	f <sub>min</sub>	f <sub>max</sub>	a <sub>p min</sub>	a <sub>p max</sub>			
  	LNGX 120508SR-R	 	M5315	☑	☐	☐	☐	☐	☐	☐	---	.031	.006	.011	.039	.354		
			M9315	☐	☑	☐	☐	☐	☐	☐	☐	---	.031	.006	.011	.039	.354	
			M9325	☐	☐	☐	☐	☐	☐	☐	☐	☐	---	.031	.006	.011	.039	.354
			M9340	☑	☐	☐	☐	☐	☐	☐	☐	☐	---	.031	.006	.011	.039	.354
			M8310	☐	☐	☐	☐	☐	☐	☐	☐	☐	-	.031	.006	.014	.039	.354
			M8330	☐	☐	☐	☐	☐	☐	☐	☐	☐	-	.031	.006	.014	.039	.354
			M8340	☐	☐	☑	☐	☐	☐	☐	☐	☐	+/-	.031	.006	.014	.039	.354
			8215	☐	☐	☐	☐	☐	☐	☐	☐	☐	-	.031	.006	.014	.039	.354
  	LNGX 120516SR-R	 	M9325	☐	☐	☐	☐	☐	☐	☐	---	.063	.006	.011	.039	.354		
			M8330	☐	☐	☐	☐	☐	☐	☐	☐	-	.063	.006	.014	.039	.354	
			M8340	☐	☐	☑	☐	☐	☐	☐	☐	☐	+/-	.063	.006	.014	.039	.354
			8215	☐	☐	☐	☐	☐	☐	☐	☐	-	.063	.006	.014	.039	.354	
  	LNGX 120504ER-MF	 	M9340	☑	☐	☐	☐	☐	☐	☐	---	.016	.002	.005	.012	.354		
			M6330	☑	☐	☐	☐	☐	☐	☐	☐	-	.016	.002	.006	.012	.354	
	M8340		☑	☐	☐	☐	☐	☐	☐	☐	☐	+/-	.016	.002	.006	.012	.354	
	LNGX 120508ER-MF		M9340	☑	☐	☐	☐	☐	☐	☐	☐	---	.031	.002	.005	.012	.354	
			M6330	☑	☐	☐	☐	☐	☐	☐	☐	-	.031	.002	.006	.012	.354	
			M8340	☑	☐	☐	☐	☐	☐	☐	☐	+/-	.031	.002	.006	.012	.354	
  	LNGX 120508SR-MM	 	M9340	☑	☐	☐	☐	☐	☐	☐	---	.031	.003	.007	.012	.354		
			M6330	☑	☐	☐	☐	☐	☐	☐	☐	-	.031	.003	.008	.012	.354	
			M8340	☐	☐	☐	☐	☐	☐	☐	☐	+/-	.031	.003	.008	.012	.354	
			M8345	☐	☐	☐	☐	☐	☐	☐	☐	+/-	.031	.003	.008	.012	.354	

## LNGU 12

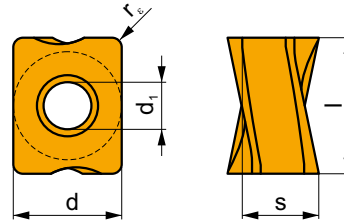
	d	d <sub>1</sub>	l	s	
	1205	.374	.177	.472	.235



i	ANSI		P	M	K	N	S	H			r <sub>c</sub>	f <sub>min</sub>	f <sub>max</sub>	a <sub>p min</sub>	a <sub>p max</sub>		
  	LNGU 120525ER-M	 	M8330	☐	☐	☐	☐	☐	☐	☐	-	.098	.002	.010	.008	.354	
			M8340	☐	☐	☑	☐	☐	☐	☐	☐	+/-	.098	.002	.010	.008	.354
	LNGU 120530ER-M		M8330	☐	☐	☐	☐	☐	☐	☐	☐	-	.118	.002	.010	.008	.354
			M8340	☐	☐	☑	☐	☐	☐	☐	☐	+/-	.118	.002	.010	.008	.354

# LNGX 12-FA

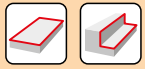
	d	d <sub>1</sub>	l	s
1205	.374	.177	.472	.235



i	ANSI	Material	P	M	K	N	S	H	Coating	Drop	r <sub>c</sub>	f <sub>min</sub>	f <sub>max</sub>	a <sub>p min</sub>	a <sub>p max</sub>
   	LNGX 120504FR-FA	HF7		<input type="checkbox"/>		<input checked="" type="checkbox"/>	<input type="checkbox"/>		●	+/-	.016	.001	.014	.008	.354
	LNGX 120508FR-FA	M0315				<input checked="" type="checkbox"/>			●	++	.031	.001	.014	.008	.354
		HF7		<input type="checkbox"/>			<input checked="" type="checkbox"/>	<input type="checkbox"/>		●	+/-	.031	.001	.014	.008

ISO	f <sub>min</sub>	f <sub>max</sub>	M5315	M9315	M9325	M9340	M0315	M6330	M8310	M8340	M8345	8215	M8330	HF7	
P	●	.0020	.0079	1070	1047	1010	873	-	787	899	801	577	863	787	-
	●	.0020	.0059	997	961	912	774	-	702	814	702	492	751	689	-
	✘	.0020	.0039	912	863	801	689	-	617	725	604	420	640	591	-
M	●	.0020	.0079	-	-	604	518	-	518	541	479	344	518	469	-
	●	.0020	.0059	-	-	541	469	-	456	479	420	295	443	420	-
	✘	.0020	.0039	-	-	479	407	-	394	430	358	246	381	358	-
K	●	.0020	.0079	1020	997	-	-	-	-	850	751	-	814	751	-
	●	.0020	.0059	948	912	-	-	-	-	774	666	-	715	653	-
	✘	.0020	.0039	873	823	-	-	-	-	689	577	-	604	568	-
N	●	.0020	.0079	-	-	-	-	1870	-	-	-	-	-	-	837
	●	.0020	.0059	-	-	-	-	1673	-	-	-	-	-	-	751
	✘	.0020	.0039	-	-	-	-	1463	-	-	-	-	-	-	653
S	●	.0020	.0079	-	-	295	259	-	259	272	233	174	259	233	-
	●	.0020	.0059	-	-	272	233	-	223	233	210	148	223	210	-
	✘	.0020	.0039	-	-	233	197	-	197	210	174	125	184	174	-
H	●	.0020	.0079	210	210	-	-	-	-	174	-	-	174	148	-
	●	.0020	.0059	197	184	-	-	-	-	161	-	-	148	135	-
	✘	.0020	.0039	174	174	-	-	-	-	135	-	-	125	112	-

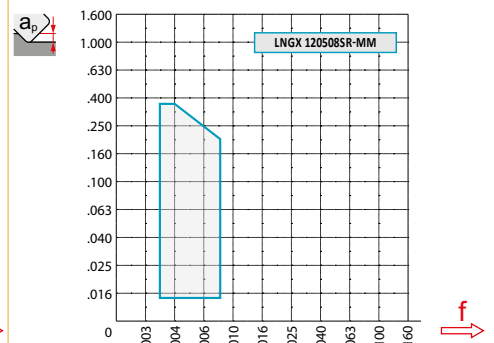
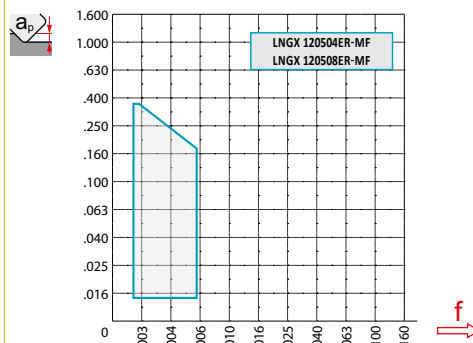
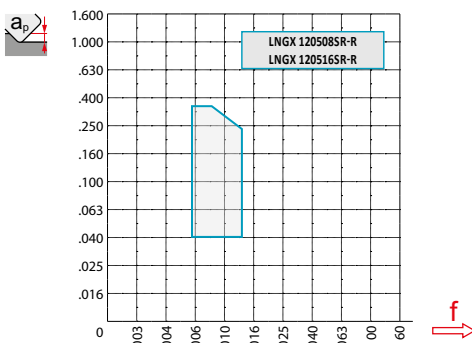
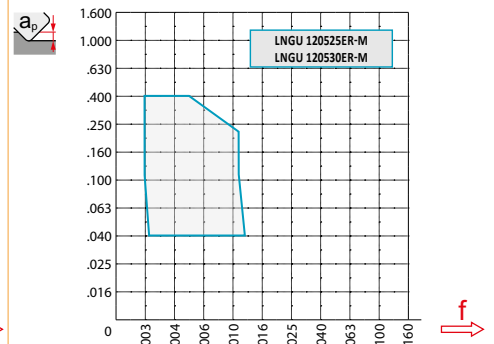
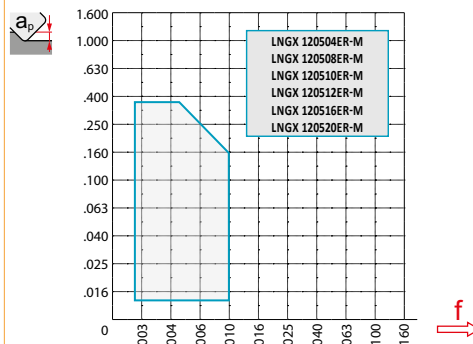
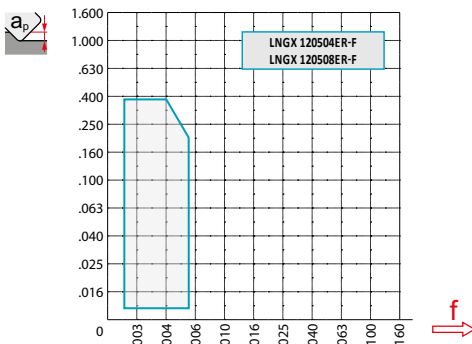


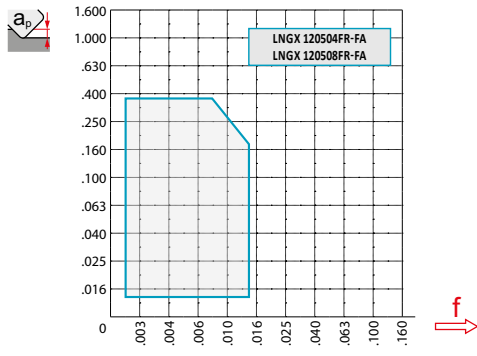


$a_p/D$	.05	.10	.15	.20	.25	.30	.40	.50	.60	.70	.75	.80	.90	1.00
	1.48	1.35	1.27	1.22	1.19	1.16	1.11	1.08	1.05	1.03	1.00	1.00	1.00	1.00
	2.87	2.05	1.69	1.48	1.33	1.23	1.09	.75	.94	.90	.89	.88	.88	1.00
	.64	.64	.64	.64	.64	.65	.65	.67	.68	.71	.72	.74	.79	1.00

	LNGX 12-F	LNGX 12-M								LNGU 12-M	
$r_\epsilon$	.016	.031	.016	.031	.039	.047	.063	.079	.098	.118	
$a$	.090	.074	.090	.074	.067	.059	.043	.027	.034	.014	

	LNGX 12-R	LNGX 12-MF		LNGX 12-MM	LNGX 12-FA		
$r_\epsilon$	.031	.063	.016	.031	.031	.016	.031
$a$	.074	.043	.090	.074	.074	.091	.074





.299



.039    .197    .354



.007    .005    .003



### LNGX 12

$\varnothing D$	$\alpha_{max}^\circ$	$a_p/l$
1.00	1.3	.083/4.000
1.25	.7	.043/4.000
1.50	.5	.028/4.000
2.00	.4	.020/4.000
2.50	.2	.012/4.000
3.00	.2	.008/4.000



### LNGX 12

$\varnothing D$	$d_{min}$	$d_{max}$	$\frac{S_{max}}{d_{min}}$	$\frac{S_{max}}{d_{max}}$
1.00	1.378	1.969	.028	.067
1.25	1.929	2.520	.024	.047
1.50	2.559	3.150	.024	.039
2.00	3.346	3.937	.028	.039
2.50	4.370	4.961	.024	.031
3.00	5.709	6.299	.028	.031

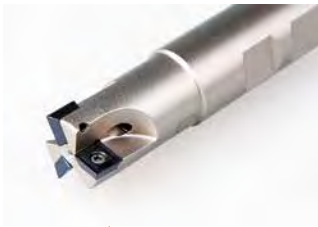


.008

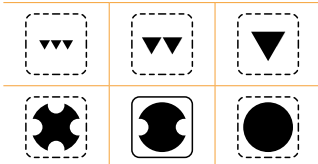
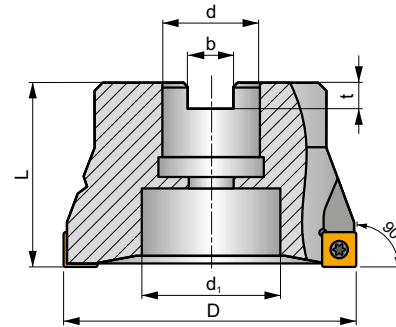
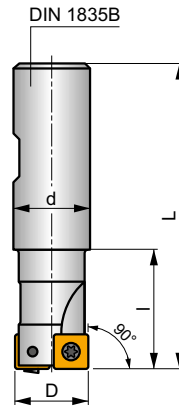
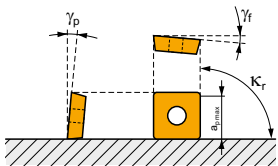
# ISSO09

P M K N S

S



$k_r$	90°
$a_{pmax}$	.315



.0027-.0086  
 .0027-.0070



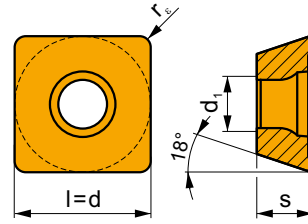
ANSI	D	L	$d_1$	l	b	t	$\gamma_f^\circ$	$\gamma_p^\circ$			max.		lbs		
100A3R128W100-ISSO09-C	1.000	3.780	-	1.280	-	-	-12	6	3	-	21300	✓	.66	IGI146	ISQ400
125A4R150W125-ISSO09-C	1.250	4.000	-	1.500	-	-	-10	10	4	✓	18800	✓	1.54	IGI146	ISQ400
150A05R-IS90S009-C	1.500	1.575	.433	-	.258	.165	-9.1	10	5	-	16800	✓	.33	IGI146	ISQ402
200A06R-IS90S009-C	2.000	1.575	.630	-	.321	.193	-8.8	10	6	-	15100	✓	.66	IGI146	ISQ403
250A07R-IS90S009-C	2.500	1.575	.630	-	.321	.193	-8.6	10	7	-	13400	✓	1.12	IGI146	ISQ403
300A09R-IS90S009-C	3.000	1.969	.827	-	.382	.224	-8.1	10	9	-	11900	✓	2.14	IGI146	ISQ404
400A10R-IS90S009-C	4.000	1.969	1.260	-	.630	.382	-8.1	10	10	-	10700	✓	3.55	IGI146	ISQ405
500A12R-IS90S009-C	5.000	2.480	1.260	-	.630	.382	-8.1	10	12	-	9500	✓	6.55	IGI146	ISQ405

IGI146	SOMT 09T3..

ISQ400	US 3006-T09P	2.0	M 3	.240	-	-	Flag T09P	-
ISQ402	US 3006-T09P	2.0	M 3	.240	D-T07P/T09P	FG-15	-	HS 025100
ISQ403	US 3006-T09P	2.0	M 3	.240	D-T07P/T09P	FG-15	-	HS 037100
ISQ404	US 3006-T09P	2.0	M 3	.240	D-T07P/T09P	FG-15	-	HS 050125
ISQ405	US 3006-T09P	2.0	M 3	.240	D-T07P/T09P	FG-15	-	HS 075125

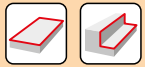
# SOMT 09

	d	d <sub>1</sub>	l	s
09T3	.376	.138	.376	.156



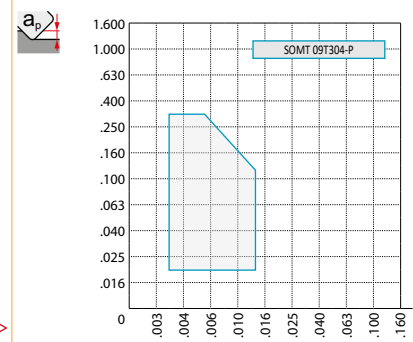
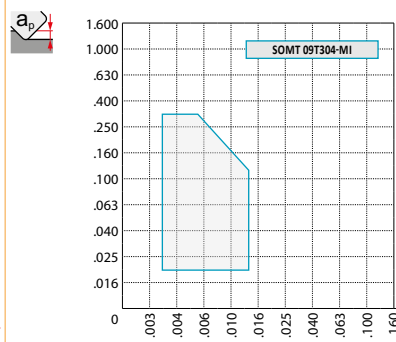
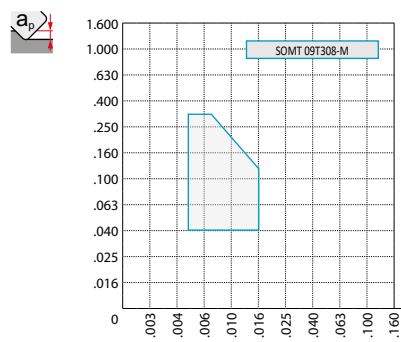
i	ANSI	Material	ISO					? (Chip)	Drop	r <sub>e</sub>	f <sub>min</sub>	f <sub>max</sub>	a <sub>p min</sub>	a <sub>p max</sub>
			P	M	K	N	S							
	SOMT 09T308-M	M5315			■			●	---	.031	.005	.012	.039	.315
		M9315	■		▣			●	---	.031	.005	.012	.039	.315
		M8330	■	▣	■	□	□	●	-	.031	.005	.016	.039	.315
		M8340	■	■	▣		▣	●	+/-	.031	.005	.016	.039	.315
		8215	▣	▣	■	□	□	●	-	.031	.005	.016	.039	.315
	SOMT 09T304-MI	M9315	■		▣			●	---	.016	.003	.010	.020	.315
		M9340	▣	■				●	---	.016	.003	.010	.020	.315
		M8310	■	▣	■		□	●	-	.016	.003	.014	.020	.315
		M8330	■	▣	■	□	□	●	-	.016	.003	.014	.020	.315
		M8340	■	■	▣		▣	●	+/-	.016	.003	.014	.020	.315
	SOMT 09T304-P	M9325	■	▣			▣	●	---	.016	.003	.010	.020	.315
		M8330	■	▣	▣	□	□	●	-	.016	.003	.014	.020	.315
		M8340	■	■	▣		▣	●	+/-	.016	.003	.014	.020	.315

ISO	f <sub>min</sub>	f <sub>max</sub>	M5315	M9315	M9325	M9340	M8310	M8340	8215	M8330	
P	●	.0039	.0118	1214	1184	1145	991	1017	906	978	892
	●	.0039	.0098	1129	1089	1033	879	922	794	850	781
	✘	.0039	.0059	1033	978	906	781	823	682	725	669
M	●	.0039	.0118	-	-	682	587	614	545	587	531
	●	.0039	.0098	-	-	614	531	545	476	502	476
	✘	.0039	.0059	-	-	545	459	489	404	433	404
K	●	.0039	.0118	1158	1129	-	-	961	850	922	850
	●	.0039	.0098	1073	1033	-	-	879	755	810	738
	✘	.0039	.0059	991	935	-	-	781	656	682	643
N	●	.0039	.0118	-	-	-	-	-	-	2454	2244
	●	.0039	.0098	-	-	-	-	-	-	2133	1982
	✘	.0039	.0059	-	-	-	-	-	-	1827	1703
S	●	.0039	.0098	-	-	335	292	308	266	292	266
	●	.0039	.0079	-	-	308	266	266	236	253	236
	✘	.0039	.0059	-	-	266	223	236	197	210	197



$a_e/D$	.05	.10	.15	.20	.25	.30	.40	.50	.60	.70	.75	.80	.90	1.00
$X.V$	1.48	1.35	1.27	1.22	1.19	1.16	1.11	1.08	1.05	1.03	1.00	1.00	1.00	1.00
$X.f$	2.87	2.05	1.69	1.48	1.33	1.23	1.09	.75	.94	.90	.89	.88	.88	1.00
$X.f$	.64	.64	.64	.64	.64	.65	.65	.67	.68	.71	.72	.74	.79	1.00

	SOMT 09-M	SOMT 09-MI	SOMT 09-P
$r_\epsilon$	.032	.016	.016
$a$	.035	.051	.051



.236



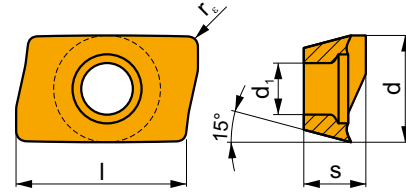
$a_p$	.394	.158	.315
$X.f$	.011	.007	.004





# ADMX 11

	d	d <sub>1</sub>	l	s
11T3	.257	.114	.433	.156



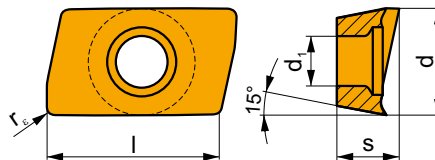
i	ANSI	Material	P	M	K	N	S	H	Coatings	Drop	r <sub>c</sub>	f <sub>min</sub>	f <sub>max</sub>	a <sub>p min</sub>	a <sub>p max</sub>
	ADMX 11T304SR-F	M9340	█	█			█		●	---	.016	.003	.004	.008	.354
		M8310	█	█	█		█		●	-	.016	.003	.005	.008	.354
		M8330	█	█	█	□	□		●	-	.016	.003	.005	.008	.354
		M8340	█	█	█		█		●	+/-	.016	.003	.005	.008	.354
		8215	█	█	█	█	█		●	-	.016	.003	.005	.008	.354
	ADMX 11T308SR-F	M9340	█	█			█		⊕	---	.031	.003	.004	.008	.354
		M8330	█	█	█	□	□		⊕	-	.031	.003	.005	.008	.354
		M8340	█	█	█		█		⊕	+/-	.031	.003	.005	.008	.354
		8215	█	█	█	█	█		⊕	-	.031	.003	.005	.008	.354
	ADMX 11T302SR-M	M8340	█	█	█		█		●	+/-	.008	.004	.006	.008	.354
		M8330	█	█	█		█		●	-	.008	.004	.006	.008	.354
	ADMX 11T304SR-M	M9325	█	█			█		●	---	.016	.004	.006	.008	.354
		M9340	█	█			█		●	---	.016	.004	.006	.008	.354
		M8310	█	█	█		█		●	-	.016	.004	.007	.008	.354
		M8330	█	█	█	□	□		⊕	-	.016	.004	.007	.008	.354
		M8340	█	█	█		█		⊕	+/-	.016	.004	.007	.008	.354
		8215	█	█	█		█		●	-	.016	.004	.007	.008	.354
	ADMX 11T308SR-M	M5315	█		█				⊕	---	.031	.004	.006	.008	.354
		M9315	█		█				⊕	---	.031	.004	.006	.008	.354
		M9325	█	█			█		⊕	---	.031	.004	.006	.008	.354
		M9340	█	█			█		⊕	---	.031	.004	.006	.008	.354
		M8310	█	█	█		█		⊕	-	.031	.004	.007	.008	.354
		M8330	█	█	█		□		⊕	-	.031	.004	.007	.008	.354
		M8340	█	█	█		█		⊕	+/-	.031	.004	.007	.008	.354
		8215	█	█	█		█		⊕	-	.031	.004	.007	.008	.354
	ADMX 11T310SR-M	M8330	█	█	█		□		⊗	-	.039	.004	.009	.008	.354
		M8340	█	█	█		█		⊗	+/-	.039	.004	.009	.008	.354
	ADMX 11T312SR-M	M8330	█	█	█		□		⊗	-	.047	.004	.009	.008	.354
		M8340	█	█	█		█		⊗	+/-	.047	.004	.009	.008	.354
		8215	█	█	█		█		⊕	-	.047	.004	.009	.008	.354
	ADMX 11T316SR-M	M6330	█	█			█		⊗	-	.063	.004	.009	.008	.354
		M8310	█	█	█		█		⊕	-	.063	.004	.009	.008	.354
		M8330	█	█	█		□		⊗	-	.063	.004	.009	.008	.354
		M8340	█	█	█		█		⊗	+/-	.063	.004	.009	.008	.354
		8215	█	█	█		█		⊕	-	.063	.004	.009	.008	.354
	ADMX 11T320SR-M	M8340	█	█	█		█		⊗	+/-	.079	.004	.009	.008	.354



i	ANSI		P	M	K	N	S	H			r <sub>c</sub>	f <sub>min</sub>	f <sub>max</sub>	a <sub>p min</sub>	a <sub>p max</sub>	
   	ADMX 11T325SR-M	M6330	☑	■			☑		✘	-	.098	.004	.009	.008	.354	
		M8330	■	■			☑		✘	-	.098	.004	.009	.008	.354	
		M8340	■	■	☑		☑		✘	+/-	.098	.004	.009	.008	.354	
	ADMX 11T330SR-M	M6330	■	■	■		☑		✘	-	.118	.004	.009	.008	.354	
		M8330	■	■	■		☑		✘	-	.118	.004	.009	.008	.354	
		M8340	■	■	☑		☑		✘	+/-	.118	.004	.009	.008	.354	
	 	ADMX 11T308PR-R	M5315	☑		■		☑		☹	---	.031	.006	.008	.031	.354
			M9315	■		☑		☑		☹	---	.031	.006	.008	.031	.354
			M9325	■	☑			☑		✘	---	.031	.006	.008	.031	.354
			M8310	■	☑	■		☑	☑	✘	-	.031	.006	.010	.031	.354
			M8830	■	☑	■		☐	☑	✘	-	.031	.006	.010	.031	.354
			M8340	■	☑	☑		☑		✘	+/-	.031	.006	.010	.031	.354
ADMX 11T316PR-R		8215	■	☑	■		☑	☑	✘	-	.031	.006	.010	.031	.354	
		M9325	■	☑			☑		✘	---	.063	.006	.008	.031	.354	
		M8330	■	☑	■		☐	☑	✘	-	.063	.006	.010	.031	.354	
		M8340	■	☑	☑		☑		✘	+/-	.063	.006	.010	.031	.354	
		8215	■	☑	■		☑	☑	✘	-	.063	.006	.010	.031	.354	
		 	ADMX 11T304SR-MF	M9340	☑	■			■		●	---	.016	.002	.005	.008
M6330	☑			■			■		●	-	.016	.002	.006	.008	.354	
M8340	■			■			■		●	+/-	.016	.002	.006	.008	.354	
ADMX 11T308SR-MF	M9340		☑	■			■		●	---	.031	.002	.005	.008	.354	
	M6330		☑	■			■		●	-	.031	.002	.006	.008	.354	
	M8340		■	■			■		●	+/-	.031	.002	.006	.008	.354	
 	ADMX 11T304SR-MM		M9340	☑	■			■		●	---	.016	.004	.006	.008	.354
			M6330	☑	■			■		●	-	.016	.004	.007	.008	.354
			M8340	■	■			■		●	+/-	.016	.004	.007	.008	.354
	ADMX 11T308SR-MM		M9340	☑	■			■		●	---	.031	.004	.006	.008	.354
			M6330	☑	■			■		●	-	.031	.004	.007	.008	.354
			M8340	■	■			■		●	+/-	.031	.004	.007	.008	.354
	ADMX 11T312SR-MM	M8345	■	■			■		●	+/-	.031	.004	.007	.008	.354	
		M9340	☑	■			■		●	---	.047	.004	.006	.008	.354	
		M6330	☑	■			■		●	-	.047	.004	.007	.008	.354	
	ADMX 11T312SR-MM	M8340	■	■			■		●	+/-	.047	.004	.007	.008	.354	
		M8345	■	■			■		●	+/-	.047	.004	.007	.008	.354	

## ADEX 11-FA

	d	d <sub>1</sub>	l	s
11T3	.254	.114	.382	.154



i	ANSI	Material	P	M	K	N	S	H	?	Drop	r <sub>c</sub>	f <sub>min</sub>	f <sub>max</sub>	a <sub>p min</sub>	a <sub>p max</sub>
	ADEX 11T304FR-FA	M0315				■			●	++	.016	.001	.012	.016	.354
		HF7				■			●	+/-	.016	.001	.012	.008	.354
	ADEX 11T308FR-FA	M0315				■			●	++	.031	.001	.012	.008	.354
		HF7				■			●	+/-	.031	.001	.012	.008	.354
	ADEX 11T312FR-FA	M0315				■			●	++	.047	.001	.012	.008	.354
	HF7				■			●	+/-	.047	.001	.012	.008	.354	
	ADEX 11T316FR-FA	HF7				■			●	+/-	.063	.001	.012	.008	.354

a <sub>e</sub> /D	.05	.10	.15	.20	.25	.30	.40	.50	.60	.70	.75	.80	.90	1.00
X.V	1.48	1.35	1.27	1.22	1.19	1.16	1.11	1.08	1.05	1.03	1.00	1.00	1.00	1.00
X.f	2.87	2.05	1.69	1.48	1.33	1.23	1.09	.75	.94	.90	.89	.88	.88	1.00
X.f	.64	.64	.64	.64	.64	.65	.65	.67	.68	.71	.72	.74	.79	1.00

	ADMX 11-F		ADMX 11-M									ADMX 11-R		ADMX 11-MF			ADMX 11-MM			ADEX 11-FA		
r <sub>c</sub>	.016	.031	.008	.016	.031	.039	.047	.063	.079	.098	.118	.031	.063	.016	.031	.016	.031	.047	.016	.031	.063	
a	.074	.058	.082	.074	.058	.050	.043	.027	.063	.044	.026	.058	.027	.074	.058	.074	.058	.043	.070	.055	.024	

ISO	f <sub>min</sub>	f <sub>max</sub>	M5315	M9315	M9325	M9340	M6330	M8310	M8340	M8345	8215	M8330	
P	●	.0028	.0071	856	836	807	699	630	718	640	462	689	630
	●	.0028	.0059	797	768	728	620	561	649	561	394	600	551
	✘	.0028	.0039	728	689	640	551	492	581	482	335	512	472
M	●	.0028	.0071	-	-	482	413	413	433	384	276	413	374
	●	.0028	.0059	-	-	433	374	364	384	335	236	354	335
	✘	.0028	.0039	-	-	384	325	315	344	285	197	305	285
K	●	.0028	.0071	817	797	-	-	-	679	600	-	649	600
	●	.0028	.0059	758	728	-	-	-	620	531	-	571	522
	✘	.0028	.0039	699	659	-	-	-	551	462	-	482	453



ISO				
25J2R50B25-SAD11E38-C	1.00	2	1.496	1.358
32J2R60B32-SAD11E47-C	1.25	2	1.850	1.713
40J2R60B40-SAD11E47-C	1.50	2	1.850	1.713
40J3R70B32-SAD11E56-C	1.50	3	2.205	2.067
40J3R70B40-SAD11E56-C	1.50	3	2.205	2.067
25J2R55E03-SAD11E38-C	1.00	2	1.496	1.358
32J2R65E04-SAD11E47-C	1.25	2	1.850	1.713
40J3R75E04-SAD11E56-C	1.50	3	2.205	2.067
50T03R-S90AD11E37-C	2.00	3	1.457	1.319



.177



	.039		.098		.197		.295		.394		.591		.787	
	$f_{min}$	$f_{max}$	$f_{min}$	$f_{max}$	$f_{min}$	$f_{max}$	$f_{min}$	$f_{max}$	$f_{min}$	$f_{max}$	$f_{min}$	$f_{max}$	$f_{min}$	$f_{max}$
1.00	↔	↔	↔	↔	↔	↔	↔	↔	↔	↔	↔	↔	↔	↔
1.25	.010	.016	.006	.010	.005	.007	.004	.006	.004	.006	.003	.005	.003	.004
1.50	.011	.018	.007	.011	.005	.008	.004	.007	.004	.006	.003	.005	.003	.005
2.00	.013	.020	.008	.013	.006	.009	.005	.007	.004	.007	.004	.006	.003	.005
2.00	.014	.022	.009	.014	.006	.010	.005	.008	.005	.007	.004	.006	.004	.006

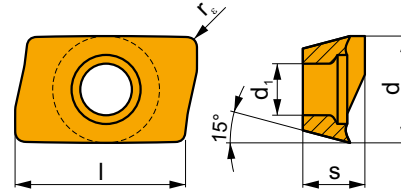
	.984		1.260		1.575		1.969	
	$f_{min}$	$f_{max}$	$f_{min}$	$f_{max}$	$f_{min}$	$f_{max}$	$f_{min}$	$f_{max}$
1.00	↔	↔	-	-	-	-	-	-
1.25	.003	.005	.003	.005	-	-	-	-
1.50	.003	.004	.003	.005	.003	.005	-	-
2.00	.003	.005	.003	.005	.003	.004	.003	.005



ADMX/ADEX 11	R
ADMX 11T320SR-M	.039
ADMX 11T325SR-M	.071
ADMX 11T330SR-M	.071



# ADMX 16



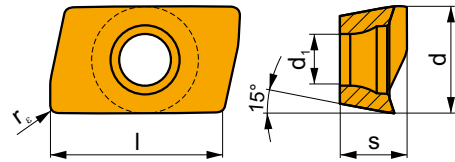
	d	d <sub>1</sub>	l	s
1606	.392	.177	.630	.246

i	ANSI	Image	P	M	K	N	S	H	Image	Image	r <sub>c</sub>	f <sub>min</sub>	f <sub>max</sub>	a <sub>p min</sub>	a <sub>p max</sub>
   	ADMX 160608SR-F	M9340	█	█					⚙	---	.031	.003	.005	.012	.512
	M8310	█	█	█		█			⚙	-	.031	.003	.006	.012	.512
	M8330	█	█	█	□	□			⚙	-	.031	.003	.006	.012	.512
	M8340	█	█	█		█			⚙	+/-	.031	.003	.006	.012	.512
	8215	█	█	█	█	□			⚙	-	.031	.003	.006	.012	.512
	ADMX 160604SR-M	M8330	█	█	█		□		⚙	-	.016	.004	.010	.012	.512
	M8340	█	█	█		█			⚙	+/-	.016	.004	.010	.012	.512
	8215	█	█	█		█			⚙	-	.016	.004	.010	.012	.512
	ADMX 160608SR-M	M5315			█				⚙	---	.031	.004	.008	.012	.512
	M9315	█		█					⚙	---	.031	.004	.008	.012	.512
	M9325	█	█			█			⚙	---	.031	.004	.008	.012	.512
	M9340	█	█						⚙	---	.031	.004	.008	.012	.512
	M8310	█	█	█		█			⚙	-	.031	.004	.010	.012	.512
	M8330	█	█	█		□			⚙	-	.031	.004	.010	.012	.512
	M8340	█	█	█		█			⚙	+/-	.031	.004	.010	.012	.512
	8215	█	█	█		█			⚙	-	.031	.004	.010	.012	.512
   	ADMX 160616SR-M	M9325	█	█		█			⚙	---	.063	.004	.009	.012	.512
	M8310	█	█	█		█			⚙	-	.063	.004	.012	.012	.512
	M8330	█	█	█		□			⚙	-	.063	.004	.012	.012	.512
	M8340	█	█	█		█			⚙	+/-	.063	.004	.012	.012	.512
	8215	█	█	█		█			⚙	-	.063	.004	.012	.012	.512
	ADMX 160620SR-M	M8340	█	█	█		█		⚙	+/-	.079	.004	.012	.012	.512
	M6330	█	█			█			⚙	-	.079	.004	.012	.012	.512
	M8330	█	█	█		□			⚙	-	.079	.004	.012	.012	.512
	ADMX 160630SR-M	M8330	█	█	█		□		⚙	-	.118	.004	.012	.012	.512
	M8340	█	█	█		█			⚙	+/-	.118	.004	.012	.012	.512
	ADMX 160632SR-M	M9325	█	█		█			⚙	---	.126	.004	.009	.012	.512
	M6330	█	█			█			⚙	-	.126	.004	.012	.012	.512
	M8330	█	█	█		□			⚙	-	.126	.004	.012	.012	.512
	M8340	█	█	█		█			⚙	+/-	.126	.004	.012	.012	.512
	8215	█	█	█		█			⚙	-	.126	.004	.012	.012	.512
	ADMX 160640SR-M	M6330	█	█		█			⚙	-	.157	.004	.012	.012	.512
	M8330	█	█	█		□			⚙	-	.157	.004	.012	.012	.512
	M8340	█	█	█		█			⚙	+/-	.157	.004	.012	.012	.512
	ADMX 160650SR-M	M8330	█	█	█		□		⚙	-	.197	.004	.012	.012	.512
	M8340	█	█	█		█			⚙	+/-	.197	.004	.012	.012	.512

i	ANSI	Image	P	M	K	N	S	H	Image	Image	$r_e$	$f_{min}$	$f_{max}$	$a_{p min}$	$a_{p max}$	
																?
  	ADMX 160608PR-R	M5315			■				✘	---	.031	.007	.011	.039	.512	
		M9315	■		■			■	✘	---	.031	.007	.011	.039	.512	
		M9325	■	■				■	✘	---	.031	.007	.011	.039	.512	
		M8310	■	■	■			■	■	✘	-	.031	.007	.014	.039	.512
		M8330	■	■	■			□	■	✘	-	.031	.007	.014	.039	.512
		M8340	■	■	■			■		✘	+/-	.031	.007	.014	.039	.512
		8215	■	■	■			□	■	✘	-	.031	.007	.014	.039	.512
  	ADMX 160616PR-R	M5315			■				✘	---	.063	.007	.011	.039	.512	
		M9315	■		■			■	✘	---	.063	.007	.011	.039	.512	
		M9325	■	■				■	✘	---	.063	.007	.011	.039	.512	
		M8330	■	■	■			□	■	✘	-	.063	.007	.014	.039	.512
		M8340	■	■	■			■		✘	+/-	.063	.007	.014	.039	.512
		8215	■	■	■			□	■	✘	-	.063	.007	.014	.039	.512
		  	ADMX 160608SR-MF	M9340	■	■			■		●	---	.031	.002	.006	.012
M6330	■			■			■		●	-	.031	.002	.006	.012	.512	
M8340	■			■			■		●	+/-	.031	.002	.006	.012	.512	
  	ADMX 160604SR-MM	M9340	■	■			■		●	---	.016	.006	.007	.012	.512	
		M6330	■	■			■		●	-	.016	.006	.009	.012	.512	
		M8340	■	■			■		●	+/-	.016	.006	.009	.012	.512	
	ADMX 160608SR-MM	M9340	■	■			■		●	---	.031	.006	.007	.012	.512	
		M6330	■	■			■		●	-	.031	.006	.009	.012	.512	
		M8340	■	■			■		●	+/-	.031	.006	.009	.012	.512	
	ADMX 160616SR-MM	M8345	■	■			■		●	+/-	.031	.006	.009	.012	.512	
		M9340	■	■			■		●	---	.063	.006	.007	.012	.512	
		M6330	■	■			■		✘	-	.063	.006	.009	.012	.512	
		M8340	■	■			■		✘	+/-	.063	.006	.009	.012	.512	
		M8345	■	■			■	✘	+/-	.063	.006	.009	.012	.512		

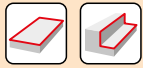
## ADEX 16

Image	d	d <sub>1</sub>	l	s
	.392	.177	.630	.246



i	ANSI	Image	P	M	K	N	S	H	Image	Image	$r_e$	$f_{min}$	$f_{max}$	$a_{p min}$	$a_{p max}$	
																?
  	ADEX 160608SR-FM	M9325	■	■				■	●	---	.031	.004	.008	.012	.512	
		M9340	■	■				■	●	---	.031	.004	.008	.012	.512	
		M8310	■	■	■			■	■	●	-	.031	.004	.010	.012	.512
		M8330	■	■	■			□	■	●	-	.031	.004	.010	.012	.512
		M8340	■	■	■			■		●	+/-	.031	.004	.010	.012	.512
		8215	■	■	■			■		●	-	.031	.004	.010	.012	.512

ISO	$f_{min}$	$f_{max}$	M5315	M9315	M9325	M9340	M6330	M8310	M8330	M8340	M8345	8215	M8330	
P		.004	.012	856	856	758	679	581	719	663	620	492	679	650
		.004	.010	797	778	669	610	522	650	594	551	433	600	581
		.004	.006	728	709	591	541	453	581	512	482	384	531	502
M		.004	.010	-	-	384	404	413	364	384	364	295	404	384
		.004	.008	-	-	344	364	364	325	344	325	256	364	344
		.004	.005	-	-	295	325	315	295	305	285	226	315	305
K		.004	.012	817	817	-	-	-	679	633	591	-	640	620
		.004	.010	758	738	-	-	-	620	561	522	-	571	551
		.004	.006	699	669	-	-	-	551	492	453	-	502	482



$a_p/D$	0.05	0.10	0.15	0.20	0.25	0.30	0.40	0.50	0.60	0.70	0.75	0.80	0.90	1.00
	1.48	1.35	1.27	1.22	1.19	1.16	1.11	1.08	1.05	1.03	1.00	1.00	1.00	1.00
	2.87	2.05	1.69	1.48	1.33	1.23	1.09	0.75	0.94	0.90	0.89	0.88	0.88	1.00
	0.64	0.64	0.64	0.64	0.64	0.65	0.65	0.67	0.68	0.71	0.72	0.74	0.79	1.00

	ADMX 16-F	ADEX 16-FM	ADMX 16-M								ADMX 16-R		
$r_\epsilon$	.031	.031	.016	.031	.063	.000	.001	.001	.001	.001	.001	.002	.063
$a$	.118	.086	.133	.118	.064	.000	.005	.003	.005	.005	.005	.003	.064

	ADMX 16-MF	ADMX 16-MM		
$r_\epsilon$	.031	.016	.031	.063
$a$	.118	.133	.118	.064



ISO	$D$	$n$	$L_1$	$a_p$
200J3R394CA50-ISAD16E213	2.000	3	2.16	2.02
200J3R551CA50-ISAD16E315	2.000	3	3.22	3.08
250J3R551CA50-ISAD16E268	2.500	3	2.69	2.55
250J3R610CA50-ISAD16E374	2.500	3	3.74	3.60
300J4R650CA50-ISAD16E425	3.000	4	4.27	4.13
200T03R-IS90AD16E163-C	2.000	3	1.63	1.49
250T04R-IS90AD16E163-C	2.500	4	1.63	1.49
250T04R-IS90AD16E268-C	2.500	4	2.69	2.55
300T04R-IS90AD16E217-C	3.000	4	2.16	2.02
300T04R-IS90AD16E315-C	3.000	4	3.22	3.08
400T05R-IS90AD16E315-C	4.000	5	3.22	3.08



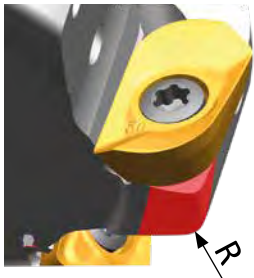
.295



	0.039		0.098		0.197		0.295		0.394		0.591		0.787	
$\varnothing$	$f_{min}$	$f_{max}$	$f_{min}$	$f_{max}$	$f_{min}$	$f_{max}$	$f_{min}$	$f_{max}$	$f_{min}$	$f_{max}$	$f_{min}$	$f_{max}$	$f_{min}$	$f_{max}$
2.000	0.022	0.028	0.014	0.018	0.010	0.013	0.008	0.011	0.007	0.009	0.006	0.007	0.006	0.007
2.500	0.025	0.031	0.016	0.020	0.011	0.014	0.009	0.012	0.008	0.010	0.007	0.008	0.006	0.007
3.000	0.028	0.035	0.018	0.022	0.013	0.016	0.011	0.013	0.009	0.011	0.007	0.009	0.007	0.008
4.000	0.031	0.039	0.020	0.025	0.014	0.018	0.012	0.015	0.010	0.013	0.008	0.011	0.007	0.009

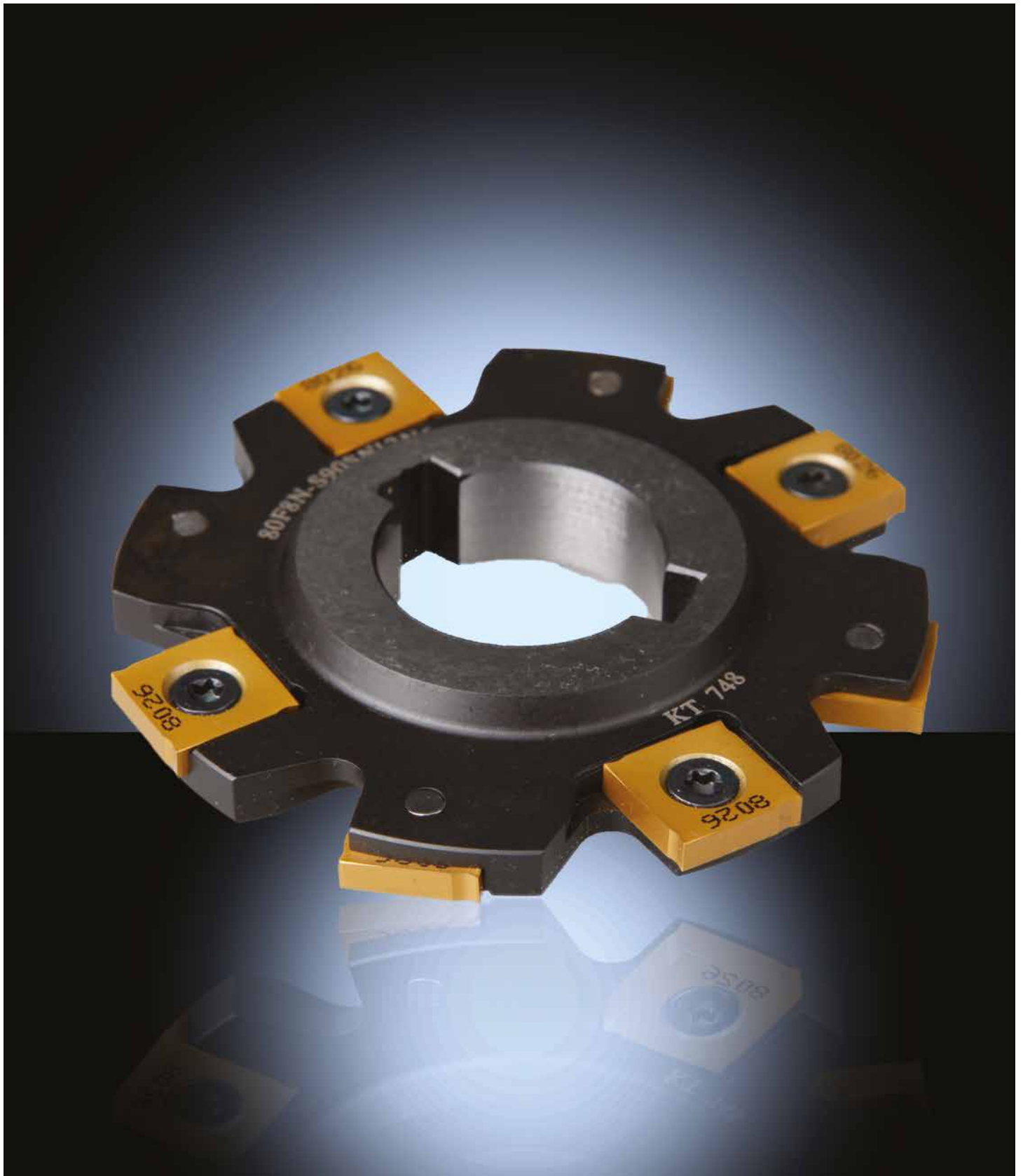
	0.984		1.260		1.575		1.969		2.480		3.150		3.937	
$\varnothing$	$f_{min}$	$f_{max}$	$f_{min}$	$f_{max}$	$f_{min}$	$f_{max}$	$f_{min}$	$f_{max}$	$f_{min}$	$f_{max}$	$f_{min}$	$f_{max}$	$f_{min}$	$f_{max}$
2.000	0.005	0.006	0.005	0.006	0.004	0.006	0.005	0.006	-	-	-	-	-	-
2.500	0.006	0.007	0.005	0.006	0.005	0.006	0.004	0.006	0.005	0.006	-	-	-	-
3.000	0.006	0.007	0.006	0.007	0.005	0.006	0.005	0.006	0.004	0.006	0.005	0.006	-	-
4.000	0.007	0.008	0.006	0.007	0.006	0.007	0.005	0.006	0.005	0.006	0.004	0.006	0.005	0.006



ADMX/ADEX 16	R
ADMX 160630SR-M	0.098
ADMX 160632SR-M	0.098
ADMX 160640SR-M	0.157
ADMX 160650SR-M	0.177



SLOT MILLING  
RANURADO  
RAINURAGE



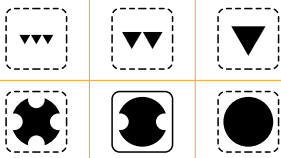
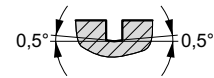
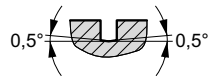
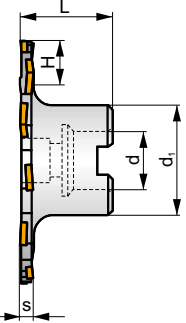
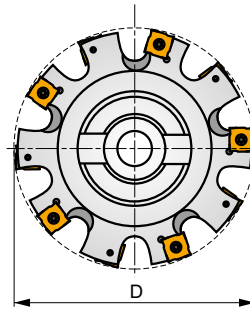
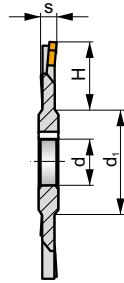
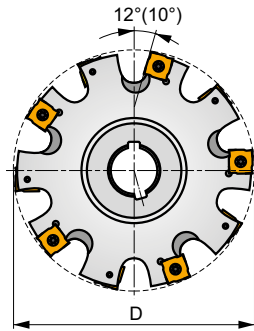
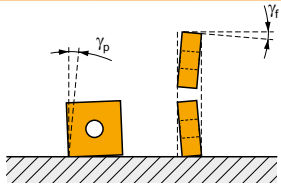
**IS90SN**

**P M K N S H**

**S**










$K_r$	90°
$a_{pmax}$	.156-.375



	.0027-.0035
	.0027-.0035



ANSI	D	L	d	$d_1$	H	s	$\frac{x}{1}$	$\gamma_f^\circ$	$\gamma_p^\circ$							
300F04N-IS90SN11N2.5	3.000	-	1.000	1.480	.630	.156	-	2.5	-5	8	-	12300	-	.44	GI151	IDI011
300F04N-IS90SN12N4	3.000	-	1.000	1.480	.630	.250	-	2.5	-5	8	-	8400	-	.44	GI153	IDI012
300F04N-IS90SN12N5	3.000	-	1.000	1.480	.630	.313	-	2.5	-5	8	-	8400	-	.66	GI157	IDI013
400G05N-IS90SN12N4	4.000	-	1.250	1.750	.945	.250	-	2.5	-5	10	-	7500	-	.66	GI153	IDI012
400G05N-IS90SN12N5	4.000	-	1.250	1.750	.945	.313	-	2.5	-5	10	-	7500	-	.88	GI157	IDI013
400G05N-IS90SN12N6	4.000	-	1.250	1.750	.945	.375	-	2.5	-5	10	-	7500	-	1.10	GI154	IDI014
500H06N-IS90SN12N4	5.000	-	1.250	2.000	1.220	.250	-	2.5	-5	12	-	6700	-	1.10	GI153	IDI012
500H06N-IS90SN12N5	5.000	-	1.250	2.000	1.220	.313	-	2.5	-5	12	-	6700	-	1.32	GI157	IDI013
600H08N-IS90SN12N4	6.000	-	1.250	2.000	1.693	.250	-	2.5	-5	16	-	5900	-	2.20	GI153	IDI012
600H08N-IS90SN12N5	6.000	-	1.250	2.000	1.693	.313	-	2.5	-5	16	-	5900	-	2.43	GI157	IDI013
600H08N-IS90SN12N6	6.000	-	1.250	2.000	1.693	.375	-	2.5	-5	16	-	5900	-	2.65	GI154	IDI014
250A03R-IS90SN11N2.5	2.500	1.575	.750	1.378	.413	.156	3	2.5	-5	6	-	13900	-	1.10	GI151	IDI021
250A03R-IS90SN12N4	2.500	1.575	.750	1.319	.413	.250	3	2.5	-5	6	-	9500	-	1.10	GI153	IDI022
300A04R-IS90SN11N3	3.000	1.575	.750	1.575	.610	.187	4	2.5	-5	8	-	12300	-	1.32	GI152	IDI023
300A04R-IS90SN12N4	3.000	1.575	.750	1.575	.610	.250	4	2.5	-5	8	-	8400	-	1.32	GI153	IDI024
400A05R-IS90SN12N4	4.000	1.969	1.000	1.890	.945	.250	5	2.5	-5	10	-	7500	-	1.54	GI153	IDI025
600B08R-IS90SN12N6	6.000	1.969	1.500	2.756	1.457	.375	8	2.5	-5	16	-	5900	-	4.63	GI154	IDI014

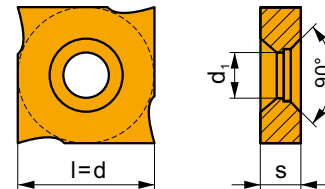


GI151	SNHQ 1102..
GI152	SNHQ 1103..
GI153	SNHQ 12T3..
GI154	SNHQ 1205..
GI157	SNHQ 1204..

IDI011	US 3504-T09P	3.0	M 3.5	.160	D-T07P/T09P	FG-15	-	
IDI012	US 70	5.0	M 4	.200	D-T07/T15	FG-15	-	
IDI013	US 71	5.0	M 4	.280	D-T07/T15	FG-15	-	
IDI014	US 72	5.0	M 4	.350	D-T07/T15	FG-15	-	
IDI021	US 3504-T09P	3.0	M 3.5	.160	D-T07P/T09P	FG-15	HS 037100	
IDI022	US 70	5.0	M 4	.200	D-T07/T15	FG-15	HS 037100	
IDI023	US 3505-T09P	3.0	M 3.5	.197	D-T07P/T09P	FG-15	HS 037100	
IDI024	US 70	5.0	M 4	.200	D-T07/T15	FG-15	HS 037100	
IDI025	US 70	5.0	M 4	.200	D-T07/T15	FG-15	HS 050125	

## SNHQ AZ

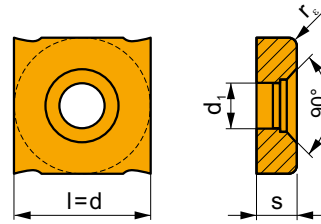
	d	d <sub>1</sub>	l	s
1102	.433	.169	.433	.091
1103	.433	.169	.433	.106
1203	.500	.197	.500	.126
1204	.500	.197	.500	.177
1205	.500	.197	.500	.213
1207	.500	.197	.500	.276



		ANSI		P	M	K	N	S	H			r <sub>e</sub>	f <sub>min</sub>	f <sub>max</sub>	a <sub>p min</sub>	a <sub>p max</sub>	
		SNHQ 1203AZEN	M8340	■	■	■	□	□	□	⚙	+/-	-	.004	.016	-	-	
			8215	■	■	■	□	□	□	⚙	-	-	.004	.016	-	-	
		SNHQ 1204AZEN	M8340	■	■	■	□	□	□	⚙	+	-	.008	.020	-	-	
			8215	■	■	■	□	□	□	⚙	-	-	.008	.020	-	-	
		SNHQ 1205AZEN	M8340	■	■	■	□	□	□	⚙	+	-	.008	.020	-	-	
			8215	■	■	■	□	□	□	⚙	-	-	.008	.020	-	-	
			SNHQ 1207AZEN	M8340	■	■	■	□	□	□	⚙	+/-	-	.008	.020	-	-
				8215	■	■	■	□	□	□	⚙	-	-	.008	.020	-	-
			SNHQ 1102AZTN	M8330	■	■	■	□	□	□	⚙	-	-	.004	.016	-	-
				M8340	■	■	■	□	□	□	⚙	+	-	.004	.016	-	-
			SNHQ 1103AZTN	M8330	■	■	■	□	□	□	⚙	-	-	.004	.016	-	-
				M8340	■	■	■	□	□	□	⚙	+	-	.004	.016	-	-
			8230	■	■	■	□	□	□	⚙	-	-	.004	.016	-	-	
		SNHQ 1203AZTN	M8330	■	■	■	□	□	□	⚙	-	-	.004	.016	-	-	
			M8340	■	■	■	□	□	□	⚙	+	-	.004	.016	-	-	
		SNHQ 1204AZTN	M8330	■	■	■	□	□	□	⚙	-	-	.004	.016	-	-	
			M8340	■	■	■	□	□	□	⚙	+	-	.008	.020	-	-	
		SNHQ 1205AZTN	M8330	■	■	■	□	□	□	⚙	-	-	.008	.020	-	-	
			M8340	■	■	■	□	□	□	⚙	+	-	.008	.020	-	-	
	SNHQ 1207AZTN	M8330	■	■	■	□	□	□	⚙	-	-	.008	.020	-	-		
		M8340	■	■	■	□	□	□	⚙	+	-	.008	.020	-	-		
				8230	■	■	■	□	□	□	⚙	-	-	.008	.020	-	-

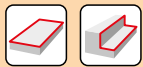
## SNHQ TRL

	d	d <sub>1</sub>	l	s
1203	.500	.197	.500	.126
1204	.500	.197	.500	.177
1205	.500	.197	.500	.213
1207	.500	.197	.500	.276



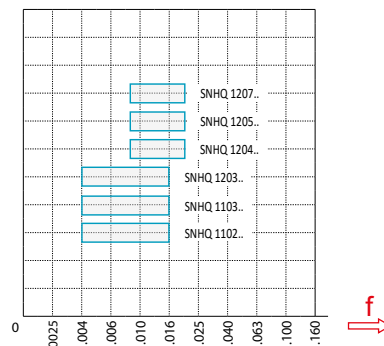
		ANSI		P	M	K	N	S	H			r <sub>ε</sub>	f <sub>min</sub>	f <sub>max</sub>	a <sub>p min</sub>	a <sub>p max</sub>
		SNHQ 120305TRL	M8340	■	▣	▣		□			+/-	.020	.004	.016	-	-
		SNHQ 120310TRL	M8340	■	▣	▣		□			+/-	.039	.004	.016	-	-
		SNHQ 120315TRL	M8340	■	▣	▣		□			+/-	.059	.004	.016	-	-
		SNHQ 120405TRL	M8340	■	▣	▣		□			+/-	.020	.008	.020	-	-
		SNHQ 120410TRL	M8340	■	▣	▣		□			+/-	.039	.008	.020	-	-
		SNHQ 120415TRL	M8340	■	▣	▣		□			+/-	.059	.008	.020	-	-
		SNHQ 120505TRL	M8340	■	▣	▣		□			+/-	.020	.008	.020	-	-
		SNHQ 120510TRL	M8340	■	▣	▣		□			+/-	.039	.008	.020	-	-
		SNHQ 120515TRL	M8340	■	▣	▣		□			+/-	.059	.008	.020	-	-
		SNHQ 120705TRL	M8340	■	▣	▣		□			+/-	.020	.008	.020	-	-
		SNHQ 120710TRL	M8340	■	▣	▣		□			+/-	.039	.008	.020	-	-
		SNHQ 120715TRL	M8340	■	▣	▣		□			+/-	.059	.008	.020	-	-

ISO		$f_{min}$	$f_{max}$	M8340	8215	M8330
P	●	.0039	.0118	961	1033	945
	●	.0039	.0098	843	902	827
	✘	.0039	.0059	725	768	709
M	●	.0039	.0098	577	620	561
	●	.0039	.0079	502	531	502
	✘	.0039	.5906	430	459	430
K	●	.0039	.0118	902	974	902
	●	.0039	.0098	797	856	784
	✘	.0039	.0059	696	725	679
N	●	.0039	.0118	-	2598	2379
	●	.0039	.0098	-	2260	2096
	✘	.0039	.0059	-	1936	1801
S	●	.0039	.0098	282	312	282
	●	.0039	.0079	253	266	253
	✘	.0039	.0059	207	223	207
H	●	.0039	.0079	-	207	177
	●	.0039	.0059	-	177	164
	✘	.0039	.0047	-	148	135




$a_p/D$	.05	.10	.15	.20	.25	.30	.40	.50	.60	.70	.75	.80	.90	1.00
	1.48	1.35	1.27	1.22	1.19	1.16	1.11	1.08	1.05	1.03	1.00	1.00	1.00	1.00

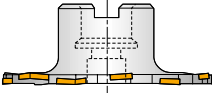
	SNHQ AZEN	SNHQ AZTN	SNHQ 12TRL
$r_f$	-	-	.020 - .059
$a$	-	-	-




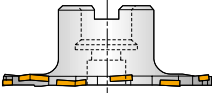
	$D$		$H$	$\max$
	3.00	4	.630	.630
	4.00	5	.945	.945
	5.00	6	1.220	1.220
	6.00	5	1.693	1.693
	8.00	9	2.441	2.441
	2.50	3	.413	2.480
	3.00	4	.689	3.150
	4.00	5	.925	3.937
	5.00	6	.945	4.921
	6.00	8	1.614	6.299




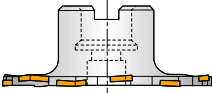
$a_e$	.197		.394		.591		.787		.984		
$\varnothing D$	$f_{min}$	$f_{max}$	$f_{min}$	$f_{max}$	$f_{min}$	$f_{max}$	$f_{min}$	$f_{max}$	$f_{min}$	$f_{max}$	
	3.00	.011	.014	.008	.010	.007	.008	-	-	-	-
	4.00	.013	.016	.009	.011	.007	.009	.006	.008	-	-
	5.00	.014	.018	.010	.013	.008	.011	.007	.009	.006	.008
	6.00	.016	.020	.011	.014	.009	.012	.008	.010	.007	.009
	8.00	.017	.022	.013	.016	.010	.013	.009	.011	.008	.010

	2.50	.010	.013	.007	.009	.006	.007	.005	.007	.005	.006
	3.00	.011	.014	.008	.010	.007	.008	.006	.007	.005	.007
	4.00	.013	.016	.009	.011	.007	.009	.006	.008	.006	.007
	5.00	.014	.018	.010	.013	.008	.011	.007	.009	.006	.008
	6.00	.016	.020	.011	.014	.009	.012	.008	.010	.007	.009

$a_e$	1.260		1.575		1.969		2.480		3.150	
$\varnothing D$	$f_{min}$	$f_{max}$	$f_{min}$	$f_{max}$	$f_{min}$	$f_{max}$	$f_{min}$	$f_{max}$	$f_{min}$	$f_{max}$
	3.00	-	-	-	-	-	-	-	-	-
	4.00	-	-	-	-	-	-	-	-	-
	5.00	-	-	-	-	-	-	-	-	-
	6.00	.006	.008	.006	.007	-	-	-	-	-
	8.00	.007	.009	.006	.008	.006	.007	-	-	-

	2.50	.004	.006	.004	.005	.004	.005	.004	.004	-	-
	3.00	.005	.006	.004	.006	.004	.005	.004	.005	.004	.004
	4.00	.005	.007	.005	.006	.004	.006	.004	.005	.004	.005
	5.00	.006	.007	.005	.007	.005	.006	.004	.006	.004	.005
	6.00	.006	.008	.006	.007	.005	.007	.005	.006	.004	.006

$a_e$	3.937		4.921		6.299	
$\varnothing D$	$f_{min}$	$f_{max}$	$f_{min}$	$f_{max}$	$f_{min}$	$f_{max}$
	3.00	-	-	-	-	-
	4.00	-	-	-	-	-
	5.00	-	-	-	-	-
	6.00	-	-	-	-	-
	8.00	-	-	-	-	-

	2.50	-	-	-	-	-
	3.00	-	-	-	-	-
	4.00	.004	.004	-	-	-
	5.00	.004	.005	.004	.004	-
	6.00	.004	.005	.004	.005	.004

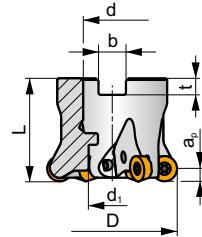
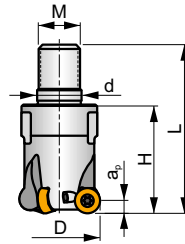
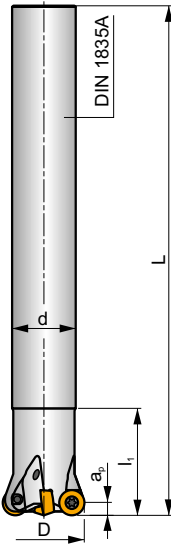
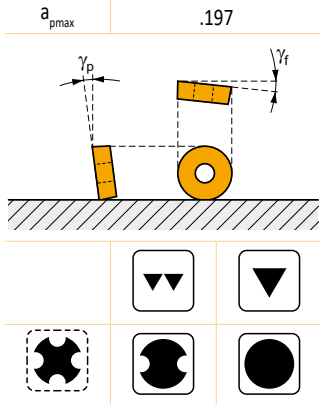
COPY MILLING  
COPIADO  
COPIAGE



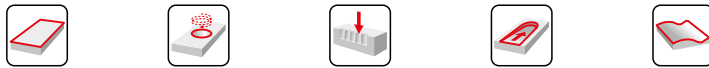
**ISRC10**

**P M K N S H**

**S**



.003 - .006  
 .002 - .005



ANSI	D	D <sub>1</sub>	L	d	d <sub>1</sub>	l	H	M	b	t	γ <sub>p</sub> °	γ <sub>f</sub> °							
<b>100E2R134C075-ISRC10-C</b>	1.000	-	6.700	.750	-	1.339	-	-	-	-	-7	-3	2	-	20900	✓	1.61	GI328	IC0010
<b>100E3R134C075-ISRC10-C</b>	1.000	-	6.700	.750	-	1.339	-	-	-	-	-7	-3	3	-	20900	✓	1.61	GI328	IC0010
<b>125E3R165C100-ISRC10-C</b>	1.250	-	7.900	1.000	-	1.654	-	-	-	-	-7	-2.6	3	-	18500	✓	3.35	GI328	IC0010
<b>125E4R165C100-ISRC10-C</b>	1.250	-	7.900	1.000	-	1.654	-	-	-	-	-7	-2.6	4	-	18500	✓	3.35	GI328	IC0010
<b>100E2R126M12-ISRC10-C</b>	1.000	.827	2.126	.492	-	-	1.260	M12	-	-	-7	-3	2	-	20900	✓	.40	GI328	IC0010
<b>100E3R126M12-ISRC10-C</b>	1.000	.827	2.126	.492	-	-	1.260	M12	-	-	-7	-3	3	-	20900	✓	.40	GI328	IC0010
<b>125E3R165M16-ISRC10-C</b>	1.250	1.142	2.559	.669	-	-	1.654	M16	-	-	-7	-2.6	3	-	18500	✓	.88	GI328	IC0010
<b>125E4R165M16-ISRC10-C</b>	1.250	1.142	2.559	.669	-	-	1.654	M16	-	-	-7	-2.6	4	-	18500	✓	.88	GI328	IC0010
<b>150E4R165M16-ISRC10-C</b>	1.500	1.142	2.559	.669	-	-	1.654	M16	-	-	-7	-2.1	4	-	16500	✓	.97	GI328	IC0010
<b>150E5R165M16-ISRC10-C</b>	1.500	1.142	2.559	.669	-	-	1.654	M16	-	-	-7	-2.1	5	-	16500	✓	.97	GI328	IC0010
<b>150A05R-ISMORC10-C</b>	1.500	-	1.575	.500	.433	-	-	-	.258	.165	-7	-2.2	5	-	16500	✓	.73	GI328	IC0012
<b>200A05R-ISMORC10-C</b>	2.000	-	1.575	.750	.630	-	-	-	.321	.193	-7	-2	5	-	14800	✓	1.37	GI328	IC0013
<b>200A06R-ISMORC10-C</b>	2.000	-	1.575	.750	.630	-	-	-	.321	.193	-7	-2	6	-	14800	✓	1.32	GI328	IC0013
<b>250A06R-ISMORC10-C</b>	2.500	-	1.575	.750	.630	-	-	-	.321	.193	-7	-1.8	6	-	13200	✓	2.18	GI328	IC0013
<b>250A07R-ISMORC10-C</b>	2.500	-	1.575	.750	.630	-	-	-	.321	.193	-7	-1.8	7	-	13200	✓	2.14	GI328	IC0013

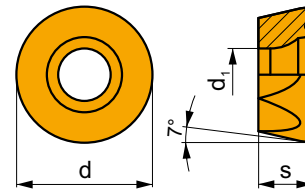
GI328	RCMT 10T3MO..

IC0010	US 63509-T10P	3,0	M 3,5	.354	Flag T10P	-
IC0012	US 63509-T10P	3,0	M 3,5	.354	Flag T10P	HS025100
IC0013	US 63509-T10P	3,0	M 3,5	.354	Flag T10P	HS037100



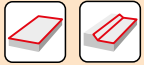
# RCMT 10

	d	d <sub>1</sub>	s
10T3	.394	.154	.156



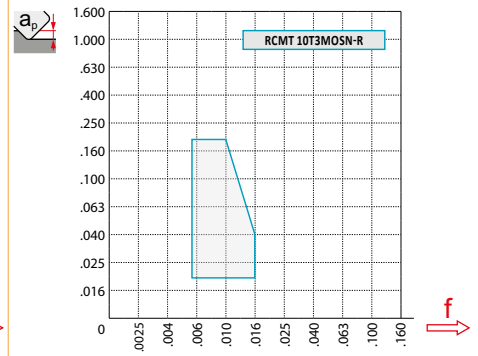
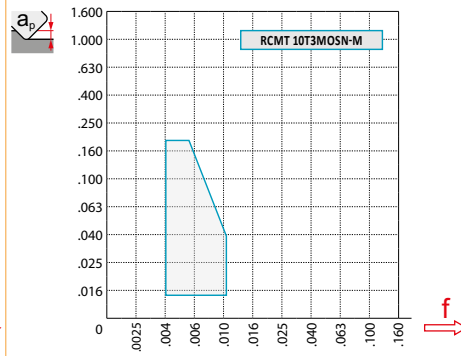
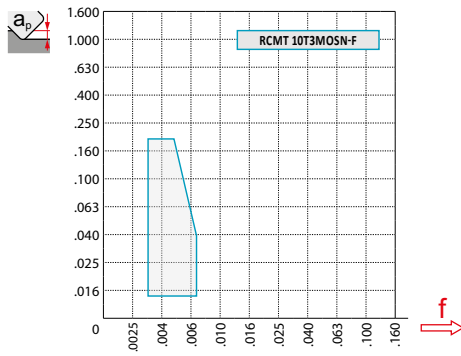
i	ANSI	Material	Material						?		r <sub>c</sub>	f <sub>min</sub>	f <sub>max</sub>	a <sub>p min</sub>	a <sub>p max</sub>
			P	M	K	N	S	H							
	RCMT 10T3MOSN-F	M6330	█	█			█		✘	-	-	.003	.007	.012	.197
		M8310	█	█	□	□	□		✘	-	-	.003	.007	.012	.197
		M8330	█	█	□	□	□		✘	-	-	.003	.007	.012	.197
	RCMT 10T3MOSN-M	M9340	█	█			█		✘	---	-	.004	.009	.012	.197
		M6330	█	█			█		✘	-	-	.004	.011	.012	.197
		M8310	█	█	█		□	□	✘	-	-	.004	.011	.012	.197
		M8330	█	█	█	□	□	□	✘	-	-	.004	.011	.012	.197
		M8340	█	█	█		█		✘	+/-	-	.004	.011	.012	.197
		M8345	█	█			█		✘	+/-	-	.004	.011	.012	.197
	RCMT 10T3MOSN-R	M5315	█		█		█		✘	---	-	.006	.015	.020	.197
		M8310	█	█	█		□	█	✘	-	-	.006	.016	.020	.197
		M8330	█	█	█		□	█	✘	-	-	.006	.016	.020	.197

ISO	f <sub>min</sub>	f <sub>max</sub>	M5315	M9325	M9340	M6330	M8310	M8330	M8340	M8345	
P	●	0.0039	0.0138	1224	1257	1247	981	1175	1056	961	771
	●	0.0039	0.0098	1099	1129	1122	883	1056	951	843	696
	✘	0.0039	0.0059	978	1004	997	784	938	843	725	617
M	●	0.0039	0.0098	-	633	738	692	587	630	577	453
	●	0.0039	0.0079	-	568	666	623	528	568	502	407
	✘	0.0039	0.0059	-	505	591	554	469	502	430	361
K	●	0.0039	0.0138	1158	-	-	-	1109	994	902	-
	●	0.0039	0.0098	1040	-	-	-	997	892	797	-
	✘	0.0039	0.0059	925	-	-	-	886	794	696	-
S	●	0.0039	0.0098	-	276	328	299	256	272	282	197
	●	0.0039	0.0079	-	246	295	269	233	243	253	177
	✘	0.0039	0.0059	-	220	262	240	207	217	207	157
H	●	0.0039	0.0079	240	-	-	-	210	194	-	-
	●	0.0039	0.0059	213	-	-	-	187	174	-	-
	✘	0.0039	0.0047	190	-	-	-	167	154	-	-



$a_p/D$	.05	.10	.15	.20	.25	.30	.40	.50	.60	.70	.75	.80	.90	1.00
$X.V$	1.48	1.35	1.27	1.22	1.19	1.16	1.11	1.08	1.05	1.03	1.00	1.00	1.00	1.00
$X.f$	2.87	2.05	1.69	1.48	1.33	1.23	1.09	.75	.94	.90	.89	.88	.88	1.00
$X.f$	.64	.64	.64	.64	.64	.65	.65	.67	.68	.71	.72	.74	.79	1.00

	RCMT 10-F	RCMT 10-M	RCMT 10-R
$r_f$	.197	.197	.197
$a$	-	-	-



$D$	$a_p$	.000	.006	.012	.020	.030	.039	.049	.059	.079	.098	.118	.157	.197
1.000	$D_{af}$	.606	.702	.741	.778	.814	.843	.867	.887	.921	.947	.967	.992	1.000
1.250		.856	.952	.991	1.028	1.064	1.093	1.117	1.137	1.171	1.197	1.217	1.242	1.250
1.500		1.106	1.202	1.241	1.278	1.314	1.343	1.367	1.387	1.421	1.447	1.467	1.492	1.500
2.000		1.606	1.702	1.741	1.778	1.814	1.843	1.867	1.887	1.921	1.947	1.967	1.992	2.000
2.500		2.106	2.202	2.241	2.278	2.314	2.343	2.367	2.387	2.421	2.447	2.467	2.492	2.500
	$a_p$	-	.006	.012	.020	.030	.039	.049	.059	.079	.098	.118	.157	.197
	$d_{af}$	-	.035	.025	.020	.016	.014	.013	.011	.010	.009	.008	.007	.007



$D$	$\alpha_{max}$	$a_p/l$
1.000	13.2	.197/906
1.250	12.7	.197/945
1.500	9.1	.197/1.300
2.000	6.3	.197/1.851
2.500	4.6	.197/2.520

$D$	$d_{min}$	$d_{max}$	$S_{min}$	$S_{max}$
1.000	1.299	2.000	.118	.118
1.250	1.732	2.500	.118	.118
1.500	2.244	3.000	.118	.118
2.000	3.228	4.000	.118	.118
2.500	4.252	5.000	.118	.118



.091



$\mu\text{m}$

.118

.197

.394

.591

.787

1.181

1.575

1.969

2.362

3.150

3.937

1.000

.022

.028

.040

.049

.056

.069

.079

.089

.097

.112

.125

1.250



.024

.031

.044

.054

.063

.077

.089

.099

.109

.125

.140

1.500

.027

.034

.049

.060

.069

.084

.097

.109

.119

.137

.154

2.000

.031

.040

.056

.069

.079

.097

.112

.125

.137

.159

.177

2.500

.034

.044

.063

.077

.089

.109

.125

.140

.154

.177

.198



$\mu\text{m}$

.118

.197

.394

.591

.787

1.181

1.575

1.969

2.362

3.150

3.937

.197



.014

.018

.025

.030

.035

.043

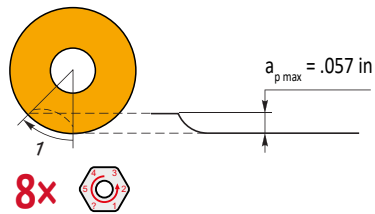
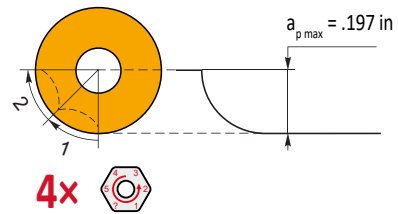
.050

.056

.061

.070

.079



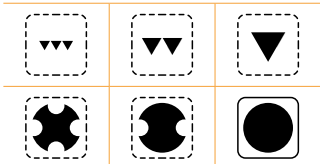
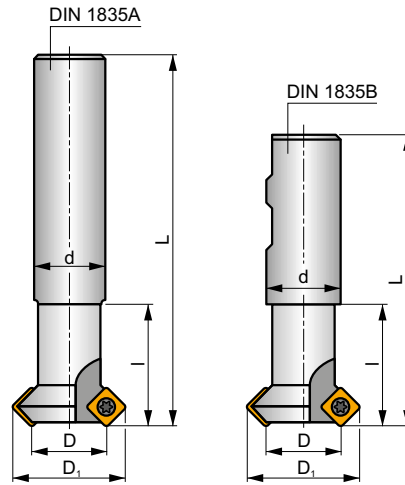
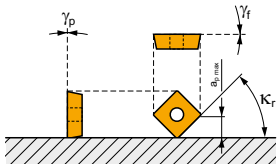


ISSD09

P M K N S H



$\kappa_r$	45°
$a_{pmax}$	.177



$h_m$  .0037-.0059

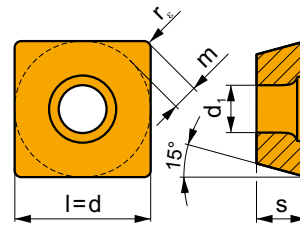
ANSI	D	D <sub>1</sub>	L	d	l	$\gamma_f^\circ$	$\gamma_p^\circ$							
062N2R106C062-ISSD09	.625	1.097	7.874	.625	1.063	0	0	2	-	32200	-	.88	IGI129	ICO070
100N3R128C100-ISSD09	1.000	1.472	7.874	1.000	1.280	0	0	3	-	25800	-	1.54	IGI129	ICH011
037N1R106W062-ISSD09	.375	.847	2.969	.625	1.063	0	0	1	-	40700	-	.26	IGI129	ICO070
062N2R106W062-ISSD09	.625	1.097	2.969	.625	1.063	0	0	2	-	32200	-	.44	IGI129	ICO070
100N3R128W100-ISSD09	1.000	1.472	3.780	1.000	1.280	0	0	3	-	25800	-	.88	IGI129	ICH011

IGI129	SDEW 0903..	SDEX 0903..

ICO070	US 3507-T15	3.0	M 3.5	.280	Flag T15
ICH011	US 3509-T15	3.0	M 3.5	.350	Flag T15

## SDEW 09

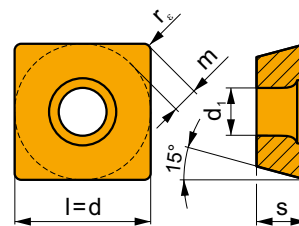
	d	d <sub>1</sub>	l	m	s
0903	.375	.173	.375	.065	.125



<b>i</b>		ANSI		P	M	K	N	S	H			r <sub>e</sub>	f <sub>min</sub>	f <sub>max</sub>	a <sub>p min</sub>	a <sub>p max</sub>
		SDEW 090308EN		<input checked="" type="checkbox"/>	<input type="checkbox"/>	<input checked="" type="checkbox"/>	<input type="checkbox"/>	<input type="checkbox"/>	<input checked="" type="checkbox"/>		-	.031	.004	.012	.039	.177
				<input checked="" type="checkbox"/>	<input type="checkbox"/>	<input checked="" type="checkbox"/>	<input type="checkbox"/>	<input type="checkbox"/>	<input checked="" type="checkbox"/>		+/-	.031	.004	.012	.039	.177
		SDEW 090308SN		<input checked="" type="checkbox"/>	<input type="checkbox"/>	<input checked="" type="checkbox"/>	<input type="checkbox"/>	<input type="checkbox"/>	<input checked="" type="checkbox"/>		-	.031	.006	.012	.039	.177
				<input checked="" type="checkbox"/>	<input type="checkbox"/>	<input checked="" type="checkbox"/>	<input type="checkbox"/>	<input type="checkbox"/>	<input checked="" type="checkbox"/>		+/-	.031	.006	.012	.039	.177
				<input checked="" type="checkbox"/>	<input type="checkbox"/>	<input checked="" type="checkbox"/>	<input type="checkbox"/>	<input type="checkbox"/>	<input checked="" type="checkbox"/>		-	.031	.006	.012	.039	.177
				<input checked="" type="checkbox"/>	<input type="checkbox"/>	<input checked="" type="checkbox"/>	<input type="checkbox"/>	<input type="checkbox"/>	<input checked="" type="checkbox"/>		-	.031	.006	.012	.039	.177
				<input checked="" type="checkbox"/>	<input type="checkbox"/>	<input checked="" type="checkbox"/>	<input type="checkbox"/>	<input type="checkbox"/>	<input checked="" type="checkbox"/>		+/-	.031	.006	.012	.039	.177
				<input checked="" type="checkbox"/>	<input type="checkbox"/>	<input checked="" type="checkbox"/>	<input type="checkbox"/>	<input type="checkbox"/>	<input checked="" type="checkbox"/>		-	.031	.006	.012	.039	.177

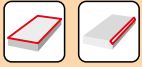
## SDEX 09

	d	d <sub>1</sub>	l	m	s
0903	.375	.173	.375	.065	.125

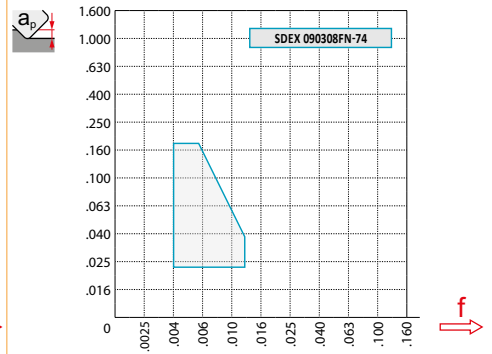
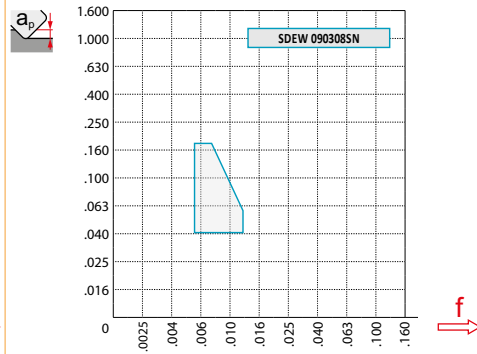
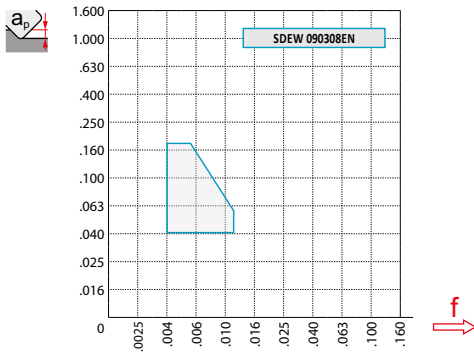


<b>i</b>		ANSI		P	M	K	N	S	H			r <sub>e</sub>	f <sub>min</sub>	f <sub>max</sub>	a <sub>p min</sub>	a <sub>p max</sub>
		SDEX 090308FN-74		<input checked="" type="checkbox"/>	<input checked="" type="checkbox"/>	<input checked="" type="checkbox"/>	<input type="checkbox"/>	<input type="checkbox"/>	<input type="checkbox"/>		-	.031	.004	.012	.020	.177
				<input checked="" type="checkbox"/>	<input checked="" type="checkbox"/>	<input checked="" type="checkbox"/>	<input type="checkbox"/>	<input type="checkbox"/>	<input type="checkbox"/>		-	.031	.004	.012	.020	.177
				<input checked="" type="checkbox"/>	<input checked="" type="checkbox"/>	<input checked="" type="checkbox"/>	<input type="checkbox"/>	<input type="checkbox"/>	<input type="checkbox"/>		-	.031	.004	.012	.020	.177
				<input checked="" type="checkbox"/>	<input checked="" type="checkbox"/>	<input checked="" type="checkbox"/>	<input type="checkbox"/>	<input type="checkbox"/>	<input type="checkbox"/>		-	.031	.004	.012	.020	.177

ISO		$f_{min}$	$f_{max}$	M8340	8215	M8330
P	●	-	-	906	978	892
	●	-	-	794	850	781
	✘	-	-	682	725	669
M	●	-	-	545	587	531
	●	-	-	476	502	476
	✘	-	-	404	433	404
K	●	-	-	850	922	850
	●	-	-	755	810	738
	✘	-	-	656	682	643
N	●	-	-	-	2454	2244
	●	-	-	-	2133	1982
	✘	-	-	-	1827	1703
S	●	-	-	266	292	266
	●	-	-	236	253	236
	✘	-	-	197	210	197
H	●	-	-	-	197	167
	●	-	-	-	167	154
	✘	-	-	-	141	125



	SDEW 09 EN	SDEW 09 SN	SDEX 09
	.031	.031	.031
	-	-	-



$d_{min}$	$d_{max}$		$f_{min}$	$f_{max}$
.394	.866	1.09	.008	.012
.630	1.102	1.17	.010	.013
.984	1.457	1.24	.013	.015



$a_p/D$	.004	.006	.008	.010	.012	.014	.016	.020 - .040																
	$f \rightarrow$																							
45	.017	.021	.026	.014	.017	.022	.012	.015	.019	.011	.013	.017	.010	.012	.015	.009	.011	.014	.008	.011	.013	.007	.009	.012
	1.35	1.27	1.22	1.19	1.16	1.13	1.11	1.00																

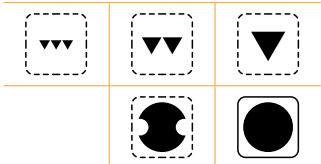
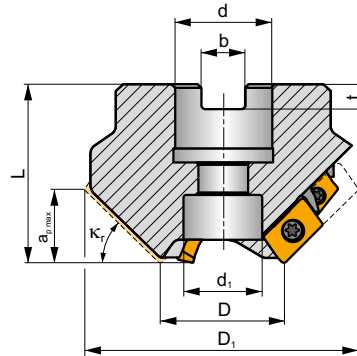
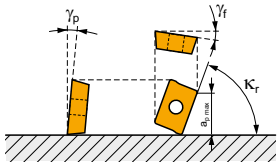


J(T)-ISXP16

P M K N



$\kappa_r$	30-60°
$a_{pmax}$	.276-1.102



.0019-.0043



ANSI	D	D <sub>1</sub>	L	d	d <sub>1</sub>	$\kappa_r$	b	t	$a_{pmax}$	$\gamma_f^\circ$	$\gamma_p^\circ$								
150T03R-IS30XP16-C	1.500	3.350	1.969	1.000	.827	30	.382	.224	.551	-6	0	3	6	-	15200	✓	2.14	IGI208	ICH050
150T03R-IS45XP16-C	1.500	3.035	1.969	1.000	.827	45	.382	.224	.787	-6	2	3	6	-	15200	✓	1.70	IGI208	ICH050
150T03R-IS60XP16-C	1.500	2.642	1.969	1.000	.827	60	.382	.224	.984	-5	4	3	6	-	15200	✓	1.17	IGI208	ICH050
200T04R-IS30XP16-C	2.000	3.850	1.969	1.000	.827	30	.382	.224	.551	-6	0	4	8	✓	13400	✓	2.38	IGI208	ICH050
200T04R-IS45XP16-C	2.000	3.575	1.969	1.000	.827	45	.382	.224	.787	-6	2	4	8	✓	13400	✓	1.98	IGI208	ICH050
200T04R-IS60XP16-C	2.000	3.102	1.969	1.000	.827	60	.382	.224	.984	-5	4	4	8	✓	13400	✓	1.50	IGI208	ICH050



IGI208

XPHT 1604..



ICH050

US 3509-T15

3.0

M 3.5

.350

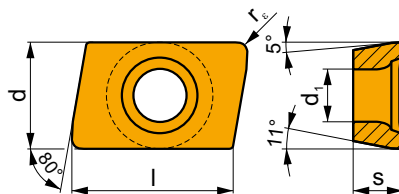
D-T07/T15

FG-15

HS 050125

## XPHT 16

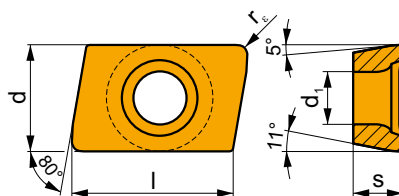
	d	d <sub>1</sub>	l	s
1604	.375	.173	.625	.187



		ANSI		P	M	K	N	S	H			r <sub>e</sub>	f <sub>min</sub>	f <sub>max</sub>	a <sub>p min</sub>	a <sub>p max</sub>
  		XPHT 160412E	M6330	■	■					●	-	.047	.002	.012	.047	.591
		M8330	■	■	■					●	-	.047	.002	.012	.047	.591
		M8340	■	■	■					●	+/-	.047	.002	.012	.047	.591
		8215	■	■	■					●	-	.047	.002	.012	.047	.591
   		XPHT 160412S	M9325	■	■					●	---	.047	.004	.009	.047	.591
		M9340	■	■						●	---	.047	.004	.009	.047	.591
		M8330	■	■	■					●	-	.047	.004	.012	.047	.591
		M8340	■	■	■					●	+/-	.047	.004	.012	.047	.591
		8215	■	■	■					●	-	.047	.004	.012	.047	.591

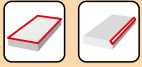
## XPHT 16-FA

	d	d <sub>1</sub>	l	s
1604	.375	.173	.625	.187

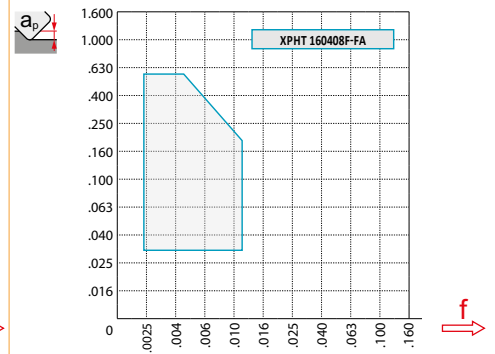
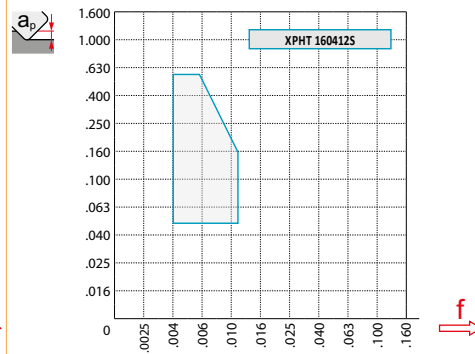
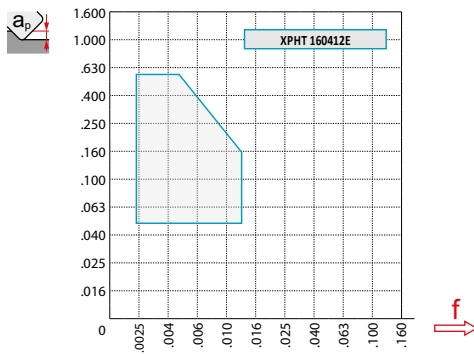


		ANSI		P	M	K	N	S	H			r <sub>e</sub>	f <sub>min</sub>	f <sub>max</sub>	a <sub>p min</sub>	a <sub>p max</sub>
 		XPHT 160408F-FA	HF7				■			●	+/-	.031	.002	.012	.031	.591

ISO		$f_{min}$	$f_{max}$	M9325	M9340	M8340	8215	M8330	HF7
P	●	-	-	1076	932	853	919	840	-
	●	-	-	971	827	748	801	735	-
	✘	-	-	853	735	643	682	630	-
M	●	-	-	643	551	512	551	499	-
	●	-	-	577	499	446	472	446	-
	✘	-	-	512	433	381	407	381	-
K	●	-	-	-	-	801	866	801	-
	●	-	-	-	-	709	761	696	-
	✘	-	-	-	-	617	643	604	-
N	●	-	-	-	-	-	-	-	892
	●	-	-	-	-	-	-	-	801
	✘	-	-	-	-	-	-	-	696



	XPHT 16 E	XPHT 16 S	XPHT 16-FA
$r_\epsilon$	.047	.047	.031
$a$	-	-	-



$a_p/D$	.10	.15	.20	.25	.30	.35	.40	.50 - 1.0																
	$f$																							
15	.039	.053	.020	.031	.043	.017	.027	.037	.015	.024	.033	.014	.022	.031	.013	.020	.028	.012	.019	.026	.011	.017	.024	.024
25	.024	.032	.012	.019	.026	.010	.017	.023	.009	.015	.020	.009	.014	.019	.008	.013	.017	.007	.012	.016	.007	.011	.015	.015
30	.020	.028	.010	.016	.022	.009	.014	.019	.008	.013	.017	.007	.011	.016	.007	.011	.015	.006	.010	.014	.006	.009	.012	.012
35	.017	.024	.009	.014	.020	.007	.012	.017	.007	.011	.015	.006	.010	.014	.006	.009	.013	.006	.009	.012	.005	.008	.011	.011
40	.015	.021	.008	.013	.017	.007	.011	.015	.006	.010	.013	.006	.009	.012	.005	.008	.011	.005	.008	.011	.004	.007	.009	.009
45	.014	.019	.007	.011	.016	.006	.010	.014	.006	.009	.012	.005	.008	.011	.005	.007	.010	.004	.007	.010	.004	.006	.009	.009
50	.013	.018	.007	.011	.015	.006	.009	.013	.005	.008	.011	.005	.007	.010	.004	.007	.009	.004	.007	.009	.004	.006	.008	.008
55	.012	.017	.006	.010	.014	.006	.009	.012	.005	.008	.011	.004	.007	.010	.004	.007	.009	.004	.006	.008	.004	.006	.007	.007
60	.011	.016	.006	.009	.013	.005	.008	.011	.005	.007	.010	.004	.007	.009	.004	.006	.008	.004	.006	.008	.003	.005	.007	.007
75	.010	.014	.005	.008	.011	.005	.007	.010	.004	.007	.009	.004	.006	.008	.004	.006	.007	.003	.005	.007	.003	.005	.006	.006
$X.V$	1.35	1.27	1.22	1.19	1.16	1.13	1.11	1.00																



		$d_{min}$	$d_{max}$		$f_{min}$	$f_{max}$
15	.276	1.378	3.567	1.16	.017	.028
25	.472	1.378	3.437	1.16	.008	.013
30	.551	1.378	3.350	1.17	.006	.010
35	.630	1.378	3.244	1.17	.005	.008
40	.709	1.378	3.126	1.17	.004	.006
45	.787	1.378	2.992	1.18	.004	.006
50	.866	1.378	2.850	1.18	.003	.005
55	.906	1.378	2.693	1.20	.003	.004
60	.984	1.378	2.524	1.20	.003	.004
25	.472	1.772	3.831	1.18	.009	.013
30	.551	1.772	3.740	1.18	.007	.010
35	.630	1.772	3.638	1.19	.006	.008
40	.709	1.772	3.524	1.19	.005	.007
45	.787	1.772	3.386	1.20	.004	.006
50	.866	1.772	3.244	1.21	.004	.005
55	.906	1.772	3.087	1.22	.004	.004
60	.984	1.772	2.917	1.23	.003	.004
75	1.102	1.772	2.366	1.31	.003	.003

Cutters with setting angle 15° can be used as HFC. Use feeds from chamfers table.

Las fresas con ángulo de posición de 15° se pueden utilizar para alto avance (HFC). Utilizar los avances indicados en la tabla de chaflanes.

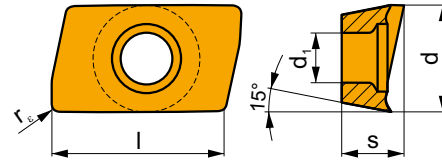
Les fraises avec un angle d'attaque de 15° peuvent être utilisées en grande avance (HF). Utiliser les avances de la table des chanfreins.





## ADEX 07-FA

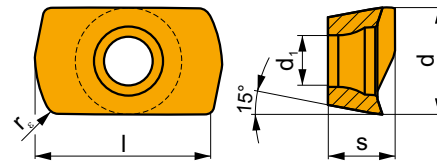
	d	d <sub>i</sub>	l	s
0702	0.177	0.087	0.274	0.098



		ISO		P	M	K	N	S	H			r <sub>c</sub>	f <sub>min</sub>	f <sub>max</sub>	a <sub>p min</sub>	a <sub>p max</sub>
    		ADEX 070204FR-FA	M0315				■			●	++	0.016	0.001	0.008	0.004	0.197
		ADEX 070208FR-FA	HF7				■			●	+/-	0.016	0.001	0.008	0.004	0.197
		ADEX 070208FR-FA	HF7				■			●	+/-	0.031	0.001	0.008	0.004	0.197

## ADEX 07-HF

	d	d <sub>i</sub>	l	s
0702	0.175	0.087	0.254	0.098

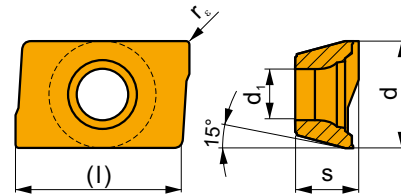


		ISO		P	M	K	N	S	H			r <sub>c</sub>	f <sub>min</sub>	f <sub>max</sub>	a <sub>p min</sub>	a <sub>p max</sub>
   		ADEX 070206SR-HF	M6330	▣	■				▣	●	-	0.024	0.008	0.035	0.004	0.012
			M8330	■	▣	□		□	□	●	-	0.024	0.008	0.035	0.004	0.012
				M8340	■	■	□		▣		●	+/-	0.024	0.008	0.035	0.004



## ADKT 15

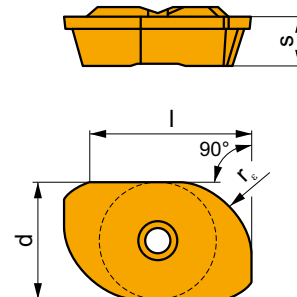
	d	d <sub>1</sub>	l	s
1505	.375	.173	.612	.220



i	ISO	M9315 M9325 M8330 M8340	P	M	K	N	S	H	?	r <sub>e</sub>	f <sub>min</sub>	f <sub>max</sub>	a <sub>p min</sub>	a <sub>p max</sub>	
															ADKT 1505PDER-M
1			■	■	■	■	■	■	●	---	.031	.006	.009	.039	.512
U			■	■	■	■	■	■	●	---	.031	.006	.009	.039	.512
S			■	■	■	■	■	■	●	-	.031	.006	.009	.039	.512
			■	■	■	■	■	■	●	+/-	.031	.006	.012	.039	.512

## ADKX 15

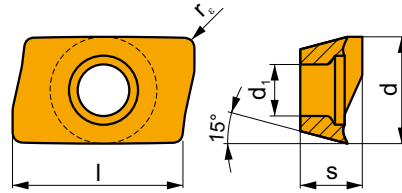
	d	l	s
15T3	.375	.480	.156



i	ANSI	M8345	P	M	K	N	S	H	?	r <sub>e</sub>	f <sub>min</sub>	f <sub>max</sub>	a <sub>p min</sub>	a <sub>p max</sub>	
															ADKX 15T308ER-F
			■	■	■	■	■	■	●	+/-	.031	.002	.005	.012	.394
			■	■	■	■	■	■	✘	+/-	.118	.002	.006	.012	.394
			■	■	■	■	■	■	✘	+/-	.157	.002	.007	.012	.394
			■	■	■	■	■	■	✘	+/-	.236	.002	.010	.012	.394

## ADMX 07

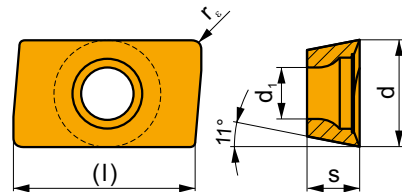
	d	d <sub>1</sub>	l	s
0702	0.176	0.087	0.274	0.098



		ISO		P	M	K	N	S	H			r <sub>c</sub>	f <sub>min</sub>	f <sub>max</sub>	a <sub>p min</sub>	a <sub>p max</sub>
		ADMX 070208SR-M	M6330								-	0.031	0.001	0.005	0.004	0.197

## APET 16-FA

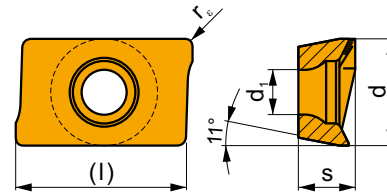
	d	d <sub>1</sub>	l	s
1604	.378	.177	.669	.187



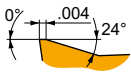
		ISO		P	M	K	N	S	H			r <sub>c</sub>	f <sub>min</sub>	f <sub>max</sub>	a <sub>p min</sub>	a <sub>p max</sub>
		APET 160408FR-FA	HF7								+/-	.031	.002	.016	.031	.591

## APKT 10

	d	d <sub>1</sub>	l	s
1003	.264	.113	.433	.138

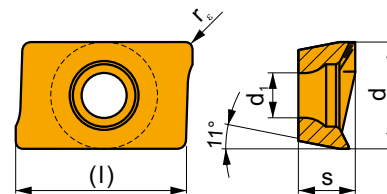


		ISO		P	M	K	N	S	H			r <sub>e</sub>	f <sub>min</sub>	f <sub>max</sub>	a <sub>p min</sub>	a <sub>p max</sub>
   		APKT 1003PDER-M	M9315	■	■	■				●	---	.020	.004	.008	.039	.354
		M9325	■	■	■			■		●	---	.020	.004	.008	.039	.354
		M9340	■	■	■					●	---	.020	.004	.008	.039	.354
		M8330	■	■	■			□		●	-	.020	.004	.010	.039	.354
		M8340	■	■	■			■	■	●	+/-	.020	.004	.010	.039	.354
		8215	■	■	■			□		●	-	.020	.004	.010	.039	.354

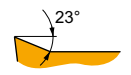


## APKT 10-FA

	d	d <sub>1</sub>	l	s
1003	.264	.113	.433	.138

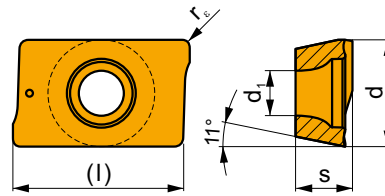


		ISO		P	M	K	N	S	H			r <sub>e</sub>	f <sub>min</sub>	f <sub>max</sub>	a <sub>p min</sub>	a <sub>p max</sub>
  		APKT 1003PDFR-FA	HF7				■			●	+/-	.020	.002	.012	.031	.354



# APKT 16

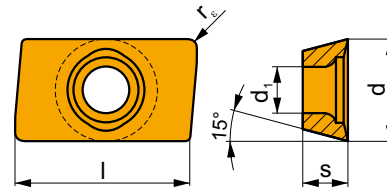
	d	d <sub>1</sub>	l	s
1604	.372	.177	.669	.223



i	ISO	Material	Material Group					Chipbreaker	Coolant	r <sub>c</sub>	f <sub>min</sub>	f <sub>max</sub>	a <sub>p min</sub>	a <sub>p max</sub>
			P	M	K	N	S							
	APKT 1604PDR-GM	M9315	■	■	■			●	---	.031	.006	.009	.039	.512
	M9325	■	■			■		●	---	.031	.006	.009	.039	.512
	M9340	■	■					●	---	.031	.006	.009	.039	.512
	M8330	■	■	■				●	-	.031	.006	.012	.039	.512
	M8340	■	■	■		■		●	+/-	.031	.006	.012	.039	.512
	8230	■	■	■		■		●	-	.031	.006	.012	.039	.512
	APKT 1604PDR-HM	M5315			■			●	---	.031	.008	.014	.039	.512
	M9315	■		■				●	---	.031	.008	.014	.039	.512
	M9325	■	■			■		●	---	.031	.008	.014	.039	.512
	M8330	■	■	■				●	-	.031	.008	.014	.039	.512
	M8340	■	■	■		■		●	+/-	.031	.008	.014	.039	.512
	8215	■	■	■				●	-	.031	.008	.014	.039	.512
	8230	■	■	■		■		●	-	.031	.008	.014	.039	.512
	APKT 160404-HM	M8340	■	■	■		■		●	+/-	.016	.008	.014	.020
APKT 160416-HM	M8340	■	■	■		■		●	+/-	.063	.008	.014	.039	.512
APKT 160431-HM	M8340	■	■	■		■		●	+/-	.122	.008	.014	.039	.512

# APMT 16

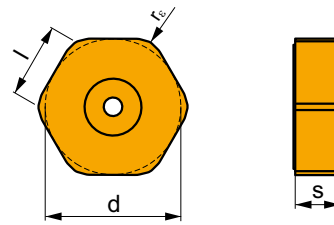
	d	d <sub>1</sub>	l	s
1604	.378	.177	.669	.187



i	ISO	Image	P	M	K	N	S	H	?	Image	r <sub>ε</sub>	f <sub>min</sub>	f <sub>max</sub>	a <sub>p min</sub>	a <sub>p max</sub>
    	APMT 1604PDER-F	 .006 20°	M9340	■	■	■	□	□	■	●	-	.003	.005	.012	.512
			M8330	■	■	■	□	□	■	●	-	.003	.006	.012	.512
    	APMT 1604PDER-FM	 .006 23°	M8330	■	■	■	□	□	■	●	-	.005	.010	.024	.512
			M8345	■	■	■	□	□	■	●	+/-	.005	.010	.024	.512
    	APMT 1604PDER-R	 .006 20°	M8330	■	□	■			■	●	-	.006	.012	.031	.512
			M8345	■	□	■			■	●	+/-	.006	.012	.031	.512
    	APMT 1604PDSR-R	 .007 23°	M8330	■	□	■			✘	●	-	.007	.016	.031	.512
			M8345	■	□	■			✘	●	+/-	.007	.016	.031	.512

## HNEF 09

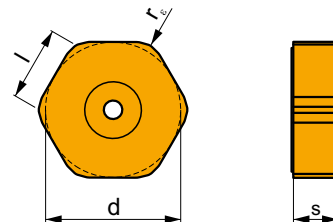
	d	l	s
0905	.638	.370	.222



		ANSI		P	M	K	N	S	H			$r_c$	$f_{min}$	$f_{max}$	$a_{p min}$	$a_{p max}$
		HNEF 0905DNFN-F	M5315	<input type="checkbox"/>		<input checked="" type="checkbox"/>				<input checked="" type="checkbox"/>	---	.016	.003	.008	.012	.118
			M8310	<input type="checkbox"/>		<input checked="" type="checkbox"/>					<input checked="" type="checkbox"/>	-	.016	.003	.008	.012
		HNEF 090508EN-M	M5315	<input type="checkbox"/>		<input checked="" type="checkbox"/>				<input checked="" type="checkbox"/>	---	.031	.007	.012	.039	.157
			8215	<input type="checkbox"/>		<input checked="" type="checkbox"/>					<input checked="" type="checkbox"/>	-	.031	.007	.012	.039
		HNEF 0905ZZR-W	M5315	<input type="checkbox"/>		<input checked="" type="checkbox"/>				<input checked="" type="checkbox"/>	---	.031	.003	.008	.012	.118
			8215	<input type="checkbox"/>		<input checked="" type="checkbox"/>					<input checked="" type="checkbox"/>	-	.031	.003	.008	.012

## HNMF 09

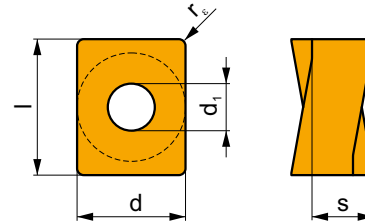
	d	l	s
0905	.638	.370	.222



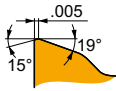
		ANSI		P	M	K	N	S	H			$r_c$	$f_{min}$	$f_{max}$	$a_{p min}$	$a_{p max}$	
		HNMF 090516SN-R	M5315	<input type="checkbox"/>		<input checked="" type="checkbox"/>				<input checked="" type="checkbox"/>	---	.063	.009	.020	.059	.236	
			M9325	<input type="checkbox"/>							<input checked="" type="checkbox"/>	---	.063	.009	.020	.059	.236
			8215	<input type="checkbox"/>		<input checked="" type="checkbox"/>					<input checked="" type="checkbox"/>	-	.063	.009	.020	.059	.236

## LNGU 16

	d	d <sub>1</sub>	l	s
1607	.520	.224	.654	.295



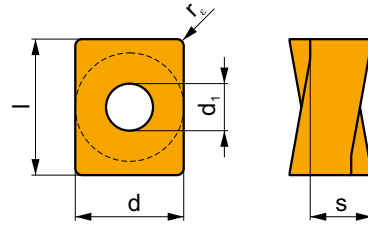
		ANSI		P	M	K	N	S	H			r <sub>s</sub>	f <sub>min</sub>	f <sub>max</sub>	a <sub>p min</sub>	a <sub>p max</sub>
		LNGU 160708SR-M	M9315	■	■	■	■	■	■	■	---	.031	.004	.011	.039	.512
			M9325	■	■	■	■	■	■	■	---	.031	.004	.011	.039	.512
			M8340	■	■	■	■	■	■	■	+/-	.031	.004	.012	.039	.512
			8215	■	■	■	■	■	■	■	-	.031	.004	.012	.039	.512



ISO		f <sub>min</sub>	f <sub>max</sub>	M5315	M9315	M9325	M6330	M8310	M8340	8215	M8330	HF7
P	●	.0039	.0098	1070	1047	1010	787	899	801	863	787	-
	⊗	.0039	.0079	997	961	912	702	814	702	751	689	-
	✘	.0039	.0059	912	863	801	617	725	604	640	591	-
K	●	.0039	.0098	1020	997	-	-	850	751	814	751	-
	⊗	.0039	.0079	948	912	-	-	774	666	715	653	-
	✘	.0039	.0059	873	823	-	-	689	577	604	568	-
N	●	.0039	.0098	-	-	-	-	-	-	-	-	837
	⊗	.0039	.0079	-	-	-	-	-	-	-	-	751
	✘	.0039	.0059	-	-	-	-	-	-	-	-	653
H	●	.0039	.0079	210	210	-	-	174	-	174	148	-
	⊗	.0039	.0059	197	184	-	-	161	-	148	135	-
	✘	.0039	.0047	174	174	-	-	135	-	125	112	-

# LNMU 16

	d	d <sub>1</sub>	l	s
1607	.520	.224	.654	.295

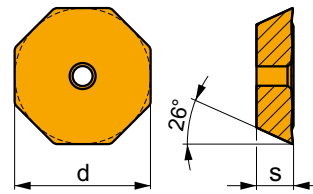


i	ANSI	Material	P	M	K	N	S	H	Chip	Drop	r <sub>c</sub>	f <sub>min</sub>	f <sub>max</sub>	a <sub>p min</sub>	a <sub>p max</sub>
	LNMU 160708ER-F	M8340	■	■	■				☉	+/-	.031	.003	.008	.012	.512
		8215	■	■	■				☉	-	.031	.003	.008	.012	.512
	LNMU 160708SR-M	M9325	■	■	■				☉	---	.031	.004	.007	.012	.512
		M6330	■	■	■				☉	-	.031	.004	.012	.012	.512
	LNMU 160720SR-M	M8340	■	■	■				☉	+/-	.031	.004	.012	.012	.512
		8215	■	■	■		□		☉	-	.031	.004	.012	.012	.512
	LNMU 160730SR-M	M8340	■	■	■				☉	+/-	.079	.004	.012	.012	.512
		M8340	■	■	■				☉	+/-	.118	.004	.012	.012	.512
	LNMU 160740SR-M	M8340	■	■	■				☉	+/-	.157	.004	.012	.012	.512
		M8340	■	■	■				☉	+/-	.157	.004	.012	.012	.512
	LNMU 160708SR-R	M5315	■	■	■			■	☉	---	.031	.006	.014	.039	.512
		M9315	■	■	■			■	☉	---	.031	.006	.014	.039	.512
	LNMU 160716SR-R	M9325	■	■	■			■	☉	---	.031	.006	.014	.039	.512
		M8310	■	■	■			■	☉	-	.031	.006	.016	.039	.512
	LNMU 160716SR-R	M8340	■	■	■			■	☉	+/-	.031	.006	.016	.039	.512
		8215	■	■	■			■	☉	-	.031	.006	.016	.039	.512
	LNMU 160716SR-R	M9315	■	■	■			■	☉	---	.063	.006	.014	.039	.512
		M9325	■	■	■			■	☉	---	.063	.006	.014	.039	.512
	LNMU 160716SR-R	M8340	■	■	■			■	☉	+/-	.063	.006	.016	.039	.512
		M8340	■	■	■			■	☉	+/-	.063	.006	.016	.039	.512



## OFKR 07

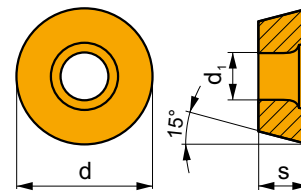
	d	d <sub>1</sub>	s
0704	.703	.104	.180



		ISO		P	M	K	N	S	H			r <sub>c</sub>	f <sub>min</sub>	f <sub>max</sub>	a <sub>p min</sub>	a <sub>p max</sub>	
   		OFKR 0704SN-M	M9340	■	■	■					---	-	.004	.012	.020	.472	
			M8330	■	■	■						-	-	.004	.012	.020	.472
			M8340	■	■	■						+/-	-	.004	.012	.020	.472

## RDET

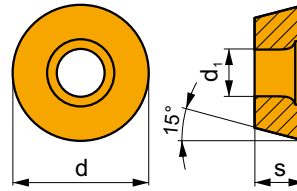
	d	d <sub>1</sub>	s
1003	.394	.173	.125
10T3	.394	.173	.156
12T3	.472	.173	.156



		ISO		P	M	K	N	S	H			r <sub>c</sub>	f <sub>min</sub>	f <sub>max</sub>	a <sub>p min</sub>	a <sub>p max</sub>	
  		RDET 1003MOSN	M8340	■	■	■		■			+/-	-	.004	.012	.020	.079	
			RDET 10T3MOSN	M8340	■	■	■		■			+/-	-	.004	.014	.020	.098
			RDET 12T3MOSN	M8340	■	■	■		■			+/-	-	.004	.014	.020	.118

## RDEW

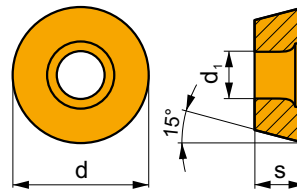
	d	d <sub>1</sub>	s
1003	.394	.173	.125
10T3	.394	.173	.156
12T3	.472	.173	.156



		ISO		P	M	K	N	S	H			r <sub>c</sub>	f <sub>min</sub>	f <sub>max</sub>	a <sub>p min</sub>	a <sub>p max</sub>
		RDEW 1003MOSN	8215									-	.004	.014	.020	.098

## RDEX

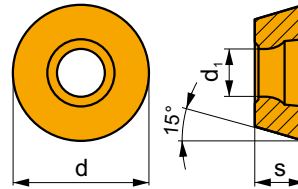
	d	d <sub>1</sub>	s
1204	.472	.173	.187



		ISO		P	M	K	N	S	H			r <sub>c</sub>	f <sub>min</sub>	f <sub>max</sub>	a <sub>p min</sub>	a <sub>p max</sub>
		RDEX 1204MOSN-12	M8340									-	.005	.016	.020	.118

## RDGT 07

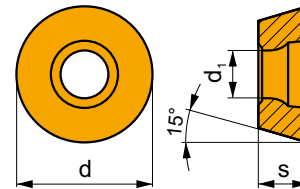
	d	d <sub>1</sub>	s
0702	.276	.110	.094



		ISO		P	M	K	N	S	H			r <sub>c</sub>	f <sub>min</sub>	f <sub>max</sub>	a <sub>p min</sub>	a <sub>p max</sub>
		RDGT 0702MOT		M8325	<input checked="" type="checkbox"/>	<input checked="" type="checkbox"/>	<input type="checkbox"/>	<input type="checkbox"/>	<input type="checkbox"/>	<input type="checkbox"/>		-	.004	.008	.012	.079
					M8345	<input checked="" type="checkbox"/>	<input checked="" type="checkbox"/>	<input type="checkbox"/>	<input checked="" type="checkbox"/>	<input type="checkbox"/>	<input type="checkbox"/>	<input type="checkbox"/>		+/-	.004	.008

## RDGT 10

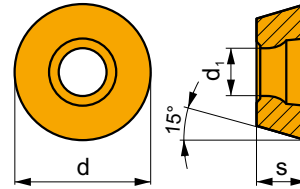
	d	d <sub>1</sub>	s
1003	.394	.154	.125



		ANSI		P	M	K	N	S	H			r <sub>c</sub>	f <sub>min</sub>	f <sub>max</sub>	a <sub>p min</sub>	a <sub>p max</sub>		
		RDGT 1003MOT		M9340	<input checked="" type="checkbox"/>	<input checked="" type="checkbox"/>	<input type="checkbox"/>	<input type="checkbox"/>	<input checked="" type="checkbox"/>	<input type="checkbox"/>		---	.004	.009	.020	.098		
				M6330	<input checked="" type="checkbox"/>	<input checked="" type="checkbox"/>	<input type="checkbox"/>	<input type="checkbox"/>	<input checked="" type="checkbox"/>	<input type="checkbox"/>	<input type="checkbox"/>		-	.004	.012	.020	.098	
				M8310	<input checked="" type="checkbox"/>	<input checked="" type="checkbox"/>	<input checked="" type="checkbox"/>	<input type="checkbox"/>	<input type="checkbox"/>	<input type="checkbox"/>	<input type="checkbox"/>	<input type="checkbox"/>		-	.004	.012	.020	.098
				M8325	<input checked="" type="checkbox"/>	<input checked="" type="checkbox"/>	<input type="checkbox"/>	<input type="checkbox"/>	<input type="checkbox"/>	<input type="checkbox"/>	<input type="checkbox"/>	<input type="checkbox"/>		-	.004	.012	.020	.098
				M8345	<input checked="" type="checkbox"/>	<input checked="" type="checkbox"/>	<input type="checkbox"/>	<input type="checkbox"/>	<input checked="" type="checkbox"/>	<input type="checkbox"/>	<input type="checkbox"/>	<input type="checkbox"/>		+/-	.004	.012	.020	.098

## RDGT 12

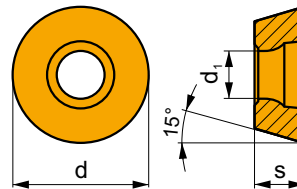
	d	d <sub>1</sub>	s
12T3	.472	.154	.156



i	ANSI	Material	P	M	K	N	S	H	?	Drop	r <sub>c</sub>	f <sub>min</sub>	f <sub>max</sub>	a <sub>p min</sub>	a <sub>p max</sub>
	RDGT 12T3MOT	M9340	☑	☑			☑		☑	---	-	.004	.010	.039	.118
		M6330	☑	☑			☑		✘	-	-	.004	.014	.039	.118
		M8310	☑	☑	☑		☐	☐	☑	-	-	.004	.014	.039	.118
		M8325	☑	☑	☐		☐		☑	-	-	.004	.014	.039	.118
		M8345	☑	☑			☑		✘	+/-	-	.004	.014	.039	.118

## RDGT 16

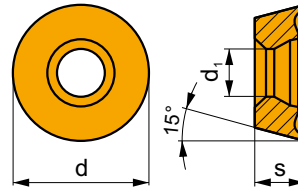
	d	d <sub>1</sub>	s
1604	.630	.205	.187



i	ANSI	Material	P	M	K	N	S	H	?	Drop	r <sub>c</sub>	f <sub>min</sub>	f <sub>max</sub>	a <sub>p min</sub>	a <sub>p max</sub>
	RDGT 1604MOT	M9340	☑	☑			☑		☑	---	-	.004	.012	.039	.157
		M6330	☑	☑			☑		✘	-	-	.004	.016	.039	.157
		M8310	☑	☑	☑		☐	☐	☑	-	-	.004	.016	.039	.157
		M8325	☑	☑	☐		☐		☑	-	-	.004	.016	.039	.157
		M8345	☑	☑			☑		✘	+/-	-	.004	.016	.039	.157

## RDHT 07-FA

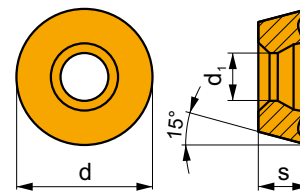
	d	d <sub>1</sub>	s
0702	.276	.110	.094
07T1	.276	.110	.078



		ISO		P	M	K	N	S	H			r <sub>e</sub>	f <sub>min</sub>	f <sub>max</sub>	a <sub>p min</sub>	a <sub>p max</sub>
		RDHT 0702MO-FA	HF7				■			●	+/-	-	.004	.008	.012	.079

## RDHT 10-FA

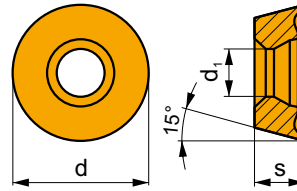
	d	d <sub>1</sub>	s
1003	.394	.154	.125



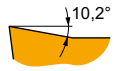
		ANSI		P	M	K	N	S	H			r <sub>e</sub>	f <sub>min</sub>	f <sub>max</sub>	a <sub>p min</sub>	a <sub>p max</sub>
		RDHT 1003MO-FA	HF7				■			●	+/-	-	.004	.012	.012	.098

## RDHT 12-FA

	d	d <sub>1</sub>	s
12T3	.472	.154	.156

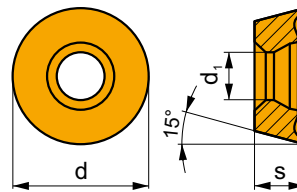


		ANSI		P	M	K	N	S	H			r <sub>c</sub>	f <sub>min</sub>	f <sub>max</sub>	a <sub>p min</sub>	a <sub>p max</sub>
		RDHT 12T3MO-FA	HF7				■			●	+/-	-	.004	.012	.012	.118

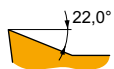


## RDHT 16-FA

	d	d <sub>1</sub>	s
1604	.630	.205	.187

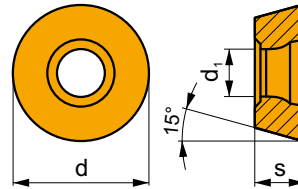


		ANSI		P	M	K	N	S	H			r <sub>c</sub>	f <sub>min</sub>	f <sub>max</sub>	a <sub>p min</sub>	a <sub>p max</sub>
		RDHT 1604MO-FA	HF7				■			●	+/-	-	.004	.016	.012	.157



## RDHX 07

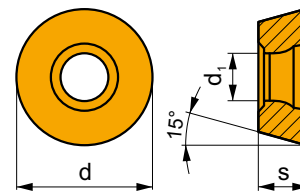
	d	d <sub>1</sub>	s
0702	.276	.110	.094
07T1	.276	.110	.078



i	ISO	Material	P	M	K	N	S	H	?	Lubrication	r <sub>c</sub>	f <sub>min</sub>	f <sub>max</sub>	a <sub>p min</sub>	a <sub>p max</sub>	
																?
  	 .005 20°	RDHX 0702MOT	M4303	█	□	█			█	✘	-	-	.004	.008	.020	.079
		M8310	█	□	█			█	✘	-	-	.004	.008	.020	.079	
		M8325	█	□	□				✘	-	-	.004	.008	.020	.079	
		7205	█	□	█			█	✘	-	-	.004	.007	.020	.079	
		M8310	█	□	█			█	✘	-	-	.004	.007	.020	.079	
		RDHX 07T1MOT	M8325	█	□	□			█	✘	-	-	.004	.007	.020	.079

## RDHX 10

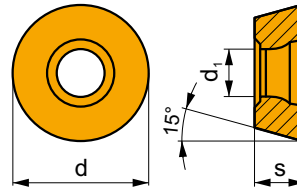
	d	d <sub>1</sub>	s
1003	.394	.154	.125



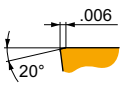
i	ANSI	Material	P	M	K	N	S	H	?	Lubrication	r <sub>c</sub>	f <sub>min</sub>	f <sub>max</sub>	a <sub>p min</sub>	a <sub>p max</sub>	
																?
  	 .006 20°	RDHX 1003MOT	M4303	█	□	█			█	✘	-	-	.004	.012	.020	.098
		M8310	█	□	█			█	✘	-	-	.004	.012	.020	.098	
		M8325	█	□	□				✘	-	-	.004	.012	.020	.098	
		M8345	█	□	█				✘	+/-	-	.004	.012	.020	.098	
		7205	█	□	█			█	✘	-	-	.004	.012	.012	.098	

## RDHX 12

	d	d <sub>1</sub>	s
12T3	.472	.154	.156

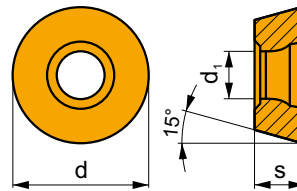


i	ANSI	Material	P	M	K	N	S	H	?	Water	r <sub>c</sub>	f <sub>min</sub>	f <sub>max</sub>	a <sub>p min</sub>	a <sub>p max</sub>
	RDHX 12T3MOT	M4303	█	□	█			█	✘	-	-	.004	.014	.039	.118
		M8310	█	□	█			█	✘	-	-	.004	.014	.039	.118
		M8325	█	□	□				✘	-	-	.004	.014	.039	.118
		M8345	█	□					✘	+/-	-	.004	.014	.039	.118
		7205	█	□	█			█	✘	-	-	.004	.014	.039	.118

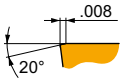


## RDHX 16

	d	d <sub>1</sub>	s
1604	.630	.205	.187



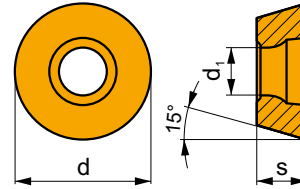
i	ANSI	Material	P	M	K	N	S	H	?	Water	r <sub>c</sub>	f <sub>min</sub>	f <sub>max</sub>	a <sub>p min</sub>	a <sub>p max</sub>
	RDHX 1604MOT	M9325	█	□					✘	---	-	.008	.016	.039	.157
		M8310	█	□	█			█	✘	-	-	.008	.016	.039	.157
		M8325	█	□	□				✘	-	-	.008	.016	.039	.157
		M8345	█	□					✘	+/-	-	.008	.016	.039	.157



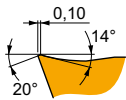


## RDMT 07

	d	d <sub>1</sub>	s
0702	7,000	2,8	2,38

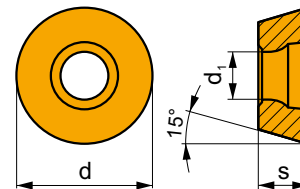


		ISO		P	M	K	N	S	H			r <sub>ε</sub>	f <sub>min</sub>	f <sub>max</sub>	a <sub>p min</sub>	a <sub>p max</sub>
		RDMT 0702MOT	M8325	■	▣	□					-	-	0,10	0,20	0,3	2,0

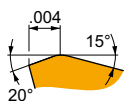


## RDMT 10

	d	d <sub>1</sub>	s
1003	.394	.154	.125

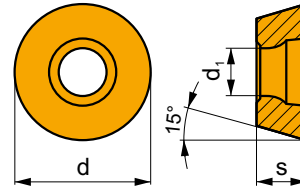


		ANSI		P	M	K	N	S	H			r <sub>ε</sub>	f <sub>min</sub>	f <sub>max</sub>	a <sub>p min</sub>	a <sub>p max</sub>
		RDMT 1003MOT	M8325	■	▣	□					-	-	.005	.012	.020	.098
			M8345	■	▣						+/-	-	.005	.012	.020	.098



## RDMT 12

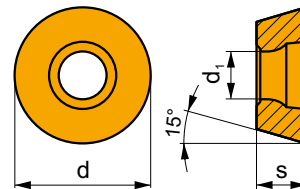
	d	d <sub>1</sub>	s
12T3	.472	.154	.156



i	ANSI	M8325 M8345	P	M	K	N	S	H	?	r <sub>c</sub>	f <sub>min</sub>	f <sub>max</sub>	a <sub>p min</sub>	a <sub>p max</sub>
HFC	RDMT 12T3MOT	M8325	■	▣	□				☹	-	.006	.014	.039	.118
		M8345	■	▣					✘	+/-	.006	.014	.039	.118

## RDMT 16

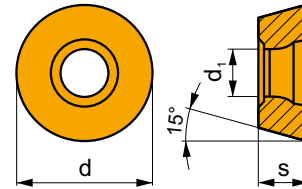
	d	d <sub>1</sub>	s
1604	.630	.205	.187



i	ANSI	M8325 M8345	P	M	K	N	S	H	?	r <sub>c</sub>	f <sub>min</sub>	f <sub>max</sub>	a <sub>p min</sub>	a <sub>p max</sub>
HFC	RDMT 1604MOT	M8325	■	▣	□				☹	-	.007	.016	.039	.157
		M8345	■	▣					✘	+/-	.007	.016	.039	.157

## RDMX 10

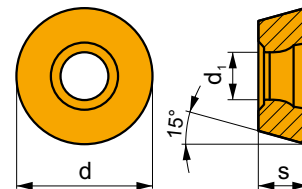
	d	d <sub>1</sub>	s
1003	.394	.154	.125



		ANSI		P	M	K	N	S	H			r <sub>c</sub>	f <sub>min</sub>	f <sub>max</sub>	a <sub>p min</sub>	a <sub>p max</sub>	
  		RDMX 1003MOT	M8310	<input checked="" type="checkbox"/>	<input type="checkbox"/>	<input checked="" type="checkbox"/>			<input checked="" type="checkbox"/>	<input checked="" type="checkbox"/>	-	-	.004	.012	.020	.098	
		M8325	<input checked="" type="checkbox"/>	<input type="checkbox"/>	<input type="checkbox"/>					<input checked="" type="checkbox"/>	<input checked="" type="checkbox"/>	-	-	.004	.012	.020	.098
		M8345	<input checked="" type="checkbox"/>	<input type="checkbox"/>							<input checked="" type="checkbox"/>	<input checked="" type="checkbox"/>	+/-	-	.004	.012	.020

## RDMX 12

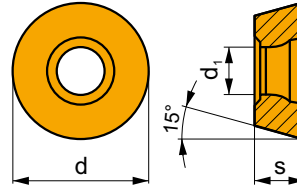
	d	d <sub>1</sub>	s
12T3	.472	.154	.156



		ANSI		P	M	K	N	S	H			r <sub>c</sub>	f <sub>min</sub>	f <sub>max</sub>	a <sub>p min</sub>	a <sub>p max</sub>	
  		RDMX 12T3MOT	M8310	<input checked="" type="checkbox"/>	<input type="checkbox"/>	<input checked="" type="checkbox"/>			<input checked="" type="checkbox"/>	<input checked="" type="checkbox"/>	-	-	.004	.014	.039	.118	
		M8325	<input checked="" type="checkbox"/>	<input type="checkbox"/>	<input type="checkbox"/>					<input checked="" type="checkbox"/>	<input checked="" type="checkbox"/>	-	-	.004	.014	.039	.118
		M8345	<input checked="" type="checkbox"/>	<input type="checkbox"/>							<input checked="" type="checkbox"/>	<input checked="" type="checkbox"/>	+/-	-	.004	.014	.039

# RDMX 16

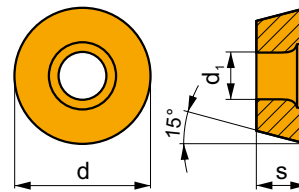
	d	d <sub>1</sub>	s
1604	.630	.205	.187



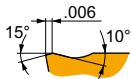
		ANSI		P	M	K	N	S	H			r <sub>c</sub>	f <sub>min</sub>	f <sub>max</sub>	a <sub>p min</sub>	a <sub>p max</sub>	
  		RDMX 1604MOT	M8310	<input checked="" type="checkbox"/>	<input type="checkbox"/>	<input checked="" type="checkbox"/>			<input checked="" type="checkbox"/>	<input checked="" type="checkbox"/>	-	-	.008	.016	.039	.157	
			M8325	<input checked="" type="checkbox"/>	<input type="checkbox"/>	<input type="checkbox"/>					<input checked="" type="checkbox"/>	-	-	.008	.016	.039	.157
			M8345	<input checked="" type="checkbox"/>	<input type="checkbox"/>							<input checked="" type="checkbox"/>	+/-	-	.008	.016	.039

## RPET 12

	d	d <sub>1</sub>	s
1204	.472	.173	.187

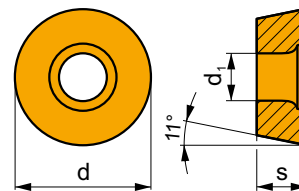


i	ISO	Machining	Material						?	Lubrication	r <sub>c</sub>	f <sub>min</sub>	f <sub>max</sub>	a <sub>p min</sub>	a <sub>p max</sub>
			P	M	K	N	S	H							
  	RPET 1204MOSN	M8330	■	▣	▣		□	□	✘	-	-	.005	.016	.020	.118
		M8340	■	■	▣		▣		✘	+/-	-	.005	.016	.020	.118
		8215	▣	▣	▣		□	□	✘	-	-	.005	.016	.020	.118

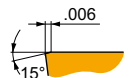


## RPEW 12

	d	d <sub>1</sub>	s
1204	.472	.173	4,76

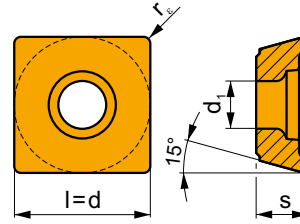


i	ISO	Machining	Material						?	Lubrication	r <sub>c</sub>	f <sub>min</sub>	f <sub>max</sub>	a <sub>p min</sub>	a <sub>p max</sub>
			P	M	K	N	S	H							
  	RPEW 1204MOSN	M8325	▣	□	□				✘	-	-	.004	.016	.020	.118
		M8330	▣	□	■		▣		✘	-	-	.004	.016	.020	.118
		M8340	▣	□	▣				✘	+/-	-	.004	.016	.020	.118
		8215	▣	□	■			■	✘	-	-	.004	.016	.020	.118



# SDMT 12

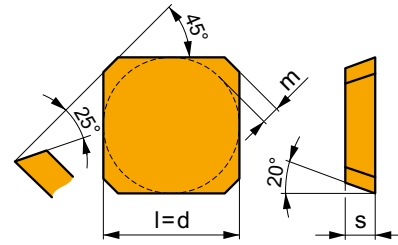
	d	d <sub>1</sub>	l	s
1205	.500	.173	.500	.197



		ISO		P	M	K	N	S	H			r <sub>c</sub>	f <sub>min</sub>	f <sub>max</sub>	a <sub>p min</sub>	a <sub>p max</sub>
		SDMT 120508SR-F	M8330	■	■	■	□	□			-	.031	.003	.010	.039	.197
		M8340	■	■	■		■				+/-	.031	.003	.010	.039	.197
		SDMT 120508SR-M	M9325	■	■			■			---	.031	.004	.007	.039	.394
		M8330	■	■	■	□	□				-	.031	.004	.010	.039	.394
		M8340	■	■	■		■				+/-	.031	.004	.010	.039	.394
		8215	■	■	■	■	□				-	.031	.004	.010	.039	.394
		SDMT 120508PR-R	M9315	■		■					---	.031	.008	.013	.039	.394
		M9325	■	■			■				---	.031	.008	.013	.039	.394
		M8330	■	■	■	□					-	.031	.008	.018	.039	.394
		M8340	■	■	■		■				+/-	.031	.008	.018	.039	.394

## SEEN

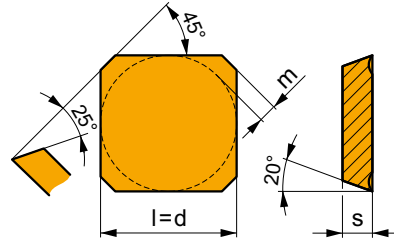
	d	l	m	s
42	.500	.500	.063	.125
43	.500	.500	.063	.187
53	.625	.625	.079	.187



		ISO		P	M	K	N	S	H			$r_e$	$f_{min}$	$f_{max}$	$a_{p min}$	$a_{p max}$	
		SEEN 42AFFN	M9340	█	█						---	-	.002	.010	.020	.256	
		M8330	█	█	□	□					-	-	.002	.012	.020	.256	
		M8340	█	█	□						+/-	-	.002	.012	.020	.256	
		SEEN 43AFFN	M8340	█	█	□					+/-	-	.002	.016	.020	.256	
		SEEN 42AFSN	M9315	█		█			█			---	-	.006	.013	.039	.256
		M9325	█	□							---	-	.006	.013	.039	.256	
		M9340	█	█							---	-	.006	.013	.039	.256	
		M8330	█	█	□	□					-	-	.006	.016	.039	.256	
		M8340	█	█	□						+/-	-	.006	.016	.039	.256	
		8215	█	□	█				█		-	-	.006	.012	.039	.256	
		SEEN 43AFSN	M8340	█	█	□					+/-	-	.006	.016	.039	.256	
		SEEN 53AFSN	M9315	█		█			█			---	-	.008	.013	.039	.354
		M9325	█	□							---	-	.008	.013	.039	.354	
		M9340	█	█							---	-	.008	.013	.039	.354	
		M8330	█	█	□	□					-	-	.008	.016	.039	.354	
		M8340	█	█	□						+/-	-	.008	.016	.039	.354	

## SEER

	d	l	m	s
42	.500	.500	.063	.125
43	.500	.500	.063	.187
53	.625	.625	.079	.187

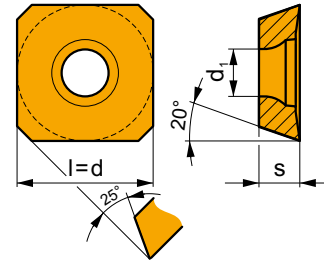


i	ISO	Material	P	M	K	N	S	H	?	Lubrication	r <sub>e</sub>	f <sub>min</sub>	f <sub>max</sub>	a <sub>p min</sub>	a <sub>p max</sub>
	SEER 42AFEN	M8330	■	▣	▣		□	□	☹	-	-	.008	.012	.020	.256
		M8340	■	■	▣		▣		☹	+/-	-	.008	.012	.020	.256
	SEER 43AFEN	M8330	■	▣	▣		□	□	☹	-	-	.008	.016	.020	.256
	SEER 53AFEN	M8330	■	▣	▣		□	□	☹	-	-	.008	.016	.020	.354
	SEER 42AFSN	M9325	■	▣			▣		☹	---	-	.008	.012	.039	.256
		M9340	▣	■					☹	---	-	.008	.012	.039	.256
		M8330	■	▣	▣		□	□	☹	-	-	.008	.016	.039	.256
		M8340	■	■	▣		▣		☹	+/-	-	.008	.016	.039	.256
	SEER 43AFSN	M8330	■	▣	▣		□	□	☹	-	-	.008	.016	.039	.256
		M8340	■	■	▣		▣		☹	+/-	-	.008	.016	.039	.256
	SEER 53AFSN	M9325	■	▣			▣		☹	---	-	.008	.012	.020	.354
		M9340	▣	■					☹	---	-	.008	.012	.020	.354
		M8330	■	▣	▣		□	□	☹	-	-	.008	.016	.039	.354
		M8340	■	■	▣		▣		☹	+/-	-	.008	.016	.039	.354



## SEET 12-PM

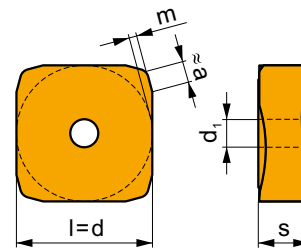
	d	d <sub>i</sub>	l	s
12T3	.528	.165	.528	.156



<b>i</b>		ISO		P	M	K	N	S	H			r <sub>ε</sub>	f <sub>min</sub>	f <sub>max</sub>	a <sub>p min</sub>	a <sub>p max</sub>
		SEET 12T3M-PM	M9325	■	▣			▣		☉	---	-	.008	.014	.039	.256
		M8330	■	▣	▣		□	□	☉	-	-	.008	.014	.039	.256	
		M8340	■	▣	▣		▣		☉	+/-	-	.008	.014	.039	.256	

## SNHF

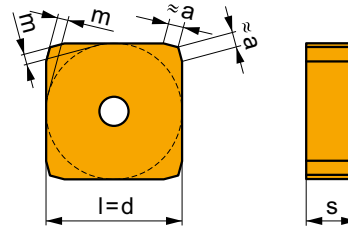
	a	d	l	m	s
43	.079	.500	.500	.020	.187
53	.055	.625	.625	.043	.187



<b>i</b>		ISO		P	M	K	N	S	H			r <sub>ε</sub>	f <sub>min</sub>	f <sub>max</sub>	a <sub>p min</sub>	a <sub>p max</sub>
		SNHF 43ENSR-M	M9325	■	▣			□		☉	---	-	.006	.012	.039	.236
		M8330	■	▣	▣		□		☉	-	-	.006	.012	.039	.236	
		M8340	■	▣	▣		□		☉	+/-	-	.006	.016	.039	.236	
		SNHF 53ENSR-M	M8340	■	▣	▣		□		☉	+/-	-	.006	.016	.039	.354
		M8330	■	▣	▣		□		☉	-	-	.006	.016	.039	.354	

## SNHN

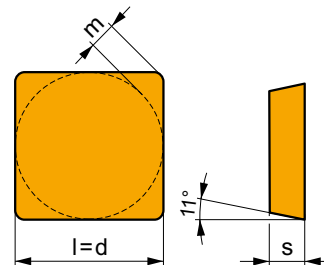
	a	d	l	m	s
43	.055	.500	.500	.037	.187
53	.055	.625	.625	.051	.187



i	ANSI	Material	P	M	K	N	S	H	?	Drop	r <sub>e</sub>	f <sub>min</sub>	f <sub>max</sub>	a <sub>p min</sub>	a <sub>p max</sub>	
																U
U	SNHN 43ENEN	M9315	█	█	█			█	⊛	---	-	.004	.013	.020	.354	
		M9325	█	□	█				⊛	---	-	.004	.013	.020	.354	
		M8330	█	█	█		□			⊛	-	-	.004	.016	.020	.354
		M8340	█	□	█					⊛	+/-	-	.004	.016	.020	.354
		8215	█	□	█				█	⊛	-	-	.004	.016	.020	.354
		8215	█	□	█				█	⊛	-	-	.004	.016	.020	.354
E	SNHN 53ENEN	M8330	█	█	█		□		⊛	-	-	.004	.016	.020	.531	
		M8340	█	□	█				⊛	+/-	-	.004	.016	.020	.531	
		8215	█	□	█			█	⊛	-	-	.004	.016	.020	.531	

## SPG

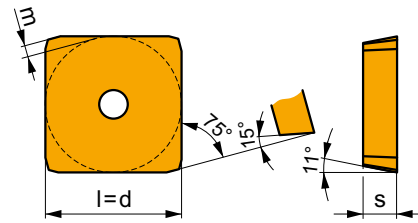
	d	l	m	s
32	.375	.375	.065	.125
42	.500	.500	.091	.125



i	ANSI	Material	P	M	K	N	S	H	?	Drop	r <sub>e</sub>	f <sub>min</sub>	f <sub>max</sub>	a <sub>p min</sub>	a <sub>p max</sub>
U	SPG 322	M8340	█	□	█				⊛	+/-	.031	.004	.010	.039	.236
	SPG 421	M8330	█	□	█			█	⊛	-	.016	.004	.010	.020	.354
		M8340	█	□	█				⊛	+/-	.016	.004	.010	.020	.354
E	SPG 422	M8330	█	□	█			█	⊛	-	.031	.004	.010	.039	.354
	SPG 532	M8330	█	□	█			█	⊛	-	.031	.004	.014	.039	.531
	SPG 533	M8330	█	□	█			█	⊛	-	.047	.004	.014	.047	.531

## SPKN

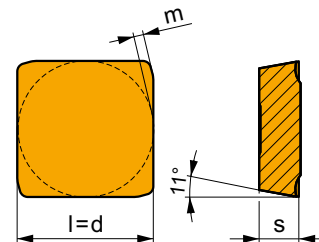
	d	l	m	s
42	.500	.500	.035	.125
53	.625	.625	.050	.187



i	ANSI	Image	P	M	K	N	S	H	Image	Image	$r_\epsilon$	$f_{min}$	$f_{max}$	$a_{p\ min}$	$a_{p\ max}$
+	SPKN 42EDER	M8330	█	□	█			█	☹	-	-	.004	.010	.039	.354
	M8340	█	□	█					☹	+/-	-	.004	.010	.039	.354
E	SPKN 53EDER	M8330	█	□	█			█	☹	-	-	.004	.014	.039	.512
	M8340	█	□	█					☹	+/-	-	.004	.014	.039	.512
U	SPKN 53EDEL	M8330	█	□	█			█	☹	-	-	.004	.014	.039	.512
	SPKN 42EDSR	M9315	█		█			█	☹	---	-	.006	.010	.039	.354
S	M9325	█	□						☹	---	-	.006	.010	.039	.354
	M8330	█	□	█			█	☹	☹	-	-	.006	.012	.039	.354
	M8340	█	□	█					☹	+/-	-	.006	.012	.039	.354
	8215	█	□	█			█	☹	☹	-	-	.006	.012	.039	.354
U	SPKN 42EDSL	M8330	█	□	█			█	☹	-	-	.006	.012	.039	.354
	SPKN 53EDSR	M5315	█		█			█	☹	---	-	.008	.013	.039	.512
S	M9315	█		█			█	☹	☹	---	-	.008	.013	.039	.512
	M9325	█	□						☹	---	-	.008	.013	.039	.512
	M8330	█	□	█			█	☹	☹	-	-	.008	.016	.039	.512
	M8340	█	□	█					☹	+/-	-	.008	.016	.039	.512
	8215	█	□	█			█	☹	☹	-	-	.008	.016	.039	.512

## SPKR

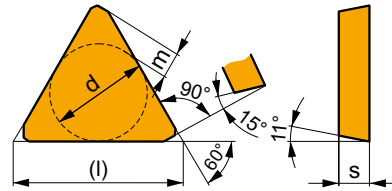
	d	l	m	s
42	.500	.500	.035	.125
53	.625	.625	.048	.187



i	ANSI	Image	P	M	K	N	S	H	Image	Image	$r_\epsilon$	$f_{min}$	$f_{max}$	$a_{p\ min}$	$a_{p\ max}$
1	SPKR 42EDSR	M9325	█	█			█		☹	---	-	.006	.009	.039	.354
	M8330	█	█	█		□	□		☹	-	-	.006	.012	.039	.354
	M8340	█	█	█		█			☹	+/-	-	.006	.012	.039	.354
S	SPKR 53EDSR	M8330	█	█	█		□	□	☹	-	-	.010	.018	.039	.472
	M8340	█	█	█		█			☹	+/-	-	.010	.018	.039	.472

## TPKN

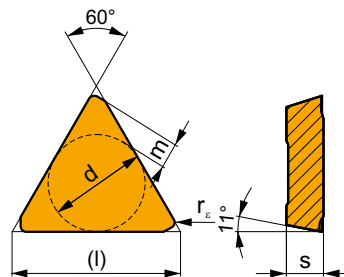
	d	l	m	s
32	.375	.650	.096	.125
43	.500	.866	.140	.187



i	ISO	Material	P	M	K	N	S	H	?	Drop	r <sub>c</sub>	f <sub>min</sub>	f <sub>max</sub>	a <sub>p min</sub>	a <sub>p max</sub>
E	TPKN 32PDER	M8330	☑	☐	☑			☐	●	-	-	.004	.008	.039	.472
		M8340	☑	☐	☑				●	+/-	-	.004	.008	.039	.472
	TPKN 43PDER	M8330	☑	☐	☑			☐	●	-	-	.004	.010	.039	.669
		M8340	☑	☐	☑				●	+/-	-	.004	.010	.039	.669
		8215	☑	☐	☑			☐	●	-	-	.004	.010	.039	.669
	TPKN 32PDSR	M8330	☑	☐	☑			☐	●	-	-	.008	.010	.039	.472
M8340		☑	☐	☑				●	+/-	-	.008	.010	.039	.472	
S	TPKN 43PDSR	M5315	☑	☐	☑			☐	●	---	-	.008	.010	.039	.669
		M9325	☑	☐					●	---	-	.008	.010	.039	.669
		M8310	☑	☐	☑			☐	●	-	-	.008	.012	.039	.669
		M8330	☑	☐	☑			☐	●	-	-	.008	.012	.039	.669
		M8340	☑	☐	☑				●	+/-	-	.008	.012	.039	.669

## TPKR

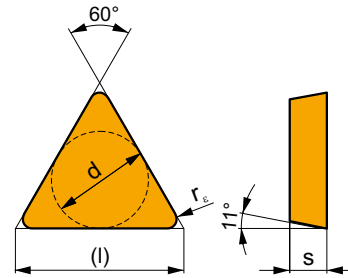
	d	l	m	s
32	.375	.650	.096	.125
43	.500	.866	.140	.187



i	ISO	Material	P	M	K	N	S	H	?	Drop	r <sub>c</sub>	f <sub>min</sub>	f <sub>max</sub>	a <sub>p min</sub>	a <sub>p max</sub>
1	TPKR 32PDSR	M9340	☑	☑					●	---	-	.004	.008	.039	.472
		M8330	☑	☑	☑				●	-	-	.004	.008	.039	.472
		M8340	☑	☑	☑				●	+/-	-	.004	.008	.039	.472
S	TPKR 43PDSR	M9325	☑	☑					●	---	-	.004	.010	.039	.669
		M9340	☑	☑					●	---	-	.004	.010	.039	.669
		M8330	☑	☑	☑				●	-	-	.004	.010	.039	.669
		M8340	☑	☑	☑				●	+/-	-	.004	.010	.039	.669

## TPU

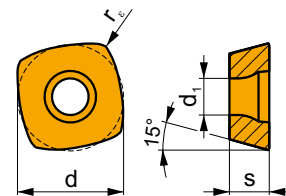
	d	l	s
22	.250	.433	.125
32	.375	.650	.125
43	.500	.866	.187



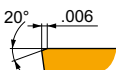
		ANSI		P	M	K	N	S	H			$r_s$	$f_{min}$	$f_{max}$	$a_{p min}$	$a_{p max}$
		TPU 221	M8330	☑	☐	■			☑	●	-	.016	.004	.006	.020	.315
		TPU 222	M8330	☑	☐	■			☑	☉	-	.031	.004	.006	.031	.315
		TPU 321	M8330	☑	☐	■			☐	●	-	.016	.004	.008	.020	.472
			8215	☑	☐	■			☐	●	-	.016	.004	.008	.020	.472
		TPU 322	M8330	☑	☐	■			☑	☉	-	.031	.004	.008	.039	.472
			8215	☑	☐	■			☐	●	-	.031	.004	.008	.039	.472
		TPU 323	M8330	☑	☐	■			☑	☉	-	.047	.004	.008	.047	.472
		TPU 432	M8330	☑	☐	■			☐	●	-	.031	.004	.010	.039	.669
			8215	☑	☐	■			☐	●	-	.031	.004	.010	.039	.669
		TPU 433	M8330	☑	☐	■			☑	☉	-	.047	.004	.010	.047	.669

## ZDCW 07

	d	$d_1$	l	s
0703	.268	.102	.268	.125

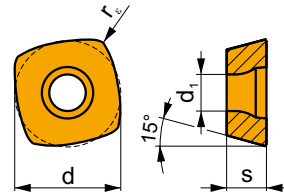


		ANSI		P	M	K	N	S	H			$r_s$	$f_{min}$	$f_{max}$	$a_{p min}$	$a_{p max}$
		ZDCW 070304	M8310	■		■			■	☉	-	.016	.006	.059	.012	.039
			M8325	■		☐				☉	-	.016	.006	.059	.012	.039
			M8345	■						☉	+/-	.016	.006	.059	.012	.039
			7215	☑		■			■	☉	-	.016	.006	.059	.012	.039
			7230	■		■			☑	☉	-	.016	.006	.059	.012	.039



## ZDCW 09

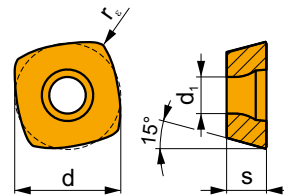
	d	d <sub>1</sub>	l	s
09T3	.375	.134	.375	.156



i	ANSI	Material	P	M	K	N	S	H	?	Lubrication	r <sub>c</sub>	f <sub>min</sub>	f <sub>max</sub>	a <sub>p min</sub>	a <sub>p max</sub>
	ZDCW 09T304	M8310	■		■			■	⊕	-	.016	.012	.079	.012	.039
		M8325	■		□				⊕	-	.016	.012	.079	.012	.039
		M8345	■						⊕	+/-	.016	.012	.079	.012	.039
		7205	▣		■			■	⊕	-	.016	.012	.079	.012	.039
		7215	▣		■			■	⊕	-	.016	.012	.079	.012	.039
		7230	■		■			▣	⊕	-	.016	.012	.079	.012	.039

## ZDEW 12

	d	d <sub>1</sub>	l	s
1204	.500	.173	.500	.187



i	ANSI	Material	P	M	K	N	S	H	?	Lubrication	r <sub>c</sub>	f <sub>min</sub>	f <sub>max</sub>	a <sub>p min</sub>	a <sub>p max</sub>
	ZDEW 120408	M8310	■		■			■	⊕	-	.031	.020	.118	.012	.063
		M8325	■		□				⊕	-	.031	.020	.118	.012	.063
		M8345	■						⊗	+/-	.031	.020	.118	.012	.063
		7205	▣		■			■	⊕	-	.031	.008	.059	.012	.039

**TECHNICAL  
INFORMATION**

**INFORMACIÓN  
TÉCNICA**

**PARTIE  
TECHNIQUE**

**RECOMMENDATIONS FOR DETERMINING STARTING CUTTING CONDITIONS  
RECOMENDACIONES PARA DETERMINAR LAS CONDICIONES DE CORTE INICIALES  
RECOMMANDATIONS POUR DÉTERMINER LES CONDITIONS D'USINAGE DE DÉPART**

The end of the product section of individual tool groups includes a table of starting cutting speeds. The following example will allow you to determine the proper value with regard to the nature of the engagement conditions.

**Example:**

Milling of a flat surface on a steel component with a large amount of intermittent cutting (very unfavourable engagement conditions) using a 63A06R-S90AD11E-C milling cutter with ADMX 11T308SR-M, M9340 inserts.

First, choose feed based on working conditions and choose starting cutting speed. Then, amend the cutting speed based on the table of corrections which is included in the technical section for milling using data for hardness, condition of machined surface, condition of machine tool and required durability.

La fin de la section produit pour chaque groupe d'outils comprend un tableau de Vitesses de Coupe (Vc) de départ. L'exemple ci-dessous vous permettra de déterminer la valeur correcte des conditions d'engagement de base.

**Exemple:**

Fraisage d'une surface plane sur un composant en acier avec une quantité importante d'ouvertures (conditions d'engagement très défavorables) avec une fraise référence 63A06R-S90AD11E-C et des plaquettes ADMX 11T308SR-M nuance M9340.

Choisissez tout d'abord l'avance par dent (f) dans l'intervalle proposé en fonction des conditions d'usinage puis choisissez la vitesse de coupe de départ. Corrigez ensuite la vitesse de coupe sur la base du tableau de corrections qui est inclus dans la section technique Fraisage, en utilisant les données de dureté matière, l'état de la surface usinée, l'état de la machine ainsi que la durée de vie souhaitée.

Picture / Figura / Image 1

A	ISO	f <sub>min</sub>	f <sub>max</sub>	M5315	M9315	M9325	A3 M9340	M0315	M6330	M8310	M8340	M8345	8215	M8330	8240	HF7
				A1 P	●	0.003	0.007	1268	1235	1186	1024	-	926	1056	943	683
●	0.003	0.006	1170		1138	1073	910	-	829	959	829	585	878	813	731	-
✘	A2 0.003	A2 0.004	1073		1024	943	813	A4	731	861	715	488	748	699	601	-
M	●	0.003	0.007	-	-	715	601	-	601	634	569	406	601	553	504	-
	●	0.003	0.006	-	-	634	553	-	536	569	488	341	520	488	439	-
	✘	0.003	0.004	-	-	569	471	-	455	504	423	293	439	423	358	-

- A** Find table with cutting speeds  
Tabla con velocidades de corte  
Trouver le tableau des vitesses de coupe

---

- A1** Find blue section of the table (steels – P)  
Sección azul de la tabla (aceros – P)  
Trouver la section correspondant au type de matière usinée (ex: Aciers – ISO P)

---

- A2** Find feed for difficult engagement conditions (f<sub>min</sub> = .003"/tooth, f<sub>max</sub> = .004"/tooth)  
Avance para condiciones de trabajo difíciles (f<sub>min</sub> = .003"/rev, f<sub>max</sub> = .004"/rev)  
Trouver l'avance correspondant à des conditions défavorables (f<sub>min</sub> = .003"/tr, f<sub>max</sub> = .004"/tr)

---

- A3** Find column with values for material M9340  
Columna con valores para la calidad M9340  
Trouver la colonne correspondant à la nuance carbure utilisée (M9340 dans l'exemple)

---

- A4** Result = starting cutting speed 813 sfm  
Resultado = velocidad de corte inicial 813 sfm  
Résultat: Vitesse de Coupe de base recommandée: 813 sfm



**RECOMMENDATIONS FOR DETERMINING STARTING CUTTING CONDITIONS  
RECOMENDACIONES PARA DETERMINAR LAS CONDICIONES DE CORTE INICIALES  
RECOMMANDATIONS POUR DÉTERMINER LES CONDITIONS D'USINAGE DE DÉPART**

You can further correct the starting cutting speed chosen from the catalogue section by taking into account the required durability:

**Example:**

*Perform specification in relation to machine condition, required durability, blank - required tool life is 20 minutes. Machining is performed on a new machine with relatively low rigidity. The blank is a pre-machined cube of medium-carbon steel with hardness of 240 HB.*

Posteriormente poderá corrigir a velocidade de corte inicial eleita a partir do catálogo tendo em conta a durabilidade requerida:

**Exemplo:**

*Indicar especificação em relação ao estado da máquina durabilidade requerida, peça. O tempo de vida do fio requerido é de 20 minutos. A mecanização realiza-se numa máquina nova com uma rigidez relativamente baixa. A peça é um cubo pré-mecanizado de aço com um conteúdo médio de carbono e uma dureza de 240 HB.*

Vous pouvez également corriger la vitesse de coupe initiale choisie dans la section du catalogue en tenant compte de la durée de vie souhaitée:

**Exemple:**

*Ajuster les spécifications en fonction de l'état de la machine, de la durée de vie souhaitée, de l'état du brut à usiner.*

- La durée de vie de l'outil souhaitée est de 20 minutes.
- L'usinage est effectué sur une nouvelle machine avec une faible rigidité.
- Le brut est un cube pré-usiné en acier au carbone moyen avec une dureté de 240 HB

Picture / Figura / Image 2

Correction for durability (general machining) Corrección para duración (mecanizado general) Correction de durée de vie (usinage général)	
	$k_{vT}$
15	1.23
20	1.13
<b>B1</b> 30	1.00 <b>B2</b>
45	0.89
60	0.81
90	0.72

Correction for durability (heavy roughing) Corrección para duración (desbaste pesado) Correction de durée de vie (ébauche lourde)	
30	1.23
60	1.00
90	0.89
120	0.81

**B1**

Find required durability (20 min)  
Duración requerida (20 min)  
Trouver la durée de vie souhaitée (20 min)

**B2**

Result = correction coefficient for required durability (1.13  $k_{vT}$ )  
Resultado = coeficiente de corrección para la duración requerida (1.13  $k_{vT}$ )  
Résultat = coefficient de correction pour la durée de vie souhaitée (1.13  $k_{vT}$ )

**RECOMMENDATIONS FOR DETERMINING STARTING CUTTING CONDITIONS**  
**RECOMENDACIONES PARA DETERMINAR LAS CONDICIONES DE CORTE INICIALES**  
**RECOMMANDATIONS POUR DÉTERMINER LES CONDITIONS D'USINAGE DE DÉPART**

Further corrections can be made with regard to the condition of the machine and the workpiece.

Se pueden realizar correcciones en función del estado de la máquina y de la pieza.

De plus amples corrections peuvent être apportées en fonction de l'état de la machine et de la pièce à usiner.

Picture / Figura / Image 3

Speed factor $k_{vx}$ / Factor de velocidad $k_{vx}$ / Facteur de vitesse $k_{vx}$	
<b>C1</b>	<div style="display: flex; justify-content: space-between;"> <div style="border: 1px solid red; padding: 2px;">                     Forged and cast piece skin / Corteza de forja o de fundición                      Surface de pièce forgée et coulée                 </div> <div style="border: 1px solid green; padding: 2px; border-radius: 50%; color: white; font-weight: bold;">C2</div> </div> <div style="text-align: center; margin-top: 5px;">0.70 - 0.90</div>
<b>C3</b>	<div style="display: flex; justify-content: space-between;"> <div style="border: 1px solid gray; padding: 2px;">                     Good machine conditions / Buen estado de la máquina                      Bonnes conditions machine                 </div> <div style="border: 1px solid green; padding: 2px; border-radius: 50%; color: white; font-weight: bold;">C4</div> </div> <div style="text-align: center; margin-top: 5px;">1.05 - 1.20</div>
	<div style="border: 1px solid red; padding: 2px;">                     Unstable machine conditions / Mal estado de la máquina                      Mauvaises conditions machine                 </div> <div style="text-align: center; margin-top: 5px;">0.85 - 0.95</div>

- C1

The workpiece is a blank with pre-machined surface, i.e. WITHOUT SKIN - therefore, either do not include at all or use a factor of 1.0  
 Pieza con superficie pre-mecanizada, es decir, SIN CORTEZA - por tanto, bien no incluir o bien utilizar un factor de 1.0  
 La pièce à usiner est une ébauche avec une surface pré-usinée, c'est-à-dire NON BRUTE - donc, soit ne pas appliquer de facteur, soit utiliser un facteur de 1.0
- C2

Result  $k_{vx1} = 1$   
 Resultado  $k_{vx1} = 1$   
 Résultat  $k_{vx1} = 1$
- C3

Find correction for machine condition (it is a new machine, i.e. condition very good)  
 Corrección para el estado de la máquina (es una máquina nueva, es decir, muy buen estado)  
 Trouver une correction pour l'état de la machine (c'est une nouvelle machine, c'est-à-dire en très bonne condition)
- C4

Result  $k_{vx2} = 1.05$  (choose the lower value from the range offered, since the machine is new, but its rigidity is relatively low)  
 Resultado  $k_{vx2} = 1.05$  (elegir el valor más bajo del rango que se ofrece, ya que la máquina es nueva pero su rigidez es relativamente baja)  
 Résultat  $k_{vx2} = 1.05$  (choisissez la valeur inférieure de la plage offerte, puisque la machine est nouvelle, mais sa rigidité est relativement faible)

Finally, perform correction with regard to the type of machined material and its hardness.

Finalmente, realizar la corrección en función del tipo de material mecanizado y su dureza.

Finalement, effectuer la correction en fonction du type de matériau usiné et de sa dureté.

RECOMMENDATIONS FOR DETERMINING STARTING CUTTING CONDITIONS  
 RECOMENDACIONES PARA DETERMINAR LAS CONDICIONES DE CORTE INICIALES  
 RECOMMANDATIONS POUR DÉTERMINER LES CONDITIONS D'USINAGE DE DÉPART

Picture / Figura / Image 4

CORRECTION / CORRECCIÓN / CORRECTION $v_c$				
Subgroup / Subgrupo / Sous-groupe	P1	D1 P2	P3	P4
Workpiece hardness factor / Factor de dureza / Facteur de dureté de la pièce usinée				
Hardness / Dureza / Dureté	$k_{v_{HBP1}}$	$k_{v_{HBP2}}$	$k_{v_{HBP3}}$	$k_{v_{HBP4}}$
120 HB	1.53	1.18	0.94	0.71
140 HB	1.46	1.12	0.90	0.67
160 HB	1.37	1.05	0.84	0.63
180 HB	1.30	1.00	0.80	0.60
200 HB	1.24	0.95	0.76	0.57
220 HB	1.17	0.90	0.72	0.54
D2 240 HB	1.12	0.86 D3	0.69	0.52
260 HB	1.07	0.82	0.66	0.49
280 HB	1.04	0.80	0.64	0.48
300 HB	1.00	0.77	0.62	0.46
320 HB	0.96	0.74	0.59	0.44
340 HB	0.92	0.71	0.57	0.43
360 HB	0.88	0.68	0.54	0.41
375 HB	0.85	0.65	0.52	0.39

**D** Find blue table (correction for steels – P)  
 Tabla azul (corrección para aceros – P)  
 À partir de la table bleue (correction pour aciers – P)

**D1** Find subgroup P2 (medium-carbon steel)  
 Subgrupo P2 (acero medio en carbono)  
 Trouver le sous-groupe P2 (Acier faiblement allié)

**D2** Find required hardness (240 HB)  
 Dureza (240 HB)  
 Trouver la dureté matière appropriée (240 HB)

**D3** Result = correction coefficient for machined material of required hardness  
 (0,86  $k_{v_{HB}}$ )  
 Resultado = coeficiente de corrección para la dureza del material mecanizado  
 (0,86  $k_{v_{HB}}$ )  
 Résultat = coefficient de correction de dureté pour la matière usinée  
 (0,86  $k_{v_{HB}}$ )

$$v_c = v_{30} \cdot k_{v_T} \cdot k_{v_X} \cdot (kvN) \cdot k_{v_{HB}} \quad v_c = 250 \times 1.13 \times (1.00) \times 1.05 \times 0.86 = 255$$

**!** Cutting speed determined in this way is the initial value (default) defining the basic cutting speed for a given operation. Variance in machinability of the workpiece material may require adjustment of the cutting speed to provide economical durability of the cutting edge.

**!** La velocidad de corte determinada de esta forma es un valor inicial, definiendo la velocidad de corte básica para una operación dada. La variación en la maquinabilidad del material puede ser la principal causa de la necesidad de ajustar la velocidad de corte en caso de que necesitemos establecer una duración económica del filo de corte con relativa precisión.

**!** La vitesse de coupe déterminée de cette manière est la valeur initiale (par défaut) définissant la vitesse de coupe de base pour une opération donnée. La variation de l'usinabilité du matériau usiné peut être une cause principale dans la nécessité d'ajuster la vitesse de coupe au cas où nous devons adhérer de manière relativement précise à la durée de vie économique de l'arête de coupe.

<b>P</b>				
CORRECTION / CORRECCIÓN / CORRECTION $v_c$				
Subgroup / Subgrupo / Sous-groupe	P1	P2	P3	P4
Workpiece hardness factor / Factor de dureza / Facteur de dureté de la pièce usinée				
Hardness / Dureza / Dureté	$k_{v_{HBP1}}$	$k_{v_{HBP2}}$	$k_{v_{HBP3}}$	$k_{v_{HBP4}}$
120 HB	1.53	1.18	.94	.71
140 HB	1.46	1.12	.90	.67
160 HB	1.37	1.05	.84	.63
180 HB	1.30	1.00	.80	.60
200 HB	1.24	.95	.76	.57
220 HB	1.17	.90	.72	.54
240 HB	1.12	.86	.69	.52
260 HB	1.07	.82	.66	.49
280 HB	1.04	.80	.64	.48
300 HB	1.00	.77	.62	.46
320 HB	.96	.74	.59	.44
340 HB	.92	.71	.57	.43
360 HB	.88	.68	.54	.41
375 HB	.85	.65	.52	.39

<b>M</b>				
CORRECTION / CORRECCIÓN / CORRECTION $v_c$				
Subgroup / Subgrupo / Sous-groupe	M1	M2	M3	M4
Workpiece hardness factor / Factor de dureza / Facteur de dureté de la pièce usinée				
Hardness / Dureza / Dureté	$k_{v_{HBP1}}$	$k_{v_{HBP2}}$	$k_{v_{HBP3}}$	$k_{v_{HBP4}}$
120 HB	1.35	1.31	1.24	1.15
140 HB	1.28	1.24	1.18	1.10
160 HB	1.22	1.18	1.12	1.04
180 HB	1.14	1.11	1.05	.98
200 HB	1.09	1.06	1.00	.93
220 HB	1.03	1.00	.95	.88
240 HB	.98	.95	.90	.84
260 HB	.93	.91	.86	.80
280 HB	.89	.87	.82	.76
300 HB	.87	.84	.80	.74
320 HB	.84	.81	.77	.72
340 HB	.80	.78	.74	.69
360 HB	.77	.75	.71	.66
375 HB	.74	.72	.68	.63

<b>S</b>				
CORRECTION / CORRECCIÓN / CORRECTION $v_c$				
Subgroup / Subgrupo / Sous-groupe	S1	S2	S3	S4
Workpiece hardness factor / Factor de dureza / Facteur de dureté de la pièce usinée				
Hardness / Dureza / Dureté	$k_{v_{HBP1}}$	$k_{v_{HBP2}}$	$k_{v_{HBP3}}$	$k_{v_{HBP4}}$
120 HB	2.14	1.46	1.22	.92
140 HB	2.01	1.38	1.15	.93
160 HB	1.93	1.32	1.10	.83
180 HB	1.89	1.30	1.08	.81
200 HB	1.84	1.26	1.05	.79
220 HB	1.80	1.24	1.03	.77
240 HB	1.75	1.20	1.00	.75
260 HB	1.70	1.16	.97	.73
280 HB	1.61	1.10	.92	.69
300 HB	1.54	1.06	.88	.66
320 HB	1.47	1.01	.84	.63
340 HB	1.40	.96	.80	.60
360 HB	1.37	.94	.78	.59
375 HB	1.30	.89	.74	.56

<b>H</b>				
CORRECTION / CORRECCIÓN / CORRECTION $v_c$				
Subgroup / Subgrupo / Sous-groupe	H1	H2	H3	H4
Workpiece hardness factor / Factor de dureza / Facteur de dureté de la pièce usinée				
Hardness / Dureza / Dureté	$k_{v_{HBP1}}$	$k_{v_{HBP2}}$	$k_{v_{HBP3}}$	$k_{v_{HBP4}}$
380 HB (40.8 HRC)	1.84	1.76	1.60	1.52
400 HB (42.7 HRC)	1.73	1.65	1.50	1.43
420 HB (44.6 HRC)	1.61	1.54	1.40	1.33
440 HB (46.5 HRC)	1.50	1.43	1.30	1.24
460 HB (48.1 HRC)	1.38	1.32	1.20	1.14
500 HB (50.8 HRC)	1.15	1.10	1.00	.95
520 HB (52.0 HRC)	1.09	1.05	.95	.90
540 HB (53.5 HRC)	1.04	.99	.90	.96
560 HB (54.7 HRC)	.98	.94	.85	.81
580 HB (55.7 HRC)	.92	.88	.80	.76
600 HB (56.8 HRC)	.86	.93	.75	.71
620 HB (57.9 HRC)	.81	.77	.70	.67
640 HB (59.0 HRC)	.75	.72	.65	.62
>640 HB (>59.0 HRC)	.69	.66	.60	.57

Table 1  
Tabla 1  
Tableau 1

CORRECTION TABLES FOR CUTTING SPEED  
TABLAS DE CORRECCIÓN PARA LA VELOCIDAD DE CORTE  
TABLES DE CORRECTION DE VITESSE DE COUPE

<b>K</b>				
CORRECTION / CORRECCIÓN / CORRECTION $v_c$				
Subgroup / Subgrupo Sous-groupe	K1	K2	K3	K4
Workpiece hardness factor / Factor de dureza / Facteur de dureté de la pièce usinée				
Hardness / Dureza / Dureté	$k_{V_{HBP1}}$	$k_{V_{HBP2}}$	$k_{V_{HBP3}}$	$k_{V_{HBP4}}$
120 HB	1.60	1.52	1.44	1.36
140 HB	1.45	1.38	1.31	1.23
160 HB	1.35	1.28	1.22	1.15
180 HB	1.25	1.19	1.13	1.06
200 HB	1.10	1.05	.99	0.94
220 HB	1.00	.95	.90	0.85
240 HB	.90	.86	.81	0.77
260 HB	.80	.76	.72	0.68
280 HB	.70	.67	.63	0.60
300 HB	.65	.62	.59	0.55
320 HB	.60	.57	.54	0.51
340 HB	.55	.52	.50	0.47
360 HB	.50	.48	.45	0.43
375 HB	.40	.38	.36	0.34

Correction for durability (general machining) Corrección para duración (mecanizado general) Correction de la durée de vie (usinage général)	
	$k_{VT}$
15	1.23
20	1.13
30	1.00
45	.89
60	.81
90	.72
Correction for durability (heavy roughing) Corrección para duración (desbaste pesado) Durée de vie (ébauche lourde)	
30	1.23
60	1.00
90	.89
120	.81

Speed factor $k_{vx}$ / Factor de velocidad $k_{vx}$ / Facteur de vitesse $k_{vx}$	
Forged and cast piece skin / Corteza de forja o de fundición Surface de pièce forgée et coulée	.70 – .90
Good machine conditions / Buen estado de la máquina Bonnes conditions machine	1.05 – 1.20
Unstable machine conditions / Mal estado de la máquina Mauvaises conditions machine	.85 – .95

<b>N</b>		
CORRECTION / CORRECCIÓN / CORRECTION $v_c$		
Group / Grupo / Groupe	N	
Workpiece hardness factor / Factor de dureza / Facteur de dureté de la pièce usinée		
Alloy type / Tipo aleación / Type d'alliage	$k_{Vx}$	Subgroup Subgrupo Sous-groupe
Electrotechnical aluminium Aluminio electrotécnico Aluminium électro-technique	2.00	<b>N1</b>
Al alloys formed, unhardened HB 60 Aleaciones de aluminio sin endurecer HB 60 Alliage d'Aluminium formé, non durci HB 60	1.50	
Al alloys formed, hardened HB 100 Aleaciones de aluminio endurecidas HB 100 Alliage d'Aluminium formé, durci HB 100	1.00	
Al alloys cast, unhardened HB75 Aleaciones de aluminio fundidas, sin endurecer HB 75 Alliage d'Aluminium coulé, non durci HB 75	.90	<b>N2</b>
Al alloys cast, hardened HB90 Aleaciones de aluminio fundidas, endurecidas HB 90 Alliage d'Aluminium coulé, durci HB 90	.65	
Al alloys cast, unhardened HB 130 >12% Si Aleaciones de aluminio fundidas, sin endurecer HB 130 >12 % Si Alliage d'Aluminium coulé, non durci HB 130 >12 % Si	1.0 PCD/0.20	
Highly machinable alloys (>1 % Pb) Aleaciones altamente mecanizables (>1 % Pb) Alliages hautement usinables (>1 % Pb)	.90	<b>N3</b>
Brass and lead bronze (<1 % Pb) Latón y bronce al plomo (<1 % Pb) Cuivre et laitón (<1 % Pb)	.75	
Other brass HB <90 Latón HB <90 Autres alliages de Laiton HB<90	.60	
Other brass HB >90 Latón HB >90 Autres alliages de Laiton HB >90	.54	<b>N4</b>
Bronze electrolytic Cu Bronce electrolítico, Cu Bronze électrolytique Cu	.40	
Hard and very hard bronze Bronce duro y muy duro Bronze dur et très dur	.6 PCD/0.20	

Table 3  
Tabla 3  
Tableau 3

GEOMETRY OF CUTTING INSERTS  
GEOMETRÍA DE PLAQUITAS DE CORTE  
GÉOMÉTRIE DE PLAQUETTES


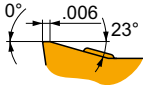
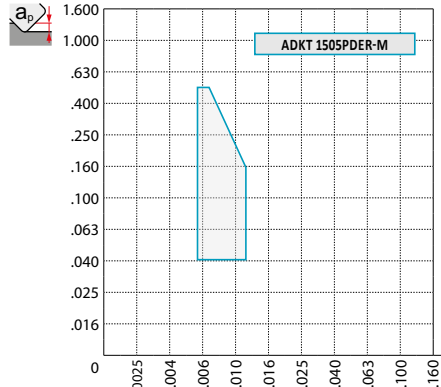







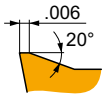
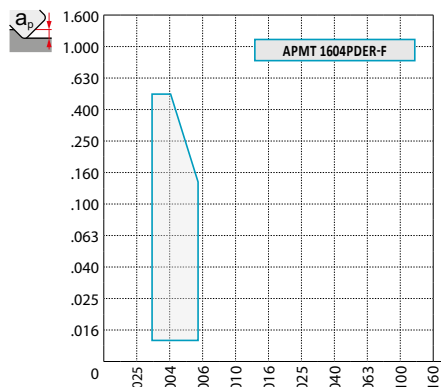







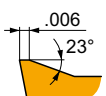
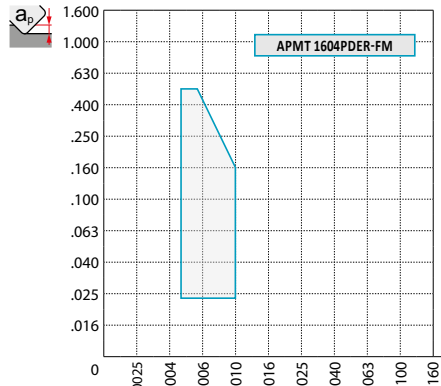







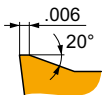
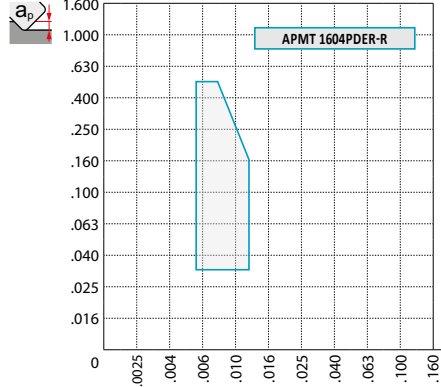






<p><b>ADKT 15</b></p>  	 <p>ADKT 1505PDER-M</p>	<table border="1"> <thead> <tr> <th>P</th> <th>M</th> <th>K</th> <th>N</th> <th>S</th> <th>H</th> </tr> </thead> <tbody> <tr> <td>■</td> <td>■</td> <td>■</td> <td>□</td> <td>■</td> <td>□</td> </tr> <tr> <td><math>f</math></td> <td colspan="5">.006 – .012</td> </tr> <tr> <td><math>a_p</math></td> <td colspan="5">.039 – .512</td> </tr> <tr> <td colspan="6" style="text-align: center;">  </td> </tr> <tr> <td colspan="6" style="text-align: center;">  </td> </tr> <tr> <td><b>?</b></td> <td colspan="5">ADKT 1505PDER-M</td> </tr> </tbody> </table>	P	M	K	N	S	H	■	■	■	□	■	□	$f$	.006 – .012					$a_p$	.039 – .512																	<b>?</b>	ADKT 1505PDER-M				
P	M	K	N	S	H																																							
■	■	■	□	■	□																																							
$f$	.006 – .012																																											
$a_p$	.039 – .512																																											
																																												
																																												
<b>?</b>	ADKT 1505PDER-M																																											
<p><b>APMT 16-F</b></p>  	 <p>APMT 1604PDER-F</p>	<table border="1"> <thead> <tr> <th>P</th> <th>M</th> <th>K</th> <th>N</th> <th>S</th> <th>H</th> </tr> </thead> <tbody> <tr> <td>■</td> <td>■</td> <td>■</td> <td>□</td> <td>■</td> <td>□</td> </tr> <tr> <td><math>f</math></td> <td colspan="5">.002 – .005</td> </tr> <tr> <td><math>a_p</math></td> <td colspan="5">.012 – .512</td> </tr> <tr> <td colspan="6" style="text-align: center;">  </td> </tr> <tr> <td colspan="6" style="text-align: center;">  </td> </tr> <tr> <td><b>?</b></td> <td colspan="5">APMT 1604PDER-F</td> </tr> </tbody> </table>	P	M	K	N	S	H	■	■	■	□	■	□	$f$	.002 – .005					$a_p$	.012 – .512																	<b>?</b>	APMT 1604PDER-F				
P	M	K	N	S	H																																							
■	■	■	□	■	□																																							
$f$	.002 – .005																																											
$a_p$	.012 – .512																																											
																																												
																																												
<b>?</b>	APMT 1604PDER-F																																											
<p><b>APMT 16-FM</b></p>  	 <p>APMT 1604PDER-FM</p>	<table border="1"> <thead> <tr> <th>P</th> <th>M</th> <th>K</th> <th>N</th> <th>S</th> <th>H</th> </tr> </thead> <tbody> <tr> <td>■</td> <td>■</td> <td>■</td> <td>□</td> <td>□</td> <td>□</td> </tr> <tr> <td><math>f</math></td> <td colspan="5">.005 – .010</td> </tr> <tr> <td><math>a_p</math></td> <td colspan="5">.024 – .512</td> </tr> <tr> <td colspan="6" style="text-align: center;">  </td> </tr> <tr> <td colspan="6" style="text-align: center;">  </td> </tr> <tr> <td><b>?</b></td> <td colspan="5">APMT 1604PDER-FM</td> </tr> </tbody> </table>	P	M	K	N	S	H	■	■	■	□	□	□	$f$	.005 – .010					$a_p$	.024 – .512																	<b>?</b>	APMT 1604PDER-FM				
P	M	K	N	S	H																																							
■	■	■	□	□	□																																							
$f$	.005 – .010																																											
$a_p$	.024 – .512																																											
																																												
																																												
<b>?</b>	APMT 1604PDER-FM																																											
<p><b>APMT 16 ER-R</b></p>  	 <p>APMT 1604PDER-R</p>	<table border="1"> <thead> <tr> <th>P</th> <th>M</th> <th>K</th> <th>N</th> <th>S</th> <th>H</th> </tr> </thead> <tbody> <tr> <td>■</td> <td>□</td> <td>■</td> <td>□</td> <td>□</td> <td>□</td> </tr> <tr> <td><math>f</math></td> <td colspan="5">.006 – .012</td> </tr> <tr> <td><math>a_p</math></td> <td colspan="5">.031 – .512</td> </tr> <tr> <td colspan="6" style="text-align: center;">  </td> </tr> <tr> <td colspan="6" style="text-align: center;">  </td> </tr> <tr> <td><b>?</b></td> <td colspan="5">APMT 1604PDER-R</td> </tr> </tbody> </table>	P	M	K	N	S	H	■	□	■	□	□	□	$f$	.006 – .012					$a_p$	.031 – .512																	<b>?</b>	APMT 1604PDER-R				
P	M	K	N	S	H																																							
■	□	■	□	□	□																																							
$f$	.006 – .012																																											
$a_p$	.031 – .512																																											
																																												
																																												
<b>?</b>	APMT 1604PDER-R																																											

Table 3  
Tabla 3  
Tableau 3

GEOMETRY OF CUTTING INSERTS  
GEOMETRÍA DE PLAQUITAS DE CORTE  
GÉOMÉTRIE DE PLAQUETTES



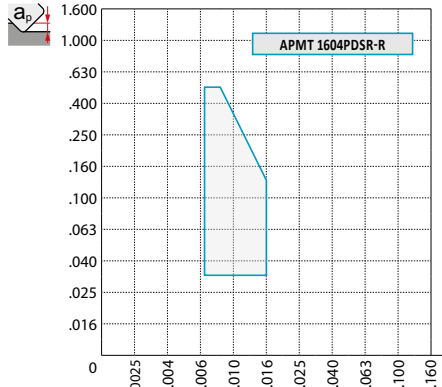






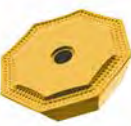
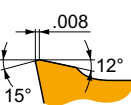
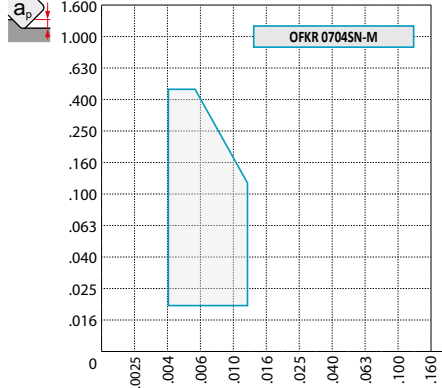







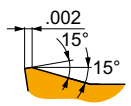
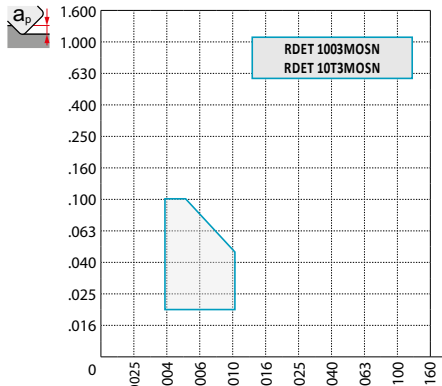







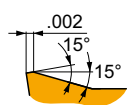
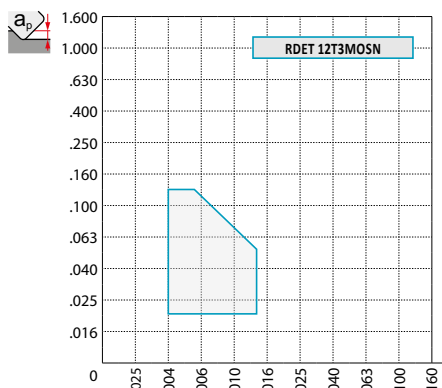






<p style="writing-mode: vertical-rl; transform: rotate(180deg);">APMT 16 SR-R</p>	  	 <p style="text-align: center;">APMT 1604PDSR-R</p>	<table border="1"> <thead> <tr> <th>P</th> <th>M</th> <th>K</th> <th>N</th> <th>S</th> <th>H</th> </tr> </thead> <tbody> <tr> <td><input checked="" type="checkbox"/></td> <td><input type="checkbox"/></td> <td><input checked="" type="checkbox"/></td> <td><input type="checkbox"/></td> <td><input type="checkbox"/></td> <td><input type="checkbox"/></td> </tr> <tr> <td></td> <td colspan="5">.007 – .016</td> </tr> <tr> <td></td> <td colspan="5">.031 – .512</td> </tr> <tr> <td colspan="6" style="text-align: center;">  </td> </tr> <tr> <td colspan="6" style="text-align: center;">  </td> </tr> <tr> <td colspan="6" style="text-align: center;">  APMT 1604PDSR-R         </td> </tr> </tbody> </table>	P	M	K	N	S	H	<input checked="" type="checkbox"/>	<input type="checkbox"/>	<input checked="" type="checkbox"/>	<input type="checkbox"/>	<input type="checkbox"/>	<input type="checkbox"/>		.007 – .016						.031 – .512																	APMT 1604PDSR-R					
P	M	K	N	S	H																																								
<input checked="" type="checkbox"/>	<input type="checkbox"/>	<input checked="" type="checkbox"/>	<input type="checkbox"/>	<input type="checkbox"/>	<input type="checkbox"/>																																								
	.007 – .016																																												
	.031 – .512																																												
																																													
																																													
APMT 1604PDSR-R																																													
<p style="writing-mode: vertical-rl; transform: rotate(180deg);">OFKR 07-M</p>	  	 <p style="text-align: center;">OFKR 0704SN-M</p>	<table border="1"> <thead> <tr> <th>P</th> <th>M</th> <th>K</th> <th>N</th> <th>S</th> <th>H</th> </tr> </thead> <tbody> <tr> <td><input checked="" type="checkbox"/></td> <td><input checked="" type="checkbox"/></td> <td><input checked="" type="checkbox"/></td> <td><input type="checkbox"/></td> <td><input type="checkbox"/></td> <td><input type="checkbox"/></td> </tr> <tr> <td></td> <td colspan="5">.004 – .012</td> </tr> <tr> <td></td> <td colspan="5">.020 – .472</td> </tr> <tr> <td colspan="6" style="text-align: center;">  </td> </tr> <tr> <td colspan="6" style="text-align: center;">  </td> </tr> <tr> <td colspan="6" style="text-align: center;">  OFKR 0704SN-M         </td> </tr> </tbody> </table>	P	M	K	N	S	H	<input checked="" type="checkbox"/>	<input checked="" type="checkbox"/>	<input checked="" type="checkbox"/>	<input type="checkbox"/>	<input type="checkbox"/>	<input type="checkbox"/>		.004 – .012						.020 – .472																	OFKR 0704SN-M					
P	M	K	N	S	H																																								
<input checked="" type="checkbox"/>	<input checked="" type="checkbox"/>	<input checked="" type="checkbox"/>	<input type="checkbox"/>	<input type="checkbox"/>	<input type="checkbox"/>																																								
	.004 – .012																																												
	.020 – .472																																												
																																													
																																													
OFKR 0704SN-M																																													
<p style="writing-mode: vertical-rl; transform: rotate(180deg);">RDET 10</p>	  	 <p style="text-align: center;">RDET 1003MOSN RDET 10T3MOSN</p>	<table border="1"> <thead> <tr> <th>P</th> <th>M</th> <th>K</th> <th>N</th> <th>S</th> <th>H</th> </tr> </thead> <tbody> <tr> <td><input checked="" type="checkbox"/></td> <td><input checked="" type="checkbox"/></td> <td><input checked="" type="checkbox"/></td> <td><input type="checkbox"/></td> <td><input checked="" type="checkbox"/></td> <td><input type="checkbox"/></td> </tr> <tr> <td></td> <td colspan="5">.004 – .014</td> </tr> <tr> <td></td> <td colspan="5">.020 – .098</td> </tr> <tr> <td colspan="6" style="text-align: center;">  </td> </tr> <tr> <td colspan="6" style="text-align: center;">  </td> </tr> <tr> <td colspan="6" style="text-align: center;">  RDET 1003MOSN, RDET 10T3MOSN         </td> </tr> </tbody> </table>	P	M	K	N	S	H	<input checked="" type="checkbox"/>	<input checked="" type="checkbox"/>	<input checked="" type="checkbox"/>	<input type="checkbox"/>	<input checked="" type="checkbox"/>	<input type="checkbox"/>		.004 – .014						.020 – .098																	RDET 1003MOSN, RDET 10T3MOSN					
P	M	K	N	S	H																																								
<input checked="" type="checkbox"/>	<input checked="" type="checkbox"/>	<input checked="" type="checkbox"/>	<input type="checkbox"/>	<input checked="" type="checkbox"/>	<input type="checkbox"/>																																								
	.004 – .014																																												
	.020 – .098																																												
																																													
																																													
RDET 1003MOSN, RDET 10T3MOSN																																													
<p style="writing-mode: vertical-rl; transform: rotate(180deg);">RDET 12</p>	  	 <p style="text-align: center;">RDET 12T3MOSN</p>	<table border="1"> <thead> <tr> <th>P</th> <th>M</th> <th>K</th> <th>N</th> <th>S</th> <th>H</th> </tr> </thead> <tbody> <tr> <td><input checked="" type="checkbox"/></td> <td><input checked="" type="checkbox"/></td> <td><input checked="" type="checkbox"/></td> <td><input type="checkbox"/></td> <td><input checked="" type="checkbox"/></td> <td><input type="checkbox"/></td> </tr> <tr> <td></td> <td colspan="5">.004 – .014</td> </tr> <tr> <td></td> <td colspan="5">.020 – .118</td> </tr> <tr> <td colspan="6" style="text-align: center;">  </td> </tr> <tr> <td colspan="6" style="text-align: center;">  </td> </tr> <tr> <td colspan="6" style="text-align: center;">  RDET 12T3MOSN         </td> </tr> </tbody> </table>	P	M	K	N	S	H	<input checked="" type="checkbox"/>	<input checked="" type="checkbox"/>	<input checked="" type="checkbox"/>	<input type="checkbox"/>	<input checked="" type="checkbox"/>	<input type="checkbox"/>		.004 – .014						.020 – .118																	RDET 12T3MOSN					
P	M	K	N	S	H																																								
<input checked="" type="checkbox"/>	<input checked="" type="checkbox"/>	<input checked="" type="checkbox"/>	<input type="checkbox"/>	<input checked="" type="checkbox"/>	<input type="checkbox"/>																																								
	.004 – .014																																												
	.020 – .118																																												
																																													
																																													
RDET 12T3MOSN																																													

Table 3  
Tabla 3  
Tableau 3

GEOMETRY OF CUTTING INSERTS  
GEOMETRÍA DE PLAQUITAS DE CORTE  
GÉOMÉTRIE DE PLAQUETTES

<p><b>RDEW 10</b></p>		<p>RDEW 1003MOSN RDEW 10T3MOSN</p>	<table border="1"> <thead> <tr> <th>P</th> <th>M</th> <th>K</th> <th>N</th> <th>S</th> <th>H</th> </tr> </thead> <tbody> <tr> <td><input checked="" type="checkbox"/></td> <td><input type="checkbox"/></td> <td><input checked="" type="checkbox"/></td> <td><input type="checkbox"/></td> <td><input type="checkbox"/></td> <td><input checked="" type="checkbox"/></td> </tr> <tr> <td><math>f</math></td> <td colspan="5">.004 – .014</td> </tr> <tr> <td><math>a_p</math></td> <td colspan="5">.020 – .098</td> </tr> <tr> <td colspan="6" style="text-align: center;"> </td> </tr> <tr> <td colspan="6" style="text-align: center;"> </td> </tr> <tr> <td><b>?</b></td> <td colspan="5">RDEW 1003MOSN, RDEW 10T3MOSN</td> </tr> </tbody> </table>	P	M	K	N	S	H	<input checked="" type="checkbox"/>	<input type="checkbox"/>	<input checked="" type="checkbox"/>	<input type="checkbox"/>	<input type="checkbox"/>	<input checked="" type="checkbox"/>	$f$	.004 – .014					$a_p$	.020 – .098																	<b>?</b>	RDEW 1003MOSN, RDEW 10T3MOSN				
P	M	K	N	S	H																																								
<input checked="" type="checkbox"/>	<input type="checkbox"/>	<input checked="" type="checkbox"/>	<input type="checkbox"/>	<input type="checkbox"/>	<input checked="" type="checkbox"/>																																								
$f$	.004 – .014																																												
$a_p$	.020 – .098																																												
<b>?</b>	RDEW 1003MOSN, RDEW 10T3MOSN																																												
<p><b>RDEW 12</b></p>		<p>RDEW 12T3MOSN</p>	<table border="1"> <thead> <tr> <th>P</th> <th>M</th> <th>K</th> <th>N</th> <th>S</th> <th>H</th> </tr> </thead> <tbody> <tr> <td><input checked="" type="checkbox"/></td> <td><input type="checkbox"/></td> <td><input checked="" type="checkbox"/></td> <td><input type="checkbox"/></td> <td><input type="checkbox"/></td> <td><input checked="" type="checkbox"/></td> </tr> <tr> <td><math>f</math></td> <td colspan="5">.005 – .016</td> </tr> <tr> <td><math>a_p</math></td> <td colspan="5">.020 – .118</td> </tr> <tr> <td colspan="6" style="text-align: center;"> </td> </tr> <tr> <td colspan="6" style="text-align: center;"> </td> </tr> <tr> <td><b>?</b></td> <td colspan="5">RDEW 12T3MOSN</td> </tr> </tbody> </table>	P	M	K	N	S	H	<input checked="" type="checkbox"/>	<input type="checkbox"/>	<input checked="" type="checkbox"/>	<input type="checkbox"/>	<input type="checkbox"/>	<input checked="" type="checkbox"/>	$f$	.005 – .016					$a_p$	.020 – .118																	<b>?</b>	RDEW 12T3MOSN				
P	M	K	N	S	H																																								
<input checked="" type="checkbox"/>	<input type="checkbox"/>	<input checked="" type="checkbox"/>	<input type="checkbox"/>	<input type="checkbox"/>	<input checked="" type="checkbox"/>																																								
$f$	.005 – .016																																												
$a_p$	.020 – .118																																												
<b>?</b>	RDEW 12T3MOSN																																												
<p><b>RDEX 12</b></p>		<p>RDEX 1204MOSN-12</p>	<table border="1"> <thead> <tr> <th>P</th> <th>M</th> <th>K</th> <th>N</th> <th>S</th> <th>H</th> </tr> </thead> <tbody> <tr> <td><input checked="" type="checkbox"/></td> <td><input checked="" type="checkbox"/></td> <td><input checked="" type="checkbox"/></td> <td><input type="checkbox"/></td> <td><input checked="" type="checkbox"/></td> <td><input type="checkbox"/></td> </tr> <tr> <td><math>f</math></td> <td colspan="5">.005 – .016</td> </tr> <tr> <td><math>a_p</math></td> <td colspan="5">.020 – .118</td> </tr> <tr> <td colspan="6" style="text-align: center;"> </td> </tr> <tr> <td colspan="6" style="text-align: center;"> </td> </tr> <tr> <td><b>?</b></td> <td colspan="5">RDEX 1604MOSN-12</td> </tr> </tbody> </table>	P	M	K	N	S	H	<input checked="" type="checkbox"/>	<input checked="" type="checkbox"/>	<input checked="" type="checkbox"/>	<input type="checkbox"/>	<input checked="" type="checkbox"/>	<input type="checkbox"/>	$f$	.005 – .016					$a_p$	.020 – .118																	<b>?</b>	RDEX 1604MOSN-12				
P	M	K	N	S	H																																								
<input checked="" type="checkbox"/>	<input checked="" type="checkbox"/>	<input checked="" type="checkbox"/>	<input type="checkbox"/>	<input checked="" type="checkbox"/>	<input type="checkbox"/>																																								
$f$	.005 – .016																																												
$a_p$	.020 – .118																																												
<b>?</b>	RDEX 1604MOSN-12																																												
<p><b>RDHX 20</b></p>		<p>RDHX 2006MOT</p>	<table border="1"> <thead> <tr> <th>P</th> <th>M</th> <th>K</th> <th>N</th> <th>S</th> <th>H</th> </tr> </thead> <tbody> <tr> <td><input checked="" type="checkbox"/></td> <td><input type="checkbox"/></td> <td><input checked="" type="checkbox"/></td> <td><input type="checkbox"/></td> <td><input type="checkbox"/></td> <td><input checked="" type="checkbox"/></td> </tr> <tr> <td><math>f</math></td> <td colspan="5">.008 – .024</td> </tr> <tr> <td><math>a_p</math></td> <td colspan="5">.039 – .197</td> </tr> <tr> <td colspan="6" style="text-align: center;"> </td> </tr> <tr> <td colspan="6" style="text-align: center;"> </td> </tr> <tr> <td><b>?</b></td> <td colspan="5">RDHX 2006MOT</td> </tr> </tbody> </table>	P	M	K	N	S	H	<input checked="" type="checkbox"/>	<input type="checkbox"/>	<input checked="" type="checkbox"/>	<input type="checkbox"/>	<input type="checkbox"/>	<input checked="" type="checkbox"/>	$f$	.008 – .024					$a_p$	.039 – .197																	<b>?</b>	RDHX 2006MOT				
P	M	K	N	S	H																																								
<input checked="" type="checkbox"/>	<input type="checkbox"/>	<input checked="" type="checkbox"/>	<input type="checkbox"/>	<input type="checkbox"/>	<input checked="" type="checkbox"/>																																								
$f$	.008 – .024																																												
$a_p$	.039 – .197																																												
<b>?</b>	RDHX 2006MOT																																												



Table 3  
 Tabla 3  
 Tableau 3

GEOMETRY OF CUTTING INSERTS  
 GEOMETRÍA DE PLAQUITAS DE CORTE  
 GÉOMÉTRIE DE PLAQUETTES


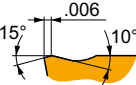
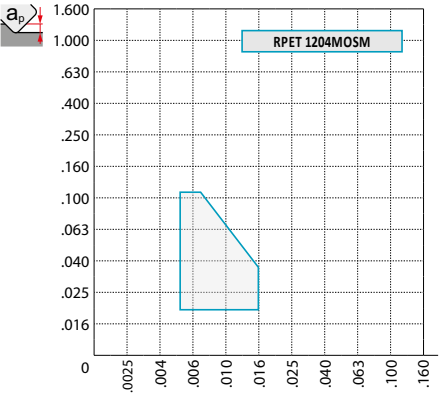







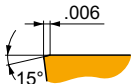
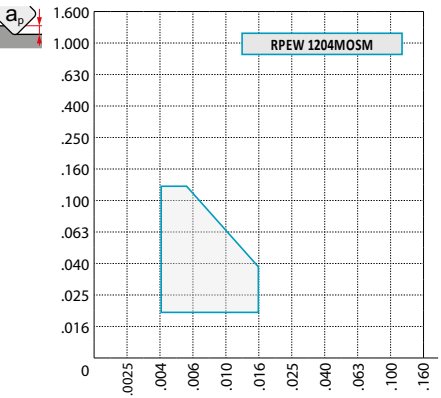







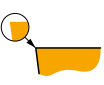
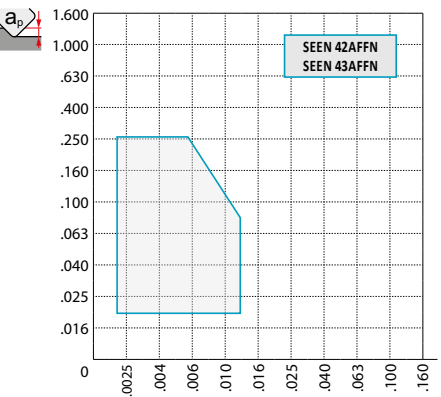







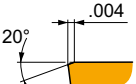
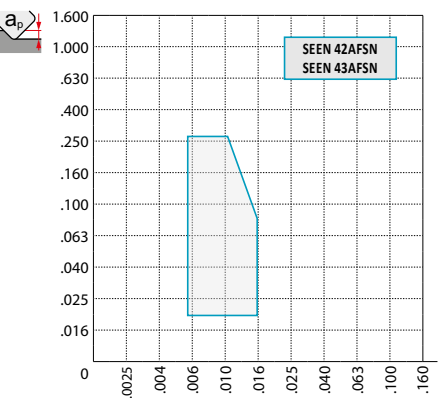






<p><b>RPET 12</b></p>  	 <p>RPET 1204MOSM</p>	<table border="1"> <thead> <tr> <th>P</th> <th>M</th> <th>K</th> <th>N</th> <th>S</th> <th>H</th> </tr> </thead> <tbody> <tr> <td><input checked="" type="checkbox"/></td> <td><input checked="" type="checkbox"/></td> <td><input checked="" type="checkbox"/></td> <td><input type="checkbox"/></td> <td><input checked="" type="checkbox"/></td> <td><input type="checkbox"/></td> </tr> <tr> <td><math>f</math></td> <td colspan="5">.005 – .016</td> </tr> <tr> <td><math>a_p</math></td> <td colspan="5">.020 – .118</td> </tr> <tr> <td colspan="6" style="text-align: center;">  </td> </tr> <tr> <td colspan="6" style="text-align: center;">  </td> </tr> <tr> <td><b>?</b></td> <td colspan="5">RPET 1204MOSN</td> </tr> </tbody> </table>	P	M	K	N	S	H	<input checked="" type="checkbox"/>	<input checked="" type="checkbox"/>	<input checked="" type="checkbox"/>	<input type="checkbox"/>	<input checked="" type="checkbox"/>	<input type="checkbox"/>	$f$	.005 – .016					$a_p$	.020 – .118																	<b>?</b>	RPET 1204MOSN				
P	M	K	N	S	H																																							
<input checked="" type="checkbox"/>	<input checked="" type="checkbox"/>	<input checked="" type="checkbox"/>	<input type="checkbox"/>	<input checked="" type="checkbox"/>	<input type="checkbox"/>																																							
$f$	.005 – .016																																											
$a_p$	.020 – .118																																											
																																												
																																												
<b>?</b>	RPET 1204MOSN																																											
<p><b>RPEW 12</b></p>  	 <p>RPEW 1204MOSM</p>	<table border="1"> <thead> <tr> <th>P</th> <th>M</th> <th>K</th> <th>N</th> <th>S</th> <th>H</th> </tr> </thead> <tbody> <tr> <td><input checked="" type="checkbox"/></td> <td><input type="checkbox"/></td> <td><input checked="" type="checkbox"/></td> <td><input type="checkbox"/></td> <td><input type="checkbox"/></td> <td><input checked="" type="checkbox"/></td> </tr> <tr> <td><math>f</math></td> <td colspan="5">.004 – .016</td> </tr> <tr> <td><math>a_p</math></td> <td colspan="5">.020 – .118</td> </tr> <tr> <td colspan="6" style="text-align: center;">  </td> </tr> <tr> <td colspan="6" style="text-align: center;">  </td> </tr> <tr> <td><b>?</b></td> <td colspan="5">RPEW 1204MOSM</td> </tr> </tbody> </table>	P	M	K	N	S	H	<input checked="" type="checkbox"/>	<input type="checkbox"/>	<input checked="" type="checkbox"/>	<input type="checkbox"/>	<input type="checkbox"/>	<input checked="" type="checkbox"/>	$f$	.004 – .016					$a_p$	.020 – .118																	<b>?</b>	RPEW 1204MOSM				
P	M	K	N	S	H																																							
<input checked="" type="checkbox"/>	<input type="checkbox"/>	<input checked="" type="checkbox"/>	<input type="checkbox"/>	<input type="checkbox"/>	<input checked="" type="checkbox"/>																																							
$f$	.004 – .016																																											
$a_p$	.020 – .118																																											
																																												
																																												
<b>?</b>	RPEW 1204MOSM																																											
<p><b>SEEN 12 FN</b></p>  	 <p>SEEN 42AFFN SEEN 43AFFN</p>	<table border="1"> <thead> <tr> <th>P</th> <th>M</th> <th>K</th> <th>N</th> <th>S</th> <th>H</th> </tr> </thead> <tbody> <tr> <td><input checked="" type="checkbox"/></td> <td><input checked="" type="checkbox"/></td> <td><input type="checkbox"/></td> <td><input type="checkbox"/></td> <td><input type="checkbox"/></td> <td><input type="checkbox"/></td> </tr> <tr> <td><math>f</math></td> <td colspan="5">.002 – .016</td> </tr> <tr> <td><math>a_p</math></td> <td colspan="5">.020 – .256</td> </tr> <tr> <td colspan="6" style="text-align: center;">  </td> </tr> <tr> <td colspan="6" style="text-align: center;">  </td> </tr> <tr> <td><b>?</b></td> <td colspan="5">SEEN 42AFFN, SEEN 43AFFN</td> </tr> </tbody> </table>	P	M	K	N	S	H	<input checked="" type="checkbox"/>	<input checked="" type="checkbox"/>	<input type="checkbox"/>	<input type="checkbox"/>	<input type="checkbox"/>	<input type="checkbox"/>	$f$	.002 – .016					$a_p$	.020 – .256																	<b>?</b>	SEEN 42AFFN, SEEN 43AFFN				
P	M	K	N	S	H																																							
<input checked="" type="checkbox"/>	<input checked="" type="checkbox"/>	<input type="checkbox"/>	<input type="checkbox"/>	<input type="checkbox"/>	<input type="checkbox"/>																																							
$f$	.002 – .016																																											
$a_p$	.020 – .256																																											
																																												
																																												
<b>?</b>	SEEN 42AFFN, SEEN 43AFFN																																											
<p><b>SEEN 12 SN</b></p>  	 <p>SEEN 42AFSN SEEN 43AFSN</p>	<table border="1"> <thead> <tr> <th>P</th> <th>M</th> <th>K</th> <th>N</th> <th>S</th> <th>H</th> </tr> </thead> <tbody> <tr> <td><input checked="" type="checkbox"/></td> <td><input type="checkbox"/></td> <td><input checked="" type="checkbox"/></td> <td><input type="checkbox"/></td> <td><input type="checkbox"/></td> <td><input checked="" type="checkbox"/></td> </tr> <tr> <td><math>f</math></td> <td colspan="5">.006 – .016</td> </tr> <tr> <td><math>a_p</math></td> <td colspan="5">.020 – .256</td> </tr> <tr> <td colspan="6" style="text-align: center;">  </td> </tr> <tr> <td colspan="6" style="text-align: center;">  </td> </tr> <tr> <td><b>?</b></td> <td colspan="5">SEEN 42AFSN, SEEN 43AFSN</td> </tr> </tbody> </table>	P	M	K	N	S	H	<input checked="" type="checkbox"/>	<input type="checkbox"/>	<input checked="" type="checkbox"/>	<input type="checkbox"/>	<input type="checkbox"/>	<input checked="" type="checkbox"/>	$f$	.006 – .016					$a_p$	.020 – .256																	<b>?</b>	SEEN 42AFSN, SEEN 43AFSN				
P	M	K	N	S	H																																							
<input checked="" type="checkbox"/>	<input type="checkbox"/>	<input checked="" type="checkbox"/>	<input type="checkbox"/>	<input type="checkbox"/>	<input checked="" type="checkbox"/>																																							
$f$	.006 – .016																																											
$a_p$	.020 – .256																																											
																																												
																																												
<b>?</b>	SEEN 42AFSN, SEEN 43AFSN																																											

Table 3  
Tabla 3  
Tableau 3

GEOMETRY OF CUTTING INSERTS  
GEOMETRÍA DE PLAQUITAS DE CORTE  
GÉOMÉTRIE DE PLAQUETTES


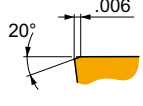
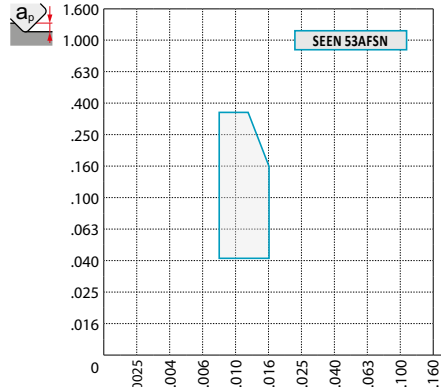







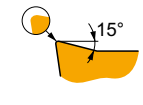
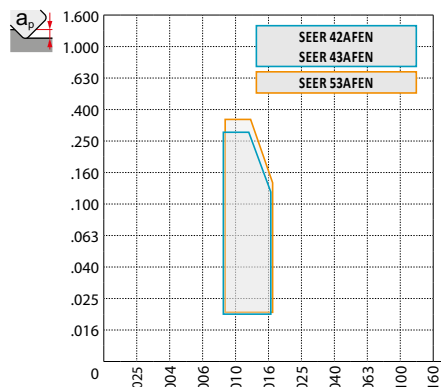







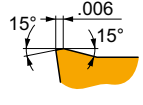
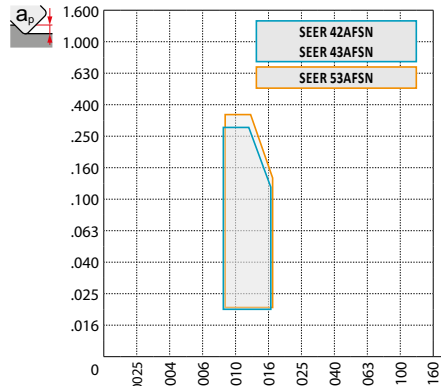







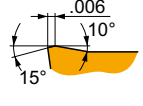
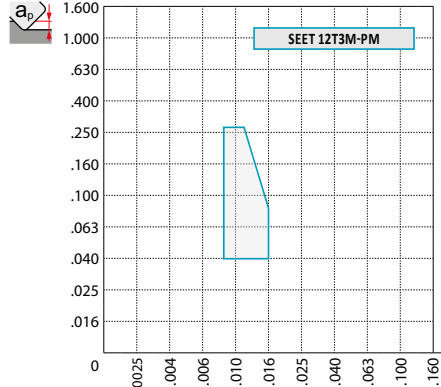






<p><b>SEEN 15 SN</b></p>  	 <p>SEEN 53AFSN</p>	<table border="1"> <thead> <tr> <th>P</th> <th>M</th> <th>K</th> <th>N</th> <th>S</th> <th>H</th> </tr> </thead> <tbody> <tr> <td><input checked="" type="checkbox"/></td> <td><input type="checkbox"/></td> <td><input checked="" type="checkbox"/></td> <td><input type="checkbox"/></td> <td><input type="checkbox"/></td> <td><input checked="" type="checkbox"/></td> </tr> <tr> <td><math>f</math></td> <td colspan="5">.008 – .016</td> </tr> <tr> <td><math>a_p</math></td> <td colspan="5">.039 – .354</td> </tr> <tr> <td colspan="6" style="text-align: center;">  </td> </tr> <tr> <td colspan="6" style="text-align: center;">  </td> </tr> <tr> <td><b>?</b></td> <td colspan="5">SEEN 53AFSN</td> </tr> </tbody> </table>	P	M	K	N	S	H	<input checked="" type="checkbox"/>	<input type="checkbox"/>	<input checked="" type="checkbox"/>	<input type="checkbox"/>	<input type="checkbox"/>	<input checked="" type="checkbox"/>	$f$	.008 – .016					$a_p$	.039 – .354																	<b>?</b>	SEEN 53AFSN				
P	M	K	N	S	H																																							
<input checked="" type="checkbox"/>	<input type="checkbox"/>	<input checked="" type="checkbox"/>	<input type="checkbox"/>	<input type="checkbox"/>	<input checked="" type="checkbox"/>																																							
$f$	.008 – .016																																											
$a_p$	.039 – .354																																											
																																												
																																												
<b>?</b>	SEEN 53AFSN																																											
<p><b>SEER EN</b></p>  	 <p>SEER 42AFEN SEER 43AFEN SEER 53AFEN</p>	<table border="1"> <thead> <tr> <th>P</th> <th>M</th> <th>K</th> <th>N</th> <th>S</th> <th>H</th> </tr> </thead> <tbody> <tr> <td><input checked="" type="checkbox"/></td> <td><input checked="" type="checkbox"/></td> <td><input checked="" type="checkbox"/></td> <td><input type="checkbox"/></td> <td><input checked="" type="checkbox"/></td> <td><input type="checkbox"/></td> </tr> <tr> <td><math>f</math></td> <td colspan="5">.008 – .016</td> </tr> <tr> <td><math>a_p</math></td> <td colspan="5">.020 – .256(.354)</td> </tr> <tr> <td colspan="6" style="text-align: center;">  </td> </tr> <tr> <td colspan="6" style="text-align: center;">  </td> </tr> <tr> <td><b>?</b></td> <td colspan="5">SEER 42AFEN, SEER 43AFEN, SEER 53AFEN</td> </tr> </tbody> </table>	P	M	K	N	S	H	<input checked="" type="checkbox"/>	<input checked="" type="checkbox"/>	<input checked="" type="checkbox"/>	<input type="checkbox"/>	<input checked="" type="checkbox"/>	<input type="checkbox"/>	$f$	.008 – .016					$a_p$	.020 – .256(.354)																	<b>?</b>	SEER 42AFEN, SEER 43AFEN, SEER 53AFEN				
P	M	K	N	S	H																																							
<input checked="" type="checkbox"/>	<input checked="" type="checkbox"/>	<input checked="" type="checkbox"/>	<input type="checkbox"/>	<input checked="" type="checkbox"/>	<input type="checkbox"/>																																							
$f$	.008 – .016																																											
$a_p$	.020 – .256(.354)																																											
																																												
																																												
<b>?</b>	SEER 42AFEN, SEER 43AFEN, SEER 53AFEN																																											
<p><b>SEER SN</b></p>  	 <p>SEER 42AFSN SEER 43AFSN SEER 53AFSN</p>	<table border="1"> <thead> <tr> <th>P</th> <th>M</th> <th>K</th> <th>N</th> <th>S</th> <th>H</th> </tr> </thead> <tbody> <tr> <td><input checked="" type="checkbox"/></td> <td><input checked="" type="checkbox"/></td> <td><input checked="" type="checkbox"/></td> <td><input type="checkbox"/></td> <td><input checked="" type="checkbox"/></td> <td><input type="checkbox"/></td> </tr> <tr> <td><math>f</math></td> <td colspan="5">.008 – .016</td> </tr> <tr> <td><math>a_p</math></td> <td colspan="5">.039 – .256(.354)</td> </tr> <tr> <td colspan="6" style="text-align: center;">  </td> </tr> <tr> <td colspan="6" style="text-align: center;">  </td> </tr> <tr> <td><b>?</b></td> <td colspan="5">SEER 42AFSN, SEER 43AFSN, SEER 53AFSN</td> </tr> </tbody> </table>	P	M	K	N	S	H	<input checked="" type="checkbox"/>	<input checked="" type="checkbox"/>	<input checked="" type="checkbox"/>	<input type="checkbox"/>	<input checked="" type="checkbox"/>	<input type="checkbox"/>	$f$	.008 – .016					$a_p$	.039 – .256(.354)																	<b>?</b>	SEER 42AFSN, SEER 43AFSN, SEER 53AFSN				
P	M	K	N	S	H																																							
<input checked="" type="checkbox"/>	<input checked="" type="checkbox"/>	<input checked="" type="checkbox"/>	<input type="checkbox"/>	<input checked="" type="checkbox"/>	<input type="checkbox"/>																																							
$f$	.008 – .016																																											
$a_p$	.039 – .256(.354)																																											
																																												
																																												
<b>?</b>	SEER 42AFSN, SEER 43AFSN, SEER 53AFSN																																											
<p><b>SEET 12-PM</b></p>  	 <p>SEET 12T3M-PM</p>	<table border="1"> <thead> <tr> <th>P</th> <th>M</th> <th>K</th> <th>N</th> <th>S</th> <th>H</th> </tr> </thead> <tbody> <tr> <td><input checked="" type="checkbox"/></td> <td><input checked="" type="checkbox"/></td> <td><input checked="" type="checkbox"/></td> <td><input type="checkbox"/></td> <td><input checked="" type="checkbox"/></td> <td><input type="checkbox"/></td> </tr> <tr> <td><math>f</math></td> <td colspan="5">.008 – .016</td> </tr> <tr> <td><math>a_p</math></td> <td colspan="5">.039 – .256</td> </tr> <tr> <td colspan="6" style="text-align: center;">  </td> </tr> <tr> <td colspan="6" style="text-align: center;">  </td> </tr> <tr> <td><b>?</b></td> <td colspan="5">SEET 12T3M-PM</td> </tr> </tbody> </table>	P	M	K	N	S	H	<input checked="" type="checkbox"/>	<input checked="" type="checkbox"/>	<input checked="" type="checkbox"/>	<input type="checkbox"/>	<input checked="" type="checkbox"/>	<input type="checkbox"/>	$f$	.008 – .016					$a_p$	.039 – .256																	<b>?</b>	SEET 12T3M-PM				
P	M	K	N	S	H																																							
<input checked="" type="checkbox"/>	<input checked="" type="checkbox"/>	<input checked="" type="checkbox"/>	<input type="checkbox"/>	<input checked="" type="checkbox"/>	<input type="checkbox"/>																																							
$f$	.008 – .016																																											
$a_p$	.039 – .256																																											
																																												
																																												
<b>?</b>	SEET 12T3M-PM																																											

Table 3  
 Tabla 3  
 Tableau 3

GEOMETRY OF CUTTING INSERTS  
 GEOMETRÍA DE PLAQUITAS DE CORTE  
 GÉOMÉTRIE DE PLAQUETTES


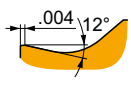
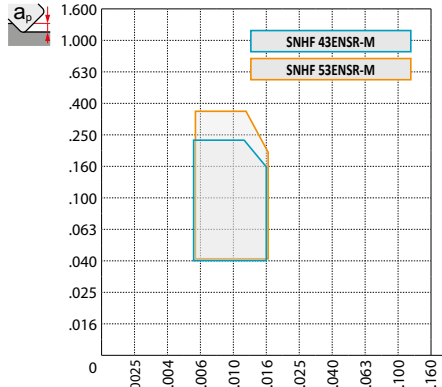



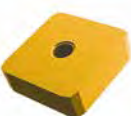

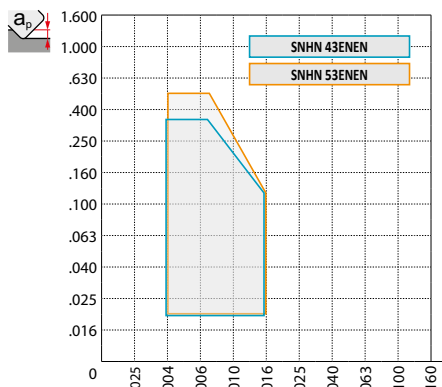





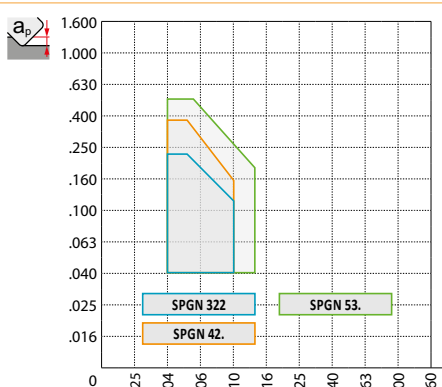





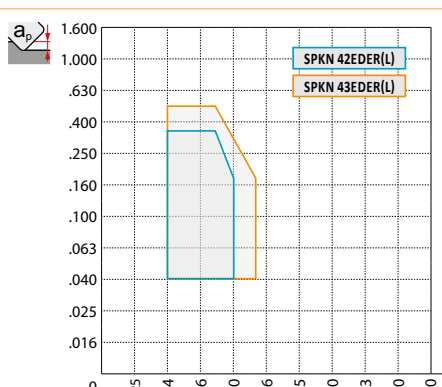



<p style="writing-mode: vertical-rl; transform: rotate(180deg);"><b>SNHF-M</b></p>  		<table border="1"> <thead> <tr> <th>P</th> <th>M</th> <th>K</th> <th>N</th> <th>S</th> <th>H</th> </tr> </thead> <tbody> <tr> <td>■</td> <td>■</td> <td>■</td> <td>■</td> <td>□</td> <td>■</td> </tr> <tr> <td><math>f</math></td> <td colspan="5">.006 – .016</td> </tr> <tr> <td><math>a_p</math></td> <td colspan="5">.039 – .236(.354)</td> </tr> <tr> <td></td> <td colspan="5"></td> </tr> <tr> <td><b>?</b></td> <td colspan="5">SNHF 43ENSR-M, SNHF 53ENSR-M</td> </tr> </tbody> </table>	P	M	K	N	S	H	■	■	■	■	□	■	$f$	.006 – .016					$a_p$	.039 – .236(.354)											<b>?</b>	SNHF 43ENSR-M, SNHF 53ENSR-M				
P	M	K	N	S	H																																	
■	■	■	■	□	■																																	
$f$	.006 – .016																																					
$a_p$	.039 – .236(.354)																																					
																																						
<b>?</b>	SNHF 43ENSR-M, SNHF 53ENSR-M																																					
<p style="writing-mode: vertical-rl; transform: rotate(180deg);"><b>SNHN</b></p>  		<table border="1"> <thead> <tr> <th>P</th> <th>M</th> <th>K</th> <th>N</th> <th>S</th> <th>H</th> </tr> </thead> <tbody> <tr> <td>■</td> <td>□</td> <td>■</td> <td>■</td> <td>■</td> <td>■</td> </tr> <tr> <td><math>f</math></td> <td colspan="5">.004 – .016</td> </tr> <tr> <td><math>a_p</math></td> <td colspan="5">.020 – .354 (.531)</td> </tr> <tr> <td></td> <td colspan="5"></td> </tr> <tr> <td><b>?</b></td> <td colspan="5">SNHN 43ENEN, SNHN 53ENEN</td> </tr> </tbody> </table>	P	M	K	N	S	H	■	□	■	■	■	■	$f$	.004 – .016					$a_p$	.020 – .354 (.531)											<b>?</b>	SNHN 43ENEN, SNHN 53ENEN				
P	M	K	N	S	H																																	
■	□	■	■	■	■																																	
$f$	.004 – .016																																					
$a_p$	.020 – .354 (.531)																																					
																																						
<b>?</b>	SNHN 43ENEN, SNHN 53ENEN																																					
<p style="writing-mode: vertical-rl; transform: rotate(180deg);"><b>SPGN</b></p>  		<table border="1"> <thead> <tr> <th>P</th> <th>M</th> <th>K</th> <th>N</th> <th>S</th> <th>H</th> </tr> </thead> <tbody> <tr> <td>■</td> <td>□</td> <td>■</td> <td>■</td> <td>■</td> <td>■</td> </tr> <tr> <td><math>f</math></td> <td colspan="5">.004 – .010 (.014)</td> </tr> <tr> <td><math>a_p</math></td> <td colspan="5">.039 – .531</td> </tr> <tr> <td></td> <td colspan="5"></td> </tr> <tr> <td><b>?</b></td> <td colspan="5">SPGN 322, SPGN 42., SPGN 53.</td> </tr> </tbody> </table>	P	M	K	N	S	H	■	□	■	■	■	■	$f$	.004 – .010 (.014)					$a_p$	.039 – .531											<b>?</b>	SPGN 322, SPGN 42., SPGN 53.				
P	M	K	N	S	H																																	
■	□	■	■	■	■																																	
$f$	.004 – .010 (.014)																																					
$a_p$	.039 – .531																																					
																																						
<b>?</b>	SPGN 322, SPGN 42., SPGN 53.																																					
<p style="writing-mode: vertical-rl; transform: rotate(180deg);"><b>SPKN ER(L)</b></p>  		<table border="1"> <thead> <tr> <th>P</th> <th>M</th> <th>K</th> <th>N</th> <th>S</th> <th>H</th> </tr> </thead> <tbody> <tr> <td>■</td> <td>□</td> <td>■</td> <td>■</td> <td>■</td> <td>■</td> </tr> <tr> <td><math>f</math></td> <td colspan="5">.004 – .010 (.014)</td> </tr> <tr> <td><math>a_p</math></td> <td colspan="5">.039 – .354 (.512)</td> </tr> <tr> <td></td> <td colspan="5"></td> </tr> <tr> <td><b>?</b></td> <td colspan="5">SPKN 42EDER(L), SPKN 53EDER(L)</td> </tr> </tbody> </table>	P	M	K	N	S	H	■	□	■	■	■	■	$f$	.004 – .010 (.014)					$a_p$	.039 – .354 (.512)											<b>?</b>	SPKN 42EDER(L), SPKN 53EDER(L)				
P	M	K	N	S	H																																	
■	□	■	■	■	■																																	
$f$	.004 – .010 (.014)																																					
$a_p$	.039 – .354 (.512)																																					
																																						
<b>?</b>	SPKN 42EDER(L), SPKN 53EDER(L)																																					

Table 3  
Tabla 3  
Tableau 3

GEOMETRY OF CUTTING INSERTS  
GEOMETRÍA DE PLAQUITAS DE CORTE  
GÉOMÉTRIE DE PLAQUETTES

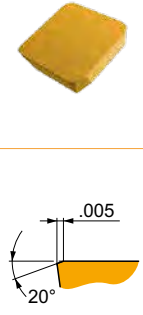
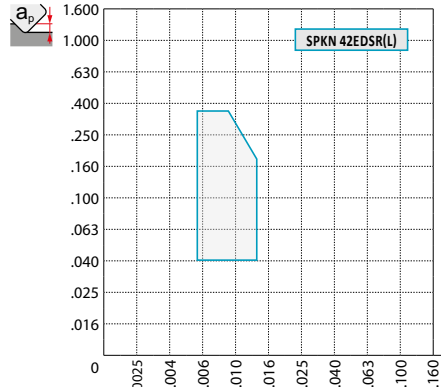







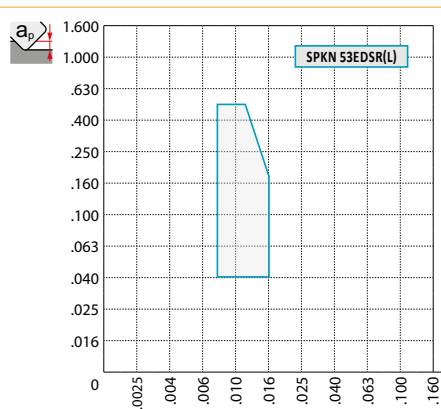







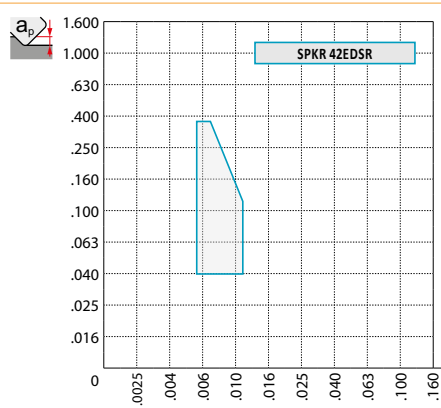







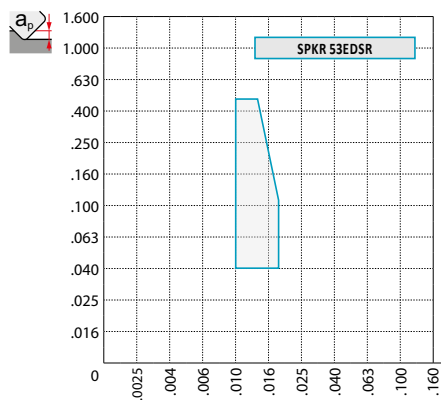







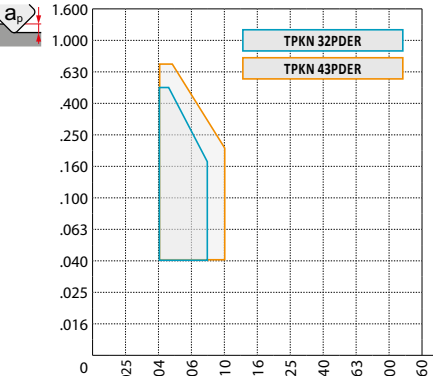







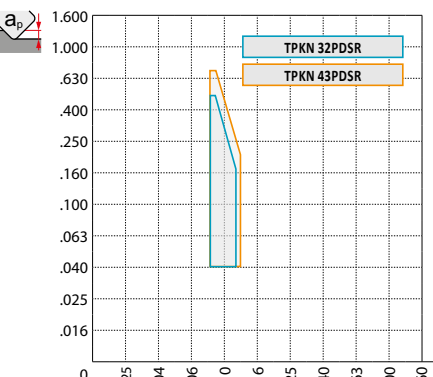







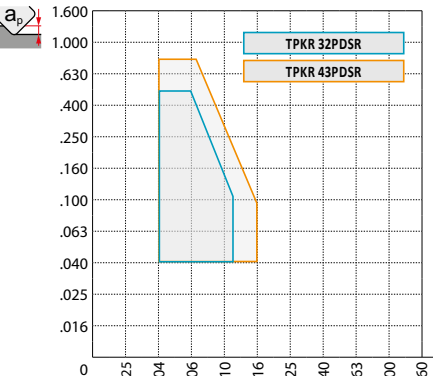







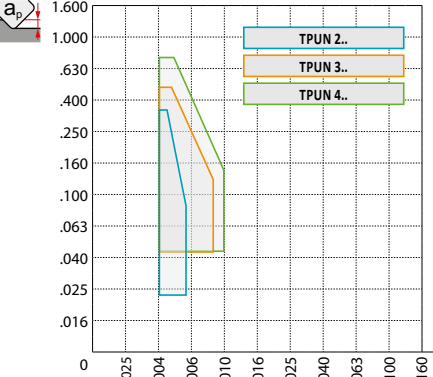






<p><b>SPKN 12 SR(L)</b></p> 	 <p>SPKN 42EDSR(L)</p>	<table border="1"> <thead> <tr> <th>P</th> <th>M</th> <th>K</th> <th>N</th> <th>S</th> <th>H</th> </tr> </thead> <tbody> <tr> <td><input checked="" type="checkbox"/></td> <td><input type="checkbox"/></td> <td><input checked="" type="checkbox"/></td> <td><input type="checkbox"/></td> <td><input type="checkbox"/></td> <td><input checked="" type="checkbox"/></td> </tr> <tr> <td><math>f</math></td> <td colspan="5">.006 – .012</td> </tr> <tr> <td><math>a_p</math></td> <td colspan="5">.039 – .354</td> </tr> <tr> <td colspan="6" style="text-align: center;">  </td> </tr> <tr> <td colspan="6" style="text-align: center;">  </td> </tr> <tr> <td><b>?</b></td> <td colspan="5">SPKN 42EDSR(L)</td> </tr> </tbody> </table>	P	M	K	N	S	H	<input checked="" type="checkbox"/>	<input type="checkbox"/>	<input checked="" type="checkbox"/>	<input type="checkbox"/>	<input type="checkbox"/>	<input checked="" type="checkbox"/>	$f$	.006 – .012					$a_p$	.039 – .354																	<b>?</b>	SPKN 42EDSR(L)				
P	M	K	N	S	H																																							
<input checked="" type="checkbox"/>	<input type="checkbox"/>	<input checked="" type="checkbox"/>	<input type="checkbox"/>	<input type="checkbox"/>	<input checked="" type="checkbox"/>																																							
$f$	.006 – .012																																											
$a_p$	.039 – .354																																											
																																												
																																												
<b>?</b>	SPKN 42EDSR(L)																																											
<p><b>SPKN 15 SR(L)</b></p> 	 <p>SPKN 53EDSR(L)</p>	<table border="1"> <thead> <tr> <th>P</th> <th>M</th> <th>K</th> <th>N</th> <th>S</th> <th>H</th> </tr> </thead> <tbody> <tr> <td><input checked="" type="checkbox"/></td> <td><input type="checkbox"/></td> <td><input checked="" type="checkbox"/></td> <td><input type="checkbox"/></td> <td><input type="checkbox"/></td> <td><input checked="" type="checkbox"/></td> </tr> <tr> <td><math>f</math></td> <td colspan="5">.008 – .016</td> </tr> <tr> <td><math>a_p</math></td> <td colspan="5">.039 – .512</td> </tr> <tr> <td colspan="6" style="text-align: center;">  </td> </tr> <tr> <td colspan="6" style="text-align: center;">  </td> </tr> <tr> <td><b>?</b></td> <td colspan="5">SPKN 53EDSR(L)</td> </tr> </tbody> </table>	P	M	K	N	S	H	<input checked="" type="checkbox"/>	<input type="checkbox"/>	<input checked="" type="checkbox"/>	<input type="checkbox"/>	<input type="checkbox"/>	<input checked="" type="checkbox"/>	$f$	.008 – .016					$a_p$	.039 – .512																	<b>?</b>	SPKN 53EDSR(L)				
P	M	K	N	S	H																																							
<input checked="" type="checkbox"/>	<input type="checkbox"/>	<input checked="" type="checkbox"/>	<input type="checkbox"/>	<input type="checkbox"/>	<input checked="" type="checkbox"/>																																							
$f$	.008 – .016																																											
$a_p$	.039 – .512																																											
																																												
																																												
<b>?</b>	SPKN 53EDSR(L)																																											
<p><b>SPKR 12 SR</b></p> 	 <p>SPKR 42EDSR</p>	<table border="1"> <thead> <tr> <th>P</th> <th>M</th> <th>K</th> <th>N</th> <th>S</th> <th>H</th> </tr> </thead> <tbody> <tr> <td><input checked="" type="checkbox"/></td> <td><input checked="" type="checkbox"/></td> <td><input checked="" type="checkbox"/></td> <td><input type="checkbox"/></td> <td><input checked="" type="checkbox"/></td> <td><input type="checkbox"/></td> </tr> <tr> <td><math>f</math></td> <td colspan="5">.006 – .012</td> </tr> <tr> <td><math>a_p</math></td> <td colspan="5">.039 – .354</td> </tr> <tr> <td colspan="6" style="text-align: center;">  </td> </tr> <tr> <td colspan="6" style="text-align: center;">  </td> </tr> <tr> <td><b>?</b></td> <td colspan="5">SPKR 42EDSR</td> </tr> </tbody> </table>	P	M	K	N	S	H	<input checked="" type="checkbox"/>	<input checked="" type="checkbox"/>	<input checked="" type="checkbox"/>	<input type="checkbox"/>	<input checked="" type="checkbox"/>	<input type="checkbox"/>	$f$	.006 – .012					$a_p$	.039 – .354																	<b>?</b>	SPKR 42EDSR				
P	M	K	N	S	H																																							
<input checked="" type="checkbox"/>	<input checked="" type="checkbox"/>	<input checked="" type="checkbox"/>	<input type="checkbox"/>	<input checked="" type="checkbox"/>	<input type="checkbox"/>																																							
$f$	.006 – .012																																											
$a_p$	.039 – .354																																											
																																												
																																												
<b>?</b>	SPKR 42EDSR																																											
<p><b>SPKR 15 SR</b></p> 	 <p>SPKR 53EDSR</p>	<table border="1"> <thead> <tr> <th>P</th> <th>M</th> <th>K</th> <th>N</th> <th>S</th> <th>H</th> </tr> </thead> <tbody> <tr> <td><input checked="" type="checkbox"/></td> <td><input checked="" type="checkbox"/></td> <td><input checked="" type="checkbox"/></td> <td><input type="checkbox"/></td> <td><input checked="" type="checkbox"/></td> <td><input type="checkbox"/></td> </tr> <tr> <td><math>f</math></td> <td colspan="5">.010 – .018</td> </tr> <tr> <td><math>a_p</math></td> <td colspan="5">.039 – .472</td> </tr> <tr> <td colspan="6" style="text-align: center;">  </td> </tr> <tr> <td colspan="6" style="text-align: center;">  </td> </tr> <tr> <td><b>?</b></td> <td colspan="5">SPKR 53EDSR</td> </tr> </tbody> </table>	P	M	K	N	S	H	<input checked="" type="checkbox"/>	<input checked="" type="checkbox"/>	<input checked="" type="checkbox"/>	<input type="checkbox"/>	<input checked="" type="checkbox"/>	<input type="checkbox"/>	$f$	.010 – .018					$a_p$	.039 – .472																	<b>?</b>	SPKR 53EDSR				
P	M	K	N	S	H																																							
<input checked="" type="checkbox"/>	<input checked="" type="checkbox"/>	<input checked="" type="checkbox"/>	<input type="checkbox"/>	<input checked="" type="checkbox"/>	<input type="checkbox"/>																																							
$f$	.010 – .018																																											
$a_p$	.039 – .472																																											
																																												
																																												
<b>?</b>	SPKR 53EDSR																																											

Table 3  
 Tabla 3  
 Tableau 3

GEOMETRY OF CUTTING INSERTS  
 GEOMETRÍA DE PLAQUITAS DE CORTE  
 GÉOMÉTRIE DE PLAQUETTES

<p>TPKN ER</p> 		<table border="1"> <thead> <tr> <th>P</th> <th>M</th> <th>K</th> <th>N</th> <th>S</th> <th>H</th> </tr> </thead> <tbody> <tr> <td><input checked="" type="checkbox"/></td> <td><input type="checkbox"/></td> <td><input checked="" type="checkbox"/></td> <td><input type="checkbox"/></td> <td><input type="checkbox"/></td> <td><input type="checkbox"/></td> </tr> <tr> <td><math>f</math></td> <td colspan="5">.004 – .008 (.010)</td> </tr> <tr> <td><math>a_p</math></td> <td colspan="5">.039 – .472 (.670)</td> </tr> <tr> <td></td> <td colspan="5"></td> </tr> <tr> <td></td> <td colspan="5">TPKN 32PDER, TPKN 43PDER</td> </tr> </tbody> </table>	P	M	K	N	S	H	<input checked="" type="checkbox"/>	<input type="checkbox"/>	<input checked="" type="checkbox"/>	<input type="checkbox"/>	<input type="checkbox"/>	<input type="checkbox"/>	$f$	.004 – .008 (.010)					$a_p$	.039 – .472 (.670)												TPKN 32PDER, TPKN 43PDER				
P	M	K	N	S	H																																	
<input checked="" type="checkbox"/>	<input type="checkbox"/>	<input checked="" type="checkbox"/>	<input type="checkbox"/>	<input type="checkbox"/>	<input type="checkbox"/>																																	
$f$	.004 – .008 (.010)																																					
$a_p$	.039 – .472 (.670)																																					
																																						
	TPKN 32PDER, TPKN 43PDER																																					
<p>TPKN SR</p> 		<table border="1"> <thead> <tr> <th>P</th> <th>M</th> <th>K</th> <th>N</th> <th>S</th> <th>H</th> </tr> </thead> <tbody> <tr> <td><input checked="" type="checkbox"/></td> <td><input type="checkbox"/></td> <td><input checked="" type="checkbox"/></td> <td><input type="checkbox"/></td> <td><input type="checkbox"/></td> <td><input type="checkbox"/></td> </tr> <tr> <td><math>f</math></td> <td colspan="5">.008 – .010 (.012)</td> </tr> <tr> <td><math>a_p</math></td> <td colspan="5">.039 – .472 (.670)</td> </tr> <tr> <td></td> <td colspan="5"></td> </tr> <tr> <td></td> <td colspan="5">TPKN 32PDSR, TPKN 43PDSR</td> </tr> </tbody> </table>	P	M	K	N	S	H	<input checked="" type="checkbox"/>	<input type="checkbox"/>	<input checked="" type="checkbox"/>	<input type="checkbox"/>	<input type="checkbox"/>	<input type="checkbox"/>	$f$	.008 – .010 (.012)					$a_p$	.039 – .472 (.670)												TPKN 32PDSR, TPKN 43PDSR				
P	M	K	N	S	H																																	
<input checked="" type="checkbox"/>	<input type="checkbox"/>	<input checked="" type="checkbox"/>	<input type="checkbox"/>	<input type="checkbox"/>	<input type="checkbox"/>																																	
$f$	.008 – .010 (.012)																																					
$a_p$	.039 – .472 (.670)																																					
																																						
	TPKN 32PDSR, TPKN 43PDSR																																					
<p>TPKR</p> 		<table border="1"> <thead> <tr> <th>P</th> <th>M</th> <th>K</th> <th>N</th> <th>S</th> <th>H</th> </tr> </thead> <tbody> <tr> <td><input checked="" type="checkbox"/></td> <td><input checked="" type="checkbox"/></td> <td><input checked="" type="checkbox"/></td> <td><input type="checkbox"/></td> <td><input type="checkbox"/></td> <td><input type="checkbox"/></td> </tr> <tr> <td><math>f</math></td> <td colspan="5">.004 – .012 (.016)</td> </tr> <tr> <td><math>a_p</math></td> <td colspan="5">.039 – .472 (.670)</td> </tr> <tr> <td></td> <td colspan="5"></td> </tr> <tr> <td></td> <td colspan="5">TPKR 32PDSR, TPKR 43PDSR</td> </tr> </tbody> </table>	P	M	K	N	S	H	<input checked="" type="checkbox"/>	<input checked="" type="checkbox"/>	<input checked="" type="checkbox"/>	<input type="checkbox"/>	<input type="checkbox"/>	<input type="checkbox"/>	$f$	.004 – .012 (.016)					$a_p$	.039 – .472 (.670)												TPKR 32PDSR, TPKR 43PDSR				
P	M	K	N	S	H																																	
<input checked="" type="checkbox"/>	<input checked="" type="checkbox"/>	<input checked="" type="checkbox"/>	<input type="checkbox"/>	<input type="checkbox"/>	<input type="checkbox"/>																																	
$f$	.004 – .012 (.016)																																					
$a_p$	.039 – .472 (.670)																																					
																																						
	TPKR 32PDSR, TPKR 43PDSR																																					
<p>TPUN</p> 		<table border="1"> <thead> <tr> <th>P</th> <th>M</th> <th>K</th> <th>N</th> <th>S</th> <th>H</th> </tr> </thead> <tbody> <tr> <td><input checked="" type="checkbox"/></td> <td><input type="checkbox"/></td> <td><input checked="" type="checkbox"/></td> <td><input type="checkbox"/></td> <td><input type="checkbox"/></td> <td><input type="checkbox"/></td> </tr> <tr> <td><math>f</math></td> <td colspan="5">.004 – .006 (.010)</td> </tr> <tr> <td><math>a_p</math></td> <td colspan="5">.020 – .315 (.670)</td> </tr> <tr> <td></td> <td colspan="5"></td> </tr> <tr> <td></td> <td colspan="5">TPUN 2., 3., 4.</td> </tr> </tbody> </table>	P	M	K	N	S	H	<input checked="" type="checkbox"/>	<input type="checkbox"/>	<input checked="" type="checkbox"/>	<input type="checkbox"/>	<input type="checkbox"/>	<input type="checkbox"/>	$f$	.004 – .006 (.010)					$a_p$	.020 – .315 (.670)												TPUN 2., 3., 4.				
P	M	K	N	S	H																																	
<input checked="" type="checkbox"/>	<input type="checkbox"/>	<input checked="" type="checkbox"/>	<input type="checkbox"/>	<input type="checkbox"/>	<input type="checkbox"/>																																	
$f$	.004 – .006 (.010)																																					
$a_p$	.020 – .315 (.670)																																					
																																						
	TPUN 2., 3., 4.																																					

Correctly identifying the machined material is one of the most important factors when choosing the tool and the initial machining conditions. To facilitate this, the machined materials are divided into six basic groups, or into twenty-four subgroups, combining materials that qualitatively cause the same type of loading (pressure) on the cutting edge and therefore a similar type of wear.

Thus the first step is to assign the workpiece material to one of the (sub)groups – see table 4. below.

Table 4

Identificar correctamente el material mecanizado es uno de los factores más importantes al momento de elegir la herramienta y la condiciones iniciales de mecanizado. Para facilitar esto, los materiales mecanizados se dividen en seis grupos básicos, o en veinticuatro subgrupos, combinando materiales que cualitativamente pueden causar el mismo tipo de carga (esfuerzo) en la arista de corte y por lo tanto un tipo similar de desgaste. Así, el primer paso es asignar el material de la pieza a uno de los (sub) grupos - véase la tabla 4. a continuación.

Tabla 4

Subgroup Sub-grupo	DORMER AMG	Subgroup definition	Definición de sub-grupo	Example Ejemplo	Correction factor Corrección standard	
<b>P</b>	<b>P1</b>	1.1, 1.2	Steel and cast steel with very good (enhanced) machinability; automatic steel and low-carbon steel	Acero y fundición de acero con muy buena (mejorado) mecanización, acero automático y de acero bajo en carbono	1213	1.33
	<b>P2</b>	1.3	Non-alloy and low-alloy cast steel and steel with a medium carbon content (.25 < C < .55); rigidity of up to 900 MPa and hardness of 160 – 255 HB	Sin alea y de baja aleación de acero fundido y acero con un contenido de carbono medio (.25 < C < .55); rigidez de hasta 900 MPa y una dureza de 160 – 255 HB	Gr.1043	1.00
	<b>P3</b>	1.4	Less machinable non-alloy and low-alloy cast steel and steel with a medium carbon content; rigidity of up to 1000 MPa and hardness of up to 300 HB	Menos mecanizable sin alea y de acero fundido de baja aleación y acero con un contenido de carbono medio; rigidez de hasta 1000 MPa y una dureza de hasta 300 HB	Cl. A	0.80
	<b>P4</b>	1.5	Medium – to high-alloy cast steel and steel (usually with a carbon content of .55 < C); rigidity of up to 1270 MPa and hardness of up to 375 HB (resp. 40 HRC)	Medio – alto-aleación de acero fundido y acero (normalmente con un contenido de carbono de .55 < C); rigidez de hasta 1270 MPa y una dureza de hasta 375HB (resp. 40 HRC)	D3	0.60
<b>M</b>	<b>M1</b>	2.1	Ferritic corrosion-resistant steel	Acero resistente a la corrosión ferrítico	Type 430	1.09
	<b>M2</b>	(2.1, 2.4)	Martensitic corrosion-resistant steel	Acero resistente a la corrosión martensítico	HNV 3	1.06
	<b>M3</b>	2.2	Austenitic corrosion-resistant steel	Acero resistente a la corrosión austenítico	Type 321	1.00
	<b>M4</b>	2.3, 2.4	Ferritic-austenitic (duplex) and super-austenitic corrosion-resistant steel	Ferrítico-austenítico (dúplex) y super-austenítico acero resistente a la corrosión	EV 12	0.93
<b>K</b>	<b>K1</b>	3.1, 3.2	Grey cast iron	Gris hierro fundido	C1.35B	1.00
	<b>K2</b>	3.1, 3.2	Tempered cast iron	Hierro fundido templado	Gr.45006	0.95
	<b>K3</b>	3.3	Ductile cast iron ferritic and ferrite-pearlite	Fundición ferrítico hierro y ferrita-perlita	Gr.60-40-18	0.90
	<b>K4</b>	3.4	Ductile cast iron pearlite-ferritic, pearlite-sorbitic and pearlite	Fundición dúctil de perlita y ferrita, perlita-sorbítico y perlita	100-70-03	0.85
<b>N</b>	<b>N1</b>	7.1	Aluminium and its soft alloys (with a low Si content), particularly formed and cast (non-hardened); hardness of up to 100 HB	Aluminio y sus aleaciones blandas (con bajo contenido de Si), especialmente formado y yeso (no resistente); dureza de hasta 100 HB	A96061	1.00
	<b>N2</b>	7.2, 7.3, 7.4	Hard Al alloys, particularly cast and hardened (with a high Si content)	Duro aleaciones de Al, en particular emitidos y endurecidos (con un alto contenido de Si)	A04130	0.65
	<b>N3</b>	6.1, 6.2, 6.3	Soft Cu alloys, automatic brass and other types of soft brass and bronze	Aleaciones Cu suaves, latón automática y otros tipos de latón blando y bronce	C83600	0.60
	<b>N4</b>	6.4	Less machinable and hard Cu alloys	Aleaciones Cu menos mecanizables y duros	C95200	0.40
<b>S</b>	<b>S1</b>	4.1, 4.2, 4.3	Technically pure Ti, alloys $\alpha$ , $\alpha+\beta$ and $\beta$ , refined and aged alloys	Técnicamente ti puro, aleaciones $\alpha$ , $\alpha+\beta$ y $\beta$ , refinado y aleaciones viejas	AMS R56401	1.75
	<b>S2</b>	(9.1)	Fe-based alloys	Aleaciones a base de hierro	B 163	1.20
	<b>S3</b>	5.1, 5.2, 5.3	Ni-based alloys	Aleaciones a base de níquel	AMS 5589	1.00
	<b>S4</b>	(9.1)	Co-based alloys	Aleaciones a base de cobalto	AMS 5759	0.75
<b>H</b>	<b>H1</b>	1.6	Highly rigid and hard tool steel and hardened and refined steel with a hardness of 40 – 50 HRC	Muy rígido y duro y acero para herramientas endurecido y acero refinado, con una dureza de 40 – 50 HRC	H21	1.15
	<b>H2</b>	–	Hardened and white cast iron 350 – 600 HV	Hierro fundido templado y blanco 350 – 600 HV	Ni-Hard 2	1.10
	<b>H3</b>	1.7	Hardened and refined steel with hardness in the 50 – 55 HRC range	Acero templado y refinada con dureza en el 50 – 55 gama HRC	H11	1.00
	<b>H4</b>	1.8	Hardened and refined (mostly tool) steel with hardness of more than 55 HRC	Endurecido y refinado (en su mayoría de la herramienta) de acero con dureza de más de 55 HRC	D3	0.95

## CLASSIFICATION DES GROUPES DE MATÉRIAUX À USINER

L'identification du matériau à usiner est l'un des facteurs les plus importants pour choisir l'outil et les conditions de coupe de départ. Pour simplifier ce choix, les matériaux usinés sont divisés en six groupes de base, ou vingt quatre sous-groupes. Dans chacun sont associés des matériaux qui causent le même type de charge sur l'arête de coupe et également un type d'usure similaire. C'est pourquoi la première étape consiste à identifier le matériau à usiner parmi les (sous-)groupes référencés - voir tableau N°4 ci-dessous.

Tableau 4

Sous-groupe	DORMER AMG	Définition du sous-groupe	Exemple	Correction à la norme
<b>P</b>	<b>P1</b>	1.1. 1.2 Acier et acier coulé avec une usinabilité améliorée ; acier de construction et acier à faible teneur en carbone	1213	1.33
	<b>P2</b>	1.3 Acier et acier coulé non allié et faiblement allié à moyenne teneur en carbone (.25 < C < .55); résistance jusqu'à 900 MPa et dureté de 160 – 255 HB	Gr.1043	1.00
	<b>P3</b>	1.4 Acier et acier coulé non allié et faiblement allié à moyenne teneur en carbone plus difficiles à usiner; résistance jusqu'à 1000 MPa et dureté jusqu'à 300 HB	Cl. A	0.80
	<b>P4</b>	1.5 Acier et acier coulé moyennement et fortement allié (généralement avec une teneur en carbone .55 < C); résistance jusqu'à 1270 MPa et dureté jusqu'à 375 HB HRC)	D3	0.60
<b>M</b>	<b>M1</b>	2.1 Aciers inoxydables ferritiques résistants à la corrosion	Type 430	1.09
	<b>M2</b>	(2.1. 2.4) Aciers inoxydables martensitiques résistants à la corrosion	HNV 3	1.06
	<b>M3</b>	2.2 Aciers inoxydables austénitiques résistants à la corrosion	Type 321	1.00
	<b>M4</b>	2.3. 2.4 Aciers inoxydables ferritiques-austénitiques (duplex) et super austénitiques résistants à la corrosion	EV 12	0.93
<b>K</b>	<b>K1</b>	3.1. 3.2 Fontes grises	C1.35B	1.00
	<b>K2</b>	3.1. 3.2 Fontes trempées	Gr.45006	0.95
	<b>K3</b>	3.3 Fontes ductiles ferritiques et ferritiques-perlitiques	Gr.60-40-18	0.90
	<b>K4</b>	3.4 Fontes ductiles perlites-ferrites. perlites et de perlites sorbitiques	100-70-03	0.85
<b>N</b>	<b>N1</b>	7.1 L'aluminium et ses alliages doux (à faible teneur en Si), en particulier formés et coulés (non trempé); dureté jusqu'à 100 HB	A96061	1.00
	<b>N2</b>	7.2. 7.3. 7.4 Alliages Al durs, en particulier coulés et traités (à haute teneur en Si)	A04130	0.65
	<b>N3</b>	6.1.6.2. 6.3 Alliages Cu doux, laiton automatique et autres types de laiton et de bronze tendre	C83600	0.60
	<b>N4</b>	6.4 Alliages moins faciles à usiner et alliages durs Cu	C95200	0.40
<b>S</b>	<b>S1</b>	4.1. 4.2. 4.3 Ti techniquement pur, alliages $\alpha$ , $\alpha+\beta$ et $\beta$ , alliages affinés et vieillis	AMS R56401	1.75
	<b>S2</b>	(9.1) Alliages base Fe	B 163	1.20
	<b>S3</b>	5.1. 5.2. 5.3 Alliages base Ni	AMS 5589	1.00
	<b>S4</b>	(9.1) Alliages base Co	AMS 5759	0.75
<b>H</b>	<b>H1</b>	1.6 Aciers à outils très résistants durs, trempés, affinés avec une dureté de 40 – 50 HRC	H21	1.15
	<b>H2</b>	– Fontes trempées et blanches 350 – 600 HV	Ni-Hard 2	1.10
	<b>H3</b>	1.7 Aciers trempés et affinés avec une dureté dans la plage 50 – 55 HRC	H11	1.00
	<b>H4</b>	1.8 Aciers trempés et affinés (principalement acier à outil) avec une dureté de plus de 55 HRC	D3	0.95

# M

# 9

# 3

# 2

# 5

Application  
Aplicación  
Application

Coating / Substrate  
Recubrimiento / Sustrato  
Revêtement / Substrat

Sequence number  
Número de secuencia  
Numéro de séquence

ISO range  
Gama ISO  
Plage ISO



<b>D</b>	Drilling Taladrado Perçage
<b>M</b>	Milling Fresado Fraisage
<b>T</b>	Turning Torneado Tournage

<b>0 PVD</b> <b>1 CVD</b>	Special application Aplicación especial Application spéciale
<b>2 PVD</b> <b>3 CVD</b>	Free Libre Libre
<b>4 PVD</b> <b>5 CVD</b>	Cast iron Fundición Fonte
<b>6 PVD</b> <b>7 CVD</b>	Group M, S Grupos M, S Groupe ISO M & S
<b>8 PVD</b> <b>9 CVD</b>	Universal Universal Universel
<b>B</b>	CBN
<b>D</b>	PCD

<b>1-9</b>
------------

<b>01-50</b>	
	<b>01-05</b>
	<b>05-10</b>
	<b>10-20</b>
	<b>20-30</b>
	<b>30-40</b>
	<b>40-50</b>



Table 2  
Tabla 2  
Tableau 2

MILLING GRADES  
CALIDADES DE FRESADO  
NUANCES DE FRAISAGE

Grade Identification Calidad Code nuance	Area of Application Área de aplicación Plage d'application Matière	Application / Application / Aplicación	Feed Avance Avance	Cutting speed Velocidad de corte Vitesse de coupe	Resistance to adverse working conditions Resistencia a condiciones de corte adversas Résistance à des conditions d'usinage difficiles	Substrate Sustrato Substrat	Coating / Recubrimiento Type de revêtement	Color / Color / Couleur	Coolant benefit / Refrigerante Bénéfice de l'arrosage	General / General / Général	Disc Milling Cutters / Fresas de disco Fraises à disques	Copy Milling / Copiado / Copiage	Heavy roughing / Desbaste fuerte Ébauche lourde
<b>M9315</b>	P05 - P25	<input type="checkbox"/>				H	MT-CVD	---	✓		✓		
	K10 - K30	<input type="checkbox"/>											
	H10 - H20	<input type="checkbox"/>											
<b>M9325</b>	P10 - P30	<input type="checkbox"/>				H	MT-CVD	---	✓		✓		
	M10 - M25	<input type="checkbox"/>											
	S05 - S15	<input type="checkbox"/>											
<b>M9340</b>	P35 - P50	<input type="checkbox"/>				H	MT-CVD	---	✓		✓		
	M30 - M40	<input type="checkbox"/>											
	S15 - S20	<input type="checkbox"/>											
<b>M5315</b>	P05 - P20	<input type="checkbox"/>				H	MT-CVD	---	✓				
	K05 - K25	<input type="checkbox"/>											
	H05 - H20	<input type="checkbox"/>											
<b>M5326</b>	P05 - P25	<input type="checkbox"/>				H	MT-CVD	---				✓	
	K10 - K30	<input type="checkbox"/>											
<b>M6330</b>	P20 - P35	<input type="checkbox"/>				H	PVD	+/-	✓				
	M20 - M35	<input type="checkbox"/>											
	S10 - S30	<input type="checkbox"/>											
<b>M8310</b>	P01 - P10	<input type="checkbox"/>				submicron H	PVD	-				✓	
	M01 - M10	<input type="checkbox"/>											
	K01 - K10	<input type="checkbox"/>											
	S05 - S10	<input type="checkbox"/>											
<b>M8325</b>	P20 - P40	<input type="checkbox"/>				S	PVD	-			✓		
	M15 - M30	<input type="checkbox"/>											
	K20 - K35	<input type="checkbox"/>											
<b>M8326</b>	P20 - P40	<input type="checkbox"/>				H	PVD	-				✓	
	M15 - M35	<input type="checkbox"/>											
	K15 - K35	<input type="checkbox"/>											
<b>M8340</b>	P25 - P50	<input type="checkbox"/>				submicron H	PVD	+/-	✓	✓	✓	✓	
	M20 - M40	<input type="checkbox"/>											
	K20 - K40	<input type="checkbox"/>											
	S20 - S30	<input type="checkbox"/>											
<b>M8345</b>	P30 - P50	<input type="checkbox"/>				H	PVD	-	✓		✓	✓	
	M30 - M40	<input type="checkbox"/>											
	S20 - S30	<input type="checkbox"/>											
<b>M8346</b>	P30 - P50	<input type="checkbox"/>				H	PVD	-				✓	
	M30 - M40	<input type="checkbox"/>											
<b>M0315</b>	N05 - N25	<input type="checkbox"/>				submicron H	PVD	-	✓				

Table 2  
Tabla 2  
Tableau 2

MILLING GRADES  
CALIDADES DE FRESADO  
NUANCES DE FRAISAGE

Grade identification Calidad Code nuance	Area of Application Área de aplicación Plage d'application Matière	Application / Application / Aplicación	Feed Avance Avance	Cutting speed Velocidad de corte Vitesse de coupe	Resistance to adverse working conditions Resistencia a condiciones de corte adversas Résistance a des conditions d'usinage difficiles	Substrate Sustrato Substrat	Coating / Recubrimiento Type de revêtement	Color / Color / Couleur	Coolant benefit / Refrigerante Bénéfice de l'arrosage	General / General / Général	Disc Milling Cutters / Fresas de disco Fraises à disques	Copy Milling / Copiado / Copiage	Heavy roughing / Desbaste fuerte Ébauche lourde
<b>8215</b>	P10 - P20	<input checked="" type="checkbox"/>				submicron H	PVD	Dark Grey	+/-	✓	✓	✓	
	M10 - M20	<input checked="" type="checkbox"/>											
	K10 - K25	<input checked="" type="checkbox"/>											
	N10 - N25	<input checked="" type="checkbox"/>											
	S10 - S15	<input checked="" type="checkbox"/>											
	H10 - H15	<input checked="" type="checkbox"/>											
<b>M8330</b>	P20 - P40	<input checked="" type="checkbox"/>				submicron H	PVD	Yellow	-	✓	✓	✓	
	M20 - M35	<input checked="" type="checkbox"/>											
	K20 - K40	<input checked="" type="checkbox"/>											
	N15 - N30	<input type="checkbox"/>											
	S15 - S25	<input type="checkbox"/>											
	H15 - H25	<input checked="" type="checkbox"/>											
<b>M8340</b>	P25 - P50	<input checked="" type="checkbox"/>				submicron H	PVD	Yellow	+/-	✓	✓	✓	✓
	M20 - M40	<input checked="" type="checkbox"/>											
	K20 - K40	<input checked="" type="checkbox"/>											
	S20 - S30	<input checked="" type="checkbox"/>											
<b>7205</b>	P01 - P10	<input checked="" type="checkbox"/>				ultra submicron H	PVD	Dark Purple	-			✓	
	M01 - M10	<input type="checkbox"/>											
	K01 - K10	<input checked="" type="checkbox"/>											
	N01 - N10	<input checked="" type="checkbox"/>											
<b>7215</b>	P05 - P20	<input checked="" type="checkbox"/>				submicron H	PVD	Dark Purple	-			✓	
	M05 - M20	<input checked="" type="checkbox"/>											
	K05 - K25	<input checked="" type="checkbox"/>											
	N05 - N25	<input checked="" type="checkbox"/>											
	S05 - S15	<input type="checkbox"/>											
H05 - H15	<input checked="" type="checkbox"/>												
<b>7230</b>	P25 - P40	<input checked="" type="checkbox"/>				submicron H	PVD	Dark Purple	-			✓	
	M20 - M35	<input checked="" type="checkbox"/>											
	K20 - K35	<input checked="" type="checkbox"/>											
	N15 - N30	<input checked="" type="checkbox"/>											
	S15 - S25	<input checked="" type="checkbox"/>											
H15 - H25	<input checked="" type="checkbox"/>												

Table 2  
Tabla 2  
Tableau 2

MILLING GRADES  
CALIDADES DE FRESADO  
NUANCES DE FRAISAGE

Grade identification Calidad Code nuance	Area of Application Área de aplicación Plage d'application Matière	Application / Application / Aplicación	Feed Avance Avance	Cutting speed Velocidad de corte Vitesse de coupe	Resistance to adverse working conditions Resistencia a condiciones de corte adversas Résistance à des conditions d'usinage difficiles	Substrate Sustrato Substrat	Coating / Recubrimiento Type de revêtement	Color / Color / Couleur	Coolant benefit / Refrigerante Bénéfice de l'arrosage	General / General / Général	Disc Milling Cutters / Fresas de disco Fraises à disques	Copy Milling / Copiado / Copiage	Heavy roughing / Desbaste fuerte Ébauche lourde
<b>HF7</b>	M10 - M20	<input type="checkbox"/>				submicron H	X		++	✓			
	K10 - K25	<input type="checkbox"/>											
	N10 - N25	<input type="checkbox"/>											
	S10 - S20	<input type="checkbox"/>											
	H10 - H20	<input type="checkbox"/>											
<b>S26</b>	P15 - P30	<input type="checkbox"/>				S	X		++	✓			✓
<b>S45</b>	P30 - P45	<input type="checkbox"/>				S	X		++	✓			
	M30 - M40	<input type="checkbox"/>											

Substrate / Sustrato / Substrat

<b>H</b>	WC-Co based substrate	Sustrato de base WC-Co	Base de substrat WC-Co (Carbure de Tungstène – base Cobalt)
<b>submicron H</b>	WC-Co based substrate fine grained (< 40 µin)	Sustrato de base WC-Co de grano fino (< 40 µin)	Base de substrat WC-Co à grains fins (<40 µin)
<b>ultra submicron H</b>	WC-Co based substrate very fine grained (< 20 µin)	Sustrato de base WC-Co de grano muy fino (< 20 µin)	Base de substrat WC-Co à grains très fins (< 20 µin)
<b>S</b>	Substrate with cubic carbides	Sustrato con carburos cúbicos	Substrat à carbures cubiques
<b>PCD</b>	Polycrystalline Diamond	Diamante Policristalino	Diamant Polycristallin
<b>CBN</b>	Cubic Boron Nitride	Nitruro de Boro Cúbico	Nitruire de Bore Cubique

Coating / Recubrimiento / Revêtement

<b>MT-CVD</b>	Medium-temperature chemical method of coating	Método de recubrimiento químico a media temperatura	Méthode de revêtement à déposition chimique moyenne température
<b>PVD</b>	Low-temperature physical method of coating	Método de recubrimiento físico a baja temperatura	Méthode de revêtement à déposition physique basse température
<b>X</b>	Uncoated grade	Calidad sin recubrimiento	Nuance carbure non revêtue



FACE MILLING (WITH SHOULDER, WITH CHAMFER) / PLANEADO (CON ESCUADRA, CON CHAFLÁN)  
SURFAÇAGE (AVEC ÉPAULEMENT, CHANFREIN)

Face milling (with shoulder or chamfer) is one of key milling operations, and we must therefore split it into multiple sections.

1. Determine whether the required operation is roughing or finishing.
2. Decide whether you wish to machine using the face or the periphery of the milling cutter.
3. Choose the proper tool based on the type, size, power and rigidity of the machine.

For roughing, the basic requirement is to remove as much material as possible in the shortest amount of time while at the same time approaching the final shape as much as possible. In powerful and rigid machines, choose tools which allow the highest depth of cut while less stable machines with lower output require a tool with low recommended depth of cut and higher allowed feed (toroidal or HFC milling cutters). The same recommendation goes for both cases: Use the information provided for inserts, where you use the minimum feed values for  $a_{p\ max}$  and maximum feed values for  $a_{p\ min}$ .

In finishing operations, where we are limited by the required surface roughness, the key factors are the size of the wiper segment, or rather the size of the radius, the number of tool teeth and feed.

For inserts with wiper segments, the feed per revolution must be smaller than the size of the wiper segment.

El planeado (con escuadra o chaflán) es una de las operaciones clave en fresado y por tanto debemos dividirlo en múltiples secciones.

1. Determinar si la operación requerida es desbaste o acabado.
2. Decidir si se quiere mecanizar utilizando la cara o la periferia de la fresa.
3. Elegir la herramienta adecuada en función del tipo, tamaño, potencia y rigidez de la máquina.

Para desbaste, el requerimiento básico es arrancar todo el material posible en el espacio de tiempo más corto posible a la vez que se deja la pieza tan cerca de su forma final como sea posible. En máquinas potentes y rígidas, elegir herramientas que permitan la mayor profundidad de corte mientras que en máquinas menos estables con menor potencia es necesario elegir herramientas con poca profundidad de corte recomendada y mayores avances permitidos (fresas toroidales o de alto avance HFC). La misma recomendación vale para ambos casos: Usar la información proporcionada en las plaquitas, donde se deben utilizar los valores mínimos de avance para  $a_{p\ max}$  y máximos valores de avance para  $a_{p\ min}$ .

En operaciones de acabado, donde estamos limitados por la rugosidad superficial, los factores clave son el tamaño de la faceta rascadora o wiper, el tamaño del radio, el número de dientes y el avance.

Para plaquitas con faceta rascadora o wiper, el avance por revolución debe ser menor que el tamaño de la faceta wiper.

Le surfaçage (avec épaulement ou chanfrein) est l'une des principales opérations de fraisage, et il doit donc être divisé en plusieurs sections.

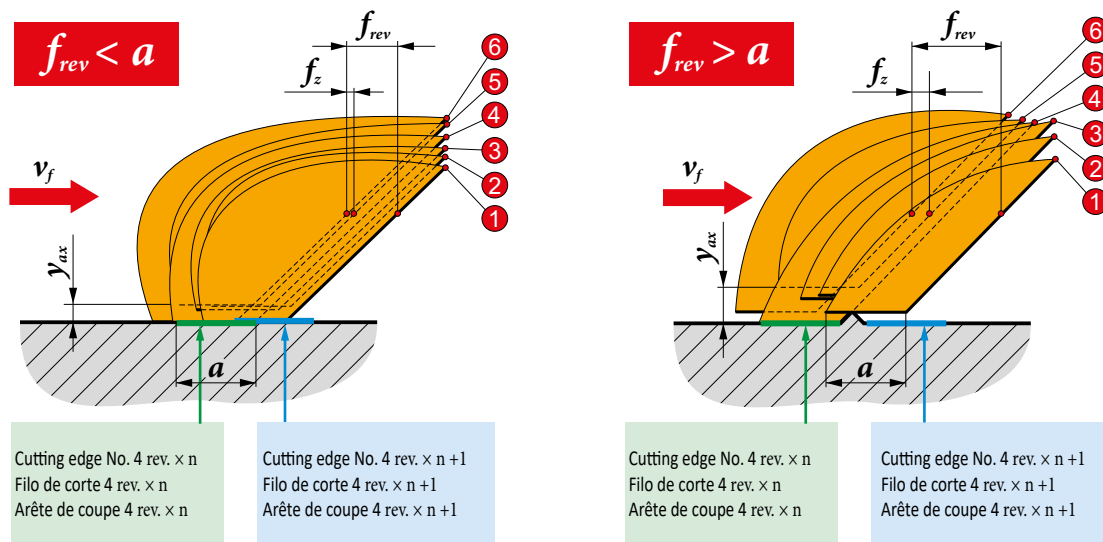
1. Déterminer si l'opération requise est une ébauche ou une finition.
2. Décider si vous souhaitez travailler dans l'axe ou dans la périphérie de la fraise.
3. Choisir l'outil approprié en fonction du type, de la taille, de la puissance et de la rigidité de la machine.

Pour l'ébauche, l'exigence de base est d'éliminer autant de matière que possible dans le temps le plus court, tout en se rapprochant de la forme finale. Avec des machines puissantes et rigides, choisissez des outils qui autorisent la plus haute profondeur de coupe, tandis que les machines moins stables avec une puissance plus faible nécessiteront un outil à profondeur de passe réduite avec des avances supérieures (fraises toroïdales ou grandes avances HFC).

La même recommandation suivante est valable dans les deux cas : utilisez les informations fournies pour les plaquettes, où vous sélectionnez les valeurs d'avance minimum pour  $a_{p\ max}$  et les valeurs maximales d'avance pour  $a_{p\ min}$ .

Dans les opérations de finition, où nous sommes limités par la rugosité de surface requise, les facteurs clés sont la taille du plat de planage, ou encore la dimension du rayon de plaquette, le nombre de dents sur l'outil et l'avance. Pour les plaquettes avec plats de planage, l'avance par tour doit être inférieure à la valeur du plat de planage.

Picture / Figura / Image 12



That means:  $f_{z \max} \leq a/z$

- a wiper segment size [in]
- z number of milling cutter teeth [-]
- $f_{rev}$  feed per revolution [in/rev]
- $f_z$  feed per tooth [in/tooth]

For toroidal milling cutters the situation is similar for round and radius version of inserts.

Esto significa:  $f_{z \max} \leq a/z$

- a tamaño de la faceta wiper [in]
- z número de dientes de la fresa [-]
- $f_{rev}$  avance por revolución [in/rev]
- $f_z$  avance por diente [in/diente]

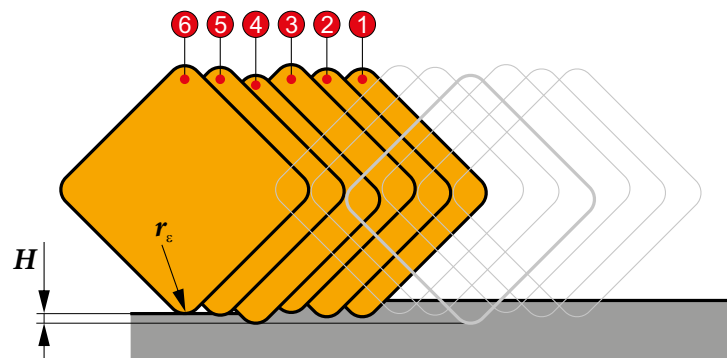
Para fresas toroidales (la situación es similar para plaquitas redondas o de radio).

Ce qui veut dire:  $f_{z \max} \leq a/z$

- a valeur du plat de planage [in]
- z nombre de dents sur la fraise [-]
- $f_{rev}$  avance par tour [in/tour]
- $f_z$  avance par dent [in/dent]

Pour les fraises toroidales (la situation est la même pour les versions à plaquettes rondes et les plaquettes à rayons).

Picture / Figura / Image 13



Therefore, feed per tooth:  $f_{z\max} \leq (\sqrt{8 \cdot r_e \cdot H})/z$

- $r_e$  size of insert radius [in]
- $z$  number of milling cutter teeth [-]
- $H$  maximum cusp height (~H) [in]

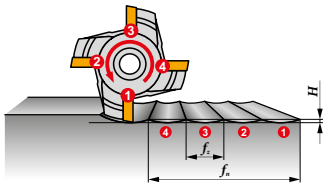
Roughness can of course be determined approximately even when machining with the periphery of the milling cutter:

Par conséquent, l'avance par dent:  $f_{z\max} \leq (\sqrt{8 \cdot r_e \cdot H})/z$

- $r_e$  valeur du rayon de plaquette [in]
- $z$  nombre de dents sur la fraise [-]
- $H$  hauteur de pointe maximale (~H) doit être indiquée en [in]

La rugosité peut bien sûr être déterminée approximativement même lors de l'usinage avec la périphérie de la fraise:

Picture / Figura / Image 14



Where:

- $f_z$  feed per tooth [in/tooth]
- $D$  milling cutter diameter [in]
- $H$  maximum cusp height (~ $R_z$ ) in [in]

Où:

- $f_z$  avance par dent [in/dent]
- $D$  diamètre de la fraise [in]
- $H$  hauteur de pointe maximale (~ $R_z$ ) en [in]

During face milling where the width of the milled surface is equal to the milling cutter diameter, use the values recommended for inserts. If the width of cut is smaller than the milling cutter diameter, the key factor is whether machining is done using the center or the side of the milling cutter. In both cases, corrections in feed and cutting speed should be made.

However, it is essential in either case to ensure that the tool does not enter or exit the cut in the area close to the center of the milling cutter (so-called „death zone“).

Pendant une opération de surfacage, où la largeur de la surface usinée est égale au diamètre de la fraise, utiliser les valeurs d'avance recommandées pour les plaquettes. Si la largeur de coupe est inférieure au diamètre de la fraise, le facteur clé est de déterminer si l'usinage est fait en utilisant le centre ou le côté de la fraise. Dans les deux cas, des corrections d'avance et de vitesse de coupe devront être faites.

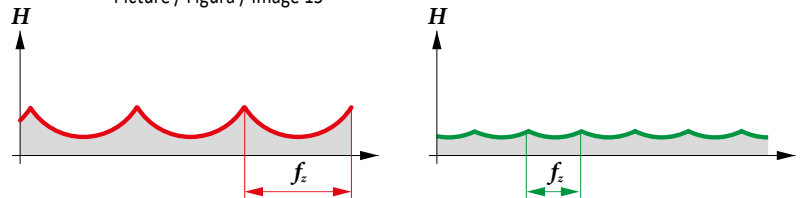
Toutefois, il est essentiel, dans l'un ou l'autre cas, de s'assurer que l'outil n'entre ni ne sorte de la matière par la zone proche du centre de la fraise.

Por tanto, avance por diente:  $f_{z\max} \leq (\sqrt{8 \cdot r_e \cdot H})/z$

- $r_e$  tamaño del radio de plaqueta [in]
- $z$  número de dientes de la fresa [-]
- $H$  máxima altura (~H) en [in]

La rugosidad se puede determinar aproximadamente incluso cuando se mecaniza con la perifería de la fresa:

Picture / Figura / Image 15



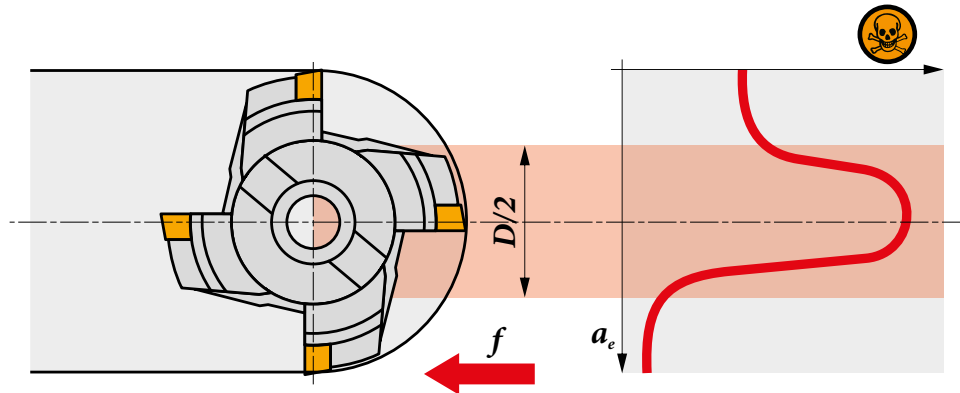
Donde:

- $f_z$  avance por diente [in/diente]
- $D$  diámetro de la fresa [in]
- $H$  máxima altura (~ $R_z$ ) en [in]

Durante el planeado, donde el ancho de la superficie fresada es igual al diámetro de la fresa, utilizar los valores recomendados para las plaquetas. Si el ancho de corte es menor que el diámetro de la fresa, el factor clave es si se mecaniza con el centro o con el lateral de la fresa. En ambos casos, hay que hacer correcciones en el avance y en la velocidad de corte.

No obstante, es esencial en cualquier caso asegurarse de que la herramienta no entra ni sale del corte en el área cercana al centro de la fresa (llamada zona de muerte).

Picture / Figura / Image 16



Below are the corrections for cutting speed and feed.

Aquí están las correcciones de velocidad de corte y avance.

Voici les corrections de vitesse de coupe et d'avance recommandées.

Table / Tabla / Tableau 5

$a_e / D$	.05	.10	.15	.20	.25	.30	.40	.50	.60	.70	.75	.80	.90	1.00
	1.48	1.35	1.27	1.22	1.19	1.16	1.11	1.08	1.05	1.03	1.00	1.00	1.00	1.00
	2.87	2.05	1.69	1.48	1.33	1.23	1.09	.75	.94	.90	.89	.88	.88	1.00
	.64	.64	.64	.64	.64	.65	.65	.67	.68	.71	.72	.74	.79	1.00



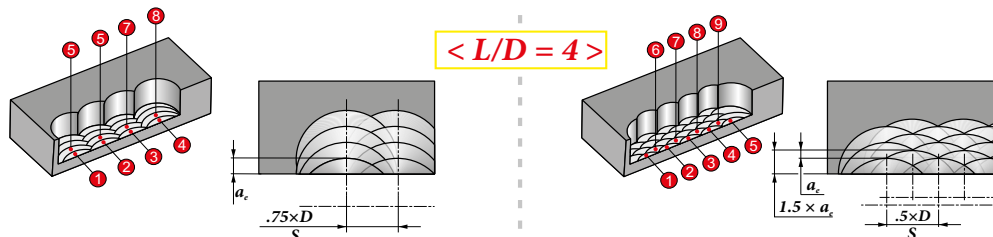
**PLUNGE MILLING (SLOTING) / FRESADO EN PLUNGE (FRESADO AXIAL) / OPÉRATION DE TRÉFLAGE**

This category contains recommendations for maximum permissible radial depth of cut for a given tool group. In this case, tool overhang plays a vital role. Therefore, when using higher overhang ( $L/D > 4$ ) to create wider shoulders, we recommend modifying the working conditions in line with the following figure.

Esta categoría contiene recomendaciones para una profundidad de corte radial máxima permisible para un grupo de herramientas determinado. En este caso, el voladizo de la herramienta juega un papel vital. Por tanto, cuando se utilizan grandes voladizo ( $L/D > 4$ ) para crear escuadras, recomendamos modificar las condiciones en línea con la siguiente figura.

Cette catégorie contient des recommandations pour la profondeur de coupe radiale maximale autorisée pour un groupe d'outils donné. Dans ce cas, le porte-à-faux de l'outil joue un rôle essentiel. Par conséquent, lorsque vous utilisez un porte-à-faux élevé ( $L/D > 4$ ) pour créer des épaulements plus larges, nous vous recommandons de modifier les conditions de travail selon la figure suivante.

Picture / Figura / Image 17

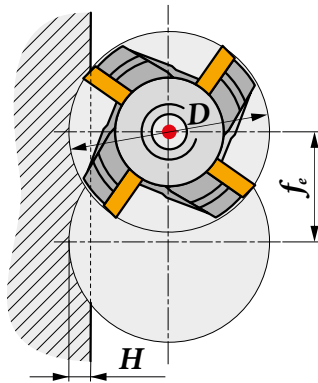


This method can also be used as finishing; the resulting roughness (cusp height) of the surface can then be calculated with the formula:

Esta tecnología se puede utilizar también para acabado; la rugosidad resultante (altura de crestas) de la superficie se puede calcular con la fórmula:

Cette technique peut également être utilisée en finition; la rugosité résultante (hauteur d'engagement) de la surface peut alors être calculée avec la formule:

Picture / Figura / Image 18



$$H = \frac{f_c^2}{4 \cdot D}$$

Where:

- $f_c$  plunging step [in]
- D milling cutter diameter [in]
- H maximum cusp height ( $\sim R_z$ ) in [in]

Donde:

- $f_c$  paso [in]
- D diámetro de la fresa [in]
- H altura máxima de crestas ( $\sim R_z$ ) en [in]

Où:

- $f_c$  incrément de plongée [in]
- D diamètre de la fraise [in]
- H hauteur maximale d'engagement ( $\sim R_z$ ) en [in]



**SLOT MILLING / RANURADO / RAINURAGE**

Here again, we must make a differentiation between milling with disc milling cutters and cylindrical milling cutters or end mills.

Aquí tenemos que hacer de nuevo una diferenciación entre fresas de disco y fresas cilíndricas o de ranurado.

Disc milling cutters can be used for machining both shoulders and slots. Therefore, we have included tables in the technology section from which you can determine the minimum and maximum feed you can use for the given tool and radial depth of cut (slot depth) or for the given  $a_e/D$  ratio.

Las fresas de disco se pueden usar para escuadras o para ranuras. Por tanto, hemos incluido tablas en la sección tecnológica con la que se puede determinar el avance mínimo y máximo que se puede utilizar para una herramienta determinada y la profundidad de corte radial (profundidad de ranura) o para la relación  $a_e/D$ .

Là encore, nous devons faire une distinction entre le fraisage avec une fraise-disque (ou fraise 3 tailles) et une fraise cylindrique.

Les fraises-disques peuvent être utilisées pour usiner à la fois les épaulements et les rainures. Par conséquent, nous avons inclus des tableaux dans la section technique de ce catalogue à partir desquels vous pouvez déterminer les avances minimum et maximum que vous pouvez utiliser pour un outil donné, pour la profondeur de coupe radiale donnée (profondeur de la rainure) ou pour le rapport  $a_e/D$  donné.



Table / Tabla / Tableau 6

$a_e$		0.20		0.40		0.60		0.80		1.00	
D	$f_{min}$ ↔	$f_{max}$ ↔	$f_{min}$ ↔	$f_{max}$ ↔	$f_{min}$ ↔	$f_{max}$ ↔	$f_{min}$ ↔	$f_{max}$ ↔	$f_{min}$ ↔	$f_{max}$ ↔	
	3.00	.011	.014	.008	.010	.007	.008	-	-	-	-
	4.00	.013	.016	.009	.011	.007	.009	.006	.008	-	-
	5.00	.014	.018	.010	.013	.008	.011	.007	.009	.006	.008
	6.00	.016	.020	.011	.014	.009	.012	.008	.010	.007	.009
	8.00	.017	.022	.013	.016	.010	.013	.009	.011	.008	.010
		.000	.000	.000	.000	.000	.000	.000	.000	.000	.000
	2.50	.010	.013	.007	.009	.006	.007	.005	.007	.005	.006
	3.00	.011	.014	.008	.010	.007	.008	.006	.007	.005	.007
	4.00	.013	.016	.009	.011	.007	.009	.006	.008	.006	.007
	5.00	.014	.018	.010	.013	.008	.011	.007	.009	.006	.008
	6.00	.016	.020	.011	.014	.009	.012	.008	.010	.007	.009

A similar solution is used for cylindrical milling cutters with teeth in a helix (porcupine cutters etc.). These also have recommended minimum and maximum feed values with regard to  $a_e$  in [in].

Se utiliza una solución similar para fresas cilíndricas con dientes en una hélice (fresas de cocodrilo, etc.). Esto también proporciona valores de avance mínimo y máximo en relación con  $a_e$  en [in].

Une solution similaire est utilisée pour les fraises cylindriques avec dents en hélice (fraises type "hérissón"). Elles ont également des valeurs d'avance minimale et maximale recommandées en fonction de la valeur  $a_e$  en [in].

Table / Tabla / Tableau 7

$a_e$		0.05		0.10		0.20		0.30		0.40		0.60		0.80	
D	$f_{min}$ ↔	$f_{max}$ ↔	$f_{min}$ ↔	$f_{max}$ ↔	$f_{min}$ ↔	$f_{max}$ ↔	$f_{min}$ ↔	$f_{max}$ ↔	$f_{min}$ ↔	$f_{max}$ ↔	$f_{min}$ ↔	$f_{max}$ ↔	$f_{min}$ ↔	$f_{max}$ ↔	
1.00	.010	.016	.006	.010	.005	.007	.004	.006	.004	.006	.003	.005	.003	.004	
1.25	.011	.018	.007	.011	.005	.008	.004	.007	.004	.006	.003	.005	.003	.005	
1.50	.013	.020	.008	.013	.006	.009	.005	.007	.004	.007	.004	.006	.003	.005	
2.00	.014	.022	.009	.014	.006	.010	.005	.008	.005	.007	.004	.006	.004	.006	

$a_e$		1.00		1.25		1.50		2.00	
D	$f_{min}$ ↔	$f_{max}$ ↔	$f_{min}$ ↔	$f_{max}$ ↔	$f_{min}$ ↔	$f_{max}$ ↔	$f_{min}$ ↔	$f_{max}$ ↔	
1.00	.003	.005	-	-	-	-	-	-	
1.25	.003	.004	.003	.005	-	-	-	-	
1.50	.003	.005	.003	.004	.003	.005	-	-	
2.00	.003	.005	.003	.005	.003	.004	.003	.005	

However, the table of corrections for cutting speed no longer applies here. **On the contrary:** as  $a_e$  increases, we recommend reducing the cutting speed to up to ca 25 % with full width and maximum depth of cut.

Por tanto, la tabla de correcciones para la velocidad de corte no se aplica aquí. **Al contrario,** al incrementarse  $a_e$ , recomendamos reducir la velocidad de corte hasta un 25 % con todo el ancho y la máxima profundidad de corte.

The exact same method is used with milling cutters for T-slots, with the difference that starting values are in this case divided into three sections: shoulder milling, rear face milling and T-slot milling.

Se utiliza exactamente el mismo método con fresas para ranuras en T, con la diferencia de que los valores iniciales están en este caso divididos en tres secciones: escuadrado, fresado trasero y ranurado en T.

Cependant, le tableau des corrections pour la vitesse de coupe ne s'applique plus ici. **Au contraire:** à mesure que  $a_e$  augmente, nous recommandons de réduire la vitesse de coupe jusqu'à environ 25 % en situation d'engagement de fraise total ( $a_e = D$ ) et profondeur maximale de coupe ( $a_{pmax}$ ).

La même méthode est utilisée avec les fraises pour rainures en T, à la différence que les valeurs de départ sont dans ce cas divisées en trois sections: fraisage d'épaulement, fraisage de face arrière et fraisage de rainure en T.

Perform shoulder milling with end mills using the recommendations given in the previous section. For slot milling, use the table included in the technical section following the milling cutter group. The table contains the starting feed values for minimum, average and maximum depth of cut.

Realizar un escuadrado con una fresa de ranurado usando las recomendaciones dadas en la sección anterior. Para ranurado, utilizar la tabla incluida en la sección técnica siguiendo el grupo de fresas. La tabla contiene valores iniciales de avance para una profundidad de corte mínima, media y máxima.

Effectuer le fraisage d'épaulement en utilisant les recommandations données dans la section précédente. Pour le rainurage, utilisez le tableau figurant dans la section technique en respectant le groupe d'outil. Le tableau contient les valeurs d'avance de départ pour les profondeurs de passe minimum, moyenne et maximale.

Table / Tabla / Tableau 8



	.039	.236	.512
	.011	.007	.004

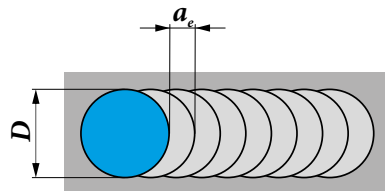
Table / Tabla / Tableau 8

The method of plunging (slotting) can also be used for slot milling. Follow the instructions provided in the grooving section.

La tecnología de fresado axial (plunging) se puede utilizar también para ranurado. Siga las instrucciones proporcionadas en la sección de ranurado.

La technique de tréflage peut également être utilisée pour le fraisage de rainures. Suivre les instructions fournies dans la section rainurage.

Picture / Figura / Image 19

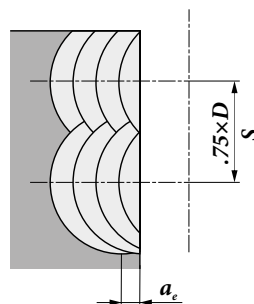


For machining wider slots by plunging, the mutual movement between particular steps (S) should not exceed ¾ of milling cutter diameter.

Para mecanizar ranuras más anchas, el movimiento entre los pasos (S) no debe ser mayor de ¾ el diámetro de la fresa.

Pour l'usinage de rainures plus larges en tréflage, le mouvement alternatif à programmer entre chaque passe (S) ne doit pas dépasser ¾ du diamètre de la fraise.

Picture / Figura / Image 20





**PROGRESSIVE PLUNGING / FRESADO PROGRESIVO / PLONGÉE PROGRESSIVE**

The limiting factor in this case is the construction of the tool or the insert itself. Thus, we are using the maximum permissible plunging depth valid in general for the entire group.

La limitación en este caso es la propia construcción de la fresa o la plaquita en sí. Por tanto estamos utilizando la máxima profundidad axial permisible válida en general para todo el grupo.

Le facteur limitant dans ce cas est la construction de l'outil ou de la plaquette elle-même. Ainsi, nous utilisons la profondeur de plongée maximale admissible valable en général pour l'ensemble du groupe.



**RAMPING / FRESADO EN RAMPA / RAMPING**

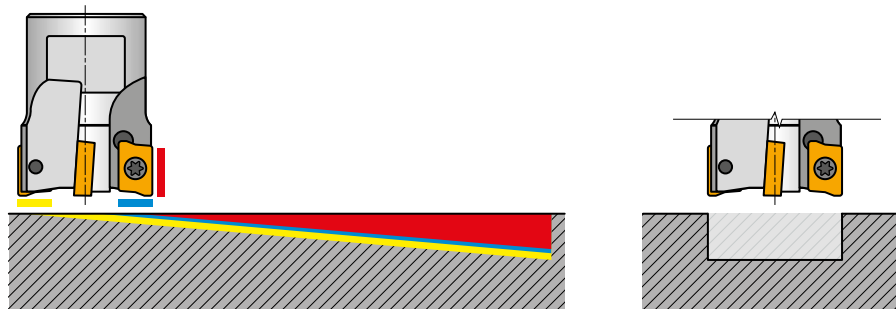
Ramping, i.e. two-axis progressive sinking, is a process that simultaneously applies three different cutting methods:

El fresado en rampa, es decir, la penetración progresiva en dos ejes, es una tecnología que aplica simultáneamente tres métodos de corte diferentes:

Le raming, c'est-à-dire la plongée progressive suivant deux axes de déplacement, est une technique qui utilise simultanément trois méthodes de coupe différentes:

Picture / Figura / Image 21

- Front insert – cut with the primary edge (tool periphery) / Plaquette frontal – corta con el filo primario (perifería de la herramienta)  
Plaquette avant – coupe avec l'arête primaire (périphérie de l'outil)
- Front insert – cut with the secondary edge (tool face) / Plaquette frontal – corta con el filo secundario (frente de la herramienta)  
Plaquette avant – coupe avec l'arête secondaire (face de l'outil)
- Rear insert – cut with the secondary edge (tool face) / Plaquette trasera – corta con el filo secundario (frente de la herramienta)  
Plaquette arrière – coupe avec l'arête secondaire (face de l'outil)



A very important fact here is the angle of descent, respectively decline in the Z-axis on that section.

Aquí es muy importante el ángulo de descenso, disminución en el eje Z en esta sección.

Some tools (HFC) allow descent at a smaller angle, but larger feed, or using larger angle of descent with lower feed.

Algunas herramientas (alto avance, HFC) permiten descender con un ángulo menor pero a mayor avance, o utilizando un ángulo mayor con menor avance.

The gradient of descent (ramp angle) recommended for different cutter styles can be found in the technical section.

Estos ángulos y los respectivos valores de descenso en una sección determinada se pueden encontrar en las recomendaciones técnicas.

Un paramètre très important est ici l'angle de descente, représenté par le déplacement d'outil dans l'axe Z sur la section ci-dessus.

Certains outils (grande avance HFC) permettent une descente à un angle plus petit, mais avec une avance plus importante, ou en utilisant un angle de descente plus grand avec une avance réduite.

Ces valeurs d'angles de descente pour un diamètre d'outil donné peuvent être trouvées dans les recommandations techniques.

Table / Tabla / Tableau 9

			HFC		
	$\alpha_{max}^{\circ}$	$a_p/l$	$\alpha_{max}^{\circ}$	$\alpha_{max}^{\circ}$	$a_p/l$
1.00	12.5	.50/2.50	4.0	8.0	.05/.75
1.25	7.5	.50/4.00	2.0	7.5	.05/1.50
1.50	5.0	.35/4.00	1.2	4.5	.05/2.60
2.00	3.5	.25/4.00	0.8	3.0	.05/4.00
2.50	2.5	.20/4.00	0.5	2.0	.03/4.00
3.00	2.0	.15/4.00	0.4	1.5	.02/4.00

When choosing feed, we advise following the recommendations provided for slot milling. If the slot is deeper (i.e. first pass at an angle, second to level off), you must choose one of four basic programme variants for the consecutive steps:

Al elegir el avance, aconsejamos seguir las recomendaciones proporcionadas para ranurado. Si la ranura es más profunda (es decir, primera pasada a un ángulo, segunda pasada para nivelar), se debe elegir una de estas cuatro programaciones básicas para los pasos consecutivos:

Lorsque vous choisissez l'avance, nous vous conseillons de suivre les recommandations fournies pour le fraisage de rainures. Si la rainure est profonde et ne peut être réalisée en une seule passe (c'est-à-dire que la première passe suit un angle, la seconde reste dans le même plan), vous devez choisir une des quatre variantes de programmation de base suivantes pour chaque étape consécutive:

Picture / Figura / Image 22



	Down at max. angle and back straight and again down at max. angle and back straight... Bajar con el ángulo máx. y volver recto, bajar otra vez con el ángulo máx. y volver recto... Descente à angle max. et retour dans le même plan, puis de nouveau répéter le même cycle...
	There and back at a smaller (half) angle and last exit straight. Ir y volver con un ángulo menor (la mitad) y la última pasada recta. Descente aller et retour avec des angles de pente plus faibles et réguliers, puis dernière passe dans le même plan.
	Down at max. angle, back straight by length D and then down at max. angle, repeat straight... Bajar con el ángulo máx., volver recto una longitud igual a D y bajar otra vez con el ángulo máx., de nuevo volver recto... Descente à angle max. et retour dans le même plan sur une longueur égale au diamètre de la fraise, puis de nouveau descente à angle max. et répéter le même cycle...
	Down at max. angle, then up by length X and back down at max. angle. Bajar con el ángulo máx., luego subir la longitud X y volver a bajar otra vez con el ángulo máx. Descente à angle max. puis remonter la fraise d'une longueur X et à nouveau plonger à angle max. recommandé.

$$X = \operatorname{tg} \alpha (D - 2b)$$

Where:

- X rebound (step) [in]
- $\alpha$  angle of descent [°]
- D milling cutter diameter [in]
- b insert width [in]

Où:

- X rebond (pas) [in]
- $\alpha$  angle de descente [°]
- D diamètre de la fraise [in]
- b largeur de la plaquette [in]

Donde:

- X rebote (paso) [in]
- $\alpha$  ángulo de descenso [°]
- D diámetro de la fresa [in]
- b ancho de la plaquita [in]



**CIRCULAR OR HELICAL INTERPOLATION MILLING / INTERPOLACIÓN CIRCULAR O HELICOIDAL  
FRAISAGE PAR INTERPOLATION CIRCULAIRE OU HÉLICOÏDALE**

The method is basically analogous to ramping. In this case, one of the most important factors is milling cutter diameter or minimum and maximum diameter of hole we are able to machine with the given milling cutter type (this information is vital only when using milling cutters without central cutting edges).

If the milling cutter diameter is too large, the trajectory of the cutting edge insert does not pass through the axis of the hole, resulting in a protrusion which collides with the tool face and can cause the destruction of the tool.

On the other hand, if the diameter of the milling cutter is too small, the core will remain inside the hole axis and must then be milled off afterwards.

La méthode est en fait analogue au ramping. Dans ce cas, l'un des critères les plus importants est le diamètre de la fraise ou le diamètre minimum et maximum du trou qu'il est possible d'usiner avec le type de fraise donné (ces informations sont vitales uniquement en utilisation de fraises sans arêtes de coupe au centre).

Si le diamètre de la fraise est trop grand, la trajectoire de l'arête de coupe de la plaquette ne traversera pas l'axe du trou à réaliser, ce qui entraînera un surplus de matière au centre qui finira par heurter la face avant de l'outil et pourra provoquer sa destruction.

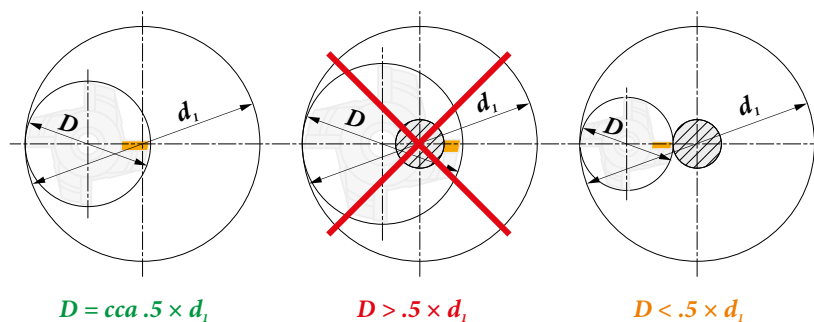
D'autre part, si le diamètre de la fraise est trop petit, un noyau de matière subsistera au centre du trou et devra être réusiné par la suite.

Este método es básicamente análogo al fresado en rampa. En este caso, uno de los factores más importantes es el diámetro de la fresa o el diámetro mínimo y máximo del agujero que somos capaces de mecanizar con un tipo de fresa determinada (esta información es vital sólo cuando se utilizan fresas sin filos de corte centrales).

Si el diámetro de la fresa es demasiado grande, la trayectoria del filo de corte no pasa por el eje del agujero, dando como resultado una protuberancia que colisiona con la cara de la herramienta y que puede causar su destrucción.

Por otro lado, si el diámetro de la fresa es demasiado pequeño, el material central permanece dentro en el eje del agujero y debe ser fresado posteriormente.

Picture / Figura / Image 23



Therefore, recommendations include tables listing minimum hole diameter values, maximum hole diameter values, and in-axis descent angle values corresponding to these diameters (in some cases there will be two tables: one for standard insert geometry and another for HFC).

Por tanto, las recomendaciones incluyen tablas con valores de diámetros mínimos de agujero, valores de diámetros máximos de agujero y valores de ángulos de descenso correspondientes a esos diámetros (en algunos casos hay dos tablas: una para geometría estándar de plaqueta y otra para HFC, alto avance).

Par conséquent, les recommandations comprennent des tableaux indiquant les valeurs minimales de diamètre de trou, les valeurs maximales de diamètre de trou et des valeurs d'angle de descente axiale correspondant à ces diamètres (dans certains cas, il y aura deux tableaux: l'un adapté à une géométrie de plaquette standard et l'autre pour le fraisage grande avance HFC).

Table / Tabla / Tableau 10

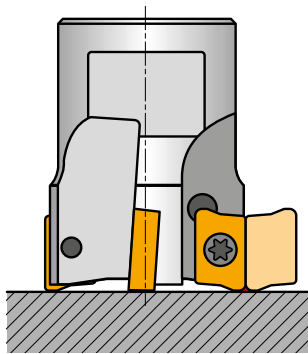
					HFC			
	$d_{min}$	$d_{max}$			$d_{min}$	$d_{max}$		
1.00	1.65	1.97	.39	.49	1.65	1.97	.05	.05
1.25	2.17	2.52	.26	.35	2.17	2.52	.05	.05
1.50	2.83	3.15	.20	.31	2.83	3.15	.05	.05
2.00	3.62	3.94	.18	.24	3.62	3.94	.05	.05
2.50	4.65	4.96	.16	.20	4.65	4.96	.05	.05
3.00	5.35	6.30	.06	.08	5.35	6.30	.05	.05

The following figure schematically explains the methodology of diameter calculation.

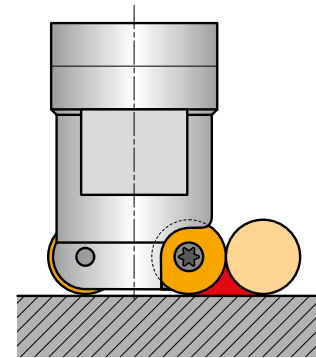
La siguiente figura explica esquemáticamente la metodología del cálculo del diámetro.

La figure suivante explique schématiquement la méthodologie de calcul du diamètre d'outil.

Picture / Figura / Image 24



- $D_{max}$  – hole diameter / diámetro del agujero / diamètre du trou
- $D$  – milling cutter diameter / diámetro de la fresa / diamètre de la fraise
- $d$  – insert diameter / diámetro de plaqueta / diamètre de la plaquette
- $r_c$  – insert radius / radio de plaqueta / rayon de la plaquette
- $X$  – wiper segment size / tamaño de faceta rascadora / taille du plat de planage
- $b$  – max.  $a_c$  for grooving / max.  $a_c$  para ranurado / valeur max. de  $a_c$



**Maximum hole diameter / Diámetro máximo del agujero / Diamètre de trou maximum**

For through hole:  
Para agujero pasante:  
Pour trou débouchant:

$$D_{max} = 2 \cdot D$$

$$D_{max} = 2 \cdot D$$

For blind holes, you can achieve a flat bottom by having the tool pass over the bottom's center.  
Para agujeros ciegos, se puede producir un fondo plano haciendo pasar la herramienta por el centro del fondo.  
Pour un trou borgne, vous pouvez obtenir une surface à fond plat en faisant passer l'outil sur le centre du trou.

**Minimum hole diameter / Diámetro mínimo del agujero / Diamètre de trou minimum**

For through hole:  
Para agujero pasante:  
Pour trou débouchant:

$$D_{min} = (D - b) \cdot 2$$

$$D_{min} = (D - 0.8d) \cdot 2$$

For flat bottom:  
Para fondo plano:  
Pour trou borgne (fond plat):

$$D_{min} = (D - (r_c + x)) \cdot 2$$

$$D_{min} = (D - 0.5d) \cdot 2$$

When choosing feed, we advise following the recommendations given for slot milling.

Para elegir el avance, aconsejamos seguir las recomendaciones dadas para ranurado.

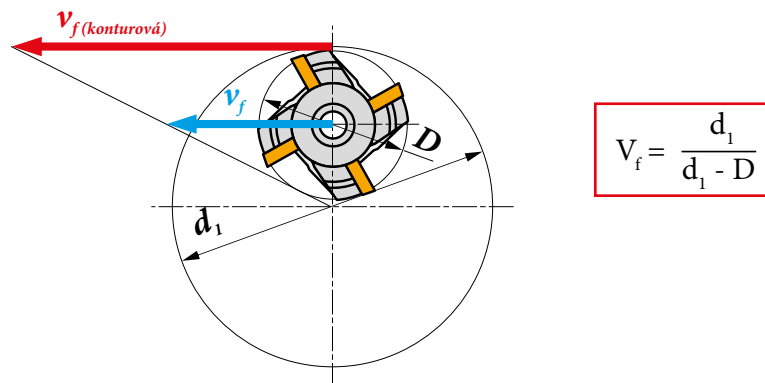
**ATTENTION:** It is necessary to use correction for circular interpolation (normally programmed to tool center, but feed is significantly higher during internal circular interpolation)!

**ATENCIÓN:** Es necesario usar correcciones para interpolación circular (normalmente programada al centro de la herramienta, pero el avance es significativamente mayor durante la interpolación circular interna)!

Lors du choix de l'avance, nous conseillons de suivre les recommandations données pour le rainurage.

**ATTENTION:** Il est nécessaire d'utiliser un facteur de correction pour l'interpolation circulaire (normalement programmée au centre de l'outil, mais l'avance est significativement plus élevée dans le cas d'une interpolation circulaire intérieure)!

Picture / Figura / Image 25



**CHAMFER MILLING / FRESADO DE CHAFLANES / FRAISAGE DE CHANFREIN**

The essential issues are the coefficient which multiplies cutting speed and the starting feed you should use if you want to mill a chamfer corresponding to maximum depth of cut  $\times 45^\circ$ . Chamfering requires proper choice of cutting speed and, above all, choice of feed based on the nature of engagement.

Los puntos esenciales son el coeficiente con múltiples velocidades de corte y los avances iniciales que deberían ser utilizados si se quiere mecanizar un chaflán a máxima profundidad de corte  $\times 45^\circ$ . La operación de achaflanado requiere una correcta elección de la velocidad de corte y, sobre todo, elegir el avance en función del trabajo.

Les problèmes essentiels sont le coefficient qui multiplie la vitesse de coupe et la vitesse d'avance que vous devez utiliser si vous souhaitez usiner un chanfrein correspondant à la profondeur maximale de coupe  $\times 45^\circ$ . Le chanfreinage nécessite un choix approprié de la vitesse de coupe et, surtout, un choix d'avance basé sur la nature de l'engagement d'outil.

Table / Tabla / Tableau 11

2.00	1.35	.014
2.50	1.39	.016
3.00	1.44	.018
4.00	1.48	.020
5.00	1.53	.022
6.00	1.58	.025

For tools suited purely for chamfer milling, we have prepared tables combining applications from chamfer milling to face milling. They list ranges of recommended feed (minimum, starting and maximum) for the given  $a_e/D$  ratio. Furthermore, they include the correction factor for cutting speed that you can (but do not have to) use.

Para herramientas adecuadas especialmente para achaflanado, hemos preparado tablas combinando aplicaciones de fresado de chaflanes a fresado frontal o planeado. Se indican gamas de avances recomendados (mínimo, inicial y máximo) para la relación  $a_e/D$  dada. Además se incluye el factor de corrección para la velocidad de corte que se puede (no necesariamente) usar.

Pour les outils conçus à la base pour le fraisage de chanfreins, nous vous avons préparé des tableaux combinant les applications de fraisage de chanfrein au fraisage de faces. Ils indiquent les plages d'avance recommandées (minimum de départ et maximum) pour un rapport  $a_e/D$  donné. En outre, ils incluent le facteur de correction pour la vitesse de coupe que vous pouvez utiliser (sans obligation).

Table / Tabla / Tableau 12

$a_e/D$	.10		.15		.20		.25		.30		.35		.40		.50-1.0									
	$f \rightarrow$																							
15	.024	.039	.053	.020	.031	.043	.017	.027	.037	.015	.024	.033	.014	.022	.031	.013	.020	.028	.012	.019	.026	.011	.017	.024
25	.015	.024	.032	.012	.019	.026	.010	.017	.023	.009	.015	.020	.009	.014	.019	.008	.013	.017	.007	.012	.016	.007	.011	.015
30	.013	.020	.028	.010	.016	.022	.009	.014	.019	.008	.013	.017	.007	.011	.016	.007	.011	.015	.006	.010	.014	.006	.009	.012
35	.011	.017	.024	.009	.014	.020	.007	.012	.017	.007	.011	.015	.006	.010	.014	.006	.009	.013	.006	.009	.012	.005	.008	.011
40	.010	.015	.021	.008	.013	.017	.007	.011	.015	.006	.010	.013	.006	.009	.012	.005	.008	.011	.005	.008	.011	.004	.007	.009
45	.009	.014	.019	.007	.011	.016	.006	.010	.014	.006	.009	.012	.005	.008	.011	.005	.007	.010	.004	.007	.010	.004	.006	.009
50	.008	.013	.018	.007	.011	.015	.006	.009	.013	.005	.008	.011	.005	.007	.010	.004	.007	.009	.004	.007	.009	.004	.006	.008
55	.007	.012	.017	.006	.010	.014	.006	.009	.012	.005	.008	.011	.004	.007	.010	.004	.007	.009	.004	.006	.008	.004	.006	.007
60	.007	.011	.016	.006	.009	.013	.005	.008	.011	.005	.007	.010	.004	.007	.009	.004	.006	.008	.004	.006	.008	.003	.005	.007
75	.006	.010	.014	.005	.008	.011	.005	.007	.010	.004	.007	.009	.004	.006	.008	.004	.006	.007	.003	.005	.007	.003	.005	.006
	1.35		1.27		1.22		1.19		1.16		1.13		1.11		1.00									



MILLING OF FREE FORM SURFACES (COPY MILLING) / FRESADO EN COPIA (COPIADO) / FRAISAGE DE FORMES COMPLEXES (COPIAGE 3D)

This is one of the most demanding operations in terms of milling applications. The main issue is the frequent change in both cutting and working conditions. These operations are performed in the vast majority of cases using toroidal (radius) or ball-nose milling cutters. To facilitate the correct use of these tools, we have included the following supporting materials in the technical section after the given tool group.

**Toroidal Milling Cutters**

One of the first pieces of data you will find here is the effective milling cutter diameter with regard to depth of cut. Zero depth is included on purpose to show where a toroidal milling cutter can still create a flat bottom (that is important with respect to the correct choice of  $a_e$  when milling larger surfaces).

Une des opérations les plus exigeantes en termes de technologie. L'enjeu principal est le changement fréquent des conditions de coupe et de travail. Ces opérations sont effectuées dans la grande majorité des cas à l'aide de fraises toroïdales (rayon) ou de fraises à bout sphérique. Afin de faciliter l'utilisation correcte de ces outils, nous avons inclus les supports suivants dans la section technique pour chaque groupe d'outils.

**Fraises Toroïdales**

L'une des premières données que vous trouverez ici est le diamètre de coupe effectif de la fraise en fonction de la profondeur de coupe. La profondeur zéro est incluse volontairement afin de montrer la largeur de surface plane qu'une fraise toroïdale est capable de générer (ce qui est important pour un choix approprié de  $a_e$  lors du fraisage de plus grandes surfaces).

Table / Tabla / Tableau 13

$D$	$a_p$	.00	.01	.02	.03	.04	.05	.06	.08	.10	.12	.16	.20	.24	.28	.31
2.50		1.850	2.020	2.071	2.118	2.154	2.189	2.217	2.268	2.307	2.343	2.398	2.433	2.461	2.476	2.480
3.00		2.520	2.689	2.740	2.787	2.823	2.858	2.886	2.937	2.976	3.012	3.067	3.102	3.130	3.146	3.150
4.00		3.307	3.476	3.528	3.575	3.610	3.646	3.673	3.724	3.764	3.799	3.854	3.890	3.917	3.933	3.937



For toroidal milling cutters, a table follows listing the starting feed values with regard to depth of cut (at small depth of cut, chip thickness is very low; this could mean that the milling cutter would be “rubbing” rather than cutting when working with soft materials in particular).

Para fresas toroidales, esta tabla muestra los valores de avance en relación con la profundidad de corte (a pequeña profundidad de corte, el espesor de viruta es muy pequeño; esto puede significar que la fresa esté “rozando” en lugar de cortando, particularmente con materiales blandos).

Pour les fraises toroïdales, le tableau suivant indique les valeurs de départ d’avance par rapport à la profondeur de coupe (à petite profondeur de coupe, l’épaisseur des copeaux est très faible; et dans ce cas de figure l’outil froterait la matière au lieu de la couper, en particulier en usinage de matériaux mous).

Table / Tabla / Tableau 14

	.000	.012	.020	.030	.039	.049	.059	.079	.098	.118	.157	.197	.236	.276	.315
	–	.043	.033	.028	.024	.021	.020	.017	.015	.014	.012	.011	.010	.010	.009

Another piece of data which could facilitate your use of toroidal milling cutters is listed in tables related to the choice of milling strategy. It is basically a comparison of the strategy of transverse and peripheral slotting. In these tables, you will find the so-called slotting step which you must use to achieve the required roughness (cusp height) of the surface (in micrometers).

Otro dato que puede facilitar el uso de fresas toroidales está en tablas relativas a la elección de la estrategia de fresado. Es básicamente una comparación de las estrategias de fresado transversal y periférico. En esas tablas se puede encontrar el llamado “paso” que se debe utilizar para alcanzar la rugosidad requerida de la superficie (en micrómetros).

Un autre élément d’information qui peut faciliter votre utilisation des fraises toroïdales est énuméré dans les tableaux relatifs au choix de la stratégie de fraisage. Il s’agit essentiellement d’une comparaison des stratégies de fraisage transversale et périphérique. Dans ces tableaux, vous trouverez la valeur de l’intervalle de balayage que vous devez utiliser pour obtenir la rugosité requise (hauteur de crête) de la surface usinée (en microns).

Table / Tabla / Tableau 15

	$\mu\text{m}$	118	197	394	590	787
.500		.015	.019	.027	.033	.039
.625		.017	.022	.031	.039	.045
.750		.019	.025	.035	.043	.050
	$\mu\text{m}$	118	197	394	590	787
.05		.007	.009	.013	.016	.018
.06		.008	.010	.014	.017	.020
.08		.009	.011	.016	.019	.022
.12		.011	.014	.019	.024	.027
.16		.012	.016	.022	.027	.031

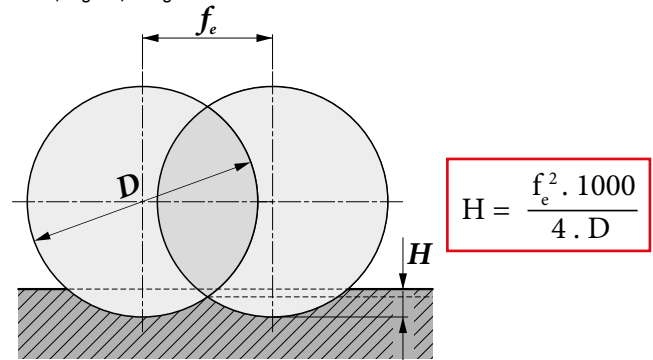
Where:  $f_e$  slotting step [in]  
D diameter [in]

The same formula is used in both cases. For conventional (peripheral) slotting D is substituted with insert diameter, while for transverse slotting D is substituted with milling cutter diameter.

Où:  $f_e$  valeur du pas ou intervalle de balayage [in]  
D diamètre [in]

La même formule est utilisée dans les deux cas. Pour les rainures conventionnelles (périphériques), D est substitué au diamètre de plaquette, tandis que pour une rainure transversale D est substitué au diamètre de la fraise.

Picture / Figura / Image 26



Donde:  $f_e$  paso [in]  
D diámetro [in]

Se utiliza la misma fórmula en ambos casos. Para fresado convencional (periférico), D se sustituye por el diámetro de la plaqueta, mientras que para fresado transversal, D se sustituye por el diámetro de la fresa.

### Ball-nose Milling Cutters

One of the first pieces of information included here is once again the actual cutting diameter value with regard to depth of cut, with all values listed in mm.

### Fresas de Punta Esférica

Una de las primeras informaciones incluidas aquí, es una vez más el diámetro de corte en función de la profundidad de corte, con todos los valores en mm.

### Fraises à bout sphérique

L'un des premiers éléments d'information inclus ici est une fois de plus le diamètre de coupe effectif en fonction de la profondeur de coupe, toutes les valeurs étant indiquées en mm.

Table / Tabla / Tableau 16

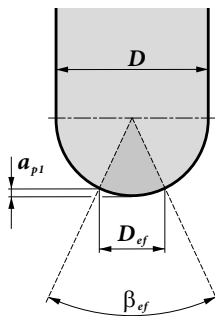
		.012	.016	.020	.028	.039	.049	.059	.079	.098	.118	.157	.197	.236	.315	.394	.472	.591	.630
.3125		.118	.138	.154	.177	.209	.228	.244	.272	.291	.303	.315	-	-	-	-	-	-	-
.3750		.134	.154	.173	.201	.236	.260	.280	.315	.343	.362	.386	.394	-	-	-	-	-	-
.5000		.146	.169	.189	.220	.260	.287	.311	.350	.382	.409	.445	.465	.472	-	-	-	-	-
.6250		.169	.197	.220	.256	.303	.339	.366	.417	.457	.492	.547	.583	.610	.630	-	-	-	-
.7500		.193	.220	.244	.291	.343	.382	.413	.472	.520	.563	.630	.681	.720	.772	.787	-	-	-
1.000		.213	.248	.276	.323	.386	.429	.469	.535	.591	.638	.720	.787	.843	.917	.965	.984	-	-
1.250		.243	.280	.313	.369	.439	.488	.533	.610	.676	.734	.833	.915	.983	1.091	1.168	1.220	1.257	1.260

Furthermore, you will find information on which milling cutter section (only for L2-SZP, K3-CXP) utilizes only one edge.

Además se puede encontrar información de qué sección de fresa (sólo para L2-SZP, K3-CXP) utiliza sólo un filo.

En outre, vous trouverez des informations relatives à quelle section de fraise (uniquement pour L2-SZP, K3-CXP) utilise une seule arête.

Picture / Figura / Image 27



Similarly to toroidal milling cutters, this information is followed by data on what slotting step to use in order to achieve the required surface roughness (it does not matter whether the slotting is transverse or longitudinal here).






Igual que en las fresas toroidales, esta información está acompañada de datos sobre qué paso utilizar para alcanzar la rugosidad superficial requerida (aquí no importa si el fresado es transversal o longitudinal).

De la même manière que pour les fraises toroïdales, cette information est suivie par des données sur l'intervalle de balayage à utiliser pour obtenir la rugosité de surface requise (peu importe si la rainure est transversale ou longitudinale ici).








Table / Tabla / Tableau 17

D [in]		$\beta_{ef}$ [°]	$D_{ef}$ [in]	$a_p$ [in]
.375	FM	41	.138	.013
.500	FM	41	.165	.015
.625	FM	42	.223	.020
.750	FM	42	.280	.026
1.00	FM	41	.345	.031
1.50	R	41	.555	.051
2.00	R	45	.755	.075

Table / Tabla / Tableau 18

 $D$	 $\mu\text{m}$	118	197	394	590	787	1181	1574	1968	2361	3148	3935
.500		.015	.019	.027	.033	.039	.047	.055	.061	.067	.077	.086
.625		.017	.022	.031	.039	.045	.055	.063	.070	.077	.089	.100
.750		.019	.025	.035	.043	.050	.061	.070	.079	.086	.100	.111



 $r_\epsilon$	 $\mu\text{m}$	118	197	394	590	787	1181	1574	1968	2361	3148	3935
.05		.007	.009	.013	.016	.018	.022	.025	.028	.031	.036	.040
.06		.008	.010	.014	.017	.020	.024	.028	.031	.034	.040	.045
.08		.009	.011	.016	.019	.022	.027	.031	.035	.039	.045	.050
.12		.011	.014	.019	.024	.027	.033	.039	.043	.047	.055	.061
.16		.012	.016	.022	.027	.031	.039	.045	.050	.055	.063	.070

The final values listed are cutting speed correction values for tool overhang:

Los valores finales listados son valores de corrección de la velocidad de corte para el voladizo de la herramienta:

Les valeurs finales indiquées sont des valeurs de correction de vitesse de coupe en fonction du porte-à-faux de l'outil:

Table / Tabla / Tableau 19

 $x \cdot D$	Tool overhang (multiples of diameter D) Voladizo de la herramienta (múltiplos del diámetro D) Porte-à-faux de l'outil (multiples du diamètre D)	<3	3 – 4	4 – 6	>6
 $x \cdot v$	Multiple coefficient for speed Coeficiente para la velocidad Coefficient multiplicateur pour la vitesse de coupe	1	.9	.7	.5

During the process of milling, the milling cutter blade operates almost always in interrupted cut conditions. Within a single revolution of the tool, each blade enters the workpiece at least once and exits the cut once.

In addition, the chip thickness periodically changes during a single milling cutter revolution. That also results in fluctuations in the size and direction of the tangential component of the cutting force. The milling cutter blade is therefore exposed to cyclic stress which leads to specific wear of the edge.

The durability of the milling cutter edge is therefore dependent on the conditions in which the blade enters and exits the workpiece. Proper selection of these conditions significantly affects the process and result of milling in terms of cutting power and quality of the machined surface.

At the moment of entering the workpiece, the edge is subject to more or less intense mechanical impact which causes mechanical stress in the immediate vicinity of the edge. If the engagement conditions are chosen incorrectly, this impact can cause brittle damage to the edge either in the form of fracture or crumbling of the edge.

Even for tools with indexable inserts, we recommend down (climb) milling (i.e. edge cuts up to the maximum chip thickness).

Durant le processus de fraisage, l'outil fonctionne presque toujours en conditions de coupe interrompues. Pendant une rotation d'outil, chaque dent entre dans la pièce au moins une fois et quitte la matière une fois.

De plus, l'épaisseur de copeaux change constamment lors de chaque rotation de la fraise. Cela induit des fluctuations de dimension et de direction dans la résultante tangentielle de la force de coupe. Le corps de fraise est donc exposé à des contraintes cycliques qui conduisent à une usure caractéristique des arêtes de coupe.

La durée de vie des arêtes de coupe de la fraise dépend donc des conditions dans lesquelles l'outil entre et sort de la pièce à usiner. Un choix approprié de ces conditions affecte de façon significative le processus et le résultat du fraisage en termes de puissance de coupe et de qualité de la surface obtenue.

Au moment de l'entrée dans la matière, la plaquette de coupe est sujette à des impacts mécaniques plus ou moins intenses qui provoquent des contraintes mécaniques à proximité immédiate de l'arête de coupe. Si les conditions d'engagement de l'outil sont choisies incorrectement, cet impact peut provoquer une détérioration des plaquettes sous la forme d'une rupture ou d'un effondrement de l'arête de coupe.

Même pour les outils à plaquettes indexables, nous recommandons la méthode de fraisage en „avalant“ (c'est-à-dire que l'arête de coupe pénètre dans la matière au point d'épaisseur maximale du copeau).

Durante el proceso de fresado, cada diente de la fresa opera casi siempre en corte interrumpido. Por cada revolución de la herramienta, cada diente entra en la pieza al menos una vez y se produce corte una vez.

Además, el espesor de viruta va variando en cada revolución de la fresa. Como resultado se producen fluctuaciones en el tamaño y la dirección de la componente tangencial de la fuerza de corte. Por tanto cada diente de la fresa está expuesto cíclicamente a una tensión que provoca un desgaste específico del filo de corte.

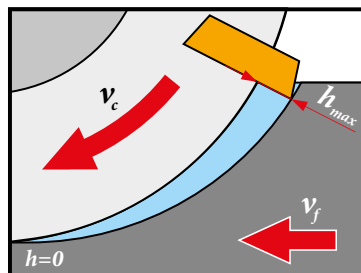
La duración del filo de corte depende por tanto de las condiciones en las que el diente entra y sale de la pieza. Una selección adecuada de estas condiciones afecta significativamente al proceso y al resultado del fresado en términos de potencia de corte y calidad de la superficie mecanizada.

En el momento de la entrada en la pieza, el filo está sometido a un impacto mecánico más o menos intenso que produce una tensión mecánica en la zona inmediatamente posterior al filo de corte. Si las condiciones de trabajo no se han elegido correctamente, este impacto puede producir la rotura del filo en forma de fractura o de desmoronamiento.

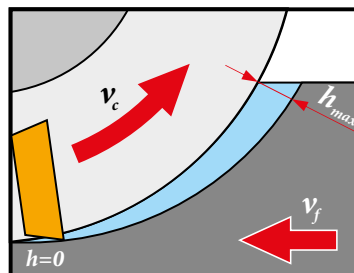
Para fresado con plaquita intercambiable recomendamos el fresado ascendente (es decir, el filo corta desde el espesor máximo de viruta).

Picture / Figura / Image 5

**DOWN (CLIMB) MILLING  
FRESADO ASCENDENTE  
FRAISAGE EN „AVALANT“**



**UP (CONVENTIONAL) MILLING  
FRESADO CONVENCIONAL  
FRAISAGE EN „OPPOSITION“**



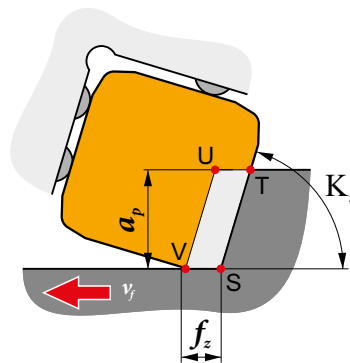
CUTTING CONDITIONS WHEN MILLING  
CONDICIONES DE CORTE EN FRESADO  
CONDITIONS DE COUPE EN FRAISAGE

Furthermore, the place of first contact between the edge and the workpiece should lie further from the insert's tip. However, the position depends on both the basic geometry of the inserts, i.e. angles  $\gamma_o$ ,  $\lambda_s$ ,  $\kappa_r$  and the mutual position of the milling cutter axis and the entry edge of the workpiece.

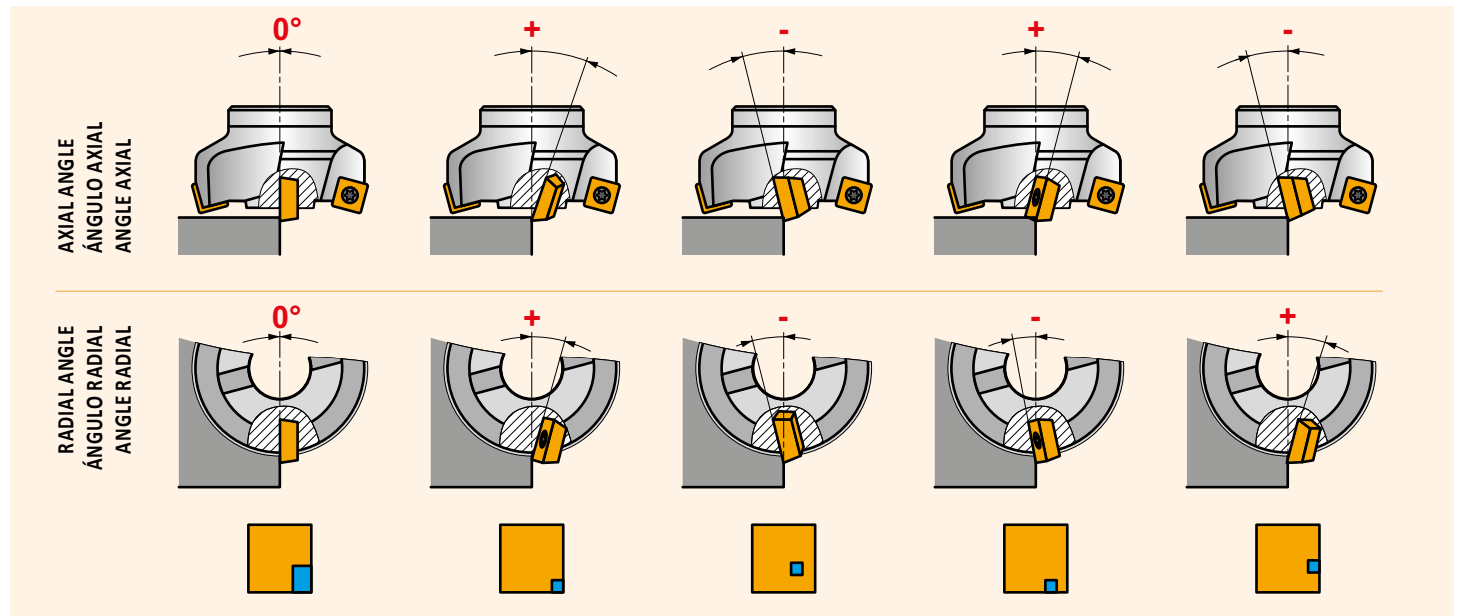
Además, el lugar del primer contacto entre el filo y la pieza debe estar alejado de la punta de la plaquita. Sin embargo, la posición depende de la geometría básica de la plaquita, es decir, ángulos  $\gamma_o$ ,  $\lambda_s$ ,  $\kappa_r$  y la posición mutua del eje de la fresa y el borde de entrada de la pieza.

En outre, le point de premier contact entre l'arête de coupe et la pièce doit idéalement se situer éloigné de l'extrémité de la plaquette. Toutefois, sa position dépend à la fois de la géométrie de base des plaquettes, c'est-à-dire les angles  $\gamma_o$ ,  $\lambda_s$ ,  $\kappa_r$  et la position mutuelle de l'axe de la fraise et du bord d'entrée de la pièce.

Picture / Figura / Image 6



Picture / Figura / Image 7

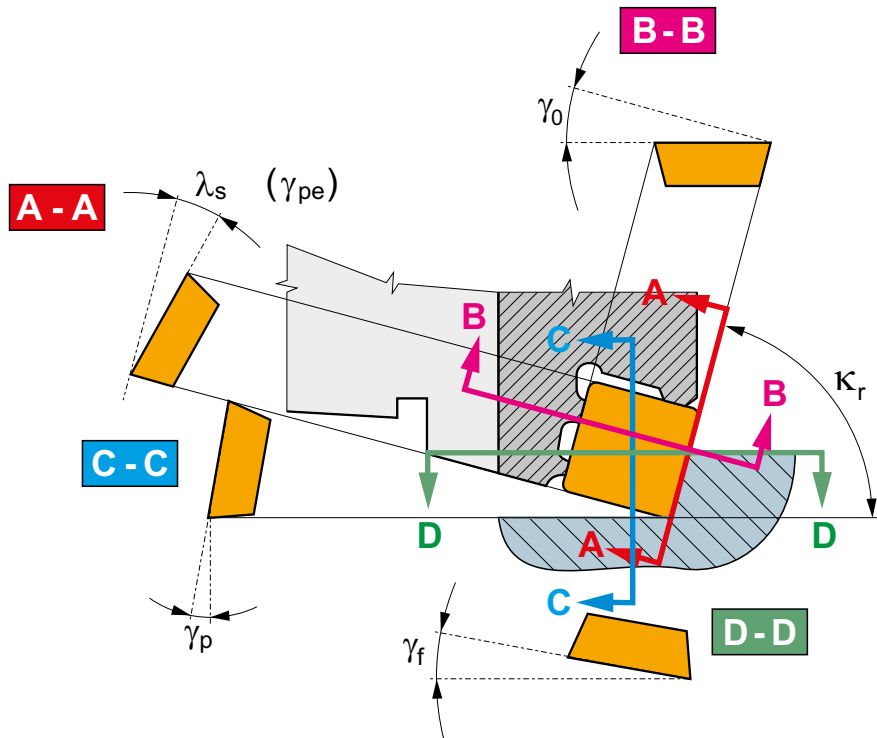


The position of the cutting insert clamped in the tool is determined by several angles – see picture 8.

La posición de la plaquita en la herramienta está determinada por varios ángulos – ver figura 8.

La position d'une plaquette de coupe montée sur l'outil est définie par plusieurs angles, voir image N° 8.

Picture / Figura / Image 8



**Constructional angles** determine the basic orientation of the seat position that the cutting insert is clamped in and are therefore important for the design of the milling cutter body. There are two angles: axial face angle  $\gamma_o$  (tool back rake) and radial face angle  $\gamma_f$  (tool side rake) – see picture 8.

**Working angles** are the setting angle  $\kappa_r$ , the orthogonal face angle  $\gamma_o$  and the rake angle of the cutting edge  $\lambda_s$ .

- **Orthogonal face angle**  $\gamma_o$  – affects not only the extent of plastic deformation of the cut chip but also the cutting force and temperature. The bigger the rake angle  $\gamma_o$ , the lower the cutting force and power demand of the spindle motor (and vice versa).
- **Setting angle**  $\kappa_r$  – determines the thickness of the chip at a specific feed per tooth  $f_z$  and axial depth of cut  $a_p$ . It therefore affects cutting forces, specifically load, wear and tool service life. Reducing the setting angle  $\kappa_r$  at a constant feed  $f_z$  causes a decrease in the chip thickness  $h$ .
- **Rake angle of cutting edge**  $\lambda_s$  – together with setting angle  $\kappa_r$  and face angle  $\gamma_o$ , this determines the point of first contact between the edge and work piece. That is why it affects the resistance of the edge to chipping during interrupted cut. At the same time, it affects the direction of chip evacuation.

Los **ángulos de construcción** determinan la orientación básica de la posición del asiento en el que se coloca la plaquita y por tanto es importante para el diseño de la fresa. Hay dos ángulos: ángulo axial  $\gamma_o$  (inclinación axial) y ángulo radial  $\gamma_f$  (inclinación lateral) – ver figura 8.

Los **ángulos de trabajo** son el ángulo de posición  $\kappa_r$ , el ángulo ortogonal  $\gamma_o$  y el ángulo de desprendimiento del filo de corte  $\lambda_s$ .

- **Ángulo ortogonal**  $\gamma_o$  – afecta no sólo a la deformación plástica de la viruta sino también a la fuerza de corte y a la temperatura. Cuanto mayor sea el ángulo ortogonal  $\gamma_o$  menor será la fuerza de corte y la demanda de potencia del motor de la máquina (y viceversa).
- **Ángulo de posición**  $\kappa_r$  – determina el espesor de viruta a un avance por diente  $f_z$  y una profundidad de corte  $a_p$  específicos. Afecta por tanto a las fuerzas de corte, carga específica, desgaste y vida útil de la herramienta. Reduciendo el ángulo de posición  $\kappa_r$  a un avance constante  $f_z$  se produce una disminución del espesor de viruta  $h$ .
- **Ángulo de desprendimiento del filo de corte**  $\lambda_s$  – junto con el ángulo de posición  $\kappa_r$  y el ángulo ortogonal  $\gamma_o$ , determina el punto del primer contacto entre el filo y la pieza. Por eso afecta a la resistencia del filo al astillamiento durante el corte interrumpido. Al mismo tiempo afecta también a la dirección de evacuación de viruta.

WORKING AND CONSTRUCTIONAL ANGLES OF MILLING CUTTERS  
 ÁNGULOS DE CONSTRUCCIÓN Y DE TRABAJO DE UNA FRESA  
 ANGLES DE CONSTRUCTION ET DE TRAVAIL DES FRAISES

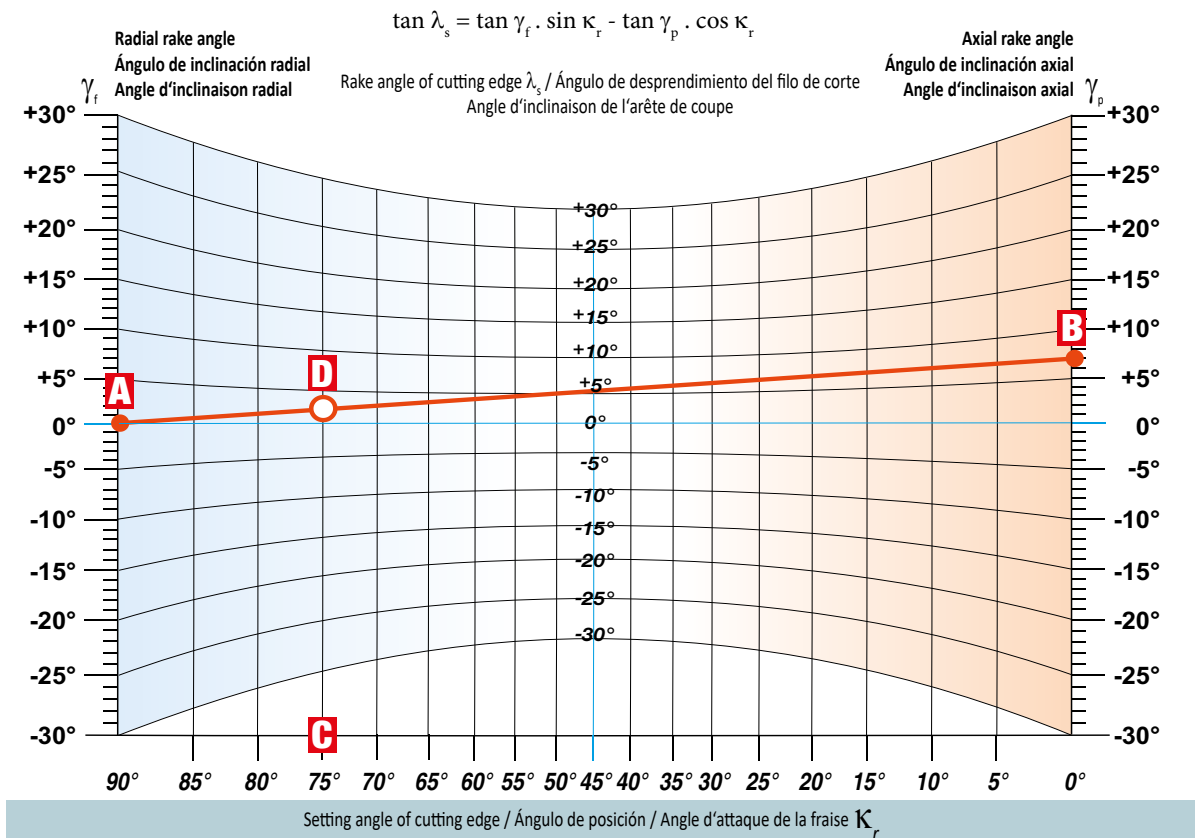
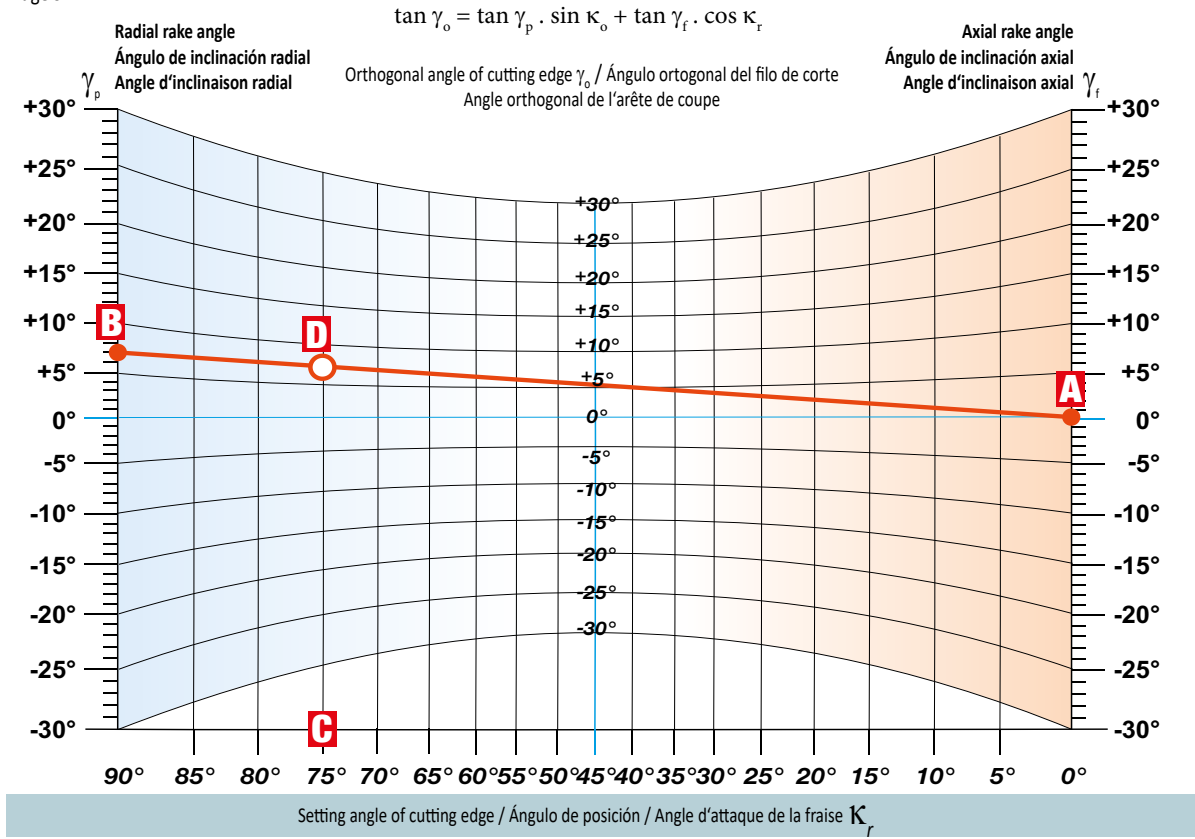
Les **angles de construction** servent à l'orientation de base du logement dans lequel la plaquette est fixée, sa fonction est importante pour la conception du corps de fraise. On parle de deux angles : l'angle axial  $\gamma_a$  (angle mesuré par rapport à l'axe fraise) et l'angle radial  $\gamma_r$  (angle mesuré en regardant la fraise en bout).

Les **angles de travail** sont l'angle d'attaque  $\kappa_r$ , l'angle de coupe orthogonal  $\gamma_o$  et l'angle d'inclinaison de l'arête de coupe  $\lambda_s$ .

- **L'angle de coupe orthogonal**  $\gamma_o$  – affecte le degré de déformation plastique du copeau sectionné et aussi de la valeur de la force de coupe et de la température. Plus l'angle est important, plus faible seront la force de coupe et la puissance demandée à la machine, et vice versa.
- **L'angle d'attaque**  $\kappa_r$  – définit l'épaisseur du copeau pour une avance par dent spécifique  $f_z$  et la profondeur de coupe axiale  $a_p$ . Il affecte donc les forces de coupe, la charge spécifique, l'usure et la durée de vie. Un angle d'attaque faible  $\kappa_r$  pour une avance  $f_z$  constante affecte la diminution de  $f_z$  pour une profondeur de coupe  $h$ .
- **L'angle d'inclinaison de l'arête de coupe**  $\lambda_s$  – combiné à l'angle d'attaque  $\kappa_r$  et à l'angle en coupe orthogonal  $\gamma_o$  définit le point de contact de l'arête dans la pièce. C'est pourquoi il affecte la résistance de l'arête à l'écaillage en coupe interrompue. En même temps il affecte la direction de l'évacuation des copeaux.

NOMOGRAM FOR CALCULATING THE WORKING GEOMETRY OF MILLING CUTTERS  
 NOMOGRAMA PARA CALCULAR LA GEOMETRÍA DE TRABAJO DE LAS FRESAS  
 NOMOGRAMME DE CALCUL DE LA GÉOMÉTRIE DE TRAVAIL DES FRAISES

Picture / Figura / Image 9





**NOMOGRAM FOR CALCULATING THE WORKING GEOMETRY OF MILLING CUTTERS**  
**NOMOGRAMME DE CALCUL DE LA GÉOMÉTRIE DE TRAVAIL DES FRAISES**  
**NOMOGRAMA PARA CALCULAR LA GEOMETRÍA DE TRABAJO DE LAS FRESAS**

The exiting of the cutting edge from the cut is also accompanied by thermal stress, caused by a rapid reduction in temperature of the surface layer of the cutting edge and mechanical stress caused by elastic deformation relief of the surface layer of workpiece at a rapid drop in cutting force.

That is why we use the average value of chip thickness  $h_m$  for any calculations.

The chip thickness  $h$  fluctuates during one revolution depending on angle  $\varphi$  in accordance with the formula  $h\varphi = f_z \times \sin\varphi$ .

The maximum chip thickness equal to  $f_z$  is reached at the axis of the milling cutter. The average chip thickness  $h_m$  cut by one tooth during one revolution is equal to the height of the rectangle of the same area as the area under the sine curve relates to the radial depth of cut  $a_c$ . The average chip thickness  $h_m$  depends on the type of milling cutter and the cutting conditions, especially on the relation  $a_c/D$ , feed per tooth  $f_z$  and the setting angle  $\kappa_r$ . See picture 10. on the next page for an illustrative example.

La sortie de l'arête de coupe de la pièce est également accompagnée de contraintes thermiques provoquées par une diminution rapide de la température sur la couche superficielle de l'arête de coupe, ainsi que des contraintes mécaniques dues au relâchement de la déformation élastique sur la surface de la pièce lié à une chute brutale de la force de coupe.

C'est pourquoi nous utilisons la valeur moyenne de l'épaisseur de copeaux  $h_m$  pour tous les calculs.

L'épaisseur de copeaux  $h$  fluctue pendant une rotation d'outil en fonction de l'angle  $\varphi$  selon la formule  $h\varphi = f_z \times \sin\varphi$ .

L'épaisseur maximale des copeaux égale à  $f_z$  est atteinte au niveau de l'axe de la fraise. L'épaisseur moyenne de copeau  $h_m$  coupé par une dent en un tour est égale à la hauteur du rectangle de la même aire que la surface sous la courbe sinusoidale se rapportant à la profondeur de coupe radiale  $a_c$ . L'épaisseur moyenne de copeau  $h_m$  dépend du type de fraise et des conditions de coupe, en particulier du rapport  $a_c/D$ , de l'avance par dent  $f_z$  et l'angle d'attaque  $\kappa_r$ . Voir l'illustration 10 à la page suivante.

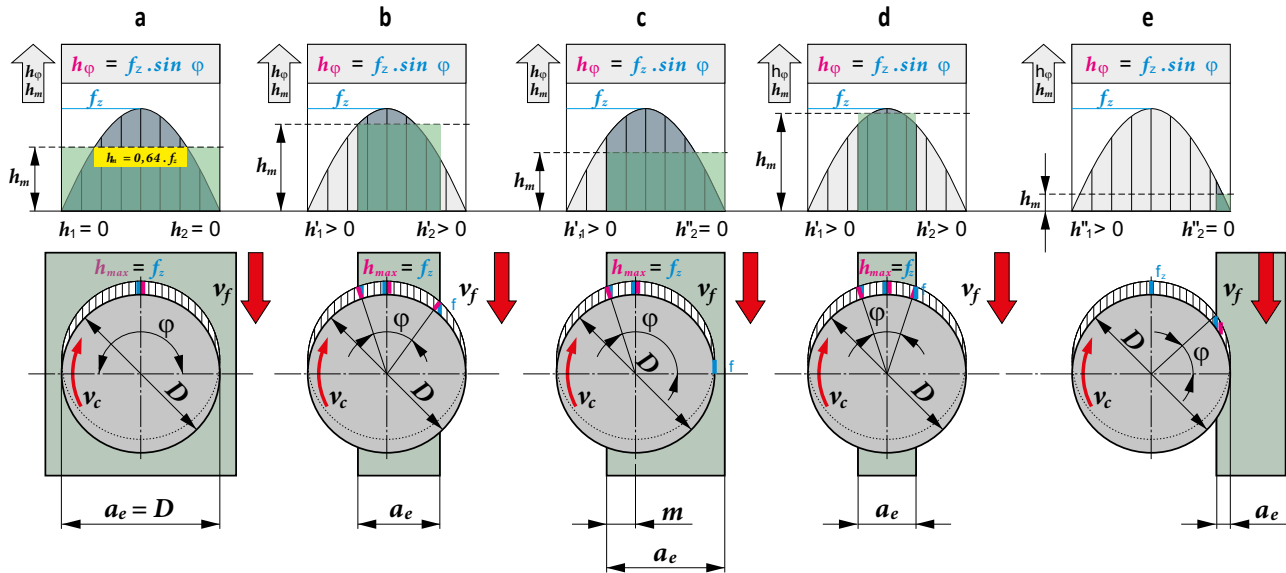
La salida del filo de corte del material va también acompañada de tensión térmica causada por una rápida disminución de la temperatura de la capa superficial del filo de corte, y tensión mecánica causada por el alivio de la deformación elástica en la capa superficial de la pieza por una rápida caída de la fuerza de corte.

Por eso utilizamos el valor de espesor medio de viruta  $h_m$  para cualquier cálculo.

El espesor de viruta  $h$  fluctúa durante una revolución dependiendo del ángulo  $\varphi$  en función de la fórmula  $h\varphi = f_z \times \sin\varphi$ .

El espesor máximo de viruta igual al avance  $f_z$  se alcanza en el eje de la fresa. El espesor medio de viruta  $h_m$  producida por un diente durante una revolución es igual a la altura del rectángulo de área igual al área bajo la curva sinusoidal relativa a la profundidad de corte radial  $a_c$ . El espesor medio de viruta  $h_m$  depende del tipo de fresa y de las condiciones de corte, especialmente en la relación  $a_c/D$ , avance por diente  $f_z$  y el ángulo de posición  $\kappa_r$ . Ver figura 10 en la siguiente página un ejemplo ilustrativo.

Picture / Figura / Image 10



The following formula can be used to calculate  $h_m$  (picture 10a, b, d):

Se puede utilizar la siguiente fórmula para calcular el avance  $f_z$  para un valor dado de  $h_m$  (imagen 10a, b, d):

Pour le calcul de  $h_m$  (image 10a, b, d) la formule suivante peut être utilisée:

$$h_m = f_z \cdot \sin \kappa_r \cdot \left( 57.3 \frac{a_e}{D \cdot \arcsin \left( \frac{a_e}{D} \right)} \right)$$

The average chip thickness for machining with the center of the milling cutter (for example 10c, e) is therefore calculated in accordance with formula:

El espesor medio de viruta para mecanizar con el centro de la fresa por ejemplo 10c, e se calcula por tanto con la siguiente fórmula:

L'épaisseur moyenne de copeau en condition d'usinage avec le centre de la fraise comme l'exemple 10c, e est donc calculée selon la formule:

$$h_m = f_z \cdot \sin \kappa_r \cdot 114.6 \cdot \left( \frac{a_e}{D \cdot \arccos \left( 1 - \frac{2a_e}{D} \right)} \right)$$

The following formula can be used to calculate the feed  $f_z$  for the given value of  $h_m$ :

Se puede utilizar la siguiente fórmula para calcular  $h_m$ :

Pour le calcul de l'avance  $f_z$  pour une valeur de  $h_m$  donnée, la formule suivante peut être utilisée:

$$f_z = \frac{h_m}{\sin \kappa_r} \cdot \left( \frac{D \cdot \arccos \left( 1 - \frac{2a_e}{D} \right)}{114.6 \cdot a_e} \right)$$

The following simplified formula can be used to calculate  $h_m$  (picture 10e) if  $a_e/D < 0,2$ :

Se puede utilizar la siguiente fórmula simplificada para calcular  $h_m$ :

La formule simplifiée suivante peut être utilisée pour calculer  $h_m$  (image 10e) si  $a_e/D < 0,2$ :

$$h_m = f_z \sin \kappa_r \sqrt{\frac{a_e}{D}}$$

The following formula can be used to calculate the feed  $f_z$  for the given value of  $h_m$ :

Se puede utilizar la siguiente fórmula para calcular el avance  $f_z$  para un valor dado de  $h_m$ :

La formule suivante peut être utilisée pour calculer l'avance par dent  $f_z$  pour la valeur donnée de  $h_m$ :

$$f_z = \frac{h_m}{\sin \kappa_r} \sqrt{\frac{D}{a_e}}$$

Where:

$h_m$	average chip thickness [in]
$f_z$	feed per tooth [in/tooth]
$a_e$	radial depth of cut [in]
D	diameter [in]
$\kappa_r$	setting angle of major edge [°]

Avec:

$h_m$	épaisseur moyenne du copeau [in]
$f_z$	avance par dent [in/dent]
$a_e$	profondeur de coupe radiale [in]
D	diamètre [in]
$\kappa_r$	angle d'attaque de l'arête principale [°]

Donde:

$h_m$	espesor medio de viruta [in]
$f_z$	avance por diente [in/diente]
$a_e$	profundidad de corte radial [in]
D	diámetro [in]
$\kappa_r$	ángulo de posición del filo [°]

CALCULATING THE AVERAGE CHIP THICKNESS RANGE  
CÁLCULO DE LAS GAMAS DE ESPESOR MEDIO DE VIRUTA  
CALCUL DES PLAGES D'ÉPAISSEUR DE COPEAU MOYEN

There is an optimum average chip thickness range for each type of tool included in this catalogue. When using values lower than the stated range, there is a risk that the tool "will not cut", that there will be excessive wear, or even that the the insert will be severely damaged in the process. Exceeding the recommended value also risks damaging the insert due to tool overloading. The following table provides the cutter types together with the recommended average chip thickness range.

The ranges of recommended average chip thickness are listed directly in the individual groups.

**The full range of chip thickness can only be used for groups P and K; the lower limit of chip thickness must be modified (taken as higher than listed) for groups M and S and in tough materials from group N. The upper limit must be lowered for groups H, S and slightly also for M group materials with higher mechanical strength. On the other hand, machining soft materials from group N allows the increase of the upper limit of recommended average chip thickness by c. 10 – 15 %.**

Hay una gama de espesores medios de viruta óptimos para cada tipo de herramienta incluida en este catálogo. Al utilizar valores inferiores a los de partida, existe riesgo de que la herramienta "no corte", que haya un desgaste excesivo o incluso que la herramienta sea severamente dañada en el proceso. Utilizar valores superiores a los recomendados supone también un riesgo de dañar la plaquita debido a una sobrecarga. La siguiente tabla proporciona los tipos de herramienta junto con la gama de espesores medios de viruta recomendados.

Las gamas de espesores medios de viruta recomendados se indican directamente en los grupos individuales.

**La gama completa de espesores de viruta se puede utilizar sólo para los grupos P y K; el límite inferior de espesor de viruta debe ser modificado (tomado como el superior de la lista) para los grupos M, S y materiales tenaces del grupo N. El límite superior se debe disminuir para los grupos H, S y ligeramente también para materiales del grupo M con una alta resistencia mecánica. Por otro lado, el mecanizado de materiales blandos del grupo N permite incrementar el límite superior de espesor medio de viruta recomendado en un 10 – 15 %.**

Il existe une plage optimum d'épaisseur de copeau moyen pour chaque outil présenté dans ce catalogue. Quand les valeurs sont plus faibles que celles préconisées, il y a un risque que l'outil "ne coupe pas", que l'usure soit excessive, ou même que la plaquette soit sévèrement endommagée par le process d'usinage. Le dépassement de la valeur recommandée risque également d'endommager la plaquette à cause d'une surcharge sur l'outil. Le tableau suivant indique les valeurs d'épaisseur de copeau moyen recommandées en fonction du type d'outil utilisé.

Les intervalles d'épaisseur moyenne recommandée sont présentés directement par groupe de matière.

**L'intervalle complet d'épaisseur de copeau ne peut être utilisé que pour les groupes P et K; La limite inférieure d'épaisseur des copeaux doit être modifiée (prendre une valeur supérieure à celle indiquée) pour les groupes M et S et dans les matériaux durs du groupe N. La limite supérieure doit être abaissée pour les groupes H, S et légèrement aussi pour les matériaux du groupe M possédant une résistance mécanique plus élevée. En revanche, l'usinage des matériaux mous (ou à faible résistance mécanique) du groupe N permet d'augmenter la limite supérieure d'épaisseur recommandée des copeaux de l'ordre de 10 à 15%.**

To achieve optimum application of any milling tool, it is recommended to check the chip thickness or choose (calculate) a suitable feed based on the recommended range of  $h_m$ . It is also necessary to take the geometry of the insert into account. The formula above can be used to calculate  $f_z$ , or the following formula can be used instead.

The value of coefficient  $c$  can be read from the following chart (picture 11):

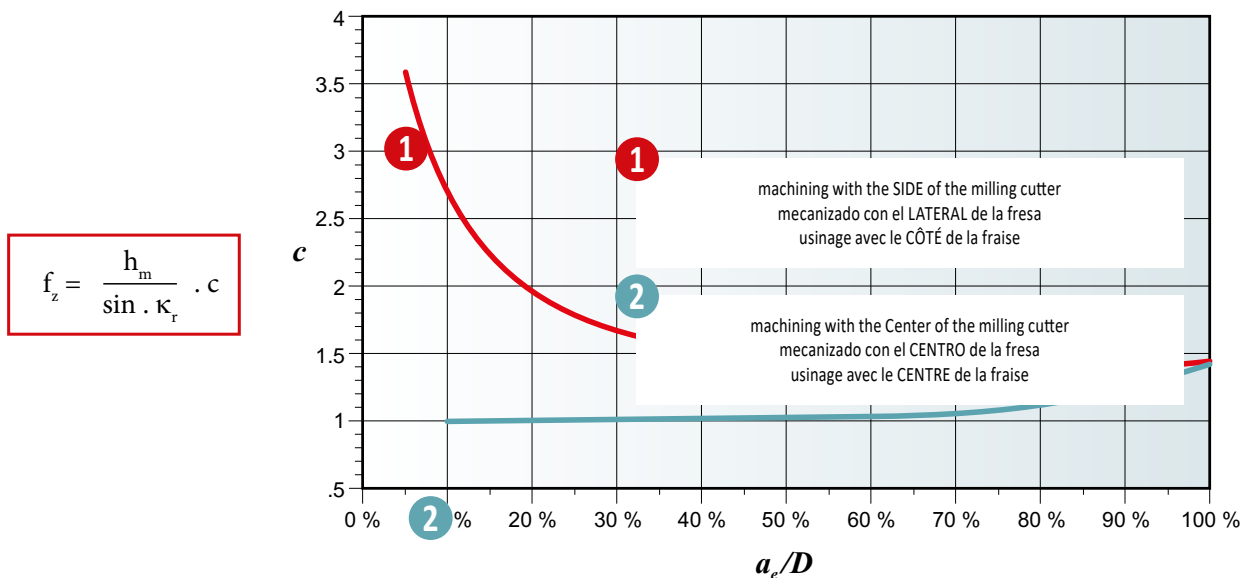
Pour parvenir à une application optimale de n'importe quel outil de fraisage, il est donc recommandé de vérifier l'épaisseur du copeau ou de choisir (calculer) une avance appropriée en fonction de la plage recommandée de  $h_m$ . Il est également nécessaire de prendre en compte la géométrie de la plaquette. La formule ci-dessus peut être utilisée pour calculer  $f_z$ , ou la formule suivante peut être utilisée à la place.

La valeur du coefficient  $c$  peut être lue à partir du tableau ci-dessous (image 11):

Para lograr una aplicación óptima de cualquier fresa, se recomienda por tanto comprobar el espesor de viruta o elegir (calcular) un avance adecuado basado en la gama recomendada de  $h_m$ . Es también necesario tener en cuenta la geometría de la plaquita. Se puede utilizar la fórmula de arriba para calcular  $f_z$ , o bien utilizar la siguiente fórmula.

El valor del coeficiente  $c$  se puede leer en la siguiente tabla (figura 11):

Picture / Figura / Image 11



And now for individual applications, or rather recommendations and explanations regarding machining of basic types of surfaces.

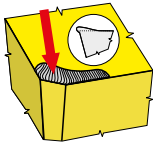








Para tecnologías individuales o recomendaciones y explicaciones relativas al mecanizado de tipos básicos de superficies.

Et maintenant pour des technologies individuelles, ou plutôt des recommandations et explications concernant l'usinage de types de surfaces de base.

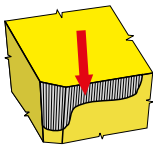
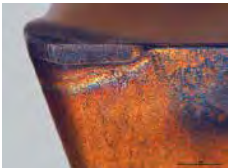







Table 20  
Tabla 20  
Tableau 20

TYPES OF WEAR ON MILLING INSERTS  
TIPOS DE DESGASTE EN PLAQUITAS DE FRESADO  
TYPES D'USURE DES PLAQUETTES DE FRAISAGE

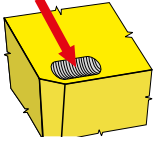
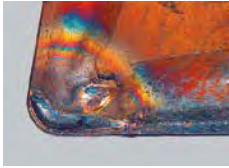







BUILT-UP EDGE / FILO DE APORTACIÓN / ARÊTE RAPPORTÉE

  			It has no influence No influye N'a aucune influence
		++	Any coating (decisive factor is anti-adhesion effect) Cualquier recubrimiento (el factor decisivo es el efecto anti-adherente) Tout revêtement (le facteur décisif est l'effet anti-adhérence)
		↑	The higher the feed rate the less probability of built-up edge creation Cuanto mayor sea el avance menor probabilidad de formación de filo de aportación Plus l'avance est forte, moins la probabilité de générer une arête rapportée est grande
		↓↑	Change (generally increase) the cutting speed Cambiar (generalmente aumentar) la velocidad de corte Modifier (souvent en l'augmentant) la vitesse de coupe
			It has no influence No influye N'a aucune influence
		↓↑	Use more positive geometry (built up edge is not created when the rake angle is more than 40°) Utilizar una geometría más positiva (el filo de aportación no se crea cuando el ángulo de desprendimiento es mayor de 40°) Utiliser une géométrie plus positive (une arête rapportée n'apparaît jamais sur des angles de coupe de plus de 40°)
		-	Use a coolant with more effective anti-sticking properties (we do not recommend to use coolant for milling) Usar un refrigerante con propiedades anti-adherencia más efectivas (no se recomienda usar refrigerante en fresado) Utiliser un arrosage plus efficace quant à ses propriétés anti-adhérentse (nous recommandons de ne pas utiliser l'arrosage en fraisage)

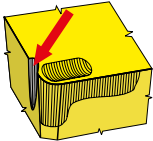








FLANK WEAR / DESGASTE EN FLANCO (O EN INCIDENCIA) / USURE EN DÉPOUILLE

  		↑	Use a more wear resistant substrate (H) Utilizar un sustrato más resistente al desgaste (H) Utiliser un substrat plus résistant à l'usure (H)
		++	Any coating (decisive factor is hardness – TiC, TiCN) Cualquier recubrimiento (el factor decisivo es la dureza – TiC, TiCN) Tout revêtement (le facteur décisif est sa dureté – TiC, TiCN)
		↑	Increase feed (especially if it is under .004 in) Incrementar el avance (especialmente si está por debajo de .004 in) Augmenter l'avance (particulièrement quand elle est inférieure à .004 in)
		↓	Decrease cutting speed Reducir la velocidad de corte Diminuer la vitesse de coupe
			It has no influence No influye N'a aucune influence
		↑	Increase the clearance angle Lo más importante es aumentar el ángulo de incidencia Le plus important est d'augmenter l'angle de dépouille
		+	It can help, but only with ideal working conditions Puede ayudar, pero sólo bajo condiciones de trabajo óptimas Cela peut aider mais seulement avec des conditions de travail idéales

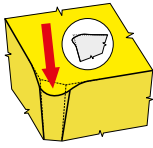
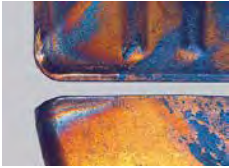







CRATERING / CRÁTER / USURE EN CRATÈRE

  		↑	Use a more wear resistant substrate (S) Utilizar un sustrato más resistente al desgaste (S) Utiliser un substrat plus résistant à l'usure (S)
		++	CVD coating (decisive factor is oxidation resistance – $\alpha$ Al <sub>2</sub> O <sub>3</sub> ) Recubrimiento CVD (el factor decisivo es la resistencia a la oxidación – $\alpha$ Al <sub>2</sub> O <sub>3</sub> ) Revêtement CVD (le facteur décisif est sa résistance à l'oxydation – $\alpha$ Al <sub>2</sub> O <sub>3</sub> )
		↑	Feed has influence on shape and position of crater El avance influye en la forma y la posición del cráter L'avance influe sur la forme et la position du cratère
		↓	Decrease cutting speed Reducir la velocidad de corte Diminuer la vitesse de coupe
		↓	Minimal effect Mínimo efecto Effet minime
		↑	Use more positive cutting geometry Utilizar una geometría de corte más positiva Utiliser une géométrie de coupe plus positive
		++	It can help, but only with ideal working conditions Puede ayudar, pero sólo bajo condiciones de trabajo óptimas Cela peut aider mais seulement avec des conditions de travail idéales

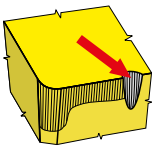








OXIDATION GROOVE ON THE MINOR EDGE / ENTALLA POR OXIDACIÓN / ENTAILLE PAR OXYDATION SUR L'ARÊTE SECONDAIRE

  		↑	Use a more wear resistant substrate (S) Utilizar un sustrato más resistente al desgaste (S) Utiliser un substrat plus résistant à l'usure (S)
		++	CVD coating (decisive factor is oxidation resistance – $\alpha$ Al <sub>2</sub> O <sub>3</sub> ) Recubrimiento CVD (el factor decisivo es la resistencia a la oxidación – $\alpha$ Al <sub>2</sub> O <sub>3</sub> ) Revêtement CVD (le facteur décisif est sa résistance à l'oxydation – $\alpha$ Al <sub>2</sub> O <sub>3</sub> )
		↓	Feed has influence on shape and position of groove El avance influye en la forma y la posición de la entalla L'avance influe sur la forme et la position de l'entaille
		↓	Decrease cutting speed Reducir la velocidad de corte Diminuer la vitesse de coupe
		↓	Minimal effect Mínimo efecto Effet minime
		↑	Use another (more positive) cutting geometry Utilizar otra (más positiva) geometría de corte Utiliser une autre géométrie de coupe (plus positive)
		++	It can help, but only with ideal working conditions Puede ayudar, pero sólo bajo condiciones de trabajo óptimas Cela peut aider mais seulement avec des conditions de travail idéales

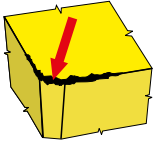








PLASTIC DEFORMATION / DEFORMACIÓN PLÁSTICA / DÉFORMATION PLASTIQUE

 		↑	Using a more wear resistant substrate (decisive factor is content of Co) Utilizar un sustrato más resistente al desgaste (el factor decisivo es el contenido en Co) Utiliser un substrat plus résistant à l'usure (le taux de cobalt est décisif)
		+	Any coating (decisive factor is friction) Cualquier recubrimiento (el factor decisivo es la fricción) Tout revêtement (le facteur décisif est le frottement)
		↓	Decrease feed rate Reducir el avance Diminuer l'avance
		↓	Decrease cutting speed Reducir la velocidad de corte Diminuer la vitesse de coupe
		↓	Minimal effect Mínimo efecto Effet minime
		↑	Use another (more positive) cutting geometry Utilizar otra (más positiva) geometría de corte Utiliser une autre géométrie de coupe (plus positive)
		++	It can help, but only with ideal working conditions Puede ayudar, pero sólo bajo condiciones de trabajo óptimas Cela peut aider mais seulement avec des conditions de travail idéales

NOTCH WEAR / ENTALLADURA / USURE EN ENTAILLE

 		↑↓	It depends on the character of the damage (abrasive – use more wear resistant substrate; breaking – use tougher substrate) Depende del carácter del problema (abrasivo – usar un sustrato más resistente al desgaste; rotura – usar un sustrato más tenaz) Dépend de la cause de l'usure (abrasion – utiliser un substrat plus résistant à l'usure; rupture – utiliser un substrat plus tenace)
		++	CVD coating (decisive factor is oxidation resistance – $\alpha$ Al <sub>2</sub> O <sub>3</sub> ) Recubrimiento CVD (el factor decisivo es la resistencia a la oxidación – $\alpha$ Al <sub>2</sub> O <sub>3</sub> ) Revêtement CVD (le facteur décisif est sa résistance à l'oxydation – $\alpha$ Al <sub>2</sub> O <sub>3</sub> )
		↓	Feed has influence on intensity, but less than the cutting speed El avance influye en la intensidad, pero menos que la velocidad de corte L'avance influe sur l'intensité, mais moins que la vitesse de coupe
		↓	Decrease cutting speed Reducir la velocidad de corte Diminuer la vitesse de coupe
		↑↓	Use unequal depth of cut Utilizar una profundidad de corte desigual Faire varier la profondeur de coupe
		↓	Use less positive cutting geometry Utilizar una geometría de corte menos positiva Utiliser une géométrie moins positive
		+	It can help, but only with ideal working conditions Puede ayudar, pero sólo bajo condiciones de trabajo óptimas Cela peut aider mais seulement avec des conditions de travail idéales
			Use tool with smaller setting angle Utilizar una herramienta con menor ángulo de posición Utiliser un outil avec un angle d'attaque plus petit

BRITTLE CRACKS AT THE CUTTING EDGE / ASTILLAMIENTO DEL FILO DE CORTE / ÉCAILLAGE DE L'ARÊTE DE COUPE

  		↓	(H) grain has a great influence El sustrato (H) tiene un papel muy importante Choisir un substrat à grains plus gros (H)
		+	PVD coating recommended Se recomienda recubrimiento PVD Un revêtement PVD est recommandé
		↓	Feed has influence on intensity, but less than the cutting speed El avance influye en la intensidad, pero menos que la velocidad de corte L'avance influe sur l'intensité, mais moins que la vitesse de coupe
		↑ ↓	It is about vibrations Influye en las vibraciones Il s'agit de vibrations
		↓	It has no influence No influye N'a aucune influence
		↑	Increase the rake angle to reduce cutting forces Incrementar el ángulo de desprendimiento para reducir las fuerzas de corte Augmenter l'angle d'inclinaison pour réduire les efforts de coupe
		-	No coolant (it is possible to use air to remove chips from cutting area) Sin refrigeración (se puede utilizar aire para evacuar virutas de la zona de corte) Pas d'arrosage (utiliser de l'air pour évacuer les copeaux hors de la zone de coupe)

FAILURE OF CUTTING EDGE / DESPRENDIMIENTO DEL FILO POR MARTILLO DE VIRUTAS / AFFAIBLISSEMENT DE L'ARÊTE DE COUPE

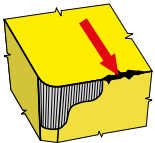








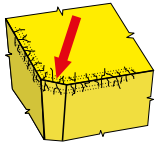
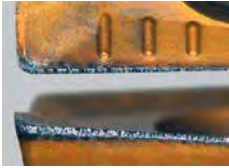







  		↓	(H) grain has a great influence El sustrato (H) tiene un papel muy importante Choisir un substrat à grains plus gros (H)
		+	PVD coating recommended Se recomienda recubrimiento PVD Un revêtement PVD est recommandé
		↑ ↓	Good swarf control is very important Es muy importante una rotura de virutas correcta Un bon fractionnement du copeau est très important
		↑ ↓	It is about swarf control and vibration Influye en la rotura de virutas y las vibraciones Il s'agit d'évacuation copeaux et de vibrations
		↑ ↓	Reduces the force load (important for machining with long overhangs) Reduce la carga mecánica en el filo de corte (importante cuando se mecaniza con voladizos largos) Réduire la charge (important pour l'usinage avec de longs porte-à-faux)
		↓	Use less positive cutting geometry Utilizar una geometría de corte menos positiva Utiliser une géométrie moins positive
			It has no influence No influye N'a aucune influence



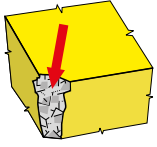
Table 20  
Tabla 20  
Tableau 20

TYPES OF WEAR ON MILLING INSERTS  
TIPOS DE DESGASTE EN PLAQUITAS DE FRESADO  
TYPES D'USURE DES PLAQUETTES DE FRAISAGE

CREATION OF RACK CRACKS / MICRO-FISURAS TÉRMICAS / USURE EN PEIGNE (FISSURES)

  		↓	(H) grain has a great influence El sustrato (H) tiene un papel muy importante Choisir un substrat à grains plus gros (H)
		++	PVD coating recommended Se recomienda recubrimiento PVD Un revêtement PVD est recommandé
		↓	Feed has influence on intensity, but less than the cutting speed El avance influye en la intensidad, pero menos que la velocidad de corte L'avance influe sur l'intensité, mais moins que la vitesse de coupe
		↓	Lower speed means lower temperature Menor velocidad significa menor temperatura Vitesse plus basse veut dire température moins élevée
			It has no influence No influye N'a aucune influence
		↑	Use another (more positive) cutting geometry Utilizar otra (más positiva) geometría de corte Utiliser une autre géométrie de coupe (plus positive)
		---	No coolant (it is possible to use air to remove chips from cutting area) Sin refrigeración (se puede utilizar aire para evacuar virutas de la zona de corte) Pas d'arrosage (utiliser de l'air pour évacuer les copeaux hors de la zone de coupe)
			Use better working condition ( $a_v/D$ ) Mejorar las condiciones de trabajo ( $a_v/D$ ) Utiliser de meilleures conditions de travail ( $a_v/D$ )

INSERT FRACTURE / ROTURA DE PLAQUITA / RUPTURE DE PLAQUETTE

  		↓	(H) grain has a great influence El sustrato (H) tiene un papel muy importante Choisir un substrat à grains plus gros (H)
		+	PVD coating recommended Se recomienda recubrimiento PVD Un revêtement PVD est recommandé
		↓	Very important to reduce cutting force La fuerza de corte es de gran importancia L'effort de coupe est très important
		↑ ↓	It is about swarf control and vibration Influye en la evacuación de viruta y vibraciones Il s'agit d'évacuation copeaux et de vibrations
		↓	Reduces the force load Reduce la carga mecánica en el filo de corte Réduire la charge
		↓	Use less positive cutting geometry Utilizar una geometría de corte menos positiva Utiliser une géométrie moins positive
			It has no influence No influye N'a aucune influence
			Use better working conditions Mejorar las condiciones de trabajo Utiliser de meilleures conditions de travail

POOR SURFACE QUALITY / MALA CALIDAD SUPERFICIAL / QUALITÉ DE SURFACE MAUVAISE

**Description and cause:**

Numerous causes depending on the workpiece material, cutting conditons (feed rate and cutting speed), the condition of the cutting edge, the extent and type of wear, and the condition and rigidity of the machine – tool – workpiece assembly.

- Incorrect tool chosen
- Incorrect chip thickness
- Incorrect cutting speed
- Coolant is needed
- High feed rate

**Corrective measures:**

- Use a finishing insert, or an insert with finishing segment
- Use an insert with suitable cutting geometry
- Reduce the feed rate
- Adjust (usually increase) the cutting speed
- Use coolant or lubrication (MQL)
- Eliminate vibrations
- Use a tool with which the position of the individual inserts can be adjusted more accurately
- Change the chip thickness (modify the machining conditions)

**Descripción y causas**

Numerosas causas dependiendo del material de la pieza, condiciones de corte (avance y velocidad de corte), estado del filo de corte, grado y tipo de desgaste y estado y rigidez de la máquina (montaje de la herramienta y de la pieza).

- Elección de herramienta incorrecta
- Espesor de viruta incorrecto
- Velocidad de corte incorrecta
- Es necesario refrigerante
- Avance demasiado alto

**Medidas correctoras:**

- Utilizar una plaqueta de acabado
- Utilizar una plaqueta con la geometría de corte adecuada
- Reducir el avance
- Ajustar (normalmente aumentar) la velocidad de corte
- Utilizar refrigerante o lubricación (MQL)
- Eliminar vibraciones
- Utilizar una herramienta en la que cada plaqueta pueda ser ajustada individualmente con mayor precisión
- Cambiar el espesor de viruta (modificar las condiciones de mecanizado)



**Description et cause :**

Les causes sont nombreuses, elles dépendent du matériau à usiner, des conditions de coupe (avance et vitesse de coupe), de la condition de l'arête de coupe, du niveau et du type d'usure, de l'état et de la rigidité de la machine.

- Mauvais choix d'outil
- Mauvaise épaisseur du copeau
- Mauvaise vitesse de coupe
- Arrosage nécessaire
- Vitesse d'avance élevée

**Solution :**

- Utiliser une plaquette racleuse (Wiper)
- Utiliser une plaquette avec une géométrie correcte
- Réduire la vitesse d'avance
- Changer (en général augmenter) la vitesse de coupe
- Utiliser l'arrosage
- Améliorer la stabilité de l'outil et de la pièce et à usiner
- Changer la section du copeau
- Sélectionner une géométrie plus coupante
- Utiliser une plaquette avec un plus gros rayon de pointe

VIBRATIONS / VIBRACIONES / VIBRATIONS

**Description and cause:**

This is a very common problem, which is mainly caused by an unbalanced workpiece or tool, unstable fixing of the machined part and high cutting forces.

- Low rigidity of machine-tool-workpiece assembly
- Excessive chip depth (both axial and radial)
- Run-out – poor workpiece or tool balance
- Large tool overhang

**Corrective measures:**

- Check the stability of the workpiece fixing
- Check the stability of the tool fixing
- Reduce the cutting depth
- Use a tool with smaller overhang
- Modify the cutting speed
- Reduce the chip thickness (change the cutting or machining conditions)
- Choose a suitable cutting geometry and tool material to minimize the cutting process force balance (as sharp and as positive as possible), i.e. use a tool with a lower cutting resistance
- When milling, use a tool with a smaller setting angle

**Descripción y causa:**

Este es un problema muy común, causado principalmente por una pieza o herramienta desequilibrada, una fijación inestable de la pieza o fuerzas de corte demasiado altas.

- Poca rigidez del montaje máquina-herramienta-pieza
- Demasiada profundidad (axial y radial)
- Desviación radial - pieza o herramienta mal equilibrada
- Gran voladizo de la herramienta

**Medidas correctoras:**

- Comprobar la estabilidad del montaje de la pieza
- Comprobar la estabilidad del montaje de la herramienta
- Reducir la profundidad de corte
- Reducir el voladizo
- Modificar la velocidad de corte
- Reducir el espesor de viruta (cambiar las condiciones de mecanizado)
- Utilizar una calidad y geometría adecuadas para minimizar el desequilibrio de las fuerzas de corte (tan viva y positiva como sea posible), es decir, una herramienta que genere fuerzas de corte más bajas.
- En fresado, utilizar una herramienta con un ángulo de posición menor




**Description et cause :**

Ceci est très fréquent. Les principales raisons sont le déséquilibre de la pièce ou de l'outil, la mauvaise stabilité de la pièce, des forces de coupe très fortes, du porte-à-faux de l'outil.


**Solution :**

- Améliorer la stabilité de l'outil et de la pièce et à usiner
- Réduire la profondeur de coupe
- Diminuer le porte-à-faux de l'outil
- Réduire la vitesse de coupe
- Utiliser un outil avec un angle d'attaque plus petit
- Réduire la section copeaux
- Utiliser un outil avec une plus faible résistance à la coupe
- Augmenter la vitesse d'avance
- Sélectionner une géométrie plus coupante
- Utiliser une plaquette avec un plus gros rayon de pointe

**BURRS / REBABAS / BAVURE**

	<p><b>Description and cause:</b> This usually occurs on soft steels and plastic materials.</p>	<p><b>Corrective measures:</b></p> <ul style="list-style-type: none"> <li>- Use a cutting insert with a sharp cutting edge</li> <li>- Use a cutting insert with positive geometry</li> <li>- Use a tool with a smaller setting angle</li> </ul>
	<p><b>Descripción y causas:</b> Esto ocurre normalmente en aceros blandos y materiales plásticos.</p>	<p><b>Medidas correctoras:</b></p> <ul style="list-style-type: none"> <li>- Utilizar una plaquita con filo de corte más vivo</li> <li>- Utilizar una plaquita con geometría positiva</li> <li>- Utilizar una herramienta con un ángulo de posición menor</li> </ul>
	<p><b>Description et cause :</b> Ceci apparaît régulièrement en usinage de matériaux doux ou de matières plastiques.</p>	<p><b>Solution :</b></p> <ul style="list-style-type: none"> <li>- Utiliser une plaquette avec une arête vive</li> <li>- Utiliser une plaquette avec une géométrie positive</li> <li>- Utiliser un outil avec un angle d'attaque plus petit</li> </ul>

**ERRORS IN DIMENSIONS AND SHAPE OF WORKPIECE / ERRORES EN DIMENSIONES Y FORMA DE LA PIEZA  
INEXACTITUDE DES DIMENSIONS ET DE LA FORME DE LA PIÈCE**

	<p><b>Description and cause:</b> Depends on a number of factors.</p>	<p><b>Corrective measures:</b></p> <ul style="list-style-type: none"> <li>- Use a wear-resistant cutting insert</li> <li>- Improve the stability of the cutter and workpiece</li> <li>- Minimize tool overhang</li> <li>- Use a workpiece with a suitable machining allowance</li> </ul>
	<p><b>Descripción y causas:</b> Depende de muchos factores.</p>	<p><b>Medidas correctoras:</b></p> <ul style="list-style-type: none"> <li>- Utilizar una plaquita más resistente al desgaste</li> <li>- Mejorar la estabilidad de la herramienta y de la pieza</li> <li>- Minimizar el voladizo</li> <li>- Utilizar una pieza con mayor tolerancia al mecanizado</li> </ul>
	<p><b>Description et cause :</b> Dépend d'un certain nombres de facteurs.</p>	<p><b>Solution :</b></p> <ul style="list-style-type: none"> <li>- Utiliser une plaquette résistante à l'usure</li> <li>- Améliorer la stabilité de l'outil et de la pièce usinée, diminuer le porte-à-faux de l'outil</li> <li>- Utiliser une pièce avec une surépaisseur d'usinage mieux appropriée</li> </ul>

INADEQUATE CHIP FORMATION / FORMACION DE VIRUTA INADECUADA / MAÎTRISE DES COPEAUX INACCEPTABLE

**Description and cause:**

Producing a chip with a suitable shape is very important to insert durability and service life of the tool. The workpiece material, the feed rate, the depth of cut and the cutting geometry all have an effect on chip forming. A chip that is too long is unacceptable for various reasons, while a chip that is too short is undesirable as it overloads the cutting edge and causes vibrations.

**Corrective measures:**

- Change the feed rate and depth of cut
- Use a more suitable cutting geometry
- Change the cutting conditions

**Descripción y causas:**

Conseguir una viruta con la forma adecuada es tan importante como la durabilidad de la herramienta. El material de la pieza, el avance, la profundidad de corte y la geometría de corte tienen un efecto en la formación de viruta. Una viruta demasiado larga es inaceptable por varias razones, mientras que una viruta demasiado corta no es deseable porque sobrecarga el filo de corte y produce vibraciones.

**Medidas correctoras:**

- Cambiar el avance y la profundidad de corte
- Utilizar una geometría de corte más adecuada
- Cambiar las condiciones de corte



**Description et cause :**

Une forme de copeau convenable est un critère important, comme la durée de vie de l'outil. Le matériau de la pièce à usiner, l'avance, la profondeur de coupe, la géométrie de coupe adaptée (brise-copeaux) agissent sur la forme correcte du copeau. Un copeau long est inacceptable cependant qu'un copeau trop court (écrasé) n'est pas souhaitable, ceci indique une trop forte charge sur l'arête et génère des vibrations.

**Solution :**

- Changer l'avance et la profondeur de coupe
- Utiliser une plaquette avec une géométrie correcte
- Changer les conditions de coupe

Table 22  
Tabla 22  
Tableau 22

GENERAL PRINCIPLES  
PRINCIPIOS GENERALES  
PRINCIPES GÉNÉRAUX

**CHECK THE SEAT CONDITION OF THE CUTTING INSERT / COMPROBAR EL ESTADO DEL ASIENTO DE LA PLAQUITA**  
**VÉRIFICATION DE L'ÉTAT CORRECT DES LOGEMENTS DE PLAQUETTES**

Before clamping a new cutting insert or changing the edge, it is necessary to clean the seat and check its condition or the condition of the anvil and wedge (especially the damage under the corner of the cutting insert).

Antes de montar una plaquita nueva o cambiar el filo de corte, es necesario limpiar el asiento y comprobar el estado de la plaquita de apoyo, especialmente la esquina que está bajo el filo de corte.

Avant le serrage d'une nouvelle plaquette ou avant de changer une arête (indexage ou rotation de la plaquette) il est nécessaire de nettoyer le logement, de vérifier l'état du système de fixation de la plaquette et du corps d'outil (particulièrement l'endroit sous la pointe de la plaquette).

**CHECK AND SERVICE THE CLAMPING PARTS / COMPROBACIÓN Y SERVICIO DE LOS COMPONENTES DE FIJACIÓN DE LA PLAQUITA**  
**VÉRIFICATION DES PIÈCES DE RECHANGE**

It is also important to check the clamping parts, including clamping levers, screws, wedges and clamps. Only use original, undamaged parts (found in the catalogue). Regularly lubricate the threads and the binding surface of screws using, for example, heat-resistant lubricant (MOLYKOTE). For assembly and disassembly, only use screwdrivers and wrenches specified in our catalogue or recommended by the tool manufacturer. Be careful not to over-tighten. To avoid this, we advise using a pre-set torque wrench.

Es también importante comprobar los componentes de la fijación de la plaquita, incluyendo palancas, tornillos, cuñas, apoyos y bridas. Utilizar solamente repuestos originales nuevos (se encuentran en el catálogo). Lubricar regularmente las roscas y las áreas de contacto de los tornillos, utilizando por ejemplo lubricante resistente al calor (MOLYKOTE). Para el montaje y desmontaje, utilizar sólo los atornilladores y llaves especificadas en nuestro catálogo o recomendadas por el fabricante de la herramienta. Prestar atención al apriete correcto (proporcional) – se recomienda utilizar llaves dinámicas.

Il est également important de vérifier l'état des pièces de rechange, incluant les leviers de serrage, les vis, les coins et les brides. Utiliser uniquement des pièces d'origine et non endommagées (présentes dans le catalogue). Graisser régulièrement les filets et les surfaces de contact des vis, par exemple en utilisant une graisse résistante à la température (MOLYKOTE). Pour le serrage et le déserrage, utiliser les tournevis et les clés spécifiés dans notre catalogue ou recommandés par le fabricant d'outils. Veiller à appliquer le couple de serrage correct (proportionnel) – il est conseillé d'utiliser un tournevis dynamométrique.

**CHECK THE TIGHTENING / COMPROBAR EL APRIETE / VÉRIFICATION DU SERRAGE**

Before tightening, check the fit of the cutting insert on the whole of the binding surface and in the radial and axial directions. Cutting inserts and tools must always be clean and undamaged.

Antes de apretar, comprobar la forma en que la plaquita asienta en el portaherramientas, tanto en la superficie plana bajo el filo como en las paredes axial y radial del asiento. Herramientas y plaquitas deben estar siempre limpias y sin daños.

Au serrage, vérifier l'appui de la plaquette sur la surface de contact avec le trou et dans les directions radiale et axiale. Les plaquettes et les outils doivent rester propres et intacts.

Table 23  
Tabla 23  
Tableau 23

FORMULAS  
FORMULAS  
FORMULES

Value Valor Valeur	Unit Unidades Unité	Formula Formula Formule
Number of revolutions Número de revoluciones Vitesse de rotation	[rev/min] [rev/min] [tour/min]	$n = \frac{v_c \cdot 12}{D \cdot \pi}$
Cutting speed Velocidad de corte Vitesse de coupe	[ft/min]	$v_c = \frac{\pi \cdot D \cdot n}{12}$
Feed per revolution Avance por revolución Avance par tour	[in/rev] [in/rev] [in/tour]	$f_{rev} = \frac{f_{min}}{n} = f_z \cdot z$
Feed per minute (speed of feed) Avance por minuto (velocidad de avance) Avance par minute (avance linéaire)	[in/min]	$f_{min} = v_f = f_{rev} \cdot n = f_z \cdot z \cdot n$
Feed per tooth Avance por diente Avance par dent	[in/tooth] [in/diente] [in/dent]	$f_z = \frac{f_{rev}}{z} = \frac{f_{min}}{n \cdot z}$

Note / Nota / Note

Quantity Cantidad Quantité	Unit Unidades Unité	Quantity Cantidad Quantité	Unit Unidades Unité
<b>n</b> Number of revolutions Número de revoluciones Vitesse de rotation	[rev/min] [rev/min] [tour/min]	<b>f<sub>min</sub></b> Feed per minute (sometimes called speed of feed) Avance por minuto (tambien llamado velocidad de avance) Avance par minute (avance linéaire)	[in/min]
<b>D</b> Diameter (of tool or work piece) Diámetro (de la herramienta o de la pieza) Diamètre (de l'outil ou de la pièce à usiner)	[in]	<b>f<sub>z</sub></b> Feed per tooth Avance por diente Avance par dent	[in/tooth] [in/diente] [in/dent]
<b>v<sub>c</sub></b> Cutting speed Velocidad de corte Vitesse de coupe	[sfm]	<b>z</b> Number of teeth Número de dientes Nombre de dents	[-]
<b>f<sub>rev</sub></b> Feed per revolution Avance por revolución Avance par tour	[in/rev] [in/rev] [in/tour]		

Value Valor Valeur	Unit Unidades Unité	Formula Formula Formule
Chip cross section Sección de viruta Section copeau	[in <sup>2</sup> ]	$A = f_z \cdot a_p$
Chip thickness (for insert with straight edge) Espesor de viruta (para plaquitas con filo recto) Épaisseur du copeau (pour plaquette avec arête droite)	[in]	$h = f_z \cdot \sin \kappa_r$
Chip thickness (for round cutting insert) Espesor de viruta (para plaquitas redondas) Épaisseur du copeau (pour plaquette ronde)	[in]	$h = f_z \cdot \sqrt{\frac{a_p}{d}}$
Metal removal rate Volumen de viruta Taux d'enlèvement de matière	[in <sup>3</sup> /min]	$Q = a_p \cdot a_e \cdot f_{min}$

Note / Nota / Note

Quantity Cantidad Quantité	Unit Unidades Unité	Quantity Cantidad Quantité	Unit Unidades Unité
<b>A</b> Chip cross section Sección de viruta Section copeau	[in <sup>2</sup> ]	<b>h</b> Chip thickness Espesor de viruta Épaisseur du copeau	[in]
<b>f<sub>z</sub></b> Feed per tooth Avance por diente Avance par dent	[in/tooth] [in/diente] [in/dent]	<b>v<sub>c</sub></b> Cutting speed Velocidad de corte Vitesse de coupe	[sfm]
<b>a<sub>p</sub></b> Axial depth of cut (depth of cut) Profundidad de corte axial (profundidad de corte) Profondeur de coupe axiale	[in]	<b>f<sub>min</sub></b> Feed per minute (sometimes called speed of feed) Avance por minuto (tambien llamado velocidad de avance) Avance par minute (avance linéaire)	[in/min]
<b>a<sub>e</sub></b> Radial depth of cut (width of cut) Profundidad de corte radial (ancho de corte) Profondeur de coupe radiale	[in]	<b>Q</b> Material removal rate per minute Volumen de viruta por minuto Taux d'enlèvement de matière par minute	[in <sup>3</sup> /min]
<b>κ<sub>r</sub></b> Major edge setting angle Ángulo de posición Angle d'attaque principal	[°]		
<b>d</b> Diameter of insert Diámetro de la plaquitas Diamètre pour plaquette	[in]		



Table 23  
Tabla 23  
Tableau 23

FORMULAS  
FORMULAS  
FORMULES

Value Valor Valeur	Unit Unidades Unité	Formula Formula Formule
Power demand Consumo de potencia Puissance requise	[kW]	$P_c = a_p \cdot a_e \cdot f_{min} \cdot k_c \cdot k_\gamma$
Approximate power demand Consumo de potencia aproximada Puissance requise approximative	[kW]	$P_c = \frac{a_p \cdot a_e \cdot f_{min}}{X}$

Note / Nota / Note

Quantity Cantidad Quantité	Unit Unidades Unité	Quantity Cantidad Quantité	Unit Unidades Unité								
$P_c$ Power demand Consumo de potencia Puissance requise	[kW]	$k_c$ Cutting force per mm <sup>2</sup> Fuerza de corte por mm <sup>2</sup> Force de coupe par mm <sup>2</sup>	[MPa]								
$a_p$ Axial depth of cut (depth of cut) Profundidad de corte axial (profundidad de corte) Profondeur de coupe axiale	[in]	$k_\gamma$ Coefficient of influence of angle $\gamma_0$ Coeficiente de influencia del ángulo $\gamma_0$ Coefficient d'influence de l'angle $\gamma_0$	[°]								
$a_e$ Radial depth of cut (width of cut) Profundidad de corte radial (ancho de corte) Profondeur de coupe radiale	[in]	$\eta$ Machine efficiency usually $\eta = 0,75$ Eficiencia de máquina normalmente $\eta = 0,75$ Rendement machine généralement $\eta = 0,75$	[-]								
$f_{min}$ Feed per minute (sometimes called speed of feed) Avance por minuto (también llamado velocidad de avance) Avance par minute (avance linéaire)	[in/min]	$X$ Coefficient of influence of work piece material Coeficiente de influencia del material de la pieza Coefficient d'influence du matériau de la pièce usinée	[-]								
		<table border="1"> <thead> <tr> <th>Material Material Matériau</th> <th>Steel Acero Acier</th> <th>Cast iron Fundición Fonte</th> <th>Al Al Aluminium</th> </tr> </thead> <tbody> <tr> <td>Coefficient x Coeficiente x Coefficient x</td> <td>24 000</td> <td>30 000</td> <td>120 000</td> </tr> </tbody> </table>	Material Material Matériau	Steel Acero Acier	Cast iron Fundición Fonte	Al Al Aluminium	Coefficient x Coeficiente x Coefficient x	24 000	30 000	120 000	
Material Material Matériau	Steel Acero Acier	Cast iron Fundición Fonte	Al Al Aluminium								
Coefficient x Coeficiente x Coefficient x	24 000	30 000	120 000								


Clamping screw Tornillo Vis de fixation	Torque Par Couple	Thread Rosca Filetage	Length Longitud Longueur
	[Nm]	–	[in]
US 20	.9	M 2	.118
US 2205-T07P	.9	M 2,2	.197
US 25	1.2	M 2,5	.197
US 2505-T08P	1.2	M 2,5	.197
US 2506-T07P	1.2	M 2,5	.236
US 3006-T09P	2	M 3	.236
US 3007-T09P	2	M 3	.276
US 3504-T09P	3	M 3,5	.157
US 3507-T15	3	M 3,5	.276
US 3509-T15	3	M 3,5	.354
US 3511-T15	3	M 3,5	.433
US 3512-T15P	3	M 3,5	.472
US 4008-T15P	3.5	M 4	.315
US 4011-T15P	3.5	M 4	.433
US 4511-T20	5	M 4,5	.433
US 5012-T15P	5	M 5	.472
US 70	5	M 4	.197
US 71	5	M 4	.276
US 72	5	M 4	.354
US 73	5	M 4	.433
CS 3007-T08P	1.2	M 3	.276
CS 4008-T15P	3	M 4	.315
CS 42506-T07P	1	M 2,5	.236
CS 43008-T08P	1.2	M 3	.315
CS 43509-T10P	2	M 3,5	.354
CS 44013-T15P	3	M 4	.512
CS 45016-T20P	5	M 5	.630
CS 46020-T25P	7.5	M 6	.787
CS 48025-T40P	15	M 8	.984
CS 5009-T20P	5	M 5	.354
CS 5013-T20P	5	M 5	.512
CS 5015-T20P	5	M 5	.591
CS 6020-T20P	7.5	M 6	.787
CS 8025-T30P	15	M 8	.984
US 2505-T07P	1.2	M 2,5	.197
US 2506-T07P	1.2	M 2,5	.236
US 3007-T09P	2	M 3	.276
US 3505-T09P	3	M 3,5	.197
US 4011A-T15P	3.5	M 4	.433
US 4011-T15P	3.5	M 4	.433

Clamping screw Tornillo Vis de fixation	Torque Par Couple	Thread Rosca Filetage	Length Longitud Longueur
	[Nm]	–	[in]
US 44012-T15P	3.5	M 4	.472
US 45011-T20P	5	M 5	.433
US 45012-T20P	5	M 5	.472
US 5011-T20P	5	M 5	.433
US 5018-T20P	5	M 5	.709
US 52506-T07P	.8	M 2,5	.236
US 54511-T15P	5	M 4,5	.433
US 62003A-T06P	.6	M 2	.118
US 62004A-T06P	.6	M 2	.157
US 62004-T06P	.6	M 2	.157
US 62505-T07P	1.2	M 2,5	.197
US 62506-T07P	1.2	M 2,5	.236
US 62506-T08P	1.2	M 2,5	.236
US 62508-T08P	1.2	M 2,5	.276
US 63009-T09P	1.2	M 3	.354
US 63509-T15P	3	M 3,5	.394
US 63510-T10P	2	M 3,5	.354
US 63511D-T15P	3	M 3,5	.433
US 63513-T15P	3	M 3,5	.472
US 64014-T15P	3.5	M 4	.551
US 65013-T20	5	M 5	.512
US 65014-T20P	5	M 5	.551
US 65017-T20P	5	M 5	.669
US 66015-T25P	7.5	M 6	.591
US 68020-T30P	15	M 8	.787
US 68026-T30P	15	M 8	1.024
US 74016-T15P	3.5	M 4	.630


Table 24  
Tabla 24  
Tableau 24

**RECOMMENDED TORQUE OF CLAMPING SCREWS  
PAR DE APRIETE RECOMENDADO PARA TORNILLOS  
COUPLES DE SERRAGE RECOMMANDÉS**

**Torque screwdrivers / Atornilladores dinamométricos / Tournevis dynamométriques**

Torque handle Mango Tige dynamométrique		Torque [Nm] Par [Nm] Couple [Nm]	Clamping screw thread Rosca del tornillo de fijación Pas de la vis de fixation
MR-0,8-2,0 Vario		.5 – 2.0	M 2 – M 3
MR-1,0-5,0 Vario		.8 – 5.0	M 2,5 – M 5
MR-0,9 fix		.9	M 2
MR-2,0 fix		2.0	M 3
MR-3,0 fix		3.0	M 3,5
MR-3,5 fix		3.5	M 4
MR-5,0 fix		5.0	M 5

**Replaceable shanks / Vástagos sustituibles / Poignées remplaçables**

Replaceable shanks Vástagos sustituibles Poignées remplaçables	
D-T6	
D-T6P	
D-T7	
D-T7P	
D-T8	
D-T8P	
D-T9	
D-T9P	
D-T15	
D-T15P	
D-T20	
D-T20P	

**Screw lubrication**

Insert clamping screws are subject to high thermal stresses. It is recommended that all screws be lubricated with a high quality paste such as MOLYKOTE 1000. This paste can be ordered in the same way as any other spare part from Dormer Pramet.

**Lubricación de tornillos**

Los tornillos de fijación de plaquita están sometidos a una tensión térmica muy alta. Se recomienda que durante su montaje, todos los tornillos estén lubricados con pasta de alta calidad como MOLYKOTE 1000. Esta pasta se puede pedir a Dormer Pramet de la misma forma que cualquier otro repuesto.

**Lubrification des vis**

Dans le respect des contraintes thermiques élevées des vis de serrage, il est recommandé de les lubrifier avec une pâte haute qualité MOLYKOTE 1000. Cette pâte peut être recommandée de la même façon que les pièces détachées.

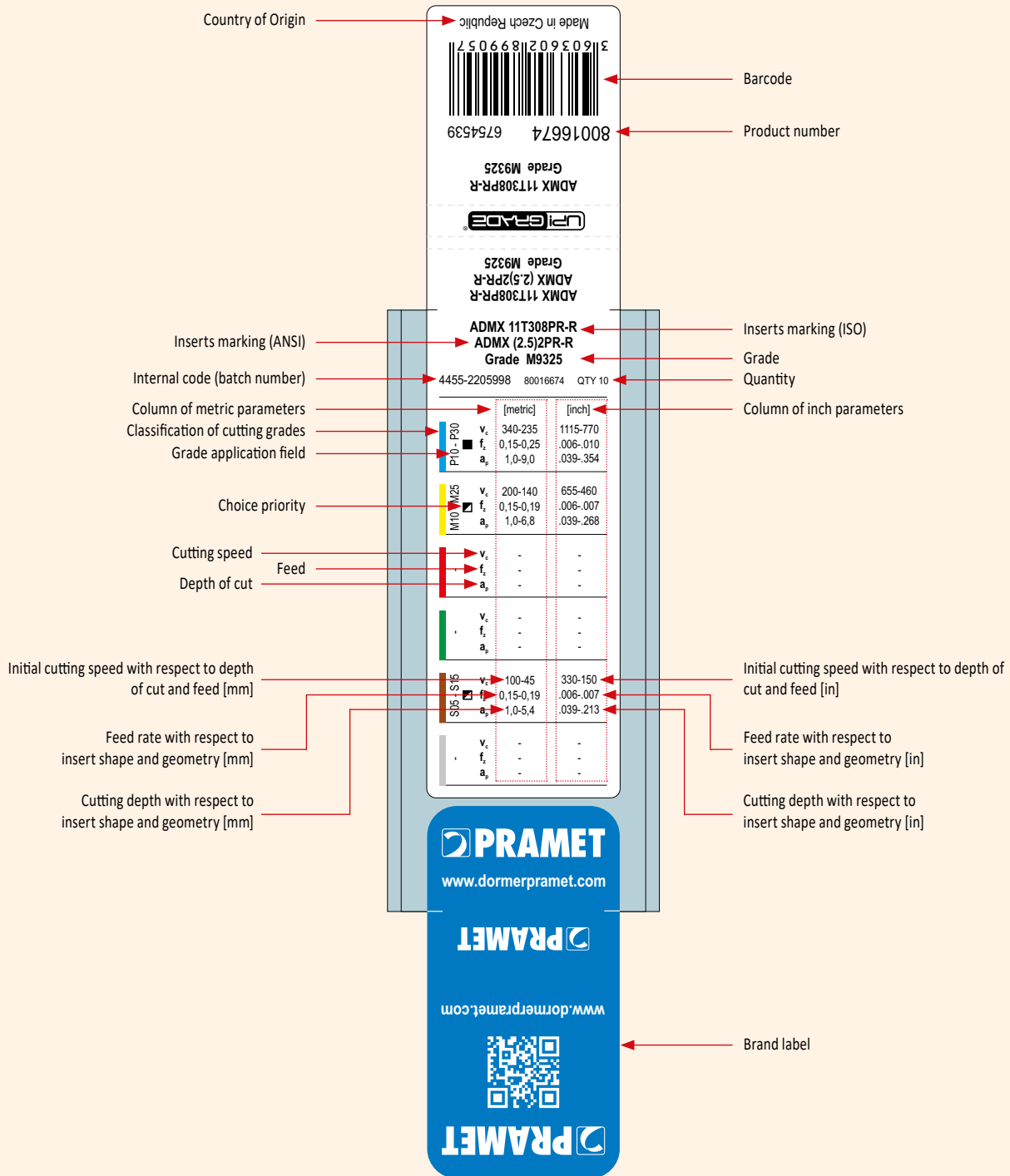
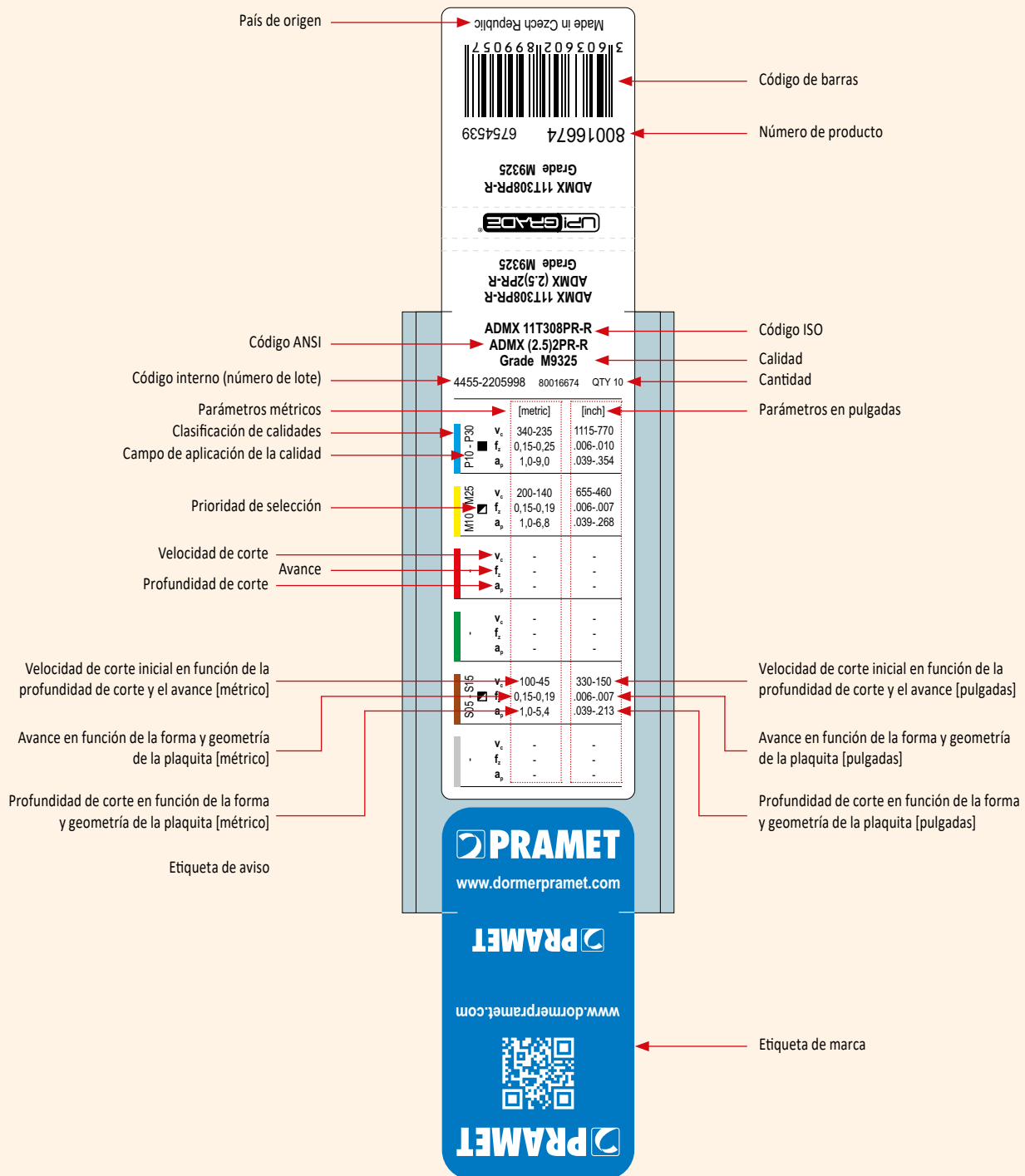
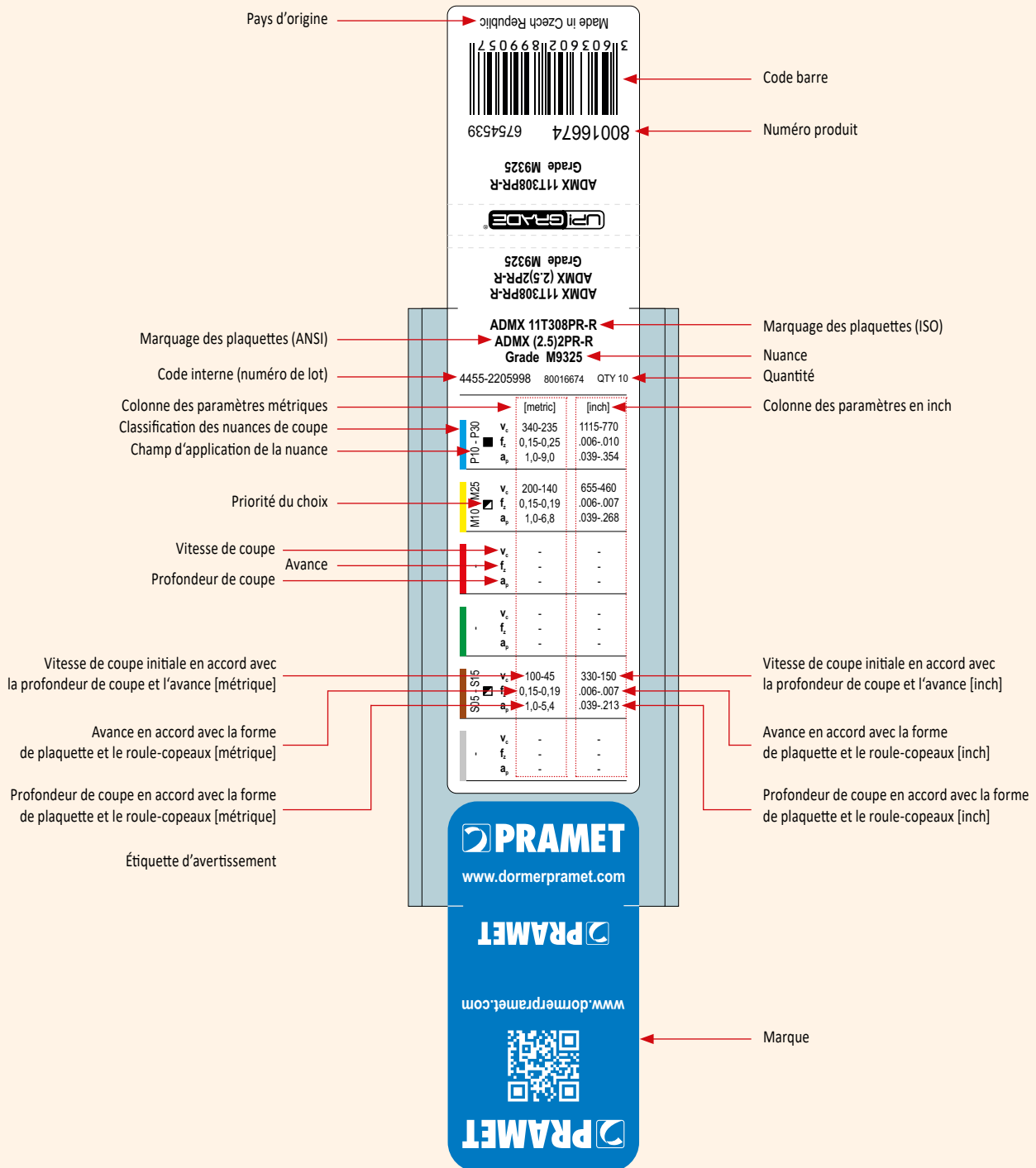



Figura 28

INFORMACIÓN TÉCNICA IMPRESA EN LA CAJA DE PLAQUITAS











**HOLE-MAKING  
TALADRADO  
PERÇAGE – ALÉSAGE**




**INSTRUCTIONS  
INSTRUCCIONES  
INSTRUCTIONS**

 [D2-D7](#)


**CODE KEY DRILLS  
LLAVE DE CÓDIGOS PARA BROCAS  
CODIFICATION DES FORETS**

 [D8 - D9](#)


**INDEXABLE DRILLS  
BROCAS DE PLAQUITA INTERCAMBIABLE  
FORETS A PLAQUETTES INDEXABLES**

 [D10 - D15](#)

**INDEXABLE INSERTS  
PLAQUITAS  
PLAQUETTES INDEXABLES**

 [D16 - D18](#)

**TECHNICAL INFORMATION  
INFORMACIÓN TÉCNICA  
INFORMATIONS TECHNIQUES**

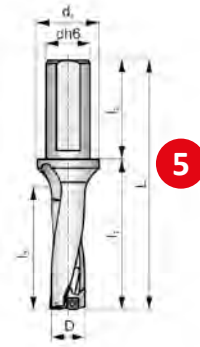
 [D19 - D37](#)

**1** **1803D** **P** **M** **K** **N** **S** **2**

**3** **S**



**4**



**5**

**6**



ANSI	D	h <sub>max</sub>	L	l <sub>1</sub>	l <sub>2</sub>	l <sub>3</sub>	dh6	d <sub>1</sub>	$\bar{D}$	$\bar{D}^+$					
<b>803D-0594-178-S100</b>	.594	1.783	5.012	2.768	2.244	1.941	1.000	1.378	.012	.012	EP253253	IGI300	IGI313	.71	IHM001
<b>803D-0625-187-S100</b>	.625	1.875	5.102	2.858	2.244	2.047	1.000	1.378	.006	.016	EP253253	IGI300	IGI313	.73	IHM001
<b>803D-0656-196-S100</b>	.656	1.969	5.197	2.953	2.244	2.157	1.000	1.378	.006	.016	EP253253	IGI300	IGI313	.73	IHM001
<b>803D-0687-206-S100</b>	.687	2.061	5.287	3.043	2.244	2.244	1.000	1.378	.020	.020	EP253253	IGI301	IGI314	.79	IHM002
<b>803D-0709-212-S100</b>	.709	2.127	5.354	3.110	2.244	2.323	1.000	1.378	.014	.008	EP253253	IGI302	IGI315	.79	IHM003
<b>803D-0750-225-S100</b>	.750	2.250	5.476	3.232	2.244	2.425	1.000	1.378	.012	.014	EP253253	IGI301	IGI314	.79	IHM002
<b>803D-0766-229-S100</b>	.766	2.298	5.528	3.283	2.244	2.484	1.000	1.378	.008	.020	EP253253	IGI302	IGI315	.79	IHM003
<b>803D-0787-236-S100</b>	.787	2.361	5.591	3.346	2.244	2.559	1.000	1.378	.008	.020	EP253253	IGI302	IGI315	.82	IHM003

IGI300	XPET 0502AP	SCET 050204-UD
IGI301	XPET 0602AP	SCET 050204-UD
IGI302	XPET 0602AP	SCET 060204-UD
IGI303	XPET 0703AP	SCET 060204-UD
IGI304	XPET 0703AP	SCET 070308-UD
IGI305	XPET 0903AP	SCET 070308-UD
IGI306	XPET 0903AP	SCET 09T308-UD
IGI307	XPET 11T3AP	SCET 09T308-UD
IGI308	XPET 11T3AP	SCET 120408-UD
IGI309	XPET 12T3AP	SCET 120408-UD
IGI310	XPET 1504AP	SCET 120408-UD
IGI311	XPET 1504AP	SCET 150512-UD
IGI312	XPET 1904AP	SCET 150512-UD
IGI313	XPET 0502AP-SD	SCET 050204-SD
IGI314	XPET 0602AP-SD	SCET 050204-SD
IGI315	XPET 0602AP-SD	SCET 060204-SD
IGI316	XPET 0703AP-SD	SCET 060204-SD
IGI317	XPET 0703AP-SD	SCET 070308-SD

IHM001	US 2245-T07P	0.9	US 2245-T07P	0.9	FLAG T07P
IHM002	US 2205-T07P	0.9	US 2245-T07P	0.9	FLAG T07P
IHM003	US 2205-T07P	0.9	US 2205-T07P	0.9	FLAG T07P
IHM004	US 2506-T07P	1.2	US 2506-T07P	1.2	FLAG T07P

1	Designation of drill Designación Désignation du foret	10	Radial setting [in] Ajuste radial [in] Réglage radial [in]
2	Material group recommendations Gupos de material Groupes de matériaux pour lesquels l'outil est indiqué	11	Adjustable sleeve Casquillo ajustable Bague excentrique
3	Clamping system of insert Sistema de fijación de la plaquita Système de fixation de la plaquette	12	Group of compatible inserts with chip breaker UD <sup>1), 2)</sup> Grupo de plaquitas compatibles con rompevirutas UD <sup>1), 2)</sup> Groupe de plaquettes compatibles avec le brise-copeaux UD <sup>1), 2)</sup>
4	Illustrative picture Esquema Ilustrativo Image pour illustration	13	Group of compatible inserts with chip breaker SD <sup>1), 2)</sup> Grupo de plaquitas compatibles con rompevirutas SD <sup>1), 2)</sup> Groupe de plaquettes compatibles avec le brise-copeaux SD <sup>1), 2)</sup>
5	Schematic drawing of tool Esquema de la herramienta Dessin schématique de l'outil	14	Weight [kg] Peso [kg] Poids [kg]
6	Basic parameters of drill Parámetros básicos Paramètres de base du foret	15	Group of spare parts <sup>1)</sup> Grupo de repuestos <sup>1)</sup> Groupe de pièces de rechange <sup>1)</sup>
7	Possible applications Posibilidades tecnológicas de la herramienta Possibilités technologiques de l'outil	16	Compatible inserts with chip breaker UD Plaquitas compatibles con rompevirutas UD Plaquettes compatibles avec le brise-copeaux UD
8	Tool code Codificación Code outil	17	Compatible inserts with chip breaker SD Plaquitas compatibles con rompevirutas SD Plaquettes compatibles avec le brise-copeaux SD
9	Tool dimensions [in]; maximal depth of hole $h_{max}$ [in] Dimensiones (in) y diámetros de herramienta [in]; máxima profundidad de agujero $h_{max}$ [in] Dimensions [in] et diamètres de l'outil [in]; profondeur maximum de perçage $h_{max}$ [in]	18	Spare parts Repuestos Pièces de rechange

<sup>1)</sup> Code of Group of compatible inserts and spare parts is used only for purposes of this catalogue. It cannot be used for orders.

<sup>2)</sup> External (SCET) and internal (XPET) inserts must always have the same chip breaker (please note: UD chip breaker is not visibly included in designation of XPET inserts – e.g. XPET 0502AP); info needed for correct choice of chip breaker (UD vs SD) can be found on the insert packaging.

<sup>1)</sup> Le code du groupe de plaquettes compatibles, des pièces de rechange et des accessoires spéciaux n'est utilisable que pour naviguer dans ce catalogue. Il ne peut pas être utilisé pour des commandes.

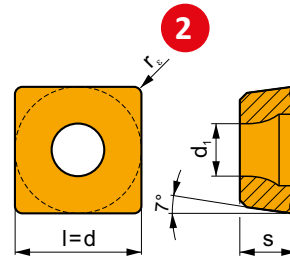
<sup>2)</sup> Les plaquettes extérieures (SCET) et intérieures (XPET) doivent toujours avoir le même brise-copeaux (note: le brise-copeaux UD n'est pas visiblement inclus dans la désignation des plaquettes XPET – ex: XPET 0502AP); l'information nécessaire au choix correct du brise-copeaux (UD ou SD) est située dans la partie plaquettes.

<sup>1)</sup> El código del grupo de plaquitas compatibles y repuestos se utiliza sólo para el uso de este catálogo. No puede ser utilizado para pedidos.

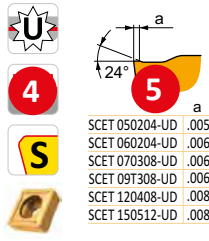
<sup>2)</sup> Las plaquitas exteriores (SCET) e interiores (XPET) deben tener siempre el mismo rompevirutas (tener en cuenta: el rompevirutas UD no está visiblemente incluido en la designación de las plaquitas XPET – por ejemplo XPET 0502AP); la información necesaria para la elección correcta del rompevirutas (UD vs SD) se incluye en el lateral de la caja de plaquitas.

**1 SCET**

	d	d <sub>i</sub>	l	s
0502	.219	.094	.219	.094
0602	.250	.114	.250	.094
0703	.312	.138	.312	.125
09T3	.375	.177	.375	.156
1204	.500	.220	.500	.187
1505	.625	.220	.625	.219





i		ANSI		P	M	K	N	S	H	?		r <sub>c</sub>	f <sub>min</sub>	f <sub>max</sub>	a <sub>p min</sub>	a <sub>p max</sub>
		SCET 050204-UD	D8330	■	□	■				●	+++	.016	.002	.004	-	-
			D9335	■	□	■				●	+++	.016	.002	.004	-	-
		SCET 060204-UD	D8330	■	□	■				●	+++	.016	.002	.006	-	-
			D9335	■	□	■				●	+++	.016	.002	.006	-	-
		SCET 070308-UD	D8330	■	□	■				●	+++	.016	.003	.007	-	-
			D9335	■	□	■				●	+++	.016	.003	.007	-	-
		SCET 09T308-UD	D8330	■	□	■				●	+++	.031	.003	.008	-	-
			D9335	■	□	■				●	+++	.031	.003	.008	-	-
		SCET 120408-UD	D8330	■	□	■				●	+++	.031	.004	.009	-	-
			D9335	■	□	■				●	+++	.031	.004	.009	-	-
		SCET 150512-UD	D8330	■	□	■				●	+++	.047	.004	.010	-	-
			D9335	■	□	■				●	+++	.047	.004	.010	-	-



<b>1</b>	Designation of insert Designación Désignation de la plaquette	<b>7</b>	Grade Calidad Nuance
<b>2</b>	Schematic drawing of insert Esquema de la plaquita Dessin schématique de la plaquette	<b>8</b>	Application area of insert Área de aplicación Domaine d'application de la plaquette
<b>3</b>	Table with insert sizes [in] Tabla con tamaños de plaquita [in] Tableau des tailles de plaquettes [in]	<b>9</b>	Suitability of insert use with respect to specific working conditions Uso de plaquetas en función de las condiciones de trabajo Possibilité d'utilisation de la plaquette en fonction des conditions de travail spécifiques
<b>4</b>	Icons – specific features, cutting edge type and picture of representative insert Iconos – características específicas, tipo de filo de corte y foto representativa de la plaquita Icônes – caractéristiques spécifiques, type d'arête de coupe et photo d'une plaquette représentative	<b>10</b>	Influence of use of cutting fluids in continual cut Influencia del uso de fluidos de corte en corte continuo Influence de l'usage du fluide en coupe continue
<b>5</b>	Profile of main cutting edge Perfil del filo de corte Profil de l'arête de coupe principale	<b>11</b>	Insert radii [in] Radio de plaquita [in] Rayon de plaquette [in]
<b>6</b>	ISO code of insert Codificación ISO de plaquetas Code ISO de la plaquette	<b>12</b>	Maximum range of feed [in/rev] Gama máxima de avance [in/rot] Plage d'avances [in/tr]

**ICONS AND SYMBOLS – DRILLING**  
**ICONOS Y SÍMBOLOS – TALADRADO**  
**ICÔNES ET SYMBOLES – PERÇAGE**

 Priority use  
 Uso prioritario  
 Utilisation prioritaire



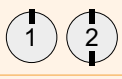


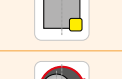

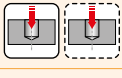
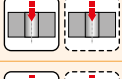
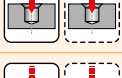
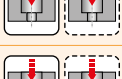
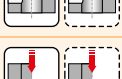
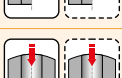
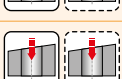
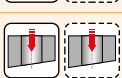
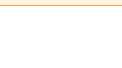
 Possible use  
 Uso posible  
 Utilisation possible

Icon absence – tool is not recommended for specific operation or group of materials or it does not have specific feature

Ausencia de icono – la herramienta no se recomienda para la operación específica, grupo de materiales o no tiene ninguna característica específica

Absence d'icône – outil non recommandé pour l'opération spécifique ou pour le groupe de matériaux ou parce qu'il ne possède pas de caractéristiques spécifiques

**Icons – drills / Iconos – broca / Icônes – forets**

General features of tools / Características generales de las herramienta / Caractéristiques principales des outils			
	Material groups	Grupos de materiales	Groupe de matériaux
	Working length of drill	Longitud de trabajo de la broca	Longueur de travail du foret
	Number of effective cutting teeth per revolution	Número de dientes efectivos por revolución	Nombre d'arêtes de coupe effectives par révolution
	Universal shank	Mango universal	Queue universelle
	Internal cooling	Refrigeración interna	Arrosage interne
	Monoblock design	Diseño monoblock	Monobloc
	Possibility of use for eccentric machining	Posibilidad de utilizar para mecanizado excéntrico	Utilisation possible pour usinage excentrique
Technological possibilities of tools / Posibilidades tecnológicas de la herramienta / Possibilités technologiques des outils			
	Blind hole drilling	Taladrado de agujero ciego	Perçage d'un trou borgne
	Through hole drilling	Taladrado de agujero pasante	Perçage d'un trou débouchant
	Drilling into center drilled hole	Taladrado de agujero con punto de centrado	Perçage dans un trou de centre
	Boring	Mandrinado	Alésage
	Drilling across an existing hole	Taladrado de agujeros cruzados	Perçage à travers un trou existant
	Interrupted cut	Corte interrumpido	Coupe interrompue
	Drilling onto curved surface	Taladrado en una superficie curva	Perçage sur une surface incurvée
	Drilling onto inclined surface	Taladrado en una superficie inclinada	Perçage sur une surface inclinée
	Drill exit on inclined surface	Salida de broca en superficie inclinada	Perçage avec sortie sur surface inclinée

	Welded joint drilling	Taladrado de cordón de soldadura	Perçage de points de soudure
	Drilling of stacked materials	Taladrado de paquetes	Perçage de matériaux empilés
	Helical interpolation drilling	Taladrado por interpolación helicoidal	Perçage par interpolation hélicoïdale
	Helical interpolation boring	Mandrinado por interpolación helicoidal	Alésage par interpolation hélicoïdale
	Chamfering (beveling)	Achaflanado	Chanfreinage (fraisage)
	Blind hole boring	Mandrinado de agujero ciego	Alésage d'un trou borgne
	Through hole boring	Mandrinado de agujero pasante	Alésage d'un trou débouchant
	Boring through cross holes	Mandrinado con agujeros cruzados	Alésage à travers de trous existants
<b>Others / Otros / Autres</b>			
	Clamping torque of screw [Nm]	Par de apriete del tornillo [Nm]	Couple de serrage de la vis [Nm]

Icons and symbols – inserts / Iconos y símbolos – plaquitas / Icônes et symboles – plaquettes

Features / Características / Caractéristiques			
	Universal wide range option	Gama completa universal	Large gamme de solution universelle
	Heavy working conditions	Condiciones de trabajo pesadas	Conditions de travail très difficiles
	For tough machined materials (long chip)	Para materiales difíciles (viruta larga)	Pour matériaux tenaces (copeaux longs)
	Rounded edge with facet	Filo redondeado con faceta	Arête arrondie avec listel
Conditions of use / Condiciones de uso/ Conditions d'utilisation			
	Main application	Aplicación principal	Applcation principale
	Secondary application	Aplicación secundaria	Application secondaire
	Supplementary application	Aplicación suplementaria	Application supplémentaire
	Stable working conditions	Condiciones de trabajo estables	Conditions de travail stables
	Unstable working conditions	Condiciones de trabajo inestables	Conditions de travail instables

**ICONS AND SYMBOLS – DRILLING**  
**ICONOS Y SÍMBOLOS – TALADRADO**  
**ICÔNES ET SYMBOLES – PERÇAGE**

	Very unstable working conditions	Condiciones de trabajo muy inestables	Conditions de travail très instables
---	Very negative effect on tool life – cooling is not recommended	Efecto muy negativo en la vida de filo – no se recomienda refrigerante	Effet très négatif sur la durée de vie de l'outil – L'arrosage n'est pas recommandé
--	Negative effect on tool life – cooling is not recommended	Efecto negativo en la vida de filo – no se recomienda refrigerante	Effet négatif sur la durée de vie de l'outil – L'arrosage n'est pas recommandé
-	Slightly negative effect on tool life	Efecto ligeramente negativo en la vida de filo	Effet légèrement négatif sur la durée de vie de l'outil
+ / -	Influence of cooling may be both positive and negative – decisive factor is specific working conditions	La influencia del refrigerante puede ser positiva o negativa – depende de las condiciones de trabajo	L'influence de l'arrosage peut être positive ou négative – les conditions spécifiques de travail sont le facteur décisif
+	Slightly positive effect on tool life	Efecto ligeramente positivo en la vida de filo	Effet légèrement positif sur la durée de vie de l'outil
++	Positive effect on tool life – cooling is recommended	Efecto positivo en la vida de filo – se recomienda refrigerante	Effet positif sur la durée de vie de l'outil – L'arrosage est recommandé
+++	Very positive effect on tool life – cooling is recommended	Efecto muy positivo en la vida de filo – se recomienda refrigerante	Effet très positif sur la durée de vie de l'outil – L'arrosage est recommandé

**Icons – technical part / Iconos – parte técnica / Icônes – partie technique**

	Feed [in/rev]	Avance [in/rev]	Avance [in/tour]
	Very high cutting speed, excellent system rigidity (stable working conditions)	Velocidad de corte muy alta (condiciones estables)	Vitesse de coupe très élevée, excellente rigidité du système (conditions de travail stables)
	High cutting speed, high system rigidity (stable working conditions)	Velocidad de corte alta, alta rigidez del sistema (condiciones estables)	Vitesse de coupe élevée, bonne rigidité du système (conditions de travail stables)
	High cutting speed, system rigidity slightly limited (depth of cut changing)	Velocidad de corte media, rigidez del sistema limitada (corte ligeramente interrumpido)	Vitesse de coupe élevée, rigidité du système légèrement limitée (variation de la profondeur de coupe)
	Medium cutting speed, system rigidity limited (slightly interrupted cut)	Velocidad de corte media, rigidez del sistema limitada (corte ligeramente interrumpido)	Vitesse de coupe moyenne, rigidité du système limitée (coupe légèrement interrompue)
	Low cutting speed, low system rigidity (interrupted cut)	Velocidad de corte baja, rigidez del sistema baja (corte interrumpido)	Vitesse de coupe faible, mauvaise rigidité du système (coupe interrompue)
	Very low cutting speed, very low system rigidity (very unstable working conditions)	Velocidad de corte muy baja, rigidez del sistema muy baja (condiciones muy inestables)	Vitesse de coupe très faible, très mauvaise rigidité du système (conditions de travail très instables)



Indexable drill\* / Brocas con plaquitas\* / Forets à plaquettes indexables\*

<b>1</b>	<b>2</b>	<b>3</b>	<b>4</b>	<b>5</b>	<b>6</b>	<b>7</b>
<b>8</b>	<b>04</b>	<b>D</b>	<b>1000</b>	<b>400</b>	<b>S</b>	<b>125</b>

\*Marking is valid for types produced from 2011 / \*Marcaje válido para tipos producidos a partir de 2011  
 \*Le marquage est valable pour les forets produits depuis 2011

1		2		3		4	
Tool type Tipo de herramienta Type d'outil		Approximate length Longitud aproximada Longueur approximative		Variant Variante Version		Cutting diameter Diámetro de corte Diamètre de coupe	
<b>8</b>	Indexable drill Broca intercambiable Foret à plaquettes indexables	<b>02</b>	2 × D	<b>D</b>	Drill Broca Foret	<b>1000</b>	1.000 in
		<b>03</b>	3 × D				
		<b>04</b>	4 × D				
5		6		7			
Max. drilling depth Profundidad de taladrado máx. Profondeur de perçage max.		Type of shank Tipo de mango Type de queue		Shank diameter Diámetro del mango Diamètre de queue			
<b>400</b>	4.000 in	<b>S</b>	ISO 9766	<b>125</b>	1.250 in		



**INDEXABLE DRILLS OVERVIEW**  
**VISION GENERAL DE LAS BROCAS INDEXABLES**  
**FORETS A PLAQUETTES INDEXABLES**

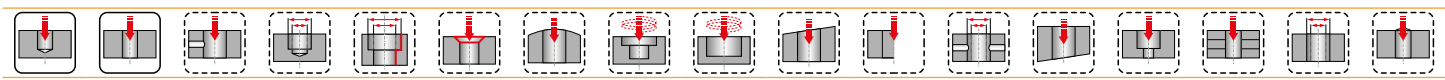
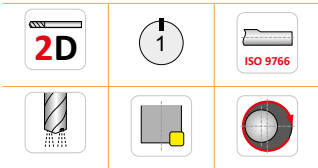
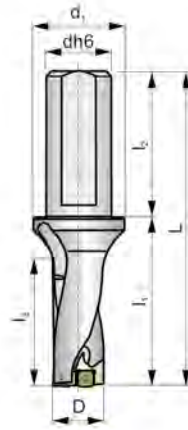
Working length / Longitud util Longueur utile				XPET..AP	SCET..-UD	XPET..AP-SD	SCET..-SD
Picture / Foto Photo							
Coolant / Refrigeración Refroidissement				-	-	-	-
	<b>D10 – D11</b>	<b>D12 – D13</b>	<b>D14 – D15</b>	<b>D17</b>	<b>D16</b>	<b>D17</b>	<b>D16</b>
Drill type / Tipo de broca Type de foret	802D	803D	804D	-	-	-	-
Drill tolerance / Tolerancia de la broca Tolérance de foret	± .002	± .002	± .002	-	-	-	-
Hole tolerance * / Tolerancia del agujero * Tolérance de perçage *	0 /+.008	0 /+.012	0 /+.016	-	-	-	-
Surface finish * / Acabado superficial * Finition de surface *	R <sub>3</sub> 78.74 - 236.22µin	R <sub>3</sub> 78.74 - 236.22µin	R <sub>3</sub> 78.74 - 236.22µin	-	-	-	-
Diameter range / Campo de diámetros Plage de diamètres	15,0 – 40,0 mm .591 – 1.575 in	15,0 – 58,0 mm .591 – 2.283 in	17,0 – 58,0 mm .669 – 2.283 in	-	-	-	-
Application areas Área de aplicación Domaines d'application	P1	<input checked="" type="checkbox"/>	<input checked="" type="checkbox"/>	<input checked="" type="checkbox"/>	<input checked="" type="checkbox"/>	<input checked="" type="checkbox"/>	<input checked="" type="checkbox"/>
	P2	<input checked="" type="checkbox"/>	<input checked="" type="checkbox"/>	<input checked="" type="checkbox"/>	<input checked="" type="checkbox"/>	<input checked="" type="checkbox"/>	<input checked="" type="checkbox"/>
	P3	<input checked="" type="checkbox"/>	<input checked="" type="checkbox"/>	<input checked="" type="checkbox"/>	<input checked="" type="checkbox"/>	<input checked="" type="checkbox"/>	<input checked="" type="checkbox"/>
	P4	<input checked="" type="checkbox"/>	<input checked="" type="checkbox"/>	<input checked="" type="checkbox"/>	<input checked="" type="checkbox"/>	<input checked="" type="checkbox"/>	<input checked="" type="checkbox"/>
	M1	<input type="checkbox"/>	<input type="checkbox"/>	<input type="checkbox"/>	<input checked="" type="checkbox"/>	<input checked="" type="checkbox"/>	<input checked="" type="checkbox"/>
	M2	<input type="checkbox"/>	<input type="checkbox"/>	<input type="checkbox"/>	<input checked="" type="checkbox"/>	<input checked="" type="checkbox"/>	<input checked="" type="checkbox"/>
	M3	<input type="checkbox"/>	<input type="checkbox"/>	<input type="checkbox"/>	<input checked="" type="checkbox"/>	<input checked="" type="checkbox"/>	<input checked="" type="checkbox"/>
	M4	<input type="checkbox"/>	<input type="checkbox"/>	<input type="checkbox"/>	<input checked="" type="checkbox"/>	<input checked="" type="checkbox"/>	<input checked="" type="checkbox"/>
	K1	<input checked="" type="checkbox"/>	<input checked="" type="checkbox"/>	<input checked="" type="checkbox"/>	<input checked="" type="checkbox"/>	<input checked="" type="checkbox"/>	<input checked="" type="checkbox"/>
	K2	<input checked="" type="checkbox"/>	<input checked="" type="checkbox"/>	<input checked="" type="checkbox"/>	<input checked="" type="checkbox"/>	<input checked="" type="checkbox"/>	<input checked="" type="checkbox"/>
	K3	<input checked="" type="checkbox"/>	<input checked="" type="checkbox"/>	<input checked="" type="checkbox"/>	<input checked="" type="checkbox"/>	<input checked="" type="checkbox"/>	<input checked="" type="checkbox"/>
	K4	<input checked="" type="checkbox"/>	<input checked="" type="checkbox"/>	<input checked="" type="checkbox"/>	<input checked="" type="checkbox"/>	<input checked="" type="checkbox"/>	<input checked="" type="checkbox"/>
	N1	<input type="checkbox"/>	<input type="checkbox"/>	<input type="checkbox"/>	<input type="checkbox"/>	<input type="checkbox"/>	<input type="checkbox"/>
	N2	<input type="checkbox"/>	<input type="checkbox"/>	<input type="checkbox"/>	<input type="checkbox"/>	<input type="checkbox"/>	<input type="checkbox"/>
	N3	<input type="checkbox"/>	<input type="checkbox"/>	<input type="checkbox"/>	<input type="checkbox"/>	<input type="checkbox"/>	<input type="checkbox"/>
	N4	<input type="checkbox"/>	<input type="checkbox"/>	<input type="checkbox"/>	<input type="checkbox"/>	<input type="checkbox"/>	<input type="checkbox"/>
S1	<input type="checkbox"/>	<input type="checkbox"/>	<input type="checkbox"/>	<input checked="" type="checkbox"/>	<input checked="" type="checkbox"/>	<input checked="" type="checkbox"/>	
S2	<input type="checkbox"/>	<input type="checkbox"/>	<input type="checkbox"/>	<input checked="" type="checkbox"/>	<input checked="" type="checkbox"/>	<input checked="" type="checkbox"/>	
S3	<input type="checkbox"/>	<input type="checkbox"/>	<input type="checkbox"/>	<input checked="" type="checkbox"/>	<input checked="" type="checkbox"/>	<input checked="" type="checkbox"/>	
S4	<input type="checkbox"/>	<input type="checkbox"/>	<input type="checkbox"/>	<input checked="" type="checkbox"/>	<input checked="" type="checkbox"/>	<input checked="" type="checkbox"/>	

\* The tolerance of drilled hole and surface finish are heavily dependent on machining conditions  
\* La tolerancia del agujero y el acabado superficial dependen en gran medida de las condiciones de mecanizado  
\* La tolérance du perçage et de la finition de surface dépendent fortement des caractéristiques de la machine

**I802D**

**P M K N S**

**S**



ANSI	D	h <sub>max</sub>	L	l <sub>1</sub>	l <sub>2</sub>	l <sub>3</sub>	dh6	d <sub>1</sub>	$\bar{D}$	$\bar{D}^+$					
802D-0594-118-S100	.594	1.188	4.417	2.173	2.244	1.346	1.000	1.378	.012	.012	EP253253	IGI300	IGI313	.68	IHM001
802D-0625-125-S100	.625	1.250	4.480	2.236	2.244	1.425	1.000	1.378	.006	.016	EP253253	IGI300	IGI313	.71	IHM001
802D-0656-131-S100	.656	1.312	4.539	2.295	2.244	1.500	1.000	1.378	.006	.016	EP253253	IGI300	IGI313	.71	IHM001
802D-0687-137-S100	.687	1.374	4.602	2.358	2.244	1.559	1.000	1.378	.020	.020	EP253253	IGI301	IGI314	.73	IHM002
802D-0709-141-S100	.709	1.418	4.646	2.402	2.244	1.614	1.000	1.378	.014	.008	EP253253	IGI301	IGI314	.73	IHM002
802D-0750-150-S100	.750	1.500	4.728	2.484	2.244	1.677	1.000	1.378	.012	.014	EP253253	IGI301	IGI314	.73	IHM002
802D-0766-153-S100	.766	1.532	4.760	2.516	2.244	1.717	1.000	1.378	.008	.020	EP253253	IGI302	IGI315	.75	IHM003
802D-0787-157-S100	.787	1.574	4.803	2.559	2.244	1.772	1.000	1.378	.008	.020	EP253253	IGI302	IGI315	.75	IHM003
802D-0812-162-S100	.812	1.624	4.850	2.606	2.244	1.831	1.000	1.378	.004	.019	EP253253	IGI302	IGI315	.77	IHM003
802D-0827-165-S100	.827	1.654	4.882	2.638	2.244	1.870	1.000	1.378	.004	.019	EP253253	IGI302	IGI315	.77	IHM003
802D-0875-175-S100	.875	1.750	4.976	2.732	2.244	1.992	1.000	1.378	.011	.019	EP253253	IGI303	IGI316	.82	IHM004
802D-0906-181-S100	.906	1.812	5.039	2.795	2.244	2.067	1.000	1.378	.008	.019	EP253253	IGI304	IGI317	.79	IHM005
802D-0937-187-S100	.937	1.874	5.102	2.858	2.244	2.146	1.000	1.378	.004	.019	EP253253	IGI304	IGI317	.84	IHM005
802D-0984-196-S125	.984	1.969	5.315	2.953	2.362	2.165	1.250	1.654	.004	.019	EP324058	IGI304	IGI317	1.26	IHM005
802D-1000-200-S125	1.000	2.000	5.346	2.984	2.362	2.205	1.250	1.654	.004	.019	EP324058	IGI304	IGI317	1.28	IHM005
802D-1032-206-S125	1.032	2.064	5.409	3.047	2.362	2.283	1.250	1.654	.004	.019	EP324058	IGI305	IGI318	1.30	IHM006
802D-1062-212-S125	1.062	2.124	5.469	3.106	2.362	2.358	1.250	1.654	.020	.008	EP324058	IGI305	IGI318	1.30	IHM006
802D-1109-221-S125	1.109	2.218	5.563	3.201	2.362	2.476	1.250	1.654	.020	.014	EP324058	IGI306	IGI319	1.34	IHM007
802D-1125-225-S125	1.125	2.250	5.598	3.236	2.362	2.520	1.250	1.654	.020	.014	EP324058	IGI306	IGI319	1.37	IHM007
802D-1187-237-S125	1.187	2.374	5.720	3.358	2.362	2.669	1.250	1.654	.014	.020	EP324058	IGI306	IGI319	1.43	IHM007
802D-1250-250-S150	1.250	2.500	6.122	3.484	2.638	2.669	1.500	1.969	.006	.020	-	IGI307	IGI320	2.07	IHM008
802D-1312-262-S150	1.312	2.624	6.244	3.606	2.638	2.827	1.500	1.969	.020	.020	-	IGI307	IGI320	2.16	IHM008
802D-1375-275-S150	1.375	2.750	6.370	3.732	2.638	2.945	1.500	1.969	.008	.020	-	IGI308	IGI321	2.23	IHM009
802D-1437-287-S150	1.437	2.874	6.496	3.858	2.638	3.098	1.500	1.969	.004	.020	-	IGI308	IGI321	2.29	IHM009
802D-1500-300-S150	1.500	3.000	6.622	3.984	2.638	3.256	1.500	1.969	.006	.020	-	IGI308	IGI321	2.43	IHM009
802D-1750-350-S150	1.750	3.500	7.094	4.457	2.638	3.894	1.500	1.969	.020	.020	-	IGI309	IGI322	2.87	IHM010
802D-2000-400-S150	2.000	4.000	7.626	4.988	2.638	4.394	1.500	2.205	.006	.020	-	IGI310	IGI323	3.70	IHM010

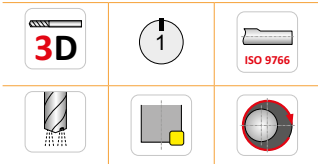
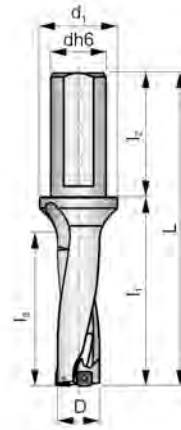
IGI300	XPET 0502AP	SCET 050204-UD
IGI301	XPET 0602AP	SCET 050204-UD
IGI302	XPET 0602AP	SCET 060204-UD
IGI303	XPET 0703AP	SCET 060204-UD
IGI304	XPET 0703AP	SCET 070308-UD
IGI305	XPET 0903AP	SCET 070308-UD
IGI306	XPET 0903AP	SCET 09T308-UD
IGI307	XPET 11T3AP	SCET 09T308-UD
IGI308	XPET 11T3AP	SCET 120408-UD
IGI309	XPET 1504AP	SCET 120408-UD
IGI310	XPET 1504AP	SCET 150512-UD
IGI313	XPET 0502AP-SD	SCET 050204-SD
IGI314	XPET 0602AP-SD	SCET 050204-SD
IGI315	XPET 0602AP-SD	SCET 060204-SD
IGI316	XPET 0703AP-SD	SCET 060204-SD
IGI317	XPET 0703AP-SD	SCET 070308-SD
IGI318	XPET 0903AP-SD	SCET 070308-SD
IGI319	XPET 0903AP-SD	SCET 09T308-SD
IGI320	XPET 11T3AP-SD	SCET 09T308-SD
IGI321	XPET 11T3AP-SD	SCET 120408-SD
IGI322	XPET 1504AP-SD	SCET 120408-SD
IGI323	XPET 1504AP-SD	SCET 150512-SD

IHM001	US 2245-T07P	0.9	US 2245-T07P	0.9	FLAG T07P
IHM002	US 2205-T07P	0.9	US 2245-T07P	0.9	FLAG T07P
IHM003	US 2205-T07P	0.9	US 2205-T07P	0.9	FLAG T07P
IHM004	US 2506-T07P	1.2	US 2506-T07P	1.2	FLAG T07P
IHM005	US 2507-T08P	1.2	US 3007-T08P	2.0	FLAG T08P
IHM006	US 3007-T09P	2.0	US 3007-T09P	2.0	FLAG T09P
IHM007	US 3007-T09P	2.0	US 3009-T09P	2.0	FLAG T09P
IHM008	US 3510-T15P	3.0	US 3508-T15P	3.0	FLAG T15P
IHM009	US 3510-T15P	3.0	US 5012-T15P	5.0	FLAG T15P
IHM010	US 4011-T15P	4.0	US 5012-T15P	5.0	FLAG T15P

**I803D**

**P M K N S**

**S**



ANSI	D	h <sub>max</sub>	L	l <sub>1</sub>	l <sub>2</sub>	l <sub>3</sub>	dh6	d <sub>1</sub>	$\bar{D}$	$\bar{D}^+$					
803D-0594-178-S100	.594	1.783	5.012	2.768	2.244	1.941	1.000	1.378	.012	.012	EP253253	IGI300	IGI313	.71	IHM001
803D-0625-187-S100	.625	1.875	5.102	2.858	2.244	2.047	1.000	1.378	.006	.016	EP253253	IGI300	IGI313	.73	IHM001
803D-0656-196-S100	.656	1.969	5.197	2.953	2.244	2.157	1.000	1.378	.006	.016	EP253253	IGI300	IGI313	.73	IHM001
803D-0687-206-S100	.687	2.061	5.287	3.043	2.244	2.244	1.000	1.378	.020	.020	EP253253	IGI301	IGI314	.75	IHM002
803D-0709-212-S100	.709	2.127	5.354	3.110	2.244	2.323	1.000	1.378	.014	.008	EP253253	IGI301	IGI314	.77	IHM002
803D-0750-225-S100	.750	2.250	5.476	3.232	2.244	2.425	1.000	1.378	.012	.014	EP253253	IGI301	IGI314	.79	IHM002
803D-0766-229-S100	.766	2.298	5.528	3.283	2.244	2.484	1.000	1.378	.008	.020	EP253253	IGI302	IGI315	.79	IHM003
803D-0787-236-S100	.787	2.361	5.591	3.346	2.244	2.559	1.000	1.378	.008	.020	EP253253	IGI302	IGI315	.82	IHM003
803D-0812-243-S100	.812	2.436	5.665	3.421	2.244	2.646	1.000	1.378	.004	.019	EP253253	IGI302	IGI315	.82	IHM003
803D-0827-248-S100	.827	2.481	5.709	3.465	2.244	2.697	1.000	1.378	.004	.019	EP253253	IGI302	IGI315	.84	IHM003
803D-0875-262-S100	.875	2.625	5.854	3.610	2.244	2.866	1.000	1.378	.011	.019	EP253253	IGI303	IGI316	.88	IHM004
803D-0906-271-S100	.906	2.718	5.945	3.701	2.244	2.972	1.000	1.378	.008	.019	EP253253	IGI304	IGI317	.90	IHM005
803D-0922-276-S100	.922	2.766	5.996	3.752	2.244	3.031	1.000	1.378	.008	.019	EP253253	IGI304	IGI317	.95	IHM005
803D-0937-281-S100	.937	2.811	6.039	3.795	2.244	3.083	1.000	1.378	.004	.019	EP253253	IGI304	IGI317	.93	IHM005
803D-0984-295-S125	.984	2.952	6.299	3.937	2.362	3.150	1.250	1.654	.004	.019	EP324058	IGI304	IGI317	1.37	IHM005
803D-1000-300-S125	1.000	3.000	6.346	3.984	2.362	3.205	1.250	1.654	.004	.019	EP324058	IGI304	IGI317	1.39	IHM005
803D-1032-310-S125	1.032	3.096	6.441	4.079	2.362	3.315	1.250	1.654	.004	.019	EP324058	IGI305	IGI318	1.41	IHM006
803D-1062-318-S125	1.062	3.186	6.531	4.169	2.362	3.421	1.250	1.654	.020	.008	EP324058	IGI305	IGI318	1.43	IHM006
803D-1109-332-S125	1.109	3.327	6.673	4.311	2.362	3.587	1.250	1.654	.020	.014	EP324058	IGI306	IGI319	1.52	IHM007
803D-1125-337-S125	1.125	3.375	6.720	4.358	2.362	3.642	1.250	1.654	.020	.014	EP324058	IGI306	IGI319	1.52	IHM007
803D-1172-351-S125	1.172	3.516	6.862	4.500	2.362	3.807	1.250	1.654	.014	.020	EP324058	IGI306	IGI319	1.61	IHM007
803D-1187-356-S125	1.187	3.561	6.906	4.543	2.362	3.858	1.250	1.654	.014	.020	EP324058	IGI306	IGI319	1.63	IHM007
803D-1250-375-S150	1.250	3.750	7.370	4.732	2.638	3.921	1.500	1.969	.006	.020	-	IGI307	IGI320	2.31	IHM008
803D-1312-393-S150	1.312	3.936	7.559	4.921	2.638	4.138	1.500	1.969	.020	.020	-	IGI307	IGI320	2.45	IHM008
803D-1375-412-S150	1.375	4.125	7.748	5.110	2.638	4.319	1.500	1.969	.008	.020	-	IGI308	IGI321	2.56	IHM009
803D-1437-431-S150	1.437	4.311	7.933	5.295	2.638	4.535	1.500	1.969	.004	.020	-	IGI308	IGI321	2.62	IHM009
803D-1500-450-S150	1.500	4.500	8.122	5.484	2.638	4.756	1.500	1.969	.006	.020	-	IGI308	IGI321	2.80	IHM009
803D-1750-525-S150	1.750	5.250	8.843	6.205	2.638	5.642	1.500	1.969	.020	.020	-	IGI309	IGI322	3.48	IHM010
803D-2000-600-S150	2.000	6.000	9.626	6.988	2.638	6.394	1.500	2.205	.006	.020	-	IGI310	IGI323	4.70	IHM010

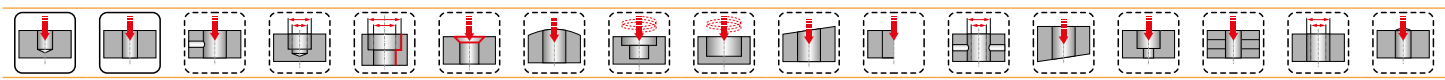
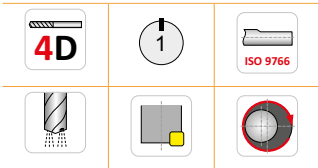
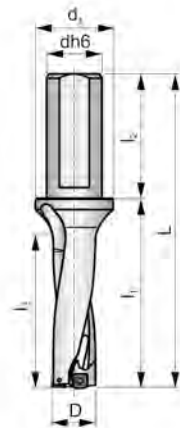
IGI300	XPET 0502AP	SCET 050204-UD
IGI301	XPET 0602AP	SCET 050204-UD
IGI302	XPET 0602AP	SCET 060204-UD
IGI303	XPET 0703AP	SCET 060204-UD
IGI304	XPET 0703AP	SCET 070308-UD
IGI305	XPET 0903AP	SCET 070308-UD
IGI306	XPET 0903AP	SCET 09T308-UD
IGI307	XPET 11T3AP	SCET 09T308-UD
IGI308	XPET 11T3AP	SCET 120408-UD
IGI309	XPET 1504AP	SCET 120408-UD
IGI310	XPET 1504AP	SCET 150512-UD
IGI311	XPET 1504AP	SCET 150512-UD
IGI312	XPET 1904AP	SCET 150512-UD
IGI313	XPET 0502AP-SD	SCET 050204-SD
IGI314	XPET 0602AP-SD	SCET 050204-SD
IGI315	XPET 0602AP-SD	SCET 060204-SD
IGI316	XPET 0703AP-SD	SCET 060204-SD
IGI317	XPET 0703AP-SD	SCET 070308-SD
IGI318	XPET 0903AP-SD	SCET 070308-SD
IGI319	XPET 0903AP-SD	SCET 09T308-SD
IGI320	XPET 11T3AP-SD	SCET 09T308-SD
IGI321	XPET 11T3AP-SD	SCET 120408-SD
IGI322	XPET 1504AP-SD	SCET 120408-SD
IGI323	XPET 1504AP-SD	SCET 150512-SD
IGI324	XPET 1504AP-SD	SCET 150512-SD
IGI325	XPET 1904AP-SD	SCET 150512-SD

IHM001	US 2245-T07P	0.9	US 2245-T07P	0.9	FLAG T07P
IHM002	US 2205-T07P	0.9	US 2245-T07P	0.9	FLAG T07P
IHM003	US 2205-T07P	0.9	US 2205-T07P	0.9	FLAG T07P
IHM004	US 2506-T07P	1.2	US 2506-T07P	1.2	FLAG T07P
IHM005	US 2507-T08P	1.2	US 3007-T08P	2.0	FLAG T08P
IHM006	US 3007-T09P	2.0	US 3007-T09P	2.0	FLAG T09P
IHM007	US 3007-T09P	2.0	US 3009-T09P	2.0	FLAG T09P
IHM008	US 3510-T15P	3.0	US 3508-T15P	3.0	FLAG T15P
IHM009	US 3510-T15P	3.0	US 5012-T15P	5.0	FLAG T15P
IHM010	US 4011-T15P	3.5	US 5012-T15P	5.0	FLAG T15P
IHM010	US 4011-T15P	4.0	US 5012-T15P	5.0	FLAG T15P

**I804D**

**P M K N S**

**S**



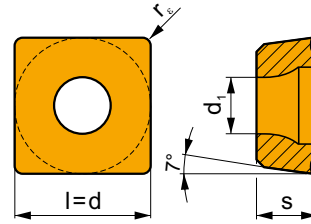
ANSI	D	h <sub>max</sub>	L	l <sub>1</sub>	l <sub>2</sub>	l <sub>3</sub>	dh6	d <sub>1</sub>	$\bar{D}$	$\bar{D}^+$				lbs	
804D-0594-237-S100	.594	2.376	5.606	3.362	2.244	2.535	1.000	1.378	.012	.012	EP253253	IGI300	IGI313	.73	IHM001
804D-0625-250-S100	.625	2.500	5.728	3.484	2.244	2.673	1.000	1.378	.006	.016	EP253253	IGI300	IGI313	.75	IHM001
804D-0656-262-S100	.656	2.624	5.850	3.587	2.244	2.811	1.000	1.378	.006	.016	EP253253	IGI300	IGI313	.77	IHM001
804D-0687-274-S100	.687	2.748	5.976	3.732	2.244	2.933	1.000	1.378	.020	.020	EP253253	IGI301	IGI314	.79	IHM002
804D-0709-283-S100	.709	2.836	6.063	3.819	2.244	3.031	1.000	1.378	.014	.008	EP253253	IGI301	IGI314	.79	IHM002
804D-0750-300-S100	.750	3.000	6.228	3.984	2.244	3.217	1.000	1.378	.012	.014	EP253253	IGI301	IGI314	.82	IHM002
804D-0766-306-S100	.766	3.064	6.291	4.047	2.244	3.248	1.000	1.378	.008	.020	EP253253	IGI302	IGI315	.84	IHM003
804D-0787-314-S100	.787	3.148	6.378	4.134	2.244	3.346	1.000	1.378	.008	.020	EP253253	IGI302	IGI315	.86	IHM003
804D-0812-324-S100	.812	3.248	6.476	4.232	2.244	3.457	1.000	1.378	.004	.019	EP253253	IGI302	IGI315	.88	IHM003
804D-0827-330-S100	.827	3.308	6.535	4.291	2.244	3.524	1.000	1.378	.004	.019	EP253253	IGI302	IGI315	.90	IHM003
804D-0875-350-S100	.875	3.500	6.728	4.484	2.244	3.740	1.000	1.378	.011	.019	EP253253	IGI303	IGI316	.97	IHM004
804D-0922-368-S100	.922	3.688	6.917	4.673	2.244	3.953	1.000	1.378	.008	.019	EP253253	IGI304	IGI317	1.01	IHM005
804D-0937-374-S100	.937	3.748	6.976	4.732	2.244	4.020	1.000	1.378	.004	.019	EP253253	IGI304	IGI317	1.01	IHM005
804D-0984-393-S125	.984	3.936	7.283	4.921	2.362	4.134	1.250	1.654	.004	.019	EP324058	IGI304	IGI317	1.48	IHM005
804D-1000-400-S125	1.000	4.000	7.346	4.984	2.362	4.205	1.250	1.654	.004	.019	EP324058	IGI304	IGI317	1.52	IHM005
804D-1032-412-S125	1.032	4.128	7.476	5.114	2.362	4.350	1.250	1.654	.004	.019	EP324058	IGI305	IGI318	1.54	IHM006
804D-1062-424-S125	1.062	4.248	7.594	5.232	2.362	4.248	1.250	1.654	.020	.008	EP324058	IGI305	IGI318	1.59	IHM006
804D-1109-443-S125	1.109	4.437	7.783	5.421	2.362	4.697	1.250	1.654	.020	.014	EP324058	IGI306	IGI319	1.68	IHM007
804D-1125-450-S125	1.125	4.500	7.846	5.484	2.362	4.768	1.250	1.654	.020	.014	EP324058	IGI306	IGI319	1.70	IHM007
804D-1172-468-S125	1.172	4.688	8.035	5.673	2.362	4.980	1.250	1.654	.014	.020	EP324058	IGI306	IGI319	1.79	IHM007
804D-1187-474-S125	1.187	4.748	8.094	5.732	2.362	5.043	1.250	1.654	.014	.020	EP324058	IGI306	IGI319	1.83	IHM007
804D-1250-500-S150	1.250	5.000	8.622	5.984	2.638	5.169	1.500	1.969	.006	.020	-	IGI307	IGI320	2.54	IHM008
804D-1312-524-S150	1.312	5.248	8.870	6.232	2.638	5.449	1.500	1.969	.020	.020	-	IGI307	IGI320	2.73	IHM008
804D-1375-550-S150	1.375	5.500	9.122	6.484	2.638	5.693	1.500	1.969	.008	.020	-	IGI308	IGI321	2.87	IHM009
804D-1437-574-S150	1.437	5.748	9.370	6.732	2.638	5.748	1.500	1.969	.004	.020	-	IGI308	IGI321	2.98	IHM009
804D-1500-600-S150	1.500	6.000	9.622	6.984	2.638	6.256	1.500	1.969	.006	.020	-	IGI308	IGI321	3.20	IHM009
804D-1750-700-S150	1.750	7.000	10.622	7.984	2.638	7.421	1.500	1.969	.020	.020	-	IGI309	IGI322	4.12	IHM010
804D-2000-800-S150	2.000	8.000	11.622	8.984	2.638	8.390	1.500	2.205	.006	.020	-	IGI310	IGI323	5.67	IHM010

IGI300	XPET 0502AP	SCET 050204-UD
IGI301	XPET 0602AP	SCET 050204-UD
IGI302	XPET 0602AP	SCET 060204-UD
IGI303	XPET 0703AP	SCET 060204-UD
IGI304	XPET 0703AP	SCET 070308-UD
IGI305	XPET 0903AP	SCET 070308-UD
IGI306	XPET 0903AP	SCET 09T308-UD
IGI307	XPET 11T3AP	SCET 09T308-UD
IGI308	XPET 11T3AP	SCET 120408-UD
IGI309	XPET 1504AP	SCET 120408-UD
IGI310	XPET 1504AP	SCET 150512-UD
IGI311	XPET 1504AP	SCET 150512-UD
IGI312	XPET 1904AP	SCET 150512-UD
IGI313	XPET 0502AP-SD	SCET 050204-SD
IGI314	XPET 0602AP-SD	SCET 050204-SD
IGI315	XPET 0602AP-SD	SCET 060204-SD
IGI316	XPET 0703AP-SD	SCET 060204-SD
IGI317	XPET 0703AP-SD	SCET 070308-SD
IGI318	XPET 0903AP-SD	SCET 070308-SD
IGI319	XPET 0903AP-SD	SCET 09T308-SD
IGI320	XPET 11T3AP-SD	SCET 09T308-SD
IGI321	XPET 11T3AP-SD	SCET 120408-SD
IGI322	XPET 1504AP-SD	SCET 120408-SD
IGI323	XPET 1504AP-SD	SCET 150512-SD
IGI324	XPET 1504AP-SD	SCET 150512-SD
IGI325	XPET 1904AP-SD	SCET 150512-SD

IHM001	US 2245-T07P	0.9	US 2245-T07P	0.9	FLAG T07P
IHM002	US 2205-T07P	0.9	US 2245-T07P	0.9	FLAG T07P
IHM003	US 2205-T07P	0.9	US 2205-T07P	0.9	FLAG T07P
IHM004	US 2506-T07P	1.2	US 2506-T07P	1.2	FLAG T07P
IHM005	US 2507-T08P	1.2	US 3007-T08P	2.0	FLAG T08P
IHM006	US 3007-T09P	2.0	US 3007-T09P	2.0	FLAG T09P
IHM007	US 3007-T09P	2.0	US 3009-T09P	2.0	FLAG T09P
IHM008	US 3510-T15P	3.0	US 3508-T15P	3.0	FLAG T15P
IHM009	US 3510-T15P	3.0	US 5012-T15P	5.0	FLAG T15P
IHM010	US 4011-T15P	3.5	US 5012-T15P	5.0	FLAG T15P
IHM010	US 4011-T15P	4.0	US 5012-T15P	5.0	FLAG T15P

## SCET

	d	d <sub>1</sub>	l	s
0502	.219	.094	.219	.094
0602	.250	.114	.250	.094
0703	.312	.138	.312	.125
09T3	.375	.177	.375	.156
1204	.500	.220	.500	.187
1505	.625	.220	.625	.219

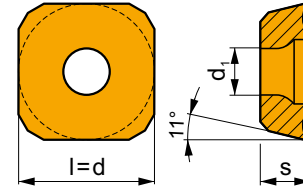


i	ANSI	Material	P	M	K	N	S	H	Coating	Drop	r <sub>c</sub>	f <sub>min</sub>	f <sub>max</sub>	a <sub>p min</sub>	a <sub>p max</sub>
<p>SCET 050204-UD .005</p> <p>SCET 060204-UD .006</p> <p>SCET 070308-UD .006</p> <p>SCET 09T308-UD .006</p> <p>SCET 120408-UD .008</p> <p>SCET 150512-UD .008</p>	SCET 050204-UD	D8330	■	□	■				●	+++	.016	.002	.004	-	-
	D9335	■	□	■				●	+++	.016	.002	.004	-	-	
	SCET 060204-UD	D8330	■	□	■				●	+++	.016	.002	.006	-	-
	D9335	■	□	■				●	+++	.016	.002	.006	-	-	
	SCET 070308-UD	D8330	■	□	■				●	+++	.031	.003	.007	-	-
	D9335	■	□	■				●	+++	.031	.003	.007	-	-	
	SCET 09T308-UD	D8330	■	□	■				●	+++	.031	.003	.008	-	-
	D9335	■	□	■				●	+++	.031	.003	.008	-	-	
	SCET 120408-UD	D8330	■	□	■				●	+++	.031	.004	.009	-	-
	D9335	■	□	■				●	+++	.031	.004	.009	-	-	
	SCET 150512-UD	D8330	■	□	■				●	+++	.047	.004	.010	-	-
	D9335	■	□	■				●	+++	.047	.004	.010	-	-	
<p>SCET 050204-SD .002</p> <p>SCET 060204-SD .002</p> <p>SCET 070308-SD .003</p> <p>SCET 09T308-SD .004</p> <p>SCET 120408-SD .004</p> <p>SCET 150512-SD .004</p>	SCET 050204-SD	D8330	■	■		□	■		●	+++	.016	.002	.004	-	-
	D9335	■	■			■		●	+++	.016	.002	.004	-	-	
	SCET 060204-SD	D8330	■	■		□	■		●	+++	.016	.002	.006	-	-
	D9335	■	■			■		●	+++	.016	.002	.006	-	-	
	SCET 070308-SD	D8330	■	■		□	■		●	+++	.031	.003	.007	-	-
	D9335	■	■			■		●	+++	.031	.003	.007	-	-	
	SCET 09T308-SD	D8330	■	■		□	■		●	+++	.031	.003	.008	-	-
	D9335	■	■			■		●	+++	.031	.003	.008	-	-	
	SCET 120408-SD	D8330	■	■		□	■		●	+++	.031	.004	.009	-	-
	D9335	■	■			■		●	+++	.031	.004	.009	-	-	
	SCET 150512-SD	D8330	■	■		□	■		●	+++	.047	.004	.010	-	-
	D9335	■	■			■		●	+++	.047	.004	.010	-	-	



## XPET

	d	d <sub>1</sub>	l	s
0502	.219	.094	.219	.094
0602	.250	.102	.250	.094
0703	.312	.114	.313	.125
0903	.375	.138	.375	.125
11T3	.453	.154	.453	.156
12T3	.500	.154	.500	.156
1504	.625	.177	.625	.187
1904	.750	.177	.750	.187



		ANSI		P	M	K	N	S	H			r <sub>e</sub>	f <sub>min</sub>	f <sub>max</sub>	a <sub>p min</sub>	a <sub>p max</sub>		
  	 a XPET 0502AP .004 XPET 0602AP .004 XPET 0703AP .006 XPET 0903AP .010 XPET 11T3AP .010 XPET 12T3AP .010 XPET 1504AP .010 XPET 1904AP .010	XPET 0502AP	D8345	■	□	▣					+++	-	.002	.004	-	-		
		XPET 0602AP	D8345	■	□	▣						+++	-	.002	.006	-	-	
		XPET 0703AP	D8345	■	□	▣						+++	-	.003	.007	-	-	
		XPET 0903AP	D8345	■	□	▣						+++	-	.003	.008	-	-	
		XPET 11T3AP	D8345	■	□	▣						+++	-	.004	.009	-	-	
		XPET 12T3AP	D8345	■	□	▣						+++	-	.004	.009	-	-	
		XPET 1504AP	D8345	■	□	▣						+++	-	.004	.010	-	-	
		XPET 1904AP	D8345	■	□	▣						+++	-	.004	.010	-	-	
		  	 a XPET 0502AP-SD .002 XPET 0602AP-SD .002 XPET 0703AP-SD .003 XPET 0903AP-SD .004 XPET 11T3AP-SD .004 XPET 12T3AP-SD .004 XPET 1504AP-SD .004 XPET 1904AP-SD .005	XPET 0502AP-SD	D8345	■	■			▣			+++	-	.002	.004	-	-
				XPET 0602AP-SD	D8345	■	■			▣				+++	-	.002	.006	-
XPET 0703AP-SD	D8345			■	■			▣				+++	-	.003	.007	-	-	
XPET 0903AP-SD	D8345			■	■			▣				+++	-	.003	.008	-	-	
XPET 11T3AP-SD	D8345			■	■			▣				+++	-	.004	.009	-	-	
XPET 12T3AP-SD	D8345			■	■			▣				+++	-	.004	.009	-	-	
XPET 1504AP-SD	D8345			■	■			▣				+++	-	.004	.010	-	-	
XPET 1904AP-SD	D8345			■	■			▣				+++	-	.004	.010	-	-	



**DRILLING  
- TECHNICAL INFORMATION**

**TALADRADO  
- APARTADO TÉCNICO**

**PERÇAGE  
- INFORMATIONS TECHNIQUES**

**WORKPIECE MATERIALS – CLASSIFICATION**  
**CLASIFICACIÓN DE MATERIALES MECANIZADOS**

Correctly identifying the machined material is one of the most important factors when choosing the tool and the initial machining conditions. To facilitate this, the machined materials are divided into six basic groups, or into twenty-four subgroups, combining materials that qualitatively cause the same type of loading (pressure) on the cutting edge and therefore a similar type of wear.

Thus the first step is to assign the workpiece material to one of the (sub)groups – see table 5. below.

Identificar correctamente el material mecanizado es uno de los factores más importantes al momento de elegir la herramienta y la condiciones iniciales de mecanizado. Para facilitar esto, los materiales mecanizados se dividen en seis grupos básicos, o en veinticuatro subgrupos, combinando materiales que cualitativamente pueden causar el mismo tipo de carga (esfuerzo) en la arista de de corte y por lo tanto un tipo similar de desgaste. Así, el primer paso es asignar el material de la pieza a uno de los (sub) grupos - véase la tabla 5. a continuación.

Table 5

Tabla 5

Subgroup Sub-grupo	DORMER AMG	Subgroup definition	Definición de sub-grupo	Example Ejemplo	Correction factor Factor de corrección	
<b>P</b>	<b>P1</b>	1.1, 1.2	Steel and cast steel with very good (enhanced) machinability; automatic steel and low-carbon steel	Acero y fundición de acero con muy buena (mejorado) mecanización, acero automático y de acero bajo en carbono	95Mn28	1.33
	<b>P2</b>	1.3	Non-alloy and low-alloy cast steel and steel with a medium carbon content (0.25 < C < 0.55); rigidity of up to 900 MPa and hardness of 160 – 255 HB	Sin alea y de baja aleación de acero fundido y acero con un contenido de carbono medio (0,25 < C < 0,55); rigidez de hasta 900 MPa y una dureza de 160 – 255 HB	C45	1.00
	<b>P3</b>	1.4	Less machinable non-alloy and low-alloy cast steel and steel with a medium carbon content; rigidity of up to 1000 MPa and hardness of up to 300 HB	Menos mecanizable sin alea y de acero fundido de baja aleación y acero con un contenido de carbono medio; rigidez de hasta 1000 MPa y una dureza de hasta 300 HB	41CrAlMo7	0.80
	<b>P4</b>	1.5	Medium – to high-alloy cast steel and steel (usually with a carbon content of 0.55 < C); rigidity of up to 1270 MPa and hardness of up to 375 HB (resp. 40 HRC)	Medio – alto-aleación de acero fundido y acero (normalmente con un contenido de carbono de 0,55 < C); rigidez de hasta 1270 MPa y una dureza de hasta 375HB (resp. 40 HRC)	X210Cr12	0.60
<b>M</b>	<b>M1</b>	2.1	Ferritic corrosion-resistant steel	Acero resistente a la corrosión ferrítico	X6Cr17	1.09
	<b>M2</b>	(2.1, 2.4)	Martensitic corrosion-resistant steel	Acero resistente a la corrosión martensítico	X 45CrSi 9.3	1.06
	<b>M3</b>	2.2	Austenitic corrosion-resistant steel	Acero resistente a la corrosión austenítico	X 6CrNiTi 18 10	1.00
	<b>M4</b>	2.3, 2.4	Ferritic-austenitic (duplex) and super-austenitic corrosion-resistant steel	Ferrítico-austenítico (dúplex) y super-austenítico acero resistente a la corrosión	X 53 CrMnNiN21 9	0.93
<b>K</b>	<b>K1</b>	3.1, 3.2	Grey cast iron	Gris hierro fundido	GG–25	1.00
	<b>K2</b>	3.1, 3.2	Tempered cast iron	Hierro fundido templado	GTS 45–06	0.95
	<b>K3</b>	3.3	Ductile cast iron ferritic and ferrite-pearlite	Fundición ferrítico hierro y ferrita-perlita	GGG40	0.90
	<b>K4</b>	3.4	Ductile cast iron pearlite-ferritic, pearlite-sorbitic and pearlite	Fundición dúctil de perlita y ferrita, perlita-sorbítico y perlita	GGG–70	0.85
<b>N</b>	<b>N1</b>	7.1	Aluminium and its soft alloys (with a low Si content), particularly formed and cast (non-hardened); hardness of up to 100 HB	Aluminio y sus aleaciones blandas (con bajo contenido de Si), especialmente formado y yeso (no resistente); dureza de hasta 100 HB	AlMgSi1	1.00
	<b>N2</b>	7.2, 7.3, 7.4	Hard Al alloys, particularly cast and hardened (with a high Si content)	Duro aleaciones de Al, en particular emitidos y endurecidos (con un alto contenido de Si)	G–AlSi11	0.65
	<b>N3</b>	6.1, 6.2, 6.3	Soft Cu alloys, automatic brass and other types of soft brass and bronze	Aleaciones Cu suaves, latón automática y otros tipos de latón blando y bronce	G–CuSn5Zn5Pb	0.60
	<b>N4</b>	6.4	Less machinable and hard Cu alloys	Aleaciones Cu menos mecanizables y duros	G–CuAl10Fe	0.40
<b>S</b>	<b>S1</b>	4.1, 4.2, 4.3	Technically pure Ti, alloys $\alpha$ , $\alpha+\beta$ and $\beta$ , refined and aged alloys	Técnicamente ti puro, aleaciones $\alpha$ , $\alpha+\beta$ y $\beta$ , refinado y aleaciones viejas	TiAl6V4	1.75
	<b>S2</b>	(9.1)	Fe-based alloys	Aleaciones a base de hierro	X10NiCrAlTi3221	1.20
	<b>S3</b>	5.1, 5.2, 5.3	Ni-based alloys	Aleaciones a base de níquel	INCONEL 718	1.20
	<b>S4</b>	(9.1)	Co-based alloys	Aleaciones a base de cobalto	Haynes 25	0.75
<b>H</b>	<b>H1</b>	1.6	Highly rigid and hard tool steel and hardened and refined steel with a hardness of 40 – 50 HRC	Muy rígido y duro y acero para herramientas endurecido y acero refinado, con una dureza de 40 – 50 HRC	X30WCrV9.3	1.15
	<b>H2</b>	–	Hardened and white cast iron 350 – 600 HV	Hierro fundido templado y blanco 350 – 600 HV	G–X 260 NiCr 4.2	1.10
	<b>H3</b>	1.7	Hardened and refined steel with hardness in the 50 – 55 HRC range	Acero templado y refinada con dureza en el 50 – 55 gama HRC	X38CrMoV5.1	1.00
	<b>H4</b>	1.8	Hardened and refined (mostly tool) steel with hardness of more than 55 HRC	Endurecido y refinado (en su mayoría de la herramienta) de acero con dureza de más de 55 HRC	X210Cr12	0.95

## CLASSIFICATION DES GROUPES DE MATÉRIAUX À USINER

L'identification du matériau à usiner est l'un des facteurs les plus importants pour choisir l'outil et les conditions de coupe de départ. Pour simplifier ce choix, les matériaux usinés sont divisés en six groupes de base, ou vingt quatre sous-groupes. Dans chacun sont associés

des matériaux qui causent le même type de charge sur l'arête de coupe et également un type d'usure similaire. C'est pourquoi la première étape consiste à identifier le matériau à usiner parmi les (sous-)groupes référencés - voir tableau N°5 ci-dessous.

Tableau 5

Subgrupo Sous-groupe	DORMER AMG	Définition du sous-groupe	Exemplo Exemple	Correção Standard Correction à la norme
<b>P</b>	<b>P1</b>	1.1, 1.2 Acier et acier coulé avec une usinabilité améliorée ; acier de construction et acier à faible teneur en carbone	9SMn28	1.33
	<b>P2</b>	1.3 Acier et acier coulé non allié et faiblement allié à moyenne teneur en carbone (0,25 < C < 0,55); résistance jusqu'à 900 MPa et dureté de 160 – 255 HB	C45	1.00
	<b>P3</b>	1.4 Acier et acier coulé non allié et faiblement allié à moyenne teneur en carbone plus difficiles à usiner; résistance jusqu'à 1000 MPa et dureté jusqu'à 300 HB	41CrAlMo7	0.80
	<b>P4</b>	1.5 Acier et acier coulé moyennement et fortement allié (généralement avec une teneur en carbone 0,55 < C); résistance jusqu'à 1270 MPa et dureté jusqu'à 375 HB HRC)	X210Cr12	0.60
<b>M</b>	<b>M1</b>	2.1 Aciers inoxydables ferritiques résistants à la corrosion	X6Cr17	1.09
	<b>M2</b>	(2.1, 2.4) Aciers inoxydables martensitiques résistants à la corrosion	X 45CrSi 9.3	1.06
	<b>M3</b>	2.2 Aciers inoxydables austénitiques résistants à la corrosion	X 6CrNiTi 18 10	1.00
	<b>M4</b>	2. , 2.4 Aciers inoxydables ferritiques-austénitiques (duplex) et super austénitiques résistants à la corrosion	X 53 CrMnNiN21 9	0.93
<b>K</b>	<b>K1</b>	3.1, 3.2 Fontes grises	GG-25	1.00
	<b>K2</b>	3.1, 3.2 Fontes trempées	GTS 45-06	0.95
	<b>K3</b>	3.3 Fontes ductiles ferritiques et ferritiques-perlitiques	GGG40	0.90
	<b>K4</b>	3.4 Fontes ductiles perlites-ferrites, perlites et de perlites sorbitiques	GGG-70	0.85
<b>N</b>	<b>N1</b>	7.1 L'aluminium et ses alliages doux (à faible teneur en Si), en particulier formés et coulés (non trempé); dureté jusqu'à 100 HB	AlMgSi1	1.00
	<b>N2</b>	7.2, 7.3, 7.4 Alliages Al durs, en particulier coulés et traités (à haute teneur en Si)	G-AlSi11	0.65
	<b>N3</b>	6.1, 6.2, 6.3 Alliages Cu doux, laiton automatique et autres types de laiton et de bronze tendre	G-CuSn5Zn5Pb	0.60
	<b>N4</b>	6.4 Alliages moins faciles à usiner et alliages durs Cu	G-CuAl10Fe	0.40
<b>S</b>	<b>S1</b>	4.1, 4.2, 4.3 Ti techniquement pur, alliages $\alpha$ , $\alpha+\beta$ et $\beta$ , alliages affinés et vieillis	TiAl6V4	1.75
	<b>S2</b>	(9.1) Alliages base Fe	X10NiCrAlTi3221	1.20
	<b>S3</b>	5.1, 5.2, 5.3 Alliages base Ni	INCONEL 718	1.00
	<b>S4</b>	(9.1) Alliages base Co	Haynes 25	0.75
<b>H</b>	<b>H1</b>	1.6 Aciers à outils très résistants durs, trempés, affinés avec une dureté de 40 – 50 HRC	X30WCrV9.3	1.15
	<b>H2</b>	- Fontes trempées et blanches 350 – 600 HV	G-X 260 NiCr 4 2	1.10
	<b>H3</b>	1.7 Aciers trempés et affinés avec une dureté dans la plage 50 – 55 HRC	X38CrMoV5.1	1.00
	<b>H4</b>	1.8 Aciers trempés et affinés (principalement acier à outil) avec une dureté de plus de 55 HRC	X210Cr12	0.95

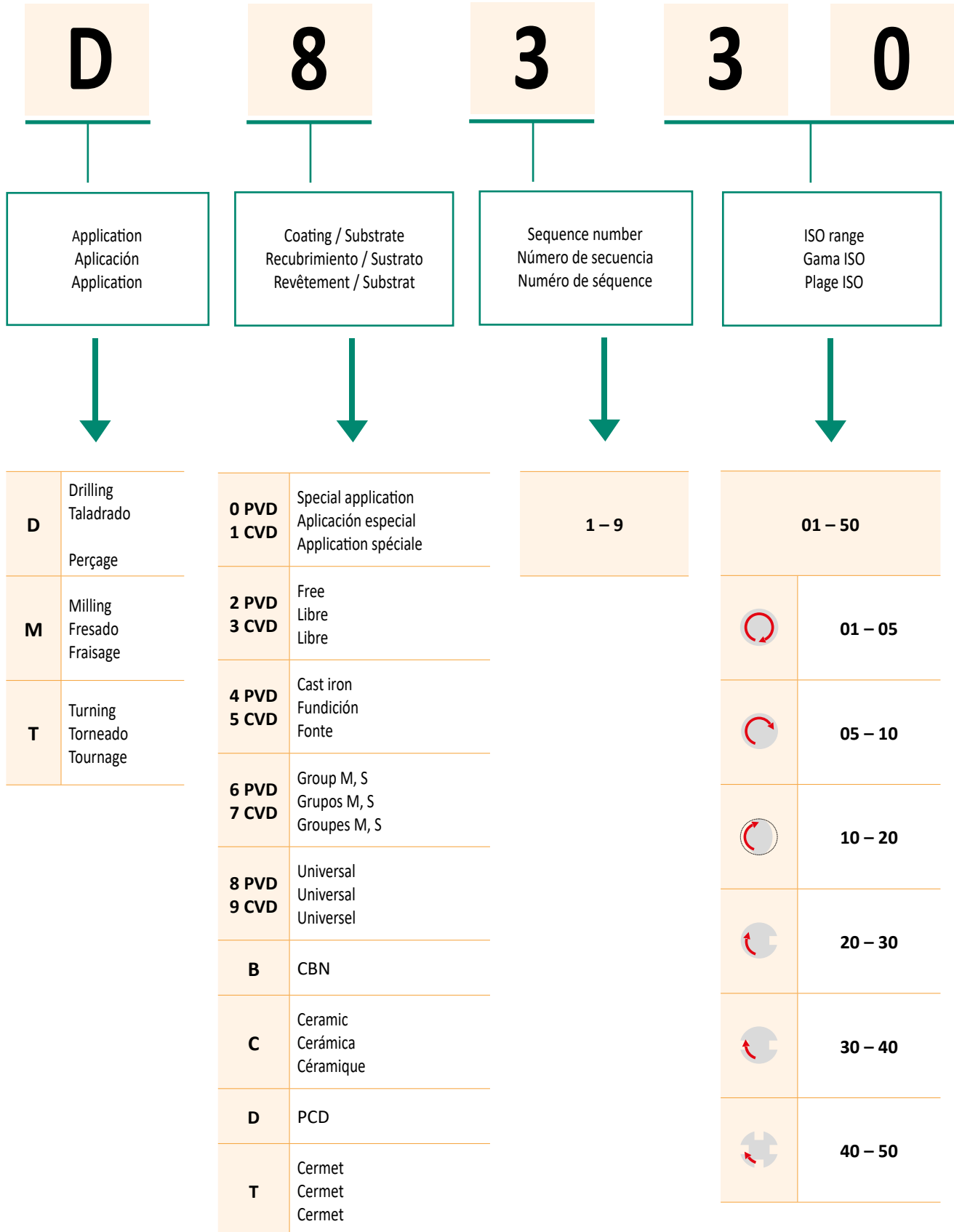


Table 2  
Tabla 2  
Tableau 2

**DRILLING GRADES**  
**DESCRIPCIÓN DE CALIDADES**  
**CODIFICATION DES NUANCES**

Grade Identification Calidad Désignation de la nuance	Area of Application Area de aplicación Domaine d'application	Application / Application / Application	Feed Avance Avance	Cutting speed Velocidad de corte Vitesse de coupe	Resistance to adverse Working Conditions Resistencia a condiciones de trabajo adversas Résistance aux chocs et aux conditions défavorables	Substrate Sustrato Substrat	Coating Recubrimiento Revêtement	Colour / Color Couleur	Coolant benefit / Refrigerante Bénéfice de l'arrosage	Drilling Talaadrado Perçage	Boring Mandrado Alésage
<b>D9335</b>	P20 - P35	<input checked="" type="checkbox"/>				FGM	MT-CVD		+++	<input checked="" type="checkbox"/>	
	M15 - M30	<input checked="" type="checkbox"/>									
	K15 - K35	<input checked="" type="checkbox"/>									
	S10 - S20	<input checked="" type="checkbox"/>									
	H10 - H20	<input type="checkbox"/>									
<b>D8330</b>	P20 - P35	<input checked="" type="checkbox"/>				submicron H	PVD		+++	<input checked="" type="checkbox"/>	
	M15 - M30	<input checked="" type="checkbox"/>									
	K15 - K35	<input checked="" type="checkbox"/>									
	N10 - N25	<input type="checkbox"/>									
	S10 - S20	<input checked="" type="checkbox"/>									
H10 - H20	<input type="checkbox"/>										
<b>D8345</b>	P25 - P45	<input checked="" type="checkbox"/>				submicron H	PVD		+++	<input checked="" type="checkbox"/>	
	M15 - M35	<input checked="" type="checkbox"/>									
	K15 - K35	<input checked="" type="checkbox"/>									
	S15 - S25	<input type="checkbox"/>									
H15 - H25	<input type="checkbox"/>										

**Substrate / Sustrato**  
**Substrat**

submicron H	WC-Co based substrate fine grained (< 1 µm)	Sustrato de grano fino de base WC-Co (<1 µm)	Substrat base WC-Co à grains fins (< 1 µm)
FGM	Functionally graded substrate	Sustrato de grado funcional	Substrat gradient fonctionnel

**Coating / Recubrimiento**  
**Revêtement**

MT-CVD	Medium-temperature chemical method of coating	Método de recubrimiento químico a media temperatura	Revêtement par dépôt chimique en phase vapeur à température moyenne
PVD	Low-temperature physical method of coating	Método de recubrimiento físico a baja temperatura	Revêtement par dépôt physique en phase vapeur à basse température

### 802D, 803D (XPET..AP, SCET..-UD)

	Dormer AMG *	D9335		D8330		D8345							
			V <sub>c</sub>		V <sub>c</sub>			∅ .591	∅ .787	∅ .984	∅ 1.181	∅ 1.575	∅ 2.283
P1	1.1, 1.2	■	1099	■	886	■		.003	.003	.004	.004	.005	.006
P2	1.3	■	820	■	656	■		.004	.005	.006	.007	.008	.011
P3	1.4	■	656	■	525	■		.005	.006	.007	.008	.009	.013
P4	1.5	■	492	■	394	■		.005	.006	.006	.007	.009	.012
M1	2.1	□	459	□	426	□		.005	.006	.006	.007	.009	.012
M2	(2.1, 2.4)	□	443	□	410	□		.004	.005	.006	.007	.008	.011
M3	2.2	□	410	□	377	□		.003	.003	.004	.004	.005	.006
M4	2.3, 2.4	□	394	□	361	□		.003	.003	.004	.004	.005	.006
K1	3.1, 3.2	■	623	■	492	▣		.006	.006	.007	.008	.010	.013
K2	3.1, 3.2	■	607	■	476	▣		.006	.006	.007	.008	.010	.013
K3	3.3	■	574	■	443	▣		.006	.006	.007	.008	.010	.013
K4	3.4	■	541	■	426	▣		.006	.006	.007	.008	.010	.013

### 802D, 803D (XPET..AP-SD, SCET..-SD)

	Dormer AMG *	D9335		D8330		D8345							
			V <sub>c</sub>		V <sub>c</sub>			∅ .591	∅ .787	∅ .984	∅ 1.181	∅ 1.575	∅ 2.283
P1	1.1, 1.2	■	1099	■	886	■		.003	.004	.004	.004	.006	.007
P2	1.3	■	820	■	656	■		.004	.005	.006	.007	.008	.011
P3	1.4	■	656	■	525	■		.005	.006	.007	.008	.009	.013
P4	1.5	■	—	■	—	■		—	—	—	—	—	—
M1	2.1	■	459	■	426	■		.005	.006	.006	.007	.009	.012
M2	(2.1, 2.4)	■	443	■	410	■		.004	.005	.006	.007	.008	.011
M3	2.2	■	410	■	377	■		.003	.003	.004	.004	.005	.006
M4	2.3, 2.4	■	394	■	361	■		.003	.003	.004	.004	.005	.006
N1	7.1	□	1476	□	1312	□		.005	.006	.007	.008	.009	.013
N2	7.2, 7.3, 7.4	□	968	□	853	□		.005	.006	.007	.008	.009	.013
N3	6.1, 6.2, 6.3	□	886	□	787	□		.005	.006	.007	.008	.009	.013
N4	6.4	□	590	□	525	□		.005	.006	.006	.007	.009	.012
S1	4.1, 4.2, 4.3	▣	213	▣	180	▣		.003	.004	.004	.004	.006	.007
S2	5.1, 5.2, 5.3	▣	148	▣	131	▣		.003	.004	.004	.004	.006	.007
S3	5.1, 5.2, 5.3	▣	115	▣	98	▣		.003	.003	.004	.004	.005	.006
S4	5.1, 5.2, 5.3	▣	98	▣	82	▣		.003	.003	.004	.004	.005	.006

\* The material classification code used by Dormer is added here for cross reference purposes and should be used only as a guide.

\* El código de clasificación de materiales utilizado por Dormer se ha añadido aquí como referencia y debe ser utilizado sólo como guía.

\* Le code de classification des matériaux utilisé par Dormer est ajouté pour permettre une correspondance et peut être utilisé comme un guide.



Table 3  
Tabla 3  
Tableau 3

RECOMMENDED CUTTING CONDITIONS FOR INDEXABLE DRILLS  
CONDICIONES DE CORTE RECOMENDADAS PARA BROCAS CON PLAQUITAS INTERCAMBIABLES  
CONDITIONS DE COUPE RECOMMANDÉES POUR LES FORETS À PLAQUETTES INDEXABLES

804D (XPET..AP, SCET..-UD)

	Dormer AMG *	D9335		D8330		D8345		f →				
			v <sub>c</sub>		v <sub>c</sub>		v <sub>c</sub>	∅ .591	∅ .787	∅ .984	∅ 1.181	∅ 1.575
P1	1.1, 1.2	■	1099	■	886	■	.002	.003	.003	.004	.004	.006
P2	1.3	■	820	■	656	■	.004	.005	.006	.006	.007	.010
P3	1.4	■	656	■	525	■	.005	.006	.006	.007	.009	.012
P4	1.5	■	492	■	394	■	.004	.005	.006	.007	.008	.011
M1	2.1	□	459	□	426	□	.004	.005	.006	.007	.008	.011
M2	(2.1, 2.4)	□	443	□	410	□	.004	.005	.006	.006	.007	.010
M3	2.2	□	410	□	377	□	.002	.003	.003	.004	.004	.006
M4	2.3, 2.4	□	394	□	361	□	.002	.003	.003	.004	.004	.006
K1	3.1, 3.2	■	623	■	492	▣	.005	.006	.007	.008	.009	.013
K2	3.1, 3.2	■	607	■	476	▣	.005	.006	.007	.008	.009	.013
K3	3.3	■	574	■	443	▣	.005	.006	.007	.008	.009	.013
K4	3.4	■	541	■	426	▣	.005	.006	.007	.008	.009	.013

804D (XPET..AP-SD, SCET..-SD)

	Dormer AMG *	D9335		D8330		D8345		f →				
			v <sub>c</sub>		v <sub>c</sub>		v <sub>c</sub>	∅ .591	∅ .787	∅ .984	∅ 1.181	∅ 1.575
P1	1.1, 1.2	■	1099	■	886	■	.003	.003	.004	.004	.005	.006
P2	1.3	■	820	■	656	■	.004	.005	.006	.006	.007	.010
P3	1.4	■	656	■	525	■	.005	.006	.006	.007	.009	.012
P4	1.5	■	—	■	—	■	—	—	—	—	—	—
M1	2.1	■	459	■	426	■	.004	.005	.006	.007	.008	.011
M2	(2.1, 2.4)	■	443	■	410	■	.004	.005	.006	.006	.007	.010
M3	2.2	■	410	■	377	■	.002	.003	.003	.004	.004	.006
M4	2.3, 2.4	■	394	■	361	■	.002	.003	.003	.004	.004	.006
N1	7.1	□	1476	□	1312	□	.005	.006	.006	.007	.009	.012
N2	7.2, 7.3, 7.4	□	968	□	853	□	.005	.006	.006	.007	.009	.012
N3	6.1, 6.2, 6.3	□	886	□	787	□	.005	.006	.006	.007	.009	.012
N4	6.4	□	590	□	525	□	.004	.005	.006	.007	.008	.011
S1	4.1, 4.2, 4.3	▣	213	▣	180	▣	.003	.003	.004	.004	.005	.006
S2	5.1, 5.2, 5.3	▣	148	▣	131	▣	.003	.003	.004	.004	.005	.006
S3	5.1, 5.2, 5.3	▣	115	▣	98	▣	.002	.003	.003	.004	.004	.006
S4	5.1, 5.2, 5.3	▣	98	▣	82	▣	.002	.003	.003	.004	.004	.006

\* The material classification code used by Dormer is added here for cross reference purposes and should be used only as a guide.

\* El código de clasificación de materiales utilizado por Dormer se ha añadido aquí como referencia y debe ser utilizado sólo como guía.

\* Le code de classification des matériaux utilisé par Dormer est ajouté pour permettre une correspondance et peut être utilisé comme un guide.

### 805D (XPET..AP, SCET..-UD)

	Dormer AMG *	D9335		D8330		D8345							
			v <sub>c</sub>		v <sub>c</sub>			∅ .591	∅ .787	∅ .984	∅ 1.181	∅ 1.575	∅ 2.283
P1	1.1, 1.2	■	886	■	705	■		.002	.003	.003	.004	.004	.006
P2	1.3	■	656	■	525	■		.004	.005	.006	.006	.007	.010
P3	1.4	■	525	■	426	■		.005	.006	.006	.007	.009	.012
P4	1.5	■	394	■	328	■		.004	.005	.006	.007	.008	.011
M1	2.1	□	361	□	344	□		.004	.005	.006	.007	.008	.011
M2	(2.1, 2.4)	□	361	□	328	□		.004	.005	.006	.006	.007	.010
M3	2.2	□	328	□	312	□		.002	.003	.003	.004	.004	.006
M4	2.3, 2.4	□	312	□	295	□		.002	.003	.003	.004	.004	.006
K1	3.1, 3.2	■	508	■	394	▣		.005	.006	.007	.008	.009	.013
K2	3.1, 3.2	■	476	■	377	▣		.005	.006	.007	.008	.009	.013
K3	3.3	■	459	■	361	▣		.005	.006	.007	.008	.009	.013
K4	3.4	■	426	■	344	▣		.005	.006	.007	.008	.009	.013

### 805D (XPET..AP-SD, SCET..-SD)

	Dormer AMG *	D9335		D8330		D8345							
			v <sub>c</sub>		v <sub>c</sub>			∅ .591	∅ .787	∅ .984	∅ 1.181	∅ 1.575	∅ 2.283
P1	1.1, 1.2	■	886	■	705	■		.003	.003	.004	.004	.005	.006
P2	1.3	■	656	■	525	■		.004	.005	.006	.006	.007	.010
P3	1.4	■	525	■	426	■		.005	.006	.006	.007	.009	.012
P4	1.5	■	—	■	—	■		—	—	—	—	—	—
M1	2.1	■	361	■	344	■		.004	.005	.006	.007	.008	.011
M2	(2.1, 2.4)	■	361	■	328	■		.004	.005	.006	.006	.007	.010
M3	2.2	■	328	■	312	■		.002	.003	.003	.004	.004	.006
M4	2.3, 2.4	■	312	■	295	■		.002	.003	.003	.004	.004	.006
N1	7.1	□	1181	□	1050	□		.005	.006	.006	.007	.009	.012
N2	7.2, 7.3, 7.4	□	771	□	689	□		.005	.006	.006	.007	.009	.012
N3	6.1, 6.2, 6.3	□	722	□	640	□		.005	.006	.006	.007	.009	.012
N4	6.4	□	476	□	426	□		.004	.005	.006	.007	.008	.011
S1	4.1, 4.2, 4.3	▣	164	▣	148	▣		.003	.003	.004	.004	.005	.006
S2	5.1, 5.2, 5.3	▣	115	▣	98	▣		.003	.003	.004	.004	.005	.006
S3	5.1, 5.2, 5.3	▣	98	▣	82	▣		.002	.003	.003	.004	.004	.006
S4	5.1, 5.2, 5.3	▣	82	▣	66	▣		.002	.003	.003	.004	.004	.006

\* The material classification code used by Dormer is added here for cross reference purposes and should be used only as a guide.


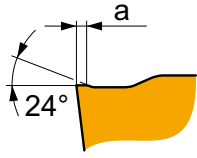
\* El código de clasificación de materiales utilizado por Dormer se ha añadido aquí como referencia y debe ser utilizado sólo como guía.

\* Le code de classification des matériaux utilisé par Dormer est ajouté pour permettre une correspondance et peut être utilisé comme un guide.

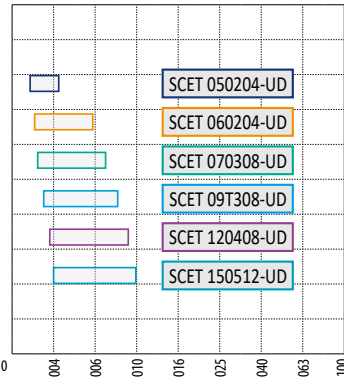
Table 4  
Tabla 4  
Tableau 4

GEOMETRY OF CUTTING INSERTS  
GEOMETRÍA DE PLAQUITAS DE CORTE  
GÉOMÉTRIE DES PLAQUETTES

**SCET.....-UD**



	a (in)
SCET 050204-UD	.005
SCET 060204-UD	.006
SCET 070308-UD	.006
SCET 09T308-UD	.006
SCET 120408-UD	.008
SCET 150512-UD	.008



Graph showing dimensions for SCET series. The x-axis represents dimension 'a' in inches, ranging from 0 to .100. The y-axis lists the series: SCET 050204-UD, SCET 060204-UD, SCET 070308-UD, SCET 09T308-UD, SCET 120408-UD, and SCET 150512-UD. A red arrow labeled 'f' points to the right.


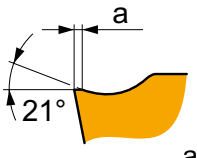
P	M	K	N	S	H
■	□	■	■	■	■

See diagram / Consultar diagrama  
Voir diagramme

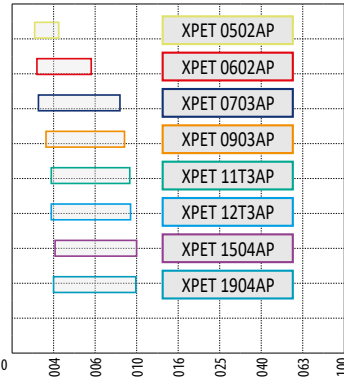



SCET.....-UD

**XPET.....AP**



	a (in)
XPET 0502AP	.004
XPET 0602AP	.004
XPET 0703AP	.006
XPET 0903AP	.010
XPET 11T3AP	.010
XPET 12T3AP	.010
XPET 1504AP	.010
XPET 1904AP	.010



Graph showing dimensions for XPET series. The x-axis represents dimension 'a' in inches, ranging from 0 to .100. The y-axis lists the series: XPET 0502AP, XPET 0602AP, XPET 0703AP, XPET 0903AP, XPET 11T3AP, XPET 12T3AP, XPET 1504AP, and XPET 1904AP. A red arrow labeled 'f' points to the right.

P	M	K	N	S	H
■	□	■	■	■	■

See diagram / Consultar diagrama  
Voir diagramme


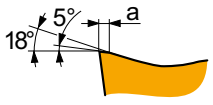



XPET.....AP

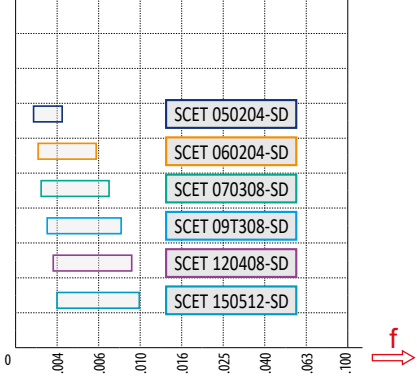
Table 4  
 Tabla 4  
 Tableau 4

GEOMETRY OF CUTTING INSERTS  
 GEOMETRÍA DE PLAQUITAS DE CORTE  
 GÉOMÉTRIE DES PLAQUETTES

**SCET .....-SD**



	$a_{(in)}$
SCET 050204-SD	.002
SCET 060204-SD	.002
SCET 070308-SD	.003
SCET 09T308-SD	.004
SCET 120408-SD	.004
SCET 150512-SD	.004



Series	Feed Rate Range (in)
SCET 050204-SD	0 - 0.004
SCET 060204-SD	0 - 0.006
SCET 070308-SD	0 - 0.010
SCET 09T308-SD	0 - 0.016
SCET 120408-SD	0 - 0.025
SCET 150512-SD	0 - 0.040


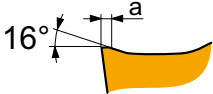
P	M	K	N	S	H
■	■	■	□	▣	■

$f$  See diagram / Consultar diagrama  
 Voir diagramme

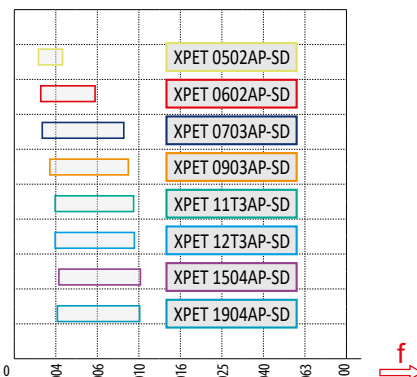



**?** SCET .....-SD

**XPET ....AP-SD**



	$a_{(in)}$
XPET 0502AP-SD	.002
XPET 0602AP-SD	.002
XPET 0703AP-SD	.003
XPET 0903AP-SD	.004
XPET 11T3AP-SD	.004
XPET 12T3AP-SD	.004
XPET 1504AP-SD	.004
XPET 1904AP-SD	.005



Series	Feed Rate Range (in)
XPET 0502AP-SD	0 - 0.004
XPET 0602AP-SD	0 - 0.006
XPET 0703AP-SD	0 - 0.010
XPET 0903AP-SD	0 - 0.016
XPET 11T3AP-SD	0 - 0.025
XPET 12T3AP-SD	0 - 0.040
XPET 1504AP-SD	0 - 0.063
XPET 1904AP-SD	0 - 0.100

P	M	K	N	S	H
■	■	■	□	▣	■

$f$  See diagram / Consultar diagrama  
 Voir diagramme

**?** XPET .... AP-SD

Table 5  
Tabla 5  
Tableau 5








FORMULAE FOR CALCULATION OF CUTTING PARAMETERS  
FÓRMULAS DE CÁLCULO DE LOS PARÁMETROS DE CORTE  
FORMULES DE CALCUL DES PARAMÈTRES DE COUPE

NOMENCLATURE AND FORMULA / NOMENCLATURA Y FÓRMULAS NOMENCLATURES ET FORMULES		
Parameter / Parámetro Paramètre	Formula / Fórmula Formule	Unit / Unidad Unité
RPM Velocidad del husillo Vitesse de rotation	$n = \frac{v_c \cdot 12}{D \cdot \pi}$	[1.min <sup>-1</sup> ]
Cutting speed Velocidad de corte Vitesse de coupe	$v_c = \frac{\pi \cdot D \cdot n}{12}$	[ft.min <sup>-1</sup> ]
Feed per minute (speed of feed) Velocida de avance Avance de table	$v_f = n \cdot f$	[in.min <sup>-1</sup> ]
Cross section area of the hole Área de sección transversal del orificio Section transversale du trou	$A = \frac{\pi \cdot D^2}{4}$	[in <sup>2</sup> ]
Metal removal rate Volumen de viruta Taux d'enlèvement de métal	$Q = f_{\min} \cdot A$	[in <sup>3</sup> .min <sup>-1</sup> ]
Machining time Tiempo de mecanizado Durée d'usinage	$T_c = \frac{L + h}{f_{\min}}$	[min/pcs] [min/pieza] [min/pièce]

D	Diameter of drill	[in]	D	Diámetro de la broca	[in]
f	Feed per revolution	[in/rev]	f	Avance por revolución	[in/rev]
h	Distance from drill point to workpiece before feeding	[in]	h	Distancia desde el punto de taladrado hasta la pieza que se trabaja antes de avanzar	[in]
L	Depth of hole	[in]	L	Profundidad del orificio	[in]
D	Diamètre du foret	[in]			
f	Avance par rotation	[tr/min]			
h	Distance entre la pointe du foret et la pièce à usiner avant l'avance	[in]			
L	Profondeur du trou	[in]			

Table 6  
Tabla 6  
Tableau 6

RECOMMENDED TIGHTENING TORQUES FOR SCREWS  
PARES DE APRIETE RECOMENDADOS PARA LOS TORNILLOS  
COUPLES DE SERRAGE RECOMMANDÉS POUR LES VIS

						
US 2245-T07P	0.9	FLAG T07P	M 2.2	5.3	D-T7P	MR-0.8-2.0 vario
US 2205-T07P	0.9	FLAG T07P	M2.2	5.4	D-T7P	MR-0.8-2.0 vario
US 2506-T07P	1.2	FLAG T07P	M 2.5	6	D-T7P	MR-0.8-2.0 vario
US 2507-T08P	1.2	FLAG T08P	M 2.5	7	D-T8P	MR-0.8-2.0 vario
US 3007-T08P	2.0	FLAG T08P	M 3	7	D-T8P	MR-1.0-5.0 vario
US 3007-T09P	2.0	FLAG T09P	M 3	7.4	D-T9P	MR-1.0-5.0 vario
US 3009-T09P	2.0	FLAG T09P	M 3	8.7	D-T9P	MR-1.0-5.0 vario
US 3508-T15P	3.0	FLAG T15P	M 3.5	8.3	D-T15P	MR-1.0-5.0 vario
US 3510-T15P	3.0	FLAG T15P	M 3.5	10.6	D-T15P	MR-1.0-5.0 vario
US 4011-T15P	3.5	FLAG T15P	M 4	10.7	D-T15P	MR-1.0-5.0 vario
US 5012-T15P	5.0	FLAG T15P	M 5	12.2	D-T15P	MR-1.0-5.0 vario

**MACHINING DATA FOR INDEXABLE DRILLS**  
**CARACTERISTICAS DE MECANIZADO PARA BROCAS CON PLAQUITAS INTERCAMBIABLES**  
**CARACTÉRISTIQUES D'USINAGE POUR LES FORETS A PLAQUETTES INDEXABLES**

### Radial adjustment

#### Hole diameter adjustment and set-up recommendation

Radial adjustment is possible with indexable drills to achieve a smaller or larger hole diameter than the actual drill.

Radial adjustment values are available in the main drill data tables.

#### Rotating tool

For drilling holes with accuracy IT10 and higher, adjustable holders are recommended when using 802D, 803D, 804D and 805D drills.

#### Stationary tool

When mounting the drill make sure the drill centre line and workpiece centre are aligned. To achieve a larger hole diameter displace the drill so that the peripheral insert moves in a + away from the workpiece center line (see diagram below).

### Ajustement radial

#### Ajustement du diamètre du trou et recommandations de réglage

Il est possible de régler radialement un foret à plaquettes afin d'obtenir un trou de diamètre plus petit ou plus grand que le diamètre de foret. Les valeurs d'ajustement radial sont présentées dans le tableau des caractéristiques générales des forets.

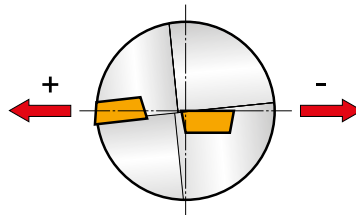
#### Outil rotatif

Un support ajustable est recommandé pour le réglage du diamètre d'un trou d'une précision IT10 ou plus avec les forets rotatifs de la série 80xD.

#### Outil fixe

Lors du montage du foret, s'assurer que le centre du foret et le centre de la pièce à usiner sont alignés. Pour un diamètre de trou plus important, déplacer le foret afin que la plaquette périphérique parte de l'axe central de la pièce.

Picture / Imagen / Image 1



### Ajuste radial

#### Ajuste del diámetro del orificio y recomendaciones de colocación

Las brocas de plaquita se pueden desplazar fuera del centro para lograr un diámetro del orificio más pequeño o más grande que con la broca. Los valores de ajuste radial se encuentran en la tabla principal de datos de las brocas.

#### Herramienta giratoria

Para taladrar agujeros con tolerancia IT10 y superior con brocas 802D, 803D, 804D y 805D, se recomienda utilizar soportes ajustables.

#### Herramienta fija

Al montar la broca, asegúrese de que la línea del centro de la broca y la línea del centro de la pieza que se trabajará están alineadas. Para lograr un diámetro del orificio mayor, desplace la broca de forma que la plaquita periférica se mueva en ese sentido desde la línea del centro de la pieza que se trabajará.

### Tool life

Inserts should be changed when flank wear measures .008 – .016 in at the largest point. Cutting data recommendations in this catalogue are aimed at achieving tool life of 23 feet drilling depth on the peripheral insert. (20 – 30 mins contact).

### Duree de vie d'outil

Les plaquettes ne doivent pas être utilisées lorsque l'usure de flanc excède .008 – .016 in au point le plus important.

Les recommandations de vitesse de coupe mentionnées dans ce catalogue sont basées sur une durée de vie de plaquette périphérique représentant une longueur totale de trou percé de 23 feet (durabilité 20 – 30 min.)

### Vida útil de la herramienta

No se deberían utilizar plaquetas con un desgaste del flanco superior a .008 – .016 in medidos en el punto mayor.

Las recomendaciones acerca de la velocidad de corte que se mencionan en este catálogo se basan en la vida útil de la herramienta en función de plaquetas periféricas de agujeros perforados con una longitud total de 23 feet (durabilidad 20 – 30 min).

# EP

ADJUSTABLE SLEEVE  
CASQUILLO AJUSTABLE  
BAGUE EXCENTRIQUE

Table 7 / Tabla 7 / Tableau 7

Shank dia. / Diám. del mango Diam. de queue	Drill dia. / Diám. broca Diam. de foret	Range / Rango Plage
.984	.591 – .954	.016 – -.008
1.260	.965 – 1.575	.016 – -.008

**For Milling Machines**

Diameter adjustment range

**Ajuste del diámetro – para centro de mecanizado**

Rango de ajuste del diámetro

**Ajustement de diamètre pour centre d'usinage**

Plage d'ajustement de diamètre

Picture / Imagen / Image 2

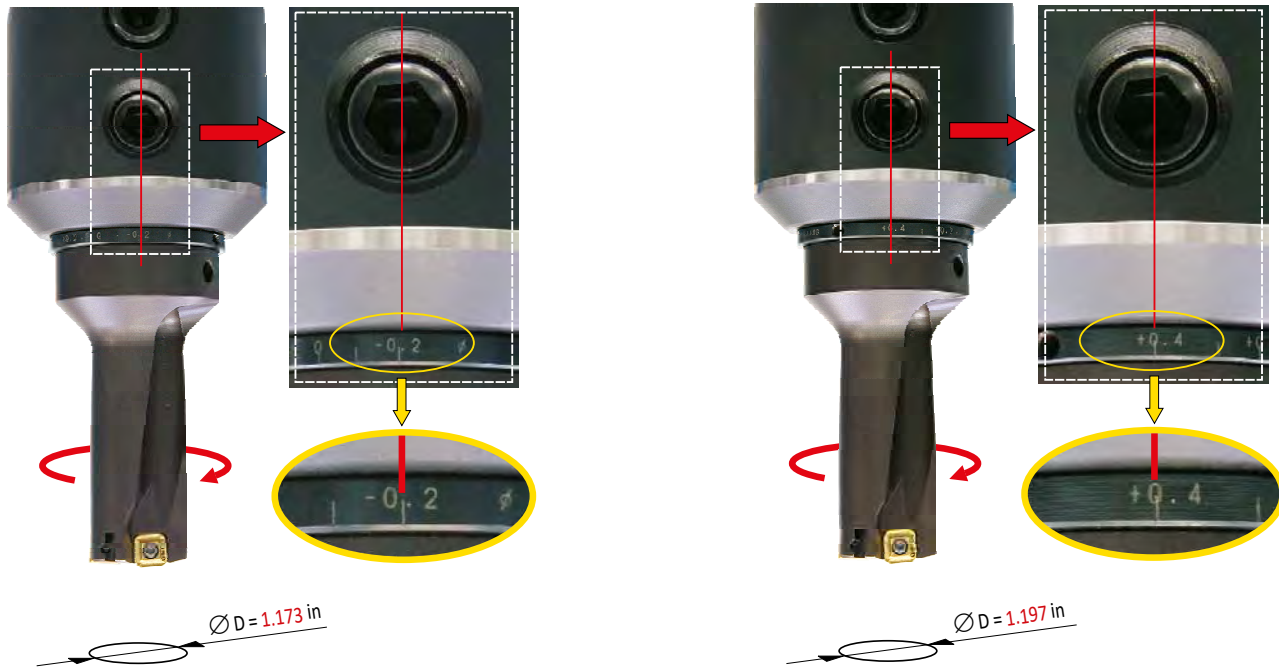


Table 8 / Tabla 8 / Tableau 8

Shank dia. / Diám. del mango Diam. de queue	Drill dia. / Diám. broca Diam. de foret	Range / Rango Plage
.984	.591 – .954	.008 – -.006
1.260	.965 – 1.575	.008 – -.006

**Center height adjustment**

– for lathe operation

Ajuste de altura centro

– para funcionamiento de torno

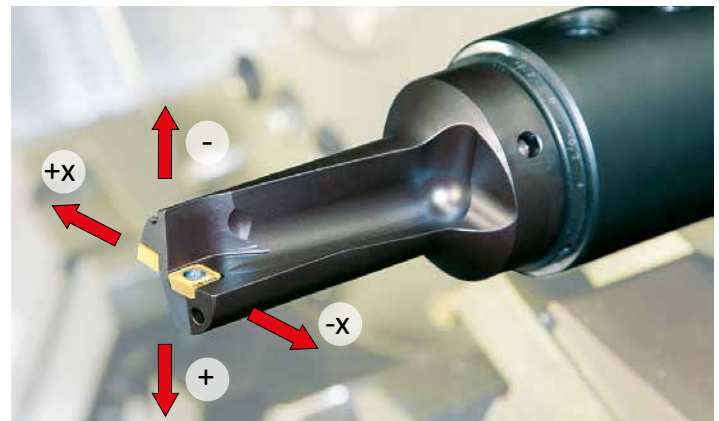
Ajustement de hauteur/centrage

– pour les opérations de tournage

Picture 3

Imagen 3

Image 3



Center height adjustment range  
Rango de ajuste de altura centro  
Plage d'ajustement de hauteur et de centrage

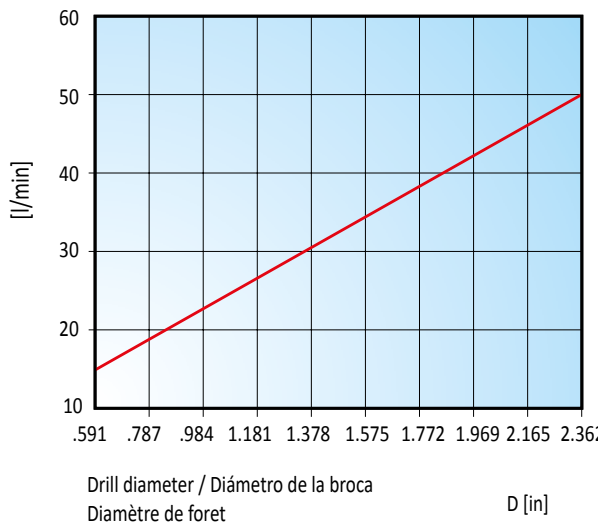


**MACHINING DATA FOR INDEXABLE DRILLS**  
**CARACTERISTICAS DE MECANIZADO PARA BROCAS CON PLAQUITAS INTERCAMBIABLES**  
**CARACTÉRISTIQUES D'USINAGE POUR LES FORETS A PLAQUETTES INDEXABLES**

**Recommended pressure of supplied cutting fluid**  
**Presion recomendada del liquido de corte suministrado**  
**Pression recommandée du liquide de coupe**

Table / Tabla / Tableau 9

Drill diameter Diámetro de la broca Diamètre de foret	D [in]	Pressure of cutting fluid <b>p</b> / Presión del liquido de corte <b>p</b> / Pression du liquide de coupe <b>p</b>	
		Drill length / Longitud de la broca / Longueur de foret	
		2.0 - 2.5 D	3.0 - 5.0 D
.591 – .984		87 psi	174 psi
1.024 – 1.575		65 psi	130 psi
> 1.575		44 psi	87 psi



**Coolant volume requirement**

**DRY DRILLING**

Pressurised air through the drill is recommended when drilling without coolant in cast iron and steel

**Requisito de volumen de refrigerante**

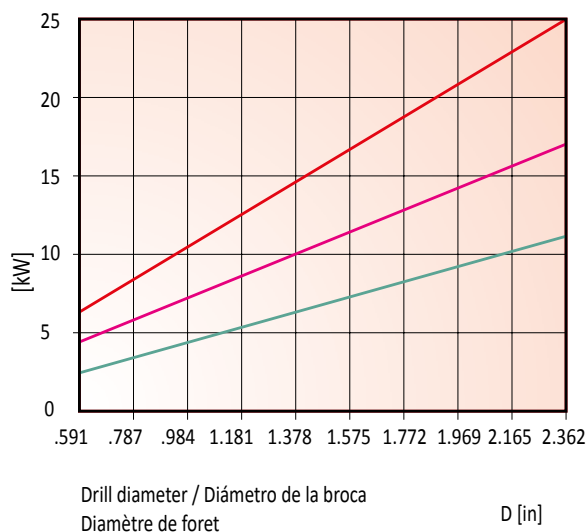
**TALADRADO EN SECO**

Se puede taladrar fundición o acero sin refrigerante, aunque se necesitará aire presurizado a través de la broca al realizar el taladrado.

**Débit de liquide de refroidissement nécessaire**

**PERÇAGE À SEC**

Il est possible de percer sans liquide de refroidissement dans la fonte et l'acier, à condition d'utiliser de l'air comprimé à travers le foret.



**Net power consumption**

**Consumo eléctrico neto**

**Puissance consommée nette**

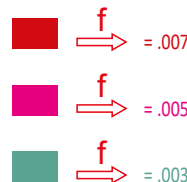


Table 10  
Tabla 10  
Tableau N°10

**COMMON MACHINING DATA**  
**CARACTERISTICAS COMUNES DE TRABAJO**  
**DONNÉES D'USINAGE GÉNÉRALES**

	<p><b>BLIND HOLE DRILLING</b> For drilling holes deeper than 1D internal cooling is necessary.</p>	<p><b>TALADRADO DE AGUJERO CIEGO</b> Para agujeros con una profundidad mayor de 1xD es necesario refrigerante.</p>	<p><b>PERÇAGE D'UN TROU BORGNE</b> L'arrosage est nécessaire pour un trou plus profond que 1xD</p>
	<p><b>THROUGH HOLE DRILLING</b> A disc can be produced when the indexable drill exits the material. This disc can be ejected at high speed when the workpiece is rotating. It is essential that the machine is adequately guarded to ensure operator safety</p>	<p><b>TALADRADO DE AGUJERO PASANTE</b> Se puede producir un disco a la salida de la broca de plaquitas que puede ser proyectado a gran velocidad cuando la pieza esta girando. Es esencial que la máquina esté protegida adecuadamente para garantizar la seguridad del operario.</p>	<p><b>PERÇAGE D'UN TROU DÉBOUCHANT</b> Une rondelle peut être produite lors de la sortie du foret hors de la pièce. Pour la sécurité de l'opérateur, il est essentiel d'équiper la machine de dispositifs de protection.</p>
	<p><b>OFF-CENTER DRILLING</b> Decrease the feed to lower recommended values for particular inserts. See inserts description pages for indexable drills. Do not exceed radial adjustment values.</p>	<p><b>BROCA DESCENTRADA</b> Reducir el avance al mínimo recomendado para las plaquitas utilizadas. Ver la descripción de las plaquitas. No exceder los valores de ajuste radial.</p>	<p><b>PERÇAGE EXCENTRÉ</b> Diminuer l'avance jusqu'au plus bas de celle recommandée pour les plaquettes sélectionnées. Voir les pages géométries de plaquettes. Ne pas dépasser les valeurs de réglage radial.</p>
	<p><b>STARTING ON UNEVEN AND CAST SURFACES</b> Decrease the feed by 50% on entrance for indexable drills until both inserts are engaged.</p>	<p><b>INICIO DEL TALADRADO EN SUPERFICIES IRREGULARES</b> Reducir el avance un 50% a la entrada hasta que las dos plaquitas estén dentro del agujero.</p>	<p><b>ALÉSAGE SUR DES SURFACES IRREGULIÈRES ET MOULÉES</b> Diminuer l'avance à la pénétration des forets à plaquettes indexables, jusqu'à ce que les deux plaquettes soient engagées.</p>
	<p><b>BORING AND DRILLING INTO PILOT HOLES</b> If a pre-drilled hole is larger than 1/4 drill diameter, decrease the feed.</p>	<p><b>TALADRADO Y MANDRINADO CON AGUJERO PILOTO</b> Si el agujero piloto es mayor de 1/4 del diámetro de la broca, reducir el avance.</p>	<p><b>ALÉSAGE ET PERÇAGE DANS UN TROU PRÉ-PERCÉ</b> Si le trou pré-percé est supérieur à 1/4 du diamètre de foret, diminuer l'avance.</p>
	<p><b>DRILLING CROSS HOLES</b> Decrease the feed by 50% when drilling across an existing hole. The diameter of existing hole should not be larger than .25 x D.</p>	<p><b>TALADRADO CON AGUJEROS CRUZADOS</b> Reducir el avance un 50% al taladrar a través de un agujero existente. El diámetro de los agujeros cruzados no debe ser mayor de .25xD.</p>	<p><b>PERÇAGE A TRAVERS UN TROU EXISTANT</b> Diminuer l'avance de 50% lors d'un perçage à travers un trou existant. Le diamètre du trou existant ne doit pas dépasser .25xD .</p>
	<p><b>INTERRUPTED CUT AND PLUNGING</b> Decrease the feed to lower recommended feed values for particular insert. See inserts description site for indexable drills.</p>	<p><b>CORTE INTERRUPTIDO Y PLUNGING</b> Reducir el avance al mínimo recomendado para las plaquitas utilizadas. Ver la descripción de las plaquitas.</p>	<p><b>COUPE INTERROMPUE ET TRÉFLAGE</b> Diminuer l'avance jusqu'au plus bas de celle recommandée pour les plaquettes sélectionnées. Voir les pages géométries de plaquettes.</p>
	<p><b>DRILLING ON CURVED SURFACE</b> Drilling on the center line can be done with reduced feed rate down to 50% during entrance and exit.</p>	<p><b>TALADRADO EN SUPERFICIES CURVAS</b> Se puede taladrar con el centro reduciendo el avance al 50% durante la entrada y la salida.</p>	<p><b>PERÇAGE SUR SURFACE INCURVÉE</b> Le perçage centré peut être effectué avec une avance réduite à 50% en entrée et en sortie.</p>
	<p><b>DRILLING ON ANGLED SURFACES</b> Decrease the feed by 50% on entrance for indexable drills until both inserts are engaged if the angle of entry is more than 5°.</p>	<p><b>TALADRADO EN SUPERFICIES INCLINADAS</b> Reducir el avance un 50% a la entrada hasta que las dos plaquitas estén dentro del agujero si el ángulo de entrada es mayor de 5°.</p>	<p><b>PERÇAGE SUR DES SURFACES INCLINÉES</b> Diminuer l'avance de 50% à la pénétration des forets à plaquettes indexées, jusqu'à ce que les deux plaquettes soient engagées si l'angle d'entrée est supérieur à 5°.</p>
	<p><b>EXIT ON ANGLED SURFACE</b> Decrease the feed by 50% on exit if angle of exit is more than 5°.</p>	<p><b>SALIDA EN SUPERFICIES INCLINADAS</b> Reducir el avance un 50% a la salida si el ángulo de salida es mayor de 5°.</p>	<p><b>SORTIE DE SURFACE INCLINÉE</b> Diminuer l'avance de 50%, si l'angle de sortie est supérieur à 5°.</p>
	<p><b>STARTING ON A WELDED SEAM</b> Facing is recommended before drilling. Decrease the feed by 50% during drilling of the welded material.</p>	<p><b>ENTRADA EN SOLDADURA</b> Se recomienda fresar previamente. Reducir el avance un 50% durante el taladrado del material de soldadura.</p>	<p><b>AMORÇAGE SUR UN POINT DE SOUDURE</b> Un dressage est recommandé avant le perçage. Diminuer l'avance de 50% pendant le perçage du matériau soudé.</p>
	<p><b>DRILLING OF STACKED MATERIALS</b> Avoid spaces larger than .008 in between layers. The component must be securely fixed. If necessary reduce the feed.</p>	<p><b>TALADRADO DE PAQUETES</b> Evitar que el espacio entre piezas sea mayor de .008 in. El paquete debe estar sujeto con mucha seguridad. Reducir el avance si es necesario.</p>	<p><b>PERÇAGE DE MATÉRIAUX EMPILÉS</b> Éviter des interstices de plus de .008 in entre les éléments. Le composant doit être correctement fixé. Réduire l'avance si nécessaire.</p>

TROUBLESHOOTING FOR INDEXABLE DRILLS  
RESOLUCION DE PROBLEMAS CON BROCAS DE PLAQUITAS INTERCAMBIABLES  
RÉSOLUTION DES PROBLÈMES

<p style="text-align: center;">LOW PERFORMANCE OF DRIVING MOTOR (LOW SPINDLE POWER)</p> <p style="text-align: center;">BAJO RENDIMIENTO DEL MOTOR DE IMPULSIÓN (MOMENTO DE TORSIÓN BAJO EN EL EJE)</p> <p style="text-align: center;">MANQUE DE PUISSANCE DE LA BROCHE</p>	<p>a) reduce cutting speed = reduction of spindle RPM b) reduce feed rate</p> <hr/> <p>a) reducción de la velocidad de corte; reducción de las revoluciones del eje b) reducción del avance</p> <hr/> <p>a) réduire la vitesse de coupe = réduire la vitesse de rotation de la broche b) réduire l'avance</p>
<p style="text-align: center;">EXCESSIVE WEAR OF PERIPHERAL INSERT</p> <p style="text-align: center;">DESGASTE EXCESIVO DEL FILO DE LA PLAQUITA DE CORTE PERIFÉRICA</p> <p style="text-align: center;">USURE EXCESSIVE DE L'ARÊTE DE LA PLAQUETTE DE COUPE PÉRIPHÉRIQUE</p>	<p>a) reduce cutting speed = reduction of spindle RPM b) choose a more wear resistant grade c) increase coolant volume and pressure</p> <hr/> <p>a) reduzca la velocidad de corte; reduzca las revoluciones del eje b) escoja una calidad de plaquita más resistente al desgaste c) aumente el volumen y la presión del líquido de corte</p> <hr/> <p>a) réduire la vitesse de coupe = réduire la vitesse de rotation de la broche b) choisir une nuance de plaquette plus résistante à l'usure c) augmenter le débit et la pression du liquide de coupe</p>
<p style="text-align: center;">CHIPPING OF PERIPHERAL INSERT</p> <p style="text-align: center;">DESPORTILLADO DE LA PLAQUITA PERIFERICA</p> <p style="text-align: center;">PASTILHA PERIFÉRICA LASCADA</p> <p style="text-align: center;">ÉCAILLAGE DE LA PLAQUETTE PÉRIPHÉRIQUE</p>	<p>a) reduce feed rate until peripheral insert is fully engaged b) choose a tougher insert grade c) reduce cutting speed</p> <hr/> <p>a) reduzca el avance durante el taladrado (sobre todo en superficies de entrada irregulares de las piezas a mecanizar) b) escoja una plaquita más resistente al desgaste c) reduzca la velocidad de corte</p> <hr/> <p>a) réduire l'avance jusqu'à l'engagement complet de la plaquette périphérique b) choisir une nuance de plaquette plus tenace c) réduire la vitesse de coupe</p>

<p>CHIPPING OF CENTER INSERT          DESPORTILLADO DE LA PLAQUITA CENTRAL          PASTILHA CENTRAL LASCADA          ÉCAILLAGE DE LA PLAQUETTE CENTRALE</p>	<p>a) reduce feed rate during entry          b) check the drill and workpiece clamping</p> <hr/> <p>a) reduzca el avance al entrar          b) compruebe la fijación de la broca y de la pieza a mecanizar</p> <hr/> <p>a) réduire l'avance à l'entrée          b) vérifier le serrage du foret et de la pièce à usiner</p>
<p>CONTINUOUS, BADLY FORMED CHIP          VIRUTA DEFORMADA DE FORMA CONTINUADA          APARA CONTINUAMENTE MAL FORMADA          COPEAU CONTINU MAL FORMÉ</p>	<p>a) adjust feed rate          b) increase cutting speed and simultaneously reduce feed rate</p> <hr/> <p>a) cambie el avance          b) aumente la velocidad de corte y reduzca a la vez el avance</p> <hr/> <p>a) ajuster l'avance          b) augmenter la vitesse de coupe tout en réduisant l'avance.</p>
<p>SWarf CONGESTION IN THE FLUTES          ATASCO DE PEQUEÑAS VIRUTAS EN LAS HENDIDURAS PERIFÉRICAS          AGLOMERAÇÃO DE PEQUENAS APARAS NAS RANHURAS PERIFÉRICAS          ACCUMULATION DE COPEAUX COURTS DANS LES GOUJURES</p>	<p>a) increase coolant volume and pressure          b) reduce cutting speed          c) adjust feed rate</p> <hr/> <p>a) aumente el volumen y la presión del líquido de corte          b) reduzca la velocidad de corte          c) cambie el avance</p> <hr/> <p>a) augmenter le débit et la pression du liquide de coupe          b) réduire la vitesse de coupe          c) ajuster l'avance</p>

Table 12  
Tabla 12  
Tableau N°12

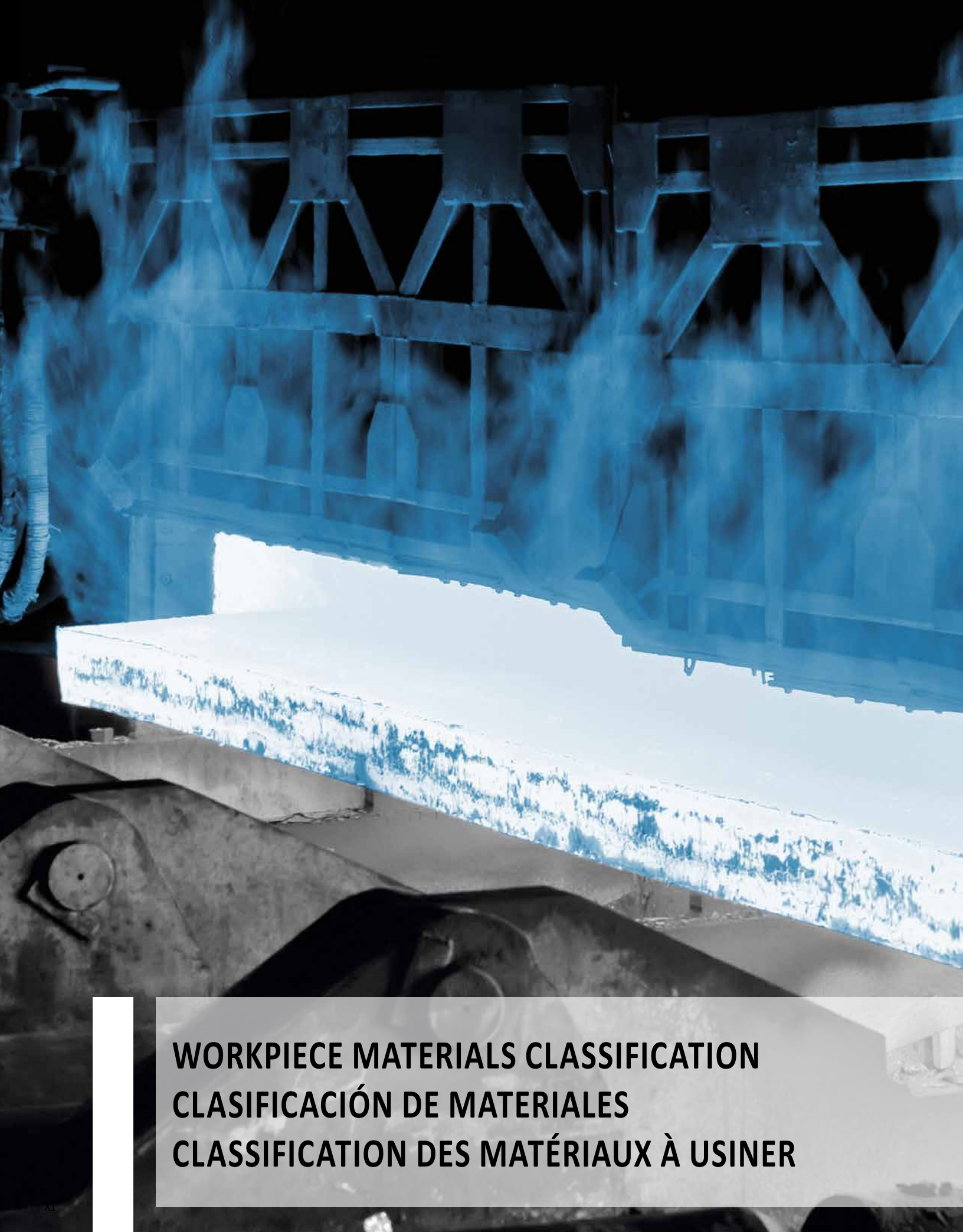
**RECOMMENDED DRILL SIZES FOR TAPPING**  
**MEDIDAS DE BROCAS CON MACHO DE ROSCAR RECOMENDADAS**  
**DIAMÈTRES DES FORETS RECOMMANDÉS AVANT TARAUDAGE**

Metric ISO threads Roscas ISO métricas Filets métriques ISO		Recommended drill diameter for [in] Diámetro de broca recomendado [in] Diamètre de foret recommandé pour [in]	
Thread Rosca Filet	Pitch Paso Pas	Cutting Tap Macho de corte Taraud de coupe	Fluteless Tap Macho de laminación Taraud par déformation
M16 × 1.0	1.00	.591	.610
M16 × 0.75	0.75	.602	–
M17 × 1.0	1.00	.630	–
M18	2.50	.610	.661
M18 × 2.0	2.00	.630	–
M18 × 1.5	1.50	.650	.681
M18 × 1.0	1.00	.669	–
M20	2.50	.689	.740
M20 × 2.0	2.00	.709	–
M20 × 1.5	1.50	.711	.760
M20 × 1.0	1.00	.748	–
M22	2.50	.768	.819
M22 × 2.0	2.00	.787	–
M22 × 1.5	1.50	.807	.839
M22 × 1.0	1.00	.827	–
M24	3.00	.827	.886
M24 × 2.0	2.00	.866	–
M24 × 1.5	1.50	.886	.917
M27	3.00	.945	–
M27 × 2.0	2.00	.984	–
M30	3.50	1.043	–
M30 × 2.0	2.00	1.102	–
M33	3.50	1.161	–
M36	4.00	1.260	–
M36 × 3.0	3.00	1.299	–
M39	4.00	1.378	–
M42	4.50	1.476	–
M42 × 3.0	3.00	1.535	–
M45	4.50	1.594	–
M48	5.00	1.693	–
M48 × 3.0	3.00	1.772	–
M52	5.00	1.850	–
M52 × 3.0	3.00	1.890	–

Inch threads UNF Roscas pulgadas UNF Filet unifié (pouces) UNF		Recommended drill diameter for [in] Diámetro de broca recomendado [in] Diamètre de foret recommandé pour [in]	
Thread Rosca Filet	No. of threads / 1" N.º de roscas / 1" No. de filets / 1"	Cutting Tap Macho de corte Taraud de coupe	Fluteless Tap Macho de laminación Taraud par déformation
3/4	16	.689	.720
7/8	14	.807	.839
1	12	.921	.957
1 1/8	12	1.043	–
1 1/4	12	1.173	–
1 3/8	12	1.299	–
1 1/2	12	1.417	–

Inch threads UNC Roscas pulgadas UNC Filets en pouce UNF		Recommended drill diameter for [in] Diámetro de broca recomendado [in] Diamètre de foret recommandé pour [in]	
Thread Rosca Filet	No. of threads / 1" N.º de roscas / 1" No. de filets / 1"	Cutting Tap Macho de corte Taraud de coupe	Fluteless Tap Macho de laminación Taraud par déformation
3/4	10	.657	.701
7/8	9	.768	.819
1	8	.874	.937
1 1/8	7	.984	–
1 1/4	7	1.110	–
1 3/8	6	1.220	–
1 1/2	6	1.339	–
1 3/4	5	1.555	–
2	4 1/2	1.780	–
2 1/4	4 1/2	2.031	–
2 1/2	4	2.252	–

Whitworth pipe threads Roscas Whitworth en tubo Filets Whitworth		Recommended drill diameter for [in] Diámetro de broca recomendado [in] Diamètre de foret recommandé pour [in]	
Thread Rosca Filet	No. of threads / 1" N.º de roscas / 1" No. de filets / 1"	Cutting Tap Macho de corte Taraud de coupe	Fluteless Tap Macho de laminación Taraud par déformation
G 3/8	19	.591	.630
G 1/2	14	.748	.787
G 5/8	14	.827	.866
G 3/4	14	.965	1.004
G 7/8	14	1.114	1.154
G 1	11	1.213	1.260
G 1 1/8	11	1.398	–
G 1 1/4	11	1.555	–
G 1 3/8	11	1.646	–
G 1 1/2	11	1.783	–
G 1 3/4	11	2.008	–
G 2	11	2.244	–



**WORKPIECE MATERIALS CLASSIFICATION**  
**CLASIFICACIÓN DE MATERIALES**  
**CLASSIFICATION DES MATÉRIAUX À USINER**



International equivalents / Equivalents internationaux / Equivalences internationales

	AMS/SAE	ČSN	GB	EN	EU	ISO	ARNOR	JIS	DIN	D	W-nr	PN	GOST	BS	E
1	Gr.A	10 000	Q.195	S 185		Fe 310	A 33	ST 33.1	ST 33.1	S 185	1.0085	St 0 S	St 0	S 185	S 185
1	Gr.A	10 004	Q.195	S 185		Fe 310-0	A 33	Sr 33-2	Sr 33-2	Sr 33-2	1.0085	St 0 S	St 0	15 HR, HS	AE 235 B
1	Gr.1213	10 216	Q.195	Fe B22		Type 2	Fe E24	IG	IG	IG	1.0715	A 10K	A 1	230M07	11SMn28
1	Gr.1108	11 109	Y12	11SMn28		S 250	S 250	95Mn28	95Mn28	95Mn28	1.0721	A 11	A 12	210M15	10S20
1	Gr.1140	11 110	Y12	10S20		Type 2	10F1	10S20	10S20	10S20	1.0724	A 11	A 12	210M15	10S20
1	Gr.1140	11 120	Y20	20F2		35S20	20F2	22S20	22S20	22S20	1.0724	A 35	A 30	212M36	35 MMS 6
1	Gr.1005	11 300	Y35	35S20		35S20	35 MF 6	35S20	35S20	35S20	1.0314	A 35	A 30	212M36	35 MMS 6
1	1008	11 301	08 F	FeP02		Cr 04	A 48 CP	US113	US113	US113	1.0333	1.0336	05kp	2HR,HS,Cr,CS	
1	A619	11 304	08 F	FeP03		Cr 04	A 48 FP	US14	US14	US14	1.0338	08J	08lu	1HR,HS,Cr,CS	DC04
1	1008	11 320	DC 01	FeP04		Cr 03	ES	St 14	St 14	St 14	1.0338	08K	08kp	1HR,HS,Cr,CS	DC 04
1	1008	11 321	DC 01	DC 01		Cr 01	FeP01	St 12	St 12	St 12	1.0322	08K	08lu	DC 01/FeP 01	DC 01
1	11 325	11 325				Cr 0	SPCC	SPCC	SPCC	SPCC				AP 04	AP 04
1	366	11 330		Cr 0		Cr 0	SPCC	SPCC	SPCC	SPCC				Cr 2	
1	Gr.C	11 331	A3	CR1		CR1	DC01/FeP01	SPCC	SPCC	SPCC	1.0330	St 3X	S3hp	3CR	FeP01/DC01
1	1120	11 343	A3	S235JRG1		S 330	A34-2	S330	S330	S330	1.0028	S13X	16D	CEW2BK	S235JRG1
1	Gr.55	11 353	Q235C	P235GH		STKM12A	A 37 AP CP	STKM12A	STKM12A	STKM12A	1.0308	R35	10	CF53	
1	Gr.A	11 364	Q235C	P235GH		P 3	A 37 AP	SPV 450	H 1	H 1	1.0345	St 36 K	12K	141-360	F 6304
1	Gr.1	11 368	Q235C	P235GH		P 5	A 37 AP	SGV 410	H 1	H 1	1.0345	St 36K	12K	141-360	A 37RCI
1	Gr.C	11 373	Q235C	S235JRG1		Fe 360 B	A 37 FP	AS135	AS135	AS135	1.0086	St 3X	S3hp	15 K	A 37 RBII
1	Gr.58	11 378	Q235C	S235JRG2		Fe 360 B	A 42 AP	US37-2	US37-2	US37-2	1.0086	S13X	S3hp	15 K	A 37 RBII
1	Gr.55	11 381	Q235C	S235JRG2Cu		Fe 360 C	E 24-3	S235JRG2	S235JRG2	S235JRG2	1.0086	S13X	S3hp	15 K	A 37 RBII
1	Gr.60	11 418	Q235C	P265GH		F 5	A 42 AP	RS17-2 Cu3	RS17-2 Cu3	RS17-2 Cu3	1.0167	S13 SCu	16D	40 D	AE 235D
1	Gr.60	11 419	Q235C	P265GH		F 7	A 42 FP	AS135	AS135	AS135	1.0425	S141K	16K	151-400	A 37 RBII
1	1020	11 423	Q225A	P310NB		A 42 FP1	A 42 FP1	St 458	St 458	St 458	1.0437	S141K	20K	161-430	A 42 RCI
1	Gr.D	11 425	Q225A	S275JR		E 28-2	E 28-2	AS141	AS141	AS141	1.0437	S141K	20K	161-430	A 42 RCI
1	Gr.70	11 428	Q225A	S275JR		E 28-3	E 28-3	US142.2	US142.2	US142.2	1.0437	S141K	20K	161-430	A 42 RCI
1	X 42	11 431	Q225A	Fe 42B		Fe 430B	E 28-2	RS42-2	RS42-2	RS42-2	1.0437	S141K	20K	161-430	A 42 RCI
1	1035	11 453	Q225A	Fe 42B		Fe 430B	E 28-2	St 42-3	St 42-3	St 42-3	1.0437	S141K	20K	161-430	A 42 RCI
1	Gr.F	11 474	Q225A	P 295 NH		P 11	A 48 CP	St 44-2	St 44-2	St 44-2	1.0444	S141K	20K	161-430	A 42 RCI
1	Gr.B.C	11 478	Q225A	P 295 GH		P 11	A 48 FP	St 45	St 45	St 45	1.0444	S141K	20K	161-430	A 42 RCI
1	X 46	11 481	Q225A	P 295 GH		P 11	A 48 FP	HIV	HIV	HIV	1.0445	S141K	20K	161-430	A 42 RCI
1	Gr.50 type 1 až 4	11 483	16Mn	S355J0G3		Fe 510D	E 36-3	AS145	AS145	AS145	1.0466	S141K	20K	161-430	A 42 RCI
1	Gr.50	11 484	16Mn	E 295		Fe 480	A 48 FP1	AS145	AS145	AS145	1.0466	S141K	20K	161-430	A 42 RCI
2	Gr.50	11 500	Q275	E 295		Fe 480	A 50	AS145	AS145	AS145	1.0466	S141K	20K	161-430	A 42 RCI
1	Gr.15180	11 523	16Mn	Fe 510		Fe 510	E 36-3	SMS20C	SMS20C	SMS20C	1.0570	1862-A-Cu	1062 BD	50/35HR	S355J0G3
1	Gr.A	11 531	Q275	Fe 510 D2		Fe 510 D2	A 52 FP	St 52-3 Cu3	St 52-3 Cu3	St 52-3 Cu3	1.0570	G355	S345	50C	S355J0G3
2	1050	11 550	Q275	S355J0Cu		Fe 510 D2	A 52 FP	AS152	AS152	AS152	1.0570	S15	S285	43/35HS	A490-2
2	Gr.65	11 600	Q275	E 355		Fe 590	E 335	AS152	AS152	AS152	1.0570	S15	S285	43/35HS	A490-2
3	Gr.1010,1011,1M1010	11 700	10	E 360		Fe 690	A 70	STKM 16 A	STKM 16 A	STKM 16 A	1.0570	S15	S285	43/35HS	A490-2
1	Gr.1010,1011,1M1010	12 010	10	2C10		C10	XC10	SW570	SW570	SW570	1.0070	S17	S375	045A10	C10K
1	12 011	12 011	10	2C10		C10	XC10	SW570	SW570	SW570	1.0070	S17	S375	045A10	C10K
1	12 014	12 014	10	2C10		C10	XC10	SW570	SW570	SW570	1.0070	S17	S375	045A10	C10K
1	12 014	12 014	10	2C10		C10	XC10	SW570	SW570	SW570	1.0070	S17	S375	045A10	C10K
1	Gr.1016	12 020	15	C15E		C15E4	C18RR	C15	C15	C15	1.1141	E2	10880	080M15	C16K

International equivalents / Equivalences internationales / Equivalences internacionais

	ANSI/SAE	ČSN	GB	EN	ISO	AFNOR	JIS	DIN	DIN		PN	GOST	BS	E
1	Gr.A	12 021			TS5	ARJ0R	STB 340	St 35.8	St 35.8	1.0395	K 10	10		
1	Gr.B	12 022			TS 14		STB 410	St 45.8	St 45.8	1.0405	K 18	20	430	
1	Gr.1015	12 023		Cl5E	Cl5E4	XCl5	S15C	C15	C15	1.1141	15	15	040A15	
1	1020	12 024		C22	C 25	XCl8	S22C	C 22	C 22	1.0402	20	20	070M20	
3	Gr.1025	12 030	25	2C25	C25E4	XCl25	S28C	C 25	C 25	1.0406	25	25	070M26	C25k
1	1030	12 031	30	C30	C 30 E4	XCl32	S30C	Cl30	Cl30	1.0528	30	30	080M32	
3	Gr.1035	12 040	35	C35	C35E4	C35	S35C	C 35	C 35	1.0501	35	35	40HS	C35
3	1040	12 041	40	C40	C40E4	XCl42 HI	S40C	Cl40	Cl40	1.0511	40	40	080M40	C 40
1		12 042	35 B	C 35 BKO	C40E4	38 B3	SWRCHB 234	35 B2	35 B2		45	45		F.1295
2	Gr.1043	12 050	45	C45	G60E4	C45	S45C	C45	C45	1.0503	45	45	50HS	C45k
2	1050	12 051	50	C50	C50E4	XCl48 H1	S50C	Cl50	Cl50	1.1206	50	50	080M50	1 C 50
3	Gr.1055	12 060	55	C55	C55E4	C54	S55C	C 55	C 55	1.0535	55	50	60HS	C55
4	1060	12 061	60	2 C 60	C 60 E4	C60	S58C	Cl60	Cl60	1.0601	60	60	60HS	C60
2	Gr.1070	12 071		1 C67		C68	S70C-CP	Cl67	Cl67		65	65	080A67	
2	Gr.1078	12 081	75	1C75	C575	XCl75		Cl75	Cl75	1.1248	75	75	80HS	
3	1086	12 090	85	2 C 85	CS 85	C90RR	SK 5-CP	C85E	C85E	1.1269	85	85	80HS	80HS
2	Gr.1330	13 141	30Mn2	28Mn6	28Mn6	35M5	SCMn2	28Mn6	28Mn6	1.1165	30G2	30G2	120M36	30Mn5
2	9250	13 151				45 S 7		46 S 7	46 S 7	1.5024	45 S			46 S 7
4		13 180	35SiMn			38M55		80Mn4	80Mn4	1.5122	65G	70G		
3		13 240						37MnS15	37MnS15	1.5122	35SG	35SG		
3		13 242						42MnV7	42MnV7	1.5223				
4	9250	13 251			Type 3	45S7	SUP6	46S7	46S7	1.5024	45S	50S2	250A53	F.1451
4	Gr.9260H	13 270	60Si2Mn			60S7	SUI2	60S7	60S7	1.5028	60S2	60S2	251A58	60S7
3	52100	14 100	G Cl15		Type 1-0	100C6	SUI2	100C6	100C6		LH 15	Šch 15	534A99	F.1310
2	52100	14 109	Gr.15		Type 1-0	100C6	SUI2	100C6	100C6	1.3595	LH 15	Šch 15	535 A99	100C6
1	5015	14 120	15Cr		12C8	15Cr	SCr 415	15Cr	15Cr	1.7015	15 H	15 H	523M15	
2	Gr.5135	14 140	35Cr		TYPE 2	37C4	SCr435H	37C4	37C4	1.7084	40H	38Cr4	530A36	37C4
3		14 160				55 C 3								
3	Gr.2	14 209	C9SiMn		TYPE 3	100CrM6	SUI3	100CrM6	100CrM6	1.3520	LH15SG	ŠCh15SG	535A99	100CrM6
1	No.5115	14 220	15CrMn		TYPE 5	16MnCr5		16MnCr5	16MnCr5	1.7131	15HG	18CrG	527M17	16MnCr5
1	5120	14 221	20CrMn		Type 7	20MnCr5	SMnCr 420 H	20MnCr5	20MnCr5	1.7147	18HG1	18CrG		F.150 D
1		14 223												
3		14 230												
3		14 231												
3	Gr.1340H	14 240	35Mn2			54SiCr6	SMn438	36Mn5	36Mn5	1.5067	60S2	60S2	250A61	
3	9260	14 260	60Si2CrA				SUP7	54SiCr6	54SiCr6	1.7102	30HGS	30CrGSA		
3		14 331												
3		14 340												
3		14 341												
1	Gr.A	15 020			F26,P26,TS26	15D3	STBA12	15Mo3	15Mo3	1.5415	16M		240	16Mo3
1	Gr.P12	15 121	12CrMo		F32,P32,TS26	15CD4-5	SFAF12	13CrMo4-5	13CrMo4-4	1.7335	15HM	12CrM	620-440	14CrMo45
1		15 124			18CrMo4	18CrMo4	SCM418	18CrMo4	18CrMo4		18HG1	20CrM	708H20	18CrMo4-1
1	Gr.P24	15 128	13MoCrV6		TS33,P33,F33	25CD4	SCM430	14MoV6-3	14MoV6-3	1.7715	13HMf	20CrM	660-460	13MoCrV6
2	4130	15 130	30CrMo		25CrMo4	25CD4	SCM 420	34CrMo4	34CrMo4	1.7220	25 HM	20CrM	708A25	25CrMo4
3	4130	15 131	30CrMo		34CrMo4	25CD4	SCM 420	34CrMo4	34CrMo4	1.7225	26HM	30CrM	708A25	AM 34CrMo4
2	Gr.4140	15 142	42CrMo		TYPE 3	42CD4	SCM440	41CrMo4	41CrMo4		38CrM	38CrM	708M40	42CrMo4
1	Gr.1	15 217	09CrPCrNi-A		Fe 355W-1A	E 36WA3	SPA-H	9CrNiCuP324	9CrNiCuP324	1.8962	10 H	15CrH	WP.50A,B,C	
1	Gr.6118	15 221												
1	Gr.8	15 223												
2		15 230												
3		15 231												
2		15 236	25Cr2MoVA											
2	6135	15 240												



International equivalents / Equivalentes internacionales / Équivalences internationales

	ANSI/SAE	ČSN	BS	EN	ISO	AFNOR	JIS	DIN	D	W-nr	PN	GOST	BS	E
2	G6150	15 241	50CrVA	51CrV4	TYPE 13	51CrV4	SUP 10	42CrV6	1.8159	50HF	50CHFA	735A50	51CrV4	
2	G6150	15 260	50CrVA	51CrV4	TYPE 13	51CrV4	SUP 10	50CrV4	1.8159	50HF	50CHFA	735A50	51CrV4	
3	G6150	15 261	50CrVA	51CrV4	TYPE 13	51CrV4	SUP 10	50CrV4	1.8159	50HF	50CHFA	735A50	51CrV4	
1	G6150	15 313	12CrMo	10CrMo9-10	P34, TS34,F34	10CD9-10	SCM4	24CrMoV5	1.7380	10H2M	20CHMFL	622	12CrMo910	
3	G6150	15 320	12CrMo	10CrMo9-10	P34, TS34,F34	10CD9-10	SCM4	24CrMoV5	1.7380	10H2M	20CHMFL	622	12CrMo910	
1	G6150	15 323	12CrMo	10CrMo9-10	P34, TS34,F34	10CD9-10	SCM4	17CrMoV10	1.7766	30H2MF	30CH3MF	905M39	31CrMoV10	
2	G6150	15 330	12CrMo	10CrMo9-10	P34, TS34,F34	10CD9-10	SCM4	30CrMoV9	1.7707	30H2MF	30CH3MF	905M39	31CrMoV10	
3	G6150	15 340	12CrMo	10CrMo9-10	P34, TS34,F34	10CD9-10	SCM4	41CrAlMo7	1.8509	38HMJ	38CH2MJuA	905M39	41CrAlMo7	
1	G6150	15 412	12CrMo	10CrMo9-10	P34, TS34,F34	10CD9-10	SCM4	42CrMo4	1.7776	38HMJ	38CH2MJuA	905M39	41CrAlMo7	
1	G6150	15 423	12CrMo	10CrMo9-10	P34, TS34,F34	10CD9-10	SCM4	10CrMo11	1.7779	38HMJ	38CH2MJuA	905M39	41CrAlMo7	
1	G6150	16 220	12CrNi2	15NiCr6		16NiCr6	SACM645	20CrMoV1.3.5	1.5713	15HN	12CrNi2	815M17	16NiCr4	
1	G6150	16 222	12CrNi2	15NiCr6		16NiCr6	SACM645	20CrMoV1.3.5	1.5713	15HN	12CrNi2	815M17	16NiCr4	
1	G6150	16 231	12CrNi2	15NiCr6		16NiCr6	SACM645	19CrNi8	1.5710	15HN	12CrNi2	815M17	16NiCr4	
3	G6150	16 240	12CrNi2	15NiCr6		16NiCr6	SACM645	20CrNi8	1.5710	15HN	12CrNi2	815M17	16NiCr4	
1	G6150	16 320	12CrNi2	15NiCr6		16NiCr6	SACM645	36NiCr6	1.5710	15HN	12CrNi2	815M17	16NiCr4	
3	G6150	16 341	12CrNi2	15NiCr6		16NiCr6	SACM645	36NiCr6	1.5710	15HN	12CrNi2	815M17	16NiCr4	
3	G6150	16 342	12CrNi2	15NiCr6		16NiCr6	SACM645	36NiCr6	1.5710	15HN	12CrNi2	815M17	16NiCr4	
3	G6150	16 343	12CrNi2	15NiCr6		16NiCr6	SACM645	36NiCr6	1.5710	15HN	12CrNi2	815M17	16NiCr4	
1	G6150	16 420	12CrNi2	15NiCr6		16NiCr6	SACM645	36NiCr6	1.5710	15HN	12CrNi2	815M17	16NiCr4	
3	G6150	16 431	12CrNi2	15NiCr6		16NiCr6	SACM645	36NiCr6	1.5710	15HN	12CrNi2	815M17	16NiCr4	
3	G6150	16 440	12CrNi2	15NiCr6		16NiCr6	SACM645	36NiCr6	1.5710	15HN	12CrNi2	815M17	16NiCr4	
3	G6150	16 444	12CrNi2	15NiCr6		16NiCr6	SACM645	36NiCr6	1.5710	15HN	12CrNi2	815M17	16NiCr4	
3	G6150	16 532	12CrNi2	15NiCr6		16NiCr6	SACM645	36NiCr6	1.5710	15HN	12CrNi2	815M17	16NiCr4	
3	G6150	16 540	12CrNi2	15NiCr6		16NiCr6	SACM645	36NiCr6	1.5710	15HN	12CrNi2	815M17	16NiCr4	
3	G6150	16 640	12CrNi2	15NiCr6		16NiCr6	SACM645	36NiCr6	1.5710	15HN	12CrNi2	815M17	16NiCr4	
1	G6150	16 720	12CrNi2	15NiCr6		16NiCr6	SACM645	36NiCr6	1.5710	15HN	12CrNi2	815M17	16NiCr4	
1	G6150	19 065	12CrNi2	15NiCr6		16NiCr6	SACM645	36NiCr6	1.5710	15HN	12CrNi2	815M17	16NiCr4	
2	G6150	19 083	12CrNi2	15NiCr6		16NiCr6	SACM645	36NiCr6	1.5710	15HN	12CrNi2	815M17	16NiCr4	
2	G6150	19 103	12CrNi2	15NiCr6		16NiCr6	SACM645	36NiCr6	1.5710	15HN	12CrNi2	815M17	16NiCr4	
2	G6150	19 125	12CrNi2	15NiCr6		16NiCr6	SACM645	36NiCr6	1.5710	15HN	12CrNi2	815M17	16NiCr4	
2	G6150	19 132	12CrNi2	15NiCr6		16NiCr6	SACM645	36NiCr6	1.5710	15HN	12CrNi2	815M17	16NiCr4	
2	G6150	19 133	12CrNi2	15NiCr6		16NiCr6	SACM645	36NiCr6	1.5710	15HN	12CrNi2	815M17	16NiCr4	
2	G6150	19 152	12CrNi2	15NiCr6		16NiCr6	SACM645	36NiCr6	1.5710	15HN	12CrNi2	815M17	16NiCr4	
2	G6150	19 191	12CrNi2	15NiCr6		16NiCr6	SACM645	36NiCr6	1.5710	15HN	12CrNi2	815M17	16NiCr4	
2	G6150	19 192	12CrNi2	15NiCr6		16NiCr6	SACM645	36NiCr6	1.5710	15HN	12CrNi2	815M17	16NiCr4	
3	G6150	19 221	12CrNi2	15NiCr6		16NiCr6	SACM645	36NiCr6	1.5710	15HN	12CrNi2	815M17	16NiCr4	
4	G6150	19 255	12CrNi2	15NiCr6		16NiCr6	SACM645	36NiCr6	1.5710	15HN	12CrNi2	815M17	16NiCr4	
3	G6150	19 312	12CrNi2	15NiCr6		16NiCr6	SACM645	36NiCr6	1.5710	15HN	12CrNi2	815M17	16NiCr4	
3	G6150	19 313	12CrNi2	15NiCr6		16NiCr6	SACM645	36NiCr6	1.5710	15HN	12CrNi2	815M17	16NiCr4	
3	G6150	19 313	12CrNi2	15NiCr6		16NiCr6	SACM645	36NiCr6	1.5710	15HN	12CrNi2	815M17	16NiCr4	
3	G6150	19 340	12CrNi2	15NiCr6		16NiCr6	SACM645	36NiCr6	1.5710	15HN	12CrNi2	815M17	16NiCr4	
3	G6150	19 356	12CrNi2	15NiCr6		16NiCr6	SACM645	36NiCr6	1.5710	15HN	12CrNi2	815M17	16NiCr4	
3	G6150	19 418	12CrNi2	15NiCr6		16NiCr6	SACM645	36NiCr6	1.5710	15HN	12CrNi2	815M17	16NiCr4	
3	G6150	19 419	12CrNi2	15NiCr6		16NiCr6	SACM645	36NiCr6	1.5710	15HN	12CrNi2	815M17	16NiCr4	
4	G6150	19 420	12CrNi2	15NiCr6		16NiCr6	SACM645	36NiCr6	1.5710	15HN	12CrNi2	815M17	16NiCr4	
3	G6150	19 421	12CrNi2	15NiCr6		16NiCr6	SACM645	36NiCr6	1.5710	15HN	12CrNi2	815M17	16NiCr4	
3	G6150	19 422	12CrNi2	15NiCr6		16NiCr6	SACM645	36NiCr6	1.5710	15HN	12CrNi2	815M17	16NiCr4	
2	G6150	19 423	12CrNi2	15NiCr6		16NiCr6	SACM645	36NiCr6	1.5710	15HN	12CrNi2	815M17	16NiCr4	
2	G6150	19 426	12CrNi2	15NiCr6		16NiCr6	SACM645	36NiCr6	1.5710	15HN	12CrNi2	815M17	16NiCr4	
3	G6150	19 434	12CrNi2	15NiCr6		16NiCr6	SACM645	36NiCr6	1.5710	15HN	12CrNi2	815M17	16NiCr4	
3	G6150	19 435	12CrNi2	15NiCr6		16NiCr6	SACM645	36NiCr6	1.5710	15HN	12CrNi2	815M17	16NiCr4	
4	G6150	19 436	12CrNi2	15NiCr6		16NiCr6	SACM645	36NiCr6	1.5710	15HN	12CrNi2	815M17	16NiCr4	
4	G6150	19 437	12CrNi2	15NiCr6		16NiCr6	SACM645	36NiCr6	1.5710	15HN	12CrNi2	815M17	16NiCr4	

International equivalents / Equivalences internationales / Equivalences internacionales

ISO 513	USA	CZ	GB	EU	ISO	F	JIS	D	DIN	W-nr	PL	RUS	GB	E
3		19 452			ISO	ARNOR	JIS	D	D	W-nr	PN	GOST		
1		19 487				Y60S7			585C8	1.2103				
4		19 512				45CDV6			21MnC5	1.2162				
4		19 520				40CMinMo8			48CGMoV67					
2		19 541				35CMo7			40CMinMo7					
3		19 552				30CMoV12-11	SKD7		40CMinMo7					
3		19 553				32CDV12-28	SKD6		X32CMoV33	1.2365				
3		19 554				X37CMoV5-1	SKD6		X38CMoV5.1	1.2343				
3		19 561				X37CMoV5-1	SKD6		X38CMoV5.1	1.2343				
3		19 571				X37CMoV5-1	SKF61		X38CMoV5.1	1.2343				
3		19 572				X40CMoV5.1	SKD 12		X40CMoV5.1	1.2344				
4		19 581				X100CMoV5	SKD 11		X100CMoV 5.1					
3		19 614				Z160CDV12			x165RmOv.12					
3		19 642												
3		19 655												
3		19 662												
3		19 663												
4		19 675												
4		19 680												
3		19 710												
3		19 711												
3		19 712												
3		19 714												
2		19 720												
3		19 721												
3		19 723												
3		19 732												
3		19 733												
3		19 740												
3		19 802												
4		19 810												
3		19 824												
4		19 830												
4		19 852												
4		19 855												
4		19 856												
4		19 858												
4		19 861												
1		422680												
1		422683												
1		422640												
1		422643												
1		422650												
2		422653												
2		422660												
2		422670												
2		422709												
1		422712												
1		422713												
1		422714												
3		422715												
3		422719												
3		422724												

International equivalents / Equivalentes internacionales / Équivalences internationales														
ISO 513	USA	CZ	PRC	EU	ISO	F	J	D	D	W-nr	PL	RUS	GB	E
	ANSI/SAE	ČSN	GB	EN	ISO	AFNOR	JIS	DIN	DIN	W-nr	PN	GOST	BS	
3		422726						GS 24 CV42			L35HG5	35CHGSL		
1	422733													
1	Gr16C6	422744		GS-17CrMo55	5CPH 21	15CD5-05M	SCPH 21	GS-17CrMo55			L18HM	20CHMFL	621	AM-18CrMo05-05
1	Gr9	422745		G17CrMoV511	5CPH23	15CDV4-10M	5CPH23	GS-17CrMo511			L15HMF			
3		422750										40 CHNL		
1	C 5	422771				Z15CD 505-M	5CPH 61					20CH5ML	625	AM-18CrMo5
4		422992										R9		

International equivalents / Equivalentes internacionales / Équivalences internationales														
ISO 513	USA	CZ	PRC	EU	ISO	F	J	D	D	W-nr	PL	RUS	GB	E
	ANSI/SAE	ČSN	GB	EN	ISO	AFNOR	JIS	DIN	DIN	W-nr	PN	GOST	BS	
1	Type 403	17 020	0Cr13	X6Cr13	TYPE 1	APROR	SUS410S	X7Cr14		14000	0H13	08CH13	403S17	X6Cr13
1	Type 410	17 021	1Cr12	X10Cr13	Type3	Z12C13	SUS 410	X10Cr13		14006	1H13	12CH13	410S2	X12Cr13
2	Type 420	17 022	2Cr13	X20Cr13	Type 4	X20Cr13	SUS42011	X20Cr13		14021	2H13	12CH13	420S37	X20Cr13
2	Type 420	17 023	3Cr13	X30Cr13	Type 5	Z30Cr13	SUS4202	X30Cr13		14028	3H13	30CH13	420S45	Z304-03
2	Type 420	17 024	4Cr13	X39Cr13	Type 6	Z40Cr13		X39Cr13		14081	4H13	40CH13	X39Cr13	X39Cr13
2		17 029								14084				
1	Type 430	17 040	1Cr15	X6Cr17	Type 8	Z8Cr17	SUS 430	X6Cr17		14016	H17	12CH17	430S18	X6Cr17
1	Type 430	17 041	1Cr15	X8Cr17	Type 8	Z8Cr17	SUS430	X6Cr17		14016	H17	12CH17	430S15	X6Cr17
2	440 C	17 042												
1	Type 501, 502	17 102	10MoCr50	5CrMo16	TS 37	Z10Cr5-05	5PVA8 5 A B	12CrMo19 5		17362	H5M	15CH5M	625	F2408
1		17 113		X10CrAl57	TYPE 1	Z8Cr47	SUH 1	X10CrAl57		14713	H18	15CH6Su	401S45	X10CrAl7
2	HW3	17 115	4Cr9S2	X 45Cr58	TS38	Z 45Cr59	SUH 1	X 45Cr59 3		14718	H9S2	40CH9S2	629-470	F3220
2	GrF9	17 116			TYPE H3		SFVAF9	X12CrMo9-1						
2	TYPE 405	17 125	0Cr13Al	X10CrAl13	TS40	Z 13Cr13		X10CrAl13		14724	H13S	10CH13Su		F3152
2		17 134				Z21CrV12		X20CrMoV121			23H11MNF			
2	446	17 153	1Cr25Ti		TYPE11	Z10Cr24	SUH446	X8CrTi25				15CH25T		
3	Type 304	17 240	0Cr18Ni9	X5CrNi18-10		Z10Cr24	SUS304	X5CrNi18-10		14301	0H18N9	08CH18Ni10	304S31	X5CrNi18-10
3	302	17 241					SUS 302	X12CrNi 18 8		14300	1H18N9			
3	Gr-302	17 242						X12CrNi188			1H18N9	17CH18N9	302S25	
3	321	17 246	1Cr18Ni9Ti	X10CrNiTi18-10	TYPE 15	Z6CrNiTi18-10	SUS321	X12CrNiTi189		14878	1H18N9T	08CH18Ni10T	302S25	X6CrNiTi18-10
3	Type 321	17 247	0Cr18Ni10Ti	X 6CrNiTi 18-10	TYPE 15	Z 6CrNiTi 18-10	SUS 321	X 6CrNiTi 18 10		14541	0H18N10T	08CH18Ni10T	321S12	F3523
3	Type 321	17 248	0Cr18Ni10Ti	X6CrNiTi18-10	TYPE 15	Z6CrNiTi18-10	SUS321	X6CrNiTi1810		14541	0H18N10T	08CH18Ni10T	321S31	X6CrNiTi18-10
3	304L	17 249	00Cr19Ni10	X2CrNi19-10	TYPE 15	Z3CrNi 18-11	SUS 304	X2CrNi 19 11		14306	0H18N11	08CH18Ni11	304S11	X2CrNi18-10
3	TYPE 309	17 251	1Cr20Ni14Si2	X 15CrNiSi20 12	TYPE H13	Z 17CrNiSi 20 12	SUH 309	X 15CrNiSi 20 12		14828	H20Ni12S2	20Cr20Ni14S2	309S24	F3312
3	330	17 253	1Cr16Ni5	X12NiCrSi5-16	H17	Z12NiCrSi7-18	SUH330	X12NiCrSi5-16			H6Ni36S2			X12NiCrSi5-16
4		17 254										12CH21Ni5T		
3	310S	17 255	1Cr25Ni20Si2	X8CrNi25-21	H16	Z8CrNi25-20	SUS310S	X8CrNi25-21		14845	H2Ni20S2	20Cr23Ni18	310S31	X15CrNiSi25-20
3	Ev9	17 322										4Cr14Ni14W2Mo	331S42	
3		17 335										CHN35-VT		
3	TP316H	17 341			TS 63	Z6CrNiD17-13B	SUS 316	X6CrNiMo1713		14919			316S51	X5CrNiMo17122
3	TYPE 316	17 346	0Cr17Ni12Mo2	X5CrNiMo 17 12 2	TYPE 20	Z 6CrNiD 17 11	SUS 316	X 5CrNiMo 17 12 2		14401			316S31	X5CrNiMo 17 12 2
3		17 347												
3	316Ti	17 348	0Cr18Ni12Mo2Ti	X6CrNiMoTi17-12-2	21	Z6CrNiD17-12	SUS316Ti	X6CrNiMoTi17-12-2			H17Ni3Mo2Ti	10CH17Ni3Mo2Ti	321S12	X6CrNiMoTi17122
3	316L	17 349	00Cr17Ni14Mo2	X2CrNiMo 17 12 2	TYPE 19	Z3CrNiD 18-12-02	SUS 316	X2CrNiMo 17 13 2		14404	00H17Ni4Mo2	03CH17Ni4Mo2	316S11	X2CrNiMo 17 13 2
3	TP316L	17 350	00Cr17Ni14Mo2	X2CrNiMo15-14-3	TYPE 19a	Z3CrNiD 17-12-03	SUS 316L	X2CrNiMo15-14-3		14435		03CH17Ni4Mo2	316S14	X2CrNiMo15-14-3
4	TYPE 635	17 351			TYPE 7									

International equivalents / Equivalences internationales / Equivalencias internacionales

ISO 513	USA	CZ	GB	EU	EN	ISO	FR	JIS	DIN	D	W-nr	PL	RUS	GB	E
	ANSI/SAE	ČSN	GB	EN	EN	ISO	ARND	JIS	DIN	D	W-nr	PN	GOST	BS	E
4	TYPE 635	17 351.9				TYPE 7	Z7CND 18-12-3	SUS 316	X5CrNiMo 17 13 3		1.4386	H17N13M2T	08Ch17N13M2T	316S31	X5CrNiMo 17 13 3
3	316	17 352	0Cr17Ni12Mo2	X3CrNiMo 17-13-3		Type 20a		316Ti	X10CrNiMoTi18-12		1.3817			320633	
3	316Ti	17 356	1Cr18Ni12Mo3Ti						X40MnCr18		1.3965				
3	17 436	17 436							X53CrMnNiN21.9		1.4871				
3	Gr.202	17 460				Type 9	Z 52 CMN 21.09	SUH 35	Ni36		1.3912				F.3217
4	EV 12	17 465							X120Mn12		1.3401				
3	NILO 36	17 536							G8CrNi13		1.4008				
4	17 618.4	17 618.4							G-X12Cr13		1.4027				
1	GrCA-15	422904	ZG1Cr13				Z120M12	SCS1	G8CrNi13						
1	GrCA-15	422905	ZG1Cr13				Z6CrNi12-1M	SCS 1	G-X12Cr13						
2	GrCA-40	422906	Z G2Cr13				Z12Cr13-M	SCS 2	G-X20Cr14						
2	GrCB30	422911	ZG1Cr17				Z20CrNi17-2	SCS 2	G-X22CrNi17						
2		422912							G-X40CrSi17						
2	GrHC	422913					Z40Cr28 M	SCH 2	G-X40CrSi23						
2	GrHC	422914					Z40Cr28-M	SCH 2	G-X70Cr29						
2	GrCA28MnV	422916	Z GCr28						G-X22CrMoV12-1		1.4922				
2		422917							G8CrNi12						
2	B-1 ex 4	422920	ZG Mn13-1-4				Z6CrNi12-1M	SCMnHt a3	G-X120Mn13		1.3802				AM-X120Mn12
4	GrC	422921					Z120M12M	SCMnH11	G-X120Mn13						
4	GrC	422921					Z120M12-M	SCS 12	G-X10CrNi 18 8						
3	CF-16F	422931	ZG1Cr18Ni9				Z6CrNi 18-10M	SCS 12	G-X25CrNiSi 18 9		1.4312				
3	CF 20	422932					Z 25CrNi 20-10 M	SCS 12	G-X25CrNiSi 18 9		1.4825				
3	CF-8C	422933					Z6CrNiNb18-10-M	SCS21	G-X7CrNiNiNb189		1.4826				
3	HF	422934					Z6CrNiNb18-10-M	SCH 12	G-X40CrNiSi 22 9		1.4826				
3	HF	422934					Z40CrNi 25-12 M	SCH 13A	G-X40CrNiSi 25 12		1.4837				
2	HH	422936													
2	HH	422938					Z40CrNi 25-12 M	SCH 13A							
3	CF 3 MIN	422941					Z 6CrNiNb 18 12-M	SCS 22	G-X10CrNiMo 18 9		1.4410				
3	CF-8M	422942					Z6CrNi 18-12 M	SCS 14	G-X10CrNiMo 18 9						
3	HE	422944						SCH 17							
3	HK	422952					Z40CrNi 25-20 M	SCH 22	G-X40CrNiSi 25 20		1.4848				
3	HK	422953													
3	HU	422955						SCH 20	G-X40CrNiSi 25 20						
3	CN-7M	422958					Z 6NCrDV 25-20-04 M	SCS 15	G-X40CrNiSi 25 20						
3								SCS 15	G-X7CrNiMoCuNb 18 18						

International equivalents / Equivalentes internacionales / Équivalences internationales

	USA	CZ	GB	EU	ISO	F	JIS	DIN	D	W-nr	PL	RUS	GB	E
	ANSI/SAE	ČSN	BS	EN	ISO	AFNOR	JIS	DIN	D	W-nr	PN	GOST	BS	EN
3	Gr.60-40-18	422303			400-12	FGS 370-71	FCD 370	GGG-35.3			Zs 35022	VC 38-17	Gr.350/22	Gr.38-17
3	65-45-12	422304			500-7	FGS400-12	FCD40	GGG40		Zs40015	Zs40015	VC40	Gr.420-12	Gr.42-12
3	Gr.80-55-06	422305		GIS 500-7	500-7	FGS 500-7	FCD 500	GGG-50		Zs 50007	Zs 50007	VC 50-2	500/7	Gr.50-7
4	100-70-03	422306			600-3	FGS600-3	FCD 600	GGG60		Zs60003	Zs60003	VC60	Gr.600/3	Gr.60-3
4	Gr.120-90-02	422307		GIS 700-2	700-2	FGS 700-2	FCD 700	GGG-70		Zs70002	Zs70002	VC 70-3	Gr.700/2	Gr.70-2
4	Class 208	422308			800-2	FGS800-2	FCD 800	GGG80		Zs80002	Zs80002	VC80	Gr.800/2	Gr.80-2
1	CL258	422410			Gr.100	Ft10	FC-100	GG10		Zl100	Zl100	SC10		FG10
1	Class 308	422415			Gr.200	FGL 150	FC-150	GG-15		Zl150	Zl150	SC 15	Gr.150	FG 15
1	CL358	422420		FG20		F20	FC-20	GG20		Zl200	Zl200	SC20	Gr.220	FG20
1	No. 45	422425			Gr.300	FGL 250	FC250	GG-25		Zl 250	Zl 250	SC 25		FG 26
1	Class508	422480				Ft 30	FC-300	GG-30		Zl 300	Zl 300	SC 30	Gr. 300	FG 30
1	Type D, CL.III	422485				F35	FC35	GG35		Zl350	Zl350	SC35	Gr.350	FGG35
1		422465				F80				Zl85	Zl85	AC5-15	1C	
1		422472								Zl85	Zl85	ŽČS5		
1		422481								ZlA7Cr	ZlA7Cr	ŽČu70h2		
2	Gr.32510	422532			B-35-10	MIN 32-8	FCMB 310	GTS35-10		Zcc 32000	Zcc 32000	KČ 33-8	B 310/10	Type B
2		422533			W35-04	MIN35-10	FCMB35			Zcc35010	Zcc35010	KČ35-10	B35-12	Type A
2		422534			W35-04	MB35-7	FCMN34			Zcb 35004	Zcb 35004		W35-04	Type B
2		422536			W 40-05	MB 400-5	FCMW 370			Zcb 40005	Zcb 40005		W 40-05	42 2540
2	Gr.45006	422540			P45-06	MIN 450-6	FCMP 440	GTS45-06		Zcp 45006	Zcp 45006		P45-06	Type E
2	6004	422545			P55-04	MIN 550-4	FCMP 540	GTS 55-04		Zcp55004	Zcp55004		P55-04	Type C
2		422555												

International equivalents / Equivalences internationales / Equivalencias internacionales

USA	CZ	GB	EN	EU	ISO	F	J	D	D	W-nr	PL	RUS	GB	E
ANSI/SAE	ČSN	BS	EN	EU	ISO	ARNOR	JIS	DIN	DIN	W-nr	PN	GOST	BS	E
4 C110000	423001		Cu-ETP	Cu-ETP	Cu-ETP	Cu-a1	C1100	E2-Cu58	Cu	Cu99,9E	Cu99,9E	Cu99,9	C101	
4 C110000	423001		Cu-ETP	Cu-ETP	Cu-ETP	Cu-a1	C1100	E2-Cu58	Cu	Cu99,9E	Cu99,9E	Cu99,9	C101	
4 C110000	423001		Cu-ETP	Cu-ETP	Cu-ETP	Cu-a1	C1100	E2-Cu58	Cu	Cu99,9E	Cu99,9E	Cu99,9	C101	
4 C110000	423001		Cu-ETP	Cu-ETP	Cu-ETP	Cu-a1	C1100	E2-Cu58	Cu	Cu99,9E	Cu99,9E	Cu99,9	C101	
4 C110000	423001		Cu-ETP	Cu-ETP	Cu-ETP	Cu-a1	C1100	E2-Cu58	Cu	Cu99,9E	Cu99,9E	Cu99,9	C101	
4 C110000	423001		Cu-ETP	Cu-ETP	Cu-ETP	Cu-a1	C1100	E2-Cu58	Cu	Cu99,9E	Cu99,9E	Cu99,9	C101	
4 C14200	423004					Cu-a1	C1821	C-Cu	Cu	Cu99,7G	Cu99,7G	M2		
4 C51900	423016		Cu58	Cu58	Cu58	Cu58Pp	C5191	Cu58	Cu	Cu99,56	Cu99,56	M3		
4 C52100	423018		Cu58	Cu58	Cu58	Cu58Pp	C5212	Cu58	Cu	BrOF6,5-0,15	BrOF6,5-0,15	BrOF6,5-0,15	PB102	
4 C60800	423042		CuAl5As	CuAl5As	CuAl5	CuAl6	C5212	CuAl5As	Cu	BrOF0,2	BrOF0,2	BrOF0,2	PB104	
4 C61900	423045				CuAl9Mn2			CuAl9Mn2	Cu	BrAS	BrAS	BrAS	CuAl5As	
4 C63000	423047		CuAl10Fe3Mn2	CuAl10Fe3	CuAl10Mn5Fe4	CuAl19N5Fe3	C6301	CuAl10Fe3Mn2	Cu	BrAMcB-2	BrAMcB-2	BrAMcB-2	CuAl9Mn2	
4 C65500	423053		Cu59Mn1	Cu63Mn1	Cu63Mn1	CuAl19N5Fe3		CuAl10Fe3Mn2	Cu	BrAZ9-4	BrAZ9-4	BrAZ9-4	CuAl10Fe3Mn2	
4 C16200	423058				CuCd1			CuAl10N15Fe4	Cu	BrZMc10-3-1,5	BrZMc10-3-1,5	BrZMc10-3-1,5	CuAl10Fe5Ni5	
3 C90700	423115		Cu58	Cu58	Cu58	Cu58		Cu58	Cu	BrAZN10-4-4	BrAZN10-4-4	BrAZN10-4-4	CA104	
3 C93700	423122		Cu58	Cu58	Cu58	Cu58		Cu58	Cu	BrKw3-1	BrKw3-1	BrKw3-1	Cu59Mn1	
4 C91700	423123		Cu58	Cu58	Cu58	Cu58		Cu58	Cu	BrKd1	BrKd1	BrKd1	Cu58	
4 C91700	423123		Cu58	Cu58	Cu58	Cu58		Cu58	Cu	BrAZN10-4-4	BrAZN10-4-4	BrAZN10-4-4	CuAl10Fe5Ni5	
3 C83600	423135		Cu58	Cu58	Cu58	Cu58		Cu58	Cu	BrAZN10-4-4	BrAZN10-4-4	BrAZN10-4-4	CuAl10Fe5Ni5	
3 C83600	423135		Cu58	Cu58	Cu58	Cu58		Cu58	Cu	BrAZN10-4-4	BrAZN10-4-4	BrAZN10-4-4	CuAl10Fe5Ni5	
3 C90500	423138		Cu58	Cu58	Cu58	Cu58		Cu58	Cu	BrAZN10-4-4	BrAZN10-4-4	BrAZN10-4-4	CuAl10Fe5Ni5	
4 C92144	423144		Cu58	Cu58	Cu58	Cu58		Cu58	Cu	BrAZN10-4-4	BrAZN10-4-4	BrAZN10-4-4	CuAl10Fe5Ni5	
4 C95200	423145		Cu58	Cu58	Cu58	Cu58		Cu58	Cu	BrAZN10-4-4	BrAZN10-4-4	BrAZN10-4-4	CuAl10Fe5Ni5	
4 C95200	423145		Cu58	Cu58	Cu58	Cu58		Cu58	Cu	BrAZN10-4-4	BrAZN10-4-4	BrAZN10-4-4	CuAl10Fe5Ni5	
4 C95500	423147		Cu58	Cu58	Cu58	Cu58		Cu58	Cu	BrAZN10-4-4	BrAZN10-4-4	BrAZN10-4-4	CuAl10Fe5Ni5	
4 C95500	423147		Cu58	Cu58	Cu58	Cu58		Cu58	Cu	BrAZN10-4-4	BrAZN10-4-4	BrAZN10-4-4	CuAl10Fe5Ni5	
3 C95500	423183		Cu58	Cu58	Cu58	Cu58		Cu58	Cu	BrAZN10-4-4	BrAZN10-4-4	BrAZN10-4-4	CuAl10Fe5Ni5	
3 C95500	423184		Cu58	Cu58	Cu58	Cu58		Cu58	Cu	BrAZN10-4-4	BrAZN10-4-4	BrAZN10-4-4	CuAl10Fe5Ni5	
3 C22000	423201		Cu58	Cu58	Cu58	Cu58		Cu58	Cu	BrAZN10-4-4	BrAZN10-4-4	BrAZN10-4-4	CuAl10Fe5Ni5	
3 C23000	423202		Cu58	Cu58	Cu58	Cu58		Cu58	Cu	BrAZN10-4-4	BrAZN10-4-4	BrAZN10-4-4	CuAl10Fe5Ni5	
3 C24000	423203		Cu58	Cu58	Cu58	Cu58		Cu58	Cu	BrAZN10-4-4	BrAZN10-4-4	BrAZN10-4-4	CuAl10Fe5Ni5	
3 C26000	423210		Cu58	Cu58	Cu58	Cu58		Cu58	Cu	BrAZN10-4-4	BrAZN10-4-4	BrAZN10-4-4	CuAl10Fe5Ni5	
4	423212		Cu58	Cu58	Cu58	Cu58		Cu58	Cu	BrAZN10-4-4	BrAZN10-4-4	BrAZN10-4-4	CuAl10Fe5Ni5	



International equivalents / Equivalences internationales / Equivalences internacionales

USA	CZ	GB	EU	EN	ISO	F	JIS	D	D	W-nr	PL	RUS	GB	E
AMS/SAE	ČSN	BS	EN	EN	ISO	AFNOR	JIS	DIN	DIN	W-nr	PN	GOST	BS	E
904 L UNS/0890A	Uranus B6					ZZNC0U25-20		X1NiCrMoCu25 20 5	X1NiCrMoCu25 20 5	1.4539				
660	ZBNCTV25-15BFF	EZ 6 NCTDV 25.15				EZ 6 NCTDV 25.15		X5NiCrTi 2615	X5NiCrTi 2615	1.4980				
B 163	Incoloy 800 HT	Z10NC32-21				Z10NC32-21		X10NiCrAlTi3221	X10NiCrAlTi3221	1.4876				
N 08330	G-X40NiCrSi38 18						SCH15	G-X40NiCrSi38 18	G-X40NiCrSi38 18	1.487			330C11	
330	X5NiCrAlTi 31 20	Z12NCS35-16				Z12NCS35-16	SUH330	X12NiCrSi 36 16	X12NiCrSi 36 16	1.4864				
N 08800	X2NiCrAlTi 32 20							X2NiCrAlTi 32 20	X2NiCrAlTi 32 20	1.456				
N 08831	X1NiCrMoCu 32 28 7	Z1NC0U31-27-03				Z1NC0U31-27-03		X1NiCrMoCu 32 28 7	X1NiCrMoCu 32 28 7	1.456				
N08028	X1NiCrMoCuNi 31.27.4							X1NiCrMoCuNi 31.27.4	X1NiCrMoCuNi 31.27.4	1.4563				
AMS 5732 - 5737	A-286							X 5 Ni Cr Ti 25 15	X 5 Ni Cr Ti 25 15	1.498				
	X40CoCrNi20 20	Z4ZCNK0Wnb				Z4ZCNK0Wnb		X40CoCrNi20 20	X40CoCrNi20 20		NiCu30	NM2M28-2,5-1,5		
	Ni70Cu30	NiCu32Fe1,5Mn			NiCu30	NiCu32Fe1,5Mn		NiCu30Fe	NiCu30Fe					
	NiFe17CuCr							NiFe16CuCr	NiFe16CuCr					
	NiFe48							NiFe47	NiFe47					
ALLOY 59	NiCr21Mo16Al													
INCONEL alloy 686	NiCr21Mo16W													
NIMONIC alloy 90 (HEV6)	NiCrCo18Ti													
NIMONIC alloy 105	NiCo20Cr15MoAlTi													
UNS N10276	NiMoCr15W	NiMo16Cr16				NiMo16Cr16								
	NiMoCr15W	NC22DNb				NC22DNb								
MAR-M509	CoCr23Ni10W7Ti4													
	Hastelloy C-4													
AMS 5754	Hastelloy X	NC22FeD				NC22FeD				2.461				
AMS 5396	Hastelloy B	ND37FeV				ND37FeV				2.4603				
AMS 5750	Hastelloy C & C 276	ND16Cr15				ND16Cr15				2.4800				
	Nimonic C 263									2.481				
	Nimonic 90									2.4650				
AMS 5754 E	Nimonic PE 13									2.4632				
	Nimonic 115									2.4665				
	Nimonic 263/C263									2.4636				
	Nimonic 105									2.4650				
	Nimonic PK33									2.4634				
UNS N07080	Nimonic 80A_	NC20ATV				NC20ATV				2.4631				
AMS 5661 A	Nimonic 901	NC20TA				NC20TA				2.4662				
AMS 5753	Nimonic PK 25	NK0D20ATU				NK0D20ATU				2.4666				
	Nimonic PE 16	NW11AC				NW11AC								
	Nimonic 75	NC20T				NC20T				2.4630				
SAE 5391 A	Nimocast 842	NC13AD				NC13AD				2.4670				
AMS 5665	Inconel 600	NC15Fe				NC15Fe				2.4816				
AMS 5715	Inconel 601									2.4851				
N06617	Inconel 617													
5666	Inconel 625													
	Inconel 690	NC22Fe0Nb				NC22Fe0Nb				2.4856				
AMS 5702	Inconel 706	NC 30 Fe				NC 30 Fe				2.464				
AMS 5391	Inconel 713	38Cr16NbT				38Cr16NbT								
AMS 5589	Inconel 718	NC12AD				NC12AD								
AMS5541	Inconel 722	NC19FeNb				NC19FeNb								
AMS 5667	Inconel X-750	NC16FeTi				NC16FeTi								
AMS 5582	Inconel X-750	NC15FeTiNbA				NC15FeTiNbA								
	Inconel 751	NC16FeTiNb				NC16FeTiNb				2.4669				
	Incoloy 825									2.469				
AMS 5660	Incoloy 901	NC21FeDU				NC21FeDU				2.4858				
AMS 5399	René 41	ZSNCDT42				ZSNCDT42				2.4662				
		NC19NDT				NC19NDT				2.4973				



International equivalents / Equivalentes internacionales / Équivalences internationales

ISO 513	USA	CZ	GB	EU	EN	ISO	F	J	D	D	W-nr	PL	RUS	GB	E
	ABIS/SAE	ČSN	BS	EN	EN	ISO	AFNOR	JIS	DIN	DIN	W-nr	PN	GOST	BS	E
3	René 95						NC14K8		NC14K8						
3	Monel 400						NU30		NCu30Fe		2.4360				
3	Monel K-500						NU30AT		NCu30Al		2.438			NA.18	
3	AMIS 5751						NCK19DAT		NCr18Co18MoTi		2.4983				
3	Udimet 500						NCK18TDA								
3	Udimet 710						NCK20AT		NiCo15Cr16AlTi		2.4636				
3	Udimet 700						NC19PeN		NCr19Fe19NiMo		UW2.4668				
3	Udimet 718						NC18K15TDA								
3	Udimet 720						NC20K14		NCr19Fe19NiMo		UW2.4668				
3	Waspaloy						KC20WN				UW2.4964				
4	AMIS 5544						KC20WN								
4	AMIS 5759						KC22WN		CoCr20W15Ni						
4	AMIS 5772						KC20WN		CoCr22W14Ni						
4	AMIS 5772						KC22WN		Ti.1Pd		3.723			TP 1	
4	5637C						KC20WN		TiAl3V2.5		3.720			TA11	
4	AMIS 5772						KC22WN		TiAl6V4EU		3.7115			TA14/17	
1	R 52250								TiAl5Sn2.5		3.712				
1	AMS R56401						T-A5E		TiAl5Sn2		3.715				
1	AMS R54520								TiAl6Sn2Zr4Mo2Si		3.715				
1	R 54620						T-A6V		TiAl6V4		3.7165			TA10-13/TA28	
1	AMS R56400								TiAl6V5Sn2		3.718				
1							T-A4DE		TiAl4Mo4Sn2Si0.5		3.719			TA 45-51/TA 57	
1															

International equivalents / Equivalentes internacionales / Équivalences internationales

ISO 513	USA	CZ	GB	EU	EN	ISO	F	J	D	D	W-nr	PL	RUS	GB	E
	ABIS/SAE	ČSN	BS	EN	EN	ISO	AFNOR	JIS	DIN	DIN	W-nr	PN	GOST	BS	E
4	Gr.1010.1011.M1010	12.010.4	10	2C10	2C10	C10	XCr10	S9CK	C10	C10	1.1121	10	08	045A10	C10K
4	Gr.1016	12.020.4	15	C15E	C15E	C15E	XCr15	S15C	C15	C15	1.1141	15	15	080M15	C16K
4	Gr.1015	12.023.4	15	C15E	C15E	C15E	XCr15	S15C	C15	C15	1.1141	15	15	040A15	
4	1020	12.024.4	20	C 22	C 22	C 22	XCr18	S 22C	C 22	C 22	1.0402	20	20	070M20	
4	Gr.1070	12.071.4		1.0S67	1.0S67		C 68	S70C-CSP	Cr 67	Cr 67		20	65	080A67	
4	52100	14.100.4		100Cr6	100Cr6	Type 1-0	100C6	SUJ 2	100Cr6	100Cr6		LH 15	Šh15	534A99	F.1311
4	52100	14.109.4		100Cr6	100Cr6	Type 1-0	100C6	SUJ 2	100Cr6	100Cr6		LH 15	Šh15	535A99	100C6
4	5015	14.120.4		15Cr	15Cr	37Cr4	12Cr	Scr 415	15Cr3	15Cr3		15 H	15Ch	523M15	
4	Gr2	14.209.4		C95Mn	100CrMn6	TYPE 3	100CrM6	SUJ3	100CrMn6	100CrMn6		LH15SG	ŠCh15SG	535A99	100CrMn6
4	No.5115	14.220.4		16MnCr5	16MnCr5	TYPE 5	16MnCr5	SUJ3	16MnCr5	16MnCr5		15HG	18ChG	527M17	16MnCr5
4	5120	14.221.4		20MnCr5	20MnCr5	TYPE 7	20MnCr5	SMinCr 420 H	20MnCr5	20MnCr5		18HGT	18ChG		F.150.D
4		14.223.4											18ChGT		
4		14.231.4											30ChGT		
4	9260	14.260					54SiCr6	SUP7	54SiCr6	54SiCr6		60S2	60S2ChA	250A61	
4	Cr.A	15.340.4		40CrAD.6.12	40CrAD.6.12	SACM645	41CrAlNi67	SACM645	41CrAlNi67	41CrAlNi67		38HMJ	38Ch2NiJ4A	905M39	41CrAlNi67
4	Gr4320	16.220.4		16NiCr6	16NiCr6	16NiCr6	16NiCr6	SACM645	15CrNi6	15CrNi6		15HN	12CrNi2	815M17	16NiCr6
4	3120	16.231.4		20NiCr6	20NiCr6	20NiCr6	20NiCr6	19CrNi8	19CrNi8	19CrNi8		19CrNi8	20Cr2Ni4A	822M17	
4	E3310X	16.420.4		13NiCr14	13NiCr14	13NiCr14	13NiCr14	SNC815	14NiCr14	14NiCr14		14NiCr14	12Cr2Ni4A	655H13	
4		16.420.4											30HGSNA		
4		16.532.4											18Ch2Ni4A		
4		16.720.4											18Ch2Ni4A		
4		16.720.4											18Ch2Ni4A		
3	Type 420	17.023.4		X30Cr13	X30Cr13	Type 5	Z30Cr13	SUS420J2	X30Cr13	X30Cr13		3H13	30Ch13	420645	2304-03
3	Type 420	17.024.4		X39Cr13	X39Cr13	Type 6	Z40Cr13	SUS420J2	X39Cr13	X39Cr13		4H13	40Ch13	X39Cr13	X39Cr13

International equivalents / Equivalences internationales / Equivalences internationales

	ANSI/SAE	ČSN	GB	EN	ISO	ARNDOR	JIS	DIN	DIN	W-nr	PN	GOST	BS	E	
3		17 029.4								1.4034	H18	95Ch18			
4	440 C	17 042.4				Y342		C45W3		1.1730				F5131	
4		19 083.4				Y355	SK7	G60W3		1.1740	N5				
4		19 103.4				Y3 65	SK 7	G67W		1.1744	N6				
4		19 125.9				C70 E2U	SK 6	C70 W2		1.1620	N7	U7-1		F5103	
4	W 1-7	19 132.4	T7	CT70	C70 U	Y170	SK6	C70W		1.1620	N7	U7		C70U	
4		19 133.4	T7	CT70	C70 U	Y180	SK5	C80W2		1.1625	N8	U8-1	BW1A	C80U	
4	W1GrA	19 152.4	T8	CT80	C80 U	C105E2U	SK5	C105W1		1.1645	N10E	U101	BW1B	C102U	
4	W5	19 191.4	T10A	CT105	C105 U	C 105 E2U	SK 3	C 105 W2		1.1654	N10	U 10-1		F5117	
4	W110	19 192.4	T10	CT 105	C 90 U	Y2120	SK 2	C110W2		1.1663	N12	U12-1	BW1C	F5123	
4		19 221.4	T11	CT 120	TC 120	C120 E3U	SK 2	C125 W		1.1663	N12	U 13-1		C120 U	
4	W112	19 255.4		CT 120	TC 120	C120 E3U	SK 2	C125 W		1.1663	N12	U 13-1		C120 U	
4	O2	19 312.4		90MnV8	90MnCrV8	90MnV8		90MnCrV8		1.2842	NMV	9G2V	B02	90MnCrV8	
4	O2	19 313.4		90MnV8	90MnCrV8	90MnV8		90MnCrV8		1.2842	NMV	9G2V	B02	90MnCrV8	
4		19 340.4		60SiMn7	60SiMn7	60Si8		70S7			NMV	9G2V	B02	90MnCrV8	
4	W210	19 356.4		100V2	TCV 105	C 105 E2 UV1	SKS 43	100V1		1.2833	NV	8Ch	BW 2	100V2	
4		19 418.4						80CrV5			NCV1	8Ch		80CrV2	
4		19 419.4						80CrV2			NCV1	8Ch		80CrV2	
4		19 420.4				Y2 140 C	SKS 8	140Cr2		1.2008	NC5	13Ch		140Cr2	
4	L2	19 421.4		107CrV3				115CrV3		1.2210	NC6			120CrV2	
4		19 422.4						145Cr6							
4	L2	19 423.4						90Cr3		1.2056					
4		19 426.4						85Cr7							
4		19 434.4		X21Cr13	X21Cr13	X20Cr13		X20Cr13 1.2082						X20Cr13 F5261	
1		19 435.4		X41Cr14	X40Cr14	X40Cr14	SUS420 J2	X42Cr13		1.2082	4H13	40Cr13	420S45	F5263	
4	D3	19 436.4		X210Cr12	C210Cr12	Z210Cr12	SKD1	X210Cr12		1.2080	NC11	Cr12	B03	X210Cr12	
4		19 437.4		X210CrW12-1	X210CrW12	X210CrW12-1		X210CrW12						2313	
4		19 452.4				Y60S7									
4		19 452.4													
4		19 487.4						21MnCr5		1.2162					
1	L7	19 501		100CrMo7	100CrMo7	100CrD7	SUJ4	100CrMo7		1.2303				F520F	
4	L7	19 501.4		100CrMo7	100CrMo7	100CrD7	SUJ4	100CrMo7		1.2303				F520F	
3		19 512.4				45CrV6		48CrMoV6 7							
3		19 520.4		35CrMo8	35CrMo7	40CrMnMo8		40CrMnMo7			W1B			40CrMnMo7	
1	H10	19 541.4		30CrMoV12-11	32CrMoV12-28	32CrMoV12-28	SKD7	X32CrMoV33		1.2365	W1V	3Ch3M3F	BH10	30CrMoV12	
3	H11	19 552.4		X37CrMoV5-1	X37CrMoV5 1	Z38CrV5	SKD6	X38CrMoV5.1		1.2343	WCL	4Ch5MF5	BH11	X37CrMoS1V5	
3	H11	19 553.9		X37CrMoV5-1	X37CrMoV5 1	Z38CrV5	SKD6	X38CrMoV5.1		1.2343	WCL	4Ch5MF5	BH11	X37CrMoS1V5	
3	H13	19 554.4		X40CrMoV5.1	40CrMoV5 1	X40CrMoV5	SKF61	X40CrMoV5.1		1.2344	WCLV	4Ch5MF1S	BH 13	X37CrMoS1V5	
4	H 42	19 561.4													
4	A 2	19 571.4		X5Mo1V	X100CrMoV5 1	Z100CrV5	SKD 12	X100CrMoV 5 1			NC1V	9Ch5Vf	BA 2	F5227	
4	A7	19 581.4													
4		19 614.4													
1		19 642.4		40NiCrMoV16	40NiCrMoV16	40NiCrMoV16		55NiCr11		1.2719				F5224	
3	L6	19 655.4		40NiCrMoV16	45NiCrMoV16	40NiCrMoV16	SKT 4	X45NiCrMoV12		1.2767	WNL	5ChNM	BP 30	35NiCrMoV16	
3		19 662.4		55NiCrMoV7	55NiCrMoV7	55NiCrD7		28NiCrMoV10		1.2740				F520S	
1		19 675.4						28NiCrMoV7		1.2747					
1		19 678						28NiCrMoV7		1.2747					
1		19 678.4						110WCrV5		1.2414	NW 1	CrV6		F5238	
4	F 1	19 710.4						X 130W5				CrV 4F			
4		19 712.4						30WCrV 5.3							
4	F 2	19 714.4						X30WCrV9.3							
1		19 720.4		X30WCrV5.3	30WCrV5	X32WCrV5	SKD 4	30WCrV 5.3			WWW	3Ch2V8F	BH21	X30WCrV9	
1		19 721.4		X30WCrV9.3	X30WCrV9.3	Z30WCrV9	SKD5	X30WCrV9.3		1.2581	WWW		BH 21A		
1	H21	19 723.4									WWW 1				

International equivalents / Equivalentes internacionales / Équivalences internationales

	(USA)	(CZ)	(PRC)	(EU)	(ISO)	(F)	(JIS)	(D)	(D)	(W-nr)	(PL)	(RUS)	(GB)	(E)
	AMS/SAE	ČSN	GB	EN	ISO	AFNOR	JIS	DIN	DIN	W-nr	PN	GOST	BS	
4	S1	19 732.4		45WCrV8	50WCrV8	45WCrV20		45WCrV7		1.2542	NZ2	50CrV2SF	BS1	45WCrV8
4	S1	19 733.4		55WCrV8	60WCrV8	55WCr20		60WCrV7		1.2542	NZ3	5CrV2S	BS 1	60WCrV8
1		19 740.4						30 WCrV151		1.2564	WWS1	R12F3		F.527
4		19 802.4					SKH6	S12-1-2		1.3318	SW12	R12F3		
4		19 810.4				Z130WV13.4		S12-1-4		1.3302	SW12	R9F5		
4	T1	19 824.4	W18CrV	HS18-0-1	HS 18-0-1	Z80WCV18-04-01	SKH 2	HS18-0-1		1.3355	SW18	R18	BT1	HS 18-0-1
4	M2	19 830.4	W6Mo5Cr4V2	HS 6-5-2	HS 6-5-2	Z85WDCV06-05-04-02	SKH51	HS 6-5-2		1.3343	SW7M	R6M5	BM2	HS 6-5-2
4		19 852.4	W6Mo5Cr4V2Co5	HS 6-5-2-5	HS 6-5-2-5	Z85WDCV06-05-04-02	SKH55	HS 6-5-2-5		1.3243	SKSM	R6M5K5	BM35	HS 6-5-2-5
4	T 4	19 855.4	W18Cr4VCo4	HS18-1-1-5		Z 80WCrV18-05-04-01	SKH 3	HS 18-1-2 5				R18M5F2	BT 4	F.5530
4		19 856.4										R9K5		
4	T 15	19 858.4	W12Cr4V5Co5	HS12-1-5-5	HS12-1-5-5	HS 12-1-5-5	SKH 10	HS 12-1-4 5		1.3202	SK 5V	R13F4K5	BT 15	HS12-1-5-5
4		19 861.4		HS 10-4-3-10		Z130WCrDV	SKH57	HS 10-4-3-10		1.3207	SK10V	R12F3K10M3-5	BT42	HS 10-4-3-10
4		42 2880.6										JUN04		
4		42 2881.6										JUN08		
4		42 2887.6						AINiCo18/9						
4		42 2891.6						AINiCo 3515						
4		42 2893.6						AINiCo 30/10				JUN14DK25A		
4		42 2895.6						AINiCo44/5				JUN13DK24S		
4		42 2992.4										R9		
2	Gr.1	422478										ŽČCh3	Sl4	
2		422483										ČS15	Sl4	
2		422484										ŽČCh30		
2		422491										ŽČCh16		
2	NH-Hard2	G-X 260 NiCr 4 2						G-X 260 NiCr 4 2		0.962			Grade 2 A	
2	NH-Hard 1	G-X 330 NiCr 4 2						G-X 330 NiCr 4 2		0.963			Grade 2 B	
2	NH-Hard2	G-X 260 NiCr 4 2						G-X 260 NiCr 4 2		0.962			Grade 2 A	
2	NH-Hard 1	G-X 330 NiCr 4 2						G-X 330 NiCr 4 2		0.963			Grade 2 B	
2	NH-Hard4	G-X 300 CrNiSi 9 5 2						G-X 300 CrNiSi 9 5 2		0.963				
2		G-X 300 CrMo 15 3						G-X 300 CrMo 15 3		0.964				
2		G-X 300 CrMoNi 15 2 1						G-X 300 CrMoNi 15 2 1		0.964				
2		G-X 280 CrMoNi 20 2 1						G-X 280 CrMoNi 20 2 1		0.965				
2	A 532 III A 25% Cr	G-X 260 Cr 27						G-X 260 Cr 27		0.965			Grade 3 D	

Strength Resistencia Résistance [MPa]	Hardness / Dureza / Dureté				Strength Resistencia Résistance [MPa]	Hardness / Dureza / Dureté			
	BRINELL	VICKERS	ROCKWELL	ROCKWELL		BRINELL	VICKERS	ROCKWELL	ROCKWELL
	HB	HV	HRB	HRC		HB	HV	HRB	HRC
285	86	90	1190	–	1190	352	370	–	37,7
320	95	100	56,2	–	1220	361	380	–	38,8
350	105	110	62,3	–	1255	371	390	–	39,8
385	114	120	66,7	–	1290	380	400	–	40,8
415	124	130	71,2	–	1320	390	410	–	41,8
450	133	140	75,0	–	1350	399	420	–	42,7
480	143	150	78,7	–	1385	409	430	–	43,6
510	152	160	81,7	–	1420	418	440	–	44,5
545	162	170	85,8	–	1455	428	450	–	45,3
575	171	180	87,1	–	1485	437	460	–	46,1
610	181	190	89,5	–	1520	447	470	–	46,9
640	190	200	91,5	–	1555	456	480	–	47,7
675	199	210	93,5	–	1595	466	490	–	48,4
705	209	220	95	–	1630	475	500	–	49,1
740	219	230	96,7	–	1665	485	510	–	49,8
770	228	240	98,1	–	1700	494	520	–	50,5
800	238	250	99,5	–	1740	504	530	–	51,1
820	242	255	–	23,1	1775	513	540	–	51,7
850	252	265	–	24,8	1810	523	550	–	52,3
880	261	275	–	26,4	1845	532	560	–	53,0
900	266	280	–	27,1	1880	542	570	–	53,6
930	276	290	–	28,5	1920	551	580	–	54,1
950	280	295	–	29,2	1955	561	590	–	54,7
995	295	310	–	31,0	1995	570	600	–	55,2
1030	304	320	–	32,2	2030	580	610	–	55,7
1060	314	330	–	33,3	2070	589	620	–	56,3
1095	323	340	–	34,4	2105	599	630	–	56,8
1125	333	350	–	35,5	2145	608	640	–	57,3
1155	342	360	–	36,6	2180	618	650	–	57,8

ANSI	ISO	EDP
ADEX 070204FR-FA:HF7	ADEX 070204FR-FA:HF7	7606835
ADEX 070204FR-FA:MO315	ADEX 070204FR-FA:MO315	7606837
ADEX 070206SR-HF:M6330	ADEX 070206SR-HF:M6330	7606877
ADEX 070206SR-HF:M8330	ADEX 070206SR-HF:M8330	7606875
ADEX 070206SR-HF:M8340	ADEX 070206SR-HF:M8340	7606876
ADEX 070208FR-FA:HF7	ADEX 070208FR-FA:HF7	7606836
ADEX 11T304FR-FA:HF7	ADEX 11T304FR-FA:HF7	6753137
ADEX 11T304FR-FA:MO315	ADEX 11T304FR-FA:MO315	6800782
ADEX 11T308FR-FA:HF7	ADEX 11T308FR-FA:HF7	6753138
ADEX 11T308FR-FA:MO315	ADEX 11T308FR-FA:MO315	6800783
ADEX 11T308SR-HF:8215	ADEX 11T308SR-HF:8215	6800779
ADEX 11T308SR-HF:8230	ADEX 11T308SR-HF:8230	6800780
ADEX 11T308SR-HF:M6330	ADEX 11T308SR-HF:M6330	7601275
ADEX 11T308SR-HF:M8310	ADEX 11T308SR-HF:M8310	6922512
ADEX 11T308SR-HF:M8330	ADEX 11T308SR-HF:M8330	7447737
ADEX 11T308SR-HF:M8340	ADEX 11T308SR-HF:M8340	6800781
ADEX 11T308SR-HF:M9340	ADEX 11T308SR-HF:M9340	7048985
ADEX 11T308SR-HF2:8230	ADEX 11T308SR-HF2:8230	7056742
ADEX 11T308SR-HF2:M8310	ADEX 11T308SR-HF2:M8310	7056741
ADEX 11T308SR-HF2:M8330	ADEX 11T308SR-HF2:M8330	7447738
ADEX 11T308SR-HF2:M8340	ADEX 11T308SR-HF2:M8340	7056745
ADEX 11T308SR-HF2:M9325	ADEX 11T308SR-HF2:M9325	7056743
ADEX 11T308SR-HF2:M9340	ADEX 11T308SR-HF2:M9340	7056744
ADEX 11T312FR-FA:HF7	ADEX 11T312FR-FA:HF7	7155957
ADEX 11T312FR-FA:MO315	ADEX 11T312FR-FA:MO315	7155958
ADEX 11T316FR-FA:HF7	ADEX 11T316FR-FA:HF7	6754620
ADEX 160604FR-FA:HF7	ADEX 160604FR-FA:HF7	6838381
ADEX 160604FR-FA:MO315	ADEX 160604FR-FA:MO315	6838384
ADEX 160608FR-FA:HF7	ADEX 160608FR-FA:HF7	6752632
ADEX 160608FR-FA:MO315	ADEX 160608FR-FA:MO315	6838385
ADEX 160608SR-FM:8215	ADEX 160608SR-FM:8215	6753382
ADEX 160608SR-FM:M8310	ADEX 160608SR-FM:M8310	6922511
ADEX 160608SR-FM:M8330	ADEX 160608SR-FM:M8330	7447739
ADEX 160608SR-FM:M8340	ADEX 160608SR-FM:M8340	6800797
ADEX 160612SR-HF:8215	ADEX 160612SR-HF:8215	6838414
ADEX 160612SR-HF:8230	ADEX 160612SR-HF:8230	6838415
ADEX 160612SR-HF:M8310	ADEX 160612SR-HF:M8310	6922513
ADEX 160612SR-HF:M8330	ADEX 160612SR-HF:M8330	7447790
ADEX 160612SR-HF:M8340	ADEX 160612SR-HF:M8340	6838416
ADEX 160612SR-HF:M9340	ADEX 160612SR-HF:M9340	7048986
ADEX 160612SR-HF2:8230	ADEX 160612SR-HF2:8230	7056747
ADEX 160612SR-HF2:M8310	ADEX 160612SR-HF2:M8310	7056746
ADEX 160612SR-HF2:M8330	ADEX 160612SR-HF2:M8330	7447791
ADEX 160612SR-HF2:M8340	ADEX 160612SR-HF2:M8340	7056750
ADEX 160612SR-HF2:M9325	ADEX 160612SR-HF2:M9325	7056748
ADEX 160612SR-HF2:M9340	ADEX 160612SR-HF2:M9340	7056749
ADEX 160616FR-FA:HF7	ADEX 160616FR-FA:HF7	6838382
ADEX 160616FR-FA:MO315	ADEX 160616FR-FA:MO315	6838386
ADEX 160630FR-FA:HF7	ADEX 160630FR-FA:HF7	6838383
ADKT 1505PDER-M:M8330	ADKT 1505PDER-M:M8330	7447792
ADKT 1505PDER-M:M8340	ADKT 1505PDER-M:M8340	6800798
ADKT 1505PDER-M:M9325	ADKT 1505PDER-M:M9325	6754542
ADKX 15T304ER-F:M8330	ADKX 15T304ER-F:M8330	7447793
ADKX 15T304ER-F:M8345	ADKX 15T304ER-F:M8345	6756223
ADKX 15T308ER-F:M8330	ADKX 15T308ER-F:M8330	7447794
ADKX 15T308ER-F:M8345	ADKX 15T308ER-F:M8345	6756225
ADKX 15T330ER-F:M8330	ADKX 15T330ER-F:M8330	7447795
ADKX 15T330ER-F:M8345	ADKX 15T330ER-F:M8345	6756227
ADKX 15T340ER-F:M8330	ADKX 15T340ER-F:M8330	7447796
ADKX 15T340ER-F:M8345	ADKX 15T340ER-F:M8345	6756229
ADKX 15T360ER-F:M8330	ADKX 15T360ER-F:M8330	7447797
ADMX 070202SR-F:M8330	ADMX 070202SR-F:M8330	7799486
ADMX 070202SR-F:M8340	ADMX 070202SR-F:M8340	7799487
ADMX 070202SR-M:8215	ADMX 070202SR-M:8215	6798615
ADMX 070202SR-M:M8330	ADMX 070202SR-M:M8330	7447798
ADMX 070202SR-M:M8340	ADMX 070202SR-M:M8340	6798617
ADMX 070204SR-F:M6330	ADMX 070204SR-F:M6330	7799521
ADMX 070204SR-F:M8310	ADMX 070204SR-F:M8310	7799488
ADMX 070204SR-F:M8330	ADMX 070204SR-F:M8330	7799489
ADMX 070204SR-F:M8340	ADMX 070204SR-F:M8340	7799520
ADMX 070204SR-F:M9340	ADMX 070204SR-F:M9340	7799522
ADMX 070204SR-M:8215	ADMX 070204SR-M:8215	6798618
ADMX 070204SR-M:8230	ADMX 070204SR-M:8230	6798619
ADMX 070204SR-M:M6330	ADMX 070204SR-M:M6330	6925504
ADMX 070204SR-M:M8310	ADMX 070204SR-M:M8310	6922514
ADMX 070204SR-M:M8330	ADMX 070204SR-M:M8330	7447799
ADMX 070204SR-M:M8340	ADMX 070204SR-M:M8340	6798620

ANSI	ISO	EDP
ADMX 070204SR-M:M9340	ADMX 070204SR-M:M9340	6798621
ADMX 070208SR-F:M6330	ADMX 070208SR-F:M6330	7799607
ADMX 070208SR-F:M8310	ADMX 070208SR-F:M8310	7799604
ADMX 070208SR-F:M8330	ADMX 070208SR-F:M8330	7799605
ADMX 070208SR-F:M8340	ADMX 070208SR-F:M8340	7799606
ADMX 070208SR-M:8215	ADMX 070208SR-M:8215	6798622
ADMX 070208SR-M:8230	ADMX 070208SR-M:8230	6798623
ADMX 070208SR-M:M6330	ADMX 070208SR-M:M6330	7601277
ADMX 070208SR-M:M8310	ADMX 070208SR-M:M8310	6922515
ADMX 070208SR-M:M8330	ADMX 070208SR-M:M8330	7447800
ADMX 070208SR-M:M8340	ADMX 070208SR-M:M8340	6798624
ADMX 070208SR-M:M9340	ADMX 070208SR-M:M9340	6798625
ADMX 070212SR-M:M8340	ADMX 070212SR-M:M8340	7799771
ADMX 070216SR-M:M8310	ADMX 070216SR-M:M8310	7799774
ADMX 070216SR-M:M8330	ADMX 070216SR-M:M8330	7799772
ADMX 070216SR-M:M8340	ADMX 070216SR-M:M8340	7799773
ADMX 070220SR-M:M8310	ADMX 070220SR-M:M8310	7048987
ADMX 070220SR-M:M8330	ADMX 070220SR-M:M8330	7447801
ADMX 070220SR-M:M8340	ADMX 070220SR-M:M8340	6939771
ADMX 11T302SR-M:M8330	ADMX 11T302SR-M:M8330	7447802
ADMX 11T302SR-M:M8340	ADMX 11T302SR-M:M8340	6800753
ADMX 11T304SR-F:8215	ADMX 11T304SR-F:8215	6753383
ADMX 11T304SR-F:8230	ADMX 11T304SR-F:8230	6753123
ADMX 11T304SR-F:M8310	ADMX 11T304SR-F:M8310	6922516
ADMX 11T304SR-F:M8330	ADMX 11T304SR-F:M8330	7447803
ADMX 11T304SR-F:M8340	ADMX 11T304SR-F:M8340	6800784
ADMX 11T304SR-F:M9340	ADMX 11T304SR-F:M9340	6754588
ADMX 11T304SR-M:8215	ADMX 11T304SR-M:8215	6753384
ADMX 11T304SR-M:8230	ADMX 11T304SR-M:8230	6753125
ADMX 11T304SR-M:M8310	ADMX 11T304SR-M:M8310	6922517
ADMX 11T304SR-M:M8330	ADMX 11T304SR-M:M8330	7447804
ADMX 11T304SR-M:M8340	ADMX 11T304SR-M:M8340	6800785
ADMX 11T304SR-M:M9325	ADMX 11T304SR-M:M9325	6754538
ADMX 11T304SR-M:M9340	ADMX 11T304SR-M:M9340	6754589
ADMX 11T304SR-MF:M6330	ADMX 11T304SR-MF:M6330	6925505
ADMX 11T304SR-MF:M8340	ADMX 11T304SR-MF:M8340	6925538
ADMX 11T304SR-MF:M9340	ADMX 11T304SR-MF:M9340	7051432
ADMX 11T304SR-MM:M6330	ADMX 11T304SR-MM:M6330	6925507
ADMX 11T304SR-MM:M8340	ADMX 11T304SR-MM:M8340	6925540
ADMX 11T304SR-MM:M9340	ADMX 11T304SR-MM:M9340	7051464
ADMX 11T308PR-R:8215	ADMX 11T308PR-R:8215	6753385
ADMX 11T308PR-R:M5315	ADMX 11T308PR-R:M5315	6754621
ADMX 11T308PR-R:M8310	ADMX 11T308PR-R:M8310	6922518
ADMX 11T308PR-R:M8330	ADMX 11T308PR-R:M8330	7447805
ADMX 11T308PR-R:M8340	ADMX 11T308PR-R:M8340	6800786
ADMX 11T308PR-R:M9315	ADMX 11T308PR-R:M9315	6754549
ADMX 11T308PR-R:M9325	ADMX 11T308PR-R:M9325	6754539
ADMX 11T308SR-F:8215	ADMX 11T308SR-F:8215	6753386
ADMX 11T308SR-F:8230	ADMX 11T308SR-F:8230	6753127
ADMX 11T308SR-F:M8330	ADMX 11T308SR-F:M8330	7447806
ADMX 11T308SR-F:M8340	ADMX 11T308SR-F:M8340	6800787
ADMX 11T308SR-F:M9340	ADMX 11T308SR-F:M9340	6754590
ADMX 11T308SR-M:8215	ADMX 11T308SR-M:8215	6753387
ADMX 11T308SR-M:8230	ADMX 11T308SR-M:8230	6753130
ADMX 11T308SR-M:M5315	ADMX 11T308SR-M:M5315	6754622
ADMX 11T308SR-M:M8310	ADMX 11T308SR-M:M8310	6922519
ADMX 11T308SR-M:M8330	ADMX 11T308SR-M:M8330	7447807
ADMX 11T308SR-M:M8340	ADMX 11T308SR-M:M8340	6800788
ADMX 11T308SR-M:M9315	ADMX 11T308SR-M:M9315	6754550
ADMX 11T308SR-M:M9325	ADMX 11T308SR-M:M9325	6754540
ADMX 11T308SR-M:M9340	ADMX 11T308SR-M:M9340	6754591
ADMX 11T308SR-MF:M6330	ADMX 11T308SR-MF:M6330	6925506
ADMX 11T308SR-MF:M8340	ADMX 11T308SR-MF:M8340	6925539
ADMX 11T308SR-MF:M9340	ADMX 11T308SR-MF:M9340	7051433
ADMX 11T308SR-MM:M6330	ADMX 11T308SR-MM:M6330	6925508
ADMX 11T308SR-MM:M8340	ADMX 11T308SR-MM:M8340	6925541
ADMX 11T308SR-MM:M8345	ADMX 11T308SR-MM:M8345	7051437
ADMX 11T308SR-MM:M9340	ADMX 11T308SR-MM:M9340	7051465
ADMX 11T310SR-M:M8330	ADMX 11T310SR-M:M8330	7447808
ADMX 11T310SR-M:M8340	ADMX 11T310SR-M:M8340	6800755
ADMX 11T312SR-M:8215	ADMX 11T312SR-M:8215	6800757
ADMX 11T312SR-M:M8330	ADMX 11T312SR-M:M8330	7447809
ADMX 11T312SR-M:M8340	ADMX 11T312SR-M:M8340	6800758
ADMX 11T312SR-MM:M6330	ADMX 11T312SR-MM:M6330	6925509
ADMX 11T312SR-MM:M8340	ADMX 11T312SR-MM:M8340	6925542
ADMX 11T312SR-MM:M8340	ADMX 11T312SR-MM:M8340	6925540
ADMX 11T312SR-MM:M8340	ADMX 11T312SR-MM:M8340	7051438

ANSI	ISO	EDP
ADMX 11T312SR-MM:M9340	ADMX 11T312SR-MM:M9340	7051466
ADMX 11T316PR-R:8215	ADMX 11T316PR-R:8215	6800775
ADMX 11T316PR-R:M8330	ADMX 11T316PR-R:M8330	7447810
ADMX 11T316PR-R:M8340	ADMX 11T316PR-R:M8340	6800777
ADMX 11T316PR-R:M9325	ADMX 11T316PR-R:M9325	6800778
ADMX 11T316SR-M:8215	ADMX 11T316SR-M:8215	6753388
ADMX 11T316SR-M:8230	ADMX 11T316SR-M:8230	6753135
ADMX 11T316SR-M:M6330	ADMX 11T316SR-M:M6330	7601278
ADMX 11T316SR-M:M8310	ADMX 11T316SR-M:M8310	6922520
ADMX 11T316SR-M:M8330	ADMX 11T316SR-M:M8330	7447811
ADMX 11T316SR-M:M8340	ADMX 11T316SR-M:M8340	6800789
ADMX 11T320SR-M:M6330	ADMX 11T320SR-M:M6330	7601279
ADMX 11T320SR-M:M8330	ADMX 11T320SR-M:M8330	7447812
ADMX 11T320SR-M:M8340	ADMX 11T320SR-M:M8340	6800770
ADMX 11T325SR-M:M6330	ADMX 11T325SR-M:M6330	7601330
ADMX 11T325SR-M:M8330	ADMX 11T325SR-M:M8330	7447813
ADMX 11T325SR-M:M8340	ADMX 11T325SR-M:M8340	6800772
ADMX 11T330SR-M:M6330	ADMX 11T330SR-M:M6330	7601331
ADMX 11T330SR-M:M8330	ADMX 11T330SR-M:M8330	7447814
ADMX 11T330SR-M:M8340	ADMX 11T330SR-M:M8340	6800774
ADMX 160604SR-M:8215	ADMX 160604SR-M:8215	6838387
ADMX 160604SR-M:8230	ADMX 160604SR-M:8230	6838388
ADMX 160604SR-M:M8330	ADMX 160604SR-M:M8330	7447815
ADMX 160604SR-M:M8340	ADMX 160604SR-M:M8340	6838389
ADMX 160604SR-MM:M6330	ADMX 160604SR-MM:M6330	6925521
ADMX 160604SR-MM:M8340	ADMX 160604SR-MM:M8340	6925544
ADMX 160604SR-MM:M9340	ADMX 160604SR-MM:M9340	7051467
ADMX 160608PR-R:8215	ADMX 160608PR-R:8215	6753389
ADMX 160608PR-R:8230	ADMX 160608PR-R:8230	6752623
ADMX 160608PR-R:M5315	ADMX 160608PR-R:M5315	6754623
ADMX 160608PR-R:M8310	ADMX 160608PR-R:M8310	6922521
ADMX 160608PR-R:M8330	ADMX 160608PR-R:M8330	7447816
ADMX 160608PR-R:M8340	ADMX 160608PR-R:M8340	6800799
ADMX 160608PR-R:M9315	ADMX 160608PR-R:M9315	6754548
ADMX 160608PR-R:M9325	ADMX 160608PR-R:M9325	6754543
ADMX 160608PR-R:8215	ADMX 160608PR-R:8215	6753390
ADMX 160608SR-F:8230	ADMX 160608SR-F:8230	6752580
ADMX 160608SR-F:M8310	ADMX 160608SR-F:M8310	6922522
ADMX 160608SR-F:M8330	ADMX 160608SR-F:M8330	7447817
ADMX 160608SR-F:M8340	ADMX 160608SR-F:M8340	6800810
ADMX 160608SR-F:M9340	ADMX 160608SR-F:M9340	6754592
ADMX 160608SR-M:8215	ADMX 160608SR-M:8215	6753391
ADMX 160608SR-M:8230	ADMX 160608SR-M:8230	6752561
ADMX 160608SR-M:M5315	ADMX 160608SR-M:M5315	6754624
ADMX 160608SR-M:M8310	ADMX 160608SR-M:M8310	6922523
ADMX 160608SR-M:M8330	ADMX 160608SR-M:M8330	7447818
ADMX 160608SR-M:M8340	ADMX 160608SR-M:M8340	6800811
ADMX 160608SR-M:M9315	ADMX 160608SR-M:M9315	6754547
ADMX 160608SR-M:M9325	ADMX 160608SR-M:M9325	6754544
ADMX 160608SR-M:M9340	ADMX 160608SR-M:M9340	6754593
ADMX 160		

ANSI	ISO	EDP
ADMX 160632SR-M:8230	ADMX 160632SR-M:8230	6752579
ADMX 160632SR-M:M6330	ADMX 160632SR-M:M6330	7601333
ADMX 160632SR-M:M8330	ADMX 160632SR-M:M8330	7447823
ADMX 160632SR-M:M8340	ADMX 160632SR-M:M8340	6800813
ADMX 160632SR-M:M9325	ADMX 160632SR-M:M9325	6754546
ADMX 160640SR-M:M6330	ADMX 160640SR-M:M6330	7601334
ADMX 160640SR-M:M8330	ADMX 160640SR-M:M8330	7447824
ADMX 160640SR-M:M8340	ADMX 160640SR-M:M8340	6838405
ADMX 160650SR-M:M8330	ADMX 160650SR-M:M8330	7447825
ADMX 160650SR-M:M8340	ADMX 160650SR-M:M8340	6838407
ANHX 107320SR-F:M8310	ANHX 107320SR-F:M8310	7451999
ANHX 107320SR-F:M8330	ANHX 107320SR-F:M8330	7452020
ANHX 107320SR-F:M8340	ANHX 107320SR-F:M8340	7452021
APET 150412EN:8230	APET 150412EN:8230	6752538
APET 150412EN:M8330	APET 150412EN:M8330	7447826
APET 150412SN:M8330	APET 150412SN:M8330	7447827
APET 150412SN:M8340	APET 150412SN:M8340	6800814
APET 160408FR-FA:HF7	APET 160408FR-FA:HF7	6752087
APEW 150412ER:M8330	APEW 150412ER:M8330	7447828
APEW 150412SR:M8330	APEW 150412SR:M8330	7447829
APEW 150412SR:M8340	APEW 150412SR:M8340	6835882
APKT 1003PDER-M:8215	APKT 1003PDER-M:8215	6753394
APKT 1003PDER-M:8230	APKT 1003PDER-M:8230	6752540
APKT 1003PDER-M:M8330	APKT 1003PDER-M:M8330	7447830
APKT 1003PDER-M:M8340	APKT 1003PDER-M:M8340	6800815
APKT 1003PDER-M:M9315	APKT 1003PDER-M:M9315	6754682
APKT 1003PDER-M:M9325	APKT 1003PDER-M:M9325	6754535
APKT 1003PDER-M:M9340	APKT 1003PDER-M:M9340	6754683
APKT 1003PDR-FA:HF7	APKT 1003PDR-FA:HF7	6757896
APKT 160404HM:M8340	APKT 160404HM:M8340	6800816
APKT 160416HM:M8340	APKT 160416HM:M8340	6800817
APKT 160431HM:M8340	APKT 160431HM:M8340	6800818
APKT 1604PDR-GM:8230	APKT 1604PDR-GM:8230	6752541
APKT 1604PDR-GM:M8330	APKT 1604PDR-GM:M8330	7447831
APKT 1604PDR-GM:M8340	APKT 1604PDR-GM:M8340	6800819
APKT 1604PDR-GM:M9315	APKT 1604PDR-GM:M9315	6754632
APKT 1604PDR-GM:M9325	APKT 1604PDR-GM:M9325	6754536
APKT 1604PDR-GM:M9340	APKT 1604PDR-GM:M9340	6754633
APKT 1604PDR-HM:8215	APKT 1604PDR-HM:8215	6753395
APKT 1604PDR-HM:8230	APKT 1604PDR-HM:8230	6752543
APKT 1604PDR-HM:M5315	APKT 1604PDR-HM:M5315	6754625
APKT 1604PDR-HM:M8330	APKT 1604PDR-HM:M8330	7447832
APKT 1604PDR-HM:M8340	APKT 1604PDR-HM:M8340	6800820
APKT 1604PDR-HM:M9315	APKT 1604PDR-HM:M9315	6754692
APKT 1604PDR-HM:M9325	APKT 1604PDR-HM:M9325	6754537
APKX 1103PDER-M:M8340	APKX 1103PDER-M:M8340	6835883
APKX 150516-M:M8340	APKX 150516-M:M8340	6835884
APKX 150532-M:M8340	APKX 150532-M:M8340	6835885
APKX 1505PDER-F:M8340	APKX 1505PDER-F:M8340	6800821
APKX 1505PDER-M:M8340	APKX 1505PDER-M:M8340	6800822
APKX 1505PDSR-R:M8340	APKX 1505PDSR-R:M8340	6800823
APMT 1604PDER-F:M8330	APMT 1604PDER-F:M8330	7447833
APMT 1604PDER-FM:M8330	APMT 1604PDER-FM:M8330	7447834
APMT 1604PDER-FM:M8345	APMT 1604PDER-FM:M8345	7156043
APMT 1604PDER-R:M8330	APMT 1604PDER-R:M8330	7447835
APMT 1604PDER-R:M8345	APMT 1604PDER-R:M8345	7156045
APMT 1604PDSR-R:M8330	APMT 1604PDSR-R:M8330	7447836
APMT 1604PDSR-R:M8345	APMT 1604PDSR-R:M8345	7156047
BNGX 107308SR-HM:8215	BNGX 107308SR-HM:8215	7451997
BNGX 107308SR-HM:M8310	BNGX 107308SR-HM:M8310	7451998
BNGX 107308SR-HM:M8330	BNGX 107308SR-HM:M8330	7451998
BNGX 107308SR-M:8215	BNGX 107308SR-M:8215	7451991
BNGX 107308SR-M:M6330	BNGX 107308SR-M:M6330	7601335
BNGX 107308SR-M:M8310	BNGX 107308SR-M:M8310	7451990
BNGX 107308SR-M:M8330	BNGX 107308SR-M:M8330	7451992
BNGX 107308SR-M:M8340	BNGX 107308SR-M:M8340	7451993
BNGX 107308SR-M:M8345	BNGX 107308SR-M:M8345	7451994
BNGX 107308SR-M:M9325	BNGX 107308SR-M:M9325	7451995
BNGX 107308SR-MM:M6330	BNGX 107308SR-MM:M6330	7253609
BNGX 107308SR-MM:M8310	BNGX 107308SR-MM:M8310	7474618
BNGX 107308SR-MM:M8330	BNGX 107308SR-MM:M8330	7474619
BNGX 107308SR-MM:M8340	BNGX 107308SR-MM:M8340	7253607
BNGX 107308SR-MM:M8345	BNGX 107308SR-MM:M8345	7253608
BNGX 107308SR-MM:M9325	BNGX 107308SR-MM:M9325	7253620
BNGX 107308SR-MM:M9340	BNGX 107308SR-MM:M9340	7253621
CCGT 2.520.5F-AL:T0315	CCGT 080302F-AL:T0315	6756210
CCGT 2.520.5F-SF3:T8310	CCGT 080302E-SF3:T8310	7168529

ANSI	ISO	EDP
CCGT 2.520.5F-SF3:T8315	CCGT 080302E-SF3:T8315	7168540
CCGT 2.521F-AL:HF7	CCGT 080304F-AL:HF7	6756212
CCGT 2.521F-AL:T0315	CCGT 080304F-AL:T0315	6756213
CCGT 2.521-SF3:H07	CCGT 080304E-SF3:H07	7168541
CCGT 2.521-SF3:T6310	CCGT 080304E-SF3:T6310	7168542
CCGT 2.521-SF3:T8315	CCGT 080304E-SF3:T8315	7168543
CCGT 2.150.2-SF3:T6310	CCGT 060201E-SF3:T6310	7600312
CCGT 2.150.5F-AL:HF7	CCGT 060202F-AL:HF7	6751796
CCGT 2.150.5F-AL:T0315	CCGT 060202F-AL:T0315	6756135
CCGT 2.150.5L-SI:T8330	CCGT 060202E-SI:T8330	6754378
CCGT 2.150.5R-SI:T8330	CCGT 060202E-SI:T8330	6754379
CCGT 2.150.5F-SF3:H07	CCGT 060202E-SF3:H07	7168523
CCGT 2.150.5F-SF3:T6310	CCGT 060202E-SF3:T6310	7168524
CCGT 2.150.5F-SF3:T8315	CCGT 060202E-SF3:T8315	7168525
CCGT 2.151F-AL:HF7	CCGT 060204F-AL:HF7	6751797
CCGT 2.151F-AL:T0315	CCGT 060204F-AL:T0315	6756136
CCGT 2.151L-SI:T8315	CCGT 060204E-SI:T8315	6922722
CCGT 2.151L-SI:T8330	CCGT 060204E-SI:T8330	6754380
CCGT 2.151-NF1:H07	CCGT 060204E-NF1:H07	7166214
CCGT 2.151-NF1:T6310	CCGT 060204E-NF1:T6310	7166215
CCGT 2.151-NF1:T7325	CCGT 060204E-NF1:T7325	7166216
CCGT 2.151R-SI:T8315	CCGT 060204E-SI:T8315	6922723
CCGT 2.151R-SI:T8330	CCGT 060204E-SI:T8330	6754381
CCGT 2.151-SF3:H07	CCGT 060204E-SF3:H07	7168526
CCGT 2.151-SF3:T6310	CCGT 060204E-SF3:T6310	7168527
CCGT 2.151-SF3:T8315	CCGT 060204E-SF3:T8315	7168528
CCGT 2.152-NF1:T6310	CCGT 060208E-NF1:T6310	7166218
CCGT 2.152-NF1:T7325	CCGT 060208E-NF1:T7325	7166219
CCGT 32.50.2-SF3:T6310	CCGT 09T301E-SF3:T6310	7600313
CCGT 32.50.5F-AL:HF7	CCGT 09T302F-AL:HF7	6752084
CCGT 32.50.5F-AL:T0315	CCGT 09T302F-AL:T0315	6756137
CCGT 32.50.5F-F2:T7325	CCGT 09T302E-F2:T7325	7156678
CCGT 32.50.5F-F2:T9325	CCGT 09T302E-F2:T9325	7156679
CCGT 32.50.5F-SF3:H07	CCGT 09T302E-SF3:H07	7168544
CCGT 32.50.5F-SF3:T6310	CCGT 09T302E-SF3:T6310	7168545
CCGT 32.50.5F-SF3:T8315	CCGT 09T302E-SF3:T8315	7168546
CCGT 32.51F-AL:HF7	CCGT 09T304F-AL:HF7	6751705
CCGT 32.51F-AL:T0315	CCGT 09T304F-AL:T0315	6756138
CCGT 32.51L-SI:T8315	CCGT 09T304E-SI:T8315	6922720
CCGT 32.51L-SI:T8330	CCGT 09T304E-SI:T8330	6754382
CCGT 32.51-NF1:H07	CCGT 09T304E-NF1:H07	7167400
CCGT 32.51-NF1:T6310	CCGT 09T304E-NF1:T6310	7167401
CCGT 32.51-NF1:T7325	CCGT 09T304E-NF1:T7325	7167402
CCGT 32.51R-SI:T8315	CCGT 09T304E-SI:T8315	6922721
CCGT 32.51R-SI:T8330	CCGT 09T304E-SI:T8330	6754383
CCGT 32.51-SF3:H07	CCGT 09T304E-SF3:H07	7168547
CCGT 32.51-SF3:T6310	CCGT 09T304E-SF3:T6310	7168548
CCGT 32.51-SF3:T8315	CCGT 09T304E-SF3:T8315	7168549
CCGT 32.52F-AL:HF7	CCGT 09T308F-AL:HF7	6751799
CCGT 32.52F-AL:T0315	CCGT 09T308F-AL:T0315	6756139
CCGT 32.52-NF1:T6310	CCGT 09T308E-NF1:T6310	7167404
CCGT 32.52-NF1:T7325	CCGT 09T308E-NF1:T7325	7167405
CCGT 32.52-SF3:H07	CCGT 09T308E-SF3:H07	7168550
CCGT 32.52-SF3:T6310	CCGT 09T308E-SF3:T6310	7168551
CCGT 32.52-SF3:T8315	CCGT 09T308E-SF3:T8315	7168552
CCGT 431F-AL:HF7	CCGT 120404F-AL:HF7	6751703
CCGT 431F-AL:T0315	CCGT 120404F-AL:T0315	6756140
CCGT 431-SF3:T6310	CCGT 120404E-SF3:T6310	7600314
CCGT 432F-AL:HF7	CCGT 120408F-AL:HF7	6751701
CCGT 432F-AL:T0315	CCGT 120408E-AL:T0315	6756141
CCGT 432L-SI:T8330	CCGT 120408E-SI:T8330	6754384
CCGT 432R-SI:T8330	CCGT 120408E-SI:T8330	6754385
CCGT 432-SF3:H07	CCGT 120408E-SF3:H07	7168553
CCGT 432-SF3:T6310	CCGT 120408E-SF3:T6310	7168554
CCGT 432-SF3:T8315	CCGT 120408E-SF3:T8315	7168555
CCGW 21.51E:T8310	CCGW 060204E-B:T8310	6755919
CCGW 21.51S0040-T8310	CCGW 060204S01020B-T8310	6755685
CCGW 32.51E:T8310	CCGW 09T304E-B:T8310	6755920
CCGW 32.51S0040-T8310	CCGW 09T304S01020B-T8310	6755921
CCMT 060202E-FM:T8330	CCMT 060202E-FM:T8330	6754280
CCMT 060204E-FM:T8330	CCMT 060204E-FM:T8330	6754281
CCMT 060208E-FM:T8330	CCMT 060208E-FM:T8330	6754282
CCMT 09T302E-FM:T8330	CCMT 09T302E-FM:T8330	6753648
CCMT 09T304E-FM:T8330	CCMT 09T304E-FM:T8330	6754283
CCMT 09T308E-FM:T8330	CCMT 09T308E-FM:T8330	6754284
CCMT 1.821-FM2:T9315	CCMT 080304E-FM2:T9315	6922861
CCMT 2.520.5F-F2:T7325	CCMT 080302E-F2:T7325	7168529

ANSI	ISO	EDP
CCMT 2.520.5F-F2:T8330	CCMT 080302E-F2:T8330	7156710
CCMT 2.520.5F-F2:T9325	CCMT 080302E-F2:T9325	6755932
CCMT 2.520.5F-F2:T1010	CCMT 080302E-F2:T1010	6756300
CCMT 2.521-FF2:T7325	CCMT 080304E-FF2:T7325	7156711
CCMT 2.521-FF2:T8330	CCMT 080304E-FF2:T8330	7156712
CCMT 2.521-FF2:T9325	CCMT 080304E-FF2:T9325	6755933
CCMT 2.521-FF2:T1010	CCMT 080304E-FF2:T1010	6756301
CCMT 2.521-FM2:T8330	CCMT 080304E-FM2:T8330	7156864
CCMT 2.521-FM2:T9325	CCMT 080304E-FM2:T9325	6756077
CCMT 2.521-FM2:T9335	CCMT 080304E-FM2:T9335	6756078
CCMT 2.521-FM2:T5315	CCMT 080304E-FM2:T5315	6756079
CCMT 2.521-NF2:T7325	CCMT 080304E-NF2:T7325	7156167
CCMT 2.521-NF2:T7335	CCMT 080304E-NF2:T7335	6756082
CCMT 2.521-NF2:T9315	CCMT 080304E-NF2:T9315	6756080
CCMT 2.521-NF2:T9325	CCMT 080304E-NF2:T9325	6756081
CCMT 2.521-NF2:T9335	CCMT 080304E-NF2:T9335	7167455
CCMT 2.522-FF2:T7325	CCMT 080308E-FF2:T7325	7156713
CCMT 2.522-FF2:T8330	CCMT 080308E-FF2:T8330	7156714
CCMT 2.522-FF2:T9325	CCMT 080308E-FF2:T9325	7156715
CCMT 2.522-FM2:T8330	CCMT 080308E-FM2:T8330	7156865
CCMT 2.522-FM2:T9325	CCMT 080308E-FM2:T9325	6756083
CCMT 2.522-FM2:T9335	CCMT 080308E-FM2:T9335	6756084
CCMT 2.522-NF2:H07	CCMT 080308E-NF2:H07	7167456
CCMT 2.522-NF2:T5315	CCMT 080308E-NF2:T5315	6756085
CCMT 2.522-NF2:T7325	CCMT 080308E-NF2:T7325	7156168
CCMT 2.522-NF2:T7335	CCMT 080308E-NF2:T7335	6756087
CCMT 2.522-NF2:T9325	CCMT 080308E-NF2:T9325	6756086
CCMT 2.150.5F-FF:T8315	CCMT 060202E-FF:T8315	6753662
CCMT 2.150.5F-FF:T8330	CCMT 060202E-FF:T8330	7654257
CCMT 2.150.5F-FF:T9315	CCMT 060202E-FF:T9315	7454479
CCMT 2.150.5F-F2:T7325	CCMT 060202E-FF:T7325	7156700
CCMT 2.150.5F-F2:T8330	CCMT 060202E-FF:T8330	7156701
CCMT 2.150.5F-F2:T9315	CCMT 060202E-FF:T9315	7156702
CCMT 2.150.5F-F2:T9325	CCMT 060202E-FF:T9325	7156703
CCMT 2.150.5F-F2:T1010	CCMT 060202E-FF:T1010	7080612
CCMT 2.150.5F-FM:T7325	CCMT 060202E-FM:T7325	7156160
CCMT 2.150.5F-FM:T7335	CCMT 060202E-FM:T7335	6754732
CCMT 2.150.5F-FM:T8315	CCMT 060202E-FM:T8315	6753571
CCMT 2.150.5F-FM:T9315	CCMT 060202E-FM:T9315	6922865
CCMT 2.150.5F-FM:T9325	CCMT 060202E-FM:T9325	6753864
CCMT 2.150.5F-NF2:H07	CCMT 060202E-NF2:H07	7167422
CCMT 2.150.5F-NF2:T6310	CCMT 060202E-NF2:T6310	7167423
CCMT 2.150.5F-NF2:T7325	CCMT 060202E-NF2:T7325	7167424
CCMT 2.150.5F-NF2:T8330	CCMT 060202E-NF2:T8330	7167425
CCMT 2.150.5F-NF2:T9325	CCMT 060202E-NF2:T9325	7167426
CCMT 2.150.5F-RF:T7335	CCMT 060202E-RF:T7335	6756021
CCMT 2.150.5F-UR:T7325	CCMT 060202E-UR:T7325	7156161
CCMT 2.150.5F-UR:T7335		



ANSI	ISO	EDP
CCMT 21.51-UR:T5315	CCMT 060204E-UR:T5315	6755833
CCMT 21.51-UR:T7325	CCMT 060204E-UR:T7325	7156163
CCMT 21.51-UR:T7335	CCMT 060204E-UR:T7335	6754735
CCMT 21.51-UR:T8315	CCMT 060204E-UR:T8315	6753574
CCMT 21.51-UR:T8330	CCMT 060204E-UR:T8330	6754227
CCMT 21.51-UR:T9315	CCMT 060204E-UR:T9315	6753710
CCMT 21.51-UR:T9325	CCMT 060204E-UR:T9325	6753763
CCMT 21.51-UR:T9310	CCMT 060204E-UR:T9310	6756252
CCMT 21.51W-FM:T7325	CCMT 060204W-FM:T7325	7156164
CCMT 21.51W-FM:T8330	CCMT 060204W-FM:T8330	7033978
CCMT 21.51W-FM:T9315	CCMT 060204W-FM:T9315	7033979
CCMT 21.51W-FM:T9325	CCMT 060204W-FM:T9325	7034000
CCMT 21.51W-UR:T7310	CCMT 060204W-UR:T7310	6756253
CCMT 21.52-FM:T7325	CCMT 060208E-FM:T7325	7156165
CCMT 21.52-FM:T9315	CCMT 060208E-FM:T9315	6753804
CCMT 21.52-FM:T9325	CCMT 060208E-FM:T9325	6753868
CCMT 21.52-UR:T5315	CCMT 060208E-UR:T5315	6755834
CCMT 21.52-UR:T7325	CCMT 060208E-UR:T7325	7156166
CCMT 21.52-UR:T8330	CCMT 060208E-UR:T8330	6754228
CCMT 21.52-UR:T9315	CCMT 060208E-UR:T9315	6754677
CCMT 21.52-UR:T9325	CCMT 060208E-UR:T9325	6754667
CCMT 32.50.5-FM:T7325	CCMT 09T302E-FM:T7325	7156169
CCMT 32.50.5-FM:T7335	CCMT 09T302E-FM:T7335	6754736
CCMT 32.50.5-FM:T8315	CCMT 09T302E-FM:T8315	6753575
CCMT 32.50.5-FM:T8330	CCMT 09T302E-FM:T8330	6753648
CCMT 32.50.5-FM:T9315	CCMT 09T302E-FM:T9315	6922864
CCMT 32.50.5-FM:T9325	CCMT 09T302E-FM:T9325	6753869
CCMT 32.50.5-UR:T6310	CCMT 09T302E-UR:T6310	7763056
CCMT 32.50.5-UR:T8330	CCMT 09T302E-UR:T8330	7763057
CCMT 32.50.5-UR:T7310	CCMT 09T302E-UR:T7310	6756254
CCMT 32.51-FF:T8315	CCMT 09T304E-FF:T8315	6753577
CCMT 32.51-FF:T8330	CCMT 09T304E-FF:T8330	6754259
CCMT 32.51-FF:T9315	CCMT 09T304E-FF:T9315	7454481
CCMT 32.51-FF:T7325	CCMT 09T304E-FF:T7325	7156716
CCMT 32.51-FF:T8330	CCMT 09T304E-FF:T8330	7156717
CCMT 32.51-FF:T9315	CCMT 09T304E-FF:T9315	7156718
CCMT 32.51-FF:T9325	CCMT 09T304E-FF:T9325	7156719
CCMT 32.51-FF:T9335	CCMT 09T304E-FF:T9335	7156720
CCMT 32.51-FF:T7310	CCMT 09T304E-FF:T7310	7080610
CCMT 32.51-FM:T7325	CCMT 09T304E-FM:T7325	7156170
CCMT 32.51-FM:T7335	CCMT 09T304E-FM:T7335	6754737
CCMT 32.51-FM:T8315	CCMT 09T304E-FM:T8315	6753578
CCMT 32.51-FM:T9315	CCMT 09T304E-FM:T9315	6753711
CCMT 32.51-FM:T9325	CCMT 09T304E-FM:T9325	6753764
CCMT 32.51-FM:T6310	CCMT 09T304E-FM:T6310	7156866
CCMT 32.51-FM:T8330	CCMT 09T304E-FM:T8330	7156867
CCMT 32.51-FM:T9315	CCMT 09T304E-FM:T9315	7156868
CCMT 32.51-FM:T9325	CCMT 09T304E-FM:T9325	7156869
CCMT 32.51-NF2:H07	CCMT 09T304E-NF2:H07	7167458
CCMT 32.51-NF2:T6310	CCMT 09T304E-NF2:T6310	7167459
CCMT 32.51-NF2:T7325	CCMT 09T304E-NF2:T7325	7167460
CCMT 32.51-NF2:T8330	CCMT 09T304E-NF2:T8330	7167461
CCMT 32.51-NF2:T9315	CCMT 09T304E-NF2:T9315	7167462
CCMT 32.51-NF2:T9325	CCMT 09T304E-NF2:T9325	7167463
CCMT 32.51-NF2:T9335	CCMT 09T304E-NF2:T9335	7167464
CCMT 32.51-RF:6630	CCMT 09T304E-RF:6630	6756025
CCMT 32.51-RF:T7335	CCMT 09T304E-RF:T7335	6756026
CCMT 32.51-RM:T5305	CCMT 09T304E-RM:T5305	6755715
CCMT 32.51-RM:T5315	CCMT 09T304E-RM:T5315	6755835
CCMT 32.51-RM:T7335	CCMT 09T304E-RM:T7335	6754738
CCMT 32.51-RM:T8330	CCMT 09T304E-RM:T8330	6754390
CCMT 32.51-RM:T9315	CCMT 09T304E-RM:T9315	6753712
CCMT 32.51-RM:T9325	CCMT 09T304E-RM:T9325	6753765
CCMT 32.51-RM:T5315	CCMT 09T304E-RM:T5315	6755836
CCMT 32.51-UR:T7325	CCMT 09T304E-UR:T7325	7156171
CCMT 32.51-UR:T7335	CCMT 09T304E-UR:T7335	6754739
CCMT 32.51-UR:T8315	CCMT 09T304E-UR:T8315	6753579
CCMT 32.51-UR:T8330	CCMT 09T304E-UR:T8330	6754229
CCMT 32.51-UR:T9310	CCMT 09T304E-UR:T9310	6755616
CCMT 32.51-UR:T9315	CCMT 09T304E-UR:T9315	6753713
CCMT 32.51-UR:T9325	CCMT 09T304E-UR:T9325	6753766
CCMT 32.51-UR:T7310	CCMT 09T304E-UR:T7310	6756255
CCMT 32.51W-FM:T7325	CCMT 09T304W-FM:T7325	7156172
CCMT 32.51W-FM:T8330	CCMT 09T304W-FM:T8330	7034001
CCMT 32.51W-FM:T9315	CCMT 09T304W-FM:T9315	7034002
CCMT 32.51W-FM:T9325	CCMT 09T304W-FM:T9325	7034003

ANSI	ISO	EDP
CCMT 32.52-FF2:T7325	CCMT 09T308E-FF2:T7325	7156721
CCMT 32.52-FF2:T8330	CCMT 09T308E-FF2:T8330	7156722
CCMT 32.52-FF2:T9315	CCMT 09T308E-FF2:T9315	7156723
CCMT 32.52-FF2:T9325	CCMT 09T308E-FF2:T9325	7156724
CCMT 32.52-FF2:T7310	CCMT 09T308E-FF2:T7310	7080611
CCMT 32.52-FM:T7325	CCMT 09T308E-FM:T7325	7156173
CCMT 32.52-FM:T7335	CCMT 09T308E-FM:T7335	6754740
CCMT 32.52-FM:T8315	CCMT 09T308E-FM:T8315	6753580
CCMT 32.52-FM:T9315	CCMT 09T308E-FM:T9315	6753714
CCMT 32.52-FM:T9325	CCMT 09T308E-FM:T9325	6753767
CCMT 32.52-FM:T6310	CCMT 09T308E-FM:T6310	7156870
CCMT 32.52-FM2:T7325	CCMT 09T308E-FM2:T7325	7156871
CCMT 32.52-FM2:T8330	CCMT 09T308E-FM2:T8330	7156872
CCMT 32.52-FM2:T9315	CCMT 09T308E-FM2:T9315	7156873
CCMT 32.52-FM2:T9325	CCMT 09T308E-FM2:T9325	7156874
CCMT 32.52-FM2:T9335	CCMT 09T308E-FM2:T9335	7156875
CCMT 32.52-NF2:H07	CCMT 09T308E-NF2:H07	7167465
CCMT 32.52-NF2:T6310	CCMT 09T308E-NF2:T6310	7167466
CCMT 32.52-NF2:T7325	CCMT 09T308E-NF2:T7325	7167467
CCMT 32.52-NF2:T8330	CCMT 09T308E-NF2:T8330	7167468
CCMT 32.52-NF2:T9315	CCMT 09T308E-NF2:T9315	7167469
CCMT 32.52-NF2:T9325	CCMT 09T308E-NF2:T9325	7167470
CCMT 32.52-NF2:T9335	CCMT 09T308E-NF2:T9335	7167471
CCMT 32.52-RF:6630	CCMT 09T308E-RF:6630	6756027
CCMT 32.52-RF:T5315	CCMT 09T308E-RF:T5315	6756029
CCMT 32.52-RF:T7335	CCMT 09T308E-RF:T7335	6756028
CCMT 32.52-RM:T5305	CCMT 09T308E-RM:T5305	6755716
CCMT 32.52-RM:T5315	CCMT 09T308E-RM:T5315	6755837
CCMT 32.52-RM:T7335	CCMT 09T308E-RM:T7335	6754741
CCMT 32.52-RM:T8330	CCMT 09T308E-RM:T8330	6754391
CCMT 32.52-RM:T9315	CCMT 09T308E-RM:T9315	6753715
CCMT 32.52-RM:T9325	CCMT 09T308E-RM:T9325	6753768
CCMT 32.52-UR:T5315	CCMT 09T308E-UR:T5315	6755838
CCMT 32.52-UR:T7325	CCMT 09T308E-UR:T7325	7156174
CCMT 32.52-UR:T7335	CCMT 09T308E-UR:T7335	6754742
CCMT 32.52-UR:T8315	CCMT 09T308E-UR:T8315	6753581
CCMT 32.52-UR:T8330	CCMT 09T308E-UR:T8330	6754230
CCMT 32.52-UR:T9310	CCMT 09T308E-UR:T9310	6755617
CCMT 32.52-UR:T9315	CCMT 09T308E-UR:T9315	6753807
CCMT 32.52-UR:T9325	CCMT 09T308E-UR:T9325	6753769
CCMT 32.52-UR:T7310	CCMT 09T308E-UR:T7310	6756256
CCMT 32.52W-FM:T8330	CCMT 09T308W-FM:T8330	7034004
CCMT 32.52W-FM:T9315	CCMT 09T308W-FM:T9315	7034005
CCMT 32.52W-FM:T9325	CCMT 09T308W-FM:T9325	7034006
CCMT 32.52W-UR:T7310	CCMT 09T308W-UR:T7310	6756259
CCMT 431-FM:T7325	CCMT 120404E-FM:T7325	7156176
CCMT 431-FM:T7335	CCMT 120404E-FM:T7335	6754743
CCMT 431-FM:T8315	CCMT 120404E-FM:T8315	6753582
CCMT 431-FM:T8330	CCMT 120404E-FM:T8330	6754285
CCMT 431-FM:T9315	CCMT 120404E-FM:T9315	6753805
CCMT 431-FM:T9325	CCMT 120404E-FM:T9325	6753770
CCMT 431-RM3:T7325	CCMT 120404E-RM3:T7325	7248701
CCMT 431-RM3:T9315	CCMT 120404E-RM3:T9315	7248702
CCMT 431-RM3:T9325	CCMT 120404E-RM3:T9325	7248703
CCMT 431-UR:T5315	CCMT 120404E-UR:T5315	6755839
CCMT 431-UR:T7325	CCMT 120404E-UR:T7325	7156177
CCMT 431-UR:T8330	CCMT 120404E-UR:T8330	6754231
CCMT 431-UR:T9315	CCMT 120404E-UR:T9315	6753806
CCMT 431-UR:T9325	CCMT 120404E-UR:T9325	6753871
CCMT 432-FM:T7325	CCMT 120408E-FM:T7325	7156178
CCMT 432-FM:T7335	CCMT 120408E-FM:T7335	6754744
CCMT 432-FM:T8315	CCMT 120408E-FM:T8315	6753583
CCMT 432-FM:T8330	CCMT 120408E-FM:T8330	6754286
CCMT 432-FM:T9315	CCMT 120408E-FM:T9315	6753716
CCMT 432-FM:T9325	CCMT 120408E-FM:T9325	6753772
CCMT 432-FM2:T7325	CCMT 120408E-FM2:T7325	7156876
CCMT 432-FM2:T8330	CCMT 120408E-FM2:T8330	7156877
CCMT 432-FM2:T9325	CCMT 120408E-FM2:T9325	7156878
CCMT 432-FM2:T9335	CCMT 120408E-FM2:T9335	7156879
CCMT 432-RF:6630	CCMT 120408E-RF:6630	6756030
CCMT 432-RF:T5315	CCMT 120408E-RF:T5315	6756032
CCMT 432-RF:T7335	CCMT 120408E-RF:T7335	6756031
CCMT 432-RF:T5305	CCMT 120408E-RF:T5305	6755717
CCMT 432-RM:T5315	CCMT 120408E-RM:T5315	6755840
CCMT 432-RM:T7335	CCMT 120408E-RM:T7335	6754745
CCMT 432-RM:T8330	CCMT 120408E-RM:T8330	6754392

ANSI	ISO	EDP
CCMT 432-RM:T9315	CCMT 120408E-RM:T9315	6753717
CCMT 432-RM:T9325	CCMT 120408E-RM:T9325	6753771
CCMT 432-RM3:T6310	CCMT 120408E-RM3:T6310	7248704
CCMT 432-RM3:T7325	CCMT 120408E-RM3:T7325	7248705
CCMT 432-RM3:T9315	CCMT 120408E-RM3:T9315	7248706
CCMT 432-RM3:T9325	CCMT 120408E-RM3:T9325	7248707
CCMT 432-UR:T5315	CCMT 120408E-UR:T5315	6755841
CCMT 432-UR:T7325	CCMT 120408E-UR:T7325	7156179
CCMT 432-UR:T7335	CCMT 120408E-UR:T7335	6754746
CCMT 432-UR:T8330	CCMT 120408E-UR:T8330	6754232
CCMT 432-UR:T9315	CCMT 120408E-UR:T9315	6753808
CCMT 432-UR:T9325	CCMT 120408E-UR:T9325	6753774
CCMT 433-FM:T8330	CCMT 120412E-FM:T8330	6754287
CCMT 433-FM:T9325	CCMT 120412E-FM:T9325	6753872
CCMT 433-RM:T8330	CCMT 120412E-RM:T8330	6754393
CCMT 433-RM:T9315	CCMT 120412E-RM:T9315	6753810
CCMT 433-RM:T9325	CCMT 120412E-RM:T9325	6753873
CCMT 433-RM3:T7325	CCMT 120412E-RM3:T7325	7248708
CCMT 433-RM3:T9315	CCMT 120412E-RM3:T9315	7248709
CCMT 433-UR:T5315	CCMT 120412E-UR:T5315	6755842
CCMT 433-UR:T7325	CCMT 120412E-UR:T7325	7156181
CCMT 433-UR:T8330	CCMT 120412E-UR:T8330	6754233
CCMT 433-UR:T9315	CCMT 120412E-UR:T9315	6753811
CCMT 433-UR:T9325	CCMT 120412E-UR:T9325	6753874
CCMW 21.50.5:T5305	CCMW 060202:T5305	6755718
CCMW 21.50.5:T6310	CCMW 060202:T6310	7168643
CCMW 21.51:T5305	CCMW 060204:T5305	6755719
CCMW 21.51:T5315	CCMW 060204:T5315	6922806
CCMW 21.51:T6310	CCMW 060204:T6310	7168644
CCMW 32.51:T5305	CCMW 09T304:T5305	6755720
CCMW 32.51:T5315	CCMW 09T304:T5315	6922807
CCMW 32.51:T6310	CCMW 09T304:T6310	7168645
CCMW 32.52:T5305	CCMW 09T308:T5305	6755721
CCMW 32.52:T5315	CCMW 09T308:T5315	6922808
CCMW 32.52:T6310	CCMW 09T308:T6310	7168646
CCMW 431:T5305	CCMW 120404:T5305	6755722
CCMW 431:T5315	CCMW 120404:T5315	6922809
CCMW 431:T6310	CCMW 120404:T6310	7168645
CCMW 432:T5305	CCMW 120408:T5305	6755723
CCMW 432:T5315	CCMW 120408:T5315	6922810
CCMW 432:T6310	CCMW 120408:T6310	7168646
CNG 432 T00420:TC100	CNGN 120408 T01020:TC100	6755429
CNG 452 T00420:TC100	CNGN 120708 T01020:TC100	6755413
CNG 453 T00420:TC100	CNGN 120712 T01020:TC100	6755430
CNGA 431 T00820:TC100	CNGA 120404 T02020:TC100	6755486
CNGA 431S00420:T8310	CNGA 120404S01020B:T8310	6755923
CNGA 432 T00420:TC100	CNGA 120408 T01020:TC100	6755427
CNGA 432S00420:T8310	CNGA 120408S01020B:T8310	6755688
CNGA 433 T00420:TC100	CNGA 120412 T01020:TC100	6755428
CNGG 430.5-SF:H07	CNGG 120402E-SF:H07	6921011
CNGG 430.5-SF:T6310	CNGG 120402E-SF:T6310	6919707
CNGG 430.5-SF:T8315	CNGG 120402E-SF:T8315	6919708
CNGG 430.5-SF:T8330	CNGG 120402E-SF:T8330	6919709
CNHX 050205ER-WM:M4310	CNHX 0	

ANSI	ISO	EDP
CNMA 544-T5315	CNMA 160616-T5315	6922788
CNMA 643-T5305	CNMA 190612-T5305	6755739
CNMA 643-T5315	CNMA 190612-T5315	6922789
CNMA 643-T6310	CNMA 190612-T6310	7168658
CNMA 644-T5305	CNMA 190616-T5305	6755740
CNMA 644-T5315	CNMA 190616-T5315	6922790
CNMA 644S-T5305	CNMA 190616S-T5305	6755741
CNMG 120404E-FM:T8330	CNMG 120404E-FM:T8330	6754185
CNMG 120408E-FM:T8330	CNMG 120408E-FM:T8330	6754187
CNMG 120412E-RM:T8330	CNMG 120412E-RM:T8330	6755122
CNMG 321-FM:T7325	CNMG 090304E-FM:T7325	7156182
CNMG 321-FM:T8330	CNMG 090304E-FM:T8330	6754183
CNMG 321-FM:T9315	CNMG 090304E-FM:T9315	6753812
CNMG 321-FM:T9325	CNMG 090304E-FM:T9325	6753875
CNMG 321-NF:T6310	CNMG 090304E-NF:T6310	6922831
CNMG 321-NF:T7335	CNMG 090304E-NF:T7335	6834619
CNMG 321-NF:T8315	CNMG 090304E-NF:T8315	6834640
CNMG 321-NF:T8330	CNMG 090304E-NF:T8330	6834641
CNMG 321-NF:T9325	CNMG 090304E-NF:T9325	6834642
CNMG 322-FM:T7325	CNMG 090308E-FM:T7325	7156183
CNMG 322-FM:T8330	CNMG 090308E-FM:T8330	6754184
CNMG 322-FM:T9315	CNMG 090308E-FM:T9315	6753813
CNMG 322-FM:T9325	CNMG 090308E-FM:T9325	6753876
CNMG 322-M:T9315	CNMG 090308E-M:T9315	6753814
CNMG 322-M:T9325	CNMG 090308E-M:T9325	6753877
CNMG 322-M:T9335	CNMG 090308E-M:T9335	6754854
CNMG 322-NF:T6310	CNMG 090308E-NF:T6310	6922832
CNMG 322-NF:T7335	CNMG 090308E-NF:T7335	6834643
CNMG 322-NF:T8330	CNMG 090308E-NF:T8330	6834645
CNMG 322-NF:T9325	CNMG 090308E-NF:T9325	6834646
CNMG 322-NMR:T7325	CNMG 090308E-NMR:T7325	7156184
CNMG 322-NMR:T7335	CNMG 090308E-NMR:T7335	7038025
CNMG 322-NMR:T9325	CNMG 090308E-NMR:T9325	7038024
CNMG 431-FF:T7325	CNMG 120404E-FF:T7325	7156501
CNMG 431-FF:T8315	CNMG 120404E-FF:T8315	6753584
CNMG 431-FF:T7325	CNMG 120404E-FF:T7325	7156185
CNMG 431-FM:T7335	CNMG 120404E-FM:T7335	6754747
CNMG 431-FM:T8315	CNMG 120404E-FM:T8315	6753585
CNMG 431-FM:T9310	CNMG 120404E-FM:T9310	6755025
CNMG 431-FM:T9315	CNMG 120404E-FM:T9315	6753820
CNMG 431-FM:T9325	CNMG 120404E-FM:T9325	6753878
CNMG 431-FM:T9335	CNMG 120404E-FM:T9335	6798556
CNMG 431-SI:T7325	CNMG 120404E-SI:T7325	7156186
CNMG 431-SI:T7335	CNMG 120404E-SI:T7335	6754748
CNMG 431-SI:T8315	CNMG 120404E-SI:T8315	6922724
CNMG 431-SI:T8330	CNMG 120404E-SI:T8330	6754360
CNMG 431-SI:T9325	CNMG 120404E-SI:T9325	6753879
CNMG 431-M:T5315	CNMG 120404E-M:T5315	6755793
CNMG 431-M:T9310	CNMG 120404E-M:T9310	6755026
CNMG 431-M:T9315	CNMG 120404E-M:T9315	6753718
CNMG 431-M:T9325	CNMG 120404E-M:T9325	6753880
CNMG 431-M:T9335	CNMG 120404E-M:T9335	6754855
CNMG 431-NF:HF7	CNMG 120404E-NF:HF7	6834647
CNMG 431-NF:T6310	CNMG 120404E-NF:T6310	6922833
CNMG 431-NF:T7325	CNMG 120404E-NF:T7325	7156187
CNMG 431-NF:T7335	CNMG 120404E-NF:T7335	6834648
CNMG 431-NF:T8315	CNMG 120404E-NF:T8315	6834649
CNMG 431-NF:T8330	CNMG 120404E-NF:T8330	6834650
CNMG 431-NF:T9315	CNMG 120404E-NF:T9315	6834651
CNMG 431-NF:T9325	CNMG 120404E-NF:T9325	6834652
CNMG 431-NM:T7325	CNMG 120404E-NM:T7325	7156188
CNMG 431-NM:T7335	CNMG 120404E-NM:T7335	6754749
CNMG 431-NM:T8315	CNMG 120404E-NM:T8315	6922662
CNMG 431-NM:T8330	CNMG 120404E-NM:T8330	6754186
CNMG 431-NM:T9315	CNMG 120404E-NM:T9315	6922868
CNMG 431-NM:T9325	CNMG 120404E-NM:T9325	6753881
CNMG 431-NMR:T6310	CNMG 120404E-NMR:T6310	7454460
CNMG 431-NMR:T7325	CNMG 120404E-NMR:T7325	7156189
CNMG 431-NMR:T7335	CNMG 120404E-NMR:T7335	7038029
CNMG 431-NMR:T8330	CNMG 120404E-NMR:T8330	7038026
CNMG 431-NMR:T9315	CNMG 120404E-NMR:T9315	7038027
CNMG 431-NMR:T9325	CNMG 120404E-NMR:T9325	7038028
CNMG 431R-SI:6630	CNMG 120404E-SI:6630	6751899
CNMG 431R-SI:T7325	CNMG 120404E-SI:T7325	7156190
CNMG 431R-SI:T7335	CNMG 120404E-SI:T7335	6754750
CNMG 431R-SI:T8315	CNMG 120404E-SI:T8315	6922725

ANSI	ISO	EDP
CNMG 431R-SI:T8330	CNMG 120404E-SI:T8330	6754361
CNMG 431R-SI:T9325	CNMG 120404E-SI:T9325	6753776
CNMG 431-SF:H07	CNMG 120404E-SF:H07	6921012
CNMG 431-SF:T6310	CNMG 120404E-SF:T6310	6919751
CNMG 431-SF:T7325	CNMG 120404E-SF:T7325	7156191
CNMG 431-SF:T7335	CNMG 120404E-SF:T7335	6919752
CNMG 431-SF:T8315	CNMG 120404E-SF:T8315	6919753
CNMG 431-SF:T8330	CNMG 120404E-SF:T8330	6919754
CNMG 431-SF:T9315	CNMG 120404E-SF:T9315	7035048
CNMG 431-SF:T9325	CNMG 120404E-SF:T9325	7035049
CNMG 431-SM:T6310	CNMG 120404E-SM:T6310	6915781
CNMG 431-SM:T7325	CNMG 120404E-SM:T7325	7156192
CNMG 431-SM:T7335	CNMG 120404E-SM:T7335	6915782
CNMG 431-SM:T8330	CNMG 120404E-SM:T8330	6915783
CNMG 431-SM:T9315	CNMG 120404E-SM:T9315	6915784
CNMG 431-SM:T9325	CNMG 120404E-SM:T9325	6915785
CNMG 431W-MR:T9315	CNMG 120404W-MR:T9315	6850837
CNMG 431W-MR:T9325	CNMG 120404W-MR:T9325	6850838
CNMG 431W-NM:T7325	CNMG 120404W-NM:T7325	7156193
CNMG 431W-NM:T7335	CNMG 120404W-NM:T7335	7034007
CNMG 431W-NM:T9315	CNMG 120404W-NM:T9315	7034008
CNMG 431W-NM:T9325	CNMG 120404W-NM:T9325	7034009
CNMG 432-FF:T7325	CNMG 120408E-FF:T7325	7156502
CNMG 432-FF:T8315	CNMG 120408E-FF:T8315	6753586
CNMG 432-FM:T7325	CNMG 120408E-FM:T7325	7156194
CNMG 432-FM:T7335	CNMG 120408E-FM:T7335	6754751
CNMG 432-FM:T8315	CNMG 120408E-FM:T8315	6753587
CNMG 432-FM:T9310	CNMG 120408E-FM:T9310	6755027
CNMG 432-FM:T9315	CNMG 120408E-FM:T9315	6753719
CNMG 432-FM:T9325	CNMG 120408E-FM:T9325	6753899
CNMG 432-FM:T9335	CNMG 120408E-FM:T9335	6798557
CNMG 432-KR:T5305	CNMG 120408E-KR:T5305	6922716
CNMG 432-KR:T5315	CNMG 120408E-KR:T5315	6922717
CNMG 432L-SI:T7325	CNMG 120408L-SI:T7325	7156195
CNMG 432L-SI:T7335	CNMG 120408L-SI:T7335	6754752
CNMG 432L-SI:T8315	CNMG 120408L-SI:T8315	6922726
CNMG 432L-SI:T8330	CNMG 120408L-SI:T8330	6754362
CNMG 432L-SI:T9325	CNMG 120408L-SI:T9325	6753883
CNMG 432-M:6630	CNMG 120408E-M:6630	6751505
CNMG 432-M:6640	CNMG 120408E-M:6640	6751506
CNMG 432-M:T5305	CNMG 120408E-M:T5305	6755742
CNMG 432-M:T5315	CNMG 120408E-M:T5315	6755794
CNMG 432-M:T8330	CNMG 120408E-M:T8330	6754188
CNMG 432-M:T9310	CNMG 120408E-M:T9310	6755028
CNMG 432-M:T9315	CNMG 120408E-M:T9315	6753722
CNMG 432-M:T9325	CNMG 120408E-M:T9325	6753778
CNMG 432-M:T9335	CNMG 120408E-M:T9335	6754856
CNMG 432-NF:HF7	CNMG 120408E-NF:HF7	6834653
CNMG 432-NF:T6310	CNMG 120408E-NF:T6310	6922834
CNMG 432-NF:T7325	CNMG 120408E-NF:T7325	7156196
CNMG 432-NF:T7335	CNMG 120408E-NF:T7335	6834654
CNMG 432-NF:T8315	CNMG 120408E-NF:T8315	6834655
CNMG 432-NF:T8330	CNMG 120408E-NF:T8330	6834656
CNMG 432-NF:T9315	CNMG 120408E-NF:T9315	6834657
CNMG 432-NF:T9325	CNMG 120408E-NF:T9325	6834658
CNMG 432-NM:T7325	CNMG 120408E-NM:T7325	7156197
CNMG 432-NM:T7335	CNMG 120408E-NM:T7335	6754753
CNMG 432-NM:T8315	CNMG 120408E-NM:T8315	6922663
CNMG 432-NM:T8330	CNMG 120408E-NM:T8330	6754189
CNMG 432-NM:T9315	CNMG 120408E-NM:T9315	6922869
CNMG 432-NM:T9325	CNMG 120408E-NM:T9325	6753884
CNMG 432-NMR:T6310	CNMG 120408E-NMR:T6310	7454461
CNMG 432-NMR:T7325	CNMG 120408E-NMR:T7325	7156198
CNMG 432-NMR:T7335	CNMG 120408E-NMR:T7335	7038033
CNMG 432-NMR:T8330	CNMG 120408E-NMR:T8330	7038030
CNMG 432-NMR:T9315	CNMG 120408E-NMR:T9315	7038031
CNMG 432-NMR:T9325	CNMG 120408E-NMR:T9325	7038032
CNMG 432-NRM:T7325	CNMG 120408-NRM:T7325	7273473
CNMG 432-NRM:T7335	CNMG 120408-NRM:T7335	7273474
CNMG 432-NRM:T9315	CNMG 120408-NRM:T9315	7273472
CNMG 432-R:6630	CNMG 120408E-R:6630	6751507
CNMG 432-R:6640	CNMG 120408E-R:6640	6751508
CNMG 432-R:T5305	CNMG 120408E-R:T5305	6755743
CNMG 432-R:T5315	CNMG 120408E-R:T5315	6922748
CNMG 432-R:T9310	CNMG 120408E-R:T9310	6922942
CNMG 432-R:T9315	CNMG 120408E-R:T9315	6753720

ANSI	ISO	EDP
CNMG 432-R:T9325	CNMG 120408E-R:T9325	6753780
CNMG 432-R:T9335	CNMG 120408E-R:T9335	6754857
CNMG 432-RM:T5305	CNMG 120408E-RM:T5305	6755778
CNMG 432-RM:T5315	CNMG 120408E-RM:T5315	6755695
CNMG 432-RM:T6310	CNMG 120408E-RM:T6310	6922771
CNMG 432-RM:T7325	CNMG 120408E-RM:T7325	7156199
CNMG 432-RM:T7335	CNMG 120408E-RM:T7335	6922685
CNMG 432-RM:T8315	CNMG 120408E-RM:T8315	6753588
CNMG 432-RM:T8330	CNMG 120408E-RM:T8330	6755121
CNMG 432-RM:T9310	CNMG 120408E-RM:T9310	6755029
CNMG 432-RM:T9315	CNMG 120408E-RM:T9315	6753721
CNMG 432-RM:T9325	CNMG 120408E-RM:T9325	6753781
CNMG 432-RM:T9335	CNMG 120408E-RM:T9335	6754858
CNMG 432R-SI:6630	CNMG 120408E-SI:6630	6751900
CNMG 432R-SI:T7325	CNMG 120408E-SI:T7325	7156200
CNMG 432R-SI:T7335	CNMG 120408E-SI:T7335	6754754
CNMG 432R-SI:T8315	CNMG 120408E-SI:T8315	6922727
CNMG 432R-SI:T8330	CNMG 120408E-SI:T8330	6754363
CNMG 432R-SI:T9325	CNMG 120408E-SI:T9325	6753783
CNMG 432-SF:H07	CNMG 120408E-SF:H07	6921013
CNMG 432-SF:T6310	CNMG 120408E-SF:T6310	6919756
CNMG 432-SF:T7325	CNMG 120408E-SF:T7325	7156201
CNMG 432-SF:T7335	CNMG 120408E-SF:T7335	6919757
CNMG 432-SF:T8315	CNMG 120408E-SF:T8315	6919758
CNMG 432-SF:T8330	CNMG 120408E-SF:T8330	6919759
CNMG 432-SF:T9315	CNMG 120408E-SF:T9315	7035050
CNMG 432-SF:T9325	CNMG 120408E-SF:T9325	7035051
CNMG 432-SM:T6310	CNMG 120408E-SM:T6310	6915786
CNMG 432-SM:T7325	CNMG 120408E-SM:T7325	7156202
CNMG 432-SM:T7335	CNMG 120408E-SM:T7335	6915787
CNMG 432-SM:T8330	CNMG 120408E-SM:T8330	6915788
CNMG 432-SM:T9315	CNMG 120408E-SM:T9315	6915789
CNMG 432-SM:T9325	CNMG 120408E-SM:T9325	6915800
CNMG 432W-F:T5315	CNMG 120408W-F:T5315	6755795
CNMG 432W-F:T9315	CNMG 120408W-F:T9315	6753821
CNMG 432W-F:T9325	CNMG 120408W-F:T9325	6753886
CNMG 432W-M:T5315	CNMG 120408W-M:T5315	6755796
CNMG 432W-M:T9315	CNMG 120408W-M:T9315	6753822
CNMG 432W-M:T9325	CNMG 120408W-M:T9325	6753888
CNMG 432W-MR:T5315	CNMG 120408W-MR:T5315	6850839
CNMG 432W-MR:T9310	CNMG 120408W-MR:T9310	7035041
CNMG 432W-MR:T9315	CNMG 120408W-MR:T9315	6850880
CNMG 432W-MR:T9325	CNMG 120408W-MR:T9325	6850881
CNMG 432W-NM:T7325	CNMG 120408W-NM:T7325	7156203
CNMG 432W-NM:T7335	CNMG 120408W-NM:T7335	7034010
CNMG 432W-NM:T9315	CNMG 120408W-NM:T9315	7034011
CNMG 432W-NM:T9325	CNMG 120408W-NM:T9325	7034012
CNMG 433-FM:T7325	CNMG 120412E-FM:T7325	7156204
CNMG 433-FM:T9315	CNMG 120412E-FM:T9315	6753823
CNMG 433-FM:T9325	CNMG 120412E-FM:T9325	6753889
CNMG 433-KR:T5305	CNMG 120412E-KR:T5305	6755779
CNMG 433-KR:T5315	CNMG 120412E-KR:T5315	6755797
CNMG 433-M:6630	CNMG 120412E-M:6630	6751509
CNMG 433-M:T5305	CNMG 120412E-M:T5305	6755780
CNMG 433-M:T5315	CNMG 120412E-M:T5315	6755798
CNMG 433-M:T9310	CNMG 120412E-M:T9310	6755030
CNMG 433-M:T9315	CNMG 120412E-M:T9315	6753723
CNMG 433-M:T9325	CNMG 120412E-M:T9325	6753793
CNMG 433-M:T9335	CNMG 120412E-M:T9335	6754859
CNMG 433-NF:T6310	CNMG 120412E-NF:T6310	6922835
CNMG 433-NF:T7325	CNMG 120412E-NF:T7325	715620



ANSI	ISO	EDP
CNMG 433-NRM:T9325	CNMG 120412E-NRM:T9325	7038036
CNMG 433-NRM:T7325	CNMG 120412E-NRM:T7325	7273476
CNMG 433-NRM:T7335	CNMG 120412E-NRM:T7335	7273477
CNMG 433-NRM:T9315	CNMG 120412E-NRM:T9315	7273475
CNMG 433-R:6630	CNMG 120412E-R:6630	6751540
CNMG 433-R:T5305	CNMG 120412E-R:T5305	6755785
CNMG 433-R:T5315	CNMG 120412E-R:T5315	6922749
CNMG 433-R:T9310	CNMG 120412E-R:T9310	6922943
CNMG 433-R:T9315	CNMG 120412E-R:T9315	6753724
CNMG 433-R:T9325	CNMG 120412E-R:T9325	6753794
CNMG 433-R:T9335	CNMG 120412E-R:T9335	6754860
CNMG 433-RM:T5305	CNMG 120412E-RM:T5305	6755786
CNMG 433-RM:T5315	CNMG 120412E-RM:T5315	6755708
CNMG 433-RM:T6310	CNMG 120412E-RM:T6310	6922772
CNMG 433-RM:T7325	CNMG 120412E-RM:T7325	7156208
CNMG 433-RM:T7335	CNMG 120412E-RM:T7335	6922686
CNMG 433-RM:T8315	CNMG 120412E-RM:T8315	6753589
CNMG 433-RM:T9310	CNMG 120412E-RM:T9310	6755031
CNMG 433-RM:T9315	CNMG 120412E-RM:T9315	6753725
CNMG 433-RM:T9325	CNMG 120412E-RM:T9325	6753891
CNMG 433-RM:T9335	CNMG 120412E-RM:T9335	6754861
CNMG 433R-SI:T8330	CNMG 120412E-SI:T8330	6922678
CNMG 433-SF:T6310	CNMG 120412E-SF:T6310	6919760
CNMG 433-SF:T7325	CNMG 120412E-SF:T7325	7156510
CNMG 433-SF:T8315	CNMG 120412E-SF:T8315	6919761
CNMG 433-SF:T8330	CNMG 120412E-SF:T8330	6919762
CNMG 433-SM:T6310	CNMG 120412E-SM:T6310	6915801
CNMG 433-SM:T7325	CNMG 120412E-SM:T7325	7156209
CNMG 433-SM:T7335	CNMG 120412E-SM:T7335	6915802
CNMG 433-SM:T8330	CNMG 120412E-SM:T8330	6915803
CNMG 433-SM:T9315	CNMG 120412E-SM:T9315	6915804
CNMG 433-SM:T9325	CNMG 120412E-SM:T9325	6915805
CNMG 433W-M:T5315	CNMG 120412W-M:T5315	6755799
CNMG 433W-M:T9315	CNMG 120412W-M:T9315	6753815
CNMG 433W-M:T9325	CNMG 120412W-M:T9325	6753892
CNMG 433W-MR:T5315	CNMG 120412W-MR:T5315	6850882
CNMG 433W-MR:T9310	CNMG 120412W-MR:T9310	7035042
CNMG 433W-MR:T9315	CNMG 120412W-MR:T9315	6850883
CNMG 433W-MR:T9325	CNMG 120412W-MR:T9325	6850884
CNMG 433W-NM:T7325	CNMG 120412W-NM:T7325	7156210
CNMG 433W-NM:T7335	CNMG 120412W-NM:T7335	7034013
CNMG 433W-NM:T9315	CNMG 120412W-NM:T9315	7034014
CNMG 433W-NM:T9325	CNMG 120412W-NM:T9325	7034015
CNMG 434-M:T9325	CNMG 120416E-M:T9325	6753893
CNMG 434-M:T9335	CNMG 120416E-M:T9335	6754862
CNMG 434-NMR:T7325	CNMG 120416E-NMR:T7325	7156211
CNMG 434-NMR:T7335	CNMG 120416E-NMR:T7335	7038039
CNMG 434-NMR:T9325	CNMG 120416E-NMR:T9325	7038038
CNMG 434-NRM:T7325	CNMG 120416E-NRM:T7325	7273479
CNMG 434-NRM:T7335	CNMG 120416E-NRM:T7335	7273510
CNMG 434-NRM:T9315	CNMG 120416E-NRM:T9315	7273478
CNMG 434-R:T5315	CNMG 120416E-R:T5315	6922750
CNMG 434-R:T9335	CNMG 120416E-R:T9335	6922751
CNMG 434-RM:T5305	CNMG 120416E-RM:T5305	6755788
CNMG 434-RM:T5315	CNMG 120416E-RM:T5315	6755800
CNMG 434-RM:T7325	CNMG 120416E-RM:T7325	7156212
CNMG 434-RM:T7335	CNMG 120416E-RM:T7335	6922687
CNMG 434-RM:T8330	CNMG 120416E-RM:T8330	6755123
CNMG 434-RM:T9310	CNMG 120416E-RM:T9310	6755032
CNMG 434-RM:T9315	CNMG 120416E-RM:T9315	6753816
CNMG 434-RM:T9325	CNMG 120416E-RM:T9325	6753894
CNMG 434-RM:T9335	CNMG 120416E-RM:T9335	6754863
CNMG 542-M:6630	CNMG 160608E-M:6630	6751541
CNMG 542-M:T9310	CNMG 160608E-M:T9310	6755033
CNMG 542-M:T9315	CNMG 160608E-M:T9315	6753817
CNMG 542-M:T9325	CNMG 160608E-M:T9325	6753895
CNMG 542-M:T9335	CNMG 160608E-M:T9335	6754864
CNMG 542-NM:T7325	CNMG 160608E-NM:T7325	7156213
CNMG 542-NM:T7335	CNMG 160608E-NM:T7335	6754756
CNMG 542-NM:T8315	CNMG 160608E-NM:T8315	6922665
CNMG 542-NM:T8330	CNMG 160608E-NM:T8330	6755108
CNMG 542-NM:T9325	CNMG 160608E-NM:T9325	6753896
CNMG 542-NMR:T7325	CNMG 160608E-NMR:T7325	7156214
CNMG 542-NMR:T7335	CNMG 160608E-NMR:T7335	7038042
CNMG 542-NMR:T9315	CNMG 160608E-NMR:T9315	7038040
CNMG 542-NMR:T9325	CNMG 160608E-NMR:T9325	7038041

ANSI	ISO	EDP
CNMG 542-NRM:T7325	CNMG 160608E-NRM:T7325	7273512
CNMG 542-NRM:T7335	CNMG 160608E-NRM:T7335	7273513
CNMG 542-NRM:T9315	CNMG 160608E-NRM:T9315	7273511
CNMG 542-R:T5315	CNMG 160608E-R:T5315	6922752
CNMG 542-RM:T5305	CNMG 160608E-RM:T5305	6755789
CNMG 542-RM:T5315	CNMG 160608E-RM:T5315	6755803
CNMG 542-RM:T8330	CNMG 160608E-RM:T8330	6755124
CNMG 542-RM:T9315	CNMG 160608E-RM:T9315	6753818
CNMG 542-RM:T9325	CNMG 160608E-RM:T9325	6753897
CNMG 542-RM:T9335	CNMG 160608E-RM:T9335	6754865
CNMG 542-SM:T7325	CNMG 160608E-SM:T7325	7156216
CNMG 542-SM:T7335	CNMG 160608E-SM:T7335	6915806
CNMG 542-SM:T8330	CNMG 160608E-SM:T8330	6915807
CNMG 542-SM:T9325	CNMG 160608E-SM:T9325	6915808
CNMG 543-M:T9315	CNMG 160612E-M:T9315	6753819
CNMG 543-M:T9325	CNMG 160612E-M:T9325	6753898
CNMG 543-M:T9335	CNMG 160612E-M:T9335	6754866
CNMG 543-NM:T7325	CNMG 160612E-NM:T7325	7156217
CNMG 543-NM:T7335	CNMG 160612E-NM:T7335	6754757
CNMG 543-NM:T8315	CNMG 160612E-NM:T8315	6922666
CNMG 543-NM:T9325	CNMG 160612E-NM:T9325	6753900
CNMG 543-NMR:T7325	CNMG 160612E-NMR:T7325	7156218
CNMG 543-NMR:T7335	CNMG 160612E-NMR:T7335	7038046
CNMG 543-NMR:T8330	CNMG 160612E-NMR:T8330	7038043
CNMG 543-NMR:T9315	CNMG 160612E-NMR:T9315	7038044
CNMG 543-NMR:T9325	CNMG 160612E-NMR:T9325	7038045
CNMG 543-NRM:T7325	CNMG 160612E-NRM:T7325	7273515
CNMG 543-NRM:T7335	CNMG 160612E-NRM:T7335	7273516
CNMG 543-NRM:T9315	CNMG 160612E-NRM:T9315	7273514
CNMG 543-R:6630	CNMG 160612E-R:6630	6751542
CNMG 543-R:T5305	CNMG 160612E-R:T5305	6755790
CNMG 543-R:T5315	CNMG 160612E-R:T5315	6922753
CNMG 543-R:T7335	CNMG 160612E-R:T7335	7763058
CNMG 543-R:T9310	CNMG 160612E-R:T9310	6922944
CNMG 543-R:T9315	CNMG 160612E-R:T9315	6753726
CNMG 543-R:T9325	CNMG 160612E-R:T9325	6753901
CNMG 543-RM:T5305	CNMG 160612E-RM:T5305	6755791
CNMG 543-RM:T5315	CNMG 160612E-RM:T5315	6755804
CNMG 543-RM:T6310	CNMG 160612E-RM:T6310	6922773
CNMG 543-RM:T7325	CNMG 160612E-RM:T7325	7156219
CNMG 543-RM:T7335	CNMG 160612E-RM:T7335	6922689
CNMG 543-RM:T8330	CNMG 160612E-RM:T8330	6755125
CNMG 543-RM:T9310	CNMG 160612E-RM:T9310	6755034
CNMG 543-RM:T9315	CNMG 160612E-RM:T9315	6753824
CNMG 543-RM:T9325	CNMG 160612E-RM:T9325	6753902
CNMG 543-RM:T9335	CNMG 160612E-RM:T9335	6754867
CNMG 543-SM:T6310	CNMG 160612E-SM:T6310	6915809
CNMG 543-SM:T7325	CNMG 160612E-SM:T7325	7156220
CNMG 543-SM:T7335	CNMG 160612E-SM:T7335	6915810
CNMG 543-SM:T9315	CNMG 160612E-SM:T9315	6915811
CNMG 543-SM:T9325	CNMG 160612E-SM:T9325	6915812
CNMG 544-M:T9325	CNMG 160616E-M:T9325	6753903
CNMG 544-M:T9335	CNMG 160616E-M:T9335	6754868
CNMG 544-NMR:T7325	CNMG 160616E-NMR:T7325	7156221
CNMG 544-NMR:T7335	CNMG 160616E-NMR:T7335	7038049
CNMG 544-NMR:T8330	CNMG 160616E-NMR:T8330	7038047
CNMG 544-NMR:T9315	CNMG 160616E-NMR:T9315	7763059
CNMG 544-NMR:T9325	CNMG 160616E-NMR:T9325	7038048
CNMG 544-NRM:T7325	CNMG 160616E-NRM:T7325	7273518
CNMG 544-NRM:T7335	CNMG 160616E-NRM:T7335	7273519
CNMG 544-NRM:T9315	CNMG 160616E-NRM:T9315	7273517
CNMG 544-R:T5305	CNMG 160616E-R:T5305	6755792
CNMG 544-RM:T5305	CNMG 160616E-RM:T5305	6755809
CNMG 544-RM:T5315	CNMG 160616E-RM:T5315	6755805
CNMG 544-RM:T7325	CNMG 160616E-RM:T7325	7156222
CNMG 544-RM:T7335	CNMG 160616E-RM:T7335	6922690
CNMG 544-RM:T9310	CNMG 160616E-RM:T9310	6755035
CNMG 544-RM:T9315	CNMG 160616E-RM:T9315	6753825
CNMG 544-RM:T9325	CNMG 160616E-RM:T9325	6753904
CNMG 544-RM:T9335	CNMG 160616E-RM:T9335	6754869
CNMG 642-M:6630	CNMG 190608E-M:6630	6751543
CNMG 642-M:T9315	CNMG 190608E-M:T9315	6753826
CNMG 642-M:T9325	CNMG 190608E-M:T9325	6753905
CNMG 642-M:T9335	CNMG 190608E-M:T9335	6754870
CNMG 642-NMR:T6310	CNMG 190608E-NMR:T6310	7454463
CNMG 642-NMR:T7325	CNMG 190608E-NMR:T7325	7156223

ANSI	ISO	EDP
CNMG 642-NMR:T7335	CNMG 190608E-NMR:T7335	7038052
CNMG 642-NMR:T9315	CNMG 190608E-NMR:T9315	7038050
CNMG 642-NMR:T9325	CNMG 190608E-NMR:T9325	7038051
CNMG 642-NRM:T7325	CNMG 190608E-NRM:T7325	7273521
CNMG 642-NRM:T7335	CNMG 190608E-NRM:T7335	7273522
CNMG 642-NRM:T9315	CNMG 190608E-NRM:T9315	7273520
CNMG 642-R:T5315	CNMG 190608E-R:T5315	6922754
CNMG 642-RM:T5305	CNMG 190608E-RM:T5305	6755810
CNMG 642-RM:T5315	CNMG 190608E-RM:T5315	6755806
CNMG 642-RM:T7335	CNMG 190608E-RM:T7335	6922691
CNMG 642-RM:T9315	CNMG 190608E-RM:T9315	6753827
CNMG 642-RM:T9325	CNMG 190608E-RM:T9325	6753906
CNMG 642-RM:T9335	CNMG 190608E-RM:T9335	6754871
CNMG 643-M:6630	CNMG 190612E-M:6630	6751545
CNMG 643-M:6640	CNMG 190612E-M:6640	6751546
CNMG 643-M:T9310	CNMG 190612E-M:T9310	6755036
CNMG 643-M:T9315	CNMG 190612E-M:T9315	6753828
CNMG 643-M:T9325	CNMG 190612E-M:T9325	6753795
CNMG 643-M:T9335	CNMG 190612E-M:T9335	6754872
CNMG 643-NM:T7325	CNMG 190612E-NM:T7325	7156225
CNMG 643-NM:T7335	CNMG 190612E-NM:T7335	6754758
CNMG 643-NM:T8315	CNMG 190612E-NM:T8315	6922667
CNMG 643-NM:T8330	CNMG 190612E-NM:T8330	6755109
CNMG 643-NM:T9325	CNMG 190612E-NM:T9325	6753907
CNMG 643-NMR:T6310	CNMG 190612E-NMR:T6310	7462039
CNMG 643-NMR:T7325	CNMG 190612E-NMR:T7325	7156226
CNMG 643-NMR:T7335	CNMG 190612E-NMR:T7335	7038056
CNMG 643-NMR:T8330	CNMG 190612E-NMR:T8330	7038053
CNMG 643-NMR:T9315	CNMG 190612E-NMR:T9315	7038054
CNMG 643-NMR:T9325	CNMG 190612E-NMR:T9325	7038055
CNMG 643-NRM:T7325	CNMG 190612E-NRM:T7325	7273524
CNMG 643-NRM:T7335	CNMG 190612E-NRM:T7335	7273525
CNMG 643-NRM:T9315	CNMG 190612E-NRM:T9315	7273523
CNMG 643-R:6630	CNMG 190612E-R:6630	6751547
CNMG 643-R:6640	CNMG 190612E-R:6640	6751548
CNMG 643-R:T5305	CNMG 190612E-R:T5305	6755811
CNMG 643-R:T5315	CNMG 190612E-R:T5315	6922755
CNMG 643-R:T9315	CNMG 190612E-R:T9315	6922871
CNMG 643-R:T9325	CNMG 190612E-R:T9325	6753796
CNMG 643-R:T9335	CNMG 190612E-R:T9335	6754873
CNMG 643-RM:T5305	CNMG 190612E-RM:T5305	6755812
CNMG 643-RM:T5315	CNMG 190612E-RM:T5315	6922774
CNMG 643-RM:T7325	CNMG 190612E-RM:T7325	7156227
CNMG 643-RM:T7335	CNMG 190612E-RM:T7335	6922692
CNMG 643-RM:T8330	CNMG 190612E-RM:T8330	6755126
CNMG 643-RM:T9310	CNMG 190612E-RM:T9310	6755037
CNMG 643-RM:T9315	CNMG 190612E-RM:T9315	6754069
CNMG 643-RM:T9325	CNMG 190612E-RM:T9325	6753908
CNMG 643-RM:T9335	CNMG 190612E-RM:T9335	6754874
CNMG 643-SM:T6310	CNMG 190612E-SM:T6310	6915813
CNMG 643-SM:T7325	CNMG 190612E-SM:T7325	7156228
CNMG 643-SM:T7335	CNMG 190612E-SM:T7335	6915814
CNMG 643-SM:T9315	CNMG 190612E-SM:T9315	6915815
CNMG 643-SM:T9325	CNMG 190612E-SM:T9325	6915816
CNMG 644-M:T9310	CNMG 190616E-M:T9310	6755038
CNMG 644-M:T9315	CNMG 190616E-M:T9315	6753727
CNMG 644-M:T9325	CNMG 190616E-M:T9325	6753909
CNMG 644-M:T9335	CNMG 190616E-M:T9335	6754875
CNMG 644-NMR:T7325	CNMG 190616E-NMR:T7325	7156229
CNMG 644-NMR:T7335	CNMG 190616E-NMR:T7335	7038059
CNMG 644-NMR:T9315	CNMG 190616E-NMR:T9315	703805

ANSI	ISO	EDP
CNMG 644-RM:T6310	CNMG 190616E-RM:T6310	6922775
CNMG 644-RM:T7325	CNMG 190616E-RM:T7325	7156230
CNMG 644-RM:T7335	CNMG 190616E-RM:T7335	6922693
CNMG 644-RM:T9310	CNMG 190616E-RM:T9310	6755039
CNMG 644-RM:T9315	CNMG 190616E-RM:T9315	6754078
CNMG 644-RM:T9325	CNMG 190616E-RM:T9325	6753910
CNMG 644-RM:T9335	CNMG 190616E-RM:T9335	6754877
CNMG 866-NRM:T7325	CNMG 250924-NRM:T7325	7273542
CNMG 866-NRM:T7335	CNMG 250924-NRM:T7335	7273543
CNMG 866-NRM:T9315	CNMG 250924-NRM:T9315	7273541
CNMG 866-NRM:T7325	CNMG 250924E-NRM:T7325	7156231
CNMG 866-NRM:T7335	CNMG 250924E-NRM:T7335	6922694
CNMG 866-NRM:T9315	CNMG 250924E-NRM:T9315	6931844
CNMG 866-NRM:T9325	CNMG 250924E-NRM:T9325	6754081
CNMG 866-NRM:T9335	CNMG 250924E-NRM:T9335	6753911
CNMG 866-NRM:T9335	CNMG 250924E-RM:T9335	6754878
CNMM 432-NR:6630	CNMM 120408E-NR:6630	6751596
CNMM 432-NR:6640	CNMM 120408E-NR:6640	6751597
CNMM 432-NR:T7325	CNMM 120408E-NR:T7325	7156232
CNMM 432-NR:T7335	CNMM 120408E-NR:T7335	6754759
CNMM 432-NR:T8330	CNMM 120408E-NR:T8330	6754205
CNMM 432-NR:T9315	CNMM 120408E-NR:T9315	6922872
CNMM 432-NR:T9325	CNMM 120408E-NR:T9325	6753912
CNMM 432-NR:T7325	CNMM 120408E-NR:T7325	7156233
CNMM 432-NR:T7335	CNMM 120408E-NR:T7335	6754760
CNMM 432-NR:T8330	CNMM 120408E-NR:T8330	6755133
CNMM 432-NR:T9315	CNMM 120408E-NR:T9315	6922873
CNMM 432-NR:T9325	CNMM 120408E-NR:T9325	6753913
CNMM 432-NR:T9335	CNMM 120408E-NR:T9335	6755146
CNMM 432-OR:T9315	CNMM 120408E-OR:T9315	6754083
CNMM 432-OR:T9325	CNMM 120408E-OR:T9325	6753914
CNMM 432-OR:T9335	CNMM 120408E-OR:T9335	6754879
CNMM 433-NR:T7325	CNMM 120412E-NR:T7325	7156234
CNMM 433-NR:T7335	CNMM 120412E-NR:T7335	6754761
CNMM 433-NR:T8330	CNMM 120412E-NR:T8330	6754206
CNMM 433-NR:T9315	CNMM 120412E-NR:T9315	6753915
CNMM 433-NR:T9325	CNMM 120412E-NR:T9325	6754762
CNMM 433-NR:T9335	CNMM 120412E-NR:T9335	6755134
CNMM 433-NR:T8330	CNMM 120412E-NR:T8330	6755134
CNMM 433-NR:T9315	CNMM 120412E-NR:T9315	6922875
CNMM 433-NR:T9325	CNMM 120412E-NR:T9325	6753916
CNMM 433-OR:T9315	CNMM 120412E-OR:T9315	6754084
CNMM 433-OR:T9325	CNMM 120412E-OR:T9325	6753917
CNMM 433-OR:T9335	CNMM 120412E-OR:T9335	6754880
CNMM 434-OR:T9325	CNMM 120416E-OR:T9325	6754484
CNMM 434-OR:T9335	CNMM 120416E-OR:T9335	6754881
CNMM 542-NR:T8330	CNMM 160608E-NR:T8330	6755135
CNMM 542-NR:T9315	CNMM 160608E-NR:T9315	6753918
CNMM 542-OR:T9315	CNMM 160608E-OR:T9315	6754093
CNMM 542-OR:T9325	CNMM 160608E-OR:T9325	6753919
CNMM 542-OR:T9335	CNMM 160608E-OR:T9335	6754882
CNMM 543-DR:T9315	CNMM 160612E-DR:T9315	6922876
CNMM 543-DR:T9325	CNMM 160612E-DR:T9325	6753920
CNMM 543-DR:T9335	CNMM 160612E-DR:T9335	6754883
CNMM 543-NR:T7325	CNMM 160612E-NR:T7325	7156237
CNMM 543-NR:T7335	CNMM 160612E-NR:T7335	6754764
CNMM 543-NR:T8330	CNMM 160612E-NR:T8330	6755136
CNMM 543-NR:T9315	CNMM 160612E-NR:T9315	6922877
CNMM 543-NR:T9325	CNMM 160612E-NR:T9325	6753921
CNMM 543-OR:T8330	CNMM 160612E-OR:T8330	6755147
CNMM 543-OR:T9315	CNMM 160612E-OR:T9315	6754097
CNMM 543-OR:T9325	CNMM 160612E-OR:T9325	6753922
CNMM 544-NR:T7325	CNMM 160616E-NR:T7325	7156238
CNMM 544-NR:T7335	CNMM 160616E-NR:T7335	6754765
CNMM 544-NR:T9315	CNMM 160616E-NR:T9315	6753923
CNMM 544-OR:T9315	CNMM 160616E-OR:T9315	6754098
CNMM 544-OR:T9325	CNMM 160616E-OR:T9325	6753924
CNMM 642-DR:T9315	CNMM 190608E-DR:T9315	6922878
CNMM 642-DR:T9325	CNMM 190608E-DR:T9325	6753925
CNMM 643-DR:6630	CNMM 190612E-DR:6630	6751599
CNMM 643-DR:T9315	CNMM 190612E-DR:T9315	6922879
CNMM 643-DR:T9325	CNMM 190612E-DR:T9325	6753926
CNMM 643-DR:T9335	CNMM 190612E-DR:T9335	6754885
CNMM 643-NR:T7325	CNMM 190612E-NR:T7325	7156239
CNMM 643-NR:T7335	CNMM 190612E-NR:T7335	6754766
CNMM 643-NR:T8330	CNMM 190612E-NR:T8330	6755137
CNMM 643-NR:T9325	CNMM 190612E-NR:T9325	6753927

ANSI	ISO	EDP
CNMM 643-OR:6630	CNMM 190612E-OR:6630	6752101
CNMM 643-OR:T8330	CNMM 190612E-OR:T8330	6755148
CNMM 643-OR:T9315	CNMM 190612E-OR:T9315	6754108
CNMM 643-OR:T9325	CNMM 190612E-OR:T9325	6753928
CNMM 643-OR:T9335	CNMM 190612E-OR:T9335	6754886
CNMM 644-DR:T9325	CNMM 190616E-DR:T9325	6753929
CNMM 644-DR:T9335	CNMM 190616E-DR:T9335	6754887
CNMM 644-HR:6630	CNMM 190616E-HR:6630	6751594
CNMM 644-HR:6640	CNMM 190616E-HR:6640	6751586
CNMM 644-HR:T8345	CNMM 190616E-HR:T8345	6753678
CNMM 644-HR:T9325	CNMM 190616E-HR:T9325	6753798
CNMM 644-HR:T9335	CNMM 190616E-HR:T9335	6754888
CNMM 644-HR:T9226	CNMM 190616E-HR:T9226	7036347
CNMM 644-HR:T9315	CNMM 190616E-HR:T9315	7036346
CNMM 644-HR:T9335	CNMM 190616E-HR:T9335	7036348
CNMM 644-NR:T7325	CNMM 190616E-NR:T7325	7156240
CNMM 644-NR:T7335	CNMM 190616E-NR:T7335	6754767
CNMM 644-NR:T8330	CNMM 190616E-NR:T8330	6755138
CNMM 644-NR:T9315	CNMM 190616E-NR:T9315	6922883
CNMM 644-NR:T9325	CNMM 190616E-NR:T9325	6753930
CNMM 644-OR:6630	CNMM 190616E-OR:6630	6752090
CNMM 644-OR:T8330	CNMM 190616E-OR:T8330	6755149
CNMM 644-OR:T8345	CNMM 190616E-OR:T8345	6753680
CNMM 644-OR:T9315	CNMM 190616E-OR:T9315	6753729
CNMM 644-OR:T9325	CNMM 190616E-OR:T9325	6753799
CNMM 644-OR:T9335	CNMM 190616E-OR:T9335	6754889
CNMM 644-OR1:6630	CNMM 190616E-OR1:6630	6752024
CNMM 644-OR1:T9325	CNMM 190616E-OR1:T9325	6753800
CNMM 644-OR1:T9335	CNMM 190616E-OR1:T9335	6754890
CNMM 646-HR:6630	CNMM 190624E-HR:6630	6751593
CNMM 646-HR:T8345	CNMM 190624E-HR:T8345	6753679
CNMM 646-HR:T9315	CNMM 190624E-HR:T9315	6922884
CNMM 646-HR:T9325	CNMM 190624E-HR:T9325	6753801
CNMM 646-HR:T9335	CNMM 190624E-HR:T9335	6754891
CNMM 646-HR:T9226	CNMM 190624E-HR:T9226	7036350
CNMM 646-HR:T9315	CNMM 190624E-HR:T9315	7036349
CNMM 646-HR:T9335	CNMM 190624E-HR:T9335	7036351
CNMM 646-NR:T7335	CNMM 190624E-NR:T7335	6754768
CNMM 646-NR:T9315	CNMM 190624E-NR:T9315	6753931
CNMM 646-OR:T9315	CNMM 190624E-OR:T9315	6754110
CNMM 646-OR:T9325	CNMM 190624E-OR:T9325	6753932
CNMM 866-923:T8330	CNMM 250924S-923:T8330	6754254
CNMM 866-923:T9335	CNMM 250924S-923:T9335	6754894
CNMM 866-HR:6630	CNMM 250924E-HR:6630	6751615
CNMM 866-HR:6640	CNMM 250924E-HR:6640	6751616
CNMM 866-HR:T8345	CNMM 250924E-HR:T8345	6753681
CNMM 866-HR:T9315	CNMM 250924E-HR:T9315	6933562
CNMM 866-HR:T9325	CNMM 250924E-HR:T9325	6753802
CNMM 866-HR:T9335	CNMM 250924E-HR:T9335	6754892
CNMM 866-HR:T9315	CNMM 250924E-HR:T9315	7015714
CNMM 866-HR:T9335	CNMM 250924E-HR:T9335	7015716
CNMM 866-NR:T7325	CNMM 250924E-NR:T7325	7156242
CNMM 866-NR:T7335	CNMM 250924E-NR:T7335	6754769
CNMM 866-NR:T8330	CNMM 250924E-NR:T8330	6755139
CNMM 866-NR:T9315	CNMM 250924E-NR:T9315	6933563
CNMM 866-NR:T9325	CNMM 250924E-NR:T9325	6754885
CNMM 866-NRM:T7325	CNMM 250924-NRM:T7325	7273560
CNMM 866-NRM:T7335	CNMM 250924-NRM:T7335	7273561
CNMM 866-NRM:T9315	CNMM 250924-NRM:T9315	7273559
CNMM 866-OR:6630	CNMM 250924E-OR:6630	6752128
CNMM 866-OR:T8330	CNMM 250924E-OR:T8330	6755150
CNMM 866-OR:T9315	CNMM 250924E-OR:T9315	6753730
CNMM 866-OR:T9325	CNMM 250924E-OR:T9325	6754886
CNMM 866-OR:T9335	CNMM 250924E-OR:T9335	6754893
CNMX 6-10SN-RF:T9315	CNMX 191140SN-RF:T9315	6798532
CNMX 6-10SN-RF:T9325	CNMX 191140SN-RF:T9325	6798533
CNMX 6-10SN-TF:T5315	CNMX 191140SN-TF:T5315	6798530
CNMX 6-10SN-TF:T9310	CNMX 191140SN-TF:T9310	6798526
CNMX 6-10SN-TF:T9315	CNMX 191140SN-TF:T9315	6798527
CNMX 6-10SN-TF:T9325	CNMX 191140SN-TF:T9325	6798528
CNMX 6510SN-RF:T5315	CNMX 190740SN-RF:T5315	6755943
CNMX 6510SN-RF:T9315	CNMX 190740SN-RF:T9315	6755944
CPGX 2.521FL-JQ:T010	CPGX 080304FL-JQ:T010	7080619
CPGX 2.521FL-JR:T010	CPGX 080304FL-JR:T010	7080620
CPGX 2.521FR-JQ:T010	CPGX 080304FR-JQ:T010	7080621
CPGX 2.521FR-JR:T010	CPGX 080304FR-JR:T010	7080622

ANSI	ISO	EDP
CPGX 21.50.5FL-JZ:T010	CPGX 060202FL-JZ:T010	7080615
CPGX 21.50.5FR-JZ:T010	CPGX 060202FR-JZ:T010	7080616
CPGX 21.51FL-JR:T010	CPGX 060204FL-JR:T010	7080617
CPGX 21.51FR-JR:T010	CPGX 060204FR-JR:T010	7080618
CPGX 32.51FL-JQ:T010	CPGX 09T304FL-JQ:T010	7080614
DCGT 21.50.2-SF3:T6310	DCGT 070201E-SF3:T6310	7600315
DCGT 21.50.5F-AL:HF7	DCGT 070202F-AL:HF7	6752064
DCGT 21.50.5F-AL:T0315	DCGT 070202F-AL:T0315	6756145
DCGT 21.50.5-SF3:H07	DCGT 070202E-SF3:H07	7168556
DCGT 21.50.5-SF3:T6310	DCGT 070202E-SF3:T6310	7168557
DCGT 21.50.5-SF3:T8315	DCGT 070202E-SF3:T8315	7168558
DCGT 21.51F-AL:HF7	DCGT 070204F-AL:HF7	6751734
DCGT 21.51F-AL:T0315	DCGT 070204F-AL:T0315	6756146
DCGT 21.51-SF3:H07	DCGT 070204E-SF3:H07	7168559
DCGT 21.51-SF3:T6310	DCGT 070204E-SF3:T6310	7168560
DCGT 21.51-SF3:T8315	DCGT 070204E-SF3:T8315	7168561
DCGT 32.50.2-SF3:T6310	DCGT 11T301E-SF3:T6310	7600316
DCGT 32.50.5F-AL:HF7	DCGT 11T302F-AL:HF7	6752066
DCGT 32.50.5F-AL:T0315	DCGT 11T302F-AL:T0315	6756147
DCGT 32.50.5-FF2:T7325	DCGT 11T302E-FF2:T7325	7156725
DCGT 32.50.5-FF2:T8330	DCGT 11T302E-FF2:T8330	7156726
DCGT 32.50.5-FF2:T9325	DCGT 11T302E-FF2:T9325	7156727
DCGT 32.50.5-FF2:T010	DCGT 11T302E-FF2:T010	7080623
DCGT 32.50.5-SF3:H07	DCGT 11T302E-SF3:H07	7168562
DCGT 32.50.5-SF3:T6310	DCGT 11T302E-SF3:T6310	7168563
DCGT 32.51F-AL:HF7	DCGT 11T304F-AL:HF7	6751736
DCGT 32.51F-AL:T0315	DCGT 11T304F-AL:T0315	6756148
DCGT 32.51-SI:T8330	DCGT 11T304E-SI:T8330	6926941
DCGT 32.51-NF1:T6310	DCGT 11T304E-NF1:T6310	7167407
DCGT 32.51-NF1:T7325	DCGT 11T304E-NF1:T7325	7167408
DCGT 32.51R-SI:T8330	DCGT 11T304E-SI:T8330	6926942
DCGT 32.51-SF3:H07	DCGT 11T304E-SF3:H07	7168564
DCGT 32.51-SF3:T6310	DCGT 11T304E-SF3:T6310	7168565
DCGT 32.51-SF3:T8315	DCGT 11T304E-SF3:T8315	7168566
DCGT 32.52F-AL:HF7	DCGT 11T308F-AL:HF7	6752068
DCGT 32.52F-AL:T0315	DCGT 11T308F-AL:T0315	6756149
DCGT 32.52-SI:T8330	DCGT 11T308E-SI:T8330	6926943
DCGT 32.52-NF1:T6310	DCGT 11T308E-NF1:T6310	7167410
DCGT 32.52-NF1:T7325	DCGT 11T308E-NF1:T7325	7167411
DCGT 32.52R-SI:T8330	DCGT 11T308E-SI:T8330	6926944
DCGT 32.52-SF3:H07	DCGT 11T308E-SF3:H07	7168567
DCGT 32.52-SF3:T6310	DCGT 11T308E-SF3:T6310	7168568
DCGT 32.52-SF3:T8315	DCGT 11T308E-SF3:T8315	7168569
DCGW 32.51S004020:T8310	DCGW 11T304S01020B:T8310	6755686
DCGW 32.52S004020:T8310	DCGW 11T308S01020B:T8310	6755924
DCMT 11T302E-FM:T8330	DCMT 11T302E-FM:T8330	6753651
DCMT 11T304E-FM:T8330	DCMT 11T304E-FM:T8330	6754288
DCMT 11T308E-FM:T8330	DCMT 11T308E-FM:T8330	6754289
DCMT 21.50.5-FF2:T7325	DCMT 070202E-FF2:T7325	7156728
DCMT 21.50.5-FF2:T8330	DCMT 070202E-FF2:T8330	7156729
DCMT 21.50.5-FF2:T9325	DCMT 070202E-FF2:T9325	7156730
DCMT 21.50.5-FF2:T010	DCMT 070202E-FF2:T010	7080626
DCMT 21.50.5-FM:T7325	DCMT 070202E-FM:T7325	7156243
DCMT 21.50.5-FM:T8315	DCMT 070202E-FM:T8315	6753612
DCMT 21.50.5-FM:T8330	DCMT 07	

ANSI	ISO	EDP
DCMT 21.51-FM2:T9325	DCMT 070204E-FM2:T9325	7156884
DCMT 21.51-UR:T7325	DCMT 070204E-UR:T7325	7156246
DCMT 21.51-UR:T8315	DCMT 070204E-UR:T8315	6753593
DCMT 21.51-UR:T8330	DCMT 070204E-UR:T8330	6754238
DCMT 21.51-UR:T9315	DCMT 070204E-UR:T9315	6754057
DCMT 21.51-UR:T9325	DCMT 070204E-UR:T9325	6753777
DCMT 21.51-UR:TT310	DCMT 070204E-UR:TT310	6756260
DCMT 21.52-FF2:T7325	DCMT 070208E-FF2:T7325	7156735
DCMT 21.52-FF2:T8330	DCMT 070208E-FF2:T8330	7156736
DCMT 21.52-FF2:T9315	DCMT 070208E-FF2:T9315	7156737
DCMT 21.52-FF2:T9325	DCMT 070208E-FF2:T9325	7156738
DCMT 32.50-5-FF:T8315	DCMT 11T302E-FF:T8315	6753590
DCMT 32.50-5-FF:T8330	DCMT 11T302E-FF:T8330	6754260
DCMT 32.50-5-FF:T9315	DCMT 11T302E-FF:T9315	7454482
DCMT 32.50-5-FM:T7325	DCMT 11T302E-FM:T7325	7156247
DCMT 32.50-5-FM:T8315	DCMT 11T302E-FM:T8315	6753594
DCMT 32.50-5-FM:T9315	DCMT 11T302E-FM:T9315	6922886
DCMT 32.50-5-FM:T9325	DCMT 11T302E-FM:T9325	6753934
DCMT 32.50-5-UR:T7325	DCMT 11T302E-UR:T7325	7156248
DCMT 32.50-5-UR:T8330	DCMT 11T302E-UR:T8330	6754234
DCMT 32.50-5-UR:T9315	DCMT 11T302E-UR:T9315	6922887
DCMT 32.50-5-UR:T9325	DCMT 11T302E-UR:T9325	6753935
DCMT 32.50-5-UR:TT310	DCMT 11T302E-UR:TT310	6756275
DCMT 32.51-FF:T8315	DCMT 11T304E-FF:T8315	6753595
DCMT 32.51-FF:T8330	DCMT 11T304E-FF:T8330	6754261
DCMT 32.51-FF:T9315	DCMT 11T304E-FF:T9315	7454483
DCMT 32.51-FF2:T7325	DCMT 11T304E-FF2:T7325	7156739
DCMT 32.51-FF2:T8330	DCMT 11T304E-FF2:T8330	7156740
DCMT 32.51-FF2:T9315	DCMT 11T304E-FF2:T9315	7156741
DCMT 32.51-FF2:T9325	DCMT 11T304E-FF2:T9325	7156742
DCMT 32.51-FF2:T9335	DCMT 11T304E-FF2:T9335	7156743
DCMT 32.51-FF2:TT010	DCMT 11T304E-FF2:TT010	7080624
DCMT 32.51-FM:T7325	DCMT 11T304E-FM:T7325	7156249
DCMT 32.51-FM:T7335	DCMT 11T304E-FM:T7335	6754771
DCMT 32.51-FM:T8315	DCMT 11T304E-FM:T8315	6753596
DCMT 32.51-FM:T9310	DCMT 11T304E-FM:T9310	7763100
DCMT 32.51-FM:T9315	DCMT 11T304E-FM:T9315	6753731
DCMT 32.51-FM:T9325	DCMT 11T304E-FM:T9325	6753779
DCMT 32.51-FM:T9335	DCMT 11T304E-FM:T9335	7156885
DCMT 32.51-FM2:T7325	DCMT 11T304E-FM2:T7325	7156886
DCMT 32.51-FM2:T8330	DCMT 11T304E-FM2:T8330	7156887
DCMT 32.51-FM2:T9315	DCMT 11T304E-FM2:T9315	7156888
DCMT 32.51-FM2:T9325	DCMT 11T304E-FM2:T9325	7156889
DCMT 32.51-FM2:T9335	DCMT 11T304E-FM2:T9335	7156890
DCMT 32.51-RF:6630	DCMT 11T304E-RF:6630	6756033
DCMT 32.51-RF:T5315	DCMT 11T304E-RF:T5315	6756035
DCMT 32.51-RF:T7335	DCMT 11T304E-RF:T7335	6756034
DCMT 32.51-RM:T5305	DCMT 11T304E-RM:T5305	6755815
DCMT 32.51-RM:T5315	DCMT 11T304E-RM:T5315	6755846
DCMT 32.51-RM:T7335	DCMT 11T304E-RM:T7335	6754772
DCMT 32.51-RM:T8330	DCMT 11T304E-RM:T8330	6754394
DCMT 32.51-RM:T9315	DCMT 11T304E-RM:T9315	6753732
DCMT 32.51-RM:T9325	DCMT 11T304E-RM:T9325	6753782
DCMT 32.51-UR:T5315	DCMT 11T304E-UR:T5315	6755847
DCMT 32.51-UR:T7325	DCMT 11T304E-UR:T7325	7156250
DCMT 32.51-UR:T7335	DCMT 11T304E-UR:T7335	6754773
DCMT 32.51-UR:T8315	DCMT 11T304E-UR:T8315	6753597
DCMT 32.51-UR:T8330	DCMT 11T304E-UR:T8330	6754235
DCMT 32.51-UR:T9315	DCMT 11T304E-UR:T9315	6753733
DCMT 32.51-UR:T9325	DCMT 11T304E-UR:T9325	6753784
DCMT 32.51-UR:TT310	DCMT 11T304E-UR:TT310	6756261
DCMT 32.52-FF:T8315	DCMT 11T308E-FF:T8315	6753598
DCMT 32.52-FF:T8330	DCMT 11T308E-FF:T8330	6754262
DCMT 32.52-FF:T9315	DCMT 11T308E-FF:T9315	7454484
DCMT 32.52-FF2:T7325	DCMT 11T308E-FF2:T7325	7156744
DCMT 32.52-FF2:T8330	DCMT 11T308E-FF2:T8330	7156745
DCMT 32.52-FF2:T9315	DCMT 11T308E-FF2:T9315	7156746
DCMT 32.52-FF2:T9325	DCMT 11T308E-FF2:T9325	7156747
DCMT 32.52-FF2:TT010	DCMT 11T308E-FF2:TT010	7080625
DCMT 32.52-FM:T7325	DCMT 11T308E-FM:T7325	7156251
DCMT 32.52-FM:T7335	DCMT 11T308E-FM:T7335	6754774
DCMT 32.52-FM:T8315	DCMT 11T308E-FM:T8315	6753599
DCMT 32.52-FM:T9310	DCMT 11T308E-FM:T9310	7763101
DCMT 32.52-FM:T9315	DCMT 11T308E-FM:T9315	6753734
DCMT 32.52-FM:T9325	DCMT 11T308E-FM:T9325	6753785
DCMT 32.52-FM2:T6310	DCMT 11T308E-FM2:T6310	7156891

ANSI	ISO	EDP
DCMT 32.52-FM2:T7325	DCMT 11T308E-FM2:T7325	7156892
DCMT 32.52-FM2:T8330	DCMT 11T308E-FM2:T8330	7156893
DCMT 32.52-FM2:T9315	DCMT 11T308E-FM2:T9315	7156894
DCMT 32.52-FM2:T9325	DCMT 11T308E-FM2:T9325	7156895
DCMT 32.52-FM2:T9335	DCMT 11T308E-FM2:T9335	7156896
DCMT 32.52-RF:6630	DCMT 11T308E-RF:6630	6756036
DCMT 32.52-RF:T5315	DCMT 11T308E-RF:T5315	6756038
DCMT 32.52-RF:T7335	DCMT 11T308E-RF:T7335	6756037
DCMT 32.52-RM:T5305	DCMT 11T308E-RM:T5305	6755816
DCMT 32.52-RM:T5315	DCMT 11T308E-RM:T5315	6755848
DCMT 32.52-RM:T7335	DCMT 11T308E-RM:T7335	6754775
DCMT 32.52-RM:T8330	DCMT 11T308E-RM:T8330	6754395
DCMT 32.52-RM:T9315	DCMT 11T308E-RM:T9315	6753735
DCMT 32.52-RM:T9325	DCMT 11T308E-RM:T9325	6753786
DCMT 32.52-UR:T5315	DCMT 11T308E-UR:T5315	6755849
DCMT 32.52-UR:T7325	DCMT 11T308E-UR:T7325	7156252
DCMT 32.52-UR:T7335	DCMT 11T308E-UR:T7335	6754776
DCMT 32.52-UR:T8315	DCMT 11T308E-UR:T8315	6753600
DCMT 32.52-UR:T8330	DCMT 11T308E-UR:T8330	6754236
DCMT 32.52-UR:T9315	DCMT 11T308E-UR:T9315	6753736
DCMT 32.52-UR:T9325	DCMT 11T308E-UR:T9325	6753787
DCMT 32.52-UR:TT310	DCMT 11T308E-UR:TT310	6756276
DCMT 32.53-FM:T8330	DCMT 11T312E-FM:T8330	6754290
DCMT 32.53-FM:T9315	DCMT 11T312E-FM:T9315	6754059
DCMT 32.53-FM:T9325	DCMT 11T312E-FM:T9325	6753936
DCMT 32.53-FM2:T9325	DCMT 11T312E-FM2:T9325	7156899
DCMT 32.53-RM:T7335	DCMT 11T312E-RM:T7335	6754777
DCMT 32.53-RM:T8330	DCMT 11T312E-RM:T8330	6754396
DCMT 32.53-RM:T9315	DCMT 11T312E-RM:T9315	6754060
DCMT 32.53-RM:T9325	DCMT 11T312E-RM:T9325	6753937
DCMT 32.53-UR:T9315	DCMT 11T312E-UR:T9315	6754061
DCMT 32.53-UR:T9325	DCMT 11T312E-UR:T9325	6753938
DCMT 432-FM2:T9315	DCMT 150408E-FM2:T9315	7156900
DCMT 432-FM2:T9325	DCMT 150408E-FM2:T9325	7156901
DCMT 432-FM2:T9335	DCMT 150408E-FM2:T9335	7156902
DCMT 432-RM:T8330	DCMT 150408E-RM:T8330	6755614
DCMT 432-RM:T9315	DCMT 150408E-RM:T9315	6922890
DCMT 432-RM:T9325	DCMT 150408E-RM:T9325	6755615
DCMW 21.50-5-T5305	DCMW 070202:T5305	6755817
DCMW 21.50-5-T6310	DCMW 070202:T6310	7168649
DCMW 21.51-T5305	DCMW 070204:T5305	6755818
DCMW 21.51-T5315	DCMW 070204:T5315	6922812
DCMW 21.51-T6310	DCMW 070204:T6310	7168650
DCMW 32.51-T5305	DCMW 11T304:T5305	6755819
DCMW 32.51-T5315	DCMW 11T304:T5315	6922813
DCMW 32.51-T6310	DCMW 11T304:T6310	7168647
DCMW 32.51-FM:T5305	DCMW 11T304FN:PD1	6751869
DCMW 32.52-T5305	DCMW 11T308:T5305	6755820
DCMW 32.52-T5315	DCMW 11T308:T5315	6922814
DCMW 32.52-T6310	DCMW 11T308:T6310	7168648
DCMW 32.52FN:PD1	DCMW 11T308FN:PD1	6751821
DCMX 32.51W-FM:T7325	DCMX 11T304W-FM:T7325	7156255
DCMX 32.51W-FM:T8330	DCMX 11T304W-FM:T8330	7034016
DCMX 32.51W-FM:T9315	DCMX 11T304W-FM:T9315	7034017
DCMX 32.52W-FM:T9325	DCMX 11T308W-FM:T9325	7034018
DCMX 32.52W-FM:T7325	DCMX 11T308W-FM:T7325	7156256
DCMX 32.52W-FM:T8330	DCMX 11T308W-FM:T8330	7034019
DCMX 32.52W-FM:T9315	DCMX 11T308W-FM:T9315	7034020
DCMX 32.52W-FM:T9325	DCMX 11T308W-FM:T9325	7034021
DNG 432 T00420:TC100	DNGN 150408 T01020:TC100	6755414
DNGA 431 500820:TC100	DNGA 150408 502020:TC100	6755433
DNGA 431 T00420:TC100	DNGA 150404 T01020:TC100	6755431
DNGA 432 T00520:TC100	DNGA 150408 T00520:TC100	6755432
DNGA 442500420:TB310	DNGA 1506080510208:TB310	6755925
DNMA 431:T5305	DNMA 150404:T5305	6755821
DNMA 432:T5305	DNMA 150408:T5305	6755822
DNMA 432:T5315	DNMA 150408:T5315	6922792
DNMA 441:T5305	DNMA 150604:T5305	6755823
DNMA 441:T5315	DNMA 150604:T5315	6922793
DNMA 441:T6310	DNMA 150604:T6310	6922856
DNMA 442:T5305	DNMA 150608:T5305	6755824
DNMA 442:T5315	DNMA 150608:T5315	6922794
DNMA 442:T6310	DNMA 150608:T6310	6922857
DNMA 443:T5305	DNMA 150612:T5305	6755825
DNMA 443:T5315	DNMA 150612:T5315	6922795
DNMG 330.5-FF:T8315	DNMG 110402E-FF:T8315	6753601

ANSI	ISO	EDP
DNMG 331-FF:T8315	DNMG 110404E-FF:T8315	6753602
DNMG 331-FF:T8330	DNMG 110404E-FF:T8330	6922776
DNMG 331-FM:T7325	DNMG 110404E-FM:T7325	7156257
DNMG 331-FM:T8315	DNMG 110404E-FM:T8315	6753603
DNMG 331-FM:T8330	DNMG 110404E-FM:T8330	6754207
DNMG 331-FM:T9310	DNMG 110404E-FM:T9310	6755040
DNMG 331-FM:T9315	DNMG 110404E-FM:T9315	6753862
DNMG 331-FM:T9325	DNMG 110404E-FM:T9325	6753939
DNMG 331L-SI:T7335	DNMG 110404E-SI:T7335	6754778
DNMG 331L-SI:T8330	DNMG 110404E-SI:T8330	6754354
DNMG 331L-SI:T9325	DNMG 110404E-SI:T9325	6753940
DNMG 331-M:T5315	DNMG 110404E-M:T5315	6755744
DNMG 331-M:T9315	DNMG 110404E-M:T9315	6753866
DNMG 331-M:T9325	DNMG 110404E-M:T9325	6753941
DNMG 331-M:T9335	DNMG 110404E-M:T9335	6754895
DNMG 331-NF:T6310	DNMG 110404E-NF:T6310	6922836
DNMG 331-NF:T7325	DNMG 110404E-NF:T7325	7156259
DNMG 331-NF:T7335	DNMG 110404E-NF:T7335	6834663
DNMG 331-NF:T8330	DNMG 110404E-NF:T8330	6834664
DNMG 331-NM:T9315	DNMG 110404E-NM:T9315	6834665
DNMG 331-NF:T9325	DNMG 110404E-NF:T9325	6834666
DNMG 331-NM:T7325	DNMG 110404E-NM:T7325	7156260
DNMG 331-NM:T7335	DNMG 110404E-NM:T7335	6754779
DNMG 331-NM:T8315	DNMG 110404E-NM:T8315	6922668
DNMG 331-NM:T8330	DNMG 110404E-NM:T8330	6755110
DNMG 331-NM:T9325	DNMG 110404E-NM:T9325	6753942
DNMG 331-NMR:T7325	DNMG 110404E-NMR:T7325	7156261
DNMG 331-NMR:T9315	DNMG 110404E-NMR:T9315	7038060
DNMG 331-NMR:T9325	DNMG 110404E-NMR:T9325	7038061
DNMG 331R-SI:T7325	DNMG 110404E-SI:T7325	7156262
DNMG 331R-SI:T7335	DNMG 110404E-SI:T7335	6754780
DNMG 331R-SI:T8330	DNMG 110404E-SI:T8330	6754355
DNMG 331R-SI:T9325	DNMG 110404E-SI:T9325	6753943
DNMG 331-SF:T6310	DNMG 110404E-SF:T6310	6919763
DNMG 331-SF:T7325	DNMG 110404E-SF:T7325	7156263
DNMG 331-SF:T8315	DNMG 110404E-SF:T8315	6919765
DNMG 331-SF:T8330	DNMG 110404E-SF:T8330	6919766
DNMG 331-SF:T9315	DNMG 110404E-SF:T9315	7035052
DNMG 331-SF:T9325	DNMG 110404E-SF:T9325	7035053
DNMG 331-SM:T6310	DNMG 110404E-SM:T6310	6915817
DNMG 331-SM:T7325	DNMG 110404E-SM:T7325	7156264
DNMG 331-SM:T7335	DNMG 110404E-SM:T7335	6915818
DNMG 331-SM:T8330	DNMG 110404E-SM:T8330	6915819
DNMG 331-SM:T9325	DNMG 110404E-SM:T9325	6915820
DNMG 332-FF:T8315	DNMG 110408E-FF:T8315	6753604
DNMG 332-FM:T7325	DNMG 110408E-FM:T7325	7156265
DNMG 332-FM:T8315	DNMG 110408E-FM:T8315	6753605
DNMG 332-FM:T8330	DNMG 110408E-FM:T8330	6754208
DNMG 332-FM:T9310	DNMG 110408E-FM:T9310	6755041
DNMG 332-FM:T9315	DNMG 110408E-FM:T9315	6753737
DNMG 332-FM:T9325	DNMG 110408E-FM:T9325	6753944
DNMG 332L-SI:T7325	DNMG 110408E-SI:T7325	7156266
DNMG 332L-SI:T8330	DNMG 110408E-SI:T8330	6754356
DNMG 332L-SI:T9325	DNMG 110408E-SI:T9325	6753945
DNMG 332-M:T5315	DNMG 110408E-M:T531	

ANSI	ISO	EDP
DNMG 332R-SI:T8330	DNMG 110408ER-SI:T8330	6754357
DNMG 332R-SI:T9325	DNMG 110408ER-SI:T9325	6753949
DNMG 332-SF:T6310	DNMG 110408E-SF:T6310	6919767
DNMG 332-SF:T7325	DNMG 110408E-SF:T7325	7156272
DNMG 332-SF:T7335	DNMG 110408E-SF:T7335	6919768
DNMG 332-SF:T8315	DNMG 110408E-SF:T8315	6919769
DNMG 332-SF:T8330	DNMG 110408E-SF:T8330	6919770
DNMG 332-SF:T9325	DNMG 110408E-SF:T9325	7035055
DNMG 332-SM:T6310	DNMG 110408E-SM:T6310	6915821
DNMG 332-SM:T7325	DNMG 110408E-SM:T7325	7156273
DNMG 332-SM:T7335	DNMG 110408E-SM:T7335	6915822
DNMG 332-SM:T8330	DNMG 110408E-SM:T8330	6915823
DNMG 332-SM:T9325	DNMG 110408E-SM:T9325	6915825
DNMG 333-MI:T9315	DNMG 110412E-MI:T9315	6753882
DNMG 333-MI:T9325	DNMG 110412E-MI:T9325	6753950
DNMG 333-MI:T9335	DNMG 110412E-MI:T9335	6754898
DNMG 333-NMR:T7325	DNMG 110412E-NMR:T7325	7156274
DNMG 333-NMR:T9315	DNMG 110412E-NMR:T9315	7038064
DNMG 333-NMR:T9325	DNMG 110412E-NMR:T9325	7038065
DNMG 333-NMR:T9315	DNMG 110412E-NMR:T9315	6753885
DNMG 333-RM:T9325	DNMG 110412E-RM:T9325	6753951
DNMG 431-FI:T8315	DNMG 150404E-FI:T8315	6753606
DNMG 431-FM:T7325	DNMG 150404E-FM:T7325	7156276
DNMG 431-FM:T8330	DNMG 150404E-FM:T8330	6754203
DNMG 431-FM:T9315	DNMG 150404E-FM:T9315	6753887
DNMG 431-FM:T9325	DNMG 150404E-FM:T9325	6753952
DNMG 431L-SI:T8330	DNMG 150404E-SI:T8330	7168618
DNMG 431L-SI:T9325	DNMG 150404E-SI:T9325	7035030
DNMG 431-MI:T5315	DNMG 150404E-MI:T5315	7035037
DNMG 431-MI:T9315	DNMG 150404E-MI:T9315	6754064
DNMG 431-MI:T9325	DNMG 150404E-MI:T9325	6753953
DNMG 431-MI:T9335	DNMG 150404E-MI:T9335	6754900
DNMG 431-NF:T6310	DNMG 150404E-NF:T6310	6922838
DNMG 431-NF:T7325	DNMG 150404E-NF:T7325	7156277
DNMG 431-NF:T7335	DNMG 150404E-NF:T7335	6834671
DNMG 431-NF:T8330	DNMG 150404E-NF:T8330	6834672
DNMG 431-NF:T9315	DNMG 150404E-NF:T9315	6834673
DNMG 431-NF:T9325	DNMG 150404E-NF:T9325	6834674
DNMG 431-NMR:T7325	DNMG 150404E-NMR:T7325	7156278
DNMG 431-NMR:T7335	DNMG 150404E-NMR:T7335	7038067
DNMG 431-NMR:T9325	DNMG 150404E-NMR:T9325	7038066
DNMG 431R-SI:T8330	DNMG 150404E-SI:T8330	7168619
DNMG 431R-SI:T9325	DNMG 150404E-SI:T9325	7035031
DNMG 431-SF:T6310	DNMG 150404E-SF:T6310	6919771
DNMG 431-SF:T8315	DNMG 150404E-SF:T8315	6919772
DNMG 431-SF:T8330	DNMG 150404E-SF:T8330	6919773
DNMG 431-SF:T9325	DNMG 150404E-SF:T9325	7035056
DNMG 431-SM:T6310	DNMG 150404E-SM:T6310	7168666
DNMG 432-FM:T7325	DNMG 150408E-FM:T7325	7156279
DNMG 432-FM:T8330	DNMG 150408E-FM:T8330	6754204
DNMG 432-FM:T9315	DNMG 150408E-FM:T9315	6754065
DNMG 432-FM:T9325	DNMG 150408E-FM:T9325	6753954
DNMG 432L-SI:T7335	DNMG 150408E-SI:T7335	6754784
DNMG 432L-SI:T8330	DNMG 150408E-SI:T8330	6754358
DNMG 432L-SI:T9325	DNMG 150408E-SI:T9325	6753955
DNMG 432-MI:T5315	DNMG 150408E-MI:T5315	7035038
DNMG 432-MI:T9315	DNMG 150408E-MI:T9315	6754066
DNMG 432-MI:T9325	DNMG 150408E-MI:T9325	6753956
DNMG 432-MI:T9335	DNMG 150408E-MI:T9335	6754901
DNMG 432-NF:T6310	DNMG 150408E-NF:T6310	6922839
DNMG 432-NF:T7325	DNMG 150408E-NF:T7325	7156281
DNMG 432-NF:T7335	DNMG 150408E-NF:T7335	6834675
DNMG 432-NF:T8330	DNMG 150408E-NF:T8330	6834676
DNMG 432-NF:T9315	DNMG 150408E-NF:T9315	6834677
DNMG 432-NF:T9325	DNMG 150408E-NF:T9325	6834678
DNMG 432-NM:T7335	DNMG 150408E-NM:T7335	7035032
DNMG 432-NM:T8330	DNMG 150408E-NM:T8330	7168640
DNMG 432-NM:T9325	DNMG 150408E-NM:T9325	7035036
DNMG 432-NMR:T7325	DNMG 150408E-NMR:T7325	7156282
DNMG 432-NMR:T7335	DNMG 150408E-NMR:T7335	7038071
DNMG 432-NMR:T8330	DNMG 150408E-NMR:T8330	7038068
DNMG 432-NMR:T9315	DNMG 150408E-NMR:T9315	7038069
DNMG 432-NMR:T9325	DNMG 150408E-NMR:T9325	7038070
DNMG 432-NRM:T7325	DNMG 150408E-NRM:T7325	7595915
DNMG 432-NRM:T7335	DNMG 150408E-NRM:T7335	7595916
DNMG 432-NRM:T9315	DNMG 150408E-NRM:T9315	7595917

ANSI	ISO	EDP
DNMG 432-R-T5315	DNMG 150408E-R-T5315	7035040
DNMG 432-RM:T9315	DNMG 150408E-RM:T9315	7035034
DNMG 432-RM:T9325	DNMG 150408E-RM:T9325	7035035
DNMG 432-RM:T9335	DNMG 150408E-RM:T9335	7035033
DNMG 432R-SI:T7335	DNMG 150408E-SI:T7335	6754785
DNMG 432R-SI:T8330	DNMG 150408E-SI:T8330	6754359
DNMG 432R-SI:T9325	DNMG 150408E-SI:T9325	6753957
DNMG 432-SF:T6310	DNMG 150408E-SF:T6310	6919774
DNMG 432-SF:T8315	DNMG 150408E-SF:T8315	6919775
DNMG 432-SF:T8330	DNMG 150408E-SF:T8330	6919776
DNMG 432-SF:T9325	DNMG 150408E-SF:T9325	7035057
DNMG 432-SM:T6310	DNMG 150408E-SM:T6310	7168667
DNMG 432-SM:T5315	DNMG 150412E-MI:T5315	7035039
DNMG 432-SM:T9315	DNMG 150412E-MI:T9315	6922891
DNMG 432-SM:T9325	DNMG 150412E-MI:T9325	6753958
DNMG 432-SM:T9335	DNMG 150412E-MI:T9335	6753958
DNMG 433-MI:T9315	DNMG 150412E-MI:T9315	6922891
DNMG 433-MI:T9325	DNMG 150412E-MI:T9325	6753958
DNMG 433-RM:T7325	DNMG 150412E-RM:T7325	7156284
DNMG 433-RM:T9315	DNMG 150412E-RM:T9315	6754067
DNMG 433-RM:T9325	DNMG 150412E-RM:T9325	6753959
DNMG 433-RM:T9335	DNMG 150412E-RM:T9335	6754903
DNMG 432-SF:T9325	DNMG 150604E-SF:T9325	7156503
DNMG 441-FF:T7325	DNMG 150604E-FF:T7325	7156507
DNMG 441-FF:T8315	DNMG 150604E-FF:T8315	6753607
DNMG 441-FM:T7325	DNMG 150604E-FM:T7325	7156285
DNMG 441-FM:T7335	DNMG 150604E-FM:T7335	6754786
DNMG 441-FM:T8315	DNMG 150604E-FM:T8315	6753608
DNMG 441-FM:T8330	DNMG 150604E-FM:T8330	6754202
DNMG 441-FM:T9310	DNMG 150604E-FM:T9310	6755042
DNMG 441-FM:T9315	DNMG 150604E-FM:T9315	6753738
DNMG 441-FM:T9325	DNMG 150604E-FM:T9325	6753960
DNMG 441-FM:T7310	DNMG 150604E-FM:T7310	6798558
DNMG 441-SI:T6330	DNMG 150604E-SI:T6330	6752018
DNMG 441-SI:T7325	DNMG 150604E-SI:T7325	7156286
DNMG 441-SI:T7335	DNMG 150604E-SI:T7335	6754787
DNMG 441-SI:T8315	DNMG 150604E-SI:T8315	6922728
DNMG 441-SI:T8330	DNMG 150604E-SI:T8330	6754364
DNMG 441-SI:T9325	DNMG 150604E-SI:T9325	6753961
DNMG 441-MI:T5315	DNMG 150604E-MI:T5315	6755746
DNMG 441-MI:T9315	DNMG 150604E-MI:T9315	6754068
DNMG 441-MI:T9325	DNMG 150604E-MI:T9325	6753962
DNMG 441-MI:T9335	DNMG 150604E-MI:T9335	6754904
DNMG 441-NF:H7	DNMG 150604E-NF:H7	6834679
DNMG 441-NF:T6310	DNMG 150604E-NF:T6310	6922840
DNMG 441-NF:T7325	DNMG 150604E-NF:T7325	7156287
DNMG 441-NF:T7335	DNMG 150604E-NF:T7335	6834680
DNMG 441-NF:T8315	DNMG 150604E-NF:T8315	6834681
DNMG 441-NF:T8330	DNMG 150604E-NF:T8330	6834682
DNMG 441-NF:T9315	DNMG 150604E-NF:T9315	6834683
DNMG 441-NF:T9325	DNMG 150604E-NF:T9325	6834684
DNMG 441-NM:T7325	DNMG 150604E-NM:T7325	7156288
DNMG 441-NM:T7335	DNMG 150604E-NM:T7335	6754788
DNMG 441-NM:T8315	DNMG 150604E-NM:T8315	6922670
DNMG 441-NM:T8330	DNMG 150604E-NM:T8330	6755112
DNMG 441-NM:T9315	DNMG 150604E-NM:T9315	6922892
DNMG 441-NM:T9325	DNMG 150604E-NM:T9325	6753963
DNMG 441-NMR:T7325	DNMG 150604E-NMR:T7325	7156289
DNMG 441-NMR:T7335	DNMG 150604E-NMR:T7335	7038075
DNMG 441-NMR:T8330	DNMG 150604E-NMR:T8330	7038072
DNMG 441-NMR:T9315	DNMG 150604E-NMR:T9315	7038073
DNMG 441-NMR:T9325	DNMG 150604E-NMR:T9325	7038074
DNMG 441-NRM:T7325	DNMG 150604E-NRM:T7325	7595918
DNMG 441-NRM:T7335	DNMG 150604E-NRM:T7335	7595919
DNMG 441-NRM:T9315	DNMG 150604E-NRM:T9315	7595920
DNMG 441R-SI:T6330	DNMG 150604E-SI:T6330	6752017
DNMG 441R-SI:T7325	DNMG 150604E-SI:T7325	7156290
DNMG 441R-SI:T7335	DNMG 150604E-SI:T7335	6754789
DNMG 441R-SI:T8315	DNMG 150604E-SI:T8315	6922729
DNMG 441R-SI:T8330	DNMG 150604E-SI:T8330	6754365
DNMG 441R-SI:T9325	DNMG 150604E-SI:T9325	6753788
DNMG 441-SF:H07	DNMG 150604E-SF:H07	6921014
DNMG 441-SF:T6310	DNMG 150604E-SF:T6310	6919778
DNMG 441-SF:T7325	DNMG 150604E-SF:T7325	7156291
DNMG 441-SF:T7335	DNMG 150604E-SF:T7335	6919779
DNMG 441-SF:T8315	DNMG 150604E-SF:T8315	6919780
DNMG 441-SF:T8330	DNMG 150604E-SF:T8330	6919781
DNMG 441-SF:T9315	DNMG 150604E-SF:T9315	7035058
DNMG 441-SF:T9325	DNMG 150604E-SF:T9325	7035059
DNMG 441-SM:T6310	DNMG 150604E-SM:T6310	6915826

ANSI	ISO	EDP
DNMG 441-SM:T7325	DNMG 150604E-SM:T7325	7156292
DNMG 441-SM:T7335	DNMG 150604E-SM:T7335	6915827
DNMG 441-SM:T8330	DNMG 150604E-SM:T8330	6915828
DNMG 441-SM:T9315	DNMG 150604E-SM:T9315	6915829
DNMG 441-SM:T9325	DNMG 150604E-SM:T9325	6915830
DNMG 442-FF:T7325	DNMG 150608E-FF:T7325	7156504
DNMG 442-FF:T8315	DNMG 150608E-FF:T8315	6753609
DNMG 442-FM:T7325	DNMG 150608E-FM:T7325	7156293
DNMG 442-FM:T7335	DNMG 150608E-FM:T7335	6754790
DNMG 442-FM:T8315	DNMG 150608E-FM:T8315	6753610
DNMG 442-FM:T8330	DNMG 150608E-FM:T8330	6754201
DNMG 442-FM:T9310	DNMG 150608E-FM:T9310	6755043
DNMG 442-FM:T9315	DNMG 150608E-FM:T9315	6753739
DNMG 442-FM:T9325	DNMG 150608E-FM:T9325	6753964
DNMG 442-FM:T7310	DNMG 150608E-FM:T7310	6798559
DNMG 442L-SI:T6330	DNMG 150608E-SI:T6330	6752012
DNMG 442L-SI:T7325	DNMG 150608E-SI:T7325	7156294
DNMG 442L-SI:T7335	DNMG 150608E-SI:T7335	6754791
DNMG 442L-SI:T8315	DNMG 150608E-SI:T8315	6922730
DNMG 442L-SI:T8330	DNMG 150608E-SI:T8330	6754366
DNMG 442L-SI:T9325	DNMG 150608E-SI:T9325	6753789
DNMG 442-MI:T6330	DNMG 150608E-MI:T6330	6751587
DNMG 442-MI:T5315	DNMG 150608E-MI:T5315	6755747
DNMG 442-MI:T9310	DNMG 150608E-MI:T9310	6755047
DNMG 442-MI:T9315	DNMG 150608E-MI:T9315	6753740
DNMG 442-MI:T9325	DNMG 150608E-MI:T9325	6753803
DNMG 442-MI:T9335	DNMG 150608E-MI:T9335	6754905
DNMG 442-NF:H7	DNMG 150608E-NF:H7	6834685
DNMG 442-NF:T6310	DNMG 150608E-NF:T6310	6922841
DNMG 442-NF:T7325	DNMG 150608E-NF:T7325	7156295
DNMG 442-NF:T7335	DNMG 150608E-NF:T7335	6834686
DNMG 442-NF:T8315	DNMG 150608E-NF:T8315	6834687
DNMG 442-NF:T8330	DNMG 150608E-NF:T8330	6834688
DNMG 442-NF:T9315	DNMG 150608E-NF:T9315	6834689
DNMG 442-NF:T9325	DNMG 150608E-NF:T9325	6834690
DNMG 442-NM:T7325	DNMG 150608E-NM:T7325	7156296
DNMG 442-NM:T7335	DNMG 150608E-NM:T7335	6754792
DNMG 442-NM:T8315	DNMG 150608E-NM:T8315	6922671
DNMG 442-NM:T8330	DNMG 150608E-NM:T8330	6754200
DNMG 442-NM:T9315	DNMG 150608E-NM:T9315	6922893
DNMG 442-NM:T9325	DNMG 150608E-NM:T9325	6753965
DNMG 442-NMR:T6310	DNMG 150608E-NMR:T6310	7454464
DNMG 442-NMR:T7325	DNMG 150608E-NMR:T7325	7156297
DNMG 442-NMR:T7335	DNMG 150608E-NMR:T7335	7038079
DNMG 442-NMR:T8330	DNMG 150608E-NMR:T8330	7038076
DNMG 442-NMR:T9315	DNMG 150608E-NMR:T9315	7038077
DNMG 442-NMR:T9325	DNMG 150608E-NMR:T9325	7038078
DNMG 442-NRM:T7325	DNMG 150608E-NRM:T7325	7595931
DNMG 442-NRM:T7335	DNMG 150608E-NRM:T7335	7595932
DNMG 442-NRM:T9315	DNMG 150608E-NRM:T9315	7595933
DNMG 442-R:T6330	DNMG 150608E-R:T6330	6755189
DNMG 442-R:T5305	DNMG 150608E-R:T5305	6755826
DNMG 442-R:T5315	DNMG 150608E-R:T5315	6922757
DNMG 442-R:T9310	DNMG 150608E-R:T9310	6922947
DNMG 442-R:T9315	DNMG 150608E-R:T9315	6922894
DNMG 442-R:T9325	DNMG 150608E-R	



ANSI	ISO	EDP
DNMG 442-SF-T8315	DNMG 150608E-SF-T8315	6919785
DNMG 442-SF-T8330	DNMG 150608E-SF-T8330	6919786
DNMG 442-SF-T9315	DNMG 150608E-SF-T9315	7035060
DNMG 442-SF-T9325	DNMG 150608E-SF-T9325	7035061
DNMG 442-SM-T6310	DNMG 150608E-SM-T6310	6915831
DNMG 442-SM-T7325	DNMG 150608E-SM-T7325	7156301
DNMG 442-SM-T7335	DNMG 150608E-SM-T7335	6915832
DNMG 442-SM-T8330	DNMG 150608E-SM-T8330	6915833
DNMG 442-SM-T9315	DNMG 150608E-SM-T9315	6915834
DNMG 442-SM-T9325	DNMG 150608E-SM-T9325	6915835
DNMG 442W-MR-T5315	DNMG 150608W-MR-T5315	7035043
DNMG 442W-MR-T9315	DNMG 150608W-MR-T9315	6850885
DNMG 442W-MR-T9325	DNMG 150608W-MR-T9325	6850886
DNMG 443-FM-T7325	DNMG 150612E-FM-T7325	7156302
DNMG 443-FM-T8330	DNMG 150612E-FM-T8330	6754199
DNMG 443-FM-T9310	DNMG 150612E-FM-T9310	7763102
DNMG 443-FM-T9315	DNMG 150612E-FM-T9315	6754070
DNMG 443-FM-T9325	DNMG 150612E-FM-T9325	6753967
DNMG 443-M-T5315	DNMG 150612E-M-T5315	6755749
DNMG 443-M-T9310	DNMG 150612E-M-T9310	6755045
DNMG 443-M-T9315	DNMG 150612E-M-T9315	6754071
DNMG 443-M-T9325	DNMG 150612E-M-T9325	6753968
DNMG 443-M-T9335	DNMG 150612E-M-T9335	6754907
DNMG 443-NF-T6310	DNMG 150612E-NF-T6310	6922842
DNMG 443-NF-T8330	DNMG 150612E-NF-T8330	6834691
DNMG 443-NF-T9325	DNMG 150612E-NF-T9325	6834693
DNMG 443-NM-T7325	DNMG 150612E-NM-T7325	7156303
DNMG 443-NM-T7335	DNMG 150612E-NM-T7335	6754794
DNMG 443-NM-T8315	DNMG 150612E-NM-T8315	6922672
DNMG 443-NM-T9325	DNMG 150612E-NM-T9325	6753969
DNMG 443-NMR-T7325	DNMG 150612E-NMR-T7325	7156304
DNMG 443-NMR-T7335	DNMG 150612E-NMR-T7335	7038083
DNMG 443-NMR-T8330	DNMG 150612E-NMR-T8330	7038080
DNMG 443-NMR-T9315	DNMG 150612E-NMR-T9315	7038081
DNMG 443-NMR-T9325	DNMG 150612E-NMR-T9325	7038082
DNMG 443-NRM-T7325	DNMG 150612E-NRM-T7325	7595934
DNMG 443-NRM-T7335	DNMG 150612E-NRM-T7335	7595935
DNMG 443-NRM-T9315	DNMG 150612E-NRM-T9315	7595936
DNMG 443-R-6630	DNMG 150612E-R-6630	6751591
DNMG 443-R-T5305	DNMG 150612E-R-T5305	6755828
DNMG 443-R-T5315	DNMG 150612E-R-T5315	6922758
DNMG 443-R-T9310	DNMG 150612E-R-T9310	6922948
DNMG 443-R-T9315	DNMG 150612E-R-T9315	6754072
DNMG 443-R-T9325	DNMG 150612E-R-T9325	6753792
DNMG 443-RM-T5305	DNMG 150612E-RM-T5305	6755829
DNMG 443-RM-T5315	DNMG 150612E-RM-T5315	6755750
DNMG 443-RM-T7325	DNMG 150612E-RM-T7325	7156305
DNMG 443-RM-T9310	DNMG 150612E-RM-T9310	6922697
DNMG 443-RM-T8330	DNMG 150612E-RM-T8330	6755128
DNMG 443-RM-T9315	DNMG 150612E-RM-T9315	6755046
DNMG 443-RM-T9325	DNMG 150612E-RM-T9325	6754073
DNMG 443-RM-T9335	DNMG 150612E-RM-T9335	6753970
DNMG 443-SF-T6310	DNMG 150612E-SF-T6310	6919787
DNMG 443-SF-T7325	DNMG 150612E-SF-T7325	7156306
DNMG 443-SF-T9315	DNMG 150612E-SF-T9315	7035062
DNMG 443-SM-T6310	DNMG 150612E-SM-T6310	6915836
DNMG 443-SM-T7325	DNMG 150612E-SM-T7325	7156307
DNMG 443-SM-T7335	DNMG 150612E-SM-T7335	6915837
DNMG 443-SM-T8330	DNMG 150612E-SM-T8330	6915838
DNMG 443-SM-T9315	DNMG 150612E-SM-T9315	6915839
DNMG 443-SM-T9325	DNMG 150612E-SM-T9325	6915840
DNMG 443W-MR-T9310	DNMG 150612W-MR-T9310	7035045
DNMG 443W-MR-T9315	DNMG 150612W-MR-T9315	6850887
DNMG 443W-MR-T9325	DNMG 150612W-MR-T9325	6850888
DNMG 444-FM-T9315	DNMG 150616E-FM-T9315	6922829
DNMG 444-FM-T9325	DNMG 150616E-FM-T9325	6922830
DNMG 444-R-T9325	DNMG 150616E-R-T9325	6922759
DNMG 444-RM-T5315	DNMG 150616E-RM-T5315	6755751
DNMG 444-RM-T9315	DNMG 150616E-RM-T9315	6754074
DNMG 444-RM-T9325	DNMG 150616E-RM-T9325	6753971
DNMG 444-RM-T9335	DNMG 150616E-RM-T9335	6754909
DNMM 432-NR-T9325	DNMM 150408E-NR-T9325	6753972
DNMM 442-NR-T7325	DNMM 150608E-NR-T7325	7156310
DNMM 442-NR-T8330	DNMM 150608E-NR-T8330	6754198
DNMM 442-NR-T9325	DNMM 150608E-NR-T9325	6753973

ANSI	ISO	EDP
DNMM 442-NR-T9325	DNMM 150608E-NR-T9325	6753974
DNMM 442-OR-T9325	DNMM 150608E-OR-T9325	6753975
DNMM 443-OR-T9315	DNMM 150612E-OR-T9315	6754075
DNMM 443-OR-T9325	DNMM 150612E-OR-T9325	6753976
DNMM 443-OR-T9335	DNMM 150612E-OR-T9335	6754911
DNMM 444-OR-T9325	DNMM 150616E-OR-T9325	6753977
DNMX 441W-NM-T7325	DNMX 150604W-NM-T7325	7156312
DNMX 441W-NM-T7335	DNMX 150604W-NM-T7335	7034022
DNMX 441W-NM-T9315	DNMX 150604W-NM-T9315	7034023
DNMX 441W-NM-T9325	DNMX 150604W-NM-T9325	7034024
DNMX 442W-NM-T7325	DNMX 150608W-NM-T7325	7156313
DNMX 442W-NM-T7335	DNMX 150608W-NM-T7335	7034025
DNMX 442W-NM-T9315	DNMX 150608W-NM-T9315	7034026
DNMX 442W-NM-T9325	DNMX 150608W-NM-T9325	7034027
ECGT 2.520.5-SF2-H07	ECGT 080302E-SF2-H07	7168492
ECGT 2.520.5-SF2-T6310	ECGT 080302E-SF2-T6310	7168493
ECGT 2.521-SF2-H07	ECGT 080304E-SF2-H07	7168494
ECGT 2.521-SF2-T6310	ECGT 080304E-SF2-T6310	7168495
ECGT 2.521-SF3-H07	ECGT 080304E-SF3-H07	7168572
ECGT 2.521-SF3-T6310	ECGT 080304E-SF3-T6310	7168573
ECGT 21.50.5-SF2-H07	ECGT 060202E-SF2-H07	7168198
ECGT 21.50.5-SF2-T6310	ECGT 060202E-SF2-T6310	7168199
ECGT 21.50.5-SF3-H07	ECGT 060202E-SF3-H07	7168570
ECGT 21.50.5-SF3-T6310	ECGT 060202E-SF3-T6310	7168571
ECGT 21.51-SF2-H07	ECGT 060204E-SF2-H07	7168490
ECGT 21.51-SF2-T6310	ECGT 060204E-SF2-T6310	7168491
ECMT 2.521-FM2-T5315	ECMT 080304E-FM2-T5315	6755936
ECMT 2.521-FM2-T7325	ECMT 080304E-FM2-T7325	7156905
ECMT 2.521-FM2-T8330	ECMT 080304E-FM2-T8330	7156906
ECMT 2.521-FM2-T9315	ECMT 080304E-FM2-T9315	6922896
ECMT 2.521-FM2-T9325	ECMT 080304E-FM2-T9325	6755937
ECMT 2.521-FM2-T9335	ECMT 080304E-FM2-T9335	6755938
ECMT 2.522-FM2-T9315	ECMT 080308E-FM2-T9315	6922897
ECMT 2.522-FM2-T9325	ECMT 080308E-FM2-T9325	6755939
ECMT 2.522-FM2-T9335	ECMT 080308E-FM2-T9335	6755940
ECMT 21.51-FM2-T7325	ECMT 060204E-FM2-T7325	7156903
ECMT 21.51-FM2-T8330	ECMT 060204E-FM2-T8330	7156904
ECMT 21.51-FM2-T9315	ECMT 060204E-FM2-T9315	6922895
ECMT 21.51-FM2-T9325	ECMT 060204E-FM2-T9325	6755934
ECMT 21.51-FM2-T9335	ECMT 060204E-FM2-T9335	6755935
ECMW 2.521-H07	ECMW 080304H07	7168664
ECMW 2.522-H07	ECMW 080308H07	7168665
ECMW 21.51-H07	ECMW 060204H07	7168666
EPGX1.81.50.5FL-JZ-TT010	EPGX 050202FL-JZ-TT010	7080627
EPGX1.81.50.5FR-JZ-TT010	EPGX 050202FR-JZ-TT010	7080628
EPMT 1.81.50.5-NF2-H07	EPMT 050202E-NF2-H07	7167482
EPMT 1.81.50.5-NF2-T7325	EPMT 050202E-NF2-T7325	7156314
EPMT 1.81.50.5-NF2-T7335	EPMT 050202E-NF2-T7335	6755942
EPMT 1.81.50.5-NF2-T9315	EPMT 050202E-NF2-T9315	6922898
EPMT 1.81.50.5-NF2-T9325	EPMT 050202E-NF2-T9325	6755941
EPMT 1.81.50.5-NF2-T9335	EPMT 050202E-NF2-T9335	7167484
EPMT 1.81.50.5-NF2-TT010	EPMT 050202E-NF2-TT010	6756302
GL2-D200G02L06-PM-G8330	GL2-D200G02L06-PM-G8330	7802886
GL2-D200G02L06-PM-T7325	GL2-D200G02L06-PM-T7325	7802888
GL2-D200G02L06-PM-T8330	GL2-D200G02L06-PM-T8330	7802912
GL2-D200G02L12-PM-G8330	GL2-D200G02L12-PM-G8330	7802884
GL2-D200G02L12-PR-G8330	GL2-D200G02L12-PR-G8330	7802914
GL2-D200G02R06-PM-G8330	GL2-D200G02R06-PM-G8330	7802887
GL2-D200G02R12-PM-T7325	GL2-D200G02R12-PM-T7325	7802889
GL2-D200G02R06-PR-G8330	GL2-D200G02R06-PR-G8330	7802913
GL2-D200G02R12-PR-G8330	GL2-D200G02R12-PR-G8330	7802885
GL2-D200G02L06-PM-G8330	GL2-D200G02L06-PM-G8330	7802915
GL2-D200M02-PM-T7325	GL2-D200M02-PM-T7325	7802883
GL2-D200M02-PR-G8330	GL2-D200M02-PR-G8330	7802910
GL2-D200M02-PR-T7325	GL2-D200M02-PR-T7325	7802911
GL3-D250G02L06-PM-G8330	GL3-D250G02L06-PM-G8330	7802916
GL3-D300G02L06-PM-G8330	GL3-D300G02L06-PM-G8330	7802921
GL3-D300G02L06-PM-T7325	GL3-D300G02L06-PM-T7325	7802923
GL3-D300G02L06-PR-G8330	GL3-D300G02L06-PR-G8330	7802927
GL3-D300G02L12-PM-G8330	GL3-D300G02L12-PM-G8330	7802919
GL3-D300G02L12-PR-G8330	GL3-D300G02L12-PR-G8330	7802929
GL3-D300G02R06-PM-G8330	GL3-D300G02R06-PM-G8330	7802922
GL3-D300G02R06-PR-T7325	GL3-D300G02R06-PR-T7325	7802924

ANSI	ISO	EDP
GL3-D300G02R06-PR-G8330	GL3-D300G02R06-PR-G8330	7802928
GL3-D300G02R12-PM-G8330	GL3-D300G02R12-PM-G8330	7802920
GL3-D300G02R12-PR-G8330	GL3-D300G02R12-PR-G8330	7802930
GL3-D300M02-PM-G8330	GL3-D300M02-PM-G8330	7802917
GL3-D300M02-PM-T7325	GL3-D300M02-PM-T7325	7802918
GL3-D300M02-PR-G8330	GL3-D300M02-PR-G8330	7802925
GL3-D300M02-PR-T7325	GL3-D300M02-PR-T7325	7802926
GL4-D400G02L06-PM-G8330	GL4-D400G02L06-PM-G8330	7802935
GL4-D400G02L06-PM-T7325	GL4-D400G02L06-PM-T7325	7802937
GL4-D400G02L06-PR-G8330	GL4-D400G02L06-PR-G8330	7802941
GL4-D400G02L12-PM-G8330	GL4-D400G02L12-PM-G8330	7802933
GL4-D400G02L12-PR-G8330	GL4-D400G02L12-PR-G8330	7802943
GL4-D400G02R06-PM-G8330	GL4-D400G02R06-PM-G8330	7802936
GL4-D400G02R06-PM-T7325	GL4-D400G02R06-PM-T7325	7802938
GL4-D400G02R06-PR-G8330	GL4-D400G02R06-PR-G8330	7802942
GL4-D400G02R12-PM-G8330	GL4-D400G02R12-PM-G8330	7802934
GL4-D400M04-PR-G8330	GL4-D400M04-PR-G8330	7802944
GL4-D400M02-PM-G8330	GL4-D400M02-PM-G8330	7802931
GL4-D400M02-PM-T7325	GL4-D400M02-PM-T7325	7802932
GL4-D400M02-PR-G8330	GL4-D400M02-PR-G8330	7802939
GL4-D400M02-PR-T7325	GL4-D400M02-PR-T7325	7802940
GL5-D500M03-PM-G8330	GL5-D500M03-PM-G8330	7802945
GL5-D500M04-PR-G8330	GL5-D500M04-PR-G8330	7802946
GL6-D600M03-PM-G8330	GL6-D600M03-PM-G8330	7802947
GL6-D600M04-PR-G8330	GL6-D600M04-PR-G8330	7802948
HNEF 090508EN-M:MS515	HNEF 090508EN-M:MS515	6756169
HNEF 090508EN-M:M9325	HNEF 090508EN-M:M9325	6756170
HNEF 0905DNFN-F:8215	HNEF 0905DNFN-F:8215	6756108
HNEF 0905DNFN-F:M5315	HNEF 0905DNFN-F:M5315	6756109
HNEF 0905DNFN-F:M9325	HNEF 0905DNFN-F:M9325	6756110
HNEF 0905ZLL-W:8215	HNEF 0905ZLL-W:8215	6756107
HNEF 0905ZLR-W:8215	HNEF 0905ZLR-W:8215	6756248
HNEF 0905ZLR-W:M5315	HNEF 0905ZLR-W:M5315	6756250
HNEF 0905ZLR-W:M8310	HNEF 0905ZLR-W:M8310	6756249
HNGX 0604ANSN-F:8215	HNGX 0604ANSN-F:8215	6753670
HNGX 0604ANSN-F:M6330	HNGX 0604ANSN-F:M6330	7601336
HNGX 0604ANSN-F:M8310	HNGX 0604ANSN-F:M8310	6922525
HNGX 0604ANSN-F:M8330	HNGX 0604ANSN-F:M8330	7447877
HNGX 0604ANSN-F:M8340	HNGX 0604ANSN-F:M8340	6800829
HNGX 0604ANSN-F:M9340	HNGX 0604ANSN-F:M9340	6755627
HNGX 0604ANSN-M:8215	HNGX 0604ANSN-M:8215	6753676
HNGX 0604ANSN-M:M5315	HNGX 0604ANSN-M:M5315	6753673
HNGX 0604ANSN-M:M6330	HNGX 0604ANSN-M:M6330	7601337
HNGX 0604ANSN-M:M8310	HNGX 0604ANSN-M:M8310	6922526
HNGX 0604ANSN-M:M8330	HNGX 0604ANSN-M:M8330	7447878
HNGX 0604ANSN-M:M8340	HNGX 0604ANSN-M:M8340	6800830
HNGX 0604ANSN-M:M9315	HNGX 0604ANSN-M:M9315	6753674
HNGX 0604ANSN-M:M9325	HNGX 0604ANSN-M:M9325	6753675
HNGX 0604ANSN-M:M9340	HNGX 0604ANSN-M:M9340	6755628
HNGX 0604ANSN-R:8215	HNGX 0604ANSN-R:8215	6753659
HNGX 0604ANSN-R:M5315	HNGX 0604ANSN-R:M5315	6753656
HNGX 0604ANSN-R:M8310	HNGX 0604ANSN-R:M8310	6922527
HNGX 0604ANSN-R:M8330	HNGX 0604ANSN-R:M8330	7447879
HNGX 0604ANSN-R:M8340	HNGX 0604ANSN-R:M8340	6800831
HNGX 0604ANSN-R:M9325	HNGX 0604ANSN-R:M9325	6753658
HNGX 0906ANFN-F:8215	HNGX 0906ANFN-F:8215	6755670
HNGX 0906ANFN-F:M8330	HNG	

ANSI	ISO	EDP
HNGX 0906ANSN-R:M8310	HNGX 0906ANSN-R:M8310	6922530
HNGX 0906ANSN-R:M8330	HNGX 0906ANSN-R:M8330	7447893
HNGX 0906ANSN-R:M8340	HNGX 0906ANSN-R:M8340	6800834
HNGX 0906ANSN-R:M9315	HNGX 0906ANSN-R:M9315	6753665
HNGX 0906ANSN-R:M9325	HNGX 0906ANSN-R:M9325	6753666
HNMFM 090516SN-R:8215	HNMFM 090516SN-R:8215	6756172
HNMFM 090516SN-R:M5315	HNMFM 090516SN-R:M5315	6756173
HNMFM 090516SN-R:M9325	HNMFM 090516SN-R:M9325	6756174
HZ 1006-60 C11:333TN	HZ 1006-60 C11:333TN	6755403
HZ 1006-60 D10:333TN	HZ 1006-60 D10:333TN	6755947
HZ 1006-60 H7:333TN	HZ 1006-60 H7:333TN	6755406
HZ 1006-60 P9:333TN	HZ 1006-60 P9:333TN	6755948
HZ 1006-80 C11:333TN	HZ 1006-80 C11:333TN	6755404
HZ 1006-80 D10:333TN	HZ 1006-80 D10:333TN	6755949
HZ 1006-80 H7:333TN	HZ 1006-80 H7:333TN	6755405
HZ 1006-80 P9:333TN	HZ 1006-80 P9:333TN	6755950
HZ 1309-100 C11:333TN	HZ 1309-100 C11:333TN	6755408
HZ 1309-100 D10:333TN	HZ 1309-100 D10:333TN	6755951
HZ 1309-100 H7:333TN	HZ 1309-100 H7:333TN	6755407
HZ 1309-100 P9:333TN	HZ 1309-100 P9:333TN	6755952
HZ 1309-120 C11:333TN	HZ 1309-120 C11:333TN	6755409
HZ 1309-120 D10:333TN	HZ 1309-120 D10:333TN	6755953
HZ 1309-120 H7:333TN	HZ 1309-120 H7:333TN	6755410
HZ 1309-120 P9:333TN	HZ 1309-120 P9:333TN	6755954
HZ/2 14-14 C11:333TN	HZ/2 14-14 C11:333TN	6755462
HZ/2 14-14 H7:333TN	HZ/2 14-14 H7:333TN	6755460
HZ/2 14-14 P9:333TN	HZ/2 14-14 P9:333TN	6755955
HZ/2 16-16 C11:333TN	HZ/2 16-16 C11:333TN	6755459
HZ/2 16-16 H7:333TN	HZ/2 16-16 H7:333TN	6755461
HZ/2 16-16 P9:333TN	HZ/2 16-16 P9:333TN	6755956
HZ/2 18-18 C11:333TN	HZ/2 18-18 C11:333TN	6755487
HZ/2 18-18 H7:333TN	HZ/2 18-18 H7:333TN	6755488
HZ/2 18-18 P9:333TN	HZ/2 18-18 P9:333TN	6755957
HZ/2 20-20 C11:333TN	HZ/2 20-20 C11:333TN	6755489
HZ/2 20-20 H7:333TN	HZ/2 20-20 H7:333TN	6755490
HZ/2 20-20 P9:333TN	HZ/2 20-20 P9:333TN	6755958
HZ90 0604-30 C11:333TN	HZ90 0604-30 C11:333TN	6755478
HZ90 0604-30 D10:333TN	HZ90 0604-30 D10:333TN	6755484
HZ90 0604-30 H7:333TN	HZ90 0604-30 H7:333TN	6755479
HZ90 0604-30 P9:333TN	HZ90 0604-30 P9:333TN	6755959
HZ90 0604-40 C11:333TN	HZ90 0604-40 C11:333TN	6755480
HZ90 0604-40 D10:333TN	HZ90 0604-40 D10:333TN	6755485
HZ90 0604-40 H7:333TN	HZ90 0604-40 H7:333TN	6755481
HZ90 0604-40 P9:333TN	HZ90 0604-40 P9:333TN	6755960
HZ90 0604-50 C11:333TN	HZ90 0604-50 C11:333TN	6755482
HZ90 0604-50 D10:333TN	HZ90 0604-50 D10:333TN	6755486
HZ90 0604-50 H7:333TN	HZ90 0604-50 H7:333TN	6755483
HZ90 0604-50 P9:333TN	HZ90 0604-50 P9:333TN	6755961
KNUX 160405EL-72:T5315	KNUX 160405EL-72:T5315	6755759
KNUX 160405EL-72:T9325	KNUX 160405EL-72:T9325	6753978
KNUX 160405EL-72:T9335	KNUX 160405EL-72:T9335	6754913
KNUX 160405ER-72:T5315	KNUX 160405ER-72:T5315	6755760
KNUX 160405ER-72:T9325	KNUX 160405ER-72:T9325	6753829
KNUX 160405ER-72:T9335	KNUX 160405ER-72:T9335	6754914
KNUX 160405L-22:T5315	KNUX 160405L-22:T5315	7455426
KNUX 160405L-22:T7325	KNUX 160405L-22:T7325	7455480
KNUX 160405L-22:T7335	KNUX 160405L-22:T7335	7455429
KNUX 160405L-22:T9325	KNUX 160405L-22:T9325	7455427
KNUX 160405L-22:T9335	KNUX 160405L-22:T9335	7455428
KNUX 160405L-32:T5315	KNUX 160405L-32:T5315	7455481
KNUX 160405L-32:T7325	KNUX 160405L-32:T7325	7455485
KNUX 160405L-32:T7335	KNUX 160405L-32:T7335	7455484
KNUX 160405L-32:T9325	KNUX 160405L-32:T9325	7455482
KNUX 160405L-32:T9335	KNUX 160405L-32:T9335	7455483
KNUX 160405R-22:T5315	KNUX 160405R-22:T5315	7455486
KNUX 160405R-22:T7325	KNUX 160405R-22:T7325	7455490
KNUX 160405R-22:T7335	KNUX 160405R-22:T7335	7455489
KNUX 160405R-22:T9325	KNUX 160405R-22:T9325	7455487
KNUX 160405R-22:T9335	KNUX 160405R-22:T9335	7455488
KNUX 160405R-32:T5315	KNUX 160405R-32:T5315	7455491
KNUX 160405R-32:T7325	KNUX 160405R-32:T7325	7455495
KNUX 160405R-32:T7335	KNUX 160405R-32:T7335	7455494
KNUX 160405R-32:T9325	KNUX 160405R-32:T9325	7455492
KNUX 160405R-32:T9335	KNUX 160405R-32:T9335	7455493
KNUX 160405SL-73:6640	KNUX 160405SL-73:6640	6751685
KNUX 160405SR-73:6640	KNUX 160405SR-73:6640	6751686

ANSI	ISO	EDP
KNUX 160410L-22:T9335	KNUX 160410L-22:T9335	7455496
KNUX 160410L-32:T9325	KNUX 160410L-32:T9325	7455497
KNUX 160410L-32:T9335	KNUX 160410L-32:T9335	7455498
KNUX 160410R-22:T9335	KNUX 160410R-22:T9335	7455499
KNUX 160410R-32:T9325	KNUX 160410R-32:T9325	7455500
KNUX 160410R-32:T9335	KNUX 160410R-32:T9335	7455501
KNUX 160410SL-73:6640	KNUX 160410SL-73:6640	6751725
KNUX 160410SR-73:6640	KNUX 160410SR-73:6640	6751726
KNUX 160410SR-73:T5315	KNUX 160410SR-73:T5315	6755764
KNUX 160415SL-74:6640	KNUX 160415SL-74:6640	6751727
KNUX 160415SR-74:6640	KNUX 160415SR-74:6640	6751728
LC 0806-KP:M4310	LC 0806-KP:M4310	7637582
LC 0806-KP:M8310	LC 0806-KP:M8310	6922531
LC 0806-KP:M8330	LC 0806-KP:M8330	7637583
LC 0806-KPF:M4310	LC 0806-KPF:M4310	7637584
LC 0810-KP:M4310	LC 0810-KP:M4310	7637585
LC 0810-KP:M8310	LC 0810-KP:M8310	6922532
LC 1008-KP:M4310	LC 1008-KP:M4310	7637586
LC 1008-KP:M8310	LC 1008-KP:M8310	6922533
LC 1008-KP:M8330	LC 1008-KP:M8330	7637587
LC 1008-KPF:M4310	LC 1008-KPF:M4310	7637588
LC 1010-KP:M4310	LC 1010-KP:M4310	7637589
LC 1010-KP:M8310	LC 1010-KP:M8310	6922534
LC 1010-KP:M8330	LC 1010-KP:M8330	7637600
LC 1210-KP:M4310	LC 1210-KP:M4310	7637601
LC 1210-KP:M8310	LC 1210-KP:M8310	6922535
LC 1210-KP:M8330	LC 1210-KP:M8330	7637602
LC 1210-KPF:M4310	LC 1210-KPF:M4310	7637603
LC 1210-KPF:M8330	LC 1210-KPF:M8330	7637604
LC 1220-KP:M4310	LC 1220-KP:M4310	7637605
LC 1220-RE:M4310	LC 1220-RE:M4310	7637649
LC 1230-RE:M4310	LC 1230-RE:M4310	7637720
LC 1245-CH:M4310	LC 1245-CH:M4310	7637721
LC 1610-KP:M4310	LC 1610-KP:M4310	7637606
LC 1610-KP:M8310	LC 1610-KP:M8310	6922536
LC 1610-KP:M8330	LC 1610-KP:M8330	7637607
LC 1613-KP:M4310	LC 1613-KP:M4310	7637608
LC 1613-KP:M8310	LC 1613-KP:M8310	6922537
LC 1613-KPF:M4310	LC 1613-KPF:M4310	7637609
LC 1630-KP:M4310	LC 1630-KP:M4310	7637610
LC 2010-KP:M4310	LC 2010-KP:M4310	7637611
LC 2010-KP:M8310	LC 2010-KP:M8310	6922538
LC 2010-KP:M8330	LC 2010-KP:M8330	7637612
LC 2016-KP:M4310	LC 2016-KP:M4310	7637613
LC 2016-KP:M8310	LC 2016-KP:M8310	6922539
LC 2016-KPF:M4310	LC 2016-KPF:M4310	7637614
LC 2040-KP:M8310	LC 2040-KP:M8310	7637615
LCMF 022002-F1:T8330	LCMF 022002-F1:T8330	6754263
LCMF 022002L6-M2:T8330	LCMF 022002L6-M2:T8330	6754697
LCMF 022002-M2:T8330	LCMF 022002-M2:T8330	6754250
LCMF 022002R6-M2:T8330	LCMF 022002R6-M2:T8330	6754696
LCMF 0220MO-MP:T8330	LCMF 0220MO-MP:T8330	6755611
LCMF 031302-F:T8330	LCMF 031302-F:T8330	6754704
LCMF 031302-F-04:T8330	LCMF 031302-F-04:T8330	6926959
LCMF 031304-CM:T8330	LCMF 031304-CM:T8330	6754705
LCMF 031304-CM-04:T8330	LCMF 031304-CM-04:T8330	6755612
LCMF 031304-F:T8330	LCMF 031304-F:T8330	6754264
LCMF 031304-F-04:T8330	LCMF 031304-F-04:T8330	6754251
LCMF 0313MO-MP:T8330	LCMF 0313MO-MP:T8330	6754265
LCMF 0313MO-MP-04:T8330	LCMF 0313MO-MP-04:T8330	6926958
LCMF 031602-CM:T8330	LCMF 031602-CM:T8330	6754706
LCMF 031602-F:T8330	LCMF 031602-F:T8330	6754266
LCMF 031602L15-CM:T8330	LCMF 031602L15-CM:T8330	6755612
LCMF 031602L6-CM:T8330	LCMF 031602L6-CM:T8330	6755651
LCMF 031602-M:T8330	LCMF 031602-M:T8330	6754267
LCMF 031602R15-CM:T8330	LCMF 031602R15-CM:T8330	6755650
LCMF 031602R6-CM:T8330	LCMF 031602R6-CM:T8330	6755649
LCMF 031604-CM:T8330	LCMF 031604-CM:T8330	6754707
LCMF 031604-F:T8330	LCMF 031604-F:T8330	6754268
LCMF 031604-M:T8330	LCMF 031604-M:T8330	6754269
LCMF 0316MO-MP:T8330	LCMF 0316MO-MP:T8330	6754270
LCMF 041304-CM:T8330	LCMF 041304-CM:T8330	6754708
LCMF 041304-F:T8330	LCMF 041304-F:T8330	6754271
LCMF 041304-F:T9325	LCMF 041304-F:T9325	6754668
LCMF 0413MO-MP:T8330	LCMF 0413MO-MP:T8330	6754272
LCMF 041602-CM:T8330	LCMF 041602-CM:T8330	6754709

ANSI	ISO	EDP
LCMF 041602L15-CM:T8330	LCMF 041602L15-CM:T8330	6755656
LCMF 041602L6-CM:T8330	LCMF 041602L6-CM:T8330	6755655
LCMF 041602R15-CM:T8330	LCMF 041602R15-CM:T8330	6755654
LCMF 041602R6-CM:T8330	LCMF 041602R6-CM:T8330	6755653
LCMF 041604-CM:T8330	LCMF 041604-CM:T8330	6754710
LCMF 041604-F:T8330	LCMF 041604-F:T8330	6754273
LCMF 041604-F:T9325	LCMF 041604-F:T9325	6754669
LCMF 041604-M:T8330	LCMF 041604-M:T8330	6754274
LCMF 041604-M:T9325	LCMF 041604-M:T9325	6754671
LCMF 041608-F:T8330	LCMF 041608-F:T8330	6754307
LCMF 041608-F:T9325	LCMF 041608-F:T9325	6754672
LCMF 041608-M:T8330	LCMF 041608-M:T8330	6754308
LCMF 041608-M:T9325	LCMF 041608-M:T9325	6754678
LCMF 0416MO-MP:T8330	LCMF 0416MO-MP:T8330	6754309
LCMF 0416MO-MP:T9325	LCMF 0416MO-MP:T9325	6754680
LCMF 051604-CM:T8330	LCMF 051604-CM:T8330	6754711
LCMF 051608-F:T8330	LCMF 051608-F:T8330	6754310
LCMF 051608-F:T9325	LCMF 051608-F:T9325	6754681
LCMF 051608-M:T8330	LCMF 051608-M:T8330	6754311
LCMF 051608-M:T9325	LCMF 051608-M:T9325	6754684
LCMF 0516MO-MP:T8330	LCMF 0516MO-MP:T8330	6754312
LCMF 0516MO-MP:T9325	LCMF 0516MO-MP:T9325	6754685
LCMF 061604-CM:T8330	LCMF 061604-CM:T8330	6754712
LCMF 061608-F:T8330	LCMF 061608-F:T8330	6754313
LCMF 061608-F:T9325	LCMF 061608-F:T9325	6754686
LCMF 061608-M:T8330	LCMF 061608-M:T8330	6754314
LCMF 061608-M:T9325	LCMF 061608-M:T9325	6754687
LCMF 0616MO-MP:T8330	LCMF 0616MO-MP:T8330	6754315
LCMF 0616MO-MP:T9325	LCMF 0616MO-MP:T9325	6754689
LCMF 083008-F:T8330	LCMF 083008-F:T8330	6755609
LCMF 083012-F:T8330	LCMF 083012-F:T8330	6754256
LCMF 0830MO-MP:T8330	LCMF 0830MO-MP:T8330	6755613
LCMR 031304-F:T8330	LCMR 031304-F:T8330	6754713
LCMR 0313MO-MP:T8330	LCMR 0313MO-MP:T8330	6754715
LCMR 031602-CM:T8330	LCMR 031602-CM:T8330	6754725
LCMR 031604-F:T8330	LCMR 031604-F:T8330	6754717
LCMR 031604-M:T8330	LCMR 031604-M:T8330	6754721
LCMR 0316MO-MP:T8330	LCMR 0316MO-MP:T8330	6754727
LCMR 041304-F:T8330	LCMR 041304-F:T8330	6754714
LCMR 0413MO-MP:T8330	LCMR 0413MO-MP:T8330	6754716
LCMR 041604-CM:T8330	LCMR 041604-CM:T8330	6754726
LCMR 041604-F:T8330	LCMR 041604-F:T8330	6754718
LCMR 041604-M:T8330	LCMR 041604-M:T8330	6754722
LCMR 0416MO-MP:T8330	LCMR 0416MO-MP:T8330	6754728
LCMR 051604-F:T8330	LCMR 051604-F:T8330	6754719
LCMR 051604-M:T8330	LCMR 051604-M:T8330	6754723
LCMR 0516MO-MP:T8330	LCMR 0516MO-MP:T8330	6754729
LCMR 061608-F:T8330	LCMR 061608-F:T8330	6754720
LCMR 061608-M:T8330	LCMR 061608-M:T8330	6754724
LCMR 0616MO-MP:T8330	LCMR 0616MO-MP:T8330	6754730
LCMR 083008-F:T8330	LCMR 083008-F:T8330	6755610
LDGN 130560-R25:6640	LDGN 130560-R25:6640	6753291
LDGN 130560-R30:6640	LDGN	

ANSI	ISO	EDP
LFMX 3.1-.20SR8M2:T8330	LFMX 3.1-.20SR8M2:T8330	6754340
LFMX 3.1-.20TNF2:6640	LFMX 3.1-.20TNF2:6640	6752368
LFMX 3.1-.20TNF2:T8330	LFMX 3.1-.20TNF2:T8330	6754341
LFMX 3.1-.20TNM2:6640	LFMX 3.1-.20TNM2:6640	6752417
LFMX 3.1-.20TNM2:T8330	LFMX 3.1-.20TNM2:T8330	6754342
LFMX 4.1-.20ENF1:T8330	LFMX 4.1-.20ENF1:T8330	6754343
LFMX 4.1-.20SL8M2:T8330	LFMX 4.1-.20SL8M2:T8330	6754344
LFMX 4.1-.20SNF2:T8330	LFMX 4.1-.20SNF2:T8330	6754345
LFMX 4.1-.20SNM2:6640	LFMX 4.1-.20SNM2:6640	6752419
LFMX 4.1-.20SNM2:T8330	LFMX 4.1-.20SNM2:T8330	6754346
LFMX 4.1-.20SR8M2:T8330	LFMX 4.1-.20SR8M2:T8330	6754347
LFMX 4.1-.20TNF2:T8330	LFMX 4.1-.20TNF2:T8330	6754348
LFMX 4.1-.20TNM2:6640	LFMX 4.1-.20TNM2:6640	6752418
LFMX 4.1-.20TNM2:T8330	LFMX 4.1-.20TNM2:T8330	6754349
LFMX 5.1-.20SNF1:T8330	LFMX 5.1-.20SNF1:T8330	6754350
LFMX 5.1-.20SNM2:6640	LFMX 5.1-.20SNM2:6640	6752009
LFMX 5.1-.20SNM2:T8330	LFMX 5.1-.20SNM2:T8330	6754351
LFMX 6.35-.20SNF2:T8330	LFMX 6.35-.20SNF2:T8330	6754352
LFMX 6.35-.20SNM2:6640	LFMX 6.35-.20SNM2:6640	6752010
LFMX 6.35-.20SNM2:T8330	LFMX 6.35-.20SNM2:T8330	6754353
LFUX 030800TL:6640	LFUX 030800TL:6640	6751720
LFUX 030800TL:T8330	LFUX 030800TL:T8330	6754329
LFUX 030800TR:6640	LFUX 030800TR:6640	6751721
LFUX 030800TR:T8330	LFUX 030800TR:T8330	6754327
LFUX 030802TN:6640	LFUX 030802TN:6640	6751687
LFUX 030802TN:T8330	LFUX 030802TN:T8330	6754328
LFUX 040800TR:6640	LFUX 040800TR:6640	6751722
LFUX 040800TR:T8330	LFUX 040800TR:T8330	6754330
LFUX 040802TN:6640	LFUX 040802TN:6640	6751688
LFUX 040802TN:T8330	LFUX 040802TN:T8330	6754331
LFUX 050802TN:6640	LFUX 050802TN:6640	6751689
LFUX 050802TN:T8330	LFUX 050802TN:T8330	6754332
LFUX 060802TN:6640	LFUX 060802TN:6640	6751723
LFUX 060802TN:T8330	LFUX 060802TN:T8330	6754333
LNET 160616SR-M:M8330	LNET 160616SR-M:M8330	7447894
LNET 160616SR-M:M8340	LNET 160616SR-M:M8340	6801305
LNET 160616SR-R:M8330	LNET 160616SR-R:M8330	7447895
LNET 160616SR-R:M8340	LNET 160616SR-R:M8340	6801306
LNEX 1513DPSR-KR:M5326	LNEX 1513DPSR-KR:M5326	6872877
LNEX 1513DPSR-M:M8326	LNEX 1513DPSR-M:M8326	6872941
LNEX 1513DPSR-M:M8346	LNEX 1513DPSR-M:M8346	6872942
LNEX 1513DPSR-M:M9325	LNEX 1513DPSR-M:M9325	7045821
LNFG 300715-MM-S01:T6310	LNFG 300715-MM-S01:T6310	7317920
LNFG 300715-MM-S01:T7325	LNFG 300715-MM-S01:T7325	7317921
LNFG 300715-MM-S01:T9315	LNFG 300715-MM-S01:T9315	7317922
LNFG 300715-MM-S02:T7325	LNFG 300715-MM-S02:T7325	7317923
LNFG 300715-MM-S02:T7325	LNFG 300715-MM-S02:T7325	7317924
LNFG 300715-PM:6630	LNFG 300715-PM:6630	6752833
LNFG 300715-PM:T6310	LNFG 300715-PM:T6310	7346979
LNFG 300715-PM:T7325	LNFG 300715-PM:T7325	7347210
LNFG 300715-PM:T9226	LNFG 300715-PM:T9226	6931824
LNFG 300715-PM:T9315	LNFG 300715-PM:T9315	7347211
LNFG 300715-PM-S02:T7325	LNFG 300715-PM-S02:T7325	7347212
LNFG 300715-PM-S03:T7325	LNFG 300715-PM-S03:T7325	7347213
LNFG 361220-MM-S01:T6310	LNFG 361220-MM-S01:T6310	7317925
LNFG 361220-MM-S01:T7325	LNFG 361220-MM-S01:T7325	7317926
LNFG 361220-MM-S01:T9315	LNFG 361220-MM-S01:T9315	7317927
LNFG 361220-MM-S02:T7325	LNFG 361220-MM-S02:T7325	7317928
LNFG 361220-MM-S02:T9315	LNFG 361220-MM-S02:T9315	7347214
LNFG 361220-MM-S03:T7325	LNFG 361220-MM-S03:T7325	7317929
LNFG 361220-MM-S03:T9315	LNFG 361220-MM-S03:T9315	7347459
LNFG 361220-MM-S04:H07	LNFG 361220-MM-S04:H07	7317930
LNFG 361220-PM:6630	LNFG 361220-PM:6630	6752848
LNFG 361220-PM-S01:T7325	LNFG 361220-PM-S01:T7325	7347215
LNFG 361220-PM-S01:T9315	LNFG 361220-PM-S01:T9315	7347216
LNFG 361220-PM-S02:T7325	LNFG 361220-PM-S02:T7325	7347217
LNFG 361220-PM-S03:T7325	LNFG 361220-PM-S03:T7325	7347218
LNFG 401035-MM-S01:T6310	LNFG 401035-MM-S01:T6310	7317931
LNFG 401035-MM-S01:T7325	LNFG 401035-MM-S01:T7325	7317932
LNFG 401035-MM-S01:T9315	LNFG 401035-MM-S01:T9315	7317933
LNFG 401035-MM-S02:T7325	LNFG 401035-MM-S02:T7325	7317934
LNFG 401035-MM-S03:T7325	LNFG 401035-MM-S03:T7325	7317935
LNFG 401035-PM:6630	LNFG 401035-PM:6630	6752818
LNFG 401035-PM-S01:T7325	LNFG 401035-PM-S01:T7325	7347219
LNFG 401035-PM-S01:T9226	LNFG 401035-PM-S01:T9226	6931826
LNFG 401035-PM-S01:T9315	LNFG 401035-PM-S01:T9315	7347220

ANSI	ISO	EDP
LNFG 401035-PM-S02:T7325	LNFG 401035-PM-S02:T7325	7347221
LNFG 401035-PM-S03:T7325	LNFG 401035-PM-S03:T7325	7347222
LNUG 120525ER-M:M8330	LNUG 120525ER-M:M8330	7447896
LNUG 120525ER-M:M8340	LNUG 120525ER-M:M8340	6798598
LNUG 120530ER-M:M8330	LNUG 120530ER-M:M8330	7447897
LNUG 120530ER-M:M8340	LNUG 120530ER-M:M8340	6798600
LNUG 160708FR-FA:HF7	LNUG 160708FR-FA:HF7	6941432
LNUG 160708SR-M:8215	LNUG 160708SR-M:8215	6753702
LNUG 160708SR-M:8230	LNUG 160708SR-M:8230	6753703
LNUG 160708SR-M:M8340	LNUG 160708SR-M:M8340	6800835
LNUG 160708SR-M:M9315	LNUG 160708SR-M:M9315	6753070
LNUG 160708SR-M:M9325	LNUG 160708SR-M:M9325	6753701
LNUG 120504ER-F:8215	LNUG 120504ER-F:8215	6798582
LNUG 120504ER-F:M8330	LNUG 120504ER-F:M8330	7447898
LNUG 120504ER-F:M8340	LNUG 120504ER-F:M8340	6798584
LNUG 120504ER-M:M8330	LNUG 120504ER-M:M8330	7447899
LNUG 120504ER-M:M8340	LNUG 120504ER-M:M8340	6798590
LNUG 120504ER-MF:M6330	LNUG 120504ER-MF:M6330	6925524
LNUG 120504ER-MF:M8340	LNUG 120504ER-MF:M8340	6925547
LNUG 120504ER-MF:M9340	LNUG 120504ER-MF:M9340	7051435
LNUG 120504FR-FA:HF7	LNUG 120504FR-FA:HF7	6798579
LNUG 120508ER-F:8215	LNUG 120508ER-F:8215	6798585
LNUG 120508ER-F:M8310	LNUG 120508ER-F:M8310	6922540
LNUG 120508ER-F:M8330	LNUG 120508ER-F:M8330	7447900
LNUG 120508ER-F:M8340	LNUG 120508ER-F:M8340	6798587
LNUG 120508ER-M:8215	LNUG 120508ER-M:8215	6753697
LNUG 120508ER-M:8230	LNUG 120508ER-M:8230	6753698
LNUG 120508ER-M:M8310	LNUG 120508ER-M:M8310	6922541
LNUG 120508ER-M:M8330	LNUG 120508ER-M:M8330	7447901
LNUG 120508ER-M:M8340	LNUG 120508ER-M:M8340	6798588
LNUG 120508ER-M:M9315	LNUG 120508ER-M:M9315	6753695
LNUG 120508ER-M:M9325	LNUG 120508ER-M:M9325	6753696
LNUG 120508ER-MF:M9340	LNUG 120508ER-MF:M9340	6755626
LNUG 120508ER-MF:M6330	LNUG 120508ER-MF:M6330	6925525
LNUG 120508ER-MF:M8340	LNUG 120508ER-MF:M8340	6925548
LNUG 120508ER-MF:M9340	LNUG 120508ER-MF:M9340	7051436
LNUG 120508FR-FA:HF7	LNUG 120508FR-FA:HF7	6798580
LNUG 120508FR-FA:M0315	LNUG 120508FR-FA:M0315	6798581
LNUG 120508SR-MM:M6330	LNUG 120508SR-MM:M6330	6925526
LNUG 120508SR-MM:M8340	LNUG 120508SR-MM:M8340	6925549
LNUG 120508SR-MM:M8345	LNUG 120508SR-MM:M8345	7051461
LNUG 120508SR-MM:M9340	LNUG 120508SR-MM:M9340	7051470
LNUG 120508SR-R:8215	LNUG 120508SR-R:8215	6798601
LNUG 120508SR-R:M5315	LNUG 120508SR-R:M5315	6798604
LNUG 120508SR-R:M8310	LNUG 120508SR-R:M8310	6922542
LNUG 120508SR-R:M8330	LNUG 120508SR-R:M8330	7447902
LNUG 120508SR-R:M8340	LNUG 120508SR-R:M8340	6798603
LNUG 120508SR-R:M9315	LNUG 120508SR-R:M9315	6798605
LNUG 120508SR-R:M9325	LNUG 120508SR-R:M9325	6798606
LNUG 120508SR-R:M9340	LNUG 120508SR-R:M9340	6798607
LNUG 120510ER-M:M8330	LNUG 120510ER-M:M8330	7447903
LNUG 120510ER-M:M8340	LNUG 120510ER-M:M8340	6939769
LNUG 120512ER-M:M8330	LNUG 120512ER-M:M8330	7447904
LNUG 120512ER-M:M8340	LNUG 120512ER-M:M8340	6798592
LNUG 120516ER-M:M8330	LNUG 120516ER-M:M8330	7447905
LNUG 120516ER-M:M8340	LNUG 120516ER-M:M8340	6798594
LNUG 120516SR-R:8215	LNUG 120516SR-R:8215	6798608
LNUG 120516SR-R:M8330	LNUG 120516SR-R:M8330	7447906
LNUG 120516SR-R:M8340	LNUG 120516SR-R:M8340	6798610
LNUG 120516SR-R:M9325	LNUG 120516SR-R:M9325	6798611
LNUG 120520ER-M:M8310	LNUG 120520ER-M:M8310	7048898
LNUG 120520ER-M:M8330	LNUG 120520ER-M:M8330	7447907
LNUG 120520ER-M:M8340	LNUG 120520ER-M:M8340	6798596
LNMT 311240S:T9315	LNMT 311240S:T9315	7074720
LNMT 311240SN-M:T9315	LNMT 311240SN-M:T9315	7661699
LNMU 160708ER-F:8215	LNMU 160708ER-F:8215	6941357
LNMU 160708ER-F:M8330	LNMU 160708ER-F:M8330	7447908
LNMU 160708ER-F:M8340	LNMU 160708ER-F:M8340	6941358
LNMU 160708SR-M:8215	LNMU 160708SR-M:8215	6941410
LNMU 160708SR-M:M6330	LNMU 160708SR-M:M6330	6941436
LNMU 160708SR-M:M8330	LNMU 160708SR-M:M8330	7447909
LNMU 160708SR-M:M8340	LNMU 160708SR-M:M8340	6941411
LNMU 160708SR-M:M9325	LNMU 160708SR-M:M9325	6941413
LNMU 160708SR-R:M5315	LNMU 160708SR-R:M5315	6941426
LNMU 160708SR-R:M8310	LNMU 160708SR-R:M8310	6941420
LNMU 160708SR-R:M8330	LNMU 160708SR-R:M8330	7447910

ANSI	ISO	EDP
LNMU 160708SR-R:M8340	LNMU 160708SR-R:M8340	6941421
LNMU 160708SR-R:M9315	LNMU 160708SR-R:M9315	6941424
LNMU 160708SR-R:M9325	LNMU 160708SR-R:M9325	6941425
LNMU 160716SR-R:M8310	LNMU 160716SR-R:M8310	6941429
LNMU 160716SR-R:M8330	LNMU 160716SR-R:M8330	7447911
LNMU 160716SR-R:M8340	LNMU 160716SR-R:M8340	6941430
LNMU 160716SR-R:M9315	LNMU 160716SR-R:M9315	6941427
LNMU 160716SR-R:M9325	LNMU 160716SR-R:M9325	6941428
LNMU 160720SR-M:M8330	LNMU 160720SR-M:M8330	7447912
LNMU 160720SR-M:M8340	LNMU 160720SR-M:M8340	6941414
LNMU 160730SR-M:M8330	LNMU 160730SR-M:M8330	7447913
LNMU 160730SR-M:M8340	LNMU 160730SR-M:M8340	6941416
LNMU 160740SR-M:M8330	LNMU 160740SR-M:M8330	7447914
LNMU 160740SR-M:M8340	LNMU 160740SR-M:M8340	6941418
LNMX 191940SN-RF:T9315	LNMX 191940SN-RF:T9315	6753325
LNMX 191940SN-RM:T9310	LNMX 191940SN-RM:T9310	6753305
LNMX 191940SN-RM:T9315	LNMX 191940SN-RM:T9315	6753306
LNMX 191940SN-RM:T9325	LNMX 191940SN-RM:T9325	6753307
LNMX 191940SN-RR:T5315	LNMX 191940SN-RR:T5315	6798520
LNMX 191940SN-RR:T9315	LNMX 191940SN-RR:T9315	6798517
LNMX 191940SN-RR:T5315	LNMX 191940SN-RR:T5315	6798515
LNMX 191940SN-TF:T5315	LNMX 191940SN-TF:T5315	6798525
LNMX 191940SN-TF:T9310	LNMX 191940SN-TF:T9310	6798521
LNMX 191940SN-TF:T9315	LNMX 191940SN-TF:T9315	6798522
LNMX 191940SN-TF:T9325	LNMX 191940SN-TF:T9325	6798523
LNMX 301940SN-RF:T9315	LNMX 301940SN-RF:T9315	6753309
LNMX 301940SN-RM:T9310	LNMX 301940SN-RM:T9310	6753311
LNMX 301940SN-RM:T9315	LNMX 301940SN-RM:T9315	6753312
LNMX 301940SN-RM:T9325	LNMX 301940SN-RM:T9325	6753313
LNMX 301940SN-RR:T9325	LNMX 301940SN-RR:T9325	6753316
LNMX 301940SN-TF:T5315	LNMX 301940SN-TF:T5315	6798510
LNMX 301940SN-TF:T9310	LNMX 301940SN-TF:T9310	6798496
LNMX 301940SN-TF:T9315	LNMX 301940SN-TF:T9315	6798497
LNMX 501432E:T9335	LNMX 501432E:T9335	6754915
LNMX 50-228400:09315	LNMX 50-228400:09315	7026644
LNMX 191940SN-DF:T9325	LNMX 191940SN-DF:T9325	6753830
LNMX 301940SN-DM:T9325	LNMX 301940SN-DM:T9325	6753979
LNMX 40-1129002:T9226	LNMX 40-1129002:T9226	6931860
LNMX 40-1129002:T9325	LNMX 40-1129002:T9325	6753980
LNMX 40-1129002:T9335	LNMX 40-1129002:T9335	6754916
LNMX 40-1129003:6630	LNMX 40-1129003:6630	6752120
LNMX 40-1129003:T9226	LNMX 40-1129003:T9226	6931861
LNMX 40-1129003:T9325	LNMX 40-1129003:T9325	6753981
LNMX 40-1129003:T9335	LNMX 40-1129003:T9335	6754917
LNMX 50-1275000:6630	LNMX 50-1275000:6630	6752126
LNMX 50-1275000:T9325	LNMX 50-1275000:T9325	6753982
LNMR 381240-PM:T9315	LNMR 381240-PM:T9315	7347223
LNMR 381240-PR:6630	LNMR 381240-PR:6630	6752820
ODEW		

ANSI	ISO	EDP
OEHT 0604AEER-MM:M8340	OEHT 0604AEER-MM:M8340	6931654
OEHT 0604AEER-MM:M8345	OEHT 0604AEER-MM:M8345	7051462
OEHT 0604AEER-MM:M9325	OEHT 0604AEER-MM:M9325	6931652
OEHT 0604AEER-MM:M9340	OEHT 0604AEER-MM:M9340	7051471
OEHT 0604AEFR-FA:HF7	OEHT 0604AEFR-FA:HF7	6931668
OEHT 0604AEFR-FA:M0315	OEHT 0604AEFR-FA:M0315	6931669
OEHT 0604AESR-M:M6330	OEHT 0604AESR-M:M6330	7056846
OEHT 0604AESR-M:M8310	OEHT 0604AESR-M:M8310	6931657
OEHT 0604AESR-M:M8330	OEHT 0604AESR-M:M8330	7447921
OEHT 0604AESR-M:M8340	OEHT 0604AESR-M:M8340	6931658
OEHT 0604AESR-M:M9325	OEHT 0604AESR-M:M9325	6931656
OEHT 0604AESR-M:M9340	OEHT 0604AESR-M:M9340	7051431
OEHT 0906AEER-MM:M8310	OEHT 0906AEER-MM:M8310	7056758
OEHT 0906AEER-MM:M8330	OEHT 0906AEER-MM:M8330	7447922
OEHT 0906AEER-MM:M8340	OEHT 0906AEER-MM:M8340	7056759
OEHT 0906AEER-MM:M8310	OEHT 0906AEER-MM:M8310	7056792
OEHT 0906AEER-MM:M8330	OEHT 0906AEER-MM:M8330	7447923
OEHT 0906AEER-MM:M8340	OEHT 0906AEER-MM:M8340	7056793
OEHT 0906AESR-M:M9325	OEHT 0906AESR-M:M9325	7056794
OFKR 0704SN-M:M8330	OFKR 0704SN-M:M8330	7447924
OFKR 0704SN-M:M8340	OFKR 0704SN-M:M8340	6800838
PDKT 090530ER-FM:8215	PDKT 090530ER-FM:8215	6755683
PDKT 090530ER-FM:8230	PDKT 090530ER-FM:8230	6755684
PDKT 090530ER-FM:M6330	PDKT 090530ER-FM:M6330	6925531
PDKT 090530ER-FM:M8310	PDKT 090530ER-FM:M8310	6922543
PDKT 090530ER-FM:M8330	PDKT 090530ER-FM:M8330	7447925
PDKT 090530ER-FM:M8345	PDKT 090530ER-FM:M8345	6756071
PDKT 090530ER-FM:M9325	PDKT 090530ER-FM:M9325	7048899
PDKX 0905ZEEER-FM:M6330	PDKX 0905ZEEER-FM:M6330	7056845
PDKX 0905ZEEER-FM:M8345	PDKX 0905ZEEER-FM:M8345	6756072
PDKX 0905ZEEER-FM:M9340	PDKX 0905ZEEER-FM:M9340	6756073
PDMW 090530SR:M8310	PDMW 090530SR:M8310	6922544
PDMW 090530SR:M8345	PDMW 090530SR:M8345	6756074
PDMW 090530SR:M9315	PDMW 090530SR:M9315	6922556
PDMW 090530SR:M9325	PDMW 090530SR:M9325	6756075
PDMX 0905ZEEER-M:8215	PDMX 0905ZEEER-M:8215	6756188
PDMX 0905ZEEER-M:M8330	PDMX 0905ZEEER-M:M8330	7447926
PDMX 0905ZEEER-M:M8345	PDMX 0905ZEEER-M:M8345	6756190
PDMX 0905ZEEER-M:M9340	PDMX 0905ZEEER-M:M9340	6756191
PDMX 0905ZESR-R:8215	PDMX 0905ZESR-R:8215	6755681
PDMX 0905ZESR-R:M8330	PDMX 0905ZESR-R:M8330	7447927
PDMX 0905ZESR-R:M8345	PDMX 0905ZESR-R:M8345	6756076
PDMX 0905ZESR-R:M9325	PDMX 0905ZESR-R:M9325	7049050
PNNQ 1308DNSN:M8330	PNNQ 1308DNSN:M8330	7447928
PNNQ 1308DNSN:M8345	PNNQ 1308DNSN:M8345	6756181
PNNQ 1308DNSN:M9340	PNNQ 1308DNSN:M9340	6756182
PNMU 1308DNSR-M:8215	PNMU 1308DNSR-M:8215	6756162
PNMU 1308DNSR-M:M8330	PNMU 1308DNSR-M:M8330	7447929
PNMU 1308DNSR-M:M8345	PNMU 1308DNSR-M:M8345	6756164
PNMU 1308DNSR-M:M9315	PNMU 1308DNSR-M:M9315	6922558
PNMU 1308DNSR-M:M9340	PNMU 1308DNSR-M:M9340	6756165
PPH 0800-CL1:2003	PPH 0800-CL1:2003	7156080
PPH 0800-CL4:8215	PPH 0800-CL4:8215	7156088
PPH 1000-CL1:2003	PPH 1000-CL1:2003	7156081
PPH 1000-CL4:8215	PPH 1000-CL4:8215	7156089
PPH 1200-CL1:2003	PPH 1200-CL1:2003	7156082
PPH 1200-CL4:8215	PPH 1200-CL4:8215	7156090
PPH 1600-CL1:2003	PPH 1600-CL1:2003	7156083
PPH 1600-CL4:8215	PPH 1600-CL4:8215	7156091
PPH 2000-CL1:2003	PPH 2000-CL1:2003	7156084
PPH 2000-CL4:8215	PPH 2000-CL4:8215	7156092
PPH 2500-CL1:2003	PPH 2500-CL1:2003	7156085
PPH 2500-CL4:8215	PPH 2500-CL4:8215	7156093
PPH 3000-CL1:2003	PPH 3000-CL1:2003	7156086
PPH 3000-CL4:8215	PPH 3000-CL4:8215	7156094
PPH 3200-CL1:2003	PPH 3200-CL1:2003	7156087
PPH 3200-CL4:8215	PPH 3200-CL4:8215	7156095
PPHE 1000-SM1:8215	PPHE 1000-SM1:8215	7156096
PPHE 1200-SM1:8215	PPHE 1200-SM1:8215	7156097
PPHE 1600-SM1:8215	PPHE 1600-SM1:8215	7156098
PPHE 2000-SM1:8215	PPHE 2000-SM1:8215	7156099
PPHF 0800O4-CE1:M8330	PPHF 0800O4-CE1:M8330	7447933
PPHF 1000O5-CE1:M8330	PPHF 1000O5-CE1:M8330	7447934
PPHF 1200O6-CE1:M8330	PPHF 1200O6-CE1:M8330	7447935
PPHF 1600O8-CE1:M8330	PPHF 1600O8-CE1:M8330	7447936
PPHF 2000O10-CE1:M8330	PPHF 2000O10-CE1:M8330	7447937

ANSI	ISO	EDP
PPHF 250012-CE1:M8330	PPHF 250012-CE1:M8330	7447938
PPHT 0800O3-A2:2003	PPHT 0800O3-A2:2003	7156106
PPHT 0800O5-A2:2003	PPHT 0800O5-A2:2003	7156107
PPHT 0800O8-A2:2003	PPHT 0800O8-A2:2003	7156108
PPHT 0800O10-A2:2003	PPHT 0800O10-A2:2003	7156109
PPHT 1000O5-A2:2003	PPHT 1000O5-A2:2003	7156110
PPHT 1000O8-A2:2003	PPHT 1000O8-A2:2003	7156111
PPHT 1000O16-A2:2003	PPHT 1000O16-A2:2003	7156112
PPHT 1200O5-A2:2003	PPHT 1200O5-A2:2003	7156113
PPHT 1200O10-A2:2003	PPHT 1200O10-A2:2003	7156114
PPHT 1200O20-A2:2003	PPHT 1200O20-A2:2003	7156115
PPHT 1600O10-A2:2003	PPHT 1600O10-A2:2003	7156116
PPHT 1600O13-A2:2003	PPHT 1600O13-A2:2003	7156117
PPHT 1600O20-A2:2003	PPHT 1600O20-A2:2003	7156118
PPHT 1600O30-A2:2003	PPHT 1600O30-A2:2003	7156119
PPHT 2000O10-A2:2003	PPHT 2000O10-A2:2003	7156120
PPHT 2000O16-A2:2003	PPHT 2000O16-A2:2003	7156121
PPHT 2000O30-A2:2003	PPHT 2000O30-A2:2003	7156122
PPHT 2000O40-A2:2003	PPHT 2000O40-A2:2003	7156123
PPHT 2500O20-A2:2003	PPHT 2500O20-A2:2003	7156124
RC 08:M4310	RC 08:M4310	7637781
RC 08:M8310	RC 08:M8310	6922545
RC 08:M8330	RC 08:M8330	7637782
RC 08-F:M4310	RC 08-F:M4310	7637783
RC 10:M4310	RC 10:M4310	7637784
RC 10:M8310	RC 10:M8310	6922546
RC 10:M8330	RC 10:M8330	7637785
RC 10-F:M4310	RC 10-F:M4310	7637786
RC 12:M4310	RC 12:M4310	7637787
RC 12:M8310	RC 12:M8310	6922547
RC 12:M8330	RC 12:M8330	7637788
RC 12-F:M4310	RC 12-F:M4310	7637789
RC 16:M4310	RC 16:M4310	7637790
RC 16:M8310	RC 16:M8310	6922548
RC 16:M8330	RC 16:M8330	7637791
RC 16-F:M4310	RC 16-F:M4310	7637792
RC 16-F:M8330	RC 16-F:M8330	7637793
RC 20:M4310	RC 20:M4310	7637794
RC 20:M8310	RC 20:M8310	6922549
RC 20:M8330	RC 20:M8330	7637795
RC 20-F:M4310	RC 20-F:M4310	7637796
RC 20-F:M8330	RC 20-F:M8330	7637797
RC 25:M4310	RC 25:M4310	7637798
RC 25:M8310	RC 25:M8310	6922550
RC 25:M8330	RC 25:M8330	7637799
RC 32:M4310	RC 32:M4310	7637800
RC 32:M8330	RC 32:M8330	7637801
RCGT 0803MOF-AL:HF7	RCGT 0803MOF-AL:HF7	6751738
RCGT 0803MOF-AL:TO315	RCGT 0803MOF-AL:TO315	6756150
RCGT 1003MOF-AL:HF7	RCGT 1003MOF-AL:HF7	6756150
RCGT 1003MOF-AL:TO315	RCGT 1003MOF-AL:TO315	6756151
RCGX 0606O0 K15015:TC100	RCGX 0606O0 K15015:TC100	6755435
RCGX 0907O0 K15015:TC100	RCGX 0907O0 K15015:TC100	6755436
RCGX 1207O0 K15015:TC100	RCGX 1207O0 K15015:TC100	6755437
RCMH 3209MO-RM2:T9310	RCMH 3209MO-RM2:T9310	6755601
RCMT 0602MOE-FM:T7325	RCMT 0602MOE-FM:T7325	7156315
RCMT 0602MOE-FM:T8330	RCMT 0602MOE-FM:T8330	6754291
RCMT 0602MOE-FM:T9315	RCMT 0602MOE-FM:T9315	6754029
RCMT 0602MOE-FM:T9325	RCMT 0602MOE-FM:T9325	6753983
RCMT 0602MOE-UR:T6310	RCMT 0602MOE-UR:T6310	7168659
RCMT 0602MOE-UR:T7325	RCMT 0602MOE-UR:T7325	7156316
RCMT 0602MOE-UR:T8330	RCMT 0602MOE-UR:T8330	6754246
RCMT 0602MOE-UR:T9315	RCMT 0602MOE-UR:T9315	6922899
RCMT 0602MOE-UR:T9325	RCMT 0602MOE-UR:T9325	6754665
RCMT 0803MOE-FM:T7325	RCMT 0803MOE-FM:T7325	7156317
RCMT 0803MOE-FM:T8330	RCMT 0803MOE-FM:T8330	6754292
RCMT 0803MOE-FM:T9315	RCMT 0803MOE-FM:T9315	6754034
RCMT 0803MOE-FM:T9325	RCMT 0803MOE-FM:T9325	6753984
RCMT 0803MOE-RM3:T7325	RCMT 0803MOE-RM3:T7325	7248711
RCMT 0803MOE-RM3:T9315	RCMT 0803MOE-RM3:T9315	7248712
RCMT 0803MOE-UR:T6310	RCMT 0803MOE-UR:T6310	7168660
RCMT 0803MOE-UR:T7325	RCMT 0803MOE-UR:T7325	7156318
RCMT 0803MOE-UR:T8330	RCMT 0803MOE-UR:T8330	6754247
RCMT 0803MOE-UR:T9315	RCMT 0803MOE-UR:T9315	6754676
RCMT 0803MOE-UR:T9325	RCMT 0803MOE-UR:T9325	6754666
RCMT 10T3MOE-FM:T7325	RCMT 10T3MOE-FM:T7325	7156319

ANSI	ISO	EDP
RCMT 10T3MOE-FM:T8330	RCMT 10T3MOE-FM:T8330	6754293
RCMT 10T3MOE-FM:T9315	RCMT 10T3MOE-FM:T9315	6754037
RCMT 10T3MOE-FM:T9325	RCMT 10T3MOE-FM:T9325	6753985
RCMT 10T3MOE-UR:T6310	RCMT 10T3MOE-UR:T6310	7168661
RCMT 10T3MOE-UR:T7325	RCMT 10T3MOE-UR:T7325	7156320
RCMT 10T3MOE-UR:T8330	RCMT 10T3MOE-UR:T8330	6754248
RCMT 10T3MOE-UR:T9315	RCMT 10T3MOE-UR:T9315	6754679
RCMT 10T3MOE-UR:T9325	RCMT 10T3MOE-UR:T9325	6754690
RCMT 10T3MOSN-F:M6330	RCMT 10T3MOSN-F:M6330	7445881
RCMT 10T3MOSN-F:M8310	RCMT 10T3MOSN-F:M8310	7445758
RCMT 10T3MOSN-F:M8330	RCMT 10T3MOSN-F:M8330	7445759
RCMT 10T3MOSN-F:M8340	RCMT 10T3MOSN-F:M8340	7445880
RCMT 10T3MOSN-M:M6330	RCMT 10T3MOSN-M:M6330	7445886
RCMT 10T3MOSN-M:M8310	RCMT 10T3MOSN-M:M8310	7445882
RCMT 10T3MOSN-M:M8330	RCMT 10T3MOSN-M:M8330	7445883
RCMT 10T3MOSN-M:M8340	RCMT 10T3MOSN-M:M8340	7445884
RCMT 10T3MOSN-M:M8345	RCMT 10T3MOSN-M:M8345	7445885
RCMT 10T3MOSN-M:M9325	RCMT 10T3MOSN-M:M9325	7445887
RCMT 10T3MOSN-M:M9340	RCMT 10T3MOSN-M:M9340	7445888
RCMT 10T3MOSN-R:M5315	RCMT 10T3MOSN-R:M5315	7445892
RCMT 10T3MOSN-R:M8310	RCMT 10T3MOSN-R:M8310	7445889
RCMT 10T3MOSN-R:M8330	RCMT 10T3MOSN-R:M8330	7445890
RCMT 10T3MOSN-R:M8340	RCMT 10T3MOSN-R:M8340	7445891
RCMT 10T3MOSN-R:M9325	RCMT 10T3MOSN-R:M9325	7445893
RCMT 1204MOE-FM:T7325	RCMT 1204MOE-FM:T7325	7156321
RCMT 1204MOE-FM:T8330	RCMT 1204MOE-FM:T8330	6754294
RCMT 1204MOE-FM:T9315	RCMT 1204MOE-FM:T9315	6754049
RCMT 1204MOE-FM:T9325	RCMT 1204MOE-FM:T9325	6753986
RCMT 1204MOEN-F:8215	RCMT 1204MOEN-F:8215	6755677
RCMT 1204MOEN-F:M8310	RCMT 1204MOEN-F:M8310	6756236
RCMT 1204MOEN-F:M8330	RCMT 1204MOEN-F:M8330	7447939
RCMT 1204MOEN-R:M8310	RCMT 1204MOEN-R:M8310	6922551
RCMT 1204MOEN-R:M8330	RCMT 1204MOEN-R:M8330	7447950
RCMT 1204MOEN-R:M9315	RCMT 1204MOEN-R:M9315	6922559
RCMT 1204MOE-RM3:H07	RCMT 1204MOE-RM3:H07	7248713
RCMT 1204MOE-RM3:T7325	RCMT 1204MOE-RM3:T7325	7248714
RCMT 1204MOE-RM3:T8330	RCMT 1204MOE-RM3:T8330	7248715
RCMT 1204MOE-RM3:T9315	RCMT 1204MOE-RM3:T9315	7248716
RCMT 1204MOE-UR:T6310	RCMT 1204MOE-UR:T6310	7168662
RCMT 1204MOE-UR:T7325	RCMT 1204MOE-UR:T7325	7156322
RCMT 1204MOE-UR:T8330	RCMT 1204MOE-UR:T8330	6754249
RCMT 1204MOE-UR:T9315	RCMT 1204MOE-UR:T9315	6922900
RCMT 1204MOE-UR:T9325	RCMT 1204MOE-UR:T9325	6754691
RCMT 1204MOSN-M:M6330	RCMT 1204MOSN-M:M6330	6922534
RCMT 1204MOSN-M:M8310	RCMT 1204MOSN-M:M8310	6922552
RCMT 1204MOSN-M:M8330	RCMT 1204MOSN-M:M8330	7447951
RCMT 1204MOSN-M:M8345	RCMT 1204MOSN-M:M8345	6756049
RCMT 1204MOSN-M:M9325	RCMT 1204MOSN-M:M9325	6756050
RCMT 1204MOSN-M:M9340	RCMT 1204MOSN-M:M9340	6756051
RCMT 1204MOSN-R:M8345	RCMT 1204MOSN-R:M8345	6756054
RCMT 1204MOSN-R:M9315	RCMT 1204MOSN-R:M9315	6922560
RCMT 1606MOEN-F:M8310	RCMT 1606MOEN-F:M8310	6756237
RCMT 1606MOEN-F:M8330	RCMT 1606MOEN-F:M8330	7447952
RCMT 1606MOE-RM3:T7325	RCMT 1606MOE-RM3:T7325	7248717
RCMT 1606MOE-RM3:T8330	RCMT 1606MOE-RM3:T8330	7248718
RCMT 1606MOE-RM3:T9315	RCMT 1606MOE-RM3:T9315	7248719
RCMT 1606MOS-37:T9315	RCMT 1606MOS-37:T9315	6753742
RCMT 1606MOS-37:T9325	RCMT 1606MOS-37:T9325	6753831
RCMT 1606MOSN-M:M6330	RCMT 1606MOSN-M:M6330	6922535
RCMT 1		



ANSI	ISO	EDP
RCMT 2006MOSN-R:M8330	RCMT 2006MOSN-R:M8330	7447957
RCMT 2006MOSN-R:M8345	RCMT 2006MOSN-R:M8345	6756064
RCMT 2006MOSN-R:M9325	RCMT 2006MOSN-R:M9325	6922562
RCMT 2507MOE-RM3:H07	RCMT 2507MOE-RM3:H07	7248720
RCMT 2507MOS-372:T9325	RCMT 2507MOS-372:T9325	6753988
RCMT 3009MO-RR4:T9310	RCMT 3009MO-RR4:T9310	6755593
RCMT 3009MO-RR4:T9315	RCMT 3009MO-RR4:T9315	6755594
RCMW 0602MO:T5305	RCMW 0602MO:T5305	6755830
RCMW 0602MO:T5315	RCMW 0602MO:T5315	6922815
RCMW 0803MO:T5305	RCMW 0803MO:T5305	6755831
RCMW 0803MO:T5315	RCMW 0803MO:T5315	6922816
RCMW 10T3MO:T5305	RCMW 10T3MO:T5305	6755832
RCMW 10T3MO:T5315	RCMW 10T3MO:T5315	6922817
RCMW 1204MO:T5305	RCMW 1204MO:T5305	6755843
RCMW 1204MO:T5315	RCMW 1204MO:T5315	6922818
RCMX 1003MOS-31:T9325	RCMX 1003MOS-31:T9325	6753989
RCMX 1003MOS-31:T9335	RCMX 1003MOS-31:T9335	6754918
RCMX 1204MOS-321:T9315	RCMX 1204MOS-321:T9315	6922902
RCMX 1204MOS-321:T9325	RCMX 1204MOS-321:T9325	6753990
RCMX 1204MOS-321:T9335	RCMX 1204MOS-321:T9335	6754919
RCMX 1606MOS-331:6630	RCMX 1606MOS-331:6630	6751660
RCMX 1606MOS-331:T9315	RCMX 1606MOS-331:T9315	6753760
RCMX 1606MOS-331:T9325	RCMX 1606MOS-331:T9325	6753832
RCMX 1606MOS-331:T9335	RCMX 1606MOS-331:T9335	6754920
RCMX 1606MOS-37:T9315	RCMX 1606MOS-37:T9315	6754055
RCMX 1606MOS-37:T9325	RCMX 1606MOS-37:T9325	6753991
RCMX 2006MO-RF1:T5305	RCMX 2006MO-RF1:T5305	6755844
RCMX 2006MO-RF1:T9310	RCMX 2006MO-RF1:T9310	6755576
RCMX 2006MO-RF1:T9315	RCMX 2006MO-RF1:T9315	6755577
RCMX 2006MO-RF1:T9325	RCMX 2006MO-RF1:T9325	6755578
RCMX 2006MO-RF1:T9335	RCMX 2006MO-RF1:T9335	6754921
RCMX 2006MO-RM1:T9310	RCMX 2006MO-RM1:T9310	6755579
RCMX 2006MO-RM1:T9315	RCMX 2006MO-RM1:T9315	6755580
RCMX 2006MO-RM1:T9325	RCMX 2006MO-RM1:T9325	6755581
RCMX 2006MO-RM1:T9335	RCMX 2006MO-RM1:T9335	6754922
RCMX 2006MOS-341:6630	RCMX 2006MOS-341:6630	6751662
RCMX 2006MOS-341:6640	RCMX 2006MOS-341:6640	6751663
RCMX 2006MOS-37:6630	RCMX 2006MOS-37:6630	6752008
RCMX 2507MO-RF1:T8345	RCMX 2507MO-RF1:T8345	6754447
RCMX 2507MO-RF1:T9310	RCMX 2507MO-RF1:T9310	6755582
RCMX 2507MO-RF1:T9315	RCMX 2507MO-RF1:T9315	6755583
RCMX 2507MO-RF1:T9325	RCMX 2507MO-RF1:T9325	6755584
RCMX 2507MO-RF1:T9335	RCMX 2507MO-RF1:T9335	6754923
RCMX 2507MO-RM1:T9310	RCMX 2507MO-RM1:T9310	6755585
RCMX 2507MO-RM1:T9315	RCMX 2507MO-RM1:T9315	6755586
RCMX 2507MO-RM1:T9325	RCMX 2507MO-RM1:T9325	6755587
RCMX 2507MO-RM1:T9335	RCMX 2507MO-RM1:T9335	6754924
RCMX 2507MO-RM2:T9310	RCMX 2507MO-RM2:T9310	6755588
RCMX 2507MO-RM2:T9315	RCMX 2507MO-RM2:T9315	6755589
RCMX 2507MO-RM2:T9325	RCMX 2507MO-RM2:T9325	6755590
RCMX 2507MOS-351:6630	RCMX 2507MOS-351:6630	6751664
RCMX 2507MOS-351:6640	RCMX 2507MOS-351:6640	6751665
RCMX 2507MOS-37:6630	RCMX 2507MOS-37:6630	6751666
RCMX 3209MO-RM2:T5315	RCMX 3209MO-RM2:T5315	6802056
RCMX 3209MO-RM2:T9310	RCMX 3209MO-RM2:T9310	6755595
RCMX 3209MO-RM2:T9315	RCMX 3209MO-RM2:T9315	6755596
RCMX 3209MO-RM2:T9325	RCMX 3209MO-RM2:T9325	6755597
RCMX 3209MO-RM2:T9335	RCMX 3209MO-RM2:T9335	6754925
RCMX 3209MO-RR2:T9315	RCMX 3209MO-RR2:T9315	6755605
RCMX 3209MO-RR2:T9316	RCMX 3209MO-RR2:T9316	6874329
RCMX 3209MOS-361:6640	RCMX 3209MOS-361:6640	6751668
RDET 0802MOSN:M8340	RDET 0802MOSN:M8340	6800839
RDET 1003MOSN:8230	RDET 1003MOSN:8230	6755631
RDET 1003MOSN:M8340	RDET 1003MOSN:M8340	6800840
RDET 12T3MOSN:M8340	RDET 12T3MOSN:M8340	6800842
RDEX 1204MOSN-12:8230	RDEX 1204MOSN-12:8230	6755637
RDEX 1204MOSN-12:M8340	RDEX 1204MOSN-12:M8340	6800843
RDEX 1604MOSN-12:M8340	RDEX 1604MOSN-12:M8340	6800844
RDGT 0702MOT:M8310	RDGT 0702MOT:M8310	6756257
RDGT 0702MOT:M8325	RDGT 0702MOT:M8325	6755999
RDGT 0702MOT:M8345	RDGT 0702MOT:M8345	6755946
RDGT 1003MOT:M6330	RDGT 1003MOT:M6330	7601340
RDGT 1003MOT:M8310	RDGT 1003MOT:M8310	6756258
RDGT 1003MOT:M8325	RDGT 1003MOT:M8325	6756000
RDGT 1003MOT:M8345	RDGT 1003MOT:M8345	6755962
RDGT 1003MOT:M9340	RDGT 1003MOT:M9340	6755646

ANSI	ISO	EDP
RDGT 120500FN-F:M8310	RDGT 120500FN-F:M8310	7342900
RDGT 120500SN-FM:M8330	RDGT 120500SN-FM:M8330	7447958
RDGT 120500SN-FM:M8345	RDGT 120500SN-FM:M8345	7342902
RDGT 12T3MOT:M6330	RDGT 12T3MOT:M6330	7601341
RDGT 12T3MOT:M8310	RDGT 12T3MOT:M8310	6756279
RDGT 12T3MOT:M8325	RDGT 12T3MOT:M8325	6756001
RDGT 12T3MOT:M8345	RDGT 12T3MOT:M8345	6755963
RDGT 12T3MOT:M9340	RDGT 12T3MOT:M9340	6755647
RDGT 1604MOT:M6330	RDGT 1604MOT:M6330	7601342
RDGT 1604MOT:M8310	RDGT 1604MOT:M8310	6756280
RDGT 1604MOT:M8325	RDGT 1604MOT:M8325	6756002
RDGT 1604MOT:M8345	RDGT 1604MOT:M8345	6755964
RDGT 1604MOT:M9340	RDGT 1604MOT:M9340	6755648
RDHT 0702MO-FA:H7	RDHT 0702MO-FA:H7	6751849
RDHT 07T1MO-FA:H7	RDHT 07T1MO-FA:H7	6751850
RDHT 1003MO-FA:H7	RDHT 1003MO-FA:H7	6751851
RDHT 1003MO-FA:H7	RDHT 1003MO-FA:H7	6751852
RDHT 1604MO-FA:H7	RDHT 1604MO-FA:H7	6751853
RDHW 12T3MOENF6-91:2003	RDHW 12T3MOENF6-91:2003	7391483
RDHX 0501MOE:M8310	RDHX 0501MOE:M8310	6756281
RDHX 0702MOT:M4303	RDHX 0702MOT:M4303	7637288
RDHX 0702MOT:M8310	RDHX 0702MOT:M8310	6755668
RDHX 0702MOT:M8325	RDHX 0702MOT:M8325	6756003
RDHX 07T1MOT:M8310	RDHX 07T1MOT:M8310	6756282
RDHX 07T1MOT:M8325	RDHX 07T1MOT:M8325	6756007
RDHX 1003MOT:5040	RDHX 1003MOT:5040	6752056
RDHX 1003MOT:M4303	RDHX 1003MOT:M4303	7637289
RDHX 1003MOT:M8310	RDHX 1003MOT:M8310	6755669
RDHX 1003MOT:M8325	RDHX 1003MOT:M8325	6756005
RDHX 1003MOT:M8345	RDHX 1003MOT:M8345	6755965
RDHX 12T3MOT:M4303	RDHX 12T3MOT:M4303	7637287
RDHX 12T3MOT:M8310	RDHX 12T3MOT:M8310	6756221
RDHX 12T3MOT:M8325	RDHX 12T3MOT:M8325	6756006
RDHX 12T3MOT:M8345	RDHX 12T3MOT:M8345	6755966
RDHX 1604MOT:M8310	RDHX 1604MOT:M8310	6756283
RDHX 1604MOT:M8325	RDHX 1604MOT:M8325	6756008
RDHX 1604MOT:M8345	RDHX 1604MOT:M8345	6755967
RDHX 1604MOT:M9325	RDHX 1604MOT:M9325	7455502
RDHX 2006MOT:M8310	RDHX 2006MOT:M8310	6756284
RDHX 2006MOT:M8325	RDHX 2006MOT:M8325	6756009
RDMT 0702MOT:M8325	RDMT 0702MOT:M8325	7343096
RDMT 1003MOT:M8325	RDMT 1003MOT:M8325	7343097
RDMT 1003MOT:M8345	RDMT 1003MOT:M8345	7343098
RDMT 120500SN-R:M8330	RDMT 120500SN-R:M8330	7447959
RDMT 120500SN-R:M8340	RDMT 120500SN-R:M8340	7342904
RDMT 120500SN-R:M9340	RDMT 120500SN-R:M9340	7342905
RDMT 12T3MOT:M8325	RDMT 12T3MOT:M8325	7343099
RDMT 12T3MOT:M8345	RDMT 12T3MOT:M8345	7343110
RDMT 1604MOT:M8325	RDMT 1604MOT:M8325	7343111
RDMT 1604MOT:M8345	RDMT 1604MOT:M8345	7343112
RDMX 1003MOT:M8310	RDMX 1003MOT:M8310	6801016
RDMX 1003MOT:M8325	RDMX 1003MOT:M8325	6801018
RDMX 1003MOT:M8345	RDMX 1003MOT:M8345	6801019
RDMX 12T3MOT:M8310	RDMX 12T3MOT:M8310	6801017
RDMX 12T3MOT:M8325	RDMX 12T3MOT:M8325	6801040
RDMX 12T3MOT:M8345	RDMX 12T3MOT:M8345	6801041
RDMX 1604MOT:M8310	RDMX 1604MOT:M8310	6801044
RDMX 1604MOT:M8325	RDMX 1604MOT:M8325	6801042
RDMX 1604MOT:M8345	RDMX 1604MOT:M8345	6801043
REHT 1604MOEN-MM:M6330	REHT 1604MOEN-MM:M6330	6931678
REHT 1604MOEN-MM:M8310	REHT 1604MOEN-MM:M8310	6931661
REHT 1604MOEN-MM:M8330	REHT 1604MOEN-MM:M8330	7447960
REHT 1604MOEN-MM:M8340	REHT 1604MOEN-MM:M8340	6931662
REHT 1604MOEN-MM:M8345	REHT 1604MOEN-MM:M8345	7051463
REHT 1604MOEN-MM:M9325	REHT 1604MOEN-MM:M9325	6931660
REHT 1604MOEN-MM:M9340	REHT 1604MOEN-MM:M9340	7051472
REHT 1604MOSN-M:M8310	REHT 1604MOSN-M:M8310	6931665
REHT 1604MOSN-M:M8330	REHT 1604MOSN-M:M8330	7447961
REHT 1604MOSN-M:M8340	REHT 1604MOSN-M:M8340	6931666
REHT 1604MOSN-M:M9325	REHT 1604MOSN-M:M9325	6931664
REHT 2406MOEN-MM:M8330	REHT 2406MOEN-MM:M8330	7447962
REHT 2406MOEN-MM:M8340	REHT 2406MOEN-MM:M8340	7056797
REHT 2406MOEN-MM:M9325	REHT 2406MOEN-MM:M9325	7056798
REHT 2406MOSN-M:M8330	REHT 2406MOSN-M:M8330	7447963
REHT 2406MOSN-M:M8340	REHT 2406MOSN-M:M8340	7056801
RNG 32 T00420:TC100	RNGN 090300 T01020:TC100	6755415

ANSI	ISO	EDP
RNG 43 T00420:TC100	RNGN 120400 T01020:TC100	6755416
RNG 45 T00420:TC100	RNGN 120700 T01020:TC100	6755417
RNG 45 T06015:TC100	RNGN 120700 T15015:TC100	6755418
RNGH 381200-MM:T6310	RNGH 381200-MM:T6310	7317936
RNGH 381200-MM:T7325	RNGH 381200-MM:T7325	7317937
RNGH 381200-MM:T9315	RNGH 381200-MM:T9315	7317938
RNGH 381200-MR:6640	RNGH 381200-MR:6640	6752651
RNGH 381200-MR:T7325	RNGH 381200-MR:T7325	7347224
RNGH 381200-MR:T9226	RNGH 381200-MR:T9226	6931830
RNGH 381200-MR:T9315	RNGH 381200-MR:T9315	7347225
RNGH 5018MO-MM:M9340	RNGH 5018MO-MM:M9340	7317939
RNGH 5018MO-MM:T6310	RNGH 5018MO-MM:T6310	7317940
RNGH 5018MO-MM:T7325	RNGH 5018MO-MM:T7325	7317941
RNGH 5018MO-MM:T9315	RNGH 5018MO-MM:T9315	7317942
RNGH 5018MO-MR:M9340	RNGH 5018MO-MR:M9340	7347226
RNGH 5018MO-MR:T7325	RNGH 5018MO-MR:T7325	7347227
RNGH 5018MO-MR:T9335	RNGH 5018MO-MR:T9335	7347228
RNMG 43-08:T5305	RNMG 120400E-08:T5305	6755850
RNMG 43-08:T9315	RNMG 120400E-08:T9315	6754063
RNMG 43-08:T9325	RNMG 120400E-08:T9325	6753994
RNMG 54-08:T5305	RNMG 150600E-08:T5305	6755851
RNMG 54-08:T9315	RNMG 150600E-08:T9315	6754529
RNMG 54-08:T9325	RNMG 150600E-08:T9325	6753995
RNMG 64-08:T9315	RNMG 190600E-08:T9315	6754530
RNMG 64-08:T9325	RNMG 190600E-08:T9325	6753996
RNMG 86-08:T9315	RNMG 250900E-08:T9315	6754531
RNMG 86-08:T9325	RNMG 250900E-08:T9325	6753997
ROEX 56EN:S30	ROEX 1509MOEN:S30	7559851
RPET 1204MOSN:8215	RPET 1204MOSN:8215	6753403
RPET 1204MOSN:M8330	RPET 1204MOSN:M8330	7447964
RPET 1204MOSN:M8340	RPET 1204MOSN:M8340	6800845
RPET 1505MOS-M:M8330	RPET 1505MOS-M:M8330	7447965
RPET 1505MOS-M:M8340	RPET 1505MOS-M:M8340	6800846
RPEW 1204MOSN:M8330	RPEW 1204MOSN:M8330	7447966
RPEW 1204MOSN:M8340	RPEW 1204MOSN:M8340	6835886
RPEW 1505MOS:8215	RPEW 1505MOS:8215	6755639
RPEW 1505MOS:M8330	RPEW 1505MOS:M8330	7447967
RPEX 1204MOSN-12:M8330	RPEX 1204MOSN-12:M8330	7447968
RPEX 1204MOSN-12:M8340	RPEX 1204MOSN-12:M8340	6800847
SBKX 2207DZER:M8326	SBKX 2207DZER:M8326	6801307
SBMR 2207DZSR:M8326	SBMR 2207DZSR:M8326	6801308
SBMR 2207DZSR:M8346	SBMR 2207DZSR:M8346	6801309
SBMR 2207DZSR:M9325	SBMR 2207DZSR:M9325	7045689
SBMR 2207DZSR-R:M5326	SBMR 2207DZSR-R:M5326	6801279
SBMR 2207DZSR-R:M8326	SBMR 2207DZSR-R:M8326	6801310
SBMR 2207DZSR-R:M8346	SBMR 2207DZSR-R:M8346	6801311
SCET 050204-SD:D8330	SCET 050204-SD:D8330	6920783
SCET 050204-SD:D9335	SCET 050204-SD:D9335	6920784
SCET 050204-UD:D8330	SCET 050204-UD:D8330	6754634
SCET 050204-UD:D9335	SCET 050204-UD:D9335	6754635
SCET 060204-SD:D8330	SCET 060204-SD:D8330	6920785
SCET 060204-SD:D9335	SCET 060204-SD:D9335	6920786
SCET 060204-UD:D8330	SCET 060204-UD:D8330	6754635
SCET 060204-UD:D9335	SCET 060204-UD:D9335	6754651
SCET 070308-SD:D8330	SCET 070308-SD:D8330	6920787
SCET 070308-SD:D9335	SCET 070308-SD:D9335	6920788
SCET 070308-UD:D8330	SCET 070308-UD:D8330	6754636
SCET 070308-UD:D9335	SCET 070308-UD:D9335	67

ANSI	ISO	EDP
SCGT 32.52-SF3:T6310	SCGT 09T308E-SF3:T6310	7168577
SCGT 32.52-SF3:T8315	SCGT 09T308E-SF3:T8315	7168578
SCGT 432F-AL:HF7	SCGT 120408F-AL:HF7	6752103
SCGT 432F-AL:T0315	SCGT 120408F-AL:T0315	6756152
SCGT 432-NF1:H07	SCGT 120408E-NF1:H07	7167415
SCGT 432-NF1:T6310	SCGT 120408E-NF1:T6310	7167416
SCGT 432-NF1:T7325	SCGT 120408E-NF1:T7325	7167417
SKCR 09T340EN-F:M8330	SKCR 09T340EN-F:M8330	7447969
SKCR 12T360EN-F:M8330	SKCR 12T360EN-F:M8330	7447970
SCMT 1268-DR4:T9335	SCMT 380932E-DR4:T9335	6754928
SCMT 1268-OR:6635	SCMT 380932E-OR:6635	6752234
SCMT 1268-OR:T9226	SCMT 380932E-OR:T9226	6931866
SCMT 1268-OR:T9315	SCMT 380932E-OR:T9315	6933566
SCMT 1268-OR:T9325	SCMT 380932E-OR:T9325	6754003
SCMT 1268-OR:T9335	SCMT 380932E-OR:T9335	6754929
SCMT 1268-SR:T9335	SCMT 380932E-SR:T9335	6754930
SCMT 32.51-FF2:T8330	SCMT 09T304E-FF2:T8330	7156749
SCMT 32.51-FF2:T9325	SCMT 09T304E-FF2:T9325	7156750
SCMT 32.51-FM:T7325	SCMT 09T304E-FM:T7325	7156323
SCMT 32.51-FM:T7335	SCMT 09T304E-FM:T7335	6754798
SCMT 32.51-FM:T8315	SCMT 09T304E-FM:T8315	6753613
SCMT 32.51-FM:T8330	SCMT 09T304E-FM:T8330	6754275
SCMT 32.51-FM:T9315	SCMT 09T304E-FM:T9315	6754030
SCMT 32.51-FM:T9325	SCMT 09T304E-FM:T9325	6753998
SCMT 32.51-FM2:T7325	SCMT 09T304E-FM2:T7325	7156909
SCMT 32.51-FM2:T8330	SCMT 09T304E-FM2:T8330	7156910
SCMT 32.51-FM2:T9325	SCMT 09T304E-FM2:T9325	7156911
SCMT 32.51-UR:T7325	SCMT 09T304E-UR:T7325	7156324
SCMT 32.51-UR:T8330	SCMT 09T304E-UR:T8330	6754239
SCMT 32.51-UR:T9315	SCMT 09T304E-UR:T9315	6754675
SCMT 32.51-UR:T9325	SCMT 09T304E-UR:T9325	6754662
SCMT 32.52-FF2:T8330	SCMT 09T308E-FF2:T8330	7156752
SCMT 32.52-FF2:T9325	SCMT 09T308E-FF2:T9325	7156753
SCMT 32.52-FM:T7325	SCMT 09T308E-FM:T7325	7156325
SCMT 32.52-FM:T7335	SCMT 09T308E-FM:T7335	6754799
SCMT 32.52-FM:T8315	SCMT 09T308E-FM:T8315	6753614
SCMT 32.52-FM:T8330	SCMT 09T308E-FM:T8330	6754276
SCMT 32.52-FM:T9315	SCMT 09T308E-FM:T9315	6754031
SCMT 32.52-FM:T9325	SCMT 09T308E-FM:T9325	6753833
SCMT 32.52-FM2:T7325	SCMT 09T308E-FM2:T7325	7156912
SCMT 32.52-FM2:T8330	SCMT 09T308E-FM2:T8330	7156913
SCMT 32.52-FM2:T9315	SCMT 09T308E-FM2:T9315	7156914
SCMT 32.52-FM2:T9325	SCMT 09T308E-FM2:T9325	7156915
SCMT 32.52-FM2:T9335	SCMT 09T308E-FM2:T9335	7156916
SCMT 32.52-RF:6630	SCMT 09T308E-RF:6630	6756039
SCMT 32.52-RF:T5315	SCMT 09T308E-RF:T5315	6756041
SCMT 32.52-RF:T7335	SCMT 09T308E-RF:T7335	6756040
SCMT 32.52-RM:T5315	SCMT 09T308E-RM:T5315	6755762
SCMT 32.52-RM:T7335	SCMT 09T308E-RM:T7335	6754800
SCMT 32.52-RM:T8330	SCMT 09T308E-RM:T8330	6754397
SCMT 32.52-RM:T9315	SCMT 09T308E-RM:T9315	6754032
SCMT 32.52-RM:T9325	SCMT 09T308E-RM:T9325	6753834
SCMT 32.52-UR:T5315	SCMT 09T308E-UR:T5315	6755763
SCMT 32.52-UR:T7325	SCMT 09T308E-UR:T7325	7156326
SCMT 32.52-UR:T8330	SCMT 09T308E-UR:T8330	6754240
SCMT 32.52-UR:T9315	SCMT 09T308E-UR:T9315	6754674
SCMT 32.52-UR:T9325	SCMT 09T308E-UR:T9325	6754688
SCMT 32.52-UR:T9330	SCMT 09T308E-UR:T9330	6756262
SCMT 431-FM:T7325	SCMT 120404E-FM:T7325	7156327
SCMT 431-FM:T8315	SCMT 120404E-FM:T8315	6753615
SCMT 431-FM:T8330	SCMT 120404E-FM:T8330	6754277
SCMT 431-FM:T9315	SCMT 120404E-FM:T9315	6754033
SCMT 431-FM:T9325	SCMT 120404E-FM:T9325	6753999
SCMT 432-FM:T7325	SCMT 120408E-FM:T7325	7156328
SCMT 432-FM:T7335	SCMT 120408E-FM:T7335	6754801
SCMT 432-FM:T8315	SCMT 120408E-FM:T8315	6753616
SCMT 432-FM:T8330	SCMT 120408E-FM:T8330	6754278
SCMT 432-FM:T9315	SCMT 120408E-FM:T9315	6753743
SCMT 432-FM:T9325	SCMT 120408E-FM:T9325	6753835
SCMT 432-RF:6630	SCMT 120408E-RF:6630	6756042
SCMT 432-RF:T5315	SCMT 120408E-RF:T5315	6756044
SCMT 432-RF:T7335	SCMT 120408E-RF:T7335	6756043
SCMT 432-RM:T5305	SCMT 120408E-RM:T5305	6755853
SCMT 432-RM:T5315	SCMT 120408E-RM:T5315	6755765
SCMT 432-RM:T7335	SCMT 120408E-RM:T7335	6754802
SCMT 432-RM:T8330	SCMT 120408E-RM:T8330	6754398

ANSI	ISO	EDP
SCMT 432-RM:T9315	SCMT 120408E-RM:T9315	6753744
SCMT 432-RM:T9325	SCMT 120408E-RM:T9325	6753836
SCMT 432-RM3:T6310	SCMT 120408E-RM3:T6310	7248721
SCMT 432-RM3:T7325	SCMT 120408E-RM3:T7325	7248722
SCMT 432-RM3:T8330	SCMT 120408E-RM3:T8330	7248723
SCMT 432-RM3:T9315	SCMT 120408E-RM3:T9315	7248724
SCMT 432-RM3:T9325	SCMT 120408E-RM3:T9325	7248725
SCMT 432-RM3:T9335	SCMT 120408E-RM3:T9335	7248726
SCMT 432-UR:T5315	SCMT 120408E-UR:T5315	6755766
SCMT 432-UR:T7325	SCMT 120408E-UR:T7325	7156329
SCMT 432-UR:T8330	SCMT 120408E-UR:T8330	6754241
SCMT 432-UR:T9315	SCMT 120408E-UR:T9315	6754673
SCMT 432-UR:T9325	SCMT 120408E-UR:T9325	6754663
SCMT 433-FM:T7325	SCMT 120412E-FM:T7325	7156330
SCMT 433-FM:T8330	SCMT 120412E-FM:T8330	6754279
SCMT 433-FM:T9315	SCMT 120412E-FM:T9315	6754035
SCMT 433-FM:T9325	SCMT 120412E-FM:T9325	6754000
SCMT 433-RM3:T7325	SCMT 120412E-RM3:T7325	7248727
SCMT 433-RM3:T9325	SCMT 120412E-RM3:T9325	7248728
SCMT 433-UR:T8330	SCMT 120412E-UR:T8330	6754242
SCMT 433-UR:T9325	SCMT 120412E-UR:T9325	6754664
SCMT 866-OR:T9226	SCMT 250924E-OR:T9226	6931863
SCMT 866-OR:T9315	SCMT 250924E-OR:T9315	6933565
SCMT 866-OR:T9325	SCMT 250924E-OR:T9325	6754001
SCMT 866-OR:T9335	SCMT 250924E-OR:T9335	6754926
SCMT 866-SR:T9325	SCMT 250924E-SR:T9325	6754002
SCMT 866-SR:T9335	SCMT 250924E-SR:T9335	6754927
SCMW 32.51:T5305	SCMW 09T304:T5305	6755854
SCMW 32.51:T5315	SCMW 09T304:T5315	6922189
SCMW 32.52:T5305	SCMW 09T308:T5305	6755855
SCMW 32.52:T5315	SCMW 09T308:T5315	6922820
SCMW 432:T5305	SCMW 120408:T5305	6755856
SCMW 432:T5315	SCMW 120408:T5315	6922821
SDEW 322EN:M8330	SDEW 090308EN:M8330	7447971
SDEW 322EN:M8340	SDEW 090308EN:M8340	6800848
SDEW 322SN:M8315	SDEW 090308SN:M8315	6753404
SDEW 322SN:M8330	SDEW 090308SN:M8330	7447972
SDEW 322SN:M8340	SDEW 090308SN:M8340	6800849
SDEX 322FN-74:M8330	SDEX 090308FN-74:M8330	7447973
SDGX 120508EN-FM:M8330	SDGX 120508EN-FM:M8330	7447974
SDGX 120508EN-FM:M8345	SDGX 120508EN-FM:M8345	6756068
SDKT 1205AESN-FM:M6330	SDKT 1205AESN-FM:M6330	7601343
SDKT 1205AESN-FM:M8330	SDKT 1205AESN-FM:M8330	7447975
SDKT 1205AESN-FM:M8345	SDKT 1205AESN-FM:M8345	7342907
SDKT 1205PDR-F:8215	SDKT 1205PDR-F:8215	7342908
SDKT 1205PDR-FM:M8330	SDKT 1205PDR-FM:M8330	7447976
SDMT 1205PDR-FM:M8345	SDMT 1205PDR-FM:M8345	7342910
SDMT 120508PR-R:M8330	SDMT 120508PR-R:M8330	7447977
SDMT 120508PR-R:M8340	SDMT 120508PR-R:M8340	6800850
SDMT 120508PR-R:M9315	SDMT 120508PR-R:M9315	6754610
SDMT 120508PR-R:M9325	SDMT 120508PR-R:M9325	6754561
SDMT 120508SN-F:M8310	SDMT 120508SN-F:M8310	7342912
SDMT 120508SN-F:M8330	SDMT 120508SN-F:M8330	7447981
SDMT 120508SN-FM:M8345	SDMT 120508SN-FM:M8345	7342913
SDMT 120508SN-R:M8330	SDMT 120508SN-R:M8330	7447982
SDMT 120508SN-R:M8345	SDMT 120508SN-R:M8345	7342915
SDMT 120508SN-R:M9340	SDMT 120508SN-R:M9340	7342916
SDMT 120508SR-F:M8330	SDMT 120508SR-F:M8330	7447978
SDMT 120508SR-F:M8340	SDMT 120508SR-F:M8340	6800851
SDMT 120508SR-M:8215	SDMT 120508SR-M:8215	6753405
SDMT 120508SR-M:M8330	SDMT 120508SR-M:M8330	7447979
SDMT 120508SR-M:M8340	SDMT 120508SR-M:M8340	6800852
SDMT 120508SR-M:M9325	SDMT 120508SR-M:M9325	6754562
SDMT 120508SR-M:M8330	SDMT 120508SR-M:M8330	7447980
SDMT 1205AESN-R:M8340	SDMT 1205AESN-R:M8340	7342918
SDMX 120508EN-M:M8330	SDMX 120508EN-M:M8330	7447978
SDMX 120508EN-M:M8345	SDMX 120508EN-M:M8345	6756070
SEEN 42AFEN:M8330	SEEN 1203AFEN:M8330	7450962
SEEN 42AFEN:M8340	SEEN 1203AFEN:M8340	6800853
SEEN 42AFEN:M9315	SEEN 1203AFEN:M9315	6753406
SEEN 42AFEN:M8330	SEEN 1203AFEN:M8330	7450963
SEEN 42AFEN:M8340	SEEN 1203AFEN:M8340	6800854
SEEN 42AFEN:M9325	SEEN 1203AFEN:M9325	6754563
SEEN 42AFEN:M9340	SEEN 1203AFEN:M9340	6754595
SEEN 53AFEN:M8330	SEEN 1504AFEN:M8330	7450966

ANSI	ISO	EDP
SEEN 53AFEN:M8340	SEEN 1504AFEN:M8340	6800857
SEEN 53AFEN:M9315	SEEN 1504AFEN:M9315	6754612
SEEN 53AFEN:M9325	SEEN 1504AFEN:M9325	6754564
SEER 42AFEN:M8330	SEER 1203AFEN:M8330	7450967
SEER 42AFEN:M8340	SEER 1203AFEN:M8340	6941439
SEER 42AFEN:M8330	SEER 1203AFEN:M8330	7450968
SEER 42AFEN:M8340	SEER 1203AFEN:M8340	6800858
SEER 42AFEN:M9325	SEER 1203AFEN:M9325	6754565
SEER 42AFEN:M9340	SEER 1203AFEN:M9340	6754597
SEER 43AFEN:M8330	SEER 1204AFEN:M8330	7450969
SEER 43AFEN:M8330	SEER 1204AFEN:M8330	7451000
SEER 43AFEN:M8340	SEER 1204AFEN:M8340	6800859
SEER 53AFEN:M8330	SEER 1504AFEN:M8330	7451001
SEER 53AFEN:M8330	SEER 1504AFEN:M8330	7451002
SEER 53AFEN:M8340	SEER 1504AFEN:M8340	6800860
SEER 53AFEN:M9325	SEER 1504AFEN:M9325	6754566
SEET 09T3AFEN:8215	SEET 09T3AFEN:8215	6755671
SEET 09T3AFEN:M6330	SEET 09T3AFEN:M6330	6925530
SEET 09T3AFEN:M8330	SEET 09T3AFEN:M8330	7451003
SEET 09T3AFEN:M8340	SEET 09T3AFEN:M8340	6800861
SEET 09T3AFEN:M9325	SEET 09T3AFEN:M9325	6755674
SEET 09T3AFEN:M9340	SEET 09T3AFEN:M9340	6755675
SEET 1204AFEN:M8330	SEET 1204AFEN:M8330	7451004
SEET 1204AFEN:FA:HF7	SEET 1204AFEN:FA:HF7	6751838
SEET 1204AFEN:FA:M0315	SEET 1204AFEN:FA:M0315	6756272
SEET 1204AFEN:8215	SEET 1204AFEN:8215	6753407
SEET 1204AFEN:M8330	SEET 1204AFEN:M8330	7451005
SEET 1204AFEN:M8340	SEET 1204AFEN:M8340	6800862
SEET 1204AFEN:M9325	SEET 1204AFEN:M9325	6754567
SEET 1204AFEN:M9340	SEET 1204AFEN:M9340	6754600
SEET 12T3M-PM:M6330	SEET 12T3M-PM:M6330	7601344
SEET 12T3M-PM:M8330	SEET 12T3M-PM:M8330	7451006
SEET 12T3M-PM:M8340	SEET 12T3M-PM:M8340	6800863
SEET 12T3M-PM:M9325	SEET 12T3M-PM:M9325	6754568
SEET 12T3M-PM:M9340	SEET 12T3M-PM:M9340	6754599
SEEW 1204AFEN:M8330	SEEW 1204AFEN:M8330	7451007
SEEW 1204AFEN:M8340	SEEW 1204AFEN:M8340	6800864
SEEW 1204AFEN:8215	SEEW 1204AFEN:8215	6753408
SEEW 1204AFEN:M8330	SEEW 1204AFEN:M8330	7451008
SEEW 1204AFEN:M8340	SEEW 1204AFEN:M8340	6800865
SEEW 1204AFEN:M9325	SEEW 1204AFEN:M9325	6754569
SEMT 09T3AFEN:8215	SEMT 09T3AFEN:8215	6753409
SEMT 09T3AFEN:M8330	SEMT 09T3AFEN:M8330	7451009
SEMT 09T3AFEN:M8340	SEMT 09T3AFEN:M8340	6800866
SEMT 09T3AFEN:M9325	SEMT 09T3AFEN:M9325	6754570
SFCN 42EFFR:H10	SFCN 1203EFFR:H10	6751635
SFCN 42EFFR:M0315	SFCN 1203EFFR:M0315	6756273
SNET 130512SR-M:M8330	SNET 130512SR-M:M8330	7451010
SNET 130512SR-M:M8340	SNET 130512SR-M:M8340	6801304
SNG 322 T00420:TC100	SNGN 090308 T01020:TC100	6755439
SNG 323 T00420:TC100	SNGN 090317 T01020:TC100	6755437
SNG 431 T00420:TC100	SNGN 120404 T01020:TC100	6755440
SNG 432 T00420:TC100	SNGN 120408 T01020:TC100	6755441
SNG 452 T00420:TC100	SNGN 120708 T01020:TC100	6755442
SNG 453 T00420:TC100	SNGN 120712 T01020:TC100	6755443
SNGA 432 T00425:TC100	SNGA 120408 T01025:TC100	6755474
SNGA 433 T00420:TC100	SNGA 120412 T01020:TC100	6755419
SNGX 110416SR-M:8215	SNGX 110416SR-M:8215	7799778
SNGX 110416SR-M:M8310	SNGX 110416SR-M:M8310	7799777
SNGX 110416SR-M:M		

ANSI	ISO	EDP
SNHN 43ENEN:8215	SNHN 1204ENEN:8215	6753410
SNHN 43ENEN:M8330	SNHN 1204ENEN:M8330	7451015
SNHN 43ENEN:M8340	SNHN 1204ENEN:M8340	6800869
SNHN 43ENEN:M9325	SNHN 1204ENEN:M9325	6754572
SNHN 43ENEN:S26	SNHN 1204ENEN:S26	6751637
SNHN 53ENEN:8215	SNHN 1504ENEN:8215	6753411
SNHN 53ENEN:M8330	SNHN 1504ENEN:M8330	7451016
SNHN 53ENEN:S26	SNHN 1504ENEN:S26	6751639
SNKT 1205AZSR-M:M8330	SNKT 1205AZSR-M:M8330	7451023
SNKT 1205AZSR-M:M8340	SNKT 1205AZSR-M:M8340	6800884
SNKX 43ENFN:H10	SNKX 1204ENFN:H10	6751641
SNKX 53ENFN:H10	SNKX 1504ENFN:H10	6751642
SNMA 150608-R09:6640	SNMA 150608-R09:6640	7818826
SNMA 150608-R105:6640	SNMA 150608-R105:6640	7818897
SNMA 150608-R13:6640	SNMA 150608-R13:6640	7818828
SNMA 150608-R11:6640	SNMA 150608-R11:6640	7818827
SNMA 150608-R120:6640	SNMA 150608-R120:6640	7818898
SNMA 150608-R133:6640	SNMA 150608-R133:6640	7818828
SNMA 150608-R15:6640	SNMA 150608-R15:6640	7818829
SNMA 150608-R18:6640	SNMA 150608-R18:6640	7818880
SNMA 150608-R20:6640	SNMA 150608-R20:6640	7818881
SNMA 150608-R22:6640	SNMA 150608-R22:6640	7818882
SNMA 150608-R25:6640	SNMA 150608-R25:6640	7818883
SNMA 150608-R27:6640	SNMA 150608-R27:6640	7818884
SNMA 150608-R30:6640	SNMA 150608-R30:6640	7818885
SNMA 150608-R35:6640	SNMA 150608-R35:6640	7818886
SNMA 150608-R40:6640	SNMA 150608-R40:6640	7818887
SNMA 150608-R42:6640	SNMA 150608-R42:6640	7818888
SNMA 150608-R45:6640	SNMA 150608-R45:6640	7818889
SNMA 150608-R50:6640	SNMA 150608-R50:6640	7818890
SNMA 150608-R60:6640	SNMA 150608-R60:6640	7818891
SNMA 150608-R65:6640	SNMA 150608-R65:6640	7818892
SNMA 150608-R70:6640	SNMA 150608-R70:6640	7818893
SNMA 150608-R75:6640	SNMA 150608-R75:6640	7818894
SNMA 150608-R80:6640	SNMA 150608-R80:6640	7818895
SNMA 150608-R90:6640	SNMA 150608-R90:6640	7818896
SNMA 250924-R00:T9335	SNMA 250924-R00:T9335	6801267
SNMA 250924-R60:T9335	SNMA 250924-R60:T9335	6801269
SNMA 432:T5305	SNMA 120408:T5305	6755857
SNMA 432:T5315	SNMA 120408:T5315	6755767
SNMA 432:T6310	SNMA 120408:T6310	6922858
SNMA 433:T5305	SNMA 120412:T5305	6755858
SNMA 433:T5315	SNMA 120412:T5315	6755768
SNMA 433S:T5305	SNMA 120412S:T5305	6755859
SNMA 543:T5305	SNMA 150612:T5305	6755860
SNMA 543:T5315	SNMA 150612:T5315	6922796
SNMA 643:T5305	SNMA 190612:T5305	6755861
SNMA 643:T5315	SNMA 190612:T5315	6922797
SNMA 644:T5305	SNMA 190616:T5305	6755692
SNMA 644:T5315	SNMA 190616:T5315	6922798
SNMA 644S:T5305	SNMA 190616S:T5305	6755862
SNMA 856:T5305	SNMA 250724:T5305	6755863
SNMA 856:T5315	SNMA 250724:T5315	6922799
SNMA 856S:T5305	SNMA 250724S:T5305	6755864
SNMA 866:T5305	SNMA 250924:T5305	6755865
SNMA 866:T5315	SNMA 250924:T5315	6755693
SNMA 866S:T5305	SNMA 250924S:T5305	6755866
SNMG 431-FM:T6310	SNMG 120404E-FM:T6310	6922777
SNMG 431-FM:T7325	SNMG 120404E-FM:T7325	7156332
SNMG 431-FM:T8315	SNMG 120404E-FM:T8315	6753617
SNMG 431-FM:T8330	SNMG 120404E-FM:T8330	6754191
SNMG 431-FM:T9315	SNMG 120404E-FM:T9315	6754036
SNMG 431-FM:T9325	SNMG 120404E-FM:T9325	6754004
SNMG 431-NF:T6310	SNMG 120404E-NF:T6310	6922843
SNMG 431-NF:T7325	SNMG 120404E-NF:T7325	7156333
SNMG 431-NF:T7335	SNMG 120404E-NF:T7335	6834694
SNMG 431-NF:T8330	SNMG 120404E-NF:T8330	6834695
SNMG 431-NF:T9315	SNMG 120404E-NF:T9315	6834696
SNMG 431-NF:T9325	SNMG 120404E-NF:T9325	6834697
SNMG 431-SF:T7325	SNMG 120404E-SF:T7325	7156511
SNMG 431-SF:T9325	SNMG 120404E-SF:T9325	7035063
SNMG 432-FM:T7325	SNMG 120408E-FM:T7325	7156334
SNMG 432-FM:T8315	SNMG 120408E-FM:T8315	6753618
SNMG 432-FM:T8330	SNMG 120408E-FM:T8330	6754195
SNMG 432-FM:T9310	SNMG 120408E-FM:T9310	6755048
SNMG 432-FM:T9315	SNMG 120408E-FM:T9315	6753745
SNMG 432-FM:T9325	SNMG 120408E-FM:T9325	6754005

ANSI	ISO	EDP
SNMG 432-KR:T5305	SNMG 120408E-KR:T5305	6755867
SNMG 432-KR:T5315	SNMG 120408E-KR:T5315	6755769
SNMG 432-M:6630	SNMG 120408E-M:6630	6751564
SNMG 432-M:T5305	SNMG 120408E-M:T5305	6755868
SNMG 432-M:T5315	SNMG 120408E-M:T5315	6755770
SNMG 432-M:T9310	SNMG 120408E-M:T9310	6755049
SNMG 432-M:T9315	SNMG 120408E-M:T9315	6754038
SNMG 432-M:T9325	SNMG 120408E-M:T9325	6753837
SNMG 432-M:T9335	SNMG 120408E-M:T9335	6754931
SNMG 432-NF:H7	SNMG 120408E-NF:H7	6834698
SNMG 432-NF:T6310	SNMG 120408E-NF:T6310	6922844
SNMG 432-NF:T7325	SNMG 120408E-NF:T7325	7156335
SNMG 432-NF:T7335	SNMG 120408E-NF:T7335	6834699
SNMG 432-NF:T8315	SNMG 120408E-NF:T8315	6834700
SNMG 432-NF:T8330	SNMG 120408E-NF:T8330	6834701
SNMG 432-NF:T9315	SNMG 120408E-NF:T9315	6834702
SNMG 432-NF:T9325	SNMG 120408E-NF:T9325	6834703
SNMG 432-NM:T7325	SNMG 120408E-NM:T7325	7156336
SNMG 432-NM:T7335	SNMG 120408E-NM:T7335	6754803
SNMG 432-NM:T8315	SNMG 120408E-NM:T8315	6922673
SNMG 432-NM:T8330	SNMG 120408E-NM:T8330	6755113
SNMG 432-NM:T9325	SNMG 120408E-NM:T9325	6754006
SNMG 432-NMR:T6310	SNMG 120408E-NMR:T6310	7454465
SNMG 432-NMR:T7325	SNMG 120408E-NMR:T7325	7156337
SNMG 432-NMR:T7335	SNMG 120408E-NMR:T7335	7038087
SNMG 432-NMR:T8330	SNMG 120408E-NMR:T8330	7038084
SNMG 432-NMR:T9315	SNMG 120408E-NMR:T9315	7038085
SNMG 432-NMR:T9325	SNMG 120408E-NMR:T9325	7038086
SNMG 432-NRM:T7325	SNMG 120408E-NRM:T7325	7273527
SNMG 432-NRM:T7335	SNMG 120408E-NRM:T7335	7273528
SNMG 432-NRM:T9315	SNMG 120408E-NRM:T9315	7273526
SNMG 432-R:6630	SNMG 120408E-R:6630	6751565
SNMG 432-R:6640	SNMG 120408E-R:6640	6751566
SNMG 432-R:T5305	SNMG 120408E-R:T5305	6755869
SNMG 432-R:T9310	SNMG 120408E-R:T9310	6922949
SNMG 432-R:T9315	SNMG 120408E-R:T9315	6922903
SNMG 432-R:T9325	SNMG 120408E-R:T9325	6753838
SNMG 432-R:T9335	SNMG 120408E-R:T9335	6754932
SNMG 432-RM:T5305	SNMG 120408E-RM:T5305	6755870
SNMG 432-RM:T5315	SNMG 120408E-RM:T5315	6755771
SNMG 432-RM:T6310	SNMG 120408E-RM:T6310	6922778
SNMG 432-RM:T7325	SNMG 120408E-RM:T7325	7156338
SNMG 432-RM:T7335	SNMG 120408E-RM:T7335	6922699
SNMG 432-RM:T8315	SNMG 120408E-RM:T8315	6753619
SNMG 432-RM:T8330	SNMG 120408E-RM:T8330	6755129
SNMG 432-RM:T9310	SNMG 120408E-RM:T9310	6755050
SNMG 432-RM:T9315	SNMG 120408E-RM:T9315	6754039
SNMG 432-RM:T9325	SNMG 120408E-RM:T9325	6754007
SNMG 432-RM:T9335	SNMG 120408E-RM:T9335	6754933
SNMG 432-SF:H07	SNMG 120408E-SF:H07	6921016
SNMG 432-SF:T6310	SNMG 120408E-SF:T6310	6919790
SNMG 432-SF:T7325	SNMG 120408E-SF:T7325	7156512
SNMG 432-SF:T7335	SNMG 120408E-SF:T7335	6919791
SNMG 432-SF:T8315	SNMG 120408E-SF:T8315	6919792
SNMG 432-SF:T8330	SNMG 120408E-SF:T8330	6919793
SNMG 432-SF:T9325	SNMG 120408E-SF:T9325	7035065
SNMG 432-SM:T6310	SNMG 120408E-SM:T6310	6915841
SNMG 432-SM:T7325	SNMG 120408E-SM:T7325	7156339
SNMG 432-SM:T7335	SNMG 120408E-SM:T7335	6915842
SNMG 432-SM:T8330	SNMG 120408E-SM:T8330	6915843
SNMG 432-SM:T9315	SNMG 120408E-SM:T9315	6915844
SNMG 432-SM:T9325	SNMG 120408E-SM:T9325	6915845
SNMG 433-FM:T8330	SNMG 120412E-FM:T8330	6754196
SNMG 433-FM:T9315	SNMG 120412E-FM:T9315	6754040
SNMG 433-FM:T9325	SNMG 120412E-FM:T9325	6754008
SNMG 433-KR:T5305	SNMG 120412E-KR:T5305	6755871
SNMG 433-KR:T5315	SNMG 120412E-KR:T5315	6755694
SNMG 433-M:T9315	SNMG 120412E-M:T9315	6754041
SNMG 433-M:T9325	SNMG 120412E-M:T9325	6754009
SNMG 433-M:T9335	SNMG 120412E-M:T9335	6754934
SNMG 433-NM:T7325	SNMG 120412E-NM:T7325	7156341
SNMG 433-NM:T7335	SNMG 120412E-NM:T7335	6754804
SNMG 433-NM:T8315	SNMG 120412E-NM:T8315	6922674
SNMG 433-NM:T9325	SNMG 120412E-NM:T9325	6754010
SNMG 433-NMR:T6310	SNMG 120412E-NMR:T6310	7454466
SNMG 433-NMR:T7325	SNMG 120412E-NMR:T7325	7156342

ANSI	ISO	EDP
SNMG 433-NRM:T7335	SNMG 120412E-NRM:T7335	7038090
SNMG 433-NRM:T9315	SNMG 120412E-NRM:T9315	7038088
SNMG 433-NRM:T9325	SNMG 120412E-NRM:T9325	7038089
SNMG 433-NRM:T7325	SNMG 120412E-NRM:T7325	7273530
SNMG 433-NRM:T7335	SNMG 120412E-NRM:T7335	7273531
SNMG 433-NRM:T9315	SNMG 120412E-NRM:T9315	7273529
SNMG 433-R:6630	SNMG 120412E-R:6630	6751569
SNMG 433-R:T5305	SNMG 120412E-R:T5305	6755872
SNMG 433-R:T9310	SNMG 120412E-R:T9310	6922950
SNMG 433-R:T9325	SNMG 120412E-R:T9325	6754011
SNMG 433-R:T9335	SNMG 120412E-R:T9335	6754935
SNMG 433-RM:T5305	SNMG 120412E-RM:T5305	6755873
SNMG 433-RM:T5315	SNMG 120412E-RM:T5315	6755772
SNMG 433-RM:T6310	SNMG 120412E-RM:T6310	6922779
SNMG 433-RM:T7325	SNMG 120412E-RM:T7325	7156343
SNMG 433-RM:T7335	SNMG 120412E-RM:T7335	6922700
SNMG 433-RM:T9310	SNMG 120412E-RM:T9310	6755051
SNMG 433-RM:T9315	SNMG 120412E-RM:T9315	6754042
SNMG 433-RM:T9325	SNMG 120412E-RM:T9325	6754012
SNMG 433-RM:T9335	SNMG 120412E-RM:T9335	6754936
SNMG 433-SF:T6310	SNMG 120412E-SF:T6310	6919794
SNMG 433-SF:T7325	SNMG 120412E-SF:T7325	7156513
SNMG 433-SF:T8330	SNMG 120412E-SF:T8330	6919796
SNMG 433-SM:T7325	SNMG 120412E-SM:T7325	7156344
SNMG 433-SM:T7335	SNMG 120412E-SM:T7335	6915846
SNMG 433-SM:T9315	SNMG 120412E-SM:T9315	6915847
SNMG 433-SM:T9325	SNMG 120412E-SM:T9325	6915848
SNMG 434-FM:T8330	SNMG 120416E-FM:T8330	6754197
SNMG 434-FM:T9325	SNMG 120416E-FM:T9325	6754013
SNMG 434-NM:T7325	SNMG 120416E-NM:T7325	7156346
SNMG 434-NM:T7335	SNMG 120416E-NM:T7335	7038092
SNMG 434-NM:T9325	SNMG 120416E-NM:T9325	7038091
SNMG 434-R:T9315	SNMG 120416E-R:T9315	6922904
SNMG 434-R:T9325	SNMG 120416E-R:T9325	6754015
SNMG 434-RM:T5315	SNMG 120416E-RM:T5315	6755773
SNMG 434-RM:T7335	SNMG 120416E-RM:T7335	6922701
SNMG 434-RM:T8330	SNMG 120416E-RM:T8330	6755130
SNMG 434-RM:T9315	SNMG 120416E-RM:T9315	6754045
SNMG 434-RM:T9325	SNMG 120416E-RM:T9325	6754016
SNMG 543-M:6630	SNMG 150612E-M:6630	6751575
SNMG 543-M:T9315	SNMG 150612E-M:T9315	6754046
SNMG 543-M:T9325	SNMG 150612E-M:T9325	6754017
SNMG 543-M:T9335	SNMG 150612E-M:T9335	6754939
SNMG 543-NMR:T6310	SNMG 150612E-NMR:T6310	7454467
SNMG 543-NM:T7325	SNMG 150612E-NM:T7325	7156348
SNMG 543-NM:T9315	SNMG 150612E-NM:T9315	7038093
SNMG 543-NM:T9325	SNMG 150612E-NM:T9325	7038094
SNMG 543-NM:T7325	SNMG 150612E-NM:T7325	7273533
SNMG 543-NM:T7335	SNMG 150612E-NM:T7335	7273534
SNMG 543-NRM:T9315	SNMG 150612E-NRM:T9315	7273532
SNMG 543-R:T5305	SNMG 150612E-R:T5305	6755875
SNMG 543-R:T5315	SNMG 150612E-R:T5315	6922760
SNMG 543-R:T9315	SNMG 150612E-R:T9315	6922905
SNMG 543-R:T9325	SNMG 150612E-R:T9325	6754018
SNMG 543-RM:T5315	SNMG 150612E-RM:T5315	6755774
SNMG 543-RM:T6310	SNMG 150612E-RM:T6310	6922780
SNMG 543-RM:T7325	SNMG 150612E-RM:T7325	7156349
SNMG 543-RM:T7335	SNMG 150612E-RM:T7335	6922702
SNMG 543-RM:T9310	SNMG 150612E-RM:T9310	6755053
SNMG 543-RM:T9315	SNMG 150612E-RM:T9315	6754047

ANSI	ISO	EDP	ANSI	ISO	EDP	ANSI	ISO	EDP
SNMG 643-M:T9335	SNMG 190612E-M:T9335	6754942	SNMM 433-DR:T9315	SNMM 120412E-DR:T9315	6922911	SNMM 856-923:T9315	SNMM 250724S-923:T9315	6933591
SNMG 643-NMR:T6310	SNMG 190612E-NMR:T6310	7454468	SNMM 433-DR:T9325	SNMM 120412E-DR:T9325	6754125	SNMM 856-HR:6630	SNMM 250724E-HR:6630	6751562
SNMG 643-NMR:T7325	SNMG 190612E-NMR:T7325	7156351	SNMM 433-DR:T9335	SNMM 120412E-DR:T9335	6754948	SNMM 856-HR:6640	SNMM 250724E-HR:6640	6751563
SNMG 643-NMR:T7335	SNMG 190612E-NMR:T7335	7038097	SNMM 433-NR2:T7335	SNMM 120412E-NR2:T7335	6754807	SNMM 856-HR:T8345	SNMM 250724E-HR:T8345	6753685
SNMG 643-NMR:T9315	SNMG 190612E-NMR:T9315	7038095	SNMM 433-NR2:T8330	SNMM 120412E-NR2:T8330	6755141	SNMM 856-HR:T9315	SNMM 250724E-HR:T9315	6933569
SNMG 643-NMR:T9325	SNMG 190612E-NMR:T9325	7038096	SNMM 433-OR:T9315	SNMM 120412E-OR:T9315	6754532	SNMM 856-HR:T9325	SNMM 250724E-HR:T9325	6753841
SNMG 643-NRM:T7325	SNMG 190612E-NRM:T7325	7273539	SNMM 433-OR:T9325	SNMM 120412E-OR:T9325	6754127	SNMM 856-HR:T9335	SNMM 250724E-HR:T9335	6754963
SNMG 643-NRM:T7335	SNMG 190612E-NRM:T7335	7273540	SNMM 434-OR:T9325	SNMM 120416E-OR:T9325	6754128	SNMM 856-HR:T9226	SNMM 250724E-HR:T9226	7015719
SNMG 643-NRM:T9315	SNMG 190612E-NRM:T9315	7273538	SNMM 542-OR:T9325	SNMM 150608E-OR:T9325	6754129	SNMM 856-HR:T9315	SNMM 250724E-HR:T9315	7015718
SNMG 643-R:6630	SNMG 190612E-R:6630	6751579	SNMM 542-OR:T9335	SNMM 150608E-OR:T9335	6754129	SNMM 856-NR2:T9226	SNMM 250724E-NR2:T9226	7015719
SNMG 643-R:6640	SNMG 190612E-R:6640	6751580	SNMM 543-DR:T9325	SNMM 150612E-DR:T9325	6754130	SNMM 856-NR2:T9315	SNMM 250724E-NR2:T9315	7015750
SNMG 643-R:T9310	SNMG 190612E-R:T9310	6922954	SNMM 543-DR:T9335	SNMM 150612E-DR:T9335	6754130	SNMM 856-NR2:T8330	SNMM 250724E-NR2:T8330	6754813
SNMG 643-R:T9315	SNMG 190612E-R:T9315	6922907	SNMM 543-DR:T9325	SNMM 150612E-DR:T9325	6754950	SNMM 856-NR2:T9325	SNMM 250724E-NR2:T9325	6755144
SNMG 643-R:T9325	SNMG 190612E-R:T9325	6754023	SNMM 543-NR2:T7325	SNMM 150612E-NR2:T7325	7156361	SNMM 856-NR2:T9315	SNMM 250724E-NR2:T9315	6931873
SNMG 643-RM:T5305	SNMG 190612E-RM:T5305	6755878	SNMM 543-NR2:T7335	SNMM 150612E-NR2:T7335	6754808	SNMM 856-NR2:T9325	SNMM 250724E-NR2:T9325	6933590
SNMG 643-RM:T5315	SNMG 190612E-RM:T5315	6755776	SNMM 543-NR2:T8330	SNMM 150612E-NR2:T8330	6755142	SNMM 856-NRM:T7335	SNMM 250724E-NRM:T7335	7273555
SNMG 643-RM:T7325	SNMG 190612E-RM:T7325	7156352	SNMM 543-OR:T9325	SNMM 150612E-OR:T9325	6754132	SNMM 856-NRM:T9315	SNMM 250724E-NRM:T9315	7273553
SNMG 643-RM:T7335	SNMG 190612E-RM:T7335	6922704	SNMM 543-OR:T9335	SNMM 150612E-OR:T9335	6754951	SNMM 856-OR:6630	SNMM 250724E-OR:6630	6752093
SNMG 643-RM:T9310	SNMG 190612E-RM:T9310	6755054	SNMM 544-NR2:T7335	SNMM 150616E-NR2:T7335	6754809	SNMM 856-OR:T8330	SNMM 250724E-OR:T8330	6755153
SNMG 643-RM:T9315	SNMG 190612E-RM:T9315	6754051	SNMM 544-NR2:T9325	SNMM 150616E-NR2:T9325	6754133	SNMM 856-OR:T8345	SNMM 250724E-OR:T8345	6753691
SNMG 643-RM:T9325	SNMG 190612E-RM:T9325	6754024	SNMM 544-OR:T9315	SNMM 150616E-OR:T9315	6754091	SNMM 856-OR:T9315	SNMM 250724E-OR:T9315	6754096
SNMG 643-RM:T9335	SNMG 190612E-RM:T9335	6754943	SNMM 544-OR:T9325	SNMM 150616E-OR:T9325	6754134	SNMM 856-OR:T9325	SNMM 250724E-OR:T9325	6754151
SNMG 643-SM:T6310	SNMG 190612E-SM:T6310	6915849	SNMM 643-DR:6640	SNMM 190612E-DR:6640	6751658	SNMM 856-OR:T9335	SNMM 250724E-OR:T9335	6754964
SNMG 643-SM:T7325	SNMG 190612E-SM:T7325	7156353	SNMM 643-DR:T9325	SNMM 190612E-DR:T9325	6754135	SNMM 856-SR:6640	SNMM 250724S-SR:6640	6752118
SNMG 643-SM:T7335	SNMG 190612E-SM:T7335	6915850	SNMM 643-DR:T9335	SNMM 190612E-DR:T9335	6754952	SNMM 856-SR:T9226	SNMM 250724S-SR:T9226	6931876
SNMG 643-SM:T9325	SNMG 190612E-SM:T9325	6915851	SNMM 643-NR2:T7335	SNMM 190612E-NR2:T7335	6754810	SNMM 856-SR:T9325	SNMM 250724S-SR:T9325	6754152
SNMG 644-M:T9315	SNMG 190616E-M:T9315	6754052	SNMM 643-NR2:T9325	SNMM 190612E-NR2:T9325	6754136	SNMM 858-HR:T9325	SNMM 250732E-HR:T9325	6754153
SNMG 644-M:T9325	SNMG 190616E-M:T9325	6754025	SNMM 643-OR:T8330	SNMM 190612E-OR:T8330	6755151	SNMM 858-HR:T9315	SNMM 250732E-HR:T9315	7036358
SNMG 644-M:T9335	SNMG 190616E-M:T9335	6754944	SNMM 643-OR:T9315	SNMM 190612E-OR:T9315	6754092	SNMM 866-923:T8330	SNMM 250924S-923:T8330	6754252
SNMG 644-NMR:T6310	SNMG 190616E-NMR:T6310	7454469	SNMM 643-OR:T9325	SNMM 190612E-OR:T9325	6754138	SNMM 866-923:T8345	SNMM 250924S-923:T8345	6753694
SNMG 644-NMR:T7325	SNMG 190616E-NMR:T7325	7156354	SNMM 643-OR:T9335	SNMM 190612E-OR:T9335	6754953	SNMM 866-923:T9226	SNMM 250924S-923:T9226	6931881
SNMG 644-NMR:T7335	SNMG 190616E-NMR:T7335	7038100	SNMM 644-923:T8330	SNMM 190616E-923:T8330	6754255	SNMM 866-923:T9315	SNMM 250924S-923:T9315	6933594
SNMG 644-NMR:T9315	SNMG 190616E-NMR:T9315	7038098	SNMM 644-923:T8345	SNMM 190616E-923:T8345	6753692	SNMM 866-923:T9335	SNMM 250924S-923:T9335	6754969
SNMG 644-NMR:T9325	SNMG 190616E-NMR:T9325	7038099	SNMM 644-923:T9335	SNMM 190616E-923:T9335	6754958	SNMM 866-HR:6630	SNMM 250924E-HR:6630	6752029
SNMG 644-NRM:T7325	SNMG 190616E-NRM:T7325	7271036	SNMM 644-DR:T9325	SNMM 190616E-DR:T9325	6754137	SNMM 866-HR:T8345	SNMM 250924E-HR:T8345	6753686
SNMG 644-NRM:T7335	SNMG 190616E-NRM:T7335	7271037	SNMM 644-DR:T9335	SNMM 190616E-DR:T9335	6754954	SNMM 866-HR:T9315	SNMM 250924E-HR:T9315	6933592
SNMG 644-NRM:T9315	SNMG 190616E-NRM:T9315	7271035	SNMM 644-HR:6630	SNMM 190616E-HR:6630	6751613	SNMM 866-HR:T9325	SNMM 250924E-HR:T9325	6753842
SNMG 644-R:6630	SNMG 190616E-R:6630	6751581	SNMM 644-HR:T8345	SNMM 190616E-HR:T8345	6753682	SNMM 866-HR:T9335	SNMM 250924E-HR:T9335	6753298
SNMG 644-R:T9310	SNMG 190616E-R:T9310	6922955	SNMM 644-HR:T9325	SNMM 190616E-HR:T9325	6754140	SNMM 866-HR:T9226	SNMM 250924E-HR:T9226	7015752
SNMG 644-R:T9315	SNMG 190616E-R:T9315	6922908	SNMM 644-HR:T9335	SNMM 190616E-HR:T9335	6754955	SNMM 866-HR2:T9315	SNMM 250924E-HR2:T9315	7015751
SNMG 644-R:T9325	SNMG 190616E-R:T9325	6754026	SNMM 644-HR2:T9335	SNMM 190616E-HR2:T9335	7036354	SNMM 866-HR2:T9335	SNMM 250924E-HR2:T9335	7015753
SNMG 644-R:T9335	SNMG 190616E-R:T9335	6922762	SNMM 644-NR2:T7325	SNMM 190616E-NR2:T7325	7156364	SNMM 866-NR2:T7325	SNMM 250924E-NR2:T7325	7156367
SNMG 644-RM:T5305	SNMG 190616E-RM:T5305	6755879	SNMM 644-NR2:T7335	SNMM 190616E-NR2:T7335	6754811	SNMM 866-NR2:T9315	SNMM 250924E-NR2:T9315	6754814
SNMG 644-RM:T5315	SNMG 190616E-RM:T5315	6755777	SNMM 644-NR2:T8330	SNMM 190616E-NR2:T8330	6755143	SNMM 866-NR2:T9226	SNMM 250924E-NR2:T9226	6931879
SNMG 644-RM:T6310	SNMG 190616E-RM:T6310	6922781	SNMM 644-NR2:T9325	SNMM 190616E-NR2:T9325	6754142	SNMM 866-NR2:T9335	SNMM 250924E-NR2:T9335	6933593
SNMG 644-RM:T7335	SNMG 190616E-RM:T7335	6922705	SNMM 644-OR:6630	SNMM 190616E-OR:6630	6752091	SNMM 866-NRM:T7325	SNMM 250924E-NRM:T7325	7273557
SNMG 644-RM:T9310	SNMG 190616E-RM:T9310	6755055	SNMM 644-OR:T8330	SNMM 190616E-OR:T8330	6755152	SNMM 866-NRM:T7335	SNMM 250924E-NRM:T7335	7273558
SNMG 644-RM:T9315	SNMG 190616E-RM:T9315	6754053	SNMM 644-OR:T8345	SNMM 190616E-OR:T8345	6753690	SNMM 866-NRM:T9315	SNMM 250924E-NRM:T9315	7273556
SNMG 644-RM:T9325	SNMG 190616E-RM:T9325	6754027	SNMM 644-OR:T9325	SNMM 190616E-OR:T9325	6753839	SNMM 866-OR:T8330	SNMM 250924E-OR:T8330	6755154
SNMG 644-RM:T9335	SNMG 190616E-RM:T9335	6754945	SNMM 644-OR:T9335	SNMM 190616E-OR:T9335	6754956	SNMM 866-OR:T9226	SNMM 250924E-OR:T9226	6931880
SNMG 644-SM:T7325	SNMG 190616E-SM:T7325	7156356	SNMM 644-OR1:6630	SNMM 190616E-OR1:6630	6752025	SNMM 866-OR:T9315	SNMM 250924E-OR:T9315	6753747
SNMG 644-SM:T7335	SNMG 190616E-SM:T7335	6915852	SNMM 644-OR1:T9325	SNMM 190616E-OR1:T9325	6753840	SNMM 866-OR:T9325	SNMM 250924E-OR:T9325	6754155
SNMG 644-SM:T9325	SNMG 190616E-SM:T9325	6915853	SNMM 644-OR1:T9335	SNMM 190616E-OR1:T9335	6754957	SNMM 866-OR:T9335	SNMM 250924E-OR:T9335	6754968
SNMG 856-NRM:T7325	SNMG 250724-NRM:T7325	7273545	SNMM 646-HR:T8345	SNMM 190624E-HR:T8345	6753683	SNMM 866-SR:6630	SNMM 250924S-SR:6630	6752129
SNMG 856-NRM:T7335	SNMG 250724-NRM:T7335	7273546	SNMM 646-HR:T9315	SNMM 190624E-HR:T9315	6922918	SNMM 866-SR:T9335	SNMM 250924S-SR:T9335	6754970
SNMG 856-NRM:T9315	SNMG 250724-NRM:T9315	7273544	SNMM 646-HR:T9325	SNMM 190624E-HR:T9325	6754145	SNMM 868-923:T9226	SNMM 250932S-923:T9226	6931884
SNMG 866-NRM:T7325	SNMG 250924-NRM:T7325	7273548	SNMM 646-HR:T9335	SNMM 190624E-HR:T9335	6754959	SNMM 868-HR:T9325	SNMM 250932E-HR:T9325	6754157
SNMG 866-NRM:T7335	SNMG 250924-NRM:T7335	7273549	SNMM 646-HR2:T9315	SNMM 190624E-HR2:T9315	7036355	SNMM 868-HR2:T9315	SNMM 250932E-HR2:T9315	7036361
SNMG 866-NRM:T9315	SNMG 250924-NRM:T9315	7273547	SNMM 646-HR2:T9335	SNMM 190624E-HR2:T9335	7036357	SNMM 868-HR2:T9335	SNMM 250932E-HR2:T9335	7036363
SNMG 866-NRM:T9325	SNMG 250924-NRM:T9325	7156357	SNMM 646-NR2:T7325	SNMM 190624E-NR2:T7325	7156365	SNMT 1205AZSR-M:8215	SNMT 1205AZSR-M:8215	6753416
SNMG 866-NRM:T9335	SNMG 250924-NRM:T9335	6754028	SNMM 646-NR2:T9325	SNMM 190624E-NR2:T9325	6754812	SNMT 1205AZSR-M:M8330	SNMT 1205AZSR-M:M8330	67541024
SNMG 866-NRM:T9335	SNMG 250924E-NRM:T9335	6754946	SNMM 646-NR2:T9335	SNMM 190624E-NR2:T9335	6754146	SNMT 1205AZSR-M:M8340	SNMT 1205AZSR-M:M8340	6800885
SNMM 432-NR:T7325	SNMM 120408E-NR:T7325	7156358	SNMM 646-OR:T9315	SNMM 190624E-OR:T9315	6754094	SNMT 1205AZSR-M:M9315	SNMT 1205AZSR-M:M9315	6754614
SNMM 432-NR:T7335	SNMM 120408E-NR:T7335	6754805	SNMM 646-OR:T9325	SNMM 190624E-OR:T9325	6754147	SNMT 1205AZSR-M:M9325	SNMT 1205AZSR-M:M9325	6754575
SNMM 432-NR:T8330	SNMM 120408E-NR:T8330	6754190	SNMM 854-HR:T8345	SNMM 250716E-HR:T8345	6753684	SNMT 1205AZSR-R:8215	SNMT 1205AZSR-R:8215	6753417
SNMM 432-NR:T9325	SNMM 120408E-NR:T9325	6754122	SNMM 854-HR:T9325	SNMM 250716E-HR:T9325	6754148	SNMT 1205AZSR-R:M5315	SNMT 1205AZSR-R:M5315	6754628
SNMM 432-NR2:T7325	SNMM 120408E-NR2:T7325	7156359	SNMM 854-HR:T9335	SNMM 250716E-HR:T9335	6754960	SNMT 1205AZSR-R:M8330	SNMT 1205AZSR-R:M8330	7451025
SNMM 432-NR2:T7335	SNMM 120408E-NR2:T7335	6754806	SNMM 854-NRM:T7325	SNMM 250716E-NRM:T7325	7273551	SNMT 1205AZSR-R:M8340	SNMT 1205AZSR-R:M8340	6800886
SNMM 432-NR2:T8330	SNMM 120408E-NR2:T8330	6755140	SNMM 854-NRM:T7335	SNMM 250716E-NRM:T7335	7273552	SNMT 1205AZSR-R:M9315	SNMT 1205AZSR-R:M9315	6754615
SNMM 432-NR2:T9325	SNMM 120408E-NR2:T9325	6754123	SNMM 854-NRM:T9315	SNMM 250716E-NRM:T9315	7273550	SNMT 1205AZSR-R:M9325	SNMT 1205AZSR-R:M9325	6754576
SNMM 432-OR:T9315	SNMM 120408E-OR:T9315	6754089	SNMM 854-OR:T9226	SNMM 250716E-OR:T9226	6931871	SNMX 150708-R09:6640	SNMX 150708-R09:6640	7817078
SNMM 432-OR:T9325	SNMM 120408E-OR:T9325	6754124	SNMM 854-OR:T9325	SNMM 250716E-OR:T9325	6754149	SNMX 150708-R100:6640	SNMX 150708-R100:6640	7817119
SNMM 432-OR:T9335	SNMM 120408E-OR:T9335	6754947	SNMM 856-923:T8330	SNMM 250724S-923:T8330	6754253	SNMX 150708-R105:6640	SNMX 150708-R105:6640	7817120



ANSI	ISO	EDP	ANSI	ISO	EDP	ANSI	ISO	EDP
SNMX 150708-R11:6640	SNMX 150708-R11:6640	7817079	SNMX 19-R35:6640	SNMX 19-R35:6640	6755000	SPET 120408S:M8340	SPET 120408S:M8340	6800890
SNMX 150708-R13:6640	SNMX 150708-R13:6640	7817100	SNMX 19-R35:T9335	SNMX 19-R35:T9335	6803679	SPET 1204ADEN:8230	SPET 1204ADEN:8230	6752568
SNMX 150708-R15:6640	SNMX 150708-R15:6640	7817101	SNMX 19-R40:6640	SNMX 19-R40:6640	6752365	SPET 1204ADEN:M8330	SPET 1204ADEN:M8330	7451035
SNMX 150708-R18:6640	SNMX 150708-R18:6640	7817102	SNMX 19-R40:T9335	SNMX 19-R40:T9335	6801239	SPET 1204ADEN:M8340	SPET 1204ADEN:M8340	6800891
SNMX 150708-R20:6640	SNMX 150708-R20:6640	7817103	SNMX 19-R45:6640	SNMX 19-R45:6640	6755661	SPET 1204ADSN:M8330	SPET 1204ADSN:M8330	7451036
SNMX 150708-R22:6640	SNMX 150708-R22:6640	7817104	SNMX 19-R45:T9335	SNMX 19-R45:T9335	6801236	SPET 1204ADSN:M8340	SPET 1204ADSN:M8340	6800892
SNMX 150708-R25:6640	SNMX 150708-R25:6640	7817105	SNMX 19-R50:6640	SNMX 19-R50:6640	6752121	SPEW 1204ADEN:M8330	SPEW 1204ADEN:M8330	7451037
SNMX 150708-R27:6640	SNMX 150708-R27:6640	7817106	SNMX 19-R50:T9335	SNMX 19-R50:T9335	6801240	SPEW 1204ADEN:M8340	SPEW 1204ADEN:M8340	6800893
SNMX 150708-R30:6640	SNMX 150708-R30:6640	7817107	SNMX 19-R55:6640	SNMX 19-R55:6640	6754648	SPEW 1204ADSN:M8330	SPEW 1204ADSN:M8330	7451038
SNMX 150708-R35:6640	SNMX 150708-R35:6640	7817108	SNMX 19-R55:T9335	SNMX 19-R55:T9335	6801241	SPEW 1204ADSN:M8340	SPEW 1204ADSN:M8340	6800894
SNMX 150708-R40:6640	SNMX 150708-R40:6640	7817109	SNMX 19-R60:6640	SNMX 19-R60:6640	6754649	SPG 322:M8340	SPGN 090308:M8340	6800895
SNMX 150708-R42:6640	SNMX 150708-R42:6640	7817110	SNMX 19-R60:T9335	SNMX 19-R60:T9335	6801242	SPG 421:M8330	SPGN 120304:M8330	7451039
SNMX 150708-R45:6640	SNMX 150708-R45:6640	7817111	SNMX 19-R65:6640	SNMX 19-R65:6640	6752122	SPG 421:M8340	SPGN 120304:M8340	6803596
SNMX 150708-R50:6640	SNMX 150708-R50:6640	7817112	SNMX 19-R65:T9335	SNMX 19-R65:T9335	6801243	SPG 422:T00420:TC100	SPGN 120308:T01020:TC100	6755444
SNMX 150708-R60:6640	SNMX 150708-R60:6640	7817113	SNMX 19-R75:6640	SNMX 19-R75:6640	6801265	SPG 422:M8330	SPGN 120308:M8330	7451040
SNMX 150708-R65:6640	SNMX 150708-R65:6640	7817114	SNMX 19-R80:6640	SNMX 19-R80:6640	6752235	SPG 532:M8330	SPGN 150408:M8330	7451041
SNMX 150708-R70:6640	SNMX 150708-R70:6640	7817115	SNMX 19-R80:T9335	SNMX 19-R80:T9335	6801244	SPG 533:M8330	SPGN 150412:M8330	7451042
SNMX 150708-R75:6640	SNMX 150708-R75:6640	7817116	SNMX 19-R85:6640	SNMX 19-R85:6640	6801266	SPGN 84DZSR:M8326	SPGN 2506DZSR:M8326	6801312
SNMX 150708-R80:6640	SNMX 150708-R80:6640	7817117	SNMX 19-R85:T9335	SNMX 19-R85:T9335	6752123	SPGN 84DZSR:M8346	SPGN 2506DZSR:M8346	6801313
SNMX 150708-R90:6640	SNMX 150708-R90:6640	7817118	SNMX 19-R90:6640	SNMX 19-R90:6640	6801245	SPKN 42EDER:H10	SPKN 1203EDER:H10	6751713
SNMX 15-R00:T9335	SNMX 15-R00:T9335	6801215	SNMX 19-R90:T9335	SNMX 19-R90:T9335	6801246	SPKN 42EDER:M8330	SPKN 1203EDER:M8330	7451043
SNMX 15-R07:6640	SNMX 15-R07:6640	6752182	SNMX 251224-R00:T9335	SNMX 251224-R00:T9335	6801247	SPKN 42EDER:M8340	SPKN 1203EDER:M8340	6803598
SNMX 15-R07:T9335	SNMX 15-R07:T9335	6801216	SNMX 251224-R100:T9335	SNMX 251224-R100:T9335	6801248	SPKN 42EDER:S26	SPKN 1203EDER:S26	6751714
SNMX 15-R09:6640	SNMX 15-R09:6640	6753569	SNMX 251224-R120:T9335	SNMX 251224-R120:T9335	6801250	SPKN 42EDSL:M8330	SPKN 1203EDSL:M8330	7451044
SNMX 15-R09:T9335	SNMX 15-R09:T9335	6801217	SNMX 251224-R25:T9335	SNMX 251224-R25:T9335	6801251	SPKN 42EDSL:M8340	SPKN 1203EDSL:M8340	6753420
SNMX 15-R11:6640	SNMX 15-R11:6640	6753560	SNMX 251224-R30:T9335	SNMX 251224-R30:T9335	6801252	SPKN 42EDSR:8215	SPKN 1203EDSR:8215	6752564
SNMX 15-R11:T9335	SNMX 15-R11:T9335	6801218	SNMX 251224-R35:T9335	SNMX 251224-R35:T9335	6801253	SPKN 42EDSR:8230	SPKN 1203EDSR:8230	6752564
SNMX 15-R13:6640	SNMX 15-R13:6640	6753566	SNMX 251224-R40:T9335	SNMX 251224-R40:T9335	6801253	SPKN 42EDSR:H10	SPKN 1203EDSR:H10	6751715
SNMX 15-R13:T9335	SNMX 15-R13:T9335	6801219	SNMX 251224-R45:T9335	SNMX 251224-R45:T9335	6801254	SPKN 42EDSR:M8330	SPKN 1203EDSR:M8330	7451045
SNMX 15-R15:6640	SNMX 15-R15:6640	6753557	SNMX 251224-R80:T9335	SNMX 251224-R80:T9335	6801255	SPKN 42EDSR:M8340	SPKN 1203EDSR:M8340	6803599
SNMX 15-R15:T9335	SNMX 15-R15:T9335	6803675	SNMX 2512245-SR:6630	SNMX 2512245-SR:6630	6751659	SPKN 42EDSR:M9325	SPKN 1203EDSR:M9325	6754578
SNMX 15-R18:6640	SNMX 15-R18:6640	6753565	SNMX 2512245-SR:T8345	SNMX 2512245-SR:T8345	6753687	SPKN 42EDSR:S26	SPKN 1203EDSR:S26	6751716
SNMX 15-R18:T9335	SNMX 15-R18:T9335	6801220	SNMX 2512245-SR:T9325	SNMX 2512245-SR:T9325	6754158	SPKN 53EDEL:M8330	SPKN 1504EDEL:M8330	7451046
SNMX 15-R20:6640	SNMX 15-R20:6640	6753566	SNMX 2512245-SR:T9335	SNMX 2512245-SR:T9335	6754972	SPKN 53EDEL:H10	SPKN 1504EDEL:H10	7451717
SNMX 15-R20:T9335	SNMX 15-R20:T9335	6801221	SNMX 25-R00:T9335	SNMX 25-R00:T9335	6801256	SPKN 53EDEL:M8340	SPKN 1504EDEL:M8340	6803600
SNMX 15-R22:6640	SNMX 15-R22:6640	6753567	SNMX 25-R100:6640	SNMX 25-R100:6640	6753182	SPKN 53EDER:M8340	SPKN 1504EDER:M8340	6803601
SNMX 15-R22:T9335	SNMX 15-R22:T9335	6801222	SNMX 25-R100:T9335	SNMX 25-R100:T9335	6801257	SPKN 53EDSL:M8340	SPKN 1504EDSL:M8340	6803601
SNMX 15-R25:6640	SNMX 15-R25:6640	6753570	SNMX 25-R120:6640	SNMX 25-R120:6640	6753183	SPKN 53EDSR:8215	SPKN 1504EDSR:8215	6753421
SNMX 15-R25:T9335	SNMX 15-R25:T9335	6801223	SNMX 25-R120:T9335	SNMX 25-R120:T9335	6801258	SPKN 53EDSR:H10	SPKN 1504EDSR:H10	6751718
SNMX 15-R27:6640	SNMX 15-R27:6640	6753641	SNMX 25-R140:6640	SNMX 25-R140:6640	6753184	SPKN 53EDSR:M5315	SPKN 1504EDSR:M5315	6945809
SNMX 15-R27:T9335	SNMX 15-R27:T9335	6801224	SNMX 25-R140:T9335	SNMX 25-R140:T9335	6801259	SPKN 53EDSR:M8330	SPKN 1504EDSR:M8330	7451048
SNMX 15-R30:6640	SNMX 15-R30:6640	6753642	SNMX 25-R160:6640	SNMX 25-R160:6640	6753185	SPKN 53EDSR:M8340	SPKN 1504EDSR:M8340	6803602
SNMX 15-R30:T9335	SNMX 15-R30:T9335	6801225	SNMX 25-R160:T9335	SNMX 25-R160:T9335	6801260	SPKN 53EDSR:M9315	SPKN 1504EDSR:M9315	6754619
SNMX 15-R35:6640	SNMX 15-R35:6640	6753705	SNMX 25-R180:6640	SNMX 25-R180:6640	6801261	SPKN 53EDSR:M9325	SPKN 1504EDSR:M9325	6754579
SNMX 15-R35:T9335	SNMX 15-R35:T9335	6801226	SNMX 25-R200:6640	SNMX 25-R200:6640	6753187	SPKN 53EDSR:S26	SPKN 1504EDSR:S26	6751719
SNMX 15-R40:6640	SNMX 15-R40:6640	6753706	SNMX 25-R200:T9335	SNMX 25-R200:T9335	6801262	SPKR 42EDSR:M8330	SPKR 1203EDSR:M8330	7451049
SNMX 15-R40:T9335	SNMX 15-R40:T9335	6803676	SNMX 25-R50:6640	SNMX 25-R50:6640	6801263	SPKR 42EDSR:M8340	SPKR 1203EDSR:M8340	6803603
SNMX 15-R45:6640	SNMX 15-R45:6640	6755491	SNMX 25-R80:6640	SNMX 25-R80:6640	6753181	SPKR 42EDSR:M9340	SPKR 1203EDSR:M9340	6754604
SNMX 15-R45:T9335	SNMX 15-R45:T9335	6801227	SNMX 25-R80:T9335	SNMX 25-R80:T9335	6801264	SPKR 53EDSR:M8330	SPKR 1504EDSR:M8330	7451050
SNMX 15-R50:6640	SNMX 15-R50:6640	6755492	SNU 432:M8330	SNU 120408:M8330	7451026	SPKR 53EDSR:M8340	SPKR 1504EDSR:M8340	6803604
SNMX 15-R50:T9335	SNMX 15-R50:T9335	6801228	SNU 433:M8330	SNU 120412:M8330	7451027	SPKX 42EDFR:H10	SPKX 1203EDFR:H10	6751645
SNMX 15-R60:6640	SNMX 15-R60:6640	6752133	SNU 433:S26	SNU 120412:S26	6751819	SPKX 53EDFR:H10	SPKX 1504EDFR:H10	6751646
SNMX 15-R60:T9335	SNMX 15-R60:T9335	6801229	SNU 533:M8330	SNU 150412:M8330	7451028	SPMR 321-46:T9325	SPMR 090304E-46:T9325	6754159
SNMX 15-R90:6640	SNMX 15-R90:6640	7660879	SOMT 050204SR-M:8215	SOMT 050204SR-M:8215	7343036	SPMR 322-46:T9325	SPMR 090308E-46:T9325	6754160
SNMX 1911405N-RF:T9315	SNMX 1911405N-RF:T9315	6753322	SOMT 050204SR-M:M6330	SOMT 050204SR-M:M6330	7343037	SPMR 421-48:6630	SPMR 120304E-48:6630	6751744
SNMX 1911405N-RF:T9325	SNMX 1911405N-RF:T9325	6753323	SOMT 050204SR-M:M8330	SOMT 050204SR-M:M8330	7451032	SPMR 421-48:T9325	SPMR 120304E-48:T9325	6754161
SNMX 1911405N-TF:T5315	SNMX 1911405N-TF:T5315	6798541	SOMT 050204SR-M:M8340	SOMT 050204SR-M:M8340	7343038	SPMR 421-48:T9335	SPMR 120304E-48:T9335	6754973
SNMX 1911405N-TF:T9315	SNMX 1911405N-TF:T9315	6803654	SOMT 050208SR-M:8215	SOMT 050208SR-M:8215	7343090	SPMR 422-48:6630	SPMR 120308E-48:6630	6751684
SNMX 1911405N-TF:T9325	SNMX 1911405N-TF:T9325	6798539	SOMT 050208SR-M:M6330	SOMT 050208SR-M:M6330	7343091	SPMR 422-48:6640	SPMR 120308E-48:6640	6751690
SNMX 19-R00:T9335	SNMX 19-R00:T9335	6801237	SOMT 050208SR-M:M8330	SOMT 050208SR-M:M8330	7451033	SPMR 422-48:T9325	SPMR 120308E-48:T9325	6754162
SNMX 19-R10:6640	SNMX 19-R10:6640	6753707	SOMT 050208SR-M:M8340	SOMT 050208SR-M:M8340	7343092	SPMR 422-48:T9335	SPMR 120308E-48:T9335	6754974
SNMX 19-R10:T9335	SNMX 19-R10:T9335	6801230	SOMT 09T304-MI:8215	SOMT 09T304-MI:8215	6753418	SPMR 422-48:T9325	SPMR 120312E-48:T9325	6754163
SNMX 19-R110:6640	SNMX 19-R110:6640	6752896	SOMT 09T304-MI:M8310	SOMT 09T304-MI:M8310	6756266	SPU 421:M8330	SPUN 120304:M8330	7451051
SNMX 19-R110:T9335	SNMX 19-R110:T9335	6801238	SOMT 09T304-MI:M8330	SOMT 09T304-MI:M8330	7451029	SPU 422:6640	SPUN 120308:6640	6751607
SNMX 19-R12:6640	SNMX 19-R12:6640	6754646	SOMT 09T304-MI:M8340	SOMT 09T304-MI:M8340	6800887	SPU 422:H10	SPUN 120308:H10	6751650
SNMX 19-R12:T9335	SNMX 19-R12:T9335	6801231	SOMT 09T304-MI:M9315	SOMT 09T304-MI:M9315	6754616	SPU 422:M8330	SPUN 120308:M8330	7451052
SNMX 19-R15:6640	SNMX 19-R15:6640	6755001	SOMT 09T304-MI:M9340	SOMT 09T304-MI:M9340	6754603	SPU 422:S26	SPUN 120308:S26	6751791
SNMX 19-R15:T9335	SNMX 19-R15:T9335	6801232	SOMT 09T304-P:M8330	SOMT 09T304-P:M8330	7451030	SPU 423:6640	SPUN 120312:6640	6751609
SNMX 19-R18:T9335	SNMX 19-R18:T9335	6801233	SOMT 09T304-P:M8340	SOMT 09T304-P:M8340	6800888	SPU 532:6640	SPUN 150408:6640	6751609
SNMX 19-R20:6640	SNMX 19-R20:6640	6754647	SOMT 09T304-P:M9325	SOMT 09T304-P:M9325	6754577	SPU 533:6640	SPUN 150412:6640	6751610
SNMX 19-R20:T9335	SNMX 19-R20:T9335	6803677	SOMT 09T308-M:8215	SOMT 09T308-M:8215	6753419	SPU 533:M8330	SPUN 150412:M8330	7451054
SNMX 19-R22:6640	SNMX 19-R22:6640	6801234	SOMT 09T308-M:8230	SOMT 09T308-M:8230	6753371	SPU 632:6640	SPUN 190408:6640	6752052
SNMX 19-R22:T9335	SNMX 19-R22:T9335	6801234	SOMT 09T308-M:M5315	SOMT 09T308-M:M5315	6754629	SPU 632:M8330	SPUN 190408:M8330	7451055
SNMX 19-R25:6640	SNMX 19-R25:6640	6753558	SOMT 09T308-M:M8330	SOMT 09T308-M:M8330	7451031	SPU 633:6640	SPUN 190412:6640	6751611
SNMX 19-R25:T9335	SNMX 19-R25:T9335	6803678	SOMT 09T308-M:M8340	SOMT 09T308-M:M8340	6800889	SPU 633:M8330	SPUN 190412:M8330	7451056
SNMX 19-R30:6640	SNMX 19-R30:6640	6754999	SOMT 09T308-M:M9315	SOMT 09T308-M:M9315	6754617	SPU 634:6640	SPUN 190416:6640	6751612
SNMX 19-R30:T9335	SNMX 19-R30:T9335	6801235	SPET 120408S:M8330	SPET 120408S:M8330	7451034			

ANSI	ISO	EDP
SPU 8445:M8326	SPUN 250616S:M8326	6801314
SPU 8455:6640	SPUN 250620S:6640	6751618
SPU 8455:M5326	SPUN 250620S:M5326	6801301
SPU 8455:M8326	SPUN 250620S:M8326	6801316
SPU 8455:M8346	SPUN 250620S:M8346	6801317
SPU 8455:S26	SPUN 250620S:S26	6751794
SPUB-63-B:6640	SPUB 19-R12:6640	7817023
SPUB-63-B:79335	SPUB 19-R12:79335	7817052
SPUB-63-C:6640	SPUB 19-R15:6640	7817024
SPUB-63-C:79335	SPUB 19-R15:79335	7817053
SPUB-63-D:6640	SPUB 19-R20:6640	7817025
SPUB-63-D:79335	SPUB 19-R20:79335	7817054
SPUB-63-E:6640	SPUB 19-R25:6640	7817026
SPUB-63-E:79335	SPUB 19-R25:79335	7817055
SPUB-63-F:6640	SPUB 19-R30:6640	7817027
SPUB-63-F:79335	SPUB 19-R30:79335	7817056
SPUB-63-G:6640	SPUB 19-R40:6640	7817028
SPUB-63-G:79335	SPUB 19-R40:79335	7817057
SPUB-63-H:6640	SPUB 19-R50:6640	7817029
SPUB-63-H:79335	SPUB 19-R50:79335	7817058
SPUB-63-I:6640	SPUB 19-R63:6640	7817050
SPUB-63-I:79335	SPUB 19-R63:79335	7817059
SPUB-63-M:6640	SPUB 19-R00:6640	7817022
SPUB-63-M:79335	SPUB 19-R00:79335	7817051
TBMR 2707PZSR:M5326	TBMR 2707PZSR:M5326	6801302
TBMR 2707PZSR:M8326	TBMR 2707PZSR:M8326	6801318
TBMR 2707PZSR:M8346	TBMR 2707PZSR:M8346	6801319
TCGT 1.21.20.5-F2:T8330	TCGT 06T102E-F2:T8330	7156754
TCGT 1.21.20.5-F2:TT010	TCGT 06T102E-F2:TT010	7080629
TCGT 1.81.50.5F-AL:HF7	TCGT 090202F-AL:HF7	6751860
TCGT 1.81.50.5F-AL:T0315	TCGT 090202F-AL:T0315	6756153
TCGT 1.81.50.5F-F2:TT010	TCGT 090202E-F2:TT010	7080630
TCGT 1.81.51F-AL:HF7	TCGT 090204F-AL:HF7	6751861
TCGT 1.81.51F-AL:T0315	TCGT 090204F-AL:T0315	6756154
TCGT 110202EL-SI:T8330	TCGT 110202EL-SI:T8330	6754386
TCGT 21.50.5F-AL:HF7	TCGT 110202F-AL:HF7	6751862
TCGT 21.50.5F-AL:T0315	TCGT 110202F-AL:T0315	6756155
TCGT 21.50.5L-SI:T8315	TCGT 110202EL-SI:T8315	6922732
TCGT 21.50.5R-SI:T8315	TCGT 110202ER-SI:T8315	6922733
TCGT 21.50.5R-SI:T8330	TCGT 110202ER-SI:T8330	6754387
TCGT 21.50.5F3:T6310	TCGT 110202E-F3:T6310	7168579
TCGT 21.50.5F3:T8315	TCGT 110202E-F3:T8315	7168580
TCGT 21.51F-AL:HF7	TCGT 110204F-AL:HF7	6751863
TCGT 21.51F-AL:T0315	TCGT 110204F-AL:T0315	6756156
TCGT 21.51L-SI:T8315	TCGT 110204EL-SI:T8315	6922734
TCGT 21.51L-SI:T8330	TCGT 110204EL-SI:T8330	6754388
TCGT 21.51-NF1:H07	TCGT 110204E-NF1:H07	7167418
TCGT 21.51-NF1:T6310	TCGT 110204E-NF1:T6310	7167419
TCGT 21.51-NF1:T7325	TCGT 110204E-NF1:T7325	7167420
TCGT 21.51R-SI:T8330	TCGT 110204ER-SI:T8330	6754389
TCGT 21.51-SF3:H07	TCGT 110204E-SF3:H07	7168581
TCGT 21.51-SF3:T6310	TCGT 110204E-SF3:T6310	7168582
TCGT 21.51-SF3:T8315	TCGT 110204E-SF3:T8315	7168583
TCGT 21.52F-AL:HF7	TCGT 110208F-AL:HF7	6751864
TCGT 21.51F-AL:HF7	TCGT 16T304F-AL:HF7	6751803
TCGT 21.51F-AL:T0315	TCGT 16T304F-AL:T0315	6756158
TCGT 32.51-SF3:H07	TCGT 16T304E-SF3:H07	7168584
TCGT 32.51-SF3:T6310	TCGT 16T304E-SF3:T6310	7168585
TCGT 32.51-SF3:T8315	TCGT 16T304E-SF3:T8315	7168586
TCGT 32.52F-AL:HF7	TCGT 16T308F-AL:HF7	6751804
TCGT 32.52F-AL:T0315	TCGT 16T308F-AL:T0315	6756159
TCGT 32.52-SF3:H07	TCGT 16T308E-SF3:H07	7168587
TCGT 32.52-SF3:T6310	TCGT 16T308E-SF3:T6310	7168588
TCGT 32.52-SF3:T8315	TCGT 16T308E-SF3:T8315	7168589
TCGT 32.53-SF3:T6310	TCGT 16T312E-SF3:T6310	7600317
TCGW 21.51E:T8310	TCGW 110204E-C:T8310	6755926
TCGW 21.51S00420:T8310	TCGW 110204S01020C:T8310	6755687
TCGW 21.52S00420:T8310	TCGW 110208S01020C:T8310	6755927
TCMT 1.21.20.5-F2:T8330	TCMT 06T102E-F2:T8330	7156755
TCMT 1.21.20.5-F2:T9325	TCMT 06T102E-F2:T9325	6756192
TCMT 1.21.21-F2:T7325	TCMT 06T104E-F2:T7325	7156756
TCMT 1.21.21-F2:T8330	TCMT 06T104E-F2:T8330	7156757
TCMT 1.21.21-F2:T9315	TCMT 06T104E-F2:T9315	6922919
TCMT 1.21.21-F2:T9325	TCMT 06T104E-F2:T9325	6756101
TCMT 1.81.51-F2:T5315	TCMT 090204E-F2:T5315	6756144
TCMT 1.81.51-F2:T7325	TCMT 090204E-F2:T7325	7156758

ANSI	ISO	EDP
TCMT 1.81.51-F2:T8330	TCMT 090204E-F2:T8330	7156759
TCMT 1.81.51-F2:T9315	TCMT 090204E-F2:T9315	6922920
TCMT 1.81.51-F2:T9325	TCMT 090204E-F2:T9325	6756120
TCMT 110202E-FM:T8330	TCMT 110202E-FM:T8330	6754295
TCMT 110204E-FM:T9325	TCMT 110204E-FM:T9325	6753843
TCMT 21.50.5-FM:T7325	TCMT 110202E-FM:T7325	7156368
TCMT 21.50.5-FM:T7335	TCMT 110202E-FM:T7335	6754815
TCMT 21.50.5-FM:T8315	TCMT 110204E-FM:T8315	6753620
TCMT 21.50.5-FM:T9315	TCMT 110202E-FM:T9315	6922921
TCMT 21.50.5-FM:T9325	TCMT 110202E-FM:T9325	6754099
TCMT 21.51-F2:T7325	TCMT 110204E-F2:T7325	7156760
TCMT 21.51-F2:T8330	TCMT 110204E-F2:T8330	7156761
TCMT 21.51-F2:T9315	TCMT 110204E-F2:T9315	7156762
TCMT 21.51-F2:T9325	TCMT 110204E-F2:T9325	7156763
TCMT 21.51-F2:T9335	TCMT 110204E-F2:T9335	7156764
TCMT 21.51-FM:T7325	TCMT 110204E-FM:T7325	7156369
TCMT 21.51-FM:T7335	TCMT 110204E-FM:T7335	6754816
TCMT 21.51-FM:T8315	TCMT 110204E-FM:T8315	6753621
TCMT 21.51-FM:T8330	TCMT 110204E-FM:T8330	6754296
TCMT 21.51-FM:T9315	TCMT 110204E-FM:T9315	6754076
TCMT 21.51-FM2:T8330	TCMT 110204E-FM2:T8330	7156917
TCMT 21.51-FM2:T9325	TCMT 110204E-FM2:T9325	7156918
TCMT 21.51-UR:T7325	TCMT 110204E-UR:T7325	7156370
TCMT 21.51-UR:T8330	TCMT 110204E-UR:T8330	6754243
TCMT 21.51-UR:T9315	TCMT 110204E-UR:T9315	6754077
TCMT 21.51-UR:T9325	TCMT 110204E-UR:T9325	6754100
TCMT 21.52-F2:T7325	TCMT 110208E-F2:T7325	7156765
TCMT 21.52-F2:T8330	TCMT 110208E-F2:T8330	7156766
TCMT 21.52-F2:T9315	TCMT 110208E-F2:T9315	7156767
TCMT 21.52-F2:T9325	TCMT 110208E-F2:T9325	7156768
TCMT 21.52-FM:T7325	TCMT 110208E-FM:T7325	7156371
TCMT 21.52-FM:T8330	TCMT 110208E-FM:T8330	6755667
TCMT 21.52-FM:T9315	TCMT 110208E-FM:T9315	6922922
TCMT 21.52-FM:T9325	TCMT 110208E-FM:T9325	6755666
TCMT 21.52-FM2:T8330	TCMT 110208E-FM2:T8330	7156919
TCMT 21.52-FM2:T9325	TCMT 110208E-FM2:T9325	7156920
TCMT 21.52-FM2:T9335	TCMT 110208E-FM2:T9335	7156921
TCMT 32.51-F2:T7325	TCMT 16T304E-F2:T7325	7156769
TCMT 32.51-F2:T8330	TCMT 16T304E-F2:T8330	7156770
TCMT 32.51-F2:T9315	TCMT 16T304E-F2:T9315	7156771
TCMT 32.51-F2:T9325	TCMT 16T304E-F2:T9325	7156772
TCMT 32.51-F2:T9335	TCMT 16T304E-F2:T9335	7156773
TCMT 32.51-F2:TT010	TCMT 16T304E-F2:TT010	7080631
TCMT 32.51-FM:T7325	TCMT 16T304E-FM:T7325	7156372
TCMT 32.51-FM:T7335	TCMT 16T304E-FM:T7335	6754817
TCMT 32.51-FM:T8315	TCMT 16T304E-FM:T8315	6753622
TCMT 32.51-FM:T8330	TCMT 16T304E-FM:T8330	6754297
TCMT 32.51-FM:T9315	TCMT 16T304E-FM:T9315	6754079
TCMT 32.51-FM:T9325	TCMT 16T304E-FM:T9325	6754101
TCMT 32.51-RM3:T6310	TCMT 16T304E-RM3:T6310	7248729
TCMT 32.51-RM3:T7325	TCMT 16T304E-RM3:T7325	7248730
TCMT 32.51-RM3:T8330	TCMT 16T304E-RM3:T8330	7248731
TCMT 32.51-RM3:T9315	TCMT 16T304E-RM3:T9315	7248732
TCMT 32.51-RM3:T9325	TCMT 16T304E-RM3:T9325	7248733
TCMT 32.51-RM3:T9335	TCMT 16T304E-RM3:T9335	7248734
TCMT 32.51-UR:T7325	TCMT 16T304E-UR:T7325	7156373
TCMT 32.51-UR:T8330	TCMT 16T304E-UR:T8330	6754244
TCMT 32.51-UR:T9315	TCMT 16T304E-UR:T9315	6754080
TCMT 32.51-UR:T9325	TCMT 16T304E-UR:T9325	6754102
TCMT 32.51-UR:TT310	TCMT 16T304E-UR:TT310	6756263
TCMT 32.52-F2:T7325	TCMT 16T308E-F2:T7325	7156774
TCMT 32.52-F2:T8330	TCMT 16T308E-F2:T8330	7156775
TCMT 32.52-F2:T9315	TCMT 16T308E-F2:T9315	7156776
TCMT 32.52-F2:T9325	TCMT 16T308E-F2:T9325	7156777
TCMT 32.52-F2:T9335	TCMT 16T308E-F2:T9335	7156778
TCMT 32.52-FM:T7325	TCMT 16T308E-FM:T7325	7156374
TCMT 32.52-FM:T7335	TCMT 16T308E-FM:T7335	6754818
TCMT 32.52-FM:T8315	TCMT 16T308E-FM:T8315	6753623
TCMT 32.52-FM:T8330	TCMT 16T308E-FM:T8330	6754298
TCMT 32.52-FM:T9315	TCMT 16T308E-FM:T9315	6754082
TCMT 32.52-FM:T9325	TCMT 16T308E-FM:T9325	6753844
TCMT 32.52-FM2:T7325	TCMT 16T308E-FM2:T7325	7156922
TCMT 32.52-FM2:T8330	TCMT 16T308E-FM2:T8330	7156923
TCMT 32.52-FM2:T9325	TCMT 16T308E-FM2:T9325	7156924
TCMT 32.52-FM2:T9335	TCMT 16T308E-FM2:T9335	7156925
TCMT 32.52-RF:6630	TCMT 16T308E-RF:6630	6756045

ANSI	ISO	EDP
TCMT 32.52-RM:T5305	TCMT 16T308E-RM:T5305	6755880
TCMT 32.52-RM:T5315	TCMT 16T308E-RM:T5315	6755781
TCMT 32.52-RM:T7335	TCMT 16T308E-RM:T7335	6754819
TCMT 32.52-RM:T8330	TCMT 16T308E-RM:T8330	6754399
TCMT 32.52-RM:T9315	TCMT 16T308E-RM:T9315	6754086
TCMT 32.52-RM:T9325	TCMT 16T308E-RM:T9325	6754103
TCMT 32.52-RM3:T6310	TCMT 16T308E-RM3:T6310	7248735
TCMT 32.52-RM3:T7325	TCMT 16T308E-RM3:T7325	7248736
TCMT 32.52-RM3:T8330	TCMT 16T308E-RM3:T8330	7248737
TCMT 32.52-RM3:T9315	TCMT 16T308E-RM3:T9315	7248738
TCMT 32.52-RM3:T9325	TCMT 16T308E-RM3:T9325	7248739
TCMT 32.52-RM3:T9335	TCMT 16T308E-RM3:T9335	7248740
TCMT 32.52-UR:T5315	TCMT 16T308E-UR:T5315	6755782
TCMT 32.52-UR:T7325	TCMT 16T308E-UR:T7325	7156375
TCMT 32.52-UR:T8330	TCMT 16T308E-UR:T8330	6754245
TCMT 32.52-UR:T9315	TCMT 16T308E-UR:T9315	6754087
TCMT 32.52-UR:T9325	TCMT 16T308E-UR:T9325	6753845
TCMT 32.53-RM:T5305	TCMT 16T312E-RM:T5305	6755881
TCMT 32.53-RM:T5315	TCMT 16T312E-RM:T5315	6755783
TCMT 32.53-RM:T8330	TCMT 16T312E-RM:T8330	6754400
TCMT 32.53-RM:T9315	TCMT 16T312E-RM:T9315	6754088
TCMT 32.53-RM:T9325	TCMT 16T312E-RM:T9325	6754104
TCMW 21.51:T5305	TCMW 110204:T5305	6755882
TCMW 21.51:T5315	TCMW 110204:T5315	6922822
TCMW 32.51:T5305	TCMW 16T304:T5305	6755883
TCMW 32.51:T5315	TCMW 16T304:T5315	6922823
TCMW 32.51:T6310	TCMW 16T304:T6310	7168651
TCMW 32.52:T5305	TCMW 16T308:T5305	6755884
TCMW 32.52:T5315	TCMW 16T308:T5315	6922824
TCMW 32.52:T6310	TCMW 16T308:T6310	7168652
TN 11N1050M:T8030	TN 11N1050M:T8030	6755368
TN 11N1075M:T8030	TN 11N1075M:T8030	6755369
TN 11N1090Z:T8330	TN 11N1090Z:T8330	6755971
TN 11N1100M:T8030	TN 11N1100M:T8030	6755370
TN 11N1102Z:T8330	TN 11N1102Z:T8330	6755972
TN 11N1125M:T8030	TN 11N1125M:T8030	6755371
TN 11N1140W:T8030	TN 11N1140W:T8030	6755378
TN 11N1150M:T8010	TN 11N1150M:T8010	7575391
TN 11N1150M:T8030	TN 11N1150M:T8030	6755372
TN 11N1190W:T8030	TN 11N1190W:T8030	6755379
TN 11N1200M:T8010	TN 11N1200M:T8010	7575392
TN 11N1200M:T8030	TN 11N1200M:T8030	6755395
TN 11N1A55:T8030	TN 11N1A55:T8030	6755527
TN 11N1A60:T8030	TN 11N1A60:T8030	6755514
TN 11N1-R050:T8330	TN 11N1-R050:T8330	6755973
TN 11NR050M:T8010	TN 11NR050M:T8010	7575393
TN 11NR050M:T8030	TN 11NR050M:T8030	6755373
TN 11NR075M:T8010	TN 11NR075M:T8010	7575394
TN 11NR075M:T8030	TN 11NR075M:T8030	6755374
TN 11NR090Z:T8330	TN 11NR090Z:T8330	6755974
TN 11NR100M:T8010	TN 11NR100M:T8010	7575395
TN 11NR100M:T8030	TN 11NR100M:T8030	6755375
TN 11NR100M-P1:T8030	TN 11NR100M-P1:T8030	6755543
TN 11NR110Z:T8330	TN 11NR110Z:T8330	6755975
TN 11NR125M:T8010	TN 11NR125M:T80	

CROSS REFERENCE GUIDE – INSERTS

ANSI	ISO	EDP
TN 16ELO75M:T8030	TN 16ELO75M:T8030	6755197
TN 16ELO80ACME:T8030	TN 16ELO80ACME:T8030	7800278
TN 16ELO80M:T8030	TN 16ELO80M:T8030	6755392
TN 16ELO80RD:T8030	TN 16ELO80RD:T8030	7800271
TN 16ELO80STACME:T8030	TN 16ELO80STACME:T8030	7800298
TN 16ELO80UN:T8030	TN 16ELO80UN:T8030	6755268
TN 16ELO80W:T8030	TN 16ELO80W:T8030	6755220
TN 16ELO90UN:T8030	TN 16ELO90UN:T8030	6755269
TN 16ELO90W:T8030	TN 16ELO90W:T8030	6755221
TN 16ELO90ZZ:T8330	TN 16ELO90ZZ:T8330	6755079
TN 16EL100ACME:T8030	TN 16EL100ACME:T8030	7800277
TN 16EL100M:T8010	TN 16EL100M:T8010	7575370
TN 16EL100M:T8030	TN 16EL100M:T8030	6755198
TN 16EL100RD:T8030	TN 16EL100RD:T8030	7800270
TN 16EL100STACME:T8030	TN 16EL100STACME:T8030	7800294
TN 16EL100UN:T8030	TN 16EL100UN:T8030	6755270
TN 16EL100W:T8030	TN 16EL100W:T8030	6755222
TN 16EL110BSP:T8030	TN 16EL110BSP:T8030	7800313
TN 16EL110UN:T8030	TN 16EL110UN:T8030	6755271
TN 16EL110W:T8030	TN 16EL110W:T8030	6755223
TN 16EL110ZZ:T8330	TN 16EL110ZZ:T8330	6755080
TN 16EL120ACME:T8030	TN 16EL120ACME:T8030	7800276
TN 16EL120STACME:T8030	TN 16EL120STACME:T8030	7800290
TN 16EL120UN:T8030	TN 16EL120UN:T8030	6755272
TN 16EL120UNJ:T8030	TN 16EL120UNJ:T8030	7800330
TN 16EL120W:T8030	TN 16EL120W:T8030	6755224
TN 16EL125M:T8010	TN 16EL125M:T8010	7575371
TN 16EL125M:T8030	TN 16EL125M:T8030	6755199
TN 16EL130ZZ:T8330	TN 16EL130ZZ:T8330	6755081
TN 16EL140BSP:T8030	TN 16EL140BSP:T8030	7800315
TN 16EL140UN:T8030	TN 16EL140UN:T8030	6755273
TN 16EL140W:T8030	TN 16EL140W:T8030	6755225
TN 16EL150M:T8010	TN 16EL150M:T8010	7575372
TN 16EL150M:T8030	TN 16EL150M:T8030	6755200
TN 16EL150TR:T8030	TN 16EL150TR:T8030	6755327
TN 16EL160STACME:T8030	TN 16EL160STACME:T8030	7800286
TN 16EL160UN:T8030	TN 16EL160UN:T8030	6755274
TN 16EL160UNJ:T8030	TN 16EL160UNJ:T8030	7800329
TN 16EL160W:T8030	TN 16EL160W:T8030	6755226
TN 16EL160ZZ:T8330	TN 16EL160ZZ:T8330	6755082
TN 16EL175M:T8010	TN 16EL175M:T8010	7575373
TN 16EL175M:T8030	TN 16EL175M:T8030	6755201
TN 16EL180UN:T8030	TN 16EL180UN:T8030	6755275
TN 16EL180UNJ:T8030	TN 16EL180UNJ:T8030	7800328
TN 16EL185ZZ:T8330	TN 16EL185ZZ:T8330	6755083
TN 16EL190BSP:T8030	TN 16EL190BSP:T8030	7800310
TN 16EL190W:T8030	TN 16EL190W:T8030	6755227
TN 16EL200M:T8010	TN 16EL200M:T8010	7575374
TN 16EL200M:T8030	TN 16EL200M:T8030	6755202
TN 16EL200TR:T8030	TN 16EL200TR:T8030	6755328
TN 16EL200UN:T8030	TN 16EL200UN:T8030	6755276
TN 16EL200UNJ:T8030	TN 16EL200UNJ:T8030	7800327
TN 16EL200W:T8030	TN 16EL200W:T8030	6755228
TN 16EL215ZZ:T8330	TN 16EL215ZZ:T8330	6755084
TN 16EL240UN:T8030	TN 16EL240UN:T8030	6755277
TN 16EL240UNJ:T8030	TN 16EL240UNJ:T8030	7800326
TN 16EL240W:T8030	TN 16EL240W:T8030	7800267
TN 16EL250M:T8010	TN 16EL250M:T8010	7575375
TN 16EL250M:T8030	TN 16EL250M:T8030	6755203
TN 16EL260W:T8030	TN 16EL260W:T8030	7800263
TN 16EL265ZZ:T8330	TN 16EL265ZZ:T8330	6755085
TN 16EL280BSP:T8030	TN 16EL280BSP:T8030	7800306
TN 16EL280UN:T8030	TN 16EL280UN:T8030	6755278
TN 16EL280UNJ:T8030	TN 16EL280UNJ:T8030	7800325
TN 16EL280W:T8030	TN 16EL280W:T8030	6755229
TN 16EL300M:T8010	TN 16EL300M:T8010	7575376
TN 16EL300M:T8030	TN 16EL300M:T8030	6755204
TN 16EL300TR:T8030	TN 16EL300TR:T8030	6755329
TN 16EL320UN:T8030	TN 16EL320UN:T8030	6755279
TN 16EL320UNJ:T8030	TN 16EL320UNJ:T8030	7800324
TN 16EL350M:T8030	TN 16EL350M:T8030	7800240
TN 16ELA55:T8030	TN 16ELA55:T8030	6755538
TN 16ELA60:T8030	TN 16ELA60:T8030	6755534
TN 16ELAG55:T8030	TN 16ELAG55:T8030	6755536
TN 16ELAG60:T8010	TN 16ELAG60:T8010	7575319
TN 16ELAG60:T8030	TN 16ELAG60:T8030	6755510

ANSI	ISO	EDP
TN 16ELG55:T8030	TN 16ELG55:T8030	6755537
TN 16ELG60:T8030	TN 16ELG60:T8030	6755535
TN 16EL-R050:T8330	TN 16EL-R050:T8330	6755977
TN 16EL-R100:T8330	TN 16EL-R100:T8330	6755978
TN 16ER050M:T8010	TN 16ER050M:T8010	7575377
TN 16ER050M:T8030	TN 16ER050M:T8030	6755176
TN 16ER050M-AL:HF7	TN 16ER050M-AL:HF7	7800243
TN 16ER060RD:T8030	TN 16ER060RD:T8030	6755347
TN 16ER060STACME:T8030	TN 16ER060STACME:T8030	7800301
TN 16ER075M:T8010	TN 16ER075M:T8010	7575378
TN 16ER075M:T8030	TN 16ER075M:T8030	6755177
TN 16ER075M-AL:HF7	TN 16ER075M-AL:HF7	7800244
TN 16ER080ACME:T8030	TN 16ER080ACME:T8030	6755357
TN 16ER080API-RD01:T8030	TN 16ER080API-RD01:T8030	6755161
TN 16ER080M:T8010	TN 16ER080M:T8010	7575379
TN 16ER080M:T8030	TN 16ER080M:T8030	6755393
TN 16ER080M-AL:HF7	TN 16ER080M-AL:HF7	7800245
TN 16ER080NPT:T8030	TN 16ER080NPT:T8030	6755497
TN 16ER080RD:T8030	TN 16ER080RD:T8030	6755348
TN 16ER080STACME:T8030	TN 16ER080STACME:T8030	7800297
TN 16ER080UN:T8030	TN 16ER080UN:T8030	6755280
TN 16ER080UN-P1:T8030	TN 16ER080UN-P1:T8030	6755547
TN 16ER080W:T8030	TN 16ER080W:T8030	6755230
TN 16ER090UN:T8030	TN 16ER090UN:T8030	6755281
TN 16ER090W:T8030	TN 16ER090W:T8030	6755231
TN 16ER090ZZ:T8330	TN 16ER090ZZ:T8330	6755086
TN 16ER100ACME:T8030	TN 16ER100ACME:T8030	6755358
TN 16ER100API-RD01:T8030	TN 16ER100API-RD01:T8030	6755160
TN 16ER100M:T8010	TN 16ER100M:T8010	7575380
TN 16ER100M:T8030	TN 16ER100M:T8030	6755167
TN 16ER100M-AL:HF7	TN 16ER100M-AL:HF7	7800246
TN 16ER100MJ:T8030	TN 16ER100MJ:T8030	7800331
TN 16ER100M-P1:T8030	TN 16ER100M-P1:T8030	6755548
TN 16ER100RD:T8030	TN 16ER100RD:T8030	6755349
TN 16ER100STACME:T8030	TN 16ER100STACME:T8030	7800293
TN 16ER100UN:T8030	TN 16ER100UN:T8030	6755282
TN 16ER100W:T8030	TN 16ER100W:T8030	6755367
TN 16ER110BSP:T8030	TN 16ER110BSP:T8030	6755503
TN 16ER110UN:T8030	TN 16ER110UN:T8030	6755283
TN 16ER110W:T8010	TN 16ER110W:T8010	7575427
TN 16ER110W:T8030	TN 16ER110W:T8030	6755165
TN 16ER110W-P1:T8030	TN 16ER110W-P1:T8030	6755549
TN 16ER110ZZ:T8330	TN 16ER110ZZ:T8330	6755087
TN 16ER115NPT:T8010	TN 16ER115NPT:T8010	7575419
TN 16ER115NPT:T8030	TN 16ER115NPT:T8030	6755493
TN 16ER115UN:T8030	TN 16ER115UN:T8030	6755384
TN 16ER120ACME:T8030	TN 16ER120ACME:T8030	6755359
TN 16ER120STACME:T8030	TN 16ER120STACME:T8030	7800289
TN 16ER120UN:T8030	TN 16ER120UN:T8030	6755284
TN 16ER120UNJ:T8030	TN 16ER120UNJ:T8030	7800323
TN 16ER120UN-P1:T8030	TN 16ER120UN-P1:T8030	6755550
TN 16ER120W:T8030	TN 16ER120W:T8030	6755232
TN 16ER125M:T8010	TN 16ER125M:T8010	7575381
TN 16ER125M:T8030	TN 16ER125M:T8030	6755172
TN 16ER125M-AL:HF7	TN 16ER125M-AL:HF7	7800247
TN 16ER125M-P1:T8030	TN 16ER125M-P1:T8030	6755551
TN 16ER130UN:T8030	TN 16ER130UN:T8030	6755285
TN 16ER130ZZ:T8330	TN 16ER130ZZ:T8330	6755088
TN 16ER140BSP:T8030	TN 16ER140BSP:T8030	6755504
TN 16ER140NPT:T8010	TN 16ER140NPT:T8010	7575420
TN 16ER140NPT:T8030	TN 16ER140NPT:T8030	6755494
TN 16ER140UN:T8030	TN 16ER140UN:T8030	6755286
TN 16ER140UN-P1:T8030	TN 16ER140UN-P1:T8030	6755552
TN 16ER140W:T8010	TN 16ER140W:T8010	7575428
TN 16ER140W:T8030	TN 16ER140W:T8030	6755169
TN 16ER140W-P1:T8030	TN 16ER140W-P1:T8030	6755553
TN 16ER150M:T8010	TN 16ER150M:T8010	7575382
TN 16ER150M:T8030	TN 16ER150M:T8030	6755164
TN 16ER150M-AL:HF7	TN 16ER150M-AL:HF7	7800248
TN 16ER150MJ:T8030	TN 16ER150MJ:T8030	7800332
TN 16ER150M-P1:T8030	TN 16ER150M-P1:T8030	6755554
TN 16ER150TR:T8030	TN 16ER150TR:T8030	6755330
TN 16ER160STACME:T8030	TN 16ER160STACME:T8030	7800285
TN 16ER160UN:T8030	TN 16ER160UN:T8030	6755287
TN 16ER160UNJ:T8030	TN 16ER160UNJ:T8030	7800322
TN 16ER160UN-P1:T8030	TN 16ER160UN-P1:T8030	6755555

ANSI	ISO	EDP
TN 16ER160W:T8030	TN 16ER160W:T8030	6755233
TN 16ER160ZZ:T8330	TN 16ER160ZZ:T8330	6755089
TN 16ER175M:T8010	TN 16ER175M:T8010	7575383
TN 16ER175M:T8030	TN 16ER175M:T8030	6755173
TN 16ER175M-AL:HF7	TN 16ER175M-AL:HF7	7800249
TN 16ER175M-P1:T8030	TN 16ER175M-P1:T8030	6755556
TN 16ER180NPT:T8030	TN 16ER180NPT:T8030	6755495
TN 16ER180UN:T8030	TN 16ER180UN:T8030	6755288
TN 16ER180UNJ:T8030	TN 16ER180UNJ:T8030	7800321
TN 16ER180UN-P1:T8030	TN 16ER180UN-P1:T8030	6755557
TN 16ER180W:T8030	TN 16ER180W:T8030	6755234
TN 16ER185ZZ:T8330	TN 16ER185ZZ:T8330	6755090
TN 16ER190BSP:T8030	TN 16ER190BSP:T8030	7800309
TN 16ER190W:T8010	TN 16ER190W:T8010	7575429
TN 16ER190W:T8030	TN 16ER190W:T8030	6755235
TN 16ER190W-P1:T8030	TN 16ER190W-P1:T8030	6755558
TN 16ER200M:T8010	TN 16ER200M:T8010	7575384
TN 16ER200M:T8030	TN 16ER200M:T8030	6755168
TN 16ER200M-AL:HF7	TN 16ER200M-AL:HF7	7800250
TN 16ER200M-P1:T8030	TN 16ER200M-P1:T8030	6755559
TN 16ER200TR:T8030	TN 16ER200TR:T8030	6755331
TN 16ER200UN:T8010	TN 16ER200UN:T8010	7575423
TN 16ER200UN:T8030	TN 16ER200UN:T8030	6755289
TN 16ER200UNJ:T8030	TN 16ER200UNJ:T8030	7800320
TN 16ER200UN-P1:T8030	TN 16ER200UN-P1:T8030	6755560
TN 16ER200W:T8030	TN 16ER200W:T8030	6755236
TN 16ER215ZZ:T8330	TN 16ER215ZZ:T8330	6755091
TN 16ER240UN:T8030	TN 16ER240UN:T8030	6755290
TN 16ER240UNJ:T8030	TN 16ER240UNJ:T8030	7800319
TN 16ER240W:T8030	TN 16ER240W:T8030	7800266
TN 16ER250M:T8010	TN 16ER250M:T8010	7575385
TN 16ER250M:T8030	TN 16ER250M:T8030	6755175
TN 16ER250M-AL:HF7	TN 16ER250M-AL:HF7	7800251
TN 16ER250M-P1:T8030	TN 16ER250M-P1:T8030	6755561
TN 16ER260W:T8030	TN 16ER260W:T8030	7800262
TN 16ER265ZZ:T8330	TN 16ER265ZZ:T8330	6755092
TN 16ER270NPT:T8030	TN 16ER270NPT:T8030	6755496
TN 16ER280BSP:T8030	TN 16ER280BSP:T8030	7800305
TN 16ER280UN:T8030	TN 16ER280UN:T8030	6755291
TN 16ER280UNJ:T8030	TN 16ER280UNJ:T8030	7800318
TN 16ER280W:T8030	TN 16ER280W:T8030	6755237
TN 16ER300M:T8010	TN 16ER300M:T8010	7575386
TN 16ER300M:T8030	TN 16ER300M:T8030	6755166
TN 16ER300M-AL:HF7	TN 16ER300M-AL:HF7	7800252
TN 16ER300M-P1:T8030	TN 16ER300M-P1:T8030	6755562
TN 16ER300TR:T8030	TN 16ER300TR:T8030	6755332
TN 16ER320UN:T8030	TN 16ER320UN:T8030	6755292
TN 16ER320UNJ:T8030	TN 16ER320UNJ:T8030	7800317
TN 16ER350M:T8030	TN 16ER350M:T8030	7800209
TN 16ERA55:T8030	TN 16ERA55:T8030	6755232
TN 16ERA60:T8010	TN 16ERA60:T8010	7575360
TN 16ERA60:T8030	TN 16ERA60:T8030	6755508
TN 16ERAG55:T8010	TN 16ERAG55:T8010	7575316
TN 16ERAG55:T8030	TN 16ERAG55:T8030	6755521
TN 16ERAG60:T8010	TN 16ERAG60:T8010	7575361
TN 16ERAG60:T8030	TN 16ERAG60:T8030	6755507
TN 16ERAG55:T8030	TN 16ERAG55:T8030	6755522
TN 16ERGG60:T8010	TN 16ERGG60:T8010	7575362
TN 16ERGG60:T8030	TN 16ERGG60:T8030	6755509
TN 16ER-R050:T8330	TN 16ER-R050:T8330	6755979
TN 16ER-R100:T8330	TN 16ER-R100:T8330	6755980
TN 16NLO50M:T8030	TN 16NLO50M:T8030	6755178
TN 16NLO60RD:T8030	TN 16NLO60RD:T8030	7800275
TN 16NLO60STACME:T8030	TN 16NLO60STACME:T8030	7800304
TN 16NLO75M:T8030	TN 1	

ANSI	ISO	EDP
TN 16NL100STACME:T8030	TN 16NL100STACME:T8030	7800296
TN 16NL100UN:T8030	TN 16NL100UN:T8030	6755294
TN 16NL100W:T8030	TN 16NL100W:T8030	6755240
TN 16NL1108SPT:T8030	TN 16NL1108SPT:T8030	7800314
TN 16NL110UN:T8030	TN 16NL110UN:T8030	6755295
TN 16NL110W:T8030	TN 16NL110W:T8030	6755241
TN 16NL110ZZ:T8330	TN 16NL110ZZ:T8330	6755094
TN 16NL120ACME:T8030	TN 16NL120ACME:T8030	7800281
TN 16NL120STACME:T8030	TN 16NL120STACME:T8030	7800292
TN 16NL120UN:T8030	TN 16NL120UN:T8030	6755296
TN 16NL120W:T8030	TN 16NL120W:T8030	6755242
TN 16NL125M:T8010	TN 16NL125M:T8010	7575400
TN 16NL125M:T8030	TN 16NL125M:T8030	6755181
TN 16NL130ZZ:T8330	TN 16NL130ZZ:T8330	6755097
TN 16NL140BSPT:T8030	TN 16NL140BSPT:T8030	7800316
TN 16NL140UN:T8030	TN 16NL140UN:T8030	6755297
TN 16NL140W:T8030	TN 16NL140W:T8030	6755243
TN 16NL150M:T8010	TN 16NL150M:T8010	7575401
TN 16NL150M:T8030	TN 16NL150M:T8030	6755182
TN 16NL150TR:T8030	TN 16NL150TR:T8030	6755333
TN 16NL160STACME:T8030	TN 16NL160STACME:T8030	7800288
TN 16NL160UN:T8030	TN 16NL160UN:T8030	6755298
TN 16NL160W:T8030	TN 16NL160W:T8030	6755244
TN 16NL160ZZ:T8330	TN 16NL160ZZ:T8330	6755095
TN 16NL175M:T8010	TN 16NL175M:T8010	7575402
TN 16NL175M:T8030	TN 16NL175M:T8030	6755183
TN 16NL180UN:T8030	TN 16NL180UN:T8030	6755299
TN 16NL185ZZ:T8330	TN 16NL185ZZ:T8330	6755096
TN 16NL190BSPT:T8030	TN 16NL190BSPT:T8030	7800312
TN 16NL190W:T8030	TN 16NL190W:T8030	6755245
TN 16NL200M:T8010	TN 16NL200M:T8010	7575403
TN 16NL200M:T8030	TN 16NL200M:T8030	6755184
TN 16NL200TR:T8030	TN 16NL200TR:T8030	6755334
TN 16NL200UN:T8030	TN 16NL200UN:T8030	6755300
TN 16NL200W:T8030	TN 16NL200W:T8030	6755246
TN 16NL215ZZ:T8330	TN 16NL215ZZ:T8330	6755098
TN 16NL240UN:T8030	TN 16NL240UN:T8030	6755301
TN 16NL240W:T8030	TN 16NL240W:T8030	7800269
TN 16NL250M:T8010	TN 16NL250M:T8010	7575404
TN 16NL250M:T8030	TN 16NL250M:T8030	6755185
TN 16NL260W:T8030	TN 16NL260W:T8030	7800265
TN 16NL265ZZ:T8330	TN 16NL265ZZ:T8330	6755099
TN 16NL280BSPT:T8030	TN 16NL280BSPT:T8030	7800308
TN 16NL280UN:T8030	TN 16NL280UN:T8030	6755302
TN 16NL280W:T8030	TN 16NL280W:T8030	6755247
TN 16NL300M:T8010	TN 16NL300M:T8010	7575405
TN 16NL300M:T8030	TN 16NL300M:T8030	6755186
TN 16NL300TR:T8030	TN 16NL300TR:T8030	6755335
TN 16NL320UN:T8030	TN 16NL320UN:T8030	6755303
TN 16NL350M:T8030	TN 16NL350M:T8030	7800242
TN 16NLA55:T8030	TN 16NLA55:T8030	6755542
TN 16NLA60:T8030	TN 16NLA60:T8030	6755540
TN 16NLAG55:T8030	TN 16NLAG55:T8030	6755531
TN 16NLAG60:T8010	TN 16NLAG60:T8010	7575365
TN 16NLAG60:T8030	TN 16NLAG60:T8030	6755518
TN 16NLG55:T8030	TN 16NLG55:T8030	6755541
TN 16NLG60:T8030	TN 16NLG60:T8030	6755539
TN 16NL-R100:T8330	TN 16NL-R100:T8330	6755981
TN 16NR050M:T8010	TN 16NR050M:T8010	7575406
TN 16NR050M:T8030	TN 16NR050M:T8030	6755187
TN 16NR050M-AL:HF7	TN 16NR050M-AL:HF7	7800253
TN 16NR060RD:T8030	TN 16NR060RD:T8030	6755350
TN 16NR060STACME:T8030	TN 16NR060STACME:T8030	7800303
TN 16NR075M:T8010	TN 16NR075M:T8010	7575407
TN 16NR075M:T8030	TN 16NR075M:T8030	6755188
TN 16NR075M-AL:HF7	TN 16NR075M-AL:HF7	7800254
TN 16NR080ACME:T8030	TN 16NR080ACME:T8030	6755360
TN 16NR080API-RD01:T8030	TN 16NR080API-RD01:T8030	6755163
TN 16NR080NPT:T8030	TN 16NR080NPT:T8030	6755302
TN 16NR080RD:T8030	TN 16NR080RD:T8030	6755351
TN 16NR080STACME:T8030	TN 16NR080STACME:T8030	7800299
TN 16NR080UN:T8010	TN 16NR080UN:T8010	7575424
TN 16NR080UN:T8030	TN 16NR080UN:T8030	6755304
TN 16NR080UN-P1:T8030	TN 16NR080UN-P1:T8030	6755563
TN 16NR080W:T8030	TN 16NR080W:T8030	6755248
TN 16NR090W:T8030	TN 16NR090W:T8030	6755249

ANSI	ISO	EDP
TN 16NR090ZZ:T8330	TN 16NR090ZZ:T8330	6755100
TN 16NR100ACME:T8030	TN 16NR100ACME:T8030	7800280
TN 16NR100API-RD01:T8030	TN 16NR100API-RD01:T8030	6755162
TN 16NR100M:T8010	TN 16NR100M:T8010	7575408
TN 16NR100M:T8030	TN 16NR100M:T8030	6755189
TN 16NR100M-AL:HF7	TN 16NR100M-AL:HF7	7800255
TN 16NR100M-P1:T8030	TN 16NR100M-P1:T8030	6755564
TN 16NR100RD:T8030	TN 16NR100RD:T8030	6755352
TN 16NR100STACME:T8030	TN 16NR100STACME:T8030	7800295
TN 16NR100UN:T8030	TN 16NR100UN:T8030	6755305
TN 16NR100W:T8030	TN 16NR100W:T8030	6755250
TN 16NR110BSPT:T8030	TN 16NR110BSPT:T8030	6755505
TN 16NR110UN:T8030	TN 16NR110UN:T8030	6755306
TN 16NR110W:T8030	TN 16NR110W:T8030	7575432
TN 16NR110W:T8030	TN 16NR110W:T8030	6755171
TN 16NR110W-P1:T8030	TN 16NR110W-P1:T8030	6755565
TN 16NR110ZZ:T8330	TN 16NR110ZZ:T8330	6755101
TN 16NR115NPT:T8010	TN 16NR115NPT:T8010	7575421
TN 16NR115NPT:T8030	TN 16NR115NPT:T8030	6755500
TN 16NR115UN:T8030	TN 16NR115UN:T8030	6755385
TN 16NR120ACME:T8030	TN 16NR120ACME:T8030	7800279
TN 16NR120STACME:T8030	TN 16NR120STACME:T8030	7800291
TN 16NR120UN:T8010	TN 16NR120UN:T8010	7575425
TN 16NR120UN:T8030	TN 16NR120UN:T8030	6755307
TN 16NR120UN-P1:T8030	TN 16NR120UN-P1:T8030	6755566
TN 16NR120W:T8030	TN 16NR120W:T8030	6755251
TN 16NR125M:T8010	TN 16NR125M:T8010	7575409
TN 16NR125M:T8030	TN 16NR125M:T8030	6755190
TN 16NR125M-AL:HF7	TN 16NR125M-AL:HF7	7800256
TN 16NR130UN:T8030	TN 16NR130UN:T8030	6755308
TN 16NR130ZZ:T8330	TN 16NR130ZZ:T8330	6755102
TN 16NR140BSPT:T8030	TN 16NR140BSPT:T8030	6755506
TN 16NR140NPT:T8010	TN 16NR140NPT:T8010	7575422
TN 16NR140NPT:T8030	TN 16NR140NPT:T8030	6755501
TN 16NR140UN:T8030	TN 16NR140UN:T8030	6755309
TN 16NR140UN-P1:T8030	TN 16NR140UN-P1:T8030	6755567
TN 16NR140W:T8010	TN 16NR140W:T8010	7575433
TN 16NR140W:T8030	TN 16NR140W:T8030	6755170
TN 16NR140W-P1:T8030	TN 16NR140W-P1:T8030	6755568
TN 16NR150M:T8010	TN 16NR150M:T8010	7575410
TN 16NR150M:T8030	TN 16NR150M:T8030	6755191
TN 16NR150M-AL:HF7	TN 16NR150M-AL:HF7	7800257
TN 16NR150M-P1:T8030	TN 16NR150M-P1:T8030	6755569
TN 16NR150TR:T8030	TN 16NR150TR:T8030	6755336
TN 16NR160STACME:T8030	TN 16NR160STACME:T8030	7800282
TN 16NR160UN:T8030	TN 16NR160UN:T8030	6755310
TN 16NR160UN-P1:T8030	TN 16NR160UN-P1:T8030	6755570
TN 16NR160W:T8030	TN 16NR160W:T8030	6755252
TN 16NR160ZZ:T8330	TN 16NR160ZZ:T8330	6755103
TN 16NR175M:T8010	TN 16NR175M:T8010	7575411
TN 16NR175M:T8030	TN 16NR175M:T8030	6755192
TN 16NR175M-AL:HF7	TN 16NR175M-AL:HF7	7800258
TN 16NR180UN:T8030	TN 16NR180UN:T8030	6755311
TN 16NR180UN-P1:T8030	TN 16NR180UN-P1:T8030	6755571
TN 16NR185ZZ:T8330	TN 16NR185ZZ:T8330	6755104
TN 16NR190BSPT:T8030	TN 16NR190BSPT:T8030	7800311
TN 16NR190W:T8010	TN 16NR190W:T8010	7575434
TN 16NR190W:T8030	TN 16NR190W:T8030	6755253
TN 16NR200M:T8010	TN 16NR200M:T8010	7575412
TN 16NR200M:T8030	TN 16NR200M:T8030	6755193
TN 16NR200M-AL:HF7	TN 16NR200M-AL:HF7	7800259
TN 16NR200M-P1:T8030	TN 16NR200M-P1:T8030	6755572
TN 16NR200TR:T8030	TN 16NR200TR:T8030	6755337
TN 16NR200UN:T8010	TN 16NR200UN:T8010	7575426
TN 16NR200UN:T8030	TN 16NR200UN:T8030	6755312
TN 16NR200UN-P1:T8030	TN 16NR200UN-P1:T8030	6755573
TN 16NR200W:T8030	TN 16NR200W:T8030	6755254
TN 16NR215ZZ:T8330	TN 16NR215ZZ:T8330	6755105
TN 16NR240UN:T8030	TN 16NR240UN:T8030	6755313
TN 16NR240W:T8030	TN 16NR240W:T8030	7800268
TN 16NR250M:T8010	TN 16NR250M:T8010	7575413
TN 16NR250M:T8030	TN 16NR250M:T8030	6755194
TN 16NR250M-AL:HF7	TN 16NR250M-AL:HF7	7800260
TN 16NR250M-P1:T8030	TN 16NR250M-P1:T8030	6755574
TN 16NR260W:T8030	TN 16NR260W:T8030	7800264
TN 16NR265ZZ:T8330	TN 16NR265ZZ:T8330	6755106

ANSI	ISO	EDP
TN 16NR280BSPT:T8030	TN 16NR280BSPT:T8030	7800307
TN 16NR280UN:T8030	TN 16NR280UN:T8030	6755314
TN 16NR280W:T8030	TN 16NR280W:T8030	6755255
TN 16NR300M:T8010	TN 16NR300M:T8010	7575414
TN 16NR300M:T8030	TN 16NR300M:T8030	6755195
TN 16NR300M-AL:HF7	TN 16NR300M-AL:HF7	7800261
TN 16NR300M-P1:T8030	TN 16NR300M-P1:T8030	6755575
TN 16NR300TR:T8030	TN 16NR300TR:T8030	6755338
TN 16NR320UN:T8030	TN 16NR320UN:T8030	6755315
TN 16NR350M:T8030	TN 16NR350M:T8030	7800241
TN 16NRA55:T8030	TN 16NRA55:T8030	6755530
TN 16NRA60:T8010	TN 16NRA60:T8010	7575366
TN 16NRA60:T8030	TN 16NRA60:T8030	6755517
TN 16NRA65:T8010	TN 16NRA65:T8010	7575318
TN 16NRA65:T8030	TN 16NRA65:T8030	6755528
TN 16NRAG60:T8010	TN 16NRAG60:T8010	7575367
TN 16NRAG60:T8030	TN 16NRAG60:T8030	6755515
TN 16NRG55:T8030	TN 16NRG55:T8030	6755529
TN 16NRG60:T8010	TN 16NRG60:T8010	7575368
TN 16NRG60:T8030	TN 16NRG60:T8030	6755516
TN 16NR-R100:T8330	TN 16NR-R100:T8330	6755982
TN 22E050ACME:T8030	TN 22E050ACME:T8030	6755361
TN 22E050UN:T8030	TN 22E050UN:T8030	6755316
TN 22E050W:T8030	TN 22E050W:T8030	6755256
TN 22E060ACME:T8030	TN 22E060ACME:T8030	6755362
TN 22E060RD:T8030	TN 22E060RD:T8030	6755353
TN 22E060UN:T8030	TN 22E060UN:T8030	6755317
TN 22E060W:T8030	TN 22E060W:T8030	6755257
TN 22E070UN:T8030	TN 22E070UN:T8030	6755318
TN 22E070W:T8030	TN 22E070W:T8030	6755258
TN 22EL265ZZ:T8330	TN 22EL265ZZ:T8330	6755983
TN 22EL315ZZ:T8330	TN 22EL315ZZ:T8330	6755984
TN 22EL350M:T8030	TN 22EL350M:T8030	6755205
TN 22EL400M:T8030	TN 22EL400M:T8030	6755206
TN 22EL400TR:T8030	TN 22EL400TR:T8030	6755339
TN 22EL415ZZ:T8330	TN 22EL415ZZ:T8330	6755985
TN 22EL450M:T8030	TN 22EL450M:T8030	6755207
TN 22EL500M:T8030	TN 22EL500M:T8030	6755208
TN 22EL500TR:T8030	TN 22EL500TR:T8030	6755340
TN 22ELN55:T8030	TN 22ELN55:T8030	6755525
TN 22ELN60:T8030	TN 22ELN60:T8030	6755512
TN 22EL-R150:T8330	TN 22EL-R150:T8330	6755986
TN 22EN350-500M:T8030	TN 22EN350-500M:T8030	6755657
TN 22EN550-800M:T8030	TN 22EN550-800M:T8030	6755658
TN 22EN600TR:T8030	TN 22EN600TR:T8030	6755388
TN 22EN700TR:T8030	TN 22EN700TR:T8030	6755390
TN 22ER050ACME:T8030	TN 22ER050ACME:T8030	6755363
TN 22ER050UN:T8030	TN 22ER050UN:T8030	6755319
TN 22ER050W:T8030	TN 22ER050W:T8030	6755259
TN 22ER060ACME:T8030	TN 22ER060ACME:T8030	6755364
TN 22ER060RD:T8030	TN 22ER060RD:T8030	6755354
TN 22ER060UN:T8030	TN 22ER060UN:T8030	6755320
TN 22ER060W:T8030	TN 22ER060W:T8030	6755260
TN 22ER070UN:T8030	TN 22ER070UN:T8030	6755321
TN 22ER070W:T8030	TN 22ER070W:T8030	6755261
TN 22ER265ZZ:T8330	TN 22ER265ZZ:T8330	6755987
TN 22ER315ZZ:T8330	TN 22ER315ZZ:T8330	6755988
TN 22ER350M:T8010	TN 22ER350M:T8010	7575387
TN 22ER350M:T8030	TN 22ER350M:T8030	6755209
TN 22ER400M:T8010	TN 22ER400M:T8010	7575388
TN 22ER400M:T8030	TN 22ER400M:T8030	6755210
TN 22ER400TR:T8030	TN 22ER400TR:T8030	6755341
TN 22ER415ZZ:T8330	TN 22ER415ZZ:T8330	6755989
TN 22ER450M:T8010	TN 22ER450M:T8010	7575389
TN 22ER450M:T8030	TN 22ER450M:T803	



ANSI	ISO	EDP
TN 22NL060RD:T8030	TN 22NL060RD:T8030	6755355
TN 22NL060UN:T8030	TN 22NL060UN:T8030	6755322
TN 22NL060W:T8030	TN 22NL060W:T8030	6755263
TN 22NL070UN:T8030	TN 22NL070UN:T8030	6755323
TN 22NL070W:T8030	TN 22NL070W:T8030	6755264
TN 22NL265ZZ:T8330	TN 22NL265ZZ:T8330	6755991
TN 22NL315ZZ:T8330	TN 22NL315ZZ:T8330	6755992
TN 22NL350M:T8030	TN 22NL350M:T8030	6755213
TN 22NL400M:T8030	TN 22NL400M:T8030	6755214
TN 22NL400TR:T8030	TN 22NL400TR:T8030	6755343
TN 22NL415ZZ:T8330	TN 22NL415ZZ:T8330	6755993
TN 22NL500M:T8030	TN 22NL500M:T8030	6755215
TN 22NL500TR:T8030	TN 22NL500TR:T8030	6755344
TN 22NLN55:T8030	TN 22NLN55:T8030	6755533
TN 22NLN60:T8030	TN 22NLN60:T8030	6755520
TN 22NL-R150:T8330	TN 22NL-R150:T8330	6755994
TN 22NN350-500M:T8030	TN 22NN350-500M:T8030	6755659
TN 22NN550-800M:T8030	TN 22NN550-800M:T8030	6755660
TN 22NN600TR:T8030	TN 22NN600TR:T8030	6755389
TN 22NN700TR:T8030	TN 22NN700TR:T8030	6755391
TN 22NR050ACME:T8030	TN 22NR050ACME:T8030	6755366
TN 22NR050UN:T8030	TN 22NR050UN:T8030	6755324
TN 22NR050W:T8030	TN 22NR050W:T8030	6755265
TN 22NR060ACME:T8030	TN 22NR060ACME:T8030	6755174
TN 22NR060RD:T8030	TN 22NR060RD:T8030	6755356
TN 22NR060UN:T8030	TN 22NR060UN:T8030	6755325
TN 22NR060W:T8030	TN 22NR060W:T8030	6755266
TN 22NR070UN:T8030	TN 22NR070UN:T8030	6755326
TN 22NR070W:T8030	TN 22NR070W:T8030	6755267
TN 22NR265ZZ:T8330	TN 22NR265ZZ:T8330	6755995
TN 22NR315ZZ:T8330	TN 22NR315ZZ:T8330	6755996
TN 22NR350M:T8010	TN 22NR350M:T8010	7575415
TN 22NR350M:T8030	TN 22NR350M:T8030	6755216
TN 22NR400M:T8010	TN 22NR400M:T8010	7575416
TN 22NR400M:T8030	TN 22NR400M:T8030	6755217
TN 22NR400TR:T8030	TN 22NR400TR:T8030	6755345
TN 22NR415ZZ:T8330	TN 22NR415ZZ:T8330	6755997
TN 22NR450M:T8010	TN 22NR450M:T8010	7575417
TN 22NR450M:T8030	TN 22NR450M:T8030	6755218
TN 22NR500M:T8010	TN 22NR500M:T8010	7575418
TN 22NR500M:T8030	TN 22NR500M:T8030	6755219
TN 22NR500TR:T8030	TN 22NR500TR:T8030	6755346
TN 22NRN55:T8030	TN 22NRN55:T8030	6755532
TN 22NRN60:T8010	TN 22NRN60:T8010	7575369
TN 22NRN60:T8030	TN 22NRN60:T8030	6755519
TN 22NR-R150:T8330	TN 22NR-R150:T8330	6755998
TNG 332 T00420:TC100	TNGN 160408 T01020:TC100	6755422
TNG 333 T00420:TC100	TNGN 160412 T01020:TC100	6755411
TNG 352 T00820:TC100	TNGN 160708 T02020:TC100	6755449
TNGA 332 T00420:TC100	TNGA 160408 T01020:TC100	6755446
TNGA 332500420R:T8310	TNGA 160408S01020C:T8310	6755928
TNGA 333 T00420:TC100	TNGA 160412 T01020:TC100	6755421
TNGJ 220720-PF-S01:T9315	TNGJ 220720-PF-S01:T9315	7347229
TNGJ 220720-PF-S02:T7325	TNGJ 220720-PF-S02:T7325	7347230
TNGJ 220720-PM-S01:T9315	TNGJ 220720-PM-S01:T9315	7347231
TNGJ 220720-PM-S02:T7325	TNGJ 220720-PM-S02:T7325	7347232
TNGJ 220720-PM-S02:T9226	TNGJ 220720-PM-S02:T9226	6931833
TNGJ 220720-PM-S02:T9315	TNGJ 220720-PM-S02:T9315	7347233
TNGJ 281025-PF-S01:6630	TNGJ 281025-PF-S01:6630	6752812
TNGJ 281025-PF-S01:T9226	TNGJ 281025-PF-S01:T9226	6931834
TNGJ 281025-PF-S01:T9315	TNGJ 281025-PF-S01:T9315	7347234
TNGJ 281025-PF-S02:T7325	TNGJ 281025-PF-S02:T7325	7347235
TNGJ 281025-PF-S03:T7325	TNGJ 281025-PF-S03:T7325	7347236
TNGX 100402SR-F:M8330	TNGX 100402SR-F:M8330	7451058
TNGX 100402SR-F:M8340	TNGX 100402SR-F:M8340	7178538
TNGX 100404FR-FA:HF7	TNGX 100404FR-FA:HF7	7178567
TNGX 100404FR-FA:M0315	TNGX 100404FR-FA:M0315	7178569
TNGX 100404SR-F:8215	TNGX 100404SR-F:8215	7178552
TNGX 100404SR-F:M6330	TNGX 100404SR-F:M6330	7342921
TNGX 100404SR-F:M8330	TNGX 100404SR-F:M8330	7451059
TNGX 100404SR-F:M8340	TNGX 100404SR-F:M8340	7178551
TNGX 100404SR-F:M9340	TNGX 100404SR-F:M9340	7178550
TNGX 100404SR-M:8215	TNGX 100404SR-M:8215	7178558
TNGX 100404SR-M:M6330	TNGX 100404SR-M:M6330	7601345
TNGX 100404SR-M:M8330	TNGX 100404SR-M:M8330	7451100
TNGX 100404SR-M:M8340	TNGX 100404SR-M:M8340	7178560

ANSI	ISO	EDP
TNGX 100404SR-M:M8345	TNGX 100404SR-M:M8345	7216248
TNGX 100404SR-M:M9340	TNGX 100404SR-M:M9340	7178561
TNGX 100408FR-FA:HF7	TNGX 100408FR-FA:HF7	7178568
TNGX 100408FR-FA:M0315	TNGX 100408FR-FA:M0315	7178570
TNGX 100408SR-F:8215	TNGX 100408SR-F:8215	7178557
TNGX 100408SR-F:M6330	TNGX 100408SR-F:M6330	7342922
TNGX 100408SR-F:M8330	TNGX 100408SR-F:M8330	7451101
TNGX 100408SR-F:M8340	TNGX 100408SR-F:M8340	7178554
TNGX 100408SR-F:M9340	TNGX 100408SR-F:M9340	7178556
TNGX 100408SR-M:8215	TNGX 100408SR-M:8215	7178562
TNGX 100408SR-M:M6330	TNGX 100408SR-M:M6330	7342923
TNGX 100408SR-M:M8310	TNGX 100408SR-M:M8310	7178565
TNGX 100408SR-M:M8330	TNGX 100408SR-M:M8330	7451102
TNGX 100408SR-M:M8340	TNGX 100408SR-M:M8340	7178564
TNGX 100408SR-M:M8345	TNGX 100408SR-M:M8345	7216249
TNGX 100408SR-M:M9340	TNGX 100408SR-M:M9340	7178566
TNGX 100412SR-M:M8330	TNGX 100412SR-M:M8330	7799438
TNGX 100412SR-M:M8340	TNGX 100412SR-M:M8340	7799439
TNGX 100416SR-M:M8310	TNGX 100416SR-M:M8310	7799480
TNGX 100416SR-M:M8330	TNGX 100416SR-M:M8330	7799481
TNGX 100416SR-M:M8340	TNGX 100416SR-M:M8340	7799482
TNMF 1204ANEN:M5315	TNMF 1204ANEN:M5315	6754630
TNMF 1204ANEN:M8330	TNMF 1204ANEN:M8330	7451103
TNMA 331:T5305	TNMA 160404:T5305	6755885
TNMA 331:T5315	TNMA 160404:T5315	6922800
TNMA 332:T5305	TNMA 160408:T5305	6755886
TNMA 332:T5315	TNMA 160408:T5315	6755887
TNMA 332:T6310	TNMA 160408:T6310	6922859
TNMA 332:T5305	TNMA 160408:T5305	6755887
TNMA 333:T5305	TNMA 160412:T5305	6755888
TNMA 333:T5315	TNMA 160412:T5315	6922801
TNMA 333:T6310	TNMA 160412:T6310	6922860
TNMA 432:T5305	TNMA 220408:T5305	6755889
TNMA 432:T5315	TNMA 220408:T5315	6922802
TNMA 432:T6310	TNMA 220408:T6310	6922861
TNMA 433:T5305	TNMA 220412:T5305	6755890
TNMA 433:T5315	TNMA 220412:T5315	6922803
TNMG 331-FF:T7325	TNMG 160404-FF:T7325	7156505
TNMG 331-FF:T8315	TNMG 160404-FF:T8315	6753624
TNMG 331-FF:T8330	TNMG 160404-FF:T8330	6922782
TNMG 331-FM:T7325	TNMG 160404-FM:T7325	7156376
TNMG 331-FM:T7335	TNMG 160404-FM:T7335	6754820
TNMG 331-FM:T8315	TNMG 160404-FM:T8315	6753625
TNMG 331-FM:T8330	TNMG 160404-FM:T8330	6754192
TNMG 331-FM:T9310	TNMG 160404-FM:T9310	6755056
TNMG 331-FM:T9315	TNMG 160404-FM:T9315	6754408
TNMG 331-FM:T9325	TNMG 160404-FM:T9325	6754105
TNMG 331-FM:T1310	TNMG 160404-FM:T1310	6798571
TNMG 331L-SI:6630	TNMG 160404EL-SI:6630	6752015
TNMG 331L-SI:T7325	TNMG 160404EL-SI:T7325	7156377
TNMG 331L-SI:T7335	TNMG 160404EL-SI:T7335	6754821
TNMG 331L-SI:T8315	TNMG 160404EL-SI:T8315	6922736
TNMG 331L-SI:T8330	TNMG 160404EL-SI:T8330	6754368
TNMG 331L-SI:T9325	TNMG 160404EL-SI:T9325	6754106
TNMG 331-M:T5315	TNMG 160404E-M:T5315	6755697
TNMG 331-M:T9315	TNMG 160404E-M:T9315	6754409
TNMG 331-M:T9325	TNMG 160404E-M:T9325	6754107
TNMG 331-M:T9335	TNMG 160404E-M:T9335	6754976
TNMG 331-NF:HF7	TNMG 160404E-NF:HF7	6834704
TNMG 331-NF:T6310	TNMG 160404E-NF:T6310	6922845
TNMG 331-NF:T7325	TNMG 160404E-NF:T7325	7156378
TNMG 331-NF:T7335	TNMG 160404E-NF:T7335	6834705
TNMG 331-NF:T8315	TNMG 160404E-NF:T8315	6834706
TNMG 331-NF:T8330	TNMG 160404E-NF:T8330	6834707
TNMG 331-NF:T9315	TNMG 160404E-NF:T9315	6834708
TNMG 331-NF:T9325	TNMG 160404E-NF:T9325	6834709
TNMG 331-NM:T7325	TNMG 160404E-NM:T7325	7156379
TNMG 331-NM:T7335	TNMG 160404E-NM:T7335	6754822
TNMG 331-NM:T8315	TNMG 160404E-NM:T8315	6922675
TNMG 331-NM:T8330	TNMG 160404E-NM:T8330	6755114
TNMG 331-NM:T9325	TNMG 160404E-NM:T9325	6754109
TNMG 331-NM:T6310	TNMG 160404E-NM:T6310	7454470
TNMG 331-NMR:T7325	TNMG 160404E-NMR:T7325	7156380
TNMG 331-NMR:T7335	TNMG 160404E-NMR:T7335	7038104
TNMG 331-NMR:T8330	TNMG 160404E-NMR:T8330	7038101
TNMG 331-NMR:T9315	TNMG 160404E-NMR:T9315	7038102

ANSI	ISO	EDP
TNMG 331-NMR:T9325	TNMG 160404E-NMR:T9325	7038103
TNMG 331R-SI:6630	TNMG 160404ER-SI:6630	6751901
TNMG 331R-SI:T7325	TNMG 160404ER-SI:T7325	7156381
TNMG 331R-SI:T7335	TNMG 160404ER-SI:T7335	6754823
TNMG 331R-SI:T8315	TNMG 160404ER-SI:T8315	6922737
TNMG 331R-SI:T8330	TNMG 160404ER-SI:T8330	6754369
TNMG 331R-SI:T9325	TNMG 160404ER-SI:T9325	6753846
TNMG 331-SF:H07	TNMG 160404E-SF:H07	6921017
TNMG 331-SF:T6310	TNMG 160404E-SF:T6310	6919798
TNMG 331-SF:T7325	TNMG 160404E-SF:T7325	7156382
TNMG 331-SF:T7335	TNMG 160404E-SF:T7335	6919799
TNMG 331-SF:T8315	TNMG 160404E-SF:T8315	6919800
TNMG 331-SF:T8330	TNMG 160404E-SF:T8330	6919801
TNMG 331-SF:T9315	TNMG 160404E-SF:T9315	7035066
TNMG 331-SF:T9325	TNMG 160404E-SF:T9325	7035067
TNMG 331-SM:T6310	TNMG 160404E-SM:T6310	6915854
TNMG 331-SM:T7325	TNMG 160404E-SM:T7325	7156383
TNMG 331-SM:T7335	TNMG 160404E-SM:T7335	6915855
TNMG 331-SM:T8330	TNMG 160404E-SM:T8330	6915856
TNMG 331-SM:T9315	TNMG 160404E-SM:T9315	6915857
TNMG 331-SM:T9325	TNMG 160404E-SM:T9325	6915858
TNMG 332-FF:T7325	TNMG 160408E-FF:T7325	7156506
TNMG 332-FF:T8315	TNMG 160408E-FF:T8315	6753626
TNMG 332-FM:T7325	TNMG 160408E-FM:T7325	7156384
TNMG 332-FM:T7335	TNMG 160408E-FM:T7335	6754824
TNMG 332-FM:T8315	TNMG 160408E-FM:T8315	6753627
TNMG 332-FM:T8330	TNMG 160408E-FM:T8330	6754193
TNMG 332-FM:T9310	TNMG 160408E-FM:T9310	6755057
TNMG 332-FM:T9315	TNMG 160408E-FM:T9315	6753748
TNMG 332-FM:T9325	TNMG 160408E-FM:T9325	6754111
TNMG 332-FM:T1310	TNMG 160408E-FM:T1310	6798572
TNMG 332-KR:T5305	TNMG 160408E-KR:T5305	6755892
TNMG 332-KR:T5315	TNMG 160408E-KR:T5315	6755698
TNMG 332L-SI:6630	TNMG 160408EL-SI:6630	6752016
TNMG 332L-SI:T7325	TNMG 160408EL-SI:T7325	7156385
TNMG 332L-SI:T7335	TNMG 160408EL-SI:T7335	6754825
TNMG 332L-SI:T8315	TNMG 160408EL-SI:T8315	6922738
TNMG 332L-SI:T8330	TNMG 160408EL-SI:T8330	6754370
TNMG 332L-SI:T9325	TNMG 160408EL-SI:T9325	6754112
TNMG 332-M:6630	TNMG 160408E-M:6630	6751551
TNMG 332-M:T5305	TNMG 160408E-M:T5305	6755893
TNMG 332-M:T5315	TNMG 160408E-M:T5315	6755699
TNMG 332-M:T9310	TNMG 160408E-M:T9310	6755058
TNMG 332-M:T9315	TNMG 160408E-M:T9315	6753749
TNMG 332-M:T9325	TNMG 160408E-M:T9325	6753847
TNMG 332-M:T9335	TNMG 160408E-M:T9335	6754977
TNMG 332-NF:HF7	TNMG 160408E-NF:HF7	6834710
TNMG 332-NF:T6310	TNMG 160408E-NF:T6310	6922846
TNMG 332-NF:T7325	TNMG 160408E-NF:T7325	7156386
TNMG 332-NF:T7335	TNMG 160408E-NF:T7335	6834711
TNMG 332-NF:T8315	TNMG 160408E-NF:T8315	6834712
TNMG 332-NF:T8330	TNMG 160408E-NF:T8330	6834713
TNMG 332-NF:T9315	TNMG 160408E-NF:T9315	6834714
TNMG 332-NF:T9325	TNMG 160408E-NF:T9325	6834715
TNMG 332-NM:T7325	TNMG 160408E-NM:T7325	7156387
TNMG 332-NM:T7335	TNMG 160408E-NM:T7335	6754826
TNMG 332-NM:T8315	TNMG 160408E-NM:T8315	6922676
TNMG 332-NM:T8330	TNMG 160408E-NM:T8330	6755115
TNMG 332-NM:T9315	TNMG 160408E-NM:T9315	6922923</

ANSI	ISO	EDP
TNMG 332-RM: T9310	TNMG 160408E-RM: T9310	6755059
TNMG 332-RM: T9315	TNMG 160408E-RM: T9315	6754411
TNMG 332-RM: T9325	TNMG 160408E-RM: T9325	6754114
TNMG 332-RM: T9335	TNMG 160408E-RM: T9335	6754979
TNMG 332R-SI: 6630	TNMG 160408E-R:SI: 6630	6751902
TNMG 332R-SI: T7325	TNMG 160408E-R:SI: T7325	7156390
TNMG 332R-SI: T7335	TNMG 160408E-R:SI: T7335	6754827
TNMG 332R-SI: T8315	TNMG 160408E-R:SI: T8315	6922739
TNMG 332R-SI: T8330	TNMG 160408E-R:SI: T8330	6754371
TNMG 332R-SI: T9325	TNMG 160408E-R:SI: T9325	6754115
TNMG 332-SF: H07	TNMG 160408E-SF: H07	6921018
TNMG 332-SF: T6310	TNMG 160408E-SF: T6310	6919803
TNMG 332-SF: T7325	TNMG 160408E-SF: T7325	7156391
TNMG 332-SF: T7335	TNMG 160408E-SF: T7335	6919804
TNMG 332-SF: T8315	TNMG 160408E-SF: T8315	6919805
TNMG 332-SF: T8330	TNMG 160408E-SF: T8330	6919806
TNMG 332-SM: T6310	TNMG 160408E-SM: T6310	6915859
TNMG 332-SM: T7325	TNMG 160408E-SM: T7325	7156392
TNMG 332-SM: T7335	TNMG 160408E-SM: T7335	6915860
TNMG 332-SM: T8310	TNMG 160408E-SM: T8310	6915861
TNMG 332-SM: T9315	TNMG 160408E-SM: T9315	6915862
TNMG 332-SM: T9325	TNMG 160408E-SM: T9325	6915863
TNMG 333-FM: T7325	TNMG 160412E-FM: T7325	7156393
TNMG 333-FM: T8330	TNMG 160412E-FM: T8330	6754194
TNMG 333-FM: T9310	TNMG 160412E-FM: T9310	7763103
TNMG 333-FM: T9315	TNMG 160412E-FM: T9315	6754412
TNMG 333-FM: T9325	TNMG 160412E-FM: T9325	6754116
TNMG 333-M: T5315	TNMG 160412E-M: T5315	6755701
TNMG 333-M: T9315	TNMG 160412E-M: T9315	6754413
TNMG 333-M: T9325	TNMG 160412E-M: T9325	6754117
TNMG 333-M: T9335	TNMG 160412E-M: T9335	6754980
TNMG 333-NMR: T7325	TNMG 160412E-NMR: T7325	7156394
TNMG 333-NMR: T9315	TNMG 160412E-NMR: T9315	7038109
TNMG 333-NMR: T9325	TNMG 160412E-NMR: T9325	7038110
TNMG 333-R: T5315	TNMG 160412E-R: T5315	6922765
TNMG 333-R: T9310	TNMG 160412E-R: T9310	6922957
TNMG 333-R: T9315	TNMG 160412E-R: T9315	6922924
TNMG 333-R: T9325	TNMG 160412E-R: T9325	6754118
TNMG 333-R: T9335	TNMG 160412E-R: T9335	6754981
TNMG 333-RM: T5305	TNMG 160412E-RM: T5305	6755845
TNMG 333-RM: T5315	TNMG 160412E-RM: T5315	6755702
TNMG 333-RM: T7325	TNMG 160412E-RM: T7325	7156395
TNMG 333-RM: T7335	TNMG 160412E-RM: T7335	6922708
TNMG 333-RM: T8330	TNMG 160412E-RM: T8330	6755131
TNMG 333-RM: T9315	TNMG 160412E-RM: T9315	6754414
TNMG 333-RM: T9325	TNMG 160412E-RM: T9325	6753849
TNMG 333-RM: T9335	TNMG 160412E-RM: T9335	6754982
TNMG 333-SF: T6310	TNMG 160412E-SF: T6310	7763104
TNMG 333-SF: T7325	TNMG 160412E-SF: T7325	7156514
TNMG 333-SF: T9325	TNMG 160412E-SF: T9325	7763105
TNMG 333-SM: T6310	TNMG 160412E-SM: T6310	7763106
TNMG 333-SM: T7325	TNMG 160412E-SM: T7325	7156396
TNMG 333-SM: T7335	TNMG 160412E-SM: T7335	6915864
TNMG 333-SM: T9325	TNMG 160412E-SM: T9325	6915865
TNMG 431-FM: T8330	TNMG 220404E-FM: T8330	6926951
TNMG 431-FM: T9315	TNMG 220404E-FM: T9315	6926949
TNMG 431-FM: T9325	TNMG 220404E-FM: T9325	6926950
TNMG 431-SF: T6310	TNMG 220404E-SF: T6310	7763107
TNMG 431-SF: T7325	TNMG 220404E-SF: T7325	7763108
TNMG 431-SF: T9325	TNMG 220404E-SF: T9325	7763109
TNMG 431-SM: T6310	TNMG 220404E-SM: T6310	6915866
TNMG 431-SM: T7325	TNMG 220404E-SM: T7325	7156397
TNMG 431-SM: T8330	TNMG 220404E-SM: T8330	6915867
TNMG 431-SM: T9325	TNMG 220404E-SM: T9325	6915868
TNMG 432-FM: T8330	TNMG 220408E-FM: T8330	6926954
TNMG 432-FM: T9315	TNMG 220408E-FM: T9315	6926952
TNMG 432-FM: T9325	TNMG 220408E-FM: T9325	6926953
TNMG 432-M: 6630	TNMG 220408E-M: 6630	6751552
TNMG 432-M: T5305	TNMG 220408E-M: T5305	6755895
TNMG 432-M: T5315	TNMG 220408E-M: T5315	6755703
TNMG 432-M: T9310	TNMG 220408E-M: T9310	6755060
TNMG 432-M: T9315	TNMG 220408E-M: T9315	6754415
TNMG 432-M: T9325	TNMG 220408E-M: T9325	6753850
TNMG 432-M: T9335	TNMG 220408E-M: T9335	6754983

ANSI	ISO	EDP
TNMG 432-NM: T7325	TNMG 220408E-NM: T7325	7156398
TNMG 432-NM: T7335	TNMG 220408E-NM: T7335	6754828
TNMG 432-NM: T8315	TNMG 220408E-NM: T8315	6922677
TNMG 432-NM: T8330	TNMG 220408E-NM: T8330	6754209
TNMG 432-NM: T9315	TNMG 220408E-NM: T9315	6922925
TNMG 432-NM: T9325	TNMG 220408E-NM: T9325	6754119
TNMG 432-NMR: T6310	TNMG 220408E-NMR: T6310	7454472
TNMG 432-NMR: T7325	TNMG 220408E-NMR: T7325	7156399
TNMG 432-NMR: T7335	TNMG 220408E-NMR: T7335	7038114
TNMG 432-NMR: T8330	TNMG 220408E-NMR: T8330	7038111
TNMG 432-NMR: T9315	TNMG 220408E-NMR: T9315	7038112
TNMG 432-NMR: T9325	TNMG 220408E-NMR: T9325	7038113
TNMG 432-R: T9315	TNMG 220408E-R: T9315	6922926
TNMG 432-R: T9325	TNMG 220408E-R: T9325	6754120
TNMG 432-R: T9335	TNMG 220408E-R: T9335	6922766
TNMG 432-RM: T5305	TNMG 220408E-RM: T5305	6755896
TNMG 432-RM: T5315	TNMG 220408E-RM: T5315	6755704
TNMG 432-RM: T7325	TNMG 220408E-RM: T7325	7156400
TNMG 432-RM: T7335	TNMG 220408E-RM: T7335	6922709
TNMG 432-RM: T9310	TNMG 220408E-RM: T9310	6755062
TNMG 432-RM: T9315	TNMG 220408E-RM: T9315	6754416
TNMG 432-RM: T9325	TNMG 220408E-RM: T9325	6754121
TNMG 432-RM: T9335	TNMG 220408E-RM: T9335	6754984
TNMG 432-SF: T6310	TNMG 220408E-SF: T6310	6919807
TNMG 432-SF: T8315	TNMG 220408E-SF: T8315	6919808
TNMG 432-SF: T8330	TNMG 220408E-SF: T8330	6919809
TNMG 432-SM: T6310	TNMG 220408E-SM: T6310	6915869
TNMG 432-SM: T7325	TNMG 220408E-SM: T7325	7156401
TNMG 432-SM: T7335	TNMG 220408E-SM: T7335	6915870
TNMG 432-SM: T8330	TNMG 220408E-SM: T8330	6915871
TNMG 432-SM: T9315	TNMG 220408E-SM: T9315	6915872
TNMG 432-SM: T9325	TNMG 220408E-SM: T9325	6915873
TNMG 433-M: 6630	TNMG 220412E-M: 6630	6751553
TNMG 433-M: T5315	TNMG 220412E-M: T5315	6755705
TNMG 433-M: T9315	TNMG 220412E-M: T9315	6754417
TNMG 433-M: T9325	TNMG 220412E-M: T9325	6754487
TNMG 433-M: T9335	TNMG 220412E-M: T9335	6754985
TNMG 433-NM: T7325	TNMG 220412E-NM: T7325	7156402
TNMG 433-NM: T7335	TNMG 220412E-NM: T7335	6754829
TNMG 433-NM: T9325	TNMG 220412E-NM: T9325	6754137
TNMG 433-NMR: T6310	TNMG 220412E-NMR: T6310	7454473
TNMG 433-NMR: T7325	TNMG 220412E-NMR: T7325	7156403
TNMG 433-NMR: T9315	TNMG 220412E-NMR: T9315	7038115
TNMG 433-NMR: T9325	TNMG 220412E-NMR: T9325	7038116
TNMG 433-R: T9310	TNMG 220412E-R: T9310	6922959
TNMG 433-R: T9315	TNMG 220412E-R: T9315	6922927
TNMG 433-R: T9325	TNMG 220412E-R: T9325	6754122
TNMG 433-RM: T5305	TNMG 220412E-RM: T5305	6755898
TNMG 433-RM: T5315	TNMG 220412E-RM: T5315	6755706
TNMG 433-RM: T7325	TNMG 220412E-RM: T7325	7156404
TNMG 433-RM: T7335	TNMG 220412E-RM: T7335	6922710
TNMG 433-RM: T9315	TNMG 220412E-RM: T9315	6754418
TNMG 433-RM: T9325	TNMG 220412E-RM: T9325	6754143
TNMG 433-RM: T9335	TNMG 220412E-RM: T9335	6754986
TNMG 433-SF: T6310	TNMG 220412E-SF: T6310	7763110
TNMG 433-SF: T7325	TNMG 220412E-SF: T7325	7763111
TNMG 433-SF: T9325	TNMG 220412E-SF: T9325	7763112
TNMG 433-SM: T6310	TNMG 220412E-SM: T6310	7763113
TNMG 433-SM: T7325	TNMG 220412E-SM: T7325	7156405
TNMG 433-SM: T7335	TNMG 220412E-SM: T7335	6915874
TNMG 433-SM: T9315	TNMG 220412E-SM: T9315	6915875
TNMG 433-SM: T9325	TNMG 220412E-SM: T9325	6915876
TNMG 434-R: T9315	TNMG 220416E-R: T9315	6922928
TNMG 434-R: T9325	TNMG 220416E-R: T9325	6754144
TNMG 434-RM: T7325	TNMG 220416E-RM: T7325	7156406
TNMG 434-RM: T9315	TNMG 220416E-RM: T9315	6754149
TNMG 434-RM: T9325	TNMG 220416E-RM: T9325	6754176
TNMG 434-RM: T9335	TNMG 220416E-RM: T9335	6754987
TNMG 543-RM: T7325	TNMG 220416E-RM: T7325	7156517
TNMG 543-RM: T9325	TNMG 220416E-RM: T9325	6926955
TNMG 544-RM: T7325	TNMG 270616E-RM: T7325	7156407
TNMG 544-RM: T9325	TNMG 270616E-RM: T9325	6931886
TNMG 544-RM: T9315	TNMG 270616E-RM: T9315	6754534
TNMG 544-RM: T9325	TNMG 270616E-RM: T9325	6754177
TNMG 544-RM: T9335	TNMG 270616E-RM: T9335	6754988
TNMG 546-RM: T7325	TNMG 270624E-RM: T7325	7156408

ANSI	ISO	EDP
TNMG 546-RM: T9325	TNMG 270624E-RM: T9325	6754178
TNMG 546-RM: T9335	TNMG 270624E-RM: T9335	6754989
TNMG 548-RM: T9335	TNMG 270632E-RM: T9335	6926956
TNMG 666-RM: T9226	TNMG 330924E-RM: T9226	6931888
TNMG 666-RM: T9335	TNMG 330924E-RM: T9335	6754990
TNMM 332-DR: T9325	TNMM 160408E-DR: T9325	6754164
TNMM 332-NR2: T9325	TNMM 160408E-NR2: T9325	6754165
TNMM 332-OR: T9315	TNMM 160408E-OR: T9315	6754420
TNMM 332-OR: T9325	TNMM 160408E-OR: T9325	6754166
TNMM 333-OR: T9325	TNMM 160412E-OR: T9325	6754167
TNMM 432-DR: T9325	TNMM 220408E-DR: T9325	6754168
TNMM 432-DR: T9335	TNMM 220408E-DR: T9335	6754991
TNMM 432-NR2: T7325	TNMM 220408E-NR2: T7325	7156410
TNMM 432-NR2: T9325	TNMM 220408E-NR2: T9325	6754169
TNMM 432-OR: T9315	TNMM 220408E-OR: T9315	6754422
TNMM 432-OR: T9325	TNMM 220408E-OR: T9325	6754170
TNMM 432-OR: T9335	TNMM 220408E-OR: T9335	6754992
TNMM 433-DR: T9315	TNMM 220412E-DR: T9315	6922930
TNMM 433-DR: T9325	TNMM 220412E-DR: T9325	6754171
TNMM 433-DR: T9335	TNMM 220412E-DR: T9335	6754993
TNMM 433L: T9335	TNMM 220412EL: T9335	6754994
TNMM 433-NR2: T7325	TNMM 220412E-NR2: T7325	7156411
TNMM 433-NR2: T8330	TNMM 220412E-NR2: T8330	6755145
TNMM 433-NR2: T9325	TNMM 220412E-NR2: T9325	6754172
TNMM 433-OR: T9325	TNMM 220412E-OR: T9325	6754173
TNMM 433-OR: T9335	TNMM 220412E-OR: T9335	6754995
TNMM 433R: T9335	TNMM 220412ER: T9335	6754996
TNMM 434-DR: T9325	TNMM 220416E-DR: T9325	6754174
TNMM 544-DR: T9325	TNMM 270616E-DR: T9325	6754179
TNMM 544-DR: T9335	TNMM 270616E-DR: T9335	6754997
TNMM 544-HR: T9325	TNMM 270616E-HR: T9325	6754180
TNMM 544-HR: T9335	TNMM 270616E-HR: T9335	6754998
TNMM 546-HR: T9226	TNMM 270624E-HR: T9226	6931891
TPCN 32PDSN: M8330	TPCN 1603PDSN: M8330	7451104
TPCN 32PDSN: M8340	TPCN 1603PDSN: M8340	6803605
TPG 221 T00420: TC100	TPGN 110304 T01020: TC100	6755450
TPG 222 T00420: TC100	TPGN 110308 T01020: TC100	6755423
TPG 321 T00420: TC100	TPGN 160304 T01020: TC100	6755424
TPG 322 T00420: TC100	TPGN 160308 T01020: TC100	6755425
TPG 323 T00420: TC100	TPGN 160312 T01020: TC100	6755426
TPGX 1.81.51FL: JQ: TT010	TPGX 090204FL: JQ: TT010	7080635
TPGX 21.51FL: JQ: TT010	TPGX 110204FL: JQ: TT010	7080636
TPGX 21.51FR: JQ: TT010	TPGX 110204FR: JQ: TT010	7080637
TPGX 32.51FL: JR: TT010	TPGX 167304FL: JR: TT010	7080632
TPGX1.81.50.SF: JZ: TT010	TPGX 090202FL: JZ: TT010	7080633
TPGX1.81.50.SF: JZ: TT010	TPGX 090202FR: JZ: TT010	7080634
TPKN 32PDR: M8330	TPKN 1603PDR: M8330	7451105
TPKN 32PDR: M8340	TPKN 1603PDR: M8340	6803606
TPKN 32PDR: M8330	TPKN 1603PDR: M8330	7451106
TPKN 32PDR: M8340	TPKN 1603PDR: M8340	6803607
TPKN 32PDR: S26	TPKN 1603PDR: S26	6751622
TPKN 43PDR: 8215	TPKN 2204PDR: 8215	6753422
TPKN 43PDR: M8330	TPKN 2204PDR: M8330	7451107
TPKN 43PDR: M8340	TPKN 2204PDR: M8340	6803608
TPKN 43PDR: 8230	TPKN 2204PDR: 8230	6752577

ANSI	ISO	EDP	ANSI	ISO	EDP	ANSI	ISO	EDP
TPMR 321-47:6630	TPMR 160304E-47:6630	6751691	VBMT 331-FM:T7335	VBMT 160404E-FM:T7335	6754831	VCGT 2.520.2-SF2:T6310	VCGT 130301E-SF2:T6310	7168497
TPMR 321-47:6640	TPMR 160304E-47:6640	6751692	VBMT 331-FM:T8315	VBMT 160404E-FM:T8315	6753630	VCGT 2.520.5F-AL:HF7	VCGT 130302F-AL:HF7	6756198
TPMR 321-47:T9325	TPMR 160304E-47:T9325	6753851	VBMT 331-FM:T8330	VBMT 160404E-FM:T8330	6754299	VCGT 2.520.5F-AL:T0315	VCGT 130302F-AL:T0315	6756199
TPMR 321-47:T9335	TPMR 160304E-47:T9335	6755004	VBMT 331-FM:T9315	VBMT 160404E-FM:T9315	6753750	VCGT 2.520.5-FF2:T5315	VCGT 130302E-FF2:T5315	6756089
TPMR 321-PF2:TT010	TPMR 160304-PF2:TT010	7168746	VBMT 331-FM:T9325	VBMT 160404E-FM:T9325	6754430	VCGT 2.520.5-FF2:T7325	VCGT 130302E-FF2:T7325	7156788
TPMR 322-47:6630	TPMR 160308E-47:6630	6751693	VBMT 331-FM:T6310	VBMT 160404E-FM:T6310	7156926	VCGT 2.520.5-FF2:T8330	VCGT 130302E-FF2:T8330	7156789
TPMR 322-47:6640	TPMR 160308E-47:6640	6751694	VBMT 331-FM:T7325	VBMT 160404E-FM:T7325	7156927	VCGT 2.520.5-FF2:T9315	VCGT 130302E-FF2:T9315	7156790
TPMR 322-47:T9325	TPMR 160308E-47:T9325	6753852	VBMT 331-FM:T8330	VBMT 160404E-FM:T8330	7156928	VCGT 2.520.5-FF2:T9325	VCGT 130302E-FF2:T9325	6756090
TPMR 322-47:T9335	TPMR 160308E-47:T9335	6755005	VBMT 331-FM:T9315	VBMT 160404E-FM:T9315	7156929	VCGT 2.520.5-FF2:TT010	VCGT 130302E-FF2:TT010	6756303
TPMR 322-61:T9325	TPMR 160308E-61:T9325	6754406	VBMT 331-FM:T9325	VBMT 160404E-FM:T9325	7156930	VCGT 2.520.5-FF2:H07	VCGT 130302E-FF2:H07	7167515
TPMR 322-61:T9335	TPMR 160308E-61:T9335	6755006	VBMT 331-FM:T9335	VBMT 160404E-FM:T9335	7156931	VCGT 2.520.5-FF2:T6310	VCGT 130302E-FF2:T6310	7763115
TPMR 323-47:T9325	TPMR 160312E-47:T9325	6754407	VBMT 331-FM:T9315	VBMT 160404E-FM:T9315	7156929	VCGT 2.520.5-FF2:T7325	VCGT 130302E-FF2:T7325	7156423
TPMR 323-47:T9335	TPMR 160312E-47:T9335	6755007	VBMT 331-FM:T9325	VBMT 160404E-FM:T9325	7156930	VCGT 2.520.5-FF2:T7335	VCGT 130302E-FF2:T7335	6756092
TPU 221:6640	TPUN 110304:6640	6751554	VBMT 331-FM:T5305	VBMT 160404E-FM:T5305	6755900	VCGT 2.520.5-FF2:T7335	VCGT 130302E-FF2:T7335	7167517
TPU 221:H10	TPUN 110304:H10	6751651	VBMT 331-FM:T5315	VBMT 160404E-FM:T5315	6755712	VCGT 2.520.5-FF2:T9315	VCGT 130302E-FF2:T9315	7167518
TPU 221:M8330	TPUN 110304:M8330	7451111	VBMT 331-FM:T7335	VBMT 160404E-FM:T7335	6754832	VCGT 2.520.5-FF2:T9325	VCGT 130302E-FF2:T9325	6756091
TPU 222:6640	TPUN 110304:6640	6751555	VBMT 331-FM:T8330	VBMT 160404E-FM:T8330	6754401	VCGT 2.520.5-FF2:T9335	VCGT 130302E-FF2:T9335	7167518
TPU 222:M8330	TPUN 110308:M8330	7451112	VBMT 331-FM:T9315	VBMT 160404E-FM:T9315	6753751	VCGT 2.520.5-FF2:TT010	VCGT 130302E-FF2:TT010	6756304
TPU 321:6640	TPUN 160304:6640	6751560	VBMT 331-UR:T5315	VBMT 160404E-UR:T5315	6755711	VCGT 2.520.5-SF2:H07	VCGT 130302E-SF2:H07	7168498
TPU 321:8215	TPUN 160304:8215	6753423	VBMT 331-UR:T7325	VBMT 160404E-UR:T7325	7156418	VCGT 2.520.5-SF2:HF7	VCGT 130302E-SF2:HF7	6756088
TPU 321:H10	TPUN 160304:H10	6751783	VBMT 331-UR:T8330	VBMT 160404E-UR:T8330	6754223	VCGT 2.520.5-SF2:T6310	VCGT 130302E-SF2:T6310	7168499
TPU 321:M8330	TPUN 160304:M8330	7451113	VBMT 331-UR:T9310	VBMT 160404E-UR:T9310	6755078	VCGT 2.520.5-SF3:H07	VCGT 130302E-SF3:H07	7168599
TPU 321:S26	TPUN 160304:S26	6751784	VBMT 331-UR:T9315	VBMT 160404E-UR:T9315	6753752	VCGT 2.520.5-SF3:T6310	VCGT 130302E-SF3:T6310	7168600
TPU 322:6640	TPUN 160308:6640	6751583	VBMT 331-UR:T9325	VBMT 160404E-UR:T9325	6753854	VCGT 2.520.5-SF3:T8315	VCGT 130302E-SF3:T8315	7168601
TPU 322:8215	TPUN 160308:8215	6753424	VBMT 331-UR:TT310	VBMT 160404E-UR:TT310	6756265	VCGT 2.521F-AL:HF7	VCGT 130304F-AL:HF7	6756201
TPU 322:H10	TPUN 160308:H10	6751785	VBMT 332-FM:T5315	VBMT 160408E-FM:T5315	6755712	VCGT 2.521F-AL:T0315	VCGT 130304F-AL:T0315	6756202
TPU 322:M8330	TPUN 160308:M8330	7451114	VBMT 332-FM:T7325	VBMT 160408E-FM:T7325	6756419	VCGT 2.521-FF2:T5315	VCGT 130304E-FF2:T5315	6756094
TPU 322:S26	TPUN 160308:S26	6751786	VBMT 332-FM:T7335	VBMT 160408E-FM:T7335	6754833	VCGT 2.521-FF2:T7325	VCGT 130304E-FF2:T7325	7156791
TPU 323:6640	TPUN 160312:6640	6751567	VBMT 332-FM:T8315	VBMT 160408E-FM:T8315	6753631	VCGT 2.521-FF2:T7335	VCGT 130304E-FF2:T7335	7156792
TPU 323:H10	TPUN 160312:H10	6751652	VBMT 332-FM:T8330	VBMT 160408E-FM:T8330	6754300	VCGT 2.521-FF2:T8330	VCGT 130304E-FF2:T8330	7156793
TPU 323:M8330	TPUN 160312:M8330	7451115	VBMT 332-FM:T9315	VBMT 160408E-FM:T9315	7763114	VCGT 2.521-FF2:T9315	VCGT 130304E-FF2:T9315	6756096
TPU 432:6640	TPUN 220408:6640	6751571	VBMT 332-FM:T9325	VBMT 160408E-FM:T9325	6753855	VCGT 2.521-FF2:T9325	VCGT 130304E-FF2:T9325	6756096
TPU 432:8215	TPUN 220408:8215	6753425	VBMT 332-FM:T6310	VBMT 160408E-FM:T6310	7156932	VCGT 2.521-FF2:TT010	VCGT 130304E-FF2:TT010	6756305
TPU 432:H10	TPUN 220408:H10	6751653	VBMT 332-FM:T7325	VBMT 160408E-FM:T7325	7156933	VCGT 2.521-NF2:H07	VCGT 130304E-NF2:H07	7167519
TPU 432:M8330	TPUN 220408:M8330	7451116	VBMT 332-FM:T8330	VBMT 160408E-FM:T8330	7156935	VCGT 2.521-NF2:T5315	VCGT 130304E-NF2:T5315	6756097
TPU 432:S26	TPUN 220408:S26	6751788	VBMT 332-FM:T9315	VBMT 160408E-FM:T9315	7156936	VCGT 2.521-NF2:T6310	VCGT 130304E-NF2:T6310	7167520
TPU 433:6640	TPUN 220412:6640	6751572	VBMT 332-FM:T9325	VBMT 160408E-FM:T9325	7156936	VCGT 2.521-NF2:T7325	VCGT 130304E-NF2:T7325	7156424
TPU 433:H10	TPUN 220412:H10	6751789	VBMT 332-FM:T9335	VBMT 160408E-FM:T9335	7156937	VCGT 2.521-NF2:T7335	VCGT 130304E-NF2:T7335	6756099
TPU 433:M8330	TPUN 220412:M8330	7451117	VBMT 332-RM:T5305	VBMT 160408E-RM:T5305	6755901	VCGT 2.521-NF2:T9315	VCGT 130304E-NF2:T9315	7167522
TPU 433:S26	TPUN 220412:S26	6751790	VBMT 332-RM:T5315	VBMT 160408E-RM:T5315	6755713	VCGT 2.521-NF2:T9325	VCGT 130304E-NF2:T9325	6756098
TPU 5445:6640	TPUN 2706165:6640	6751573	VBMT 332-RM:T7335	VBMT 160408E-RM:T7335	6754834	VCGT 2.521-NF2:T9335	VCGT 130304E-NF2:T9335	7167523
TPU 6455:6640	TPUN 3306205:6640	6751574	VBMT 332-RM:T8330	VBMT 160408E-RM:T8330	6754402	VCGT 2.521-NF2:TT010	VCGT 130304E-NF2:TT010	6756306
VBGW 331500420:T8310	VBGW 160404501020B:T8310	6755929	VBMT 332-RM:T9315	VBMT 160408E-RM:T9315	6753754	VCGT 2.521-SF2:H07	VCGT 130304E-SF2:H07	7168500
VBGW 332500420:T8310	VBGW 160408501020B:T8310	6755930	VBMT 332-RM:T9325	VBMT 160408E-RM:T9325	6753856	VCGT 2.521-SF2:HF7	VCGT 130304E-SF2:HF7	6756093
VBMT 21.50.5-UR:TT310	VBMT 110202E-UR:TT310	6756277	VBMT 332-RM:T9315	VBMT 160408E-RM:T9315	6755714	VCGT 2.521-SF2:T6310	VCGT 130304E-SF2:T6310	7168501
VBMT 21.51-UR:T7325	VBMT 110204E-UR:T7325	7156412	VBMT 332-UR:T5315	VBMT 160408E-UR:T5315	6755714	VCGT 2.521-SF3:H07	VCGT 130304E-SF3:H07	7168602
VBMT 21.51-UR:T7335	VBMT 110204E-UR:T7335	6754221	VBMT 332-UR:T7325	VBMT 160408E-UR:T7325	7156420	VCGT 2.521-SF3:T6310	VCGT 130304E-SF3:T6310	7168603
VBMT 21.51-UR:T9315	VBMT 110204E-UR:T9315	6754473	VBMT 332-UR:T7335	VBMT 160408E-UR:T7335	6754224	VCGT 2.521-SF3:T8315	VCGT 130304E-SF3:T8315	7168604
VBMT 21.51-UR:T9325	VBMT 110204E-UR:T9325	6754425	VBMT 332-UR:T8330	VBMT 160408E-UR:T8330	6754224	VCGT 2.522F-AL:HF7	VCGT 130308F-AL:HF7	6756204
VBMT 21.51-UR:TT310	VBMT 110204E-UR:TT310	6756264	VBMT 332-UR:T9315	VBMT 160408E-UR:T9315	6755076	VCGT 2.522F-AL:T0315	VCGT 130308F-AL:T0315	6756205
VBMT 220.5-FM:T7325	VBMT 110302E-FM:T7325	7156413	VBMT 332-UR:T9325	VBMT 160408E-UR:T9325	6754476	VCGT 2.522-FF2:T7325	VCGT 130308E-FF2:T7325	7156793
VBMT 220.5-FM:T8315	VBMT 110302E-FM:T8315	6753628	VBMT 332-UR:T9335	VBMT 160408E-UR:T9335	6753857	VCGT 2.522-FF2:T7335	VCGT 130308E-FF2:T7335	7156794
VBMT 220.5-FM:T8330	VBMT 110302E-FM:T8330	6753652	VBMT 332-UR:TT310	VBMT 160408E-UR:TT310	6756278	VCGT 2.522-FF2:T9315	VCGT 130308E-FF2:T9315	7156794
VBMT 220.5-FM:T9325	VBMT 110302E-FM:T9325	6754426	VBMT 333-FM:T7325	VBMT 160412E-FM:T7325	7156421	VCGT 2.522-FF2:T9325	VCGT 130308E-FF2:T9325	6756102
VBMT 221-FM:T7325	VBMT 110304E-FM:T7325	7156414	VBMT 333-FM:T8330	VBMT 160412E-FM:T8330	6754301	VCGT 2.522-FF2:TT010	VCGT 130308E-FF2:TT010	6756307
VBMT 221-FM:T7335	VBMT 110304E-FM:T7335	6754830	VBMT 333-FM:T9315	VBMT 160412E-FM:T9315	6754477	VCGT 2.522-FM2:T8330	VCGT 130308E-FM2:T8330	7156941
VBMT 221-FM:T8315	VBMT 110304E-FM:T8315	6753629	VBMT 333-FM:T9325	VBMT 160412E-FM:T9325	6754431	VCGT 2.522-FM2:T9325	VCGT 130308E-FM2:T9325	6756103
VBMT 221-FM:T8330	VBMT 110304E-FM:T8330	6753653	VBMT 333-FM2:T8330	VBMT 160412E-FM2:T8330	7156938	VCGT 2.522-NF2:T5315	VCGT 130308E-NF2:T5315	6756104
VBMT 221-FM:T9315	VBMT 110304E-FM:T9315	6754474	VBMT 333-FM2:T9315	VBMT 160412E-FM2:T9315	7156939	VCGT 2.522-NF2:T6310	VCGT 130308E-NF2:T6310	7763116
VBMT 221-FM:T9325	VBMT 110304E-FM:T9325	6754427	VBMT 333-FM2:T9325	VBMT 160412E-FM2:T9325	7156940	VCGT 2.522-NF2:T7325	VCGT 130308E-NF2:T7325	7156425
VBMT 222-FM:T7325	VBMT 110308E-FM:T7325	7156415	VBMT 333-RM:T7335	VBMT 160412E-RM:T7335	6754835	VCGT 2.522-NF2:T7335	VCGT 130308E-NF2:T7335	6756106
VBMT 222-FM:T8330	VBMT 110308E-FM:T8330	6753654	VBMT 333-RM:T8330	VBMT 160412E-RM:T8330	6754403	VCGT 2.522-NF2:T9315	VCGT 130308E-NF2:T9315	7167525
VBMT 222-FM:T9315	VBMT 110308E-FM:T9315	6754475	VBMT 333-RM:T9315	VBMT 160412E-RM:T9315	6754403	VCGT 2.522-NF2:T9325	VCGT 130308E-NF2:T9325	6756105
VBMT 222-FM:T9325	VBMT 110308E-FM:T9325	6754428	VBMT 333-RM:T9325	VBMT 160412E-RM:T9325	6754478	VCGT 2.522-NF2:T9335	VCGT 130308E-NF2:T9335	7167526
VBMT 330.5-FM:T7325	VBMT 160402E-FM:T7325	7156416	VBMT 333-UR:T7325	VBMT 160412E-UR:T7325	7156422	VCGT 2.522-NF2:TT010	VCGT 130308E-NF2:TT010	6756308
VBMT 330.5-FM:T8330	VBMT 160402E-FM:T8330	6753655	VBMT 333-UR:T7335	VBMT 160412E-UR:T7335	6754225	VCGT 2.522-SF2:H07	VCGT 130308E-SF2:H07	7168502
VBMT 330.5-FM:T9315	VBMT 160402E-FM:T9315	6922931	VBMT 333-UR:T9310	VBMT 160412E-UR:T9310	6755077	VCGT 2.522-SF2:HF7	VCGT 130308E-SF2:HF7	6756100
VBMT 330.5-FM:T9325	VBMT 160402E-FM:T9325	6754429	VBMT 333-UR:T9325	VBMT 160412E-UR:T9325	6755077	VCGT 2.522-SF2:T6310	VCGT 130308E-SF2:T6310	7168503
VBMT 330.5-FM:T8330	VBMT 160402E-FM:T8330	6754222	VCGT 1.21.50.5F-AL:HF7	VCGT 070202F-AL:HF7	6756194	VCGT 2.522-SF3:H07	VCGT 130308E-SF3:H07	7168605
VBMT 331-FF2:T7325	VBMT 160404E-FF2:T7325	7156779	VCGT 1.21.50.5-FF2:T8315	VCGT 070202E-FF2:T8315	7156784	VCGT 2.522-SF3:T6310	VCGT 130308E-SF3:T6310	7168606
VBMT 331-FF2:T8330	VBMT 160404E-FF2:T8330	7156780	VCGT 1.21.50.5-FF2:T8330	VCGT 070202E-FF2:T8330	7156785	VCGT 2.522-SF3:T8315	VCGT 130308E-SF3:T8315	7168607
VBMT 331-FF2:T9315	VBMT 160404E-FF2:T9315	7156781	VCGT 1.21.50.5-SF3:H07	VCGT 070202E-SF3:H07	7168590	VCGT 21.50.2-SF3:T6310	VCGT 110201E-SF3:T6310	7600318
VBMT 331-FF2:T9325	VBMT 160404E-FF2:T9325	7156782	VCGT 1.21.50.5-SF3:T6310	VCGT 070202E-SF3:T6310	7168591	VCGT 21.50.2-SF3:T8315	VCGT 110202E-SF3:T8315	7168593
VBMT 331-FF2:T9335	VBMT 160404E-FF2:T9335	7156783	VCGT 1.21.51-FF2:T8315	VCGT 070204E-FF2:T8315	6756786	VCGT 21.50.5-SF3:T6310	VCGT 110202E-SF3:T6310	7168594
VBMT 331-FM:T								

ANSI	ISO	EDP
VCGT 220.5F-AL:HF7	VCGT 110302F-AL:HF7	6752080
VCGT 220.5F-AL:T0315	VCGT 110302F-AL:T0315	6756160
VCGT 220.5F-SF3:T6310	VCGT 110302F-SF3:T6310	7600320
VCGT 220515F-FA:HF7	VCGT 220515F-FA:HF7	6751854
VCGT 220520F-FA:HF7	VCGT 220520F-FA:HF7	6751855
VCGT 220530F-FA:HF7	VCGT 220530F-FA:HF7	6751856
VCGT 221F-AL:HF7	VCGT 110304F-AL:HF7	6751806
VCGT 221F-AL:T0315	VCGT 110304F-AL:T0315	6756161
VCGT 221-SF3:T6310	VCGT 110304F-SF3:T6310	7600321
VCGT 330.5F-AL:HF7	VCGT 160402F-AL:HF7	6752053
VCGT 330.5F-AL:T0315	VCGT 160402F-AL:T0315	6756171
VCGT 330.5F-SF3:T6310	VCGT 160402F-SF3:T6310	7600322
VCGT 331F-AL:HF7	VCGT 160404F-AL:HF7	6751808
VCGT 331F-AL:T0315	VCGT 160404F-AL:T0315	6756175
VCGT 331-SF3:H07	VCGT 160404F-SF3:H07	7168608
VCGT 331-SF3:T6310	VCGT 160404F-SF3:T6310	7168609
VCGT 331-SF3:T8315	VCGT 160404F-SF3:T8315	7168610
VCGT 332F-AL:HF7	VCGT 160408F-AL:HF7	6751810
VCGT 332F-AL:T0315	VCGT 160408F-AL:T0315	6756176
VCGT 332-SF3:H07	VCGT 160408F-SF3:H07	7168611
VCGT 332-SF3:T6310	VCGT 160408F-SF3:T6310	7168612
VCGT 332-SF3:T8315	VCGT 160408F-SF3:T8315	7168613
VCGT 333F-AL:HF7	VCGT 160412F-AL:HF7	6751812
VCGT 333F-AL:T0315	VCGT 160412F-AL:T0315	6756178
VCGT 333-SF3:H07	VCGT 160412F-SF3:H07	7168614
VCGT 333-SF3:T6310	VCGT 160412F-SF3:T6310	7168615
VCGW 2.520.5:T5305	VCGW 130302:T5305	6756218
VCGW 2.521:T5305	VCGW 130304:T5305	6756219
VCGW 2.522:T5305	VCGW 130308:T5305	6756220
VCGX 2.520.2FL-FF2:T6310	VCGX 130301FL-FF2:T6310	7156797
VCGX 2.520.2FL-FF2:T8315	VCGX 130301FL-FF2:T8315	6756216
VCGX 2.520.2FR-FF2:T6310	VCGX 130301FR-FF2:T6310	7156798
VCGX 2.520.2FR-FF2:T8315	VCGX 130301FR-FF2:T8315	6756217
VCGX 2.520.2FR-FF2:T010	VCGX 130301FR-FF2:T010	6756311
VCGX 2.520FL-FF2:T6310	VCGX 130300FL-FF2:T6310	7156795
VCGX 2.520FL-FF2:T8315	VCGX 130300FL-FF2:T8315	6756214
VCGX 2.520FL-FF2:T010	VCGX 130300FL-FF2:T010	6756309
VCGX 2.520FR-FF2:T6310	VCGX 130300FR-FF2:T6310	7156796
VCGX 2.520FR-FF2:T8315	VCGX 130300FR-FF2:T8315	6756215
VCGX 2.520FR-FF2:T010	VCGX 130300FR-FF2:T010	6756310
VCMT 221-UR:T7325	VCMT 110304E-UR:T7325	7156426
VCMT 221-UR:T8330	VCMT 110304E-UR:T8330	6755622
VCMT 221-UR:T9315	VCMT 110304E-UR:T9315	6922932
VCMT 221-UR:T9325	VCMT 110304E-UR:T9325	6755623
VCMT 222-UR:T7325	VCMT 110308E-UR:T7325	7156427
VCMT 222-UR:T8330	VCMT 110308E-UR:T8330	6755624
VCMT 222-UR:T9315	VCMT 110308E-UR:T9315	6922933
VCMT 222-UR:T9325	VCMT 110308E-UR:T9325	6755625
VCMT 331-FM:T7325	VCMT 160404E-FM:T7325	7156428
VCMT 331-FM:T8330	VCMT 160404E-FM:T8330	6755662
VCMT 331-FM:T9315	VCMT 160404E-FM:T9315	6922934
VCMT 331-FM:T9325	VCMT 160404E-FM:T9325	6755663
VCMT 331-UR:T7325	VCMT 160404E-UR:T7325	7156429
VCMT 331-UR:T8330	VCMT 160404E-UR:T8330	6755618
VCMT 331-UR:T9315	VCMT 160404E-UR:T9315	6922935
VCMT 331-UR:T9325	VCMT 160404E-UR:T9325	6755619
VCMT 332-FM:T7325	VCMT 160408E-FM:T7325	7156430
VCMT 332-FM:T8330	VCMT 160408E-FM:T8330	6755664
VCMT 332-FM:T9315	VCMT 160408E-FM:T9315	6922936
VCMT 332-FM:T9325	VCMT 160408E-FM:T9325	6755665
VCMT 332-UR:T7325	VCMT 160408E-UR:T7325	7156431
VCMT 332-UR:T8330	VCMT 160408E-UR:T8330	6755620
VCMT 332-UR:T9315	VCMT 160408E-UR:T9315	6922937
VCMT 332-UR:T9325	VCMT 160408E-UR:T9325	6755621
VCMW 220.5:T5305	VCMW 110302:T5305	6755902
VCMW 220.5:T5315	VCMW 110302:T5315	6922825
VCMW 220.5:T6310	VCMW 110302:T6310	7168653
VCMW 221:T5305	VCMW 110304:T5305	6755903
VCMW 221:T5315	VCMW 110304:T5315	6922826
VCMW 221:T6310	VCMW 110304:T6310	7168654
VCMW 331:T5305	VCMW 160404:T5305	6755904
VCMW 331:T5315	VCMW 160404:T5315	6922827
VCMW 331:T6310	VCMW 160404:T6310	7168655
VCMW 331FN:PD1	VCMW 160404FN:PD1	6751824
VCMW 332:T5305	VCMW 160408:T5305	6755905
VCMW 332:T5315	VCMW 160408:T5315	6922828

ANSI	ISO	EDP
VCMW 332:T6310	VCMW 160408:T6310	7168656
VCMW 332FN:PD1	VCMW 160408FN:PD1	6751865
VNGA 331 T00420:TC100	VNGA 160404 T01020:TC100	6755451
VNGA 331500420:TB310	VNGA 160404501020B:TB310	6755931
VNGA 332 T00420:TC100	VNGA 160408 T01020:TC100	6755452
VNGA 332500420:TB310	VNGA 160408501020B:TB310	6755689
VNMG 331-FF:T7325	VNMG 160404E-FF:T7325	7156507
VNMG 331-FF:T8315	VNMG 160404E-FF:T8315	6753632
VNMG 331-FF:T8330	VNMG 160404E-FF:T8330	6922783
VNMG 331-FM:T7325	VNMG 160404E-FM:T7325	7156432
VNMG 331-FM:T8330	VNMG 160404E-FM:T8330	6754212
VNMG 331-FM:T9310	VNMG 160404E-FM:T9310	6755063
VNMG 331-FM:T9315	VNMG 160404E-FM:T9315	6754480
VNMG 331-FM:T9325	VNMG 160404E-FM:T9325	6754434
VNMG 331-M:T5315	VNMG 160404E-M:T5315	6755724
VNMG 331-M:T9315	VNMG 160404E-M:T9315	6754481
VNMG 331-M:T9325	VNMG 160404E-M:T9325	6754435
VNMG 331-M:T9335	VNMG 160404E-M:T9335	6755008
VNMG 331-NF:T6310	VNMG 160404E-NF:T6310	6922852
VNMG 331-NF:T7325	VNMG 160404E-NF:T7325	7156433
VNMG 331-NF:T7335	VNMG 160404E-NF:T7335	6834716
VNMG 331-NF:T8315	VNMG 160404E-NF:T8315	6834717
VNMG 331-NF:T8330	VNMG 160404E-NF:T8330	6834718
VNMG 331-NF:T9315	VNMG 160404E-NF:T9315	6834719
VNMG 331-NF:T9325	VNMG 160404E-NF:T9325	6834720
VNMG 331-NF:T9325	VNMG 160404E-NM:T9325	7156434
VNMG 331-NM:T7335	VNMG 160404E-NM:T7335	6754836
VNMG 331-NM:T8315	VNMG 160404E-NM:T8315	6922678
VNMG 331-NM:T8330	VNMG 160404E-NM:T8330	6755119
VNMG 331-NM:T9325	VNMG 160404E-NM:T9325	6754436
VNMG 331-NMR:T7325	VNMG 160404E-NMR:T7325	7156435
VNMG 331-NMR:T7335	VNMG 160404E-NMR:T7335	7038118
VNMG 331-NMR:T9325	VNMG 160404E-NMR:T9325	7038117
VNMG 331-SF:T6310	VNMG 160404E-SF:T6310	6919810
VNMG 331-SF:T7325	VNMG 160404E-SF:T7325	7156436
VNMG 331-SF:T8315	VNMG 160404E-SF:T8315	6919811
VNMG 331-SF:T8330	VNMG 160404E-SF:T8330	6919812
VNMG 331-SF:T9315	VNMG 160404E-SF:T9315	7035070
VNMG 331-SF:T9325	VNMG 160404E-SF:T9325	7035071
VNMG 331-SM:T6310	VNMG 160404E-SM:T6310	6915877
VNMG 331-SM:T7325	VNMG 160404E-SM:T7325	7156437
VNMG 331-SM:T7335	VNMG 160404E-SM:T7335	6915878
VNMG 331-SM:T8330	VNMG 160404E-SM:T8330	6915879
VNMG 331-SM:T9315	VNMG 160404E-SM:T9315	6915880
VNMG 331-SM:T9325	VNMG 160404E-SM:T9325	6915881
VNMG 332-FM:T7325	VNMG 160408E-FM:T7325	7156438
VNMG 332-FM:T8330	VNMG 160408E-FM:T8330	6754213
VNMG 332-FM:T9310	VNMG 160408E-FM:T9310	6755064
VNMG 332-FM:T9315	VNMG 160408E-FM:T9315	6754482
VNMG 332-FM:T9325	VNMG 160408E-FM:T9325	6754437
VNMG 332-M:T5305	VNMG 160408E-M:T5305	6755906
VNMG 332-M:T5315	VNMG 160408E-M:T5315	6755725
VNMG 332-M:T9310	VNMG 160408E-M:T9310	6755065
VNMG 332-M:T9315	VNMG 160408E-M:T9315	6753755
VNMG 332-M:T9325	VNMG 160408E-M:T9325	6754438
VNMG 332-M:T9335	VNMG 160408E-M:T9335	6755009
VNMG 332-NF:T6310	VNMG 160408E-NF:T6310	6922853
VNMG 332-NF:T7325	VNMG 160408E-NF:T7325	7156439
VNMG 332-NF:T7335	VNMG 160408E-NF:T7335	6834721
VNMG 332-NF:T8315	VNMG 160408E-NF:T8315	6834722
VNMG 332-NF:T8330	VNMG 160408E-NF:T8330	6834723
VNMG 332-NF:T9315	VNMG 160408E-NF:T9315	6834724
VNMG 332-NF:T9325	VNMG 160408E-NF:T9325	6834725
VNMG 332-NM:T7325	VNMG 160408E-NM:T7325	7156440
VNMG 332-NM:T7335	VNMG 160408E-NM:T7335	6754837
VNMG 332-NM:T8315	VNMG 160408E-NM:T8315	6922679
VNMG 332-NM:T8330	VNMG 160408E-NM:T8330	6755120
VNMG 332-NM:T9325	VNMG 160408E-NM:T9325	6754439
VNMG 332-NMR:T7325	VNMG 160408E-NMR:T7325	7156441
VNMG 332-NMR:T7335	VNMG 160408E-NMR:T7335	7038122
VNMG 332-NMR:T8330	VNMG 160408E-NMR:T8330	7038119
VNMG 332-NMR:T9315	VNMG 160408E-NMR:T9315	7038120
VNMG 332-NMR:T9325	VNMG 160408E-NMR:T9325	7038121
VNMG 332-SF:T6310	VNMG 160408E-SF:T6310	6919813
VNMG 332-SF:T8315	VNMG 160408E-SF:T8315	6919814
VNMG 332-SF:T8330	VNMG 160408E-SF:T8330	6919815

ANSI	ISO	EDP
VNMG 332-SF:T9315	VNMG 160408E-SF:T9315	7035072
VNMG 332-SF:T9325	VNMG 160408E-SF:T9325	7035073
VNMG 332-SM:T6310	VNMG 160408E-SM:T6310	6915882
VNMG 332-SM:T7325	VNMG 160408E-SM:T7325	7156442
VNMG 332-SM:T8330	VNMG 160408E-SM:T8330	6915884
VNMG 332-SM:T9315	VNMG 160408E-SM:T9315	6915885
VNMG 332-SM:T9325	VNMG 160408E-SM:T9325	6915886
VNMG 333-FM:T7325	VNMG 160412E-FM:T7325	7156443
VNMG 333-FM:T8330	VNMG 160412E-FM:T8330	6754214
VNMG 333-FM:T9315	VNMG 160412E-FM:T9315	6754483
VNMG 333-FM:T9325	VNMG 160412E-FM:T9325	6754440
VNMG 333-M:T9325	VNMG 160412E-M:T9325	6754441
VNMG 333-NMR:T7325	VNMG 160412E-NMR:T7325	7156444
VNMG 333-NMR:T8330	VNMG 160412E-NMR:T8330	7038123
VNMG 333-NMR:T9325	VNMG 160412E-NMR:T9325	7038124
VNMG 333-SF:T6310	VNMG 160412E-SF:T6310	6919816
VNMG 333-SF:T9325	VNMG 160412E-SF:T9325	7156515
VNMG 333-SM:T6310	VNMG 160412E-SM:T6310	6915887
WCGT 1.210.5-FF2:HF7	WCGT 020102E-FF2:HF7	6756166
WCGT 1.210.5-FF2:T8330	WCGT 020102E-FF2:T8330	7156799
WCGT 1.210.5-FF2:T010	WCGT 020102E-FF2:T010	6756312
WCGT 1.211-FF2:HF7	WCGT 020104E-FF2:HF7	6756167
WCGT 1.211-FF2:T8330	WCGT 020104E-FF2:T8330	7156800
WCGT 1.211-FF2:T010	WCGT 020104E-FF2:T010	6756313
WCGT 32.50.5F-AL:HF7	WCGT 06T302F-AL:HF7	6751857
WCGT 32.51F-AL:HF7	WCGT 06T304F-AL:HF7	6751858
WCGT 32.51F-AL:T0315	WCGT 06T304F-AL:T0315	6756206
WCGT 32.52F-AL:HF7	WCGT 06T308F-AL:HF7	6751859
WCGT 433F-AL:HF7	WCGT 080412F-AL:HF7	6752407
WCGT 433F-AL:T0315	WCGT 080412F-AL:T0315	6756208
WCGX 1.210.5FL-FJ:T010	WCGX 020102FL-FJ:T010	7080640
WCMT 2.522.47:D8330	WCMT 050308E.47:D8330	6754638
WCMT 2.522.UM:D8330	WCMT 050308E-UM:D8330	6754642
WCMT 32.51-FM:T7325	WCMT 06T304E-FM:T7325	7156446
WCMT 32.51-FM:T7335	WCMT 06T304E-FM:T7335	6754838
WCMT 32.51-FM:T8315	WCMT 06T304E-FM:T8315	6753633
WCMT 32.51-FM:T8330	WCMT 06T304E-FM:T8330	6754302
WCMT 32.51-FM:T9315	WCMT 06T304E-FM:T9315	6754502
WCMT 32.51-FM:T9325	WCMT 06T304E-FM:T9325	6754432
WCMT 32.52.45:D8330	WCMT 06T308E.45:D8330	6754639
WCMT 32.52-FM:T7325	WCMT 06T308E-FM:T7325	7156447
WCMT 32.52-FM:T7335	WCMT 06T308E-FM:T7335	6754839
WCMT 32.52-FM:T8315	WCMT 06T308E-FM:T8315	6753634
WCMT 32.52-FM:T8330	WCMT 06T308E-FM:T8330	6754303
WCMT 32.52-FM:T9315	WCMT 06T308E-FM:T9315	6754503
WCMT 32.52-FM:T9325	WCMT 06T308E-FM:T9325	6754443
WCMT 32.52-RF:T7335	WCMT 06T308E-RF:T7335	6756046
WCMT 32.52-UR:T7325	WCMT 06T308E-UR:T7325	7156448
WCMT 32.52-UR:T9315	WCMT 06T308E-UR:T9315	6754670
WCMT 32.52-UR:T9325	WCMT 06T308E-UR:T9325	6754661
WCMT 431-FM:T7325	WCMT 080404E-FM:T7325	7156449
WCMT 431-FM:T8315	WCMT 080404E-FM:T8315	6753635
WCMT 431-FM:T8330	WCMT 080404E-FM:T8330	6754304
WCMT 431-FM:T9315	WCMT 080404E-FM:T9315	6754504
WCMT 431-FM:T9325	WCMT 080412E-RF:T7335	6754444
WCMT 432-FM:T7325	WCMT 080408E-FM:T7325	7156450
WCMT 432-FM:T7335	WCMT 080408E-FM:T7335	6754841
WCMT 432-FM:T8315	WCMT 080408E-FM:T8315	67536



ANSI	ISO	EDP
WNHX 040310ER-WM:M4310	WNHX 040310ER-WM:M4310	7639272
WNHX 040310ER-WM:M8330	WNHX 040310ER-WM:M8330	7639273
WNHX 040315ER-WM:M4310	WNHX 040315ER-WM:M4310	7639274
WNHX 040315ER-WM:M8330	WNHX 040315ER-WM:M8330	7639275
WNMA 431-T5305	WNMA 080404-T5305	6755907
WNMA 431-T5315	WNMA 080404-T5315	6922804
WNMA 432-T5305	WNMA 080408-T5305	6755908
WNMA 432-T5315	WNMA 080408-T5315	6755928
WNMA 432-T6310	WNMA 080408-T6310	6922862
WNMA 432S-T5305	WNMA 080408S-T5305	6755918
WNMA 433-T5305	WNMA 080412-T5305	6755909
WNMA 433-T5315	WNMA 080412-T5315	6755730
WNMA 433-T6310	WNMA 080412-T6310	6922863
WNMF 201380-PM-S01:6630	WNMF 201380-PM-S01:6630	6752814
WNMF 201380-PM-S01:T9226	WNMF 201380-PM-S01:T9226	6931836
WNMG 32.5I-FM:T7325	WNMG 06T304E-FM:T7325	7156469
WNMG 32.5I-FM:T8330	WNMG 06T304E-FM:T8330	6755156
WNMG 32.5I-FM:T9325	WNMG 06T304E-FM:T9325	6755157
WNMG 32.52-FM:T8330	WNMG 06T308E-FM:T8330	6755158
WNMG 32.52-FM:T9325	WNMG 06T308E-FM:T9325	6755159
WNMG 330.5-FF:T8315	WNMG 060402E-FF:T8315	6753637
WNMG 331-FF:T8315	WNMG 060404E-FF:T8315	6753638
WNMG 331-FM:T7325	WNMG 060404E-FM:T7325	7156452
WNMG 331-FM:T8315	WNMG 060404E-FM:T8315	6753639
WNMG 331-FM:T8330	WNMG 060404E-FM:T8330	6754210
WNMG 331-FM:T9315	WNMG 060404E-FM:T9315	6754507
WNMG 331-FM:T9325	WNMG 060404E-FM:T9325	6754448
WNMG 331-FM:T7310	WNMG 060404E-FM:T7310	6798573
WNMG 331L-SI:T8330	WNMG 060404EL-SI:T8330	6754372
WNMG 331L-SI:T9325	WNMG 060404EL-SI:T9325	6754449
WNMG 331-M-T5315	WNMG 060404E-M-T5315	6755732
WNMG 331-M-T9315	WNMG 060404E-M-T9315	6754508
WNMG 331-M-T9325	WNMG 060404E-M-T9325	6754450
WNMG 331-M-T9335	WNMG 060404E-M-T9335	6755011
WNMG 331-NF:T6310	WNMG 060404E-NF:T6310	6922847
WNMG 331-NF:T7325	WNMG 060404E-NF:T7325	7156454
WNMG 331-NF:T7335	WNMG 060404E-NF:T7335	6834726
WNMG 331-NF:T8315	WNMG 060404E-NF:T8315	6834727
WNMG 331-NF:T8330	WNMG 060404E-NF:T8330	6834728
WNMG 331-NF:T9315	WNMG 060404E-NF:T9315	6834729
WNMG 331-NF:T9325	WNMG 060404E-NF:T9325	6834730
WNMG 331-NM:T7325	WNMG 060404E-NM:T7325	7156455
WNMG 331-NM:T7335	WNMG 060404E-NM:T7335	6754842
WNMG 331-NM:T8315	WNMG 060404E-NM:T8315	6922680
WNMG 331-NM:T8330	WNMG 060404E-NM:T8330	6755116
WNMG 331-NM:T9325	WNMG 060404E-NM:T9325	6754451
WNMG 331-NM:T6310	WNMG 060404E-NM:T6310	7454474
WNMG 331-NMR:T7325	WNMG 060404E-NMR:T7325	7156456
WNMG 331-NMR:T8330	WNMG 060404E-NMR:T8330	7038125
WNMG 331-NMR:T9325	WNMG 060404E-NMR:T9325	7038126
WNMG 331R-SI:T8330	WNMG 060404ER-SI:T8330	6754373
WNMG 331R-SI:T9325	WNMG 060404ER-SI:T9325	6754452
WNMG 331-SF:H07	WNMG 060404E-SF:H07	6921019
WNMG 331-SF:T6310	WNMG 060404E-SF:T6310	6919819
WNMG 331-SF:T7325	WNMG 060404E-SF:T7325	7156458
WNMG 331-SF:T7335	WNMG 060404E-SF:T7335	6919820
WNMG 331-SF:T8315	WNMG 060404E-SF:T8315	6919821
WNMG 331-SF:T8330	WNMG 060404E-SF:T8330	6919822
WNMG 331-SF:T9325	WNMG 060404E-SF:T9325	7035074
WNMG 331-SM:T7325	WNMG 060404E-SM:T7325	7156459
WNMG 331-SM:T7335	WNMG 060404E-SM:T7335	6915889
WNMG 331-SM:T8330	WNMG 060404E-SM:T8330	6915890
WNMG 331-SM:T9315	WNMG 060404E-SM:T9315	6915891
WNMG 331-SM:T9325	WNMG 060404E-SM:T9325	6915892
WNMG 332-FM:T7325	WNMG 060408E-FM:T7325	7156460
WNMG 332-FM:T8330	WNMG 060408E-FM:T8330	6754211
WNMG 332-FM:T9325	WNMG 060408E-FM:T9325	6754509
WNMG 332-M-T5315	WNMG 060408E-M-T5315	6755733
WNMG 332-M-T9310	WNMG 060408E-M-T9310	6755066
WNMG 332-M-T9315	WNMG 060408E-M-T9315	6754510
WNMG 332-M-T9325	WNMG 060408E-M-T9325	6753858
WNMG 332-M-T9335	WNMG 060408E-M-T9335	6755012
WNMG 332-NF:T6310	WNMG 060408E-NF:T6310	6922848
WNMG 332-NF:T7325	WNMG 060408E-NF:T7325	7156461
WNMG 332-NF:T8330	WNMG 060408E-NF:T8330	6834731

ANSI	ISO	EDP
WNMG 332-NF:T9315	WNMG 060408E-NF:T9315	6834732
WNMG 332-NF:T9325	WNMG 060408E-NF:T9325	6834733
WNMG 332-NM:T7325	WNMG 060408E-NM:T7325	7156462
WNMG 332-NM:T7335	WNMG 060408E-NM:T7335	6754843
WNMG 332-NM:T8315	WNMG 060408E-NM:T8315	6922681
WNMG 332-NM:T8330	WNMG 060408E-NM:T8330	6755117
WNMG 332-NM:T9315	WNMG 060408E-NM:T9315	6922938
WNMG 332-NM:T9325	WNMG 060408E-NM:T9325	6754454
WNMG 332-NMR:T6310	WNMG 060408E-NMR:T6310	7454475
WNMG 332-NMR:T7325	WNMG 060408E-NMR:T7325	7156463
WNMG 332-NMR:T7335	WNMG 060408E-NMR:T7335	7038129
WNMG 332-NMR:T9315	WNMG 060408E-NMR:T9315	7038127
WNMG 332-NMR:T9325	WNMG 060408E-NMR:T9325	7038128
WNMG 332-SF:H07	WNMG 060408E-SF:H07	6921020
WNMG 332-SF:T6310	WNMG 060408E-SF:T6310	6919824
WNMG 332-SF:T7335	WNMG 060408E-SF:T7335	6919825
WNMG 332-SF:T8315	WNMG 060408E-SF:T8315	6919826
WNMG 332-SF:T8330	WNMG 060408E-SF:T8330	6919827
WNMG 332-SF:T9315	WNMG 060408E-SF:T9315	7763117
WNMG 332-SF:T9325	WNMG 060408E-SF:T9325	7035075
WNMG 332-SM:T6310	WNMG 060408E-SM:T6310	6915893
WNMG 332-SM:T7325	WNMG 060408E-SM:T7325	7156464
WNMG 332-SM:T7335	WNMG 060408E-SM:T7335	6915894
WNMG 332-SM:T8330	WNMG 060408E-SM:T8330	6915895
WNMG 332-SM:T9325	WNMG 060408E-SM:T9325	6915896
WNMG 332W-F-T9315	WNMG 060408W-F-T9315	6754511
WNMG 332W-F-T9325	WNMG 060408W-F-T9325	6754456
WNMG 332W-M-T9310	WNMG 060408W-M-T9310	6755067
WNMG 332W-M-T9315	WNMG 060408W-M-T9315	6754512
WNMG 332W-M-T9325	WNMG 060408W-M-T9325	6754457
WNMG 332W-MR-T9315	WNMG 060408W-MR-T9315	6850889
WNMG 332W-MR-T9325	WNMG 060408W-MR-T9325	6850890
WNMG 332W-NM-T7325	WNMG 060408W-NM-T7325	7156465
WNMG 332W-NM-T7335	WNMG 060408W-NM-T7335	7034028
WNMG 332W-NM-T9315	WNMG 060408W-NM-T9315	7034029
WNMG 332W-NM-T9325	WNMG 060408W-NM-T9325	7034030
WNMG 333-FM:T9315	WNMG 060412E-FM:T9315	6754513
WNMG 333-NM:T7325	WNMG 060412E-NM:T7325	7156466
WNMG 333-NM:T7335	WNMG 060412E-NM:T7335	6754844
WNMG 333-NM:T9315	WNMG 060412E-NM:T9315	6922939
WNMG 333-NM:T9325	WNMG 060412E-NM:T9325	6754455
WNMG 333-RM:T9310	WNMG 060412E-RM:T9310	7763118
WNMG 333-RM:T9315	WNMG 060412E-RM:T9315	6754514
WNMG 333-RM-T9325	WNMG 060412E-RM-T9325	6754458
WNMG 333-SM-T7325	WNMG 060412E-SM-T7325	7156468
WNMG 333-SM-T8330	WNMG 060412E-SM-T8330	6915898
WNMG 333-SM-T9325	WNMG 060412E-SM-T9325	6915899
WNMG 333W-M-T5315	WNMG 060412W-M-T5315	6755737
WNMG 333W-M-T9315	WNMG 060412W-M-T9315	6754515
WNMG 333W-M-T9325	WNMG 060412W-M-T9325	6754459
WNMG 431-FF:T7325	WNMG 080404E-FF:T7325	7156508
WNMG 431-FF:T8315	WNMG 080404E-FF:T8315	6753640
WNMG 431-FM:T7325	WNMG 080404E-FM:T7325	7156471
WNMG 431-FM:T7335	WNMG 080404E-FM:T7335	6754845
WNMG 431-FM:T8315	WNMG 080404E-FM:T8315	6753643
WNMG 431-FM:T8330	WNMG 080404E-FM:T8330	6754216
WNMG 431-FM-T9310	WNMG 080404E-FM-T9310	6755068
WNMG 431-FM-T9315	WNMG 080404E-FM-T9315	6754516
WNMG 431-FM-T9325	WNMG 080404E-FM-T9325	6754460
WNMG 431L-SI:T7325	WNMG 080404EL-SI:T7325	7156472
WNMG 431L-SI:T7335	WNMG 080404EL-SI:T7335	6922744
WNMG 431L-SI:T8315	WNMG 080404EL-SI:T8315	6922470
WNMG 431L-SI:T8330	WNMG 080404EL-SI:T8330	6754374
WNMG 431L-SI-T9325	WNMG 080404EL-SI-T9325	6754461
WNMG 431-M-T5315	WNMG 080404E-M-T5315	6755752
WNMG 431-M-T9315	WNMG 080404E-M-T9315	6754517
WNMG 431-M-T9325	WNMG 080404E-M-T9325	6754462
WNMG 431-M-T9335	WNMG 080404E-M-T9335	6755014
WNMG 431-NF-HF7	WNMG 080404E-NF-HF7	6834734
WNMG 431-NF-T6310	WNMG 080404E-NF-T6310	6922849
WNMG 431-NF-T7325	WNMG 080404E-NF-T7325	7156473
WNMG 431-NF-T7335	WNMG 080404E-NF-T7335	6834735
WNMG 431-NF-T8315	WNMG 080404E-NF-T8315	6834736
WNMG 431-NF-T8330	WNMG 080404E-NF-T8330	6834737
WNMG 431-NF-T9315	WNMG 080404E-NF-T9315	6834738
WNMG 431-NF-T9325	WNMG 080404E-NF-T9325	6834739

ANSI	ISO	EDP
WNMG 431-NM:T7325	WNMG 080404E-NM:T7325	7156474
WNMG 431-NM:T7335	WNMG 080404E-NM:T7335	6754846
WNMG 431-NM:T8315	WNMG 080404E-NM:T8315	6922682
WNMG 431-NM:T8330	WNMG 080404E-NM:T8330	6755118
WNMG 431-NM-T9315	WNMG 080404E-NM-T9315	6922940
WNMG 431-NM-T9325	WNMG 080404E-NM-T9325	6754463
WNMG 431-NMR:T6310	WNMG 080404E-NMR:T6310	7454476
WNMG 431-NMR:T7325	WNMG 080404E-NMR:T7325	7156475
WNMG 431-NMR:T7335	WNMG 080404E-NMR:T7335	7038133
WNMG 431-NMR:T8330	WNMG 080404E-NMR:T8330	7038130
WNMG 431-NMR-T9315	WNMG 080404E-NMR-T9315	7038131
WNMG 431-NMR-T9325	WNMG 080404E-NMR-T9325	7038132
WNMG 431-NRM:T7325	WNMG 080404-NRM:T7325	7595937
WNMG 431-NRM-T7335	WNMG 080404-NRM:T7335	7595938
WNMG 431-NRM-T9315	WNMG 080404-NRM-T9315	7595939
WNMG 431-SI:T7325	WNMG 080404ER-SI:T7325	7156476
WNMG 431-SI:T7335	WNMG 080404ER-SI:T7335	6922745
WNMG 431-SI-T8315	WNMG 080404ER-SI-T8315	6922741
WNMG 431-SI-T8330	WNMG 080404ER-SI-T8330	6754375
WNMG 431-SF:T9325	WNMG 080404E-SF:T9325	6754464
WNMG 431-SF:H07	WNMG 080404E-SF:H07	6921021
WNMG 431-SF-T6310	WNMG 080404E-SF:T6310	6919829
WNMG 431-SF-T7325	WNMG 080404E-SF:T7325	7156477
WNMG 431-SF-T7335	WNMG 080404E-SF:T7335	6919830
WNMG 431-SF-T8315	WNMG 080404E-SF:T8315	6919831
WNMG 431-SF-T8330	WNMG 080404E-SF:T8330	6919832
WNMG 431-SF-T9315	WNMG 080404E-SF-T9315	7035076
WNMG 431-SF-T9325	WNMG 080404E-SF-T9325	7035077
WNMG 431-SM:T6310	WNMG 080404E-SM:T6310	6915900
WNMG 431-SM-T7325	WNMG 080404E-SM:T7325	7156478
WNMG 431-SM-T7335	WNMG 080404E-SM:T7335	6915901
WNMG 431-SM-T8330	WNMG 080404E-SM:T8330	6915902
WNMG 431-SM-T9315	WNMG 080404E-SM-T9315	6915903
WNMG 431-SM-T9325	WNMG 080404E-SM-T9325	6915904
WNMG 431W-F-T9315	WNMG 080404W-F-T9315	6754518
WNMG 431W-F-T9325	WNMG 080404W-F-T9325	6754465
WNMG 431W-MR-T9315	WNMG 080404W-MR-T9315	6850891
WNMG 431W-MR-T9325	WNMG 080404W-MR-T9325	6850892
WNMG 431W-NM-T7325	WNMG 080404W-NM-T7325	7156479
WNMG 431W-NM-T7335	WNMG 080404W-NM-T7335	7034031
WNMG 431W-NM-T9315	WNMG 080404W-NM-T9315	7034032
WNMG 431W-NM-T9325	WNMG 080404W-NM-T9325	7034033
WNMG 432-FF:T7325	WNMG 080408E-FF:T7325	7156509
WNMG 432-FF-T8315	WNMG 080408E-FF:T8315	6753644
WNMG 432-FM-T7325	WNMG 080408E-FM:T7325	7156480
WNMG 432-FM-T7335	WNMG 080408E-FM:T7335	6754847
WNMG 432-FM-T8315	WNMG 080408E-FM:T8315	6753645
WNMG 432-FM-T8330	WNMG 080408E-FM:T8330	6754217
WNMG 432-FM-T9310	WNMG 080408E-FM-T9310	6755069
WNMG 432-FM-T9315	WNMG 080408E-FM-T9315	6754519
WNMG 432-FM-T9325	WNMG 080408E-FM-T9325	6754466
WNMG 432-KR-T5305	WNMG 080408E-KR-T5305	6922718
WNMG 432-KR-T5315	WNMG 080408E-KR-T5315	6922719
WNMG 432L-SI:T7325	WNMG 080408EL-SI:T7325	7156481
WNMG 432L-SI-T7335	WNMG 080408EL-SI-T7335	6922746
WNMG 432L-SI-T8315	WNMG 080408EL-SI-T8315	6922742
WNMG 432L-SI-T8330	WNMG 080408EL-SI-T8330	6754376
WNMG 432L-SI-T9325	WNMG 080408EL-SI-T9325	6754467
WNMG 432-M-T6630	WNMG 080408E-M-T6630	6751556
WNMG 432-M-T5305	WNMG 080408E-M-T5305	6755910
WNMG 432L-M-T5315	WNMG 080408E-M-T5315	6755753

ANSI	ISO	EDP	ANSI	ISO	EDP	ANSI	ISO	EDP
WNMG 432-NM:T8315	WNMG 080408E-NM:T8315	6922683	WNMG 433-NF:T9315	WNMG 080412E-NF:T9315	6834748	WNMM 643-DR:T9325	WNMM 130612E-DR:T9325	6753863
WNMG 432-NM:T8330	WNMG 080408E-NM:T8330	6754219	WNMG 433-NF:T9325	WNMG 080412E-NF:T9325	6834749	WNMM 643-DR:T9335	WNMM 130612E-DR:T9335	6755024
WNMG 432-NM:T9315	WNMG 080408E-NM:T9315	6922941	WNMG 433-NM:T7325	WNMG 080412E-NM:T7325	7156492	WNMM 643-OR:T9325	WNMM 130612E-OR:T9325	6754500
WNMG 432-NM:T9325	WNMG 080408E-NM:T9325	6754468	WNMG 433-NM:T7335	WNMG 080412E-NM:T7335	6754850	WNMM 644-OR:T9325	WNMM 130616E-OR:T9325	6754501
WNMG 432-NMR:T6310	WNMG 080408E-NMR:T6310	7454477	WNMG 433-NM:T8315	WNMG 080412E-NM:T8315	6922684	WNXJ 150935-PM:6630	WNXJ 150935-PM:6630	6752846
WNMG 432-NMR:T7325	WNMG 080408E-NMR:T7325	7156484	WNMG 433-NM:T9325	WNMG 080412E-NM:T9325	6754489	WNXJ 201380-PR-S01:6630	WNXJ 201380-PR-S01:6630	6752844
WNMG 432-NMR:T7335	WNMG 080408E-NMR:T7335	7038137	WNMG 433-NMR:T6310	WNMG 080412E-NMR:T6310	7454478	X61 0602-080 L:6640	X61 0602-080 L:6640	7721535
WNMG 432-NMR:T8330	WNMG 080408E-NMR:T8330	7038134	WNMG 433-NMR:T7325	WNMG 080412E-NMR:T7325	7156493	X61 0602-080 L:G8330	X61 0602-080 L:G8330	7721536
WNMG 432-NMR:T9315	WNMG 080408E-NMR:T9315	7038135	WNMG 433-NMR:T7335	WNMG 080412E-NMR:T7335	7038141	X61 0602-080 L:6640	X61 0602-080 L:6640	7721537
WNMG 432-NMR:T9325	WNMG 080408E-NMR:T9325	7038136	WNMG 433-NMR:T8330	WNMG 080412E-NMR:T8330	7038138	X61 0602-080 R:6640	X61 0602-080 R:6640	7721538
WNMG 432-NRM:T7325	WNMG 080408E-NRM:T7325	7595940	WNMG 433-NMR:T9315	WNMG 080412E-NMR:T9315	7038139	X61 0602-080 R:G8330	X61 0602-080 R:G8330	7721539
WNMG 432-NRM:T7335	WNMG 080408E-NRM:T7335	7595941	WNMG 433-NMR:T9325	WNMG 080412E-NMR:T9325	7038140	X61 0602-080 R1:6640	X61 0602-080 R1:6640	7721590
WNMG 432-NRM:T9315	WNMG 080408E-NRM:T9315	7595942	WNMG 433-NRM:T7325	WNMG 080412E-NRM:T7325	7595943	X61 0602-090 L:6640	X61 0602-090 L:6640	7721591
WNMG 432-R:6630	WNMG 080408E-R:6630	6751558	WNMG 433-NRM:T7335	WNMG 080412E-NRM:T7335	7595944	X61 0602-090 L:G8330	X61 0602-090 L:G8330	7721592
WNMG 432-R:T5305	WNMG 080408E-R:T5305	6755911	WNMG 433-NRM:T9315	WNMG 080412E-NRM:T9315	7595945	X61 0602-090 L1:6640	X61 0602-090 L1:6640	7721593
WNMG 432-R:T5315	WNMG 080408E-R:T5315	6922767	WNMG 433-R:T5305	WNMG 080412E-R:T5305	6755915	X61 0602-090 R:6640	X61 0602-090 R:6640	7721594
WNMG 432-R:T9310	WNMG 080408E-R:T9310	6922961	WNMG 433-R:T5315	WNMG 080412E-R:T5315	6922768	X61 0602-090 R1:6640	X61 0602-090 R1:6640	7721595
WNMG 432-R:T9315	WNMG 080408E-R:T9315	6754521	WNMG 433-R:T9310	WNMG 080412E-R:T9310	6922962	X61 0602-090 R1:6640	X61 0602-090 R1:6640	7721596
WNMG 432-R:T9325	WNMG 080408E-R:T9325	6753860	WNMG 433-R:T9315	WNMG 080412E-R:T9315	6753758	X61 0602-100 L:6640	X61 0602-100 L:6640	7721597
WNMG 432-R:T9335	WNMG 080408E-R:T9335	6755016	WNMG 433-R:T9325	WNMG 080412E-R:T9325	6754490	X61 0602-100 L:G8330	X61 0602-100 L:G8330	7721598
WNMG 432-RM:T5305	WNMG 080408E-RM:T5305	6755912	WNMG 433-R:T9335	WNMG 080412E-R:T9335	6922769	X61 0602-100 R:6640	X61 0602-100 R:6640	7721599
WNMG 432-RM:T5315	WNMG 080408E-RM:T5315	6755754	WNMG 433-RM:T5305	WNMG 080412E-RM:T5305	6755916	X61 0602-100 R:G8330	X61 0602-100 R:G8330	7721600
WNMG 432-RM:T7325	WNMG 080408E-RM:T7325	7156485	WNMG 433-RM:T5315	WNMG 080412E-RM:T5315	6755696	X61 0602-110 L:6640	X61 0602-110 L:6640	7721601
WNMG 432-RM:T7335	WNMG 080408E-RM:T7335	6922713	WNMG 433-RM:T7325	WNMG 080412E-RM:T7325	7156494	X61 0602-110 L:G8330	X61 0602-110 L:G8330	7721602
WNMG 432-RM:T8315	WNMG 080408E-RM:T8315	6753646	WNMG 433-RM:T7335	WNMG 080412E-RM:T7335	6922714	X61 0602-110 L1:6640	X61 0602-110 L1:6640	7721603
WNMG 432-RM:T8330	WNMG 080408E-RM:T8330	6754182	WNMG 433-RM:T8315	WNMG 080412E-RM:T8315	6753647	X61 0602-110 L1:G8330	X61 0602-110 L1:G8330	7721604
WNMG 432-RM:T9310	WNMG 080408E-RM:T9310	6755071	WNMG 433-RM:T9310	WNMG 080412E-RM:T9310	6755074	X61 0602-110 R:G8330	X61 0602-110 R:G8330	7721605
WNMG 432-RM:T9315	WNMG 080408E-RM:T9315	6753756	WNMG 433-RM:T9315	WNMG 080412E-RM:T9315	6754524	X61 0602-110 R1:6640	X61 0602-110 R1:6640	7721606
WNMG 432-RM:T9325	WNMG 080408E-RM:T9325	6754469	WNMG 433-RM:T9325	WNMG 080412E-RM:T9325	6754491	X61 0602-130 L:6640	X61 0602-130 L:6640	7721607
WNMG 432-RM:T9335	WNMG 080408E-RM:T9335	6755017	WNMG 433-RM:T9335	WNMG 080412E-RM:T9335	6755019	X61 0602-130 L:G8330	X61 0602-130 L:G8330	7721608
WNMG 432R-SI:T7325	WNMG 080408E-SI:T7325	7156486	WNMG 433R-SI:T8330	WNMG 080412ER-SI:T8330	6926946	X61 0602-130 L1:6640	X61 0602-130 L1:6640	7721609
WNMG 432R-SI:T7335	WNMG 080408E-SI:T7335	6922747	WNMG 433R-SI:T9325	WNMG 080412ER-SI:T9325	6926948	X61 0602-130 R:6640	X61 0602-130 R:6640	7721610
WNMG 432R-SI:T8315	WNMG 080408E-SI:T8315	6922743	WNMG 433-SF:T7325	WNMG 080412E-SF:T7325	7156516	X61 0602-130 R:G8330	X61 0602-130 R:G8330	7721611
WNMG 432R-SI:T8330	WNMG 080408E-SI:T8330	6754377	WNMG 433-SM:T6310	WNMG 080412E-SM:T6310	6915910	X61 0602-130 R1:6640	X61 0602-130 R1:6640	7721612
WNMG 432R-SI:T9325	WNMG 080408E-SI:T9325	6754470	WNMG 433-SM:T7325	WNMG 080412E-SM:T7325	7156495	X61 0602-150 L:6640	X61 0602-150 L:6640	7721613
WNMG 432-SF:H07	WNMG 080408E-SF:H07	6921022	WNMG 433-SM:T7335	WNMG 080412E-SM:T7335	6915911	X61 0602-150 L:G8330	X61 0602-150 L:G8330	7721614
WNMG 432-SF:T6310	WNMG 080408E-SF:T6310	6919834	WNMG 433-SM:T8330	WNMG 080412E-SM:T8330	6915912	X61 0602-150 R:6640	X61 0602-150 R:6640	7721615
WNMG 432-SF:T7325	WNMG 080408E-SF:T7325	7156487	WNMG 433-SM:T9315	WNMG 080412E-SM:T9315	6915913	X61 0602-150 R:G8330	X61 0602-150 R:G8330	7721616
WNMG 432-SF:T7335	WNMG 080408E-SF:T7335	6919835	WNMG 433-SM:T9325	WNMG 080412E-SM:T9325	6915914	X61 0602-160 L:6640	X61 0602-160 L:6640	7721617
WNMG 432-SF:T8315	WNMG 080408E-SF:T8315	6919836	WNMG 433W-M:T9325	WNMG 080412W-M:T9325	6754492	X61 0602-160 L:G8330	X61 0602-160 L:G8330	7721618
WNMG 432-SF:T8330	WNMG 080408E-SF:T8330	6919837	WNMG 433W-MR:T5315	WNMG 080412W-MR:T5315	6850896	X61 0602-160 L1:6640	X61 0602-160 L1:6640	7721619
WNMG 432-SF:T9315	WNMG 080408E-SF:T9315	7035078	WNMG 433W-MR:T9310	WNMG 080412W-MR:T9310	7035078	X61 0602-160 R:6640	X61 0602-160 R:6640	7721620
WNMG 432-SF:T9325	WNMG 080408E-SF:T9325	7035079	WNMG 433W-MR:T9315	WNMG 080412W-MR:T9315	6850897	X61 0602-160 R:G8330	X61 0602-160 R:G8330	7721621
WNMG 432-SM:T6310	WNMG 080408E-SM:T6310	6915905	WNMG 433W-NM:T9325	WNMG 080412W-NM:T9325	6850898	X61 0602-160 R1:6640	X61 0602-160 R1:6640	7721622
WNMG 432-SM:T7325	WNMG 080408E-SM:T7325	7156488	WNMG 433W-NM:T7325	WNMG 080412W-NM:T7325	7156496	X61 0602-185 L:6640	X61 0602-185 L:6640	7721623
WNMG 432-SM:T7335	WNMG 080408E-SM:T7335	6915906	WNMG 433W-NM:T7335	WNMG 080412W-NM:T7335	7034037	X61 0602-185 L:G8330	X61 0602-185 L:G8330	7721624
WNMG 432-SM:T8330	WNMG 080408E-SM:T8330	6915907	WNMG 433W-NM:T9315	WNMG 080412W-NM:T9315	7034038	X61 0602-185 L1:6640	X61 0602-185 L1:6640	7721625
WNMG 432-SM:T9315	WNMG 080408E-SM:T9315	6915908	WNMG 433W-NM:T9325	WNMG 080412W-NM:T9325	7034039	X61 0602-185 R:6640	X61 0602-185 R:6640	7721626
WNMG 432-SM:T9325	WNMG 080408E-SM:T9325	6915909	WNMG 434-RM:T5305	WNMG 080416E-RM:T5305	6755917	X61 0602-185 R:G8330	X61 0602-185 R:G8330	7721627
WNMG 432W-M:T9315	WNMG 080408W-M:T9315	6754522	WNMG 434-RM:T5315	WNMG 080416E-RM:T5315	6755758	X61 0602-185 R1:6640	X61 0602-185 R1:6640	7721628
WNMG 432W-M:T9325	WNMG 080408W-M:T9325	6754471	WNMG 434-RM:T7335	WNMG 080416E-RM:T7335	6922715	X61 0602-200 R:G8330	X61 0602-200 R:G8330	7721629
WNMG 432W-MR:T5315	WNMG 080408W-MR:T5315	6850893	WNMG 434-RM:T8330	WNMG 080416E-RM:T8330	6755132	X61 0602-200 R1:6640	X61 0602-200 R1:6640	7721630
WNMG 432W-MR:T9310	WNMG 080408W-MR:T9310	7035046	WNMG 434-RM:T9310	WNMG 080416E-RM:T9310	6755075	X61 0602-215 L:6640	X61 0602-215 L:6640	7721631
WNMG 432W-MR:T9315	WNMG 080408W-MR:T9315	6850894	WNMG 434-RM:T9315	WNMG 080416E-RM:T9315	6754526	X61 0602-215 L:G8330	X61 0602-215 L:G8330	7721632
WNMG 432W-MR:T9325	WNMG 080408W-MR:T9325	6850895	WNMG 434-RM:T9325	WNMG 080416E-RM:T9325	6754493	X61 0602-215 R:6640	X61 0602-215 R:6640	7721633
WNMG 432W-MR:T9335	WNMG 080408W-MR:T9335	7156489	WNMG 434-RM:T9335	WNMG 080416E-RM:T9335	6755020	X61 0602-215 R1:6640	X61 0602-215 R1:6640	7721634
WNMG 432W-NM:T7325	WNMG 080408W-NM:T7325	7156489	WNMJ 201380-PR:T9226	WNMJ 201380-PR:T9226	6931837	X61 0602-215 R:G8330	X61 0602-215 R:G8330	7721635
WNMG 432W-NM:T7335	WNMG 080408W-NM:T7335	7034034	WNMJ 201480-PR:6630	WNMJ 201480-PR:6630	6752795	X61 0602-215 R1:6640	X61 0602-215 R1:6640	7721636
WNMG 432W-NM:T9315	WNMG 080408W-NM:T9315	7034035	WNMJ 201480-PR:T9226	WNMJ 201480-PR:T9226	6931838	X61 0602-250 L:6640	X61 0602-250 L:6640	7721637
WNMG 432W-NM:T9325	WNMG 080408W-NM:T9325	7034036	WNMM 432-NR:T7325	WNMM 080408E-NR:T7325	7156498	X61 0602-250 L:G8330	X61 0602-250 L:G8330	7721638
WNMG 433-FM:T7325	WNMG 080412E-FM:T7325	7156490	WNMM 432-NR:T8330	WNMM 080408E-NR:T8330	6754215	X61 0602-250 R:6640	X61 0602-250 R:6640	7721639
WNMG 433-FM:T7335	WNMG 080412E-FM:T7335	6754849	WNMM 432-NR:T9325	WNMM 080408E-NR:T9325	6754494	X61 0602-265 L:6640	X61 0602-265 L:6640	7721640
WNMG 433-FM:T8330	WNMG 080412E-FM:T8330	6754220	WNMM 432-NR2:T7335	WNMM 080408E-NR2:T7335	6754852	X61 0602-265 L:G8330	X61 0602-265 L:G8330	7721641
WNMG 433-FM:T9310	WNMG 080412E-FM:T9310	6755072	WNMM 432-NR2:T9325	WNMM 080408E-NR2:T9325	6754495	X61 0602-300 L:6640	X61 0602-300 L:6640	7721642
WNMG 433-FM:T9325	WNMG 080412E-FM:T9325	6754472	WNMM 432-OR:T8330	WNMM 080408E-OR:T8330	6755155	X61 0602-300 L:G8330	X61 0602-300 L:G8330	7721643
WNMG 433-KR:T5305	WNMG 080412E-KR:T5305	6755913	WNMM 432-OR:T9325	WNMM 080408E-OR:T9325	6754946	X61 0602-300 R:6640	X61 0602-300 R:6640	7721644
WNMG 433-KR:T5315	WNMG 080412E-KR:T5315	6755755	WNMM 432-OR:T9335	WNMM 080408E-OR:T9335	6755021	X61 0602-300 R1:6640	X61 0602-300 R1:6640	7721645
WNMG 433-M:T5305	WNMG 080412E-M:T5305	6755914	WNMM 433-NR2:T7325	WNMM 080412E-NR2:T7325	7156500	X61 0602-300 R:G8330	X61 0602-300 R:G8330	7721646
WNMG 433-M:T5315	WNMG 080412E-M:T5315	6755756	WNMM 433-NR2:T9325	WNMM 080412E-NR2:T9325	6754497	X61 0602-315 L:6640	X61 0602-315 L:6640	7721647
WNMG 433-M:T9310	WNMG 080412E-M:T9310	6755073	WNMM 433-OR:T9325	WNMM 080412E-OR:T9325	6754949	X61 0602-315 L:G8330	X61 0602-315 L:G8330	7721648
WNMG 433-M:T9315	WNMG 080412E-M:T9315	6753757	WNMM 433-OR:T9335	WNMM 080412E-OR:T9335	6755022	X61 0602-315 R:6640	X61 0602-315 R:6640	7721649
WNMG 433-M:T9325	WNMG 080412E-M:T9325	6754488	WNMM 434-OR:T9325	WNMM 080416E-OR:T9325	6754949	X61 0602-315 R:G8330	X61 0602-315 R:G8330	7721650
WNMG 433-M:T9335	WNMG 080412E-M:T9335	6755018	WNMM 542-DR:6630	WNMM 100608E-DR:6630	6751781	X61 0602-315 R1:6640	X61 0602-315 R1:6640	7721651
WNMG 433-NF:T6310	WNMG 080412E-NF:T6310	6922851	WNMM 542-DR:T					

ANSI	ISO	EDP
X61 0602-R100 L1:6640	X61 0602-R100 L1:6640	7721653
X61 0602-R100 R:6640	X61 0602-R100 R:6640	7721654
X61 0602-R100 R:G8330	X61 0602-R100 R:G8330	7721655
X61 0602-R100 R1:6640	X61 0602-R100 R1:6640	7721656
X61 0602-R150 L:6640	X61 0602-R150 L:6640	7721657
X61 0602-R150 L:G8330	X61 0602-R150 L:G8330	7721658
X61 0602-R150 R:6640	X61 0602-R150 R:6640	7721659
X61 0602-R150 R:G8330	X61 0602-R150 R:G8330	7721660
XDHW 070210EN:M8310	XDHW 070210EN:M8310	6756267
XDHW 070210EN:M8325	XDHW 070210EN:M8325	6756011
XDHW 070210SN:M8310	XDHW 070210SN:M8310	6756268
XDHW 070210SN:M8325	XDHW 070210SN:M8325	6756012
XDHW 10T310SN:M8310	XDHW 10T310SN:M8310	6756269
XDHW 10T310SN:M8325	XDHW 10T310SN:M8325	6756013
XEHT 0604AESR:M8310	XEHT 0604AESR:M8310	6931670
XEHT 0604AESR:M8330	XEHT 0604AESR:M8330	7451118
XEHT 0906AESR:M8310	XEHT 0906AESR:M8310	7056803
XEHT 0906AESR:M8330	XEHT 0906AESR:M8330	7451119
XNGX 0604ANSN:8215	XNGX 0604ANSN:8215	6753708
XNGX 0906ANSN:8215	XNGX 0906ANSN:8215	6753568
XNGX 0906ANSN:M8330	XNGX 0906ANSN:M8330	7451120
XNGX 1308DNSN:M8330	XNGX 1308DNSN:M8330	7606905
XOEN 12T304 RF:D720	XOEN 12T304 RF:D720	6755464
XOEN 12T308 RF:D720	XOEN 12T308 RF:D720	6755467
XOEN 12T308 RH:D720	XOEN 12T308 RH:D720	6755468
XP 16ER-FM:M8310	XP 16ER-FM:M8310	6756232
XP 16ER-FM:M8330	XP 16ER-FM:M8330	7451123
XP 16ER-FM:M8345	XP 16ER-FM:M8345	6756177
XP 20ER-FM:M8310	XP 20ER-FM:M8310	6756233
XP 20ER-FM:M8330	XP 20ER-FM:M8330	7451124
XP 20ER-FM:M8345	XP 20ER-FM:M8345	6756180
XP 25ER-FM:M8310	XP 25ER-FM:M8310	6756234
XP 25ER-FM:M8330	XP 25ER-FM:M8330	7451125
XP 25ER-FM:M8345	XP 25ER-FM:M8345	6756185
XP 32ER-FM:M8310	XP 32ER-FM:M8310	6756235
XP 32ER-FM:M8330	XP 32ER-FM:M8330	7451126
XP 32ER-FM:M8345	XP 32ER-FM:M8345	6756187
XPET 0502AP:D8345	XPET 0502AP:D8345	6754693
XPET 0502AP-SD:D8345	XPET 0502AP-SD:D8345	6920805
XPET 0602AP:D8345	XPET 0602AP:D8345	6754694
XPET 0602AP-SD:D8345	XPET 0602AP-SD:D8345	6920806
XPET 0703AP:D8345	XPET 0703AP:D8345	6754695
XPET 0703AP-SD:D8345	XPET 0703AP-SD:D8345	6920807
XPET 0903AP:D8345	XPET 0903AP:D8345	6754656
XPET 0903AP-SD:D8345	XPET 0903AP-SD:D8345	6920808
XPET 11T3AP:D8345	XPET 11T3AP:D8345	6754657
XPET 11T3AP-SD:D8345	XPET 11T3AP-SD:D8345	6920809
XPET 12T3AP:D8345	XPET 12T3AP:D8345	6754658
XPET 12T3AP-SD:D8345	XPET 12T3AP-SD:D8345	6920810
XPET 1504AP:D8345	XPET 1504AP:D8345	6754659
XPET 1504AP-SD:D8345	XPET 1504AP-SD:D8345	6920811
XPET 1904AP:D8345	XPET 1904AP:D8345	6754660
XPET 1904AP-SD:D8345	XPET 1904AP-SD:D8345	6920812
XPHT 160408F-FA:HF7	XPHT 160408F-FA:HF7	6752075
XPHT 160412E:8215	XPHT 160412E:8215	6753426
XPHT 160412E:M6330	XPHT 160412E:M6330	7451137
XPHT 160412E:M8330	XPHT 160412E:M8330	7451127
XPHT 160412E:M8340	XPHT 160412E:M8340	6835887
XPHT 160412S:8215	XPHT 160412S:8215	6753427
XPHT 160412S:8230	XPHT 160412S:8230	6752552
XPHT 160412S:M8330	XPHT 160412S:M8330	7451128
XPHT 160412S:M8340	XPHT 160412S:M8340	6803614
XPHT 160412S:M9325	XPHT 160412S:M9325	6754583
XPHT 160412S:M9340	XPHT 160412S:M9340	6754608
ZDCW 070304:M8310	ZDCW 070304:M8310	6922554
ZDCW 070304:M8325	ZDCW 070304:M8325	6756014
ZDCW 070304:M8345	ZDCW 070304:M8345	6755968
ZDCW 09T304:M8310	ZDCW 09T304:M8310	6756270
ZDCW 09T304:M8325	ZDCW 09T304:M8325	6756015
ZDCW 09T304:M8345	ZDCW 09T304:M8345	6755969
ZDEW 120408:M4303	ZDEW 120408:M4303	7637370
ZDEW 120408:M8310	ZDEW 120408:M8310	6756271
ZDEW 120408:M8325	ZDEW 120408:M8325	6756016
ZDEW 120408:M8345	ZDEW 120408:M8345	6755970
ZP 10ER-FM:M8310	ZP 10ER-FM:M8310	6756238
ZP 10ER-FM:M8345	ZP 10ER-FM:M8345	6756111

ANSI	ISO	EDP
ZP 12ER-FM:M8310	ZP 12ER-FM:M8310	6756239
ZP 12ER-FM:M8345	ZP 12ER-FM:M8345	6756112
ZP 12ER-M:M8330	ZP 12ER-M:M8330	7451129
ZP 12ER-M:M8340	ZP 12ER-M:M8340	6803615
ZP 12ER-M:M8345	ZP 12ER-M:M8345	6756117
ZP 16ER-FM:M8310	ZP 16ER-FM:M8310	6756240
ZP 16ER-FM:M8345	ZP 16ER-FM:M8345	6756113
ZP 16ER-M:M8330	ZP 16ER-M:M8330	7451130
ZP 16ER-M:M8340	ZP 16ER-M:M8340	6803616
ZP 16ER-M:M8345	ZP 16ER-M:M8345	6756121
ZP 16ER-R:M8330	ZP 16ER-R:M8330	6756124
ZP 16ER-R:M8345	ZP 16ER-R:M8345	6756124
ZP 20ER-F:M8310	ZP 20ER-F:M8310	6756241
ZP 20ER-FM:M8310	ZP 20ER-FM:M8310	6756242
ZP 20ER-FM:M8345	ZP 20ER-FM:M8345	6756114
ZP 20ER-M:M8330	ZP 20ER-M:M8330	7451131
ZP 20ER-M:M8345	ZP 20ER-M:M8345	6756126
ZP 20ER-R:M8345	ZP 20ER-R:M8345	6756127
ZP 25ER-FM:M8310	ZP 25ER-FM:M8310	6756243
ZP 25ER-FM:M8345	ZP 25ER-FM:M8345	6756115
ZP 25ER-M:M8330	ZP 25ER-M:M8330	7451132
ZP 25ER-M:M8345	ZP 25ER-M:M8345	6756129
ZP 25ER-R:M8345	ZP 25ER-R:M8345	6756130
ZP 32ER-FM:M8310	ZP 32ER-FM:M8310	6756244
ZP 32ER-FM:M8345	ZP 32ER-FM:M8345	6756116
ZP 32ER-M:M8330	ZP 32ER-M:M8330	7451133
ZP 32ER-M:M8345	ZP 32ER-M:M8345	6756132
ZP 32ER-R:M8330	ZP 32ER-R:M8330	7451134
ZP 32ER-R:M8345	ZP 32ER-R:M8345	6756134
ZP 40ER-R:M8345	ZP 40ER-R:M8345	6756142
ZP 50ER-F:M8310	ZP 50ER-F:M8310	6756245
ZP 50ER-R:M8345	ZP 50ER-R:M8345	6756143

ANSI	ISO	EDP	ANSI	ISO	EDP	ANSI	ISO	EDP
CKJNL 2020 K 16	CKJNL 2020 K 16	6757125	DCRNL 12 4B	DCRNL 12 4B	6788532	DSDNN 20 6D	DSDNN 20 6D	6788593
CKJNL 2525 M 16	CKJNL 2525 M 16	6756896	DCRNL 16 4D	DCRNL 16 4D	6788533	DSDNN 24 8D	DSDNN 24 8D	6788594
CKJNL 3225 P 16	CKJNL 3225 P 16	6757269	DCRNL 20 4D	DCRNL 20 4D	6788534	DSDNN 2525 M 12	DSDNN 2525 M 12	7028435
CKJNR 2020 K 16	CKJNR 2020 K 16	6756934	DCRNL 20 5D	DCRNL 20 5D	6788535	DSDNN 2525 M 15	DSDNN 2525 M 15	7028436
CKJNR 2525 M 16	CKJNR 2525 M 16	6756895	DCRNL 20 6D	DCRNL 20 6D	6788536	DSDNN 3232 P 19	DSDNN 3232 P 19	7028437
CKJNR 3225 P 16	CKJNR 3225 P 16	6757224	DCRNL 24 6D	DCRNL 24 6D	6788537	DSDNN 4040 S 25	DSDNN 4040 S 25	7028438
CSSPR 2525 M 12	CSSPR 2525 M 12	6756977	DCRNR 12 4B	DCRNR 12 4B	6788538	DSKNL 16 4D	DSKNL 16 4D	6788595
CTAPR 2020 K 16	CTAPR 2020 K 16	6756821	DCRNR 16 4D	DCRNR 16 4D	6788539	DSKNL 20 5D	DSKNL 20 5D	6788596
CTAPR 2525 M 16	CTAPR 2525 M 16	6756679	DCRNR 20 4D	DCRNR 20 4D	6788540	DSKNL 2525 M 12	DSKNL 2525 M 12	7028439
CTCPN 2509 K 11	CTCPN 2509 K 11	6757126	DCRNR 20 5D	DCRNR 20 5D	6788541	DSKNL 3232 P 19	DSKNL 3232 P 19	7028440
CTCPN 2514 M 16	CTCPN 2514 M 16	6756905	DCRNR 20 6D	DCRNR 20 6D	6788542	DSKNR 16 4D	DSKNR 16 4D	6788597
CTFPR 2525 M 16	CTFPR 2525 M 16	6757170	DCRNR 24 6D	DCRNR 24 6D	6788543	DSKNR 20 5D	DSKNR 20 5D	6788598
DCBNL 2020 K 12	DCBNL 2020 K 12	7028367	DDJNL 12 3C	DDJNL 12 3C	6788564	DSKNR 2525 M 12	DSKNR 2525 M 12	7028441
DCBNL 2525 M 12	DCBNL 2525 M 12	7028368	DDJNL 12 4B	DDJNL 12 4B	6788565	DSKNR 3232 P 19	DSKNR 3232 P 19	7028442
DCBNL 2525 M 16	DCBNL 2525 M 16	7028369	DDJNL 16 3D	DDJNL 16 3D	6788566	DSRNL 12 4B	DSRNL 12 4B	6788578
DCBNL 3225 P 12	DCBNL 3225 P 12	7028400	DDJNL 16 4D	DDJNL 16 4D	6788567	DSRNL 16 4D	DSRNL 16 4D	6788579
DCBNL 3225 P 16	DCBNL 3225 P 16	7028401	DDJNL 20 4D	DDJNL 20 4D	6788568	DSRNL 20 5D	DSRNL 20 5D	6788580
DCBNL 3232 P 19	DCBNL 3232 P 19	7028402	DDJNL 2020 K 11	DDJNL 2020 K 11	6758540	DSRNL 20 6D	DSRNL 20 6D	6788581
DCBNL 4040 S 19	DCBNL 4040 S 19	7028403	DDJNL 2020 P 15	DDJNL 2020 P 15	6757935	DSRNL 24 6D	DSRNL 24 6D	6788582
DCBNR 2020 K 12	DCBNR 2020 K 12	7028404	DDJNL 2525 M 11	DDJNL 2525 M 11	6758542	DSRNL 24 8E	DSRNL 24 8E	6788583
DCBNR 2525 M 12	DCBNR 2525 M 12	7028405	DDJNL 2525 M 15	DDJNL 2525 M 15	6757937	DSRNR 12 4B	DSRNR 12 4B	6788584
DCBNR 2525 M 16	DCBNR 2525 M 16	7028406	DDJNL 3225 P 15	DDJNL 3225 P 15	6757939	DSRNR 16 4D	DSRNR 16 4D	6788585
DCBNR 3225 P 12	DCBNR 3225 P 12	7028407	DDJNL 3232 P 15	DDJNL 3232 P 15	7028425	DSRNR 20 5D	DSRNR 20 5D	6788586
DCBNR 3225 P 16	DCBNR 3225 P 16	7028408	DDJNR 12 3C	DDJNR 12 3C	6788569	DSRNR 20 6D	DSRNR 20 6D	6788587
DCBNR 3232 P 19	DCBNR 3232 P 19	7028409	DDJNR 12 4B	DDJNR 12 4B	6788570	DSRNR 24 6D	DSRNR 24 6D	6788588
DCBNR 4040 S 19	DCBNR 4040 S 19	7028410	DDJNR 16 3D	DDJNR 16 3D	6788571	DSRNR 24 8E	DSRNR 24 8E	6788589
DCKNL 16 4D	DCKNL 16 4D	6788544	DDJNR 16 4D	DDJNR 16 4D	6788572	DSSNL 12 4B	DSSNL 12 4B	6788599
DCKNL 2020 K 12	DCKNL 2020 K 12	7028411	DDJNR 20 4D	DDJNR 20 4D	6788573	DSSNL 16 4D	DSSNL 16 4D	6788600
DCKNL 2525 M 12	DCKNL 2525 M 12	7028412	DDJNR 2020 K 11	DDJNR 2020 K 11	6758539	DSSNL 20 5D	DSSNL 20 5D	6788601
DCKNL 3225 P 12	DCKNL 3225 P 12	7028413	DDJNR 2020 K 15	DDJNR 2020 K 15	6757934	DSSNL 20 6D	DSSNL 20 6D	6788602
DCKNL 3232 P 16	DCKNL 3232 P 16	7028414	DDJNR 2525 M 11	DDJNR 2525 M 11	6758541	DSSNL 2020 K 12	DSSNL 2020 K 12	7028443
DCKNR 16 4D	DCKNR 16 4D	6788545	DDJNR 2525 M 15	DDJNR 2525 M 15	6757936	DSSNL 24 6E	DSSNL 24 6E	6788603
DCKNR 2020 K 12	DCKNR 2020 K 12	7028415	DDJNR 3225 P 15	DDJNR 3225 P 15	6757938	DSSNL 2525 M 12	DSSNL 2525 M 12	7028444
DCKNR 2525 M 12	DCKNR 2525 M 12	7028416	DDJNR 3232 P 15	DDJNR 3232 P 15	7028426	DSSNL 2525 M 15	DSSNL 2525 M 15	7028445
DCKNR 3225 P 12	DCKNR 3225 P 12	7028417	DDPNN 12 3B	DDPNN 12 3B	6788574	DSSNL 3225 P 15	DSSNL 3225 P 15	7028446
DCKNR 3232 P 16	DCKNR 3232 P 16	7028418	DDPNN 16 4D	DDPNN 16 4D	6788575	DSSNL 3232 P 19	DSSNL 3232 P 19	7028447
DCLNL 10 3A	DCLNL 10 3A	6788546	DK.FMH1.16	DK.FMH1.16	7386985	DSSNL 4040 S 19	DSSNL 4040 S 19	7028448
DCLNL 12 3C	DCLNL 12 3C	6788547	DK.FMH1.22	DK.FMH1.22	7386986	DSSNR 12 4B	DSSNR 12 4B	6788604
DCLNL 12 4B	DCLNL 12 4B	6788548	DK.FMH1.27	DK.FMH1.27	7386987	DSSNR 16 4D	DSSNR 16 4D	6788605
DCLNL 16 4D	DCLNL 16 4D	6788549	DK.FMH1.32	DK.FMH1.32	7386988	DSSNR 20 5D	DSSNR 20 5D	6788606
DCLNL 1616 H 09	DCLNL 1616 H 09	6757917	DK.FMH1.40	DK.FMH1.40	7386989	DSSNR 20 6D	DSSNR 20 6D	6788607
DCLNL 1616 H 12	DCLNL 1616 H 12	7028419	DK.FMH1.60	DK.FMH1.60	7387020	DSSNR 2020 K 12	DSSNR 2020 K 12	7028449
DCLNL 20 6D	DCLNL 20 6D	6788552	DKHL 4050 V	DKHL 4050 V	6757385	DSSNR 24 6E	DSSNR 24 6E	6788608
DCLNL 2020 K 09	DCLNL 2020 K 09	6757919	DKHL 5060 V	DKHL 5060 V	6757220	DSSNR 2525 M 12	DSSNR 2525 M 12	7028450
DCLNL 2020 K 12	DCLNL 2020 K 12	6757923	DKHL 6080 W-A	DKHL 6080 W-A	6758516	DSSNR 2525 M 15	DSSNR 2525 M 15	7028451
DCLNL 24 6D	DCLNL 24 6D	6788553	DKHR 4050 V	DKHR 4050 V	6757384	DSSNR 3225 P 15	DSSNR 3225 P 15	7028452
DCLNL 24 8E	DCLNL 24 8E	6788554	DKHR 5060 V	DKHR 5060 V	6757219	DSSNR 3232 P 19	DSSNR 3232 P 19	7028453
DCLNL 2525 M 09	DCLNL 2525 M 09	6757921	DKHR 6080 W-A	DKHR 6080 W-A	6758501	DSSNR 4040 S 19	DSSNR 4040 S 19	7028454
DCLNL 2525 M 12	DCLNL 2525 M 12	6757925	DKTL 5055 X A1	DKTL 5055 X A1	6759705	DTFNL 2020 K 16	DTFNL 2020 K 16	7028455
DCLNL 2525 M 16	DCLNL 2525 M 16	7028420	DKTL 5055 X A2	DKTL 5055 X A2	6759659	DTFNL 2525 M 16	DTFNL 2525 M 16	7028456
DCLNL 3225 P 12	DCLNL 3225 P 12	6757927	DKTR 5055 X A1	DKTR 5055 X A1	6759706	DTFNL 2525 M 22	DTFNL 2525 M 22	7028457
DCLNL 3225 P 16	DCLNL 3225 P 16	6757929	DKTR 5055 X A2	DKTR 5055 X A2	6759660	DTFNR 2020 K 16	DTFNR 2020 K 16	7028458
DCLNL 3232 P 19	DCLNL 3232 P 19	6757931	DR.FMH2.16	DR.FMH2.16	7228913	DTFNR 2525 M 16	DTFNR 2525 M 16	7028459
DCLNL 4040 S 19	DCLNL 4040 S 19	7028421	DR.FMH2.22	DR.FMH2.22	7228914	DTFNR 2525 M 22	DTFNR 2525 M 22	7028460
DCLNL 85 4D	DCLNL 85 4D	6788550	DR.FMH2.27	DR.FMH2.27	7228915	DTGNL 12 3B	DTGNL 12 3B	6788609
DCLNL 85 5D	DCLNL 85 5D	6788551	DR.FMH2.32	DR.FMH2.32	7228916	DTGNL 16 3D	DTGNL 16 3D	6788610
DCLNR 10 3A	DCLNR 10 3A	6788555	DR.FMH2.40	DR.FMH2.40	7228917	DTGNL 16 4D	DTGNL 16 4D	6788611
DCLNR 12 3C	DCLNR 12 3C	6788556	DRSNL 16 4D	DRSNL 16 4D	6788576	DTGNL 20 4D	DTGNL 20 4D	6788612
DCLNR 12 4B	DCLNR 12 4B	6788557	DRSNL 2525 M 12	DRSNL 2525 M 12	7028427	DTGNL 2020 K 16	DTGNL 2020 K 16	6757949
DCLNR 16 4D	DCLNR 16 4D	6788558	DRSNR 16 4D	DRSNR 16 4D	6788577	DTGNL 24 5D	DTGNL 24 5D	6788613
DCLNR 1616 H 09	DCLNR 1616 H 09	6757916	DRSNR 2525 M 12	DRSNR 2525 M 12	7028428	DTGNL 2525 M 16	DTGNL 2525 M 16	6757951
DCLNR 1616 H 12	DCLNR 1616 H 12	7028422	DSBNL 2020 K 12	DSBNL 2020 K 12	7028429	DTGNL 2525 M 22	DTGNL 2525 M 22	6757953
DCLNR 20 6D	DCLNR 20 6D	6788561	DSBNL 2525 M 12	DSBNL 2525 M 12	6757941	DTGNL 3232 P 22	DTGNL 3232 P 22	7028461
DCLNR 2020 K 09	DCLNR 2020 K 09	6757918	DSBNL 2525 M 15	DSBNL 2525 M 15	7028430	DTGNR 12 3B	DTGNR 12 3B	6788614
DCLNR 2020 K 12	DCLNR 2020 K 12	6757922	DSBNL 3225 P 15	DSBNL 3225 P 15	6757943	DTGNR 16 3D	DTGNR 16 3D	6788615
DCLNR 24 6D	DCLNR 24 6D	6788562	DSBNL 3232 P 19	DSBNL 3232 P 19	6757945	DTGNR 16 4D	DTGNR 16 4D	6788616
DCLNR 24 8E	DCLNR 24 8E	6788563	DSBNL 4040 S 19	DSBNL 4040 S 19	7028431	DTGNR 20 4D	DTGNR 20 4D	6788617
DCLNR 2525 M 09	DCLNR 2525 M 09	6757920	DSBNR 2020 K 12	DSBNR 2020 K 12	7028432	DTGNR 2020 K 16	DTGNR 2020 K 16	6757948
DCLNR 2525 M 12	DCLNR 2525 M 12	6757924	DSBNR 2525 M 12	DSBNR 2525 M 12	6757940	DTGNR 24 5D	DTGNR 24 5D	6788618
DCLNR 2525 M 16	DCLNR 2525 M 16	7028423	DSBNR 2525 M 15	DSBNR 2525 M 15	7028433	DTGNR 2525 M 16	DTGNR 2525 M 16	6757950
DCLNR 3225 P 12	DCLNR 3225 P 12	6757926	DSBNR 3225 P 15	DSBNR 3225 P 15	6757942	DTGNR 2525 M 22	DTGNR 2525 M 22	6757952
DCLNR 3225 P 16	DCLNR 3225 P 16	6757928	DSBNR 3232 P 19	DSBNR 3232 P 19	6757944	DTGNR 3232 P 22	DTGNR 3232 P 22	7028462
DCLNR 3232 P 19	DCLNR 3232 P 19	6757930	DSBNR 4040 S 19	DSBNR 4040 S 19	7028434	DTJNL 12 3B	DTJNL 12 3B	6788520
DCLNR 4040 S 19	DCLNR 4040 S 19	7028424	DSDNN 12 4B	DSDNN 12 4B	6788590	DTJNL 16 3D	DTJNL 16 3D	6788521
DCLNR 85 4D	DCLNR 85 4D	6788559	DSDNN 16 4D	DSDNN 16 4D	6788591	DTJNL 20 4D	DTJNL 20 4D	6788522
DCLNR 85 5D	DCLNR 85 5D	6788560	DSDNN 20 5D	DSDNN 20 5D	6788592	DTJNR 12 3B	DTJNR 12 3B	6788523



CROSS REFERENCE GUIDE – TOOLHOLDERS

ANSI	ISO	EDP
DTJNR 16 3D	DTJNR 16 3D	6788524
DTJNR 20 4D	DTJNR 20 4D	6788525
DTTNL 12 3B	DTTNL 12 3B	6788619
DTTNL 16 4D	DTTNL 16 4D	6788620
DTTNR 12 3B	DTTNR 12 3B	6788621
DTTNR 16 4D	DTTNR 16 4D	6788622
DVJNL 12 3B	DVJNL 12 3B	6788526
DVJNL 16 3D	DVJNL 16 3D	6788527
DVJNL 20 3D	DVJNL 20 3D	6788528
DVJNL 2020 K 16	DVJNL 2020 K 16	7028463
DVJNL 2525 M 16	DVJNL 2525 M 16	7028464
DVJNL 3225 P 16	DVJNL 3225 P 16	7028465
DVJNR 12 3B	DVJNR 12 3B	6788529
DVJNR 16 3D	DVJNR 16 3D	6788530
DVJNR 20 3D	DVJNR 20 3D	6788531
DVJNR 2020 K 16	DVJNR 2020 K 16	7028466
DVJNR 2525 M 16	DVJNR 2525 M 16	7028467
DVJNR 3225 P 16	DVJNR 3225 P 16	7028468
DVPNL 2525 M 16	DVPNL 2525 M 16	7028469
DVPNL 3225 P 16	DVPNL 3225 P 16	7028470
DVJNR 2525 M 16	DVJNR 2525 M 16	7028471
DVJNR 3225 P 16	DVJNR 3225 P 16	7028472
DWLNL 10 3B	DWLNL 10 3B	6788623
DWLNL 12 3C	DWLNL 12 3C	6788624
DWLNL 12 4C	DWLNL 12 4C	6788625
DWLNL 16 3D	DWLNL 16 3D	6788626
DWLNL 16 4D	DWLNL 16 4D	6788627
DWLNL 1616 H 06	DWLNL 1616 H 06	7028473
DWLNL 20 4D	DWLNL 20 4D	6788628
DWLNL 2020 K 06	DWLNL 2020 K 06	7028474
DWLNL 2020 K 08	DWLNL 2020 K 08	6758090
DWLNL 2525 M 06	DWLNL 2525 M 06	7028475
DWLNL 2525 M 08	DWLNL 2525 M 08	6758092
DWLNL 3225 P 08	DWLNL 3225 P 08	6758094
DWLNL 3225 P 10	DWLNL 3225 P 10	6758517
DWLNL 3232 P 13	DWLNL 3232 P 13	6758518
DWLNL 4040 S 13	DWLNL 4040 S 13	6758519
DWLNR 10 3B	DWLNR 10 3B	6788629
DWLNR 12 3C	DWLNR 12 3C	6788630
DWLNR 12 4C	DWLNR 12 4C	6788631
DWLNR 16 3D	DWLNR 16 3D	6788632
DWLNR 16 4D	DWLNR 16 4D	6788633
DWLNR 1616 H 06	DWLNR 1616 H 06	7028476
DWLNR 20 4D	DWLNR 20 4D	6788634
DWLNR 2020 K 06	DWLNR 2020 K 06	7028477
DWLNR 2020 K 08	DWLNR 2020 K 08	6758079
DWLNR 2525 M 06	DWLNR 2525 M 06	7028478
DWLNR 2525 M 08	DWLNR 2525 M 08	6758091
DWLNR 3225 P 08	DWLNR 3225 P 08	6758093
DWLNR 3225 P 10	DWLNR 3225 P 10	6758520
DWLNR 3232 P 13	DWLNR 3232 P 13	6758521
DWLNR 4040 S 13	DWLNR 4040 S 13	6758522
GFIL 10A 03	GFIL 10A 03	6790496
GFIL 10A 04	GFIL 10A 04	6790497
GFIL 12C 03	GFIL 12C 03	6790498
GFIL 12C 04	GFIL 12C 04	6790499
GFIL 12C 05	GFIL 12C 05	6790500
GFIL 12C 06	GFIL 12C 06	6790501
GFIL 1616 H 03	GFIL 1616 H 03	6757964
GFIL 1616 H 04	GFIL 1616 H 04	6757970
GFIL 16D 03	GFIL 16D 03	6790502
GFIL 16D 0313L 1.18-.670	GFIL 16D 0313L 1.18-.670	6790503
GFIL 16D 0313L 1.54-.940	GFIL 16D 0313L 1.54-.940	6790504
GFIL 16D 0313L 1.97-1.30	GFIL 16D 0313L 1.97-1.30	6790505
GFIL 16D 0313L 2.36-1.69	GFIL 16D 0313L 2.36-1.69	6790506
GFIL 16D 0313L 2.99-2.09	GFIL 16D 0313L 2.99-2.09	6790507
GFIL 16D 0316L 3.94-2.76	GFIL 16D 0316L 3.94-2.76	6790508
GFIL 16D 0316L 5.12-3.54	GFIL 16D 0316L 5.12-3.54	6790509

ANSI	ISO	EDP
GFIL 16D 0316L 6.69-4.33	GFIL 16D 0316L 6.69-4.33	6790510
GFIL 16D 03R 1.18-.670	GFIL 16D 03R 1.18-.670	6790511
GFIL 16D 03R 1.54-.940	GFIL 16D 03R 1.54-.940	6790512
GFIL 16D 03R 1.97-1.30	GFIL 16D 03R 1.97-1.30	6790513
GFIL 16D 03R 2.36-1.69	GFIL 16D 03R 2.36-1.69	6790514
GFIL 16D 03R 2.99-2.09	GFIL 16D 03R 2.99-2.09	6790515
GFIL 16D 03R 3.94-2.76	GFIL 16D 03R 3.94-2.76	6790516
GFIL 16D 03R 5.12-3.54	GFIL 16D 03R 5.12-3.54	6790517
GFIL 16D 03R 6.69-4.33	GFIL 16D 03R 6.69-4.33	6790518
GFIL 16D 04	GFIL 16D 04	6790519
GFIL 16D 04R 1.18-.670	GFIL 16D 04R 1.18-.670	6790520
GFIL 16D 04R 1.34-.826	GFIL 16D 04R 1.34-.826	6790521
GFIL 16D 04R 1.57-1.02	GFIL 16D 04R 1.57-1.02	6790522
GFIL 16D 04R 1.97-1.26	GFIL 16D 04R 1.97-1.26	6790523
GFIL 16D 04R 2.36-1.65	GFIL 16D 04R 2.36-1.65	6790524
GFIL 16D 04R 2.95-2.05	GFIL 16D 04R 2.95-2.05	6790525
GFIL 16D 04R 3.94-2.76	GFIL 16D 04R 3.94-2.76	6790526
GFIL 16D 04R 5.12-3.54	GFIL 16D 04R 5.12-3.54	6790527
GFIL 16D 04R 6.69-4.33	GFIL 16D 04R 6.69-4.33	6790528
GFIL 16D 04R 9.06-5.51	GFIL 16D 04R 9.06-5.51	6790529
GFIL 16D 05	GFIL 16D 05	6790530
GFIL 16D 06	GFIL 16D 06	6790531
GFIL 16D 08	GFIL 16D 08	6790532
GFIL 2020 K 03	GFIL 2020 K 03	6757966
GFIL 2020 K 04	GFIL 2020 K 04	6757972
GFIL 2020 K 05	GFIL 2020 K 05	6757976
GFIL 2020 K 06	GFIL 2020 K 06	6757980
GFIL 2525 M 03	GFIL 2525 M 03	6757968
GFIL 2525 M 0313L 030017	GFIL 2525 M 0313L 030017	6760389
GFIL 2525 M 0313L 039024	GFIL 2525 M 0313L 039024	6760390
GFIL 2525 M 0313L 050033	GFIL 2525 M 0313L 050033	6760391
GFIL 2525 M 0313L 060043	GFIL 2525 M 0313L 060043	6760392
GFIL 2525 M 0313L 076053	GFIL 2525 M 0313L 076053	6760393
GFIL 2525 M 0316L 100070	GFIL 2525 M 0316L 100070	6760394
GFIL 2525 M 0316L 130090	GFIL 2525 M 0316L 130090	6760395
GFIL 2525 M 0316L 170110	GFIL 2525 M 0316L 170110	6760396
GFIL 2525 M 03R 030017-A	GFIL 2525 M 03R 030017-A	6758938
GFIL 2525 M 03R 039024-A	GFIL 2525 M 03R 039024-A	6758937
GFIL 2525 M 03R 050033-A	GFIL 2525 M 03R 050033-A	6758936
GFIL 2525 M 03R 060043-A	GFIL 2525 M 03R 060043-A	6758935
GFIL 2525 M 03R 076053-A	GFIL 2525 M 03R 076053-A	6758966
GFIL 2525 M 03R 100070-A	GFIL 2525 M 03R 100070-A	6758965
GFIL 2525 M 03R 130090-A	GFIL 2525 M 03R 130090-A	6758964
GFIL 2525 M 03R 170110-A	GFIL 2525 M 03R 170110-A	6758963
GFIL 2525 M 04	GFIL 2525 M 04	6757974
GFIL 2525 M 04R 030017-A	GFIL 2525 M 04R 030017-A	6758962
GFIL 2525 M 04R 034021-A	GFIL 2525 M 04R 034021-A	6758961
GFIL 2525 M 04R 040026-A	GFIL 2525 M 04R 040026-A	6758960
GFIL 2525 M 04R 050032-A	GFIL 2525 M 04R 050032-A	6758959
GFIL 2525 M 04R 060042-A	GFIL 2525 M 04R 060042-A	6758958
GFIL 2525 M 04R 075052-A	GFIL 2525 M 04R 075052-A	6758957
GFIL 2525 M 04R 100070-A	GFIL 2525 M 04R 100070-A	6758934

ANSI	ISO	EDP
GFIL 2525 M 04R 130090-A	GFIL 2525 M 04R 130090-A	6758933
GFIL 2525 M 04R 170110-A	GFIL 2525 M 04R 170110-A	6758932
GFIL 2525 M 04R 230140-A	GFIL 2525 M 04R 230140-A	6758931
GFIL 2525 M 05	GFIL 2525 M 05	6757978
GFIL 2525 M 06	GFIL 2525 M 06	6757982
GFIL 2525 M 08	GFIL 2525 M 08	6759691
GFIL 3225 P 08	GFIL 3225 P 08	6759693
GFIL 85E 08	GFIL 85E 08	6790533
GFIR 10A 03	GFIR 10A 03	6790534
GFIR 10A 04	GFIR 10A 04	6790535
GFIR 12C 03	GFIR 12C 03	6790536
GFIR 12C 04	GFIR 12C 04	6790537
GFIR 12C 05	GFIR 12C 05	6790538
GFIR 12C 06	GFIR 12C 06	6790539
GFIR 1616 H 03	GFIR 1616 H 03	6757963
GFIR 1616 H 04	GFIR 1616 H 04	6757969
GFIR 16D 03	GFIR 16D 03	6790540
GFIR 16D 0313R 1.18-.670	GFIR 16D 0313R 1.18-.670	6790541
GFIR 16D 0313R 1.54-.940	GFIR 16D 0313R 1.54-.940	6790542
GFIR 16D 0313R 1.97-1.30	GFIR 16D 0313R 1.97-1.30	6790543
GFIR 16D 0313R 2.36-1.69	GFIR 16D 0313R 2.36-1.69	6790544
GFIR 16D 0313R 2.99-2.09	GFIR 16D 0313R 2.99-2.09	6790545
GFIR 16D 0316R 3.94-2.76	GFIR 16D 0316R 3.94-2.76	6790546
GFIR 16D 0316R 5.12-3.54	GFIR 16D 0316R 5.12-3.54	6790547
GFIR 16D 0316R 6.69-4.33	GFIR 16D 0316R 6.69-4.33	6790548
GFIR 16D 03L 1.18-.670	GFIR 16D 03L 1.18-.670	6790549
GFIR 16D 03L 1.54-.940	GFIR 16D 03L 1.54-.940	6790550
GFIR 16D 03L 1.97-1.30	GFIR 16D 03L 1.97-1.30	6790551
GFIR 16D 03L 2.36-1.69	GFIR 16D 03L 2.36-1.69	6790552
GFIR 16D 03L 2.99-2.09	GFIR 16D 03L 2.99-2.09	6790553
GFIR 16D 03L 3.94-2.76	GFIR 16D 03L 3.94-2.76	6790554
GFIR 16D 03L 5.12-3.54	GFIR 16D 03L 5.12-3.54	6790555
GFIR 16D 03L 6.69-4.33	GFIR 16D 03L 6.69-4.33	6790556
GFIR 16D 04	GFIR 16D 04	6790557
GFIR 16D 04L 1.18-.670	GFIR 16D 04L 1.18-.670	6790558
GFIR 16D 04L 1.34-.826	GFIR 16D 04L 1.34-.826	6790559
GFIR 16D 04L 1.57-1.02	GFIR 16D 04L 1.57-1.02	6790560
GFIR 16D 04L 1.97-1.26	GFIR 16D 04L 1.97-1.26	6790561
GFIR 16D 04L 2.36-1.65	GFIR 16D 04L 2.36-1.65	6790562
GFIR 16D 04L 2.95-2.05	GFIR 16D 04L 2.95-2.05	6790563
GFIR 16D 04L 3.94-2.76	GFIR 16D 04L 3.94-2.76	6790564
GFIR 16D 04L 5.12-3.54	GFIR 16D 04L 5.12-3.54	6790565
GFIR 16D 04L 6.69-4.33	GFIR 16D 04L 6.69-4.33	6790566
GFIR 16D 04L 9.06-5.51	GFIR 16D 04L 9.06-5.51	6790567
GFIR 16D 05	GFIR 16D 05	6790568
GFIR 16D 06	GFIR 16D 06	6790569
GFIR 16D 08	GFIR 16D 08	6790570
GFIR 2020 K 03	GFIR 2020 K 03	6757965
GFIR 2020 K 04	GFIR 2020 K 04	6757971
GFIR 2020 K 05	GFIR 2020 K 05	6757975
GFIR 2020 K 06	GFIR 2020 K 06	6757979
GFIR 2525 M 03	GFIR 2525 M 03	6757967
GFIR 2525 M 0313R 030017	GFIR 2525 M 0313R 030017	6760397
GFIR 2525 M 0313R 039024	GFIR 2525 M 0313R 039024	6760398
GFIR 2525 M 0313R 050033	GFIR 2525 M 0313R 050033	6760399
GFIR 2525 M 0313R 060043	GFIR 2525 M 0313R 060043	6760400
GFIR 2525 M 0313R 076053	GFIR 2525 M 0313R 076053	6760401
GFIR 2525 M 0316R 100070	GFIR 2525 M 0316R 100070	6760402
GFIR 2525 M 0316R 130090	GFIR 2525 M 0316R 130090	6760403

ANSI	ISO	EDP
GFIR 2525 M 0316R 170110	GFIR 2525 M 0316R 170110	6760404
GFIR 2525 M 03L 030017-A	GFIR 2525 M 03L 030017-A	6758956
GFIR 2525 M 03L 039024-A	GFIR 2525 M 03L 039024-A	6758955
GFIR 2525 M 03L 050033-A	GFIR 2525 M 03L 050033-A	6758954
GFIR 2525 M 03L 060043-A	GFIR 2525 M 03L 060043-A	6758953
GFIR 2525 M 03L 076053-A	GFIR 2525 M 03L 076053-A	6758952
GFIR 2525 M 03L 100070-A	GFIR 2525 M 03L 100070-A	6758951
GFIR 2525 M 03L 130090-A	GFIR 2525 M 03L 130090-A	6758950
GFIR 2525 M 03L 170110-A	GFIR 2525 M 03L 170110-A	6758949
GFIR 2525 M 04	GFIR 2525 M 04	6757973
GFIR 2525 M 04L 030017-A	GFIR 2525 M 04L 030017-A	6758948
GFIR 2525 M 04L 034021-A	GFIR 2525 M 04L 034021-A	6758947
GFIR 2525 M 04L 040026-A	GFIR 2525 M 04L 040026-A	6758946
GFIR 2525 M 04L 050032-A	GFIR 2525 M 04L 050032-A	6758945
GFIR 2525 M 04L 060042-A	GFIR 2525 M 04L 060042-A	6758944
GFIR 2525 M 04L 075052-A	GFIR 2525 M 04L 075052-A	6758943
GFIR 2525 M 04L 100070-A	GFIR 2525 M 04L 100070-A	6758942
GFIR 2525 M 04L 130090-A	GFIR 2525 M 04L 130090-A	6758941
GFIR 2525 M 04L 170110-A	GFIR 2525 M 04L 170110-A	6758940
GFIR 2525 M 04L 230140-A	GFIR 2525 M 04L 230140-A	6758939
GFIR 2525 M 05	GFIR 2525 M 05	6757977
GFIR 2525 M 06	GFIR 2525 M 06	6757981
GFIR 2525 M 08	GFIR 2525 M 08	6759687
GFIR 3225 P 08	GFIR 3225 P 08	6759692
GFIR 85E 08	GFIR 85E 08	6790571
GFKL 10A 02	GFKL 10A 02	6790572
GFKL 12C 02	GFKL 12C 02	6790573
GFKL 1616 H 02	GFKL 1616 H 02	6758523
GFKL 16D 02	GFKL 16D 02	6790574
GFKL 2020 K 02	GFKL 2020 K 02	6758524
GFKL 2525 M 02	GFKL 2525 M 02	6758528
GFKR 10A 02	GFKR 10A 02	6790575
GFKR 12C 02	GFKR 12C 02	6790576
GFKR 1616 H 02	GFKR 1616 H 02	6758526
GFKR 16D 02	GFKR 16D 02	6790577
GFKR 2020 K 02	GFKR 2020 K 02	6758527
GFKR 2525 M 02	GFKR 2525 M 02	6758528
GFML 12C 0316	GFML 12C 0316	6790578
GFML 12C 0416	GFML 12C 0416	6790579
GFML 16D 0316	GFML 16D 0316	6790580
GFML 16D 0416	GFML 16D 0416	6790581
GFML 16D 0516	GFML 16D 0516	6790582
GFML 16D 0616	GFML 16D 0616	6790583
GFML 2020 K 0316	GFML 2020 K 0316	6760365
GFML 2020 K 0416	GFML 2020 K 0416	6760366
GFML 2525 M 0316	GFML 2525 M 0316	6760367
GFML 2525 M 0413L 030017	GFML 2525 M 0413L 030017	6760405
GFML 2525 M 0413L 034021	GFML 2525 M 0413L 034021	6760406
GFML 2525 M 0413L 040026	GFML 2525 M 0413L 040026	6760407
GFML 2525 M 0413L 050032	GFML 2525 M 0413L 050032	6760408
GFML 2525 M 0413L 060042	GFML 2525 M 0413L 060042	6760409
GFML 2525 M 0413L 075052	GFML 2525 M 0413L 075052	6760410

ANSI	ISO	EDP
GFML 2525 M 0413R 030017	GFML 2525 M 0413R 030017	6761000
GFML 2525 M 0413R 034021	GFML 2525 M 0413R 034021	6761001
GFML 2525 M 0413R 040026	GFML 2525 M 0413R 040026	6761002
GFML 2525 M 0413R 050032	GFML 2525 M 0413R 050032	6761003
GFML 2525 M 0413R 060042	GFML 2525 M 0413R 060042	6761004
GFML 2525 M 0413R 075052	GFML 2525 M 0413R 075052	6761005
GFML 2525 M 0416	GFML 2525 M 0416	6760368
GFML 2525 M 0416L 100070	GFML 2525 M 0416L 100070	6760411
GFML 2525 M 0416L 130090	GFML 2525 M 0416L 130090	6760412
GFML 2525 M 0416L 170110	GFML 2525 M 0416L 170110	6760413
GFML 2525 M 0416L 230140	GFML 2525 M 0416L 230140	6760414
GFML 2525 M 0416R 100070	GFML 2525 M 0416R 100070	6761006
GFML 2525 M 0416R 130090	GFML 2525 M 0416R 130090	6761007
GFML 2525 M 0416R 170110	GFML 2525 M 0416R 170110	6761008
GFML 2525 M 0416R 230140	GFML 2525 M 0416R 230140	6761009
GFML 2525 M 0516	GFML 2525 M 0516	6760369
GFML 2525 M 0616	GFML 2525 M 0616	6760370
GFML 3225 P 0516	GFML 3225 P 0516	6760371
GFML 3225 P 0616	GFML 3225 P 0616	6760372
GFML 3225 P 0830	GFML 3225 P 0830	6760373
GFML 85E 0516	GFML 85E 0516	6790584
GFML 85E 0616	GFML 85E 0616	6790585
GFML 85E 0830	GFML 85E 0830	6790586
GFMR 12C 0316	GFMR 12C 0316	6790587
GFMR 12C 0416	GFMR 12C 0416	6790588
GFMR 16D 0316	GFMR 16D 0316	6790589
GFMR 16D 0416	GFMR 16D 0416	6790590
GFMR 16D 0516	GFMR 16D 0516	6790591
GFMR 16D 0616	GFMR 16D 0616	6790592
GFMR 2020 K 0316	GFMR 2020 K 0316	6760374
GFMR 2020 K 0416	GFMR 2020 K 0416	6760375
GFMR 2525 M 0316	GFMR 2525 M 0316	6760376
GFMR 2525 M 0413L 030017	GFMR 2525 M 0413L 030017	6760990
GFMR 2525 M 0413L 034021	GFMR 2525 M 0413L 034021	6760991
GFMR 2525 M 0413L 040026	GFMR 2525 M 0413L 040026	6760992
GFMR 2525 M 0413L 050032	GFMR 2525 M 0413L 050032	6760993
GFMR 2525 M 0413L 060042	GFMR 2525 M 0413L 060042	6760994
GFMR 2525 M 0413L 075052	GFMR 2525 M 0413L 075052	6760995
GFMR 2525 M 0413R 030017	GFMR 2525 M 0413R 030017	6760415
GFMR 2525 M 0413R 034021	GFMR 2525 M 0413R 034021	6760416
GFMR 2525 M 0413R 040026	GFMR 2525 M 0413R 040026	6760417
GFMR 2525 M 0413R 050032	GFMR 2525 M 0413R 050032	6760418
GFMR 2525 M 0413R 060042	GFMR 2525 M 0413R 060042	6760419
GFMR 2525 M 0413R 075052	GFMR 2525 M 0413R 075052	6760420
GFMR 2525 M 0416	GFMR 2525 M 0416	6760377
GFMR 2525 M 0416L 100070	GFMR 2525 M 0416L 100070	6760996
GFMR 2525 M 0416L 130090	GFMR 2525 M 0416L 130090	6760997
GFMR 2525 M 0416L 170110	GFMR 2525 M 0416L 170110	6760998

ANSI	ISO	EDP
GFMR 2525 M 0416L 230140	GFMR 2525 M 0416L 230140	6760999
GFMR 2525 M 0416R 100070	GFMR 2525 M 0416R 100070	6760421
GFMR 2525 M 0416R 130090	GFMR 2525 M 0416R 130090	6760422
GFMR 2525 M 0416R 170110	GFMR 2525 M 0416R 170110	6760423
GFMR 2525 M 0416R 230140	GFMR 2525 M 0416R 230140	6760424
GFMR 2525 M 0516	GFMR 2525 M 0516	6760378
GFMR 2525 M 0616	GFMR 2525 M 0616	6760379
GFMR 3225 P 0516	GFMR 3225 P 0516	6760380
GFMR 3225 P 0616	GFMR 3225 P 0616	6760381
GFMR 3225 P 0830	GFMR 3225 P 0830	6760382
GFMR 85E 0516	GFMR 85E 0516	6790593
GFMR 85E 0616	GFMR 85E 0616	6790594
GFMR 85E 0830	GFMR 85E 0830	6790595
GGIL 16D 03L 1.18-.670	GGIL 16D 03L 1.18-.670	6790596
GGIL 16D 03L 1.54-.940	GGIL 16D 03L 1.54-.940	6790597
GGIL 16D 03L 1.97-1.30	GGIL 16D 03L 1.97-1.30	6790598
GGIL 16D 03L 2.36-1.69	GGIL 16D 03L 2.36-1.69	6790599
GGIL 16D 03L 2.99-2.09	GGIL 16D 03L 2.99-2.09	6790600
GGIL 16D 03L 3.94-2.76	GGIL 16D 03L 3.94-2.76	6790601
GGIL 16D 03L 5.12-3.54	GGIL 16D 03L 5.12-3.54	6790602
GGIL 16D 03L 6.69-4.33	GGIL 16D 03L 6.69-4.33	6790603
GGIL 2525 M 03L 030017	GGIL 2525 M 03L 030017	6758108
GGIL 2525 M 03L 039024	GGIL 2525 M 03L 039024	6758109
GGIL 2525 M 03L 050033	GGIL 2525 M 03L 050033	6758110
GGIL 2525 M 03L 060043	GGIL 2525 M 03L 060043	6758111
GGIL 2525 M 03L 076053	GGIL 2525 M 03L 076053	6758112
GGIL 2525 M 03L 100070	GGIL 2525 M 03L 100070	6758227
GGIL 2525 M 03L 130090	GGIL 2525 M 03L 130090	6758228
GGIL 2525 M 03L 170110	GGIL 2525 M 03L 170110	6758229
GGIR 16D 03R 1.18-.670	GGIR 16D 03R 1.18-.670	6790604
GGIR 16D 03R 1.54-.940	GGIR 16D 03R 1.54-.940	6790605
GGIR 16D 03R 1.97-1.30	GGIR 16D 03R 1.97-1.30	6790606
GGIR 16D 03R 2.36-1.69	GGIR 16D 03R 2.36-1.69	6790607
GGIR 16D 03R 2.99-2.09	GGIR 16D 03R 2.99-2.09	6790608
GGIR 16D 03R 3.94-2.76	GGIR 16D 03R 3.94-2.76	6790609
GGIR 16D 03R 5.12-3.54	GGIR 16D 03R 5.12-3.54	6790610
GGIR 16D 03R 6.69-4.33	GGIR 16D 03R 6.69-4.33	6790611
GGIR 2525 M 03R 030017	GGIR 2525 M 03R 030017	6758103
GGIR 2525 M 03R 039024	GGIR 2525 M 03R 039024	6758104
GGIR 2525 M 03R 050033	GGIR 2525 M 03R 050033	6758105
GGIR 2525 M 03R 060043	GGIR 2525 M 03R 060043	6758106
GGIR 2525 M 03R 076053	GGIR 2525 M 03R 076053	6758107
GGIR 2525 M 03R 100070	GGIR 2525 M 03R 100070	6758224
GGIR 2525 M 03R 130090	GGIR 2525 M 03R 130090	6758225
GGIR 2525 M 03R 170110	GGIR 2525 M 03R 170110	6758226
GL2-S10CFL-.63-1.78	GL2-S10CFL-.63-1.78	7804075
GL2-S10CFR-.63-1.78	GL2-S10CFR-.63-1.78	7804076
GL2-S12CFL-.79-3.15	GL2-S12CFL-.79-3.15	7804077
GL2-S12CFR-.79-3.15	GL2-S12CFR-.79-3.15	7804078
GL2-S1616KFL-16-45	GL2-S1616KFL-16-45	7803124
GL2-S1616KFR-16-45	GL2-S1616KFR-16-45	7803125
GL2-S16DFL-.79-3.15	GL2-S16DFL-.79-3.15	7804079
GL2-S16DFR-.79-3.15	GL2-S16DFR-.79-3.15	7804140
GL2-S2020KFL-20-80	GL2-S2020KFL-20-80	7803126
GL2-S2020KFR-20-80	GL2-S2020KFR-20-80	7803127
GL2-S2525MFL-20-80	GL2-S2525MFL-20-80	7803128

CROSS REFERENCE GUIDE – TOOLHOLDERS

ANSI	ISO	EDP
GL2-S2525MFR-20-80	GL2-S2525MFR-20-80	7803129
GL3-S10CFL-63-1.78	GL3-S10CFL-63-1.78	7804141
GL3-S10CFR-63-1.78	GL3-S10CFR-63-1.78	7804142
GL3-S12CFL-79-3.15	GL3-S12CFL-79-3.15	7804143
GL3-S12CFR-79-3.15	GL3-S12CFR-79-3.15	7804144
GL3-S1616KFL-16-45	GL3-S1616KFL-16-45	7803232
GL3-S1616KFR-16-45	GL3-S1616KFR-16-45	7803233
GL3-S16DFL-79-3.15	GL3-S16DFL-79-3.15	7804145
GL3-S16DFR-79-3.15	GL3-S16DFR-79-3.15	7804146
GL3-S16EFL-1.26-3.15	GL3-S16EFL-1.26-3.15	7804147
GL3-S16EFR-1.26-3.15	GL3-S16EFR-1.26-3.15	7804148
GL3-S2020KFL-20-80	GL3-S2020KFL-20-80	7803234
GL3-S2020KFR-20-80	GL3-S2020KFR-20-80	7803235
GL3-S2525MFL-20-80	GL3-S2525MFL-20-80	7803236
GL3-S2525MFR-20-80	GL3-S2525MFR-20-80	7803237
GL3-S2525PFL-32-80	GL3-S2525PFL-32-80	7803238
GL3-S2525PFR-32-80	GL3-S2525PFR-32-80	7803239
GL4-S12CFL-79-3.15	GL4-S12CFL-79-3.15	7804149
GL4-S12CFR-79-3.15	GL4-S12CFR-79-3.15	7804150
GL4-S16DFL-79-3.15	GL4-S16DFL-79-3.15	7804151
GL4-S16DFR-79-3.15	GL4-S16DFR-79-3.15	7804152
GL4-S16EFL-1.26-3.15	GL4-S16EFL-1.26-3.15	7804153
GL4-S16EFR-1.26-3.15	GL4-S16EFR-1.26-3.15	7804154
GL4-S2020KFL-20-80	GL4-S2020KFL-20-80	7803242
GL4-S2020KFR-20-80	GL4-S2020KFR-20-80	7803243
GL4-S2525MFL-20-80	GL4-S2525MFL-20-80	7803244
GL4-S2525MFR-20-80	GL4-S2525MFR-20-80	7803245
GL4-S2525PFL-32-80	GL4-S2525PFL-32-80	7803246
GL4-S2525PFR-32-80	GL4-S2525PFR-32-80	7803247
GL5-S12CFL-79-3.15	GL5-S12CFL-79-3.15	7804155
GL5-S12CFR-79-3.15	GL5-S12CFR-79-3.15	7804156
GL5-S16DFL-79-3.15	GL5-S16DFL-79-3.15	7804157
GL5-S16DFR-79-3.15	GL5-S16DFR-79-3.15	7804158
GL5-S2020KFL-20-80	GL5-S2020KFL-20-80	7803249
GL5-S2020KFR-20-80	GL5-S2020KFR-20-80	7803250
GL5-S2525MFL-20-80	GL5-S2525MFL-20-80	7803251
GL5-S2525MFR-20-80	GL5-S2525MFR-20-80	7803252
GL6-S12CFL-79-3.15	GL6-S12CFL-79-3.15	7804159
GL6-S12CFR-79-3.15	GL6-S12CFR-79-3.15	7804160
GL6-S16DFL-79-3.15	GL6-S16DFL-79-3.15	7804161
GL6-S16DFR-79-3.15	GL6-S16DFR-79-3.15	7804162
GL6-S2020KFL-20-80	GL6-S2020KFL-20-80	7803254
GL6-S2020KFR-20-80	GL6-S2020KFR-20-80	7803255
GL6-S2525MFL-20-80	GL6-S2525MFL-20-80	7803256
GL6-S2525MFR-20-80	GL6-S2525MFR-20-80	7803257
HSK.100A-FMH1.22.050	HSK.100A-FMH1.22.050	7227112
HSK.100A-FMH1.22.100	HSK.100A-FMH1.22.100	7227113
HSK.100A-FMH1.27.050	HSK.100A-FMH1.27.050	7227114
HSK.100A-FMH1.27.100	HSK.100A-FMH1.27.100	7227115
HSK.100A-FMH1.32.060	HSK.100A-FMH1.32.060	7227116
HSK.100A-FMH1.32.100	HSK.100A-FMH1.32.100	7227117
HSK.100A-FMH1.40.070	HSK.100A-FMH1.40.070	7227118
HSK.100A-FMH1.40.100	HSK.100A-FMH1.40.100	7227119
HSK.100A-FMH1.60.070	HSK.100A-FMH1.60.070	7227120
HSK.100A-FMH2.16.060	HSK.100A-FMH2.16.060	7227083
HSK.100A-FMH2.22.060	HSK.100A-FMH2.22.060	7227084
HSK.100A-FMH2.27.060	HSK.100A-FMH2.27.060	7227085
HSK.100A-FMH2.32.060	HSK.100A-FMH2.32.060	7227086
HSK.100A-FMH2.40.070	HSK.100A-FMH2.40.070	7227087
HSK.100A-FMH4.27.120	HSK.100A-FMH4.27.120	7227349
HSK.100A-FMH4.32.155	HSK.100A-FMH4.32.155	7227350
HSK.100A-FMH4.40.190	HSK.100A-FMH4.40.190	7227351
HSK.100A-FMH4.50.235	HSK.100A-FMH4.50.235	7227352
HSK.100A-FMH4.60.255	HSK.100A-FMH4.60.255	7227353
HSK.100A-IHA.M10.050	HSK.100A-IHA.M10.050	7227055
HSK.100A-IHA.M10.100	HSK.100A-IHA.M10.100	7227056
HSK.100A-IHA.M10.150	HSK.100A-IHA.M10.150	7227057
HSK.100A-IHA.M12.050	HSK.100A-IHA.M12.050	7227058
HSK.100A-IHA.M12.100	HSK.100A-IHA.M12.100	7227059
HSK.100A-IHA.M12.150	HSK.100A-IHA.M12.150	7227060
HSK.100A-IHA.M16.050	HSK.100A-IHA.M16.050	7227061
HSK.100A-IHA.M16.100	HSK.100A-IHA.M16.100	7227062
HSK.100A-IHA.M16.150	HSK.100A-IHA.M16.150	7227063
HSK.100A-IHA.M8.050	HSK.100A-IHA.M8.050	7227064
HSK.100A-MT.1.110	HSK.100A-MT.1.110	7227121
HSK.100A-MT.2.120	HSK.100A-MT.2.120	7227122

ANSI	ISO	EDP
HSK.100A-MT.3.150	HSK.100A-MT.3.150	7227123
HSK.100A-MT.4.170	HSK.100A-MT.4.170	7227124
HSK.100A-MT.5.200	HSK.100A-MT.5.200	7227125
HSK.100A-MTS.1.110	HSK.100A-MTS.1.110	7227130
HSK.100A-MTS.2.120	HSK.100A-MTS.2.120	7227131
HSK.100A-MTS.3.150	HSK.100A-MTS.3.150	7227132
HSK.100A-MTS.4.170	HSK.100A-MTS.4.170	7227133
HSK.100A-MTS.5.200	HSK.100A-MTS.5.200	7227134
HSK.100A-SC.04.085	HSK.100A-SC.04.085	7227263
HSK.100A-SC.05.085	HSK.100A-SC.05.085	7227264
HSK.100A-SC.06.085	HSK.100A-SC.06.085	7227265
HSK.100A-SC.06.085.C	HSK.100A-SC.06.085.C	7227315
HSK.100A-SC.06.120	HSK.100A-SC.06.120	7227266
HSK.100A-SC.06.160	HSK.100A-SC.06.160	7227267
HSK.100A-SC.06.160.C	HSK.100A-SC.06.160.C	7227316
HSK.100A-SC.06.200	HSK.100A-SC.06.200	7227295
HSK.100A-SC.08.085	HSK.100A-SC.08.085	7227268
HSK.100A-SC.08.085.C	HSK.100A-SC.08.085.C	7227317
HSK.100A-SC.08.120	HSK.100A-SC.08.120	7227269
HSK.100A-SC.08.160	HSK.100A-SC.08.160	7227270
HSK.100A-SC.08.160.C	HSK.100A-SC.08.160.C	7227318
HSK.100A-SC.08.200	HSK.100A-SC.08.200	7227296
HSK.100A-SC.10.090	HSK.100A-SC.10.090	7227271
HSK.100A-SC.10.090.C	HSK.100A-SC.10.090.C	7227319
HSK.100A-SC.10.120	HSK.100A-SC.10.120	7227272
HSK.100A-SC.10.160	HSK.100A-SC.10.160	7227273
HSK.100A-SC.10.160.C	HSK.100A-SC.10.160.C	7227320
HSK.100A-SC.10.200	HSK.100A-SC.10.200	7227297
HSK.100A-SC.12.095	HSK.100A-SC.12.095	7227274
HSK.100A-SC.12.095.C	HSK.100A-SC.12.095.C	7227321
HSK.100A-SC.12.120	HSK.100A-SC.12.120	7227275
HSK.100A-SC.12.160	HSK.100A-SC.12.160	7227276
HSK.100A-SC.12.160.C	HSK.100A-SC.12.160.C	7227322
HSK.100A-SC.12.200	HSK.100A-SC.12.200	7227298
HSK.100A-SC.14.095	HSK.100A-SC.14.095	7227277
HSK.100A-SC.14.095.C	HSK.100A-SC.14.095.C	7227323
HSK.100A-SC.14.120	HSK.100A-SC.14.120	7227278
HSK.100A-SC.14.160	HSK.100A-SC.14.160	7227279
HSK.100A-SC.14.160.C	HSK.100A-SC.14.160.C	7227324
HSK.100A-SC.14.200	HSK.100A-SC.14.200	7227299
HSK.100A-SC.16.100	HSK.100A-SC.16.100	7227280
HSK.100A-SC.16.100.C	HSK.100A-SC.16.100.C	7227325
HSK.100A-SC.16.120	HSK.100A-SC.16.120	7227281
HSK.100A-SC.16.160	HSK.100A-SC.16.160	7227282
HSK.100A-SC.16.160.C	HSK.100A-SC.16.160.C	7227326
HSK.100A-SC.16.200	HSK.100A-SC.16.200	7227300
HSK.100A-SC.18.100	HSK.100A-SC.18.100	7227283
HSK.100A-SC.18.100.C	HSK.100A-SC.18.100.C	7227327
HSK.100A-SC.18.120	HSK.100A-SC.18.120	7227284
HSK.100A-SC.18.160	HSK.100A-SC.18.160	7227285
HSK.100A-SC.18.160.C	HSK.100A-SC.18.160.C	7227328
HSK.100A-SC.18.200	HSK.100A-SC.18.200	7227301
HSK.100A-SC.20.105	HSK.100A-SC.20.105	7227286
HSK.100A-SC.20.105.C	HSK.100A-SC.20.105.C	7227329
HSK.100A-SC.20.120	HSK.100A-SC.20.120	7227287
HSK.100A-SC.20.160	HSK.100A-SC.20.160	7227288
HSK.100A-SC.20.160.C	HSK.100A-SC.20.160.C	7227330
HSK.100A-SC.20.200	HSK.100A-SC.20.200	7227302
HSK.100A-SC.25.115.C	HSK.100A-SC.25.115.C	7227331
HSK.100A-SC.25.120	HSK.100A-SC.25.120	7227289
HSK.100A-SC.25.160	HSK.100A-SC.25.160	7227290
HSK.100A-SC.25.160.C	HSK.100A-SC.25.160.C	7227332
HSK.100A-SC.25.200	HSK.100A-SC.25.200	7227303
HSK.100A-SC.32.120	HSK.100A-SC.32.120	7227291
HSK.100A-SC.32.120.C	HSK.100A-SC.32.120.C	7227333
HSK.100A-SC.32.160	HSK.100A-SC.32.160	7227292
HSK.100A-SC.32.160.C	HSK.100A-SC.32.160.C	7227334
HSK.100A-SC.32.200	HSK.100A-SC.32.200	7227304
HSK.100A-SC.40.150	HSK.100A-SC.40.150	7227293
HSK.100A-SC.40.150.C	HSK.100A-SC.40.150.C	7227294
HSK.100A-W.06.080	HSK.100A-W.06.080	7227003
HSK.100A-W.06.080.C	HSK.100A-W.06.080.C	7227005
HSK.100A-W.06.160	HSK.100A-W.06.160	7227004
HSK.100A-W.08.080	HSK.100A-W.08.080	7227005
HSK.100A-W.08.080.C	HSK.100A-W.08.080.C	7227006
HSK.100A-W.08.160	HSK.100A-W.08.160	7227006

ANSI	ISO	EDP
HSK.100A-W.10.080	HSK.100A-W.10.080	7227007
HSK.100A-W.10.080.C	HSK.100A-W.10.080.C	7227027
HSK.100A-W.10.160	HSK.100A-W.10.160	7227008
HSK.100A-W.12.080	HSK.100A-W.12.080	7227009
HSK.100A-W.12.080.C	HSK.100A-W.12.080.C	7227028
HSK.100A-W.12.160	HSK.100A-W.12.160	7227010
HSK.100A-W.14.080	HSK.100A-W.14.080	7227011
HSK.100A-W.14.080.C	HSK.100A-W.14.080.C	7227029
HSK.100A-W.14.160	HSK.100A-W.14.160	7227012
HSK.100A-W.16.100	HSK.100A-W.16.100	7227013
HSK.100A-W.16.100.C	HSK.100A-W.16.100.C	7227030
HSK.100A-W.16.160	HSK.100A-W.16.160	7227014
HSK.100A-W.18.100	HSK.100A-W.18.100	7227015
HSK.100A-W.18.100.C	HSK.100A-W.18.100.C	7227031
HSK.100A-W.18.160	HSK.100A-W.18.160	7227016
HSK.100A-W.20.100	HSK.100A-W.20.100	7227017
HSK.100A-W.20.100.C	HSK.100A-W.20.100.C	7227032
HSK.100A-W.20.160	HSK.100A-W.20.160	7227018
HSK.100A-W.25.100	HSK.100A-W.25.100	7227019
HSK.100A-W.25.100.C	HSK.100A-W.25.100.C	7227033
HSK.100A-W.25.160	HSK.100A-W.25.160	7227020
HSK.100A-W.32.100	HSK.100A-W.32.100	7227021
HSK.100A-W.32.100.C	HSK.100A-W.32.100.C	7227034
HSK.100A-W.32.160	HSK.100A-W.32.160	7227022
HSK.100A-W.40.105	HSK.100A-W.40.105	7227023
HSK.100A-W.40.105.C	HSK.100A-W.40.105.C	7227035
HSK.100A-W.40.160	HSK.100A-W.40.160	7227024
HSK.63A-FMH1.16.050	HSK.63A-FMH1.16.050	7227097
HSK.63A-FMH1.16.100	HSK.63A-FMH1.16.100	7227098
HSK.63A-FMH1.16.160	HSK.63A-FMH1.16.160	7227099
HSK.63A-FMH1.22.050	HSK.63A-FMH1.22.050	7227100
HSK.63A-FMH1.22.100	HSK.63A-FMH1.22.100	7227101
HSK.63A-FMH1.22.160	HSK.63A-FMH1.22.160	7227102
HSK.63A-FMH1.27.060	HSK.63A-FMH1.27.060	7227103
HSK.63A-FMH1.27.100	HSK.63A-FMH1.27.100	7227104
HSK.63A-FMH1.27.160	HSK.63A-FMH1.27.160	7227105
HSK.63A-FMH1.32.060	HSK.63A-FMH1.32.060	7227106
HSK.63A-FMH1.32.100	HSK.63A-FMH1.32.100	7227107
HSK.63A-FMH1.32.160	HSK.63A-FMH1.32.160	7227108
HSK.63A-FMH1.40.060	HSK.63A-FMH1.40.060	7227109
HSK.63A-FMH1.40.100	HSK.63A-FMH1.40.100	7227110
HSK.63A-FMH1.40.160	HSK.63A-FMH1.40.160	7227111
HSK.63A-FMH2.16.060	HSK.63A-FMH2.16.060	7227088
HSK.63A-FMH2.16.100	HSK.63A-FMH2.16.100	7227089
HSK.63A-FMH2.22.060	HSK.63A-FMH2.22.060	7227090
HSK.63A-FMH2.22.100	HSK.63A-FMH2.22.100	7227091
HSK.63A-FMH2.27.060	HSK.63A-FMH2.27.060	7227092
HSK.63A-FMH2.27.100	HSK.63A-FMH2.27.100	7227093
HSK.63A-FMH2.32.060	HSK.63A-FMH2.32.060	7227094
HSK.63A-FMH2.32.100	HSK.63A-FMH2.32.100	7227095
HSK.63A-FMH2.40.070	HSK.63A-FMH2.40.070	7227096
HSK.63A-FMH4.27.120	HSK.63A-FMH4.27.120	7227347
HSK.63A-FMH4.32.150	HSK.63A-FMH4.32.150	7227348

ANSI	ISO	EDP	ANSI	ISO	EDP	ANSI	ISO	EDP
HSK.63A-MTS.2.120	HSK.63A-MTS.2.120	7227136	HSK.63A-W.08.065	HSK.63A-W.08.065	7226979	P61.SFR-2020K-06	P61.SFR-2020K-06	7725307
HSK.63A-MTS.3.140	HSK.63A-MTS.3.140	7227137	HSK.63A-W.08.065.C	HSK.63A-W.08.065.C	7227038	P61.SFR-2525M-06	P61.SFR-2525M-06	7725308
HSK.63A-MTS.4.160	HSK.63A-MTS.4.160	7227138	HSK.63A-W.08.100	HSK.63A-W.08.100	7226980	PCBNL 2020 K 12	PCBNL 2020 K 12	6757322
HSK.63A-SC.03.080	HSK.63A-SC.03.080	7227215	HSK.63A-W.08.100.C	HSK.63A-W.08.100.C	7227039	PCBNL 2525 M 12	PCBNL 2525 M 12	6757076
HSK.63A-SC.03.120	HSK.63A-SC.03.120	7227216	HSK.63A-W.08.160	HSK.63A-W.08.160	7226981	PCBNL 3225 P 12	PCBNL 3225 P 12	6757181
HSK.63A-SC.03.160	HSK.63A-SC.03.160	7227242	HSK.63A-W.10.065	HSK.63A-W.10.065	7226982	PCBNL 3232 P 16	PCBNL 3232 P 16	6757083
HSK.63A-SC.04.080	HSK.63A-SC.04.080	7227217	HSK.63A-W.10.065.C	HSK.63A-W.10.065.C	7227040	PCBNL 3232 P 19	PCBNL 3232 P 19	6756742
HSK.63A-SC.04.120	HSK.63A-SC.04.120	7227218	HSK.63A-W.10.100	HSK.63A-W.10.100	7226983	PCBNL 4040 S 19	PCBNL 4040 S 19	6758529
HSK.63A-SC.04.160	HSK.63A-SC.04.160	7227243	HSK.63A-W.10.100.C	HSK.63A-W.10.100.C	7227041	PCBNL 4040 S 25	PCBNL 4040 S 25	6757405
HSK.63A-SC.05.080	HSK.63A-SC.05.080	7227219	HSK.63A-W.10.160	HSK.63A-W.10.160	7226984	PCBNL 5050 T 25	PCBNL 5050 T 25	6757407
HSK.63A-SC.05.120	HSK.63A-SC.05.120	7227220	HSK.63A-W.12.080	HSK.63A-W.12.080	7226985	PCBNR 2020 K 12	PCBNR 2020 K 12	6757276
HSK.63A-SC.05.160	HSK.63A-SC.05.160	7227244	HSK.63A-W.12.080.C	HSK.63A-W.12.080.C	7227042	PCBNR 2525 M 12	PCBNR 2525 M 12	6756932
HSK.63A-SC.06.080	HSK.63A-SC.06.080	7227221	HSK.63A-W.12.100	HSK.63A-W.12.100	7226986	PCBNR 3225 P 12	PCBNR 3225 P 12	6757243
HSK.63A-SC.06.080.C	HSK.63A-SC.06.080.C	7227305	HSK.63A-W.12.100.C	HSK.63A-W.12.100.C	7227043	PCBNR 3232 P 16	PCBNR 3232 P 16	6757041
HSK.63A-SC.06.120	HSK.63A-SC.06.120	7227222	HSK.63A-W.12.160	HSK.63A-W.12.160	7226987	PCBNR 3232 P 19	PCBNR 3232 P 19	6756736
HSK.63A-SC.06.160	HSK.63A-SC.06.160	7227245	HSK.63A-W.14.080	HSK.63A-W.14.080	7226988	PCBNR 4040 S 19	PCBNR 4040 S 19	6758530
HSK.63A-SC.06.160.C	HSK.63A-SC.06.160.C	7227335	HSK.63A-W.14.080.C	HSK.63A-W.14.080.C	7227044	PCBNR 4040 S 25	PCBNR 4040 S 25	6757128
HSK.63A-SC.06.200	HSK.63A-SC.06.200	7227246	HSK.63A-W.14.100	HSK.63A-W.14.100	7226989	PCBNR 5050 T 25	PCBNR 5050 T 25	6757406
HSK.63A-SC.08.080	HSK.63A-SC.08.080	7227223	HSK.63A-W.14.100.C	HSK.63A-W.14.100.C	7227045	PCKNL 2020 K 12	PCKNL 2020 K 12	6757283
HSK.63A-SC.08.080.C	HSK.63A-SC.08.080.C	7227306	HSK.63A-W.14.160	HSK.63A-W.14.160	7226990	PCKNL 2525 M 12	PCKNL 2525 M 12	6757084
HSK.63A-SC.08.120	HSK.63A-SC.08.120	7227224	HSK.63A-W.16.080	HSK.63A-W.16.080	7226991	PCKNL 3225 P 12	PCKNL 3225 P 12	6757284
HSK.63A-SC.08.160	HSK.63A-SC.08.160	7227247	HSK.63A-W.16.080.C	HSK.63A-W.16.080.C	7227046	PCKNL 3232 P 16	PCKNL 3232 P 16	6757285
HSK.63A-SC.08.160.C	HSK.63A-SC.08.160.C	7227336	HSK.63A-W.16.100	HSK.63A-W.16.100	7226992	PCKNL 3232 P 19	PCKNL 3232 P 19	6757085
HSK.63A-SC.08.200	HSK.63A-SC.08.200	7227248	HSK.63A-W.16.100.C	HSK.63A-W.16.100.C	7227047	PCKNL 4040 S 19	PCKNL 4040 S 19	6758531
HSK.63A-SC.10.085	HSK.63A-SC.10.085	7227225	HSK.63A-W.16.160	HSK.63A-W.16.160	7226993	PCKNR 2020 K 12	PCKNR 2020 K 12	6757195
HSK.63A-SC.10.085.C	HSK.63A-SC.10.085.C	7227307	HSK.63A-W.16.160.C	HSK.63A-W.16.160.C	7226994	PCKNR 2525 M 12	PCKNR 2525 M 12	6756777
HSK.63A-SC.10.120	HSK.63A-SC.10.120	7227226	HSK.63A-W.18.080	HSK.63A-W.18.080	7226995	PCKNR 3225 P 12	PCKNR 3225 P 12	6757129
HSK.63A-SC.10.160	HSK.63A-SC.10.160	7227227	HSK.63A-W.18.080.C	HSK.63A-W.18.080.C	7227048	PCKNR 3232 P 16	PCKNR 3232 P 16	6757176
HSK.63A-SC.10.160.C	HSK.63A-SC.10.160.C	7227337	HSK.63A-W.18.100	HSK.63A-W.18.100	7226996	PCKNR 3232 P 19	PCKNR 3232 P 19	6757042
HSK.63A-SC.10.200	HSK.63A-SC.10.200	7227228	HSK.63A-W.18.100.C	HSK.63A-W.18.100.C	7227049	PCKNR 4040 S 19	PCKNR 4040 S 19	6758532
HSK.63A-SC.12.090	HSK.63A-SC.12.090	7227229	HSK.63A-W.18.160	HSK.63A-W.18.160	7226996	PCLNL 2020 K 12	PCLNL 2020 K 12	6756933
HSK.63A-SC.12.090.C	HSK.63A-SC.12.090.C	7227308	HSK.63A-W.20.080	HSK.63A-W.20.080	7226997	PCLNL 2020 K 12	PCLNL 2020 K 12	6756933
HSK.63A-SC.12.120	HSK.63A-SC.12.120	7227230	HSK.63A-W.20.080.C	HSK.63A-W.20.080.C	7227050	PCLNL 2525 M 12	PCLNL 2525 M 12	6756739
HSK.63A-SC.12.160	HSK.63A-SC.12.160	7227249	HSK.63A-W.20.100	HSK.63A-W.20.100	7226998	PCLNL 3225 P 12	PCLNL 3225 P 12	6756740
HSK.63A-SC.12.160.C	HSK.63A-SC.12.160.C	7227349	HSK.63A-W.20.100.C	HSK.63A-W.20.100.C	7227051	PCLNL 3225 P 16	PCLNL 3225 P 16	6757075
HSK.63A-SC.12.200	HSK.63A-SC.12.200	7227350	HSK.63A-W.20.160	HSK.63A-W.20.160	7226999	PCLNL 3232 P 19	PCLNL 3232 P 19	6756962
HSK.63A-SC.14.090	HSK.63A-SC.14.090	7227231	HSK.63A-W.25.110	HSK.63A-W.25.110	7227000	PCLNL 4040 R 19	PCLNL 4040 R 19	6756741
HSK.63A-SC.14.090.C	HSK.63A-SC.14.090.C	7227309	HSK.63A-W.25.110.C	HSK.63A-W.25.110.C	7227052	PCLNL 4040 S 19	PCLNL 4040 S 19	6757910
HSK.63A-SC.14.120	HSK.63A-SC.14.120	7227232	HSK.63A-W.32.110	HSK.63A-W.32.110	7227001	PCLNL 4040 S 25	PCLNL 4040 S 25	6756843
HSK.63A-SC.14.160	HSK.63A-SC.14.160	7227251	HSK.63A-W.32.110.C	HSK.63A-W.32.110.C	7227053	PCLNL 5050 T 25	PCLNL 5050 T 25	6757142
HSK.63A-SC.14.160.C	HSK.63A-SC.14.160.C	7227339	HSK.63A-W.40.125	HSK.63A-W.40.125	7227002	PCLNR 2020 K 12	PCLNR 2020 K 12	6757056
HSK.63A-SC.14.200	HSK.63A-SC.14.200	7227252	HSK.63A-W.40.125.C	HSK.63A-W.40.125.C	7227054	PCLNR 2525 M 12	PCLNR 2525 M 12	6757057
HSK.63A-SC.16.095	HSK.63A-SC.16.095	7227233	MS-EN-08 A	MS-EN-08 A	6790612	PCLNR 3225 P 12	PCLNR 3225 P 12	6756822
HSK.63A-SC.16.095.C	HSK.63A-SC.16.095.C	7227310	MS-EN-10 A	MS-EN-10 A	6790613	PCLNR 3225 P 16	PCLNR 3225 P 16	6756776
HSK.63A-SC.16.120	HSK.63A-SC.16.120	7227234	MS-EN-12 C	MS-EN-12 C	6790614	PCLNR 3232 P 19	PCLNR 3232 P 19	6756900
HSK.63A-SC.16.160	HSK.63A-SC.16.160	7227253	MS-EN-1212 F	MS-EN-1212 F	6756564	PCLNR 4040 R 19	PCLNR 4040 R 19	6756734
HSK.63A-SC.16.160.C	HSK.63A-SC.16.160.C	7227340	MS-EN-16 D	MS-EN-16 D	6790615	PCLNR 4040 S 19	PCLNR 4040 S 19	6757909
HSK.63A-SC.16.200	HSK.63A-SC.16.200	7227254	MS-EN-1616 H	MS-EN-1616 H	6756338	PCLNR 4040 S 25	PCLNR 4040 S 25	6756842
HSK.63A-SC.18.095	HSK.63A-SC.18.095	7227235	MS-EN-2020 K	MS-EN-2020 K	6756328	PCLNR 5050 T 25	PCLNR 5050 T 25	6757143
HSK.63A-SC.18.095.C	HSK.63A-SC.18.095.C	7227311	MS-EN-2020 KS	MS-EN-2020 KS	6756836	PDJNL 2020 K 11	PDJNL 2020 K 11	6756747
HSK.63A-SC.18.120	HSK.63A-SC.18.120	7227236	MS-EN-2525 M	MS-EN-2525 M	6756329	PDJNL 2020 K 15	PDJNL 2020 K 15	6756743
HSK.63A-SC.18.160	HSK.63A-SC.18.160	7227255	MS-EN-2525 MS	MS-EN-2525 MS	6756837	PDJNL 2020 M 11	PDJNL 2020 M 11	6756748
HSK.63A-SC.18.160.C	HSK.63A-SC.18.160.C	7227341	MS-EN-3225 P	MS-EN-3225 P	6756330	PDJNL 2525 M 15	PDJNL 2525 M 15	6756956
HSK.63A-SC.18.200	HSK.63A-SC.18.200	7227256	MS-EN-3225 PS	MS-EN-3225 PS	6756838	PDJNL 3225 P 11	PDJNL 3225 P 11	6756749
HSK.63A-SC.20.100	HSK.63A-SC.20.100	7227237	MS-EN-85 E	MS-EN-85 E	6790616	PDJNL 3225 P 15	PDJNL 3225 P 15	6756744
HSK.63A-SC.20.100.C	HSK.63A-SC.20.100.C	7227312	MTJNL 2020 K 16	MTJNL 2020 K 16	6758419	PDJNL 3232 P 15	PDJNL 3232 P 15	6757182
HSK.63A-SC.20.120	HSK.63A-SC.20.120	7227238	MTJNL 2525 M 16	MTJNL 2525 M 16	6758421	PDJNR 2020 K 11	PDJNR 2020 K 11	6756750
HSK.63A-SC.20.160	HSK.63A-SC.20.160	7227257	MTJNL 3232 P 22	MTJNL 3232 P 22	6758423	PDJNR 2020 K 15	PDJNR 2020 K 15	6757088
HSK.63A-SC.20.160.C	HSK.63A-SC.20.160.C	7227342	MTJNR 2020 K 16	MTJNR 2020 K 16	6758418	PDJNR 2525 M 11	PDJNR 2525 M 11	6756751
HSK.63A-SC.20.200	HSK.63A-SC.20.200	7227352	MTJNR 2525 M 16	MTJNR 2525 M 16	6758420	PDJNR 2525 M 15	PDJNR 2525 M 15	6756966
HSK.63A-SC.25.115	HSK.63A-SC.25.115	7227239	MTJNR 3232 P 22	MTJNR 3232 P 22	6758422	PDJNR 3225 P 11	PDJNR 3225 P 11	6756752
HSK.63A-SC.25.115.C	HSK.63A-SC.25.115.C	7227313	MVJNL 2020 K 16-A	MVJNL 2020 K 16-A	6756761	PDJNR 3225 P 15	PDJNR 3225 P 15	6757055
HSK.63A-SC.25.120	HSK.63A-SC.25.120	7227240	MVJNL 2525 M 16-A	MVJNL 2525 M 16-A	6756762	PDJNR 3232 P 15	PDJNR 3232 P 15	6757036
HSK.63A-SC.25.160	HSK.63A-SC.25.160	7227259	MVJNL 3225 P 16-A	MVJNL 3225 P 16-A	6757319	PDNNL 2020 K 11	PDNNL 2020 K 11	6756753
HSK.63A-SC.25.160.C	HSK.63A-SC.25.160.C	7227343	MVJNR 2020 K 16-A	MVJNR 2020 K 16-A	6756763	PDNNL 2525 M 11	PDNNL 2525 M 11	6756754
HSK.63A-SC.25.200	HSK.63A-SC.25.200	7227260	MVJNR 2525 M 16-A	MVJNR 2525 M 16-A	6756764	PDNNL 2525 M 15	PDNNL 2525 M 15	6757086
HSK.63A-SC.32.120	HSK.63A-SC.32.120	7227241	MVJNR 3225 P 16-A	MVJNR 3225 P 16-A	6756765	PDNNL 3225 P 15	PDNNL 3225 P 15	6757904
HSK.63A-SC.32.120.C	HSK.63A-SC.32.120.C	7227314	MWLNL 2525 M 08	MWLNL 2525 M 08	6757244	PDNNR 2020 K 11	PDNNR 2020 K 11	6756755
HSK.63A-SC.32.160	HSK.63A-SC.32.160	7227261	MWLNL 3225 P 08	MWLNL 3225 P 08	6757154	PDNNR 2525 M 11	PDNNR 2525 M 11	6756756
HSK.63A-SC.32.160.C	HSK.63A-SC.32.160.C	7227344	MWLNL 4040 R 08	MWLNL 4040 R 08	6757294	PDNNR 2525 M 15	PDNNR 2525 M 15	6757044
HSK.63A-SC.32.200	HSK.63A-SC.32.200	7227262	MWLNLR 2525 M 08	MWLNLR 2525 M 08	6756955	PDNNR 3225 P 15	PDNNR 3225 P 15	6757903
HSK.63A-W.06.065	HSK.63A-W.06.065	7226976	MWLNLR 3225 P 08	MWLNLR 3225 P 08	6757198	PDXNL 2020 K 15	PDXNL 2020 K 15	6757290
HSK.63A-W.06.065.C	HSK.63A-W.06.065.C	7227036	MWLNLR 4040 R 08	MWLNLR 4040 R 08	6757293	PDXNL 2525 M 15	PDXNL 2525 M 15	6757087
HSK.63A-W.06.100	HSK.63A-W.06.100	7226977	P61.SFL-1616H-06	P61.SFL-1616H-06	7725303	PDXNR 3225 P 15	PDXNR 3225 P 15	6757090
HSK.63A-W.06.100.C	HSK.63A-W.06.100.C	7227037	P61.SFL-2020K-06	P61.SFL-2020K-06	7725304	PDXNR 2020 K 15	PDXNR 2020 K 15	6757045
HSK.63A-W.06.160	HSK.63A-W.06.160	7226978	P61.SFL-2525M-06	P61.SFL-2525M-06	7725305	PDXNR 2525 M 15	PDXNR 2525 M 15	6756907
			P61.SFR-1616H-06	P61.SFR-1616H-06	7725306	PDXNR 3225 P 15	PDXNR 3225 P 15	6757082



ANSI	ISO	EDP	ANSI	ISO	EDP	ANSI	ISO	EDP
PHZ 1512-10	PHZ 1512-10	6760618	PSKNR 2020 K 12	PSKNR 2020 K 12	6756988	PXFNR 2525 S 19/15	PXFNR 2525 S 19/15	6759653
PHZ 2014-13	PHZ 2014-13	6760623	PSKNR 2525 M 12	PSKNR 2525 M 12	6756688	PXFNR 3232 S 25	PXFNR 3232 S 25	6760227
PHZ 90 1104-06	PHZ 90 1104-06	6760938	PSKNR 3225 P 15	PSKNR 3225 P 15	6757275	S16M-CTFPR 11	S16M-CTFPR 11	6756930
PHZ 90 1107-06	PHZ 90 1107-06	6760939	PSKNR 3232 P 19	PSKNR 3232 P 19	6756989	S20Q-CSKPR 09	S20Q-CSKPR 09	6757092
PHZ 90 1111-06	PHZ 90 1111-06	6760940	PSKNR 4040 S 19	PSKNR 4040 S 19	6758445	S20Q-CTFPR 11	S20Q-CTFPR 11	6756965
PHZ/2 3625-14	PHZ/2 3625-14	6760769	PSKNR 4040 S 25	PSKNR 4040 S 25	6758504	S25T-CSKPR 12	S25T-CSKPR 12	6756884
PHZ/2 4832-18	PHZ/2 4832-18	6760941	PSKNR 5050 T 25	PSKNR 5050 T 25	6758289	S25T-CTFPR 16	S25T-CTFPR 16	6756959
PLBNL 6060 V 40-A	PLBNL 6060 V 40-A	6757421	PSKNR 5050 T 2509	PSKNR 5050 T 2509	6756708	S32U-CTFPR 16	S32U-CTFPR 16	6756908
PLBNL 6060 V 50	PLBNL 6060 V 50	6758283	PSSNL 2020 K 12	PSSNL 2020 K 12	6757155	SCACL 0808 D 06	SCACL 0808 D 06	6757096
PLBNL 6060 V 50-2	PLBNL 6060 V 50-2	7045478	PSSNL 2525 M 12	PSSNL 2525 M 12	6757066	SCACL 1010 E 06	SCACL 1010 E 06	6756880
PLBNR 6060 V 40-A	PLBNR 6060 V 40-A	6757240	PSSNL 3225 P 15	PSSNL 3225 P 15	6757067	SCACL 1212 F 09	SCACL 1212 F 09	6756881
PLBNR 6060 V 50	PLBNR 6060 V 50	6758284	PSSNL 3232 P 19	PSSNL 3232 P 19	6756738	SCACL 1616 H 09	SCACL 1616 H 09	6756795
PLBNR 6060 V 50-2	PLBNR 6060 V 50-2	7045479	PSSNL 4040 R 19	PSSNL 4040 R 19	6757073	SCACR 0808 D 06	SCACR 0808 D 06	6756799
PRDCN 3225 P 16	PRDCN 3225 P 16	6757144	PSSNL 5050 T 25	PSSNL 5050 T 25	6758290	SCACR 1010 E 06	SCACR 1010 E 06	6756778
PRDCN 3232 P 20	PRDCN 3232 P 20	6756904	PSSNL 5050 T 2509	PSSNL 5050 T 2509	6757889	SCACR 1212 F 09	SCACR 1212 F 09	6756912
PRDCN 4040 S 20	PRDCN 4040 S 20	6757911	PSSNR 2020 K 12	PSSNR 2020 K 12	6756909	SCACR 1616 H 09	SCACR 1616 H 09	6756779
PRDCN 4040 S 25	PRDCN 4040 S 25	6758511	PSSNR 2525 M 12	PSSNR 2525 M 12	6756899	SCBCL 1212 F 09	SCBCL 1212 F 09	6756992
PRDCN 5050 S 32	PRDCN 5050 S 32	6757175	PSSNR 3225 P 15	PSSNR 3225 P 15	6757130	SCBCL 1616 H 09	SCBCL 1616 H 09	6756892
PRDCN 5050 T 32	PRDCN 5050 T 32	6758285	PSSNR 3232 P 19	PSSNR 3232 P 19	6756897	SCBCL 2020 K 12-M-A	SCBCL 2020 K 12-M-A	6756574
PRSCCL 3225 P 16	PRSCCL 3225 P 16	6757179	PSSNR 4040 R 19	PSSNR 4040 R 19	6757037	SCBCL 2525 M 12-M-A	SCBCL 2525 M 12-M-A	6756575
PRSCCL 3232 P 20	PRSCCL 3232 P 20	6757180	PSSNR 5050 T 25	PSSNR 5050 T 25	6758291	SCBCR 1212 F 09	SCBCR 1212 F 09	6757183
PRSCCL 4040 R 16	PRSCCL 4040 R 16	6757906	PSSNR 5050 T 2509	PSSNR 5050 T 2509	6757888	SCBCR 1616 H 09	SCBCR 1616 H 09	6756886
PRSCCL 4040 S 25	PRSCCL 4040 S 25	6758533	PTFNL 1616 H 16	PTFNL 1616 H 16	6757282	SCBCR 2020 K 12-M-A	SCBCR 2020 K 12-M-A	6756576
PRSCCR 3225 P 16	PRSCCR 3225 P 16	6757185	PTFNL 2020 K 16	PTFNL 2020 K 16	6757279	SCBCR 2525 M 12-M-A	SCBCR 2525 M 12-M-A	6756577
PRSCCR 3232 P 20	PRSCCR 3232 P 20	6757174	PTFNL 2525 M 16	PTFNL 2525 M 16	6757196	SCDCR 1010 E 06	SCDCR 1010 E 06	6760923
PRSCCR 4040 R 16	PRSCCR 4040 R 16	6757905	PTFNL 2525 M 22	PTFNL 2525 M 22	6757061	SCFCL 0808 D 06	SCFCL 0808 D 06	6756890
PRSCCR 4040 S 25	PRSCCR 4040 S 25	6758534	PTFNL 3225 P 22	PTFNL 3225 P 22	6757131	SCFCL 1010 E 06	SCFCL 1010 E 06	6756891
PRSNL 2525 M 12	PRSNL 2525 M 12	6757291	PTFNL 4040 R 27	PTFNL 4040 R 27	6757280	SCFCL 1212 F 09	SCFCL 1212 F 09	6756796
PRSNL 3232 P 15	PRSNL 3232 P 15	6757358	PTFNR 1616 H 16	PTFNR 1616 H 16	6757039	SCFCL 1616 H 09	SCFCL 1616 H 09	6756807
PRSNL 4040 R 19	PRSNL 4040 R 19	6757292	PTFNR 2020 K 16	PTFNR 2020 K 16	6757132	SCFCR 0808 D 06	SCFCR 0808 D 06	6756800
PRSNR 2525 M 12	PRSNR 2525 M 12	6757046	PTFNR 2525 M 16	PTFNR 2525 M 16	6756986	SCFCR 1010 E 06	SCFCR 1010 E 06	6756783
PRSNR 3232 P 15	PRSNR 3232 P 15	6757277	PTFNR 2525 M 22	PTFNR 2525 M 22	6756686	SCFCR 1212 F 09	SCFCR 1212 F 09	6756804
PRSNR 4040 R 19	PRSNR 4040 R 19	6757278	PTFNR 3225 P 22	PTFNR 3225 P 22	6756987	SCFCR 1616 H 09	SCFCR 1616 H 09	6756810
PSBNL 2020 K 12	PSBNL 2020 K 12	6757051	PTFNR 4040 R 27	PTFNR 4040 R 27	6757274	SCCLCL 06 2	SCCLCL 06 2	6788651
PSBNL 2525 M 12	PSBNL 2525 M 12	6757071	PTGNL 1616 H 16	PTGNL 1616 H 16	6757074	SCCLCL 08 3	SCCLCL 08 3	6788652
PSBNL 3225 P 15	PSBNL 3225 P 15	6757060	PTGNL 2020 K 16	PTGNL 2020 K 16	6757047	SCCLCL 0808 D 06	SCCLCL 0808 D 06	6756793
PSBNL 3232 P 19	PSBNL 3232 P 19	6756958	PTGNL 2525 M 16	PTGNL 2525 M 16	6757133	SCCLCL 10 3	SCCLCL 10 3	6788653
PSBNL 4040 R 19	PSBNL 4040 R 19	6756737	PTGNL 2525 M 22	PTGNL 2525 M 22	6757050	SCCLCL 1010 E 06	SCCLCL 1010 E 06	6756879
PSBNL 4040 R 25	PSBNL 4040 R 25	6757145	PTGNL 3225 P 22	PTGNL 3225 P 22	6757048	SCCLCL 12 4B	SCCLCL 12 4B	6788654
PSBNL 4040 S 19	PSBNL 4040 S 19	6757913	PTGNL 3232 P 22	PTGNL 3232 P 22	6757411	SCCLCL 1212 F 08	SCCLCL 1212 F 08	6760925
PSBNL 4040 S 25	PSBNL 4040 S 25	6757239	PTGNL 4040 R 27	PTGNL 4040 R 27	6757049	SCCLCL 1212 F 09	SCCLCL 1212 F 09	6756794
PSBNL 4040 S 2509	PSBNL 4040 S 2509	6756705	PTGNR 1616 H 16	PTGNR 1616 H 16	6757134	SCCLCL 16 4D	SCCLCL 16 4D	6788655
PSBNL 4040 S 2512-A	PSBNL 4040 S 2512-A	6758473	PTGNR 2020 K 16	PTGNR 2020 K 16	6756680	SCCLCL 1616 H 08	SCCLCL 1616 H 08	6760927
PSBNL 5050 S 25	PSBNL 5050 S 25	6757072	PTGNR 2525 M 16	PTGNR 2525 M 16	6756681	SCCLCL 1616 H 09	SCCLCL 1616 H 09	6756768
PSBNL 5050 T 25	PSBNL 5050 T 25	6758286	PTGNR 2525 M 22	PTGNR 2525 M 22	6756682	SCCLCL 2020 K 12-M-A	SCCLCL 2020 K 12-M-A	6756578
PSBNL 5050 T 2509	PSBNL 5050 T 2509	6756707	PTGNR 3225 P 22	PTGNR 3225 P 22	6756960	SCCLCL 2525 M 12-M-A	SCCLCL 2525 M 12-M-A	6756579
PSBNL 5050 T 2512-A	PSBNL 5050 T 2512-A	6758474	PTGNR 3232 P 22	PTGNR 3232 P 22	6757173	SCCLR 06 2	SCCLR 06 2	6788656
PSBNR 2020 K 12	PSBNR 2020 K 12	6756985	PTGNR 4040 R 27	PTGNR 4040 R 27	6756978	SCCLR 08 3	SCCLR 08 3	6788657
PSBNR 2525 M 12	PSBNR 2525 M 12	6757226	PTTNL 2020 K 16	PTTNL 2020 K 16	6757286	SCCLR 0808 D 06	SCCLR 0808 D 06	6756808
PSBNR 3225 P 15	PSBNR 3225 P 15	6757146	PTTNL 2525 M 16	PTTNL 2525 M 16	6757287	SCCLR 10 3	SCCLR 10 3	6788658
PSBNR 3232 P 19	PSBNR 3232 P 19	6756685	PTTNL 2525 M 22	PTTNL 2525 M 22	6757288	SCCLR 1010 E 06	SCCLR 1010 E 06	6756745
PSBNR 4040 R 19	PSBNR 4040 R 19	6756683	PTTNL 3225 P 22	PTTNL 3225 P 22	6757289	SCCLR 1010 E 08	SCCLR 1010 E 08	6760924
PSBNR 4040 R 25	PSBNR 4040 R 25	6756735	PTTNR 2020 K 16	PTTNR 2020 K 16	6757043	SCCLR 12 4B	SCCLR 12 4B	6788659
PSBNR 4040 S 19	PSBNR 4040 S 19	6757912	PTTNR 2525 M 16	PTTNR 2525 M 16	6757251	SCCLR 1212 F 08	SCCLR 1212 F 08	6760926
PSBNR 4040 S 25	PSBNR 4040 S 25	6757238	PTTNR 2525 M 22	PTTNR 2525 M 22	6757177	SCCLR 1212 F 09	SCCLR 1212 F 09	6756801
PSBNR 4040 S 2509	PSBNR 4040 S 2509	6756704	PTTNR 3225 P 22	PTTNR 3225 P 22	6757178	SCCLR 16 4D	SCCLR 16 4D	6788660
PSBNR 4040 S 2512-A	PSBNR 4040 S 2512-A	6758471	PWLNL 1616 H 0604	PWLNL 1616 H 0604	6757062	SCCLR 1616 H 08	SCCLR 1616 H 08	6760928
PSBNR 5050 S 25	PSBNR 5050 S 25	6756684	PWLNL 2020 K 0604	PWLNL 2020 K 0604	6757063	SCCLR 1616 H 09	SCCLR 1616 H 09	6756746
PSBNR 5050 T 25	PSBNR 5050 T 25	6758287	PWLNL 2020 K 08	PWLNL 2020 K 08	6757068	SCCLR 2020 K 12-M-A	SCCLR 2020 K 12-M-A	6756580
PSBNR 5050 T 2509	PSBNR 5050 T 2509	6756706	PWLNL 2525 M 0604	PWLNL 2525 M 0604	6759721	SCCLR 2525 M 12-M-A	SCCLR 2525 M 12-M-A	6756581
PSBNR 5050 T 2512-A	PSBNR 5050 T 2512-A	6758472	PWLNL 2525 M 08	PWLNL 2525 M 08	6756952	SDJCL 06 2	SDJCL 06 2	6788661
PSDNN 2020 K 12	PSDNN 2020 K 12	6757038	PWLNL 3225 P 08	PWLNL 3225 P 08	6757135	SDJCL 08 2	SDJCL 08 2	6788662
PSDNN 2525 M 12	PSDNN 2525 M 12	6756906	PWLNR 1616 H 0604	PWLNR 1616 H 0604	6757194	SDJCL 0808 D 07	SDJCL 0808 D 07	6756990
PSDNN 3232 P 15	PSDNN 3232 P 15	6757040	PWLNR 2020 K 0604	PWLNR 2020 K 0604	6756687	SDJCL 1010 E 07	SDJCL 1010 E 07	6756915
PSDNN 3232 P 19	PSDNN 3232 P 19	6756689	PWLNR 2020 K 08	PWLNR 2020 K 08	6757070	SDJCL 12 3B	SDJCL 12 3B	6788663
PSDNN 4040 S 19	PSDNN 4040 S 19	6758535	PWLNR 2525 M 0604	PWLNR 2525 M 0604	6759722	SDJCL 1212 F 07	SDJCL 1212 F 07	6756792
PSDNN 4040 S 25	PSDNN 4040 S 25	6758536	PWLNR 2525 M 08	PWLNR 2525 M 08	6756937	SDJCL 1212 F 11	SDJCL 1212 F 11	6756797
PSDNN 5050 T 25	PSDNN 5050 T 25	6758537	PWLNR 3225 P 08	PWLNR 3225 P 08	6756924	SDJCL 16 3D	SDJCL 16 3D	6788664
PSKNL 2020 K 12	PSKNL 2020 K 12	6757197	PXFNL 2525 R 15	PXFNL 2525 R 15	6760224	SDJCL 1616 H 11	SDJCL 1616 H 11	6756882
PSKNL 2525 M 12	PSKNL 2525 M 12	6757064	PXFNL 2525 R 15/15	PXFNL 2525 R 15/15	6759652	SDJCL 2020 K 11-M-A	SDJCL 2020 K 11-M-A	6756582
PSKNL 3225 P 15	PSKNL 3225 P 15	6757281	PXFNL 2525 S 19	PXFNL 2525 S 19	6760226	SDJCL 2525 M 11-M-A	SDJCL 2525 M 11-M-A	6756583
PSKNL 3232 P 19	PSKNL 3232 P 19	6757065	PXFNL 2525 S 19/15	PXFNL 2525 S 19/15	6759654	SDJCL 2525 M 15	SDJCL 2525 M 15	6761038
PSKNL 4040 S 19	PSKNL 4040 S 19	6758538	PXFNL 3232 S 25	PXFNL 3232 S 25	6760228	SDJCR 06 2	SDJCR 06 2	6788665
PSKNL 4040 S 25	PSKNL 4040 S 25	6758512	PXFNR 2525 R 15	PXFNR 2525 R 15	6760223	SDJCR 08 2	SDJCR 08 2	6788666
PSKNL 5050 T 25	PSKNL 5050 T 25	6758288	PXFNR 2525 R 15/15	PXFNR 2525 R 15/15	6759651	SDJCR 0808 D 07	SDJCR 0808 D 07	6756781
PSKNL 5050 T 2509	PSKNL 5050 T 2509	6756709	PXFNR 2525 S 19	PXFNR 2525 S 19	6760225	SDJCR 1010 E 07	SDJCR 1010 E 07	6756883

ANSI	ISO	EDP	ANSI	ISO	EDP	ANSI	ISO	EDP
SDJCR 12 3B	SDJCR 12 3B	6788667	SRSC 3225 P 16-M	SRSC 3225 P 16-M	6758443	SVGCR 0808 K 07	SVGCR 0808 K 07	6760747
SDJCR 1212 F 07	SDJCR 1212 F 07	6756782	SRSCR 1212 F 06	SRSCR 1212 F 06	6756873	SVGCR 1010 M 07	SVGCR 1010 M 07	6760748
SDJCR 1212 F 11	SDJCR 1212 F 11	6756767	SRSCR 1616 H 06	SRSCR 1616 H 06	6756785	SVGCR 1212 M 07	SVGCR 1212 M 07	6760749
SDJCR 16 3D	SDJCR 16 3D	6788668	SRSCR 2020 K 08	SRSCR 2020 K 08	6756780	SVGCR 1616 P 07	SVGCR 1616 P 07	6760766
SDJCR 1616 H 11	SDJCR 1616 H 11	6756901	SRSCR 2020 K 10-M-A	SRSCR 2020 K 10-M-A	6756594	SVHBL 12 3B	SVHBL 12 3B	6788682
SDJCR 2020 K 11-M-A	SDJCR 2020 K 11-M-A	6756584	SRSCR 2525 M 10-M-A	SRSCR 2525 M 10-M-A	6756595	SVHBL 16 3D	SVHBL 16 3D	6788683
SDJCR 2525 M 11-M-A	SDJCR 2525 M 11-M-A	6756585	SRSCR 2525 M 12-M-A	SRSCR 2525 M 12-M-A	6756596	SVHBL 1616 H 11	SVHBL 1616 H 11	6760327
SDJCR 2525 M 15	SDJCR 2525 M 15	6761037	SRSCR 3225 P 10-M	SRSCR 3225 P 10-M	6758438	SVHBR 12 3B	SVHBR 12 3B	6788684
SDNCN 0808 D 07	SDNCN 0808 D 07	6756885	SRSCR 3225 P 12-M	SRSCR 3225 P 12-M	6758440	SVHBR 16 3D	SVHBR 16 3D	6788685
SDNCN 1010 E 07	SDNCN 1010 E 07	6756860	SRSCR 3225 P 16-M	SRSCR 3225 P 16-M	6758442	SVHBR 1616 H 11	SVHBR 1616 H 11	6760328
SDNCN 1212 F 07	SDNCN 1212 F 07	6756861	SSBCL 1212 F 09	SSBCL 1212 F 09	6757214	SVHCL 2020 K 16-M-A	SVHCL 2020 K 16-M-A	6756615
SDNCN 1212 F 11	SDNCN 1212 F 11	6756862	SSBCL 1616 H 09	SSBCL 1616 H 09	6756993	SVHCL 2525 M 16-M-A	SVHCL 2525 M 16-M-A	6756616
SDNCN 1616 H 11	SDNCN 1616 H 11	6756803	SSBCL 2020 K 12-M-A	SSBCL 2020 K 12-M-A	6756597	SVHCR 2020 K 16-M-A	SVHCR 2020 K 16-M-A	6756617
SDNCN 2020 K 11-M-A	SDNCN 2020 K 11-M-A	6756586	SSBCL 2525 M 12-M-A	SSBCL 2525 M 12-M-A	6756598	SVHCR 2525 M 16-M-A	SVHCR 2525 M 16-M-A	6756618
SDNCN 2525 M 11-M-A	SDNCN 2525 M 11-M-A	6756587	SSBCL 4040 S 25	SSBCL 4040 S 25	6757891	SVJBL 10 2	SVJBL 10 2	6788687
SDPCN 06 2	SDPCN 06 2	6788669	SSBCL 5050 T 25	SSBCL 5050 T 25	6757893	SVJBL 12 2B	SVJBL 12 2B	6788686
SDPCN 08 2	SDPCN 08 2	6788670	SSBCL 5050 T 38-A	SSBCL 5050 T 38-A	6759704	SVJBL 12 3B	SVJBL 12 3B	6788690
SDPCN 10 3	SDPCN 10 3	6788671	SSBCL 6060 V 38-A	SSBCL 6060 V 38-A	6759638	SVJBL 1212 F 11	SVJBL 1212 F 11	6760329
SDPCN 12 3B	SDPCN 12 3B	6788672	SSBCR 1212 F 09	SSBCR 1212 F 09	6756887	SVJBL 16 3D	SVJBL 16 3D	6789414
SDPCN 16 3C	SDPCN 16 3C	6788673	SSBCR 1616 H 09	SSBCR 1616 H 09	6756784	SVJBL 1616 H 11	SVJBL 1616 H 11	6760330
SEGCL 1212 N 08	SEGCL 1212 N 08	6760432	SSBCR 2020 K 12-M-A	SSBCR 2020 K 12-M-A	6756599	SVJBL 20 3D	SVJBL 20 3D	6788695
SEGCL 1616 H 08	SEGCL 1616 H 08	6760433	SSBCR 2525 M 12-M-A	SSBCR 2525 M 12-M-A	6756600	SVJBR 10 2	SVJBR 10 2	6788689
SEGCR 1212 N 08	SEGCR 1212 N 08	6760434	SSBCR 4040 S 25	SSBCR 4040 S 25	6757890	SVJBR 12 2B	SVJBR 12 2B	6788688
SEGCR 1616 H 08	SEGCR 1616 H 08	6760435	SSBCR 5050 T 25	SSBCR 5050 T 25	6757892	SVJBR 12 3B	SVJBR 12 3B	6788693
SEL 12 C16	SEL 12 C16	6790619	SSBCR 5050 T 38-A	SSBCR 5050 T 38-A	6759703	SVJBR 1212 F 11	SVJBR 1212 F 11	6760331
SEL 16 D16	SEL 16 D16	6790630	SSBCR 6060 V 38-A	SSBCR 6060 V 38-A	6759657	SVJBR 16 3D	SVJBR 16 3D	6788694
SEL 16 D22	SEL 16 D22	6790631	SSDCN 08 3	SSDCN 08 3	6788674	SVJBR 1616 H 11	SVJBR 1616 H 11	6760332
SEL 2020 K 16	SEL 2020 K 16	6756971	SSDCN 10 3	SSDCN 10 3	6788675	SVJBR 20 3D	SVJBR 20 3D	6788692
SEL 2525 M 16	SEL 2525 M 16	6756972	SSDCN 1212 F 09	SSDCN 1212 F 09	6756823	SVJCL 0808 K 13-DC	SVJCL 0808 K 13-DC	6760596
SEL 2525 M 22-A	SEL 2525 M 22-A	6757165	SSDCN 1616 H 09	SSDCN 1616 H 09	6756802	SVJCL 1010 L 13-DC	SVJCL 1010 L 13-DC	6760598
SEL 3225 P 16	SEL 3225 P 16	6757249	SSDCN 2020 K 12-M-A	SSDCN 2020 K 12-M-A	6756601	SVJCL 1212 L 13-DC	SVJCL 1212 L 13-DC	6760600
SEL 3225 P 22-A	SEL 3225 P 22-A	6757250	SSDCN 2525 M 12-M-A	SSDCN 2525 M 12-M-A	6756602	SVJCL 1212 N 13	SVJCL 1212 N 13	6760436
SEL 85 D16	SEL 85 D16	6790632	SSKCL 1212 F 09	SSKCL 1212 F 09	6757189	SVJCL 1616 H 13	SVJCL 1616 H 13	6760437
SEL 85 D22	SEL 85 D22	6790633	SSKCL 1616 H 09	SSKCL 1616 H 09	6756893	SVJCL 1616 M 13-DC	SVJCL 1616 M 13-DC	6760602
SEL-S 16 D22	SEL-S 16 D22	6790634	SSKCL 2020 K 12-M-A	SSKCL 2020 K 12-M-A	6756603	SVJCL 2020 K 13	SVJCL 2020 K 13	6760438
SEL-S 2525 M 22-A	SEL-S 2525 M 22-A	6757161	SSKCL 2525 M 12-M-A	SSKCL 2525 M 12-M-A	6756604	SVJCL 2020 K 16-M-A	SVJCL 2020 K 16-M-A	6756619
SEL-S 3225 P 22-A	SEL-S 3225 P 22-A	6757241	SSKCR 1212 F 09	SSKCR 1212 F 09	6756888	SVJCL 2020 M 13-DC	SVJCL 2020 M 13-DC	6760604
SEL-S 85 D22	SEL-S 85 D22	6790635	SSKCR 1616 H 09	SSKCR 1616 H 09	6756840	SVJCL 2525 M 13	SVJCL 2525 M 13	6760439
SER 12 C16	SER 12 C16	6790636	SSKCR 2020 K 12-M-A	SSKCR 2020 K 12-M-A	6756605	SVJCL 2525 M 13-DC	SVJCL 2525 M 13-DC	6760830
SER 16 D16	SER 16 D16	6790637	SSKCR 2525 M 12-M-A	SSKCR 2525 M 12-M-A	6756606	SVJCL 2525 M 16-M-A	SVJCL 2525 M 16-M-A	6756620
SER 16 D22	SER 16 D22	6790638	STFCL 1616 H 11	STFCL 1616 H 11	6756788	SVJCL 3225 P 16-M-A	SVJCL 3225 P 16-M-A	6756621
SER 2020 K 16	SER 2020 K 16	6756898	STFCL 2020 K 11-A	STFCL 2020 K 11-A	6760492	SVJCR 0808 K 13-DC	SVJCR 0808 K 13-DC	6760829
SER 2525 M 16	SER 2525 M 16	6756940	STFCL 2020 K 16-M-A	STFCL 2020 K 16-M-A	6756607	SVJCR 1010 L 13-DC	SVJCR 1010 L 13-DC	6760597
SER 2525 M 22-A	SER 2525 M 22-A	6756923	STFCL 2525 M 16-M-A	STFCL 2525 M 16-M-A	6756608	SVJCR 1212 L 13-DC	SVJCR 1212 L 13-DC	6760599
SER 3225 P 16	SER 3225 P 16	6756973	STFCR 1616 H 11	STFCR 1616 H 11	6756805	SVJCR 1212 N 13	SVJCR 1212 N 13	6760440
SER 3225 P 22-A	SER 3225 P 22-A	6756981	STFCR 2020 K 11-A	STFCR 2020 K 11-A	6760493	SVJCR 1616 H 13	SVJCR 1616 H 13	6760441
SER 85 D16	SER 85 D16	6790639	STFCR 2020 K 16-M-A	STFCR 2020 K 16-M-A	6756609	SVJCR 1616 M 13-DC	SVJCR 1616 M 13-DC	6760601
SER 85 D22	SER 85 D22	6790640	STFCR 2525 M 16-M-A	STFCR 2525 M 16-M-A	6756610	SVJCR 2020 K 13	SVJCR 2020 K 13	6760442
SER-S 16 D22	SER-S 16 D22	6790641	STGCL 08 2	STGCL 08 2	6788676	SVJCR 2020 K 16-M-A	SVJCR 2020 K 16-M-A	6756622
SER-S 2525 M 22-A	SER-S 2525 M 22-A	6757114	STGCL 12 3B	STGCL 12 3B	6788677	SVJCR 2020 M 13-DC	SVJCR 2020 M 13-DC	6760603
SER-S 3225 P 22-A	SER-S 3225 P 22-A	6757316	STGCL 16 3D	STGCL 16 3D	6788678	SVJCR 2525 M 13	SVJCR 2525 M 13	6760443
SER-S 85 D22	SER-S 85 D22	6790642	STGCR 08 2	STGCR 08 2	6788679	SVJCR 2525 M 13-DC	SVJCR 2525 M 13-DC	6760605
SRDCL 2020 K 08-A	SRDCL 2020 K 08-A	6760486	STGCR 12 3B	STGCR 12 3B	6788680	SVJCR 2525 M 16-M-A	SVJCR 2525 M 16-M-A	6756623
SRDCL 2525 M 08-A	SRDCL 2525 M 08-A	6760487	STGCR 16 3D	STGCR 16 3D	6788681	SVJCR 3225 P 16-M-A	SVJCR 3225 P 16-M-A	6756624
SRDCL 3225 P 08-A	SRDCL 3225 P 08-A	6760488	STJCL 1616 H 11	STJCL 1616 H 11	6756791	SVPBL 1616 H 11	SVPBL 1616 H 11	6760333
SRDCN 1212 F 06	SRDCN 1212 F 06	6757150	STJCL 2020 K 16-M-A	STJCL 2020 K 16-M-A	6756611	SVPBL 2020 K 11	SVPBL 2020 K 11	6760334
SRDCN 1616 H 06	SRDCN 1616 H 06	6756811	STJCL 2525 M 16-M-A	STJCL 2525 M 16-M-A	6756612	SVPBR 1616 H 11	SVPBR 1616 H 11	6760335
SRDCN 2020 K 08	SRDCN 2020 K 08	6757097	STJCR 1616 H 11	STJCR 1616 H 11	6756806	SVPBR 2020 K 11	SVPBR 2020 K 11	6760336
SRDCN 2020 K 1003-M-A	SRDCN 2020 K 1003-M-A	6756875	STJCR 2020 K 16-M-A	STJCR 2020 K 16-M-A	6756613	SVPCL 2020 K 16-M-A	SVPCL 2020 K 16-M-A	6756625
SRDCN 2020 K 10-M-A	SRDCN 2020 K 10-M-A	6756588	STJCR 2525 M 16-M-A	STJCR 2525 M 16-M-A	6756614	SVPCL 2525 M 16-M-A	SVPCL 2525 M 16-M-A	6756626
SRDCN 2525 M 10-M-A	SRDCN 2525 M 10-M-A	6756589	SVACL 0808 K 13-DC	SVACL 0808 K 13-DC	6760606	SVPCL 3225 P 16-M-A	SVPCL 3225 P 16-M-A	6756627
SRDCN 2525 M 12-M-A	SRDCN 2525 M 12-M-A	6756590	SVACL 1010 L 13-DC	SVACL 1010 L 13-DC	6760832	SVPCL 2020 K 16-M-A	SVPCL 2020 K 16-M-A	6756628
SRDCN 3225 P 10-M	SRDCN 3225 P 10-M	6758436	SVACL 1212 L 13-DC	SVACL 1212 L 13-DC	6760609	SVPCL 2525 M 16-M-A	SVPCL 2525 M 16-M-A	6756629
SRDCN 3225 P 12-M	SRDCN 3225 P 12-M	6758437	SVACL 1616 M 13-DC	SVACL 1616 M 13-DC	6760833	SVPCL 3225 P 16-M-A	SVPCL 3225 P 16-M-A	6756630
SRDCN 3225 P 16-M	SRDCN 3225 P 16-M	6758444	SVACL 2020 M 13-DC	SVACL 2020 M 13-DC	6760835	SVPBR 08 2	SVPBR 08 2	6788696
SRDCR 2020 K 08-A	SRDCR 2020 K 08-A	6760489	SVACL 2525 M 13-DC	SVACL 2525 M 13-DC	6760611	SVPBR 12 2B	SVPBR 12 2B	6788697
SRDCR 2525 M 08-A	SRDCR 2525 M 08-A	6760490	SVACL 2525 M 16-M-A	SVACL 2525 M 16-M-A	6760831	SVPBR 12 3B	SVPBR 12 3B	6788698
SRDCR 3225 P 08-A	SRDCR 3225 P 08-A	6760491	SVACR 0808 K 13-DC	SVACR 0808 K 13-DC	6760607	SVPBR 1212 F 11	SVPBR 1212 F 11	6760337
SRSC 1212 F 06	SRSC 1212 F 06	6756994	SVACR 1010 L 13-DC	SVACR 1010 L 13-DC	6760607	SVPBR 16 3D	SVPBR 16 3D	6788699
SRSC 1616 H 06	SRSC 1616 H 06	6757213	SVACR 1212 L 13-DC	SVACR 1212 L 13-DC	6760608	SVPBR 1616 H 11	SVPBR 1616 H 11	6760338
SRSC 2020 K 08	SRSC 2020 K 08	6756889	SVACR 1616 M 13-DC	SVACR 1616 M 13-DC	6760610	SVPBR 20 3D	SVPBR 20 3D	6788700
SRSC 2020 K 10-M-A	SRSC 2020 K 10-M-A	6756591	SVACR 2020 M 13-DC	SVACR 2020 M 13-DC	6760834	SVPBR 2020 K 11	SVPBR 2020 K 11	6760339
SRSC 2525 M 10-M-A	SRSC 2525 M 10-M-A	6756592	SVACR 2525 M 13-DC	SVACR 2525 M 13-DC	6760836	SVPBR 2525 M 16-M-A	SVPBR 2525 M 16-M-A	6756631
SRSC 2525 M 12-M-A	SRSC 2525 M 12-M-A	6756593	SVGCL 0808 K 07	SVGCL 0808 K 07	6760750	SVPBR 3225 P 16-M-A	SVPBR 3225 P 16-M-A	6756630
SRSC 3225 P 10-M	SRSC 3225 P 10-M	6758439	SVGCL 1010 M 07	SVGCL 1010 M 07	6760751	SVPBR 08 2	SVPBR 08 2	6788696
SRSC 3225 P 12-M	SRSC 3225 P 12-M	6758441	SVGCL 1212 M 07	SVGCL 1212 M 07	6760752	SVPBR 12 2B	SVPBR 12 2B	6788697
			SVGCL 1616 P 07	SVGCL 1616 P 07	6760767	SVPBR 12 3B	SVPBR 12 3B	6788698
						SVPBR 1212 F 11	SVPBR 1212 F 11	6760337
						SVPBR 16 3D	SVPBR 16 3D	6788699
						SVPBR 1616 H 11	SVPBR 1616 H 11	6760338
						SVPBR 20 3D	SVPBR 20 3D	6788700
						SVPBR 2020 K 11	SVPBR 2020 K 11	6760339
						SVPBR 2525 M 16-M-A	SVPBR 2525 M 16-M-A	6756631
						SVPBR 3225 P 16-M-A	SVPBR 3225 P 16-M-A	6756630
						SVPBR 08 2	SVPBR 08 2	6788696
						SVPBR 12 2B	SVPBR 12 2B	6788697
						SVPBR 12 3B	SVPBR 12 3B	6788698
						SVPBR 1212 F 11	SVPBR 1212 F 11	6760337
						SVPBR 16 3D	SVPBR 16 3D	6788699
						SVPBR 1616 H 11	SVPBR 1616 H 11	6760338
						SVPBR 20 3D	SVPBR 20 3D	6788700
						SVPBR 2020 K 11	SVPBR 2020 K 11	6760339
						SVPBR 2525 M 16-M-A	SVPBR 2525 M 16-M-A	6756631
						SVPBR 3225 P 16-M-A	SVPBR 3225 P 16-M-A	6756630
						SVPBR 08 2	SVPBR 08 2	6788696
						SVPBR 12 2B	SVPBR 12 2B	6788697
</								

ANSI	ISO	EDP
SVVCN 2525 M 13	SVVCN 2525 M 13	6760447
SVVCN 2525 M 16-M-A	SVVCN 2525 M 16-M-A	6756632
SVVCN 3225 P 16-M-A	SVVCN 3225 P 16-M-A	6756633
SVXBL 1212 F 11	SVXBL 1212 F 11	6760340
SVXBL 1616 H 11	SVXBL 1616 H 11	6760341
SVXBR 1212 F 11	SVXBR 1212 F 11	6760342
SVXBR 1616 H 11	SVXBR 1616 H 11	6760343
SVXCL 2020 K 13	SVXCL 2020 K 13	6760448
SVXCL 2020 K 16-M-A	SVXCL 2020 K 16-M-A	6756634
SVXCL 2525 M 16-M-A	SVXCL 2525 M 16-M-A	6756635
SVXCL 3225 P 16-M-A	SVXCL 3225 P 16-M-A	6756636
SVXCR 2020 K 13	SVXCR 2020 K 13	6760449
SVXCR 2020 K 16-M-A	SVXCR 2020 K 16-M-A	6756637
SVXCR 2525 M 16-M-A	SVXCR 2525 M 16-M-A	6756638
SVXCR 3225 P 16-M-A	SVXCR 3225 P 16-M-A	6756639
SWLCL 12 3B	SWLCL 12 3B	6820323
SWLCL 16 4D	SWLCL 16 4D	6820324
SWLCL 1616 H 06	SWLCL 1616 H 06	6756995
SWLCL 2020 K 06	SWLCL 2020 K 06	6756798
SWLCL 2525 M 08	SWLCL 2525 M 08	6757190
SWLCR 12 3B	SWLCR 12 3B	6820325
SWLCR 16 4D	SWLCR 16 4D	6820326
SWLCR 1616 H 06	SWLCR 1616 H 06	6756786
SWLCR 2020 K 06	SWLCR 2020 K 06	6756809
SWLCR 2525 M 08	SWLCR 2525 M 08	6756766
VDI.30-AL.26	VDI.30-AL.26	7227860
VDI.30-AR.26	VDI.30-AR.26	7227857
VDI.30-B1.20.40	VDI.30-B1.20.40	7227765
VDI.30-B2.20.40	VDI.30-B2.20.40	7227768
VDI.30-B3.20.40	VDI.30-B3.20.40	7227821
VDI.30-B4.20.40	VDI.30-B4.20.40	7227824
VDI.30-B5.20.40	VDI.30-B5.20.40	7227827
VDI.30-B6.20.40	VDI.30-B6.20.40	7227830
VDI.30-B7.20.40	VDI.30-B7.20.40	7227833
VDI.30-B8.20.40	VDI.30-B8.20.40	7227836
VDI.30-C1.20	VDI.30-C1.20	7227839
VDI.30-C2.20	VDI.30-C2.20	7227842
VDI.30-C3.20	VDI.30-C3.20	7227845
VDI.30-C4.20	VDI.30-C4.20	7227848
VDI.30-D1.20	VDI.30-D1.20	7227851
VDI.30-D2.20	VDI.30-D2.20	7227854
VDI.30-E1.16	VDI.30-E1.16	7227876
VDI.30-E1.20	VDI.30-E1.20	7227877
VDI.30-E1.25	VDI.30-E1.25	7227878
VDI.30-E1.32	VDI.30-E1.32	7227879
VDI.30-E1.40	VDI.30-E1.40	7227880
VDI.30-E2.08	VDI.30-E2.08	7227892
VDI.30-E2.10	VDI.30-E2.10	7227893
VDI.30-E2.12	VDI.30-E2.12	7227894
VDI.30-E2.16	VDI.30-E2.16	7227895
VDI.30-E2.20	VDI.30-E2.20	7227896
VDI.30-E2.25	VDI.30-E2.25	7227897
VDI.30-E2.32	VDI.30-E2.32	7227898
VDI.30-F1.MT.1	VDI.30-F1.MT.1	7227914
VDI.30-F1.MT.2	VDI.30-F1.MT.2	7227915
VDI.30-F1.MT.3	VDI.30-F1.MT.3	7227916
VDI.40-AL.32	VDI.40-AL.32	7227861
VDI.40-AR.32	VDI.40-AR.32	7227858
VDI.40-B1.25.44	VDI.40-B1.25.44	7227766
VDI.40-B2.25.44	VDI.40-B2.25.44	7227769
VDI.40-B3.25.44	VDI.40-B3.25.44	7227822
VDI.40-B4.25.44	VDI.40-B4.25.44	7227825
VDI.40-B5.25.44	VDI.40-B5.25.44	7227828
VDI.40-B6.25.44	VDI.40-B6.25.44	7227831
VDI.40-B7.25.44	VDI.40-B7.25.44	7227834
VDI.40-B8.25.44	VDI.40-B8.25.44	7227837
VDI.40-C1.25	VDI.40-C1.25	7227840
VDI.40-C2.25	VDI.40-C2.25	7227843
VDI.40-C3.25	VDI.40-C3.25	7227846
VDI.40-C4.25	VDI.40-C4.25	7227849
VDI.40-D1.25	VDI.40-D1.25	7227852
VDI.40-D2.25	VDI.40-D2.25	7227855
VDI.40-E1.16	VDI.40-E1.16	7227881
VDI.40-E1.20	VDI.40-E1.20	7227882
VDI.40-E1.25	VDI.40-E1.25	7227883
VDI.40-E1.32	VDI.40-E1.32	7227884

ANSI	ISO	EDP
VDI.40-E1.40	VDI.40-E1.40	7227885
VDI.40-E2.08	VDI.40-E2.08	7227899
VDI.40-E2.10	VDI.40-E2.10	7227900
VDI.40-E2.12	VDI.40-E2.12	7227901
VDI.40-E2.16	VDI.40-E2.16	7227902
VDI.40-E2.20	VDI.40-E2.20	7227903
VDI.40-E2.25	VDI.40-E2.25	7227904
VDI.40-E2.32	VDI.40-E2.32	7227905
VDI.40-E2.40	VDI.40-E2.40	7227906
VDI.40-F1.MT.2	VDI.40-F1.MT.2	7227917
VDI.40-F1.MT.3	VDI.40-F1.MT.3	7227918
VDI.40-F1.MT.4	VDI.40-F1.MT.4	7227919
VDI.50-AL.32	VDI.50-AL.32	7227862
VDI.50-AR.32	VDI.50-AR.32	7227859
VDI.50-B1.32.55	VDI.50-B1.32.55	7227767
VDI.50-B2.32.55	VDI.50-B2.32.55	7227820
VDI.50-B3.32.55	VDI.50-B3.32.55	7227823
VDI.50-B4.32.55	VDI.50-B4.32.55	7227826
VDI.50-B5.32.55	VDI.50-B5.32.55	7227829
VDI.50-B6.32.55	VDI.50-B6.32.55	7227832
VDI.50-B7.32.55	VDI.50-B7.32.55	7227835
VDI.50-B8.32.55	VDI.50-B8.32.55	7227838
VDI.50-C1.32	VDI.50-C1.32	7227841
VDI.50-C2.32	VDI.50-C2.32	7227844
VDI.50-C3.32	VDI.50-C3.32	7227847
VDI.50-C4.32	VDI.50-C4.32	7227850
VDI.50-D1.32	VDI.50-D1.32	7227853
VDI.50-D2.32	VDI.50-D2.32	7227856
VDI.50-E1.16	VDI.50-E1.16	7227886
VDI.50-E1.20	VDI.50-E1.20	7227887
VDI.50-E1.25	VDI.50-E1.25	7227888
VDI.50-E1.32	VDI.50-E1.32	7227889
VDI.50-E1.40	VDI.50-E1.40	7227890
VDI.50-E1.50	VDI.50-E1.50	7227891
VDI.50-E2.12	VDI.50-E2.12	7227907
VDI.50-E2.16	VDI.50-E2.16	7227908
VDI.50-E2.20	VDI.50-E2.20	7227909
VDI.50-E2.25	VDI.50-E2.25	7227910
VDI.50-E2.32	VDI.50-E2.32	7227911
VDI.50-E2.40	VDI.50-E2.40	7227912
VDI.50-E2.50	VDI.50-E2.50	7227913
VDI.50-F1.MT.2	VDI.50-F1.MT.2	7227920
VDI.50-F1.MT.3	VDI.50-F1.MT.3	7227921
VDI.50-F1.MT.4	VDI.50-F1.MT.4	7227922
VDI.50-F1.MT.5	VDI.50-F1.MT.5	7227923
XLCDN 2525 R 15	XLCDN 2525 R 15	6759658
XLCFL 1612 H 03	XLCFL 1612 H 03	6756674
XLCFL 2016 K 03	XLCFL 2016 K 03	6756675
XLCFL 2016 K 04	XLCFL 2016 K 04	6757163
XLCFL 2520 K 03	XLCFL 2520 K 03	6757164
XLCFL 2520 K 04	XLCFL 2520 K 04	6756980
XLCFL 2520 K 05	XLCFL 2520 K 05	6756970
XLCFL 3225 P 05	XLCFL 3225 P 05	6757247
XLCFL 3225 P 06	XLCFL 3225 P 06	6757248
XLCFR 1612 H 03	XLCFR 1612 H 03	6756670
XLCFR 2016 K 03	XLCFR 2016 K 03	6756774
XLCFR 2016 K 04	XLCFR 2016 K 04	6756671
XLCFR 2520 K 03	XLCFR 2520 K 03	6756663
XLCFR 2520 K 04	XLCFR 2520 K 04	6756664
XLCFR 2520 K 05	XLCFR 2520 K 05	6756922
XLCFR 3225 P 05	XLCFR 3225 P 05	6756672
XLCFR 3225 P 06	XLCFR 3225 P 06	6756673

ANSI	ISO	EDP
037N1R106W062-SSD09	037N1R106W062-SSD09	6789706
062A2R094C062-ISAD11E-C	062A2R094C062-ISAD11E-C	6790623
062A2R106W062-ISAD11E-C	062A2R106W062-ISAD11E-C	6790625
062A2R197C062-ISAD11E-C	062A2R197C062-ISAD11E-C	6790626
062E2R118C062-ISBN10-C	062E2R118C062-ISBN10-C	7455279
062E2R197C062-ISBN10-C	062E2R197C062-ISBN10-C	7455290
062N2R106C062-SSD09	062N2R106C062-SSD09	6789707
062N2R106W062-SSD09	062N2R106W062-SSD09	6789708
075A2R114C075-ISAD11E-C	075A2R114C075-ISAD11E-C	6790628
075A2R114C075-ISTN10-C	075A2R114C075-ISTN10-C	7276931
075A2R125W075-ISTN10-C	075A2R125W075-ISTN10-C	7276925
075A2R126W075-ISAD11E-C	075A2R126W075-ISAD11E-C	6790629
075A2R276C075-ISAD11E-C	075A2R276C075-ISAD11E-C	6790700
075A3R114C075-ISAD11E-C	075A3R114C075-ISAD11E-C	6790702
075A3R114C075-ISTN10-C	075A3R114C075-ISTN10-C	7276932
075A3R125W075-ISTN10-C	075A3R125W075-ISTN10-C	7276926
075A3R126W075-ISAD11E-C	075A3R126W075-ISAD11E-C	6790703
075E2R175W075-ISR10-C	075E2R175W075-ISR10-C	6820353
075E2R250W075-ISR10-C	075E2R250W075-ISR10-C	6820354
075E2R325W100-ISR10-C	075E2R325W100-ISR10-C	6820355
075E2R400W100-ISR10-C	075E2R400W100-ISR10-C	6820356
075E2R475W100-ISR10-C	075E2R475W100-ISR10-C	6820357
075E3R157C075-ISBN10-C	075E3R157C075-ISBN10-C	7455291
075E3R157C075-ISBN10-C	075E3R157C075-ISBN10-C	7455292
075N2R126W075-ISSE09-C	075N2R126W075-ISSE09-C	6789712
08K2R025A10-SRC08-A	08K2R025A10-SRC08-A	6756690
08K2R050A12-SRC08-A	08K2R050A12-SRC08-A	6756718
1000C12R-IS45OE09Z-C	1000C12R-IS45OE09Z-C	7275075
1000C12R-IS57PN13	1000C12R-IS57PN13	6792993
1000C14R-IS45HN09CF	1000C14R-IS45HN09CF	6790728
100A05R-S57PN13	100A05R-S57PN13	6761667
100A05R-S90LN16-C	100A05R-S90LN16-C	6760312
100A05R-SMORC20-C	100A05R-SMORC20-C	7155925
100A06R-S19PD09-C	100A06R-S19PD09-C	6761262
100A06R-S45HN09C-CF	100A06R-S45HN09C-CF	6761571
100A06R-S45OE06Z-C	100A06R-S45OE06Z-C	6922504
100A06R-S45OE09Z-C	100A06R-S45OE09Z-C	7056832
100A06R-S90AD16E-C	100A06R-S90AD16E-C	6760187
100A06R-S90LN12-C	100A06R-S90LN12-C	6760293
100A06R-SMORC12-C	100A06R-SMORC12-C	7155899
100A06R-SMORC16-C	100A06R-SMORC16-C	7155922
100A06R-W90XO12	100A06R-W90XO12	6761754
100A07R-S45OD05-C	100A07R-S45OD05-C	7342887
100A07R-S45OD06D	100A07R-S45OD06D	6756818
100A07R-S45SN12Z-C	100A07R-S45SN12Z-C	6758342
100A07R-S90LN16-C	100A07R-S90LN16-C	6760313
100A07R-SCMORD16	100A07R-SCMORD16	6757638
100A08R-S19PD09-C	100A08R-S19PD09-C	6761263
100A08R-S45HN06C-C	100A08R-S45HN06C-C	6760273
100A08R-S45HN09C-CF	100A08R-S45HN09C-CF	6761572
100A08R-S45OE06Z-C	100A08R-S45OE06Z-C	6922505
100A08R-S45SE09F-C	100A08R-S45SE09F-C	6761669

ANSI	ISO	EDP
100A08R-S90AD16E-C	100A08R-S90AD16E-C	6760188
100A08R-S90LN12-C	100A08R-S90LN12-C	6760294
100A08R-S90SD12-C	100A08R-S90SD12-C	6760183
100A08R-SMOSN11-C	100A08R-SMOSN11-C	7799350
100A10R-C60HN09	100A10R-C60HN09	6761688
100A10R-S45HN09C-CF	100A10R-S45HN09C-CF	6761570
100A10R-S45SE09F-C	100A10R-S45SE09F-C	6761685
100A10R-S90SO09-C	100A10R-S90SO09-C	6758312
100A11R-S90AD11E-C	100A11R-S90AD11E-C	6760219
100A12R-S45HN06C-C	100A12R-S45HN06C-C	6760274
100A12R-W90XO12	100A12R-W90XO12	6761755
100A16R-C60HN09	100A16R-C60HN09	6761689
100A2R128W100-ISAD16E-C	100A2R128W100-ISAD16E-C	6798444
100A2R128W100-ISLN12-C	100A2R128W100-ISLN12-C	6792995
100A2R130C100-ISAD16E-C	100A2R130C100-ISAD16E-C	6798445
100A2R134C100-ISLN12-C	100A2R134C100-ISLN12-C	6792996
100A2R315C100-ISLN12-C	100A2R315C100-ISLN12-C	6792998
100A3R128W100-ISAD11E-C	100A3R128W100-ISAD11E-C	6790704
100A3R128W100-ISSO09-C	100A3R128W100-ISSO09-C	6789775
100A3R134C100-ISAD11E-C	100A3R134C100-ISAD11E-C	6790705
100A3R140C100-ISTN10-C	100A3R140C100-ISTN10-C	7276933
100A3R150W100-ISTN10-C	100A3R150W100-ISTN10-C	7276927
100A3R315C100-ISAD11E-C	100A3R315C100-ISAD11E-C	6790707
100A4R128W100-ISAD11E-C	100A4R128W100-ISAD11E-C	6790708
100A4R134C100-ISAD11E-C	100A4R134C100-ISAD11E-C	6790709
100A4R140C100-ISTN10-C	100A4R140C100-ISTN10-C	7276934
100A4R150W100-ISTN10-C	100A4R150W100-ISTN10-C	7276928
100B6R-S90AP16D	100B6R-S90AP16D	6757029
100B8R-S90AP16D	100B8R-S90AP16D	6757030
100E2R134C075-ISR10-C	100E2R134C075-ISR10-C	7455328
100E3R134C075-ISR10-C	100E3R134C075-ISR10-C	7455329
100E4R197C100-ISBN10-C	100E4R197C100-ISBN10-C	7455293
100E4R394C100-ISBN10-C	100E4R394C100-ISBN10-C	7455294
100E4R472C100-ISBN10-C	100E4R472C100-ISBN10-C	7455295
100E5R197C100-ISBN10-C	100E5R197C100-ISBN10-C	7455296
100G10N-S90SN12N10	100G10N-S90SN12N10	6758375
100G10N-S90SN12N12	100G10N-S90SN12N12	6758451
100G10N-S90SN12N6	100G10N-S90SN12N6	6758373
100G10N-S90SN12N8	100G10N-S90SN12N8	6758374
100J2R197W100-ISAD11E150	100J2R197W100-ISAD11E150	6790020
100N2R128W100-ISHN06C-C	100N2R128W100-ISHN06C-C	6792953
100N3R128C100-ISSD09	100N3R128C100-ISSD09	6789709
100N3R128W100-ISSD09	100N3R128W100-ISSD09	6789710
100N3R128W100-ISSE09-C	100N3R128W100-ISSE09-C	6789713
100T05R-S90AD16E80-C	100T05R-S90AD16E80-C	6922376
10A1R020B16-SAP10D-C	10A1R020B16-SAP10D-C	6758361
10A2R016A08-SAD07D-C	10A2R016A08-SAD07D-C	6798637
10A2R016A10-SAD07D-C	10A2R016A10-SAD07D-C	6798626

ANSI	ISO	EDP
10A2R018A08-SAD07D-CF	10A2R018A08-SAD07D-CF	7607332
10A2R018A10-SAD07D-CF	10A2R018A10-SAD07D-CF	7607333
10K2R030A12-SRC10-A	10K2R030A12-SRC10-A	6756691
10K2R060A16-SRC10-A	10K2R060A16-SRC10-A	6756719
10L2R030A10-SZP10	10L2R030A10-SZP10	7049114
10L2R050A16-SZP10	10L2R050A16-SZP10	6761626
10L2R050E02-SZP10	10L2R050E02-SZP10	6761646
10N1R027B16-SSD09-A	10N1R027B16-SSD09-A	6757762
10N1R030E02-SSD09-A	10N1R030E02-SSD09-A	6757761
110A06R-S90LN12-C	110A06R-S90LN12-C	6760295
115A08R-SMOSN11-C	115A08R-SMOSN11-C	7799351
1200C14R-IF60SB22X	1200C14R-IF60SB22X	6789687
1200C14R-IS45OE09Z-C	1200C14R-IS45OE09Z-C	7275076
1200C14R-IS57PN13	1200C14R-IS57PN13	6792992
1200C16R-IS45HN09CF	1200C16R-IS45HN09CF	6790729
125A05R-S45OE09Z-C	125A05R-S45OE09Z-C	7056833
125A06R-S45HN09C-CF	125A06R-S45HN09C-CF	6761575
125A06R-S57PN13	125A06R-S57PN13	6761673
125A06R-S90LN16-C	125A06R-S90LN16-C	6760314
125A06R-SMORC20-C	125A06R-SMORC20-C	6920717
125A07R-S45OE06Z-C	125A07R-S45OE06Z-C	6922506
125A07R-S45OE09Z-C	125A07R-S45OE09Z-C	7056834
125A07R-S90LN12-C	125A07R-S90LN12-C	6798612
125A07R-SMORC16-C	125A07R-SMORC16-C	6920715
125A08R-S19PD09-C	125A08R-S19PD09-C	7039765
125A08R-S45HN09C-CF	125A08R-S45HN09C-CF	7049097
125A08R-S45OD05-C	125A08R-S45OD05-C	7342888
125A08R-S45OD06D	125A08R-S45OD06D	6756819
125A08R-S45SN12Z-C	125A08R-S45SN12Z-C	6758343
125A08R-S90LN16-C	125A08R-S90LN16-C	6760315
125A08R-SMOSN11-C	125A08R-SMOSN11-C	7799352
125A08R-W90XO12	125A08R-W90XO12	6761756
125A09R-S45OE06Z-C	125A09R-S45OE06Z-C	6922507
125A09R-S45SE09F-C	125A09R-S45SE09F-C	6761670
125A09R-S90AD16E-C	125A09R-S90AD16E-C	6760189
125A09R-S90LN12-C	125A09R-S90LN12-C	6798613
125A09R-S90SD12-C	125A09R-S90SD12-C	6760184
125A10R-S19PD09-C	125A10R-S19PD09-C	6920711
125A10R-S45HN06C-C	125A10R-S45HN06C-C	6760275
125A10R-S45HN09C-CF	125A10R-S45HN09C-CF	6761574
125A12R-C60HN09	125A12R-C60HN09	6761690
125A12R-S45HN09C-CF	125A12R-S45HN09C-CF	6761573
125A12R-S45SE09F-C	125A12R-S45SE09F-C	6761699
125A12R-S90AD11E-C	125A12R-S90AD11E-C	6760220
125A12R-S90SO09-C	125A12R-S90SO09-C	6758313
125A15R-W90XO12	125A15R-W90XO12	6761758
125A16R-S45HN06C-C	125A16R-S45HN06C-C	6760276
125A20R-C60HN09	125A20R-C60HN09	6761691
125A2R134C125-ISLN12-C	125A2R134C125-ISLN12-C	6792999
125A2R354C125-ISLN12-C	125A2R354C125-ISLN12-C	6793011
125A3R130C125-ISAD16E-C	125A3R130C125-ISAD16E-C	6798446
125A3R150W125-ISAD16E-C	125A3R150W125-ISAD16E-C	6798447
125A3R150W125-ISLN12-C	125A3R150W125-ISLN12-C	6793012
125A3R354C125-ISAD11E-C	125A3R354C125-ISAD11E-C	6790711
125A4R146C125-ISTN10-C	125A4R146C125-ISTN10-C	7276935
125A4R150W125-ISAD11E-C	125A4R150W125-ISAD11E-C	6790712
125A4R150W125-ISSO09-C	125A4R150W125-ISSO09-C	6789776
125A4R150W125-ISTN10-C	125A4R150W125-ISTN10-C	7276929
125A5R134C125-ISAD11E-C	125A5R134C125-ISAD11E-C	6790714
125A5R146C125-ISTN10-C	125A5R146C125-ISTN10-C	7276936
125A5R150W125-ISAD11E-C	125A5R150W125-ISAD11E-C	6790715



ANSI	ISO	EDP
125A5R150W125-ISTN10-C	125A5R150W125-ISTN10-C	7276930
125B05R-F60SB22X	125B05R-F60SB22X	6759707
125B07R-F60SB22X	125B07R-F60SB22X	6758303
125B9R-S90AP16D	125B9R-S90AP16D	6757031
125E2R236C125-ISPD09-C	125E2R236C125-ISPD09-C	6792981
125E3R165C100-ISRC10-C	125E3R165C100-ISRC10-C	7455360
125E4R165C100-ISRC10-C	125E4R165C100-ISRC10-C	7455361
125E5R276C125-ISBN10-C	125E5R276C125-ISBN10-C	7455297
125E5R472C125-ISBN10-C	125E5R472C125-ISBN10-C	7455299
125E6R276C125-ISBN10-C	125E6R276C125-ISBN10-C	7455298
125H04N-S90CN10N18	125H04N-S90CN10N18	6760153
125H12N-S90SN12N10	125H12N-S90SN12N10	6758378
125H12N-S90SN12N12	125H12N-S90SN12N12	6758452
125H12N-S90SN12N6	125H12N-S90SN12N6	6758376
125H12N-S90SN12N8	125H12N-S90SN12N8	6758377
125J2R236W125-ISAD11E185	125J2R236W125-ISAD11E185	6790021
125N3R150W125-ISHN06C-C	125N3R150W125-ISHN06C-C	6792954
125N3R177C100-ISOD05-C	125N3R177C100-ISOD05-C	7546855
125N4R150W125-ISSE09-C	125N4R150W125-ISSE09-C	6789714
12A1R027B16-SAP10D-C	12A1R027B16-SAP10D-C	6758362
12A2R018A10-SAD07D-C	12A2R018A10-SAD07D-C	6798638
12A2R018A10-SSO050-C	12A2R018A10-SSO050-C	7342929
12A2R018A12-SAD07D-C	12A2R018A12-SAD07D-C	6798627
12A2R018A12-SSO050-C	12A2R018A12-SSO050-C	7342925
12A2R020A10-SCN05C-C	12A2R020A10-SCN05C-C	7636576
12A3R018A12-SAD07D-C	12A3R018A12-SAD07D-C	6798628
12A3R020A12-SAD07D-CF	12A3R020A12-SAD07D-CF	7607334
12K2R030A12-SLC12-A	12K2R030A12-SLC12-A	6756697
12K2R030A12-SRC12-A	12K2R030A12-SRC12-A	6756692
12K2R060A16-SRC12-A	12K2R060A16-SRC12-A	6756720
12L2R035A12-SZP12	12L2R035A12-SZP12	7049115
12L2R040B20-SZP12	12L2R040B20-SZP12	6761633
12L2R040E02-SZP12	12L2R040E02-SZP12	6761647
12L2R045A20-SZP12	12L2R045A20-SZP12	6761621
12L2R060B20-SZP12	12L2R060B20-SZP12	6761634
12L2R060E02-SZP12	12L2R060E02-SZP12	6761648
12L2R090E02-SZP12	12L2R090E02-SZP12	6761649
140A06R-S90LN16-C	140A06R-S90LN16-C	6760317
140A08R-S19PD09-C	140A08R-S19PD09-C	7049117
140A08R-S90AD16E-C	140A08R-S90AD16E-C	6800790
140B05R-F90TB27X	140B05R-F90TB27X	6759712
140B07R-F90TB27X	140B07R-F90TB27X	6758483
14A1R027B16-SAP10D-C	14A1R027B16-SAP10D-C	6758363
14A3R018A12-SAD07D-C	14A3R018A12-SAD07D-C	6798646
14A3R018A14-SAD07D-C	14A3R018A14-SAD07D-C	6798629
14A3R020A12-SAD07D-CF	14A3R020A12-SAD07D-CF	7607335
14A3R020A14-SAD07D-CF	14A3R020A14-SAD07D-CF	7607336
150A04R-IS45SE09F-C	150A04R-IS45SE09F-C	6789715
150A04R-IS90AD11E-C	150A04R-IS90AD11E-C	6790717
150A04R-IS90AD16E-C	150A04R-IS90AD16E-C	6798449
150A04R-IS90LN12-C	150A04R-IS90LN12-C	6793014
150A04R-IS90TN10-C	150A04R-IS90TN10-C	7276848
150A04R-ISMOSN11-C	150A04R-ISMOSN11-C	7800651

ANSI	ISO	EDP
150A05R-IS45HN06C-C	150A05R-IS45HN06C-C	6792926
150A05R-IS90SO09-C	150A05R-IS90SO09-C	6789777
150A05R-ISMOBN10-C	150A05R-ISMOBN10-C	7464859
150A05R-ISMORC10-C	150A05R-ISMORC10-C	7455508
150A06R-IS90AD11E-C	150A06R-IS90AD11E-C	6790718
150A06R-IS90TN10-C	150A06R-IS90TN10-C	7276849
150A07R-ISMOBN10-C	150A07R-ISMOBN10-C	7464890
150A3R160W125-ISAD16E-C	150A3R160W125-ISAD16E-C	6798480
150A4R160W125-ISAD16E-C	150A4R160W125-ISAD16E-C	6798481
150A4R160W125-ISLN12-C	150A4R160W125-ISLN12-C	6793016
150E3R236C125-ISPD09-C	150E3R236C125-ISPD09-C	6792949
150E4R315W125-ISZD12-C	150E4R315W125-ISZD12-C	6789770
150E4R551W125-ISZD12-C	150E4R551W125-ISZD12-C	6789771
150J3R276W125-ISAD11E220	150J3R276W125-ISAD11E220	6790022
150N3R177C125-ISOD05-C	150N3R177C125-ISOD05-C	7546856
150T03R-IS30XP16-C	150T03R-IS30XP16-C	6790025
150T03R-IS45XP16-C	150T03R-IS45XP16-C	6790026
150T03R-IS60XP16-C	150T03R-IS60XP16-C	6790027
15E2R040B16-SRD07	15E2R040B16-SRD07	6757611
15E2R060B16-SRD07	15E2R060B16-SRD07	6757612
15E2R080B20-SRD07	15E2R080B20-SRD07	6757613
15E2R100B20-SRD07	15E2R100B20-SRD07	6757614
15E2R120B25-SRD07	15E2R120B25-SRD07	6757615
160C06R-F60SB22X	160C06R-F60SB22X	6759708
160C06R-S45OE09Z-C	160C06R-S45OE09Z-C	7065600
160C07R-SMORC20-C	160C07R-SMORC20-C	7155926
160C08R-F60SB22X	160C08R-F60SB22X	6758304
160C08R-S45HN09C-CF	160C08R-S45HN09C-CF	7155951
160C08R-S45OE09Z-C	160C08R-S45OE09Z-C	7065601
160C08R-S57PN13	160C08R-S57PN13	6761674
160C08R-S90LN16-C	160C08R-S90LN16-C	7156001
160C08R-SMORC16-C	160C08R-SMORC16-C	7155923
160C09R-S45OD06D	160C09R-S45OD06D	6756820
160C09R-S45OE06Z-C	160C09R-S45OE06Z-C	6931703
160C10R-S45SE09F	160C10R-S45SE09F	6761671
160C10R-S45SN12Z	160C10R-S45SN12Z	6758357
160C10R-S90AD16E-C	160C10R-S90AD16E-C	7155929
160C10R-S90AP16D	160C10R-S90AP16D	6757032
160C10R-W90X012	160C10R-W90X012	6761759
160C12R-S45HN09C-CF	160C12R-S45HN09C-CF	7155952
160C12R-S45OE06Z-C	160C12R-S45OE06Z-C	6931704
160C12R-S90SD12	160C12R-S90SD12	6760185
160C14R-S45HN09C-CF	160C14R-S45HN09C-CF	7155953
160C14R-S45SE09F	160C14R-S45SE09F	6761700
160C16R-C60HN09	160C16R-C60HN09	6761692
160H05N-S90XN12N24	160H05N-S90XN12N24	6760157
160H06N-S90CN10N18	160H06N-S90CN10N18	6760152
160H15N-S90SN12N14	160H15N-S90SN12N14	6758383
160H16N-S90SN12N10	160H16N-S90SN12N10	6758381
160H16N-S90SN12N12	160H16N-S90SN12N12	6758382
160H16N-S90SN12N6	160H16N-S90SN12N6	6758379
160H16N-S90SN12N8	160H16N-S90SN12N8	6758380
16A2R024A14-SAD11E-C	16A2R024A14-SAD11E-C	6800792
16A2R024A16-SAD11E-C	16A2R024A16-SAD11E-C	6760210
16A2R027B16-SAD11E-C	16A2R027B16-SAD11E-C	6760196
16A2R030E02-SAD11E-C	16A2R030E02-SAD11E-C	6758928
16A2R032B16-SAP10D-C	16A2R032B16-SAP10D-C	6758364
16A2R050A16-SAD11E-C	16A2R050A16-SAD11E-C	6759683
16A3R019A14-SAD07D-C	16A3R019A14-SAD07D-C	6798639
16A3R019A16-SAD07D-C	16A3R019A16-SAD07D-C	6798630

ANSI	ISO	EDP
16A3R020A14-SCN05C-C	16A3R020A14-SCN05C-C	7636577
16A3R020A14-SSO050-C	16A3R020A14-SSO050-C	7343020
16A3R020A16-SSO050-C	16A3R020A16-SSO050-C	7342926
16A4R019A16-SAD07D-C	16A4R019A16-SAD07D-C	6798631
16E2R030A14-SBN10-C	16E2R030A14-SBN10-C	7452542
16E2R030A16-SBN10-C	16E2R030A16-SBN10-C	7259577
16E2R030A16-SZD07	16E2R030A16-SZD07	6760246
16E2R050A16-SBN10-C	16E2R050A16-SBN10-C	7452543
16E2R065A16-SZD07	16E2R065A16-SZD07	6760248
16K2R035A16-SLC16-A	16K2R035A16-SLC16-A	6756698
16K2R035A16-SRC16-A	16K2R035A16-SRC16-A	6756693
16K2R065A20-SRC16-A	16K2R065A20-SRC16-A	6756721
16K3R050A16-CXP16	16K3R050A16-CXP16	6761723
16K3R050A20-CXP16	16K3R050A20-CXP16	6761724
16K3R060B20-CXP16	16K3R060B20-CXP16	6761727
16L2R040A16-SZP16-C	16L2R040A16-SZP16-C	7049116
16L2R040B20-SZP16-C	16L2R040B20-SZP16-C	6761635
16L2R040E02-SZP16	16L2R040E02-SZP16	6761650
16L2R045A20-SZP16-C	16L2R045A20-SZP16-C	6761627
16L2R060B20-SZP16-C	16L2R060B20-SZP16-C	6761636
16L2R060E02-SZP16	16L2R060E02-SZP16	6761651
16L2R090E02-SZP16	16L2R090E02-SZP16	6761652
16N2R027A16-SSD09	16N2R027A16-SSD09	6757771
16N2R027B16-SSD09-A	16N2R027B16-SSD09-A	6757763
16N2R027B16-SSO09-C	16N2R027B16-SSO09-C	6758333
16N2R030E02-SSD09-A	16N2R030E02-SSD09-A	6757798
175C06R-F90TB27X	175C06R-F90TB27X	6759713
175C08R-F90TB27X	175C08R-F90TB27X	6758484
175C08R-S90LN16-C	175C08R-S90LN16-C	7156002
175C10R-S90AD16E-C	175C10R-S90AD16E-C	7155950
18A2R029A20-SAD11E-C	18A2R029A20-SAD11E-C	6760318
18A2R032B20-SAP10D-C	18A2R032B20-SAP10D-C	6758365
18A2R050A20-STN10-C	18A2R050A20-STN10-C	7178465
18A4R019A16-SAD07D-C	18A4R019A16-SAD07D-C	6798640
18A4R019A18-SAD07D-C	18A4R019A18-SAD07D-C	6798632
18E2R030A16-SBN10-C	18E2R030A16-SBN10-C	7452544
200A03R-IS90AD16E-C	200A03R-IS90AD16E-C	6798483
200A04R-IS19PD09-C	200A04R-IS19PD09-C	6792982
200A04R-IS45HN06C-C	200A04R-IS45HN06C-C	6792927
200A04R-IS45HN09C-CF	200A04R-IS45HN09C-CF	6790760
200A04R-IS45OD05-C	200A04R-IS45OD05-C	7546797
200A04R-IS45OE06Z-C	200A04R-IS45OE06Z-C	7216301
200A04R-IS90LN12-C	200A04R-IS90LN12-C	6793017
200A04R-ISMOZD12-C	200A04R-ISMOZD12-C	6789772
200A05R-IS45OD05-C	200A05R-IS45OD05-C	7546798
200A05R-IS45OE06Z-C	200A05R-IS45OE06Z-C	7216302
200A05R-IS45SE09F-C	200A05R-IS45SE09F-C	6789716
200A05R-IS90AD11E-C	200A05R-IS90AD11E-C	6790721
200A05R-IS90AD16E-C	200A05R-IS90AD16E-C	6798484
200A05R-IS90LN12-C	200A05R-IS90LN12-C	6793018
200A05R-IS90TN10-C	200A05R-IS90TN10-C	7276920
200A05R-ISCMORD12-C	200A05R-ISCMORD12-C	6820327
200A05R-ISMORC10-C	200A05R-ISMORC10-C	7455509
200A05R-ISMOSN11-C	200A05R-ISMOSN11-C	7800652
200A06R-IS45HN06C-C	200A06R-IS45HN06C-C	6792928
200A06R-IS90SO09-C	200A06R-IS90SO09-C	6789778
200A06R-ISMORC10-C	200A06R-ISMORC10-C	7455530
200A06R-ISMOSN11-C	200A06R-ISMOSN11-C	7800653
200A07R-IS90AD11E-C	200A07R-IS90AD11E-C	6790722
200A07R-IS90TN10-C	200A07R-IS90TN10-C	7276921
200C08R-F60SB22X	200C08R-F60SB22X	6759709
200C08R-S45OE09Z-C	200C08R-S45OE09Z-C	7065602
200C10R-F60SB22X	200C10R-F60SB22X	6758305
200C10R-S45HN09C-CF	200C10R-S45HN09C-CF	7155954
200C10R-S45OE09Z-C	200C10R-S45OE09Z-C	7065603
200C10R-S57PN13	200C10R-S57PN13	6761675
200C11R-S45OE06Z-C	200C11R-S45OE06Z-C	6931705
200C12R-S45SN12Z	200C12R-S45SN12Z	6758446

ANSI	ISO	EDP
200C12R-W90XO12	200C12R-W90XO12	6761761
200C14R-S45OE06Z-C	200C14R-S45OE06Z-C	6931706
200C20R-C60HN09	200C20R-C60HN09	6761694
200J06N-S90XN12N24	200J06N-S90XN12N24	6760156
200J06N-S90XN16N30	200J06N-S90XN16N30	6760160
200J07N-S90CN10N18	200J07N-S90CN10N18	6760151
200J18N-S90SN12N10	200J18N-S90SN12N10	6758455
200J18N-S90SN12N12	200J18N-S90SN12N12	6758456
200J18N-S90SN12N14	200J18N-S90SN12N14	6758457
200J18N-S90SN12N6	200J18N-S90SN12N6	6758453
200J18N-S90SN12N8	200J18N-S90SN12N8	6758454
200J3R394CA50-ISAD16E213	200J3R394CA50-ISAD16E213	7276988
200J3R551CA50-ISAD16E315	200J3R551CA50-ISAD16E315	7276989
200T03R-IS90AD11E146-C	200T03R-IS90AD11E146-C	6790023
200T03R-IS90AD16E163-C	200T03R-IS90AD16E163-C	7276982
200T04R-IS30XP16-C	200T04R-IS30XP16-C	6790028
200T04R-IS45XP16-C	200T04R-IS45XP16-C	6790029
200T04R-IS60XP16-C	200T04R-IS60XP16-C	6790070
20A2R029A20-SAD11E-C	20A2R029A20-SAD11E-C	6760211
20A2R029A20-STN10-C	20A2R029A20-STN10-C	7178466
20A2R032B20-SAD11E-C	20A2R032B20-SAD11E-C	6760205
20A2R032B20-SSO09-C	20A2R032B20-SSO09-C	6758358
20A2R032B20-STN10-C	20A2R032B20-STN10-C	7178494
20A2R070A20-SAD11E-C	20A2R070A20-SAD11E-C	6759684
20A3R020A18-SWN04C-C	20A3R020A18-SWN04C-C	7636661
20A3R029A18-SAD11E-C	20A3R029A18-SAD11E-C	6800795
20A3R029A20-SAD11E-C	20A3R029A20-SAD11E-C	6760212
20A3R029A20-STN10-C	20A3R029A20-STN10-C	7174636
20A3R032B20-SAD11E-C	20A3R032B20-SAD11E-C	6760206
20A3R032B20-SAP10D-C	20A3R032B20-SAP10D-C	6758366
20A3R032B20-STN10-C	20A3R032B20-STN10-C	7178495
20A3R035E03-SAD11E-C	20A3R035E03-SAD11E-C	6758929
20A4R020A18-SAD07D-C	20A4R020A18-SAD07D-C	6798641
20A4R020A18-SSO05O-C	20A4R020A18-SSO05O-C	7343021
20A4R020A20-SAD07D-C	20A4R020A20-SAD07D-C	6798633
20A4R020A20-SSO05O-C	20A4R020A20-SSO05O-C	7342927
20A4R032B20-SSO05O-C	20A4R032B20-SSO05O-C	7343022
20A5R020A18-SCN05C-C	20A5R020A18-SCN05C-C	7636578
20A5R020A20-SAD07D-C	20A5R020A20-SAD07D-C	6798634
20E2R040B20-SRD10	20E2R040B20-SRD10	6757616
20E2R060B20-SRD10	20E2R060B20-SRD10	6757617
20E2R080B25-SRD10	20E2R080B25-SRD10	6757618
20E2R100B25-SRD10	20E2R100B25-SRD10	6757619
20E2R120B25-SRD10	20E2R120B25-SRD10	6757620
20E3R040A18-SBN10-C	20E3R040A18-SBN10-C	7259579
20E3R040A20-SBN10-C	20E3R040A20-SBN10-C	7259578
20E3R040A20-SZD07	20E3R040A20-SZD07	6760249
20E3R080A20-SBN10-C	20E3R080A20-SBN10-C	7452455
20E3R080A20-SZD07	20E3R080A20-SZD07	6760250
20E4R040A20-SBN10-C	20E4R040A20-SBN10-C	7455018
20K2R045A20-SLC20-A	20K2R045A20-SLC20-A	6756699
20K2R045A20-SRC20-A	20K2R045A20-SRC20-A	6756694
20K2R080A25-SRC20-A	20K2R080A25-SRC20-A	6756722
20K3R050A20-CXP20	20K3R050A20-CXP20	6761728
20K3R060A25-CXP20	20K3R060A25-CXP20	6761729
20K3R070B25-CXP20	20K3R070B25-CXP20	6761731
20L2R050A20-SZP20-C	20L2R050A20-SZP20-C	6761622

ANSI	ISO	EDP
20L2R050B25-SZP20-C	20L2R050B25-SZP20-C	6761637
20L2R050E03-SZP20	20L2R050E03-SZP20	6761653
20L2R055A25-SZP20-C	20L2R055A25-SZP20-C	6761628
20L2R055A32-SZP20-C	20L2R055A32-SZP20-C	6761629
20L2R070B25-SZP20-C	20L2R070B25-SZP20-C	6761638
20L2R070E03-SZP20	20L2R070E03-SZP20	6761654
20L2R100E03-SZP20	20L2R100E03-SZP20	6761655
20N2R032B20-SSE09-C	20N2R032B20-SSE09-C	6758314
210C08R-F90TB27X	210C08R-F90TB27X	6759714
210C10R-F90TB27X	210C10R-F90TB27X	6758485
22A3R029A20-SAD11E-C	22A3R029A20-SAD11E-C	6923283
22A3R050A25-STN10-C	22A3R050A25-STN10-C	7178467
2416-20R-E3-P	2416-20R-E3-P	6757683
2416-25R-E3-P	2416-25R-E3-P	6757801
2416-32R-E4-P	2416-32R-E4-P	6757684
2416-40R-E4-P	2416-40R-E4-P	6757743
250A04R-IS45OE06Z-C	250A04R-IS45OE06Z-C	7270034
250A04R-IS90AD16E-C	250A04R-IS90AD16E-C	6798485
250A04R-IS90LN12-C	250A04R-IS90LN12-C	6793019
250A04R-ISCMORD16-C	250A04R-ISCMORD16-C	6820340
250A05R-IS19PD09-C	250A05R-IS19PD09-C	6792980
250A05R-IS45OD05-C	250A05R-IS45OD05-C	7546799
250A05R-IS45SE09F-C	250A05R-IS45SE09F-C	6789717
250A05R-ISMOZD12-C	250A05R-ISMOZD12-C	6789773
250A06R-IS45HN06C-C	250A06R-IS45HN06C-C	6792929
250A06R-IS45HN09C-CF	250A06R-IS45HN09C-CF	6790761
250A06R-IS45OD05-C	250A06R-IS45OD05-C	7546850
250A06R-IS45OE06Z-C	250A06R-IS45OE06Z-C	7270035
250A06R-IS45SE09F-C	250A06R-IS45SE09F-C	6789718
250A06R-IS90AD11E-C	250A06R-IS90AD11E-C	6790723
250A06R-IS90AD16E-C	250A06R-IS90AD16E-C	6798486
250A06R-IS90LN12-C	250A06R-IS90LN12-C	6793020
250A06R-IS90TN10-C	250A06R-IS90TN10-C	7276922
250A06R-ISCMORD12-C	250A06R-ISCMORD12-C	6820328
250A06R-ISMORC10-C	250A06R-ISMORC10-C	7455531
250A06R-ISMOSN11-C	250A06R-ISMOSN11-C	7800654
250A07R-IS90SO09-C	250A07R-IS90SO09-C	6789779
250A07R-ISMORC10-C	250A07R-ISMORC10-C	7455532
250A08R-IS45HN06C-C	250A08R-IS45HN06C-C	6792950
250A08R-ISMOSN11-C	250A08R-ISMOSN11-C	7800655
250A09R-IS90AD11E-C	250A09R-IS90AD11E-C	6790724
250A09R-IS90TN10-C	250A09R-IS90TN10-C	7276923
250C09R-F60SB22X	250C09R-F60SB22X	6759710
250C12R-F60SB22X	250C12R-F60SB22X	6758306
250C12R-S45OE09Z-C	250C12R-S45OE09Z-C	7065604
250C12R-S57PN13	250C12R-S57PN13	6761676
250C14R-S45HN09C-CF	250C14R-S45HN09C-CF	7155955
250C16R-S45SN12Z	250C16R-S45SN12Z	6758447
250C16R-W90XO12	250C16R-W90XO12	6761763
250C24R-C60HN09	250C24R-C60HN09	6761696
250C40R-C60HN09	250C40R-C60HN09	6761697
250J08N-S90XN12N24	250J08N-S90XN12N24	6760155
250J08N-S90XN16N30	250J08N-S90XN16N30	6760159
250J09N-S90CN10N18	250J09N-S90CN10N18	6760150
250J3R551CA50-ISAD16E268	250J3R551CA50-ISAD16E268	7277020
250J3R610CA50-ISAD16E374	250J3R610CA50-ISAD16E374	7277021
250T04R-IS90AD16E163-C	250T04R-IS90AD16E163-C	7276983
250T04R-IS90AD16E268-C	250T04R-IS90AD16E268-C	7276984
2516-45-11	2516-45-11	6758330
2516-45-19	2516-45-19	6758331
25A2R033A25-SAD16E-C	25A2R033A25-SAD16E-C	6760181
25A2R034A25-SLN12-C	25A2R034A25-SLN12-C	6760296
25A2R038A25-SAD16E-C	25A2R038A25-SAD16E-C	6800793
25A2R042B25-SAD16E-C	25A2R042B25-SAD16E-C	6760169
25A2R042B25-SAP16D-C	25A2R042B25-SAP16D-C	6758369
25A2R042B25-SLN12-C	25A2R042B25-SLN12-C	6760300

ANSI	ISO	EDP
25A2R043E03-SAD16E-C	25A2R043E03-SAD16E-C	6758505
25A2R080A25-SLN12-C	25A2R080A25-SLN12-C	6760297
25A3R034A25-SAD11E-C	25A3R034A25-SAD11E-C	6760213
25A3R034A25-STN10-C	25A3R034A25-STN10-C	7178468
25A3R040A25-CAD15-C	25A3R040A25-CAD15-C	6761703
25A3R042B25-SAD11E-C	25A3R042B25-SAD11E-C	6760197
25A3R042B25-SAP10D-C	25A3R042B25-SAP10D-C	6758448
25A3R042B25-SSO09-C	25A3R042B25-SSO09-C	6758359
25A3R042B25-STN10-C	25A3R042B25-STN10-C	7178496
25A3R080A25-SAD11E-C	25A3R080A25-SAD11E-C	6759682
25A4R020A22-SWN04C-C	25A4R020A22-SWN04C-C	7636662
25A4R034A25-SAD11E-C	25A4R034A25-SAD11E-C	6760214
25A4R034A25-STN10-C	25A4R034A25-STN10-C	7178469
25A4R040A25-SAD11E-C	25A4R040A25-SAD11E-C	7049093
25A4R042B25-SAD11E-C	25A4R042B25-SAD11E-C	6760207
25A4R042B25-STN10-C	25A4R042B25-STN10-C	7178497
25A4R043E03-SAD11E-C	25A4R043E03-SAD11E-C	6758930
25A5R024A25-SAD07D-C	25A5R024A25-SAD07D-C	6798635
25A5R024A25-SSO05O-C	25A5R024A25-SSO05O-C	7342928
25A5R042B25-SSO05O-C	25A5R042B25-SSO05O-C	7343023
25A6R024A25-SAD07D-C	25A6R024A25-SAD07D-C	6798636
25E2R034A20-SRC10-C	25E2R034A20-SRC10-C	7444097
25E2R080B25-SZD09-C	25E2R080B25-SZD09-C	6759694
25E2R140B25-SZD09-C	25E2R140B25-SZD09-C	6759695
25E2R240B25-SZD09-C	25E2R240B25-SZD09-C	6759696
25E3R034A20-SRC10-C	25E3R034A20-SRC10-C	7444098
25E3R050A25-SZD07	25E3R050A25-SZD07	6760247
25E3R100A25-SZD07	25E3R100A25-SZD07	6760245
25E4R050A22-SBN10-C	25E4R050A22-SBN10-C	7259720
25E4R050A25-SBN10-C	25E4R050A25-SBN10-C	7452546
25E4R100A25-SBN10-C	25E4R100A25-SBN10-C	7452547
25E5R050A25-SBN10-C	25E5R050A25-SBN10-C	7253577
25F1R030B25-SCC06-C	25F1R030B25-SCC06-C	6758317
25J2R50B25-SAD11E38-C	25J2R50B25-SAD11E38-C	6759643
25J2R55E03-SAD11E38-C	25J2R55E03-SAD11E38-C	6759647
25K2R045A25-SRC25-A	25K2R045A25-SRC25-A	6756695
25K3R060A25-CXP25	25K3R060A25-CXP25	6761732
25K3R080B25-CXP25	25K3R080B25-CXP25	6761734
25L2R060A25-SZP25-C	25L2R060A25-SZP25-C	6761630
25L2R060B25-SZP25-C	25L2R060B25-SZP25-C	6761639
25L2R065A32-SZP25-C	25L2R065A32-SZP25-C	6761631
25L2R080B25-SZP25-C	25L2R080B25-SZP25-C	6761640
25L2R080E03-SZP25	25L2R080E03-SZP25	6761656
25L2R110E04-SZP25	25L2R110E04-SZP25	6761657
25N2R042B25-SHN06C-C	25N2R042B25-SHN06C-C	6760283
25N3R042A25-SSD09	25N3R042A25-SSD09	6757772
25N3R042B25-SSD09-A	25N3R042B25-SSD09-A	6757764
25N3R042B25-SSE09-C	25N3R042B25-SSE09-C	6758315
25N3R040A25-SSO09-C	25N3R040A25-SSO09-C	6758334
25N3R043E03-SSD09-A	25N3R043E03-SSD09-A	6757829
260C10R-F90TB27X	260C10R-F90TB27X	6759715
260C12R-F90TB27X	260C12R-F90TB27X	6758486
300A05R-IS19PD09-C	300A05R-IS19PD09-C	6792983
300A05R-IS45OE06Z-C	300A05R-IS45OE06Z-C	7274857
300A05R-IS45OE09Z-C	300A05R-IS45OE09Z-C	7275038
300A05R-IS90AD16E-C	300A05R-IS90AD16E-C	6798487
300A05R-IS90LN12-C	300A05R-IS90LN12-C	6793021
300A05R-ISCMORD16-C	300A05R-ISCMORD16-C	6820341
300A05R-ISMOZD12-C	300A05R-ISMOZD12-C	6789774
300A06R-IS45HN09C-CF	300A06R-IS45HN09C-CF	6790762

ANSI	ISO	EDP
300A06R-IS45OD05-C	300A06R-IS45OD05-C	7546851
300A06R-IS45OE06Z-C	300A06R-IS45OE06Z-C	7274858
300A06R-IS45SE09F-C	300A06R-IS45SE09F-C	6789719
300A07R-IS45HN06C-C	300A07R-IS45HN06C-C	6792951
300A07R-IS90AD16E-C	300A07R-IS90AD16E-C	6798488
300A07R-IS90LN12-C	300A07R-IS90LN12-C	6793022
300A07R-ISCMORD12-C	300A07R-ISCMORD12-C	6820329
300A07R-ISMOSN11-C	300A07R-ISMOSN11-C	7800656
300A08R-IS45HN09C-CF	300A08R-IS45HN09C-CF	6790763
300A08R-IS45OD05-C	300A08R-IS45OD05-C	7546852
300A08R-IS45SE09F-C	300A08R-IS45SE09F-C	6789740
300A09R-IS90SO09-C	300A09R-IS90SO09-C	6789780
300A09R-ISMOSN11-C	300A09R-ISMOSN11-C	7800657
300A10R-IS45HN06C-C	300A10R-IS45HN06C-C	6792952
300A10R-IS90AD11E-C	300A10R-IS90AD11E-C	6790725
300A10R-IS90TN10-C	300A10R-IS90TN10-C	7276924
300F04N-IS90SN11N2.5	300F04N-IS90SN11N2.5	6789672
300F04N-IS90SN12N4	300F04N-IS90SN12N4	6789673
300F04N-IS90SN12N5	300F04N-IS90SN12N5	6789674
300J4R65OCA50-ISAD16E425	300J4R65OCA50-ISAD16E425	7277022
300T04R-IS90AD16E217-C	300T04R-IS90AD16E217-C	7276985
300T04R-IS90AD16E315-C	300T04R-IS90AD16E315-C	7276986
30A3R080A32-SAD11E-C	30A3R080A32-SAD11E-C	7049094
30A4R050A32-STN10-C	30A4R050A32-STN10-C	7178490
315C11R-F60S22X	315C11R-F60S22X	6759711
315C14R-F60S22X	315C14R-F60S22X	6758113
315C14R-S45OE09Z-C	315C14R-S45OE09Z-C	7065605
315C14R-S57PN13	315C14R-S57PN13	6761677
315C16R-S45HN09C-CF	315C16R-S45HN09C-CF	7155956
315C20R-W90XO12	315C20R-W90XO12	6761765
315J12N-S90CN12N24	315J12N-S90CN12N24	6760154
315J12N-S90CN10N18	315J12N-S90CN10N18	6760149
315K10N-S90XN16N30	315K10N-S90XN16N30	6760158
32A04R-S45SE09F-C	32A04R-S45SE09F-C	6761701
32A06R-S90SO05O-C	32A06R-S90SO05O-C	7343026
32A2R034A32-SLN12-C	32A2R034A32-SLN12-C	6760298
32A2R045A25-SVC22C	32A2R045A25-SVC22C	6759789
32A2R090A32-SLN12-C	32A2R090A32-SLN12-C	6760299
32A3R033A32-SAD16E-C	32A3R033A32-SAD16E-C	6760186
32A3R040B32-SAD16E-C	32A3R040B32-SAD16E-C	6760170
32A3R040B32-SAP16D-C	32A3R040B32-SAP16D-C	6758370
32A3R042B32-SLN12-C	32A3R042B32-SLN12-C	6760301
32A3R043E03-SAD16E-C	32A3R043E03-SAD16E-C	6758506
32A3R048A32-SAD16E-C	32A3R048A32-SAD16E-C	6800794
32A3R090A32-SAD11E-C	32A3R090A32-SAD11E-C	6759685
32A4R037A32-STN10-C	32A4R037A32-STN10-C	7178491
32A4R042B32-SAD11E-C	32A4R042B32-SAD11E-C	6760208
32A4R042B32-SSO09-C	32A4R042B32-SSO09-C	6758360
32A4R042B32-STN10-C	32A4R042B32-STN10-C	7178498
32A5R034A32-SAD11E-C	32A5R034A32-SAD11E-C	6760215
32A5R037A32-STN10-C	32A5R037A32-STN10-C	7178492
32A5R040A32-CAD15-C	32A5R040A32-CAD15-C	6761705
32A5R042B32-SAD11E-C	32A5R042B32-SAD11E-C	6760209
32A5R042B32-STN10-C	32A5R042B32-STN10-C	7178499
32A6R020A25-SWN04C-C	32A6R020A25-SWN04C-C	7636663
32A6R042B32-SSO05O-C	32A6R042B32-SSO05O-C	7343024
32E2R060A32-SPD09-C	32E2R060A32-SPD09-C	6920665
32E2R080B32-SZD09-C	32E2R080B32-SZD09-C	6759697
32E2R140B32-SZD09-C	32E2R140B32-SZD09-C	6759698
32E2R240B32-SZD09-C	32E2R240B32-SZD09-C	6759699
32E3R040M16-SSN11-C	32E3R040M16-SSN11-C	7799394

ANSI	ISO	EDP
32E3R042A25-SRC10-C	32E3R042A25-SRC10-C	7444200
32E3R070A32-SSN11-C	32E3R070A32-SSN11-C	7799390
32E3R120A32-SSN11-C	32E3R120A32-SSN11-C	7799391
32E4R042A25-SRC10-C	32E4R042A25-SRC10-C	7444099
32E5R070A32-SBN10-C	32E5R070A32-SBN10-C	7452548
32E5R120A32-SBN10-C	32E5R120A32-SBN10-C	7259721
32E6R070A32-SBN10-C	32E6R070A32-SBN10-C	7452549
32F1R038B32-SCC08-C	32F1R038B32-SCC08-C	6758318
32J2R60B32-SAD11E47-C	32J2R60B32-SAD11E47-C	6759644
32J2R65E04-SAD11E47-C	32J2R65E04-SAD11E47-C	6759648
32K2R060A32-SRC32-A	32K2R060A32-SRC32-A	6756696
32K3R080A32-CXP32	32K3R080A32-CXP32	6761735
32L2R070A32-SZP32-C	32L2R070A32-SZP32-C	6761632
32L2R070B32-SZP32-C	32L2R070B32-SZP32-C	6761641
32L2R100B32-SZP32-C	32L2R100B32-SZP32-C	6761642
32L2R100E04-SZP32	32L2R100E04-SZP32	6761658
32L2R150E04-SZP32	32L2R150E04-SZP32	6761659
32N3R042B32-SHN06C-C	32N3R042B32-SHN06C-C	6760284
32N3R045A25-SOD05-C	32N3R045A25-SOD05-C	7342889
32N4R042B32-SSE09-C	32N4R042B32-SSE09-C	6758316
35A5R025A32-SAD11E-C	35A5R025A32-SAD11E-C	7049095
35A5R080A32-STN10-C	35A5R080A32-STN10-C	7178493
35E3R040M16-SSN11-C	35E3R040M16-SSN11-C	7799395
35E3R050A32-SSN11-C	35E3R050A32-SSN11-C	7799393
35E5R050A32-SBN10-C	35E5R050A32-SBN10-C	7452550
35E6R050A32-SBN10-C	35E6R050A32-SBN10-C	7452551
35T03R-S15XP1607-C	35T03R-S15XP1607-C	6760360
35T03R-S25XP1612-C	35T03R-S25XP1612-C	6760347
35T03R-S30XP1614-C	35T03R-S30XP1614-C	6760355
35T03R-S35XP1616-C	35T03R-S35XP1616-C	6760354
35T03R-S40XP1618-C	35T03R-S40XP1618-C	6760362
35T03R-S45XP1620-C	35T03R-S45XP1620-C	6760353
35T03R-S50XP1622-C	35T03R-S50XP1622-C	6760361
35T03R-S55XP1623-C	35T03R-S55XP1623-C	6760363
35T03R-S60XP1625-C	35T03R-S60XP1625-C	6760364
400A05R-IS57PN13	400A05R-IS57PN13	6792988
400A06R-IS19PD09-C	400A06R-IS19PD09-C	6792984
400A06R-IS45HN09C-CF	400A06R-IS45HN09C-CF	6790764
400A06R-IS45OE06Z-C	400A06R-IS45OE06Z-C	7274859
400A06R-IS45OE09Z-C	400A06R-IS45OE09Z-C	7275039
400A06R-IS90AD16E-C	400A06R-IS90AD16E-C	6798489
400A06R-IS90LN12-C	400A06R-IS90LN12-C	6793023
400A06R-ISCMORD16-C	400A06R-ISCMORD16-C	6820342
400A07R-IS45OD05-C	400A07R-IS45OD05-C	7546853
400A08R-IS19PD09-C	400A08R-IS19PD09-C	6792985
400A08R-IS45HN06C-C	400A08R-IS45HN06C-C	6792922
400A08R-IS45HN09C-CF	400A08R-IS45HN09C-CF	6790765
400A08R-IS45OE06Z-C	400A08R-IS45OE06Z-C	7275030
400A08R-IS45OE09F-C	400A08R-IS45OE09F-C	6789741
400A08R-IS90AD16E-C	400A08R-IS90AD16E-C	6798490
400A08R-IS90LN12-C	400A08R-IS90LN12-C	6793024
400A08R-ISMOSN11-C	400A08R-ISMOSN11-C	7800658
400A10R-IS45HN09C-CF	400A10R-IS45HN09C-CF	6790766
400A10R-IS45SE09F-C	400A10R-IS45SE09F-C	6789742
400A10R-IS90SO09-C	400A10R-IS90SO09-C	6789781
400A11R-IS90AD11E-C	400A11R-IS90AD11E-C	6790726
400A12R-IS45HN06C-C	400A12R-IS45HN06C-C	6792923
400G05N-IS90SN12N4	400G05N-IS90SN12N4	6789676
400G05N-IS90SN12N5	400G05N-IS90SN12N5	6789677
400G05N-IS90SN12N6	400G05N-IS90SN12N6	6789678
400T05R-IS90AD16E315-C	400T05R-IS90AD16E315-C	7276987
40A03R-S45OD05-C	40A03R-S45OD05-C	7342880
40A03R-S45SN12Z-C	40A03R-S45SN12Z-C	6758338
40A03R-SMORC12-C	40A03R-SMORC12-C	7155895
40A03R-SMOZD09-C	40A03R-SMOZD09-C	6759665
40A04R-S45SE09F-C	40A04R-S45SE09F-C	6761698
40A04R-S90AD11E-C	40A04R-S90AD11E-C	6760198
40A04R-S90AD16E-C	40A04R-S90AD16E-C	6761295
40A04R-S90LN12-C	40A04R-S90LN12-C	6760288
40A04R-S90TN10-C	40A04R-S90TN10-C	7178521
40A04R-SMOSN11-C	40A04R-SMOSN11-C	7799318

ANSI	ISO	EDP
40A04R-SMOZD09-C	40A04R-SMOZD09-C	6759666
40A05R-S45HN06C-C	40A05R-S45HN06C-C	6760271
40A05R-S90AD11E-C	40A05R-S90AD11E-C	7049096
40A05R-S90SO09-C	40A05R-S90SO09-C	6758308
40A05R-SMOBN10-C	40A05R-SMOBN10-C	7464824
40A05R-SMORC10-C	40A05R-SMORC10-C	7444330
40A06R-C90AD15-C	40A06R-C90AD15-C	6761707
40A06R-S90AD11E-C	40A06R-S90AD11E-C	6760199
40A06R-S90TN10-C	40A06R-S90TN10-C	7178522
40A07R-SMOBN10-C	40A07R-SMOBN10-C	7464825
40A08R-S90SO05O-C	40A08R-S90SO05O-C	7343027
40A3R045A32-SVC22C	40A3R045A32-SVC22C	6757990
40A3R050B32-SAD16E-C	40A3R050B32-SAD16E-C	6760171
40A3R050B32-SAP16D-C	40A3R050B32-SAP16D-C	6758449
40A3R054E04-SAD16E-C	40A3R054E04-SAD16E-C	6758507
40A4R050B32-SAD16E-C	40A4R050B32-SAD16E-C	6760172
40A4R050B32-SAP16D-C	40A4R050B32-SAP16D-C	6758371
40A4R050B32-SLN12-C	40A4R050B32-SLN12-C	6760302
40A4R054E04-SAD16E-C	40A4R054E04-SAD16E-C	6758508
40A4R-S90AP16D	40A4R-S90AP16D	6757024
40A6R-S90AP10D	40A6R-S90AP10D	6757033
40A8R050B32-SSO05O-C	40A8R050B32-SSO05O-C	7343025
40E3R060A32-SPD09-C	40E3R060A32-SPD09-C	6920666
40E4R043M16-SSN11-C	40E4R043M16-SSN11-C	7799396
40E4R080B32-SZD12-C	40E4R080B32-SZD12-C	6759700
40E4R140B32-SZD12-C	40E4R140B32-SZD12-C	6759701
40E4R240B32-SZD12-C	40E4R240B32-SZD12-C	6759702
40F2R046B32-SCC09-C	40F2R046B32-SCC09-C	6758319
40J2R60B40-SAD11E47-C	40J2R60B40-SAD11E47-C	6759645
40J3R70B32-SAD11E56-C	40J3R70B32-SAD11E56-C	6800796
40J3R70B40-SAD11E56-C	40J3R70B40-SAD11E56-C	6759646
40J3R75E04-SAD11E56-C	40J3R75E04-SAD11E56-C	6759649
40J4R080XC5-CSD12X44	40J4R080XC5-CSD12X44	6761738
40J4R090H40-CSD12X44	40J4R090H40-CSD12X44	6761737
40L2R070B32-SZP40-C	40L2R070B32-SZP40-C	6761643
40L2R100B40-SZP40-C	40L2R100B40-SZP40-C	6761644
40N3R045A32-SOD05-C	40N3R045A32-SOD05-C	7342890
42A03R-S19PD09-C	42A03R-S19PD09-C	6761256
42A04R-SMOSN11-C	42A04R-SMOSN11-C	7799319
42A05R-SMOBN10-C	42A05R-SMOBN10-C	7464826
42A07R-SMOBN10-C	42A07R-SMOBN10-C	7464827
45T03R-S75XP1628-C	45T03R-S75XP1628-C	6760359
45T04R-S25XP1612-C	45T04R-S25XP1612-C	6760352
45T04R-S30XP1614-C	45T04R-S30XP1614-C	6760351
45T04R-S35XP1616-C	45T04R-S35XP1616-C	6760350
45T04R-S40XP1618-C	45T04R-S40XP1618-C	6760349
45T04R-S45XP1620-C	45T04R-S45XP1620-C	6760348
45T04R-S50XP1622-C	45T04R-S50XP1622-C	6760357
45T04R-S55XP1623-C	45T04R-S55XP1623-C	6760356
45T04R-S60XP1625-C	45T04R-S60XP1625-C	6760358
500A05R-IS45OE09Z-C	500A05R-IS45OE09Z-C	7275070
500A06R-IS45HN09C-CF	500A06R-IS45HN09C-CF	6790767
500A07R-IS45OE06Z-C	500A07R-IS45OE06Z-C	7275031
500A07R-IS45OE09Z-C	500A07R-IS45OE09Z-C	7275071
500A07R-IS90LN12-C	500A07R-IS90LN12-C	6793025
500A08R-IS45OD05-C	500A08R-IS45OD05-C	7546854
500A09R-IS45OE06Z-C	500A09R-IS45OE06Z-C	7275032
500A09R-IS45SE09F-C	500A09R-IS45SE09F-C	6789743
500A09R-IS90AD16E-C	500A09R-IS90AD16E-C	6798491
500A09R-IS90LN12-C	500A09R-IS90LN12-C	6793026
500A10R-IS45HN06C-C	500A10R-IS45HN06C-C	6792924
500A10R-IS45HN09C-CF	500A10R-IS45HN09C-CF	6790768
500A12R-IS45HN09C-CF	500A12R-IS45HN09C-CF	6790769

ANSI	ISO	EDP
500A12R-IS45SE09F-C	500A12R-IS45SE09F-C	6789744
500A12R-IS90AD11E-C	500A12R-IS90AD11E-C	6790727
500A12R-IS90S009-C	500A12R-IS90S009-C	6789782
500A16R-IS45HN06C-C	500A16R-IS45HN06C-C	6792925
500B06R-IS57PN13	500B06R-IS57PN13	6792989
500H06N-IS90SN12N4	500H06N-IS90SN12N4	6789679
500H06N-IS90SN12N5	500H06N-IS90SN12N5	6789680
50A03R-S90AD16E-C	50A03R-S90AD16E-C	6760174
50A03R-S90VC22C	50A03R-S90VC22C	6757986
50A04R-S19PD09-C	50A04R-S19PD09-C	6761257
50A04R-S45HN06C-C	50A04R-S45HN06C-C	6760272
50A04R-S45HN09C-CF	50A04R-S45HN09C-CF	6761566
50A04R-S45OD05-C	50A04R-S45OD05-C	7342881
50A04R-S45OE06Z-C	50A04R-S45OE06Z-C	6922478
50A04R-S45SN12Z-C	50A04R-S45SN12Z-C	6758339
50A04R-S90LN12-C	50A04R-S90LN12-C	6760289
50A04R-SMORC12-C	50A04R-SMORC12-C	7155896
50A04R-SMOZD12-C	50A04R-SMOZD12-C	6759667
50A04R-W90X012	50A04R-W90X012	6761751
50A05R-S19PD09-C	50A05R-S19PD09-C	6920667
50A05R-S45OD05-C	50A05R-S45OD05-C	7342882
50A05R-S45OE06Z-C	50A05R-S45OE06Z-C	6922479
50A05R-S45SE09F-C	50A05R-S45SE09F-C	6761683
50A05R-S90AD11E-C	50A05R-S90AD11E-C	6760200
50A05R-S90AD16E-C	50A05R-S90AD16E-C	6760173
50A05R-S90LN12-C	50A05R-S90LN12-C	6760290
50A05R-S90SD12-C	50A05R-S90SD12-C	6756789
50A05R-S90TN10-C	50A05R-S90TN10-C	7178523
50A05R-SCMORD12	50A05R-SCMORD12	6757895
50A05R-SMORC10-C	50A05R-SMORC10-C	7444331
50A05R-SMOSN11-C	50A05R-SMOSN11-C	7799340
50A05R-SMOZD09-C	50A05R-SMOZD09-C	7049098
50A06R-S45HN06C-C	50A06R-S45HN06C-C	6760269
50A06R-S90S009-C	50A06R-S90S009-C	6758309
50A06R-SMORC10-C	50A06R-SMORC10-C	7444332
50A06R-SMOSN11-C	50A06R-SMOSN11-C	7799341
50A06R-W90X012	50A06R-W90X012	6761757
50A07R-S90AD11E-C	50A07R-S90AD11E-C	6760201
50A07R-S90TN10-C	50A07R-S90TN10-C	7174637
50A08R-C90AD15-C	50A08R-C90AD15-C	6761709
50A5R-S90AP16D	50A5R-S90AP16D	6757025
50A7R-S90AP10D	50A7R-S90AP10D	6757034
50J3R100H50-SAD16E54-C	50J3R100H50-SAD16E54-C	6922377
50J3R140G50-SAD16E80-C	50J3R140G50-SAD16E80-C	6922378
50J3R140H50-SAD16E80-C	50J3R140H50-SAD16E80-C	6922379
50J3R140X50-SAD16E68-C	50J3R140X50-SAD16E68-C	6922410
50J4R106X50-SSAP37+21	50J4R106X50-SSAP37+21	6757754
50J4R106X50-SSAP58-A	50J4R106X50-SSAP58-A	6757749
50J4R110H50-SSAP37+21	50J4R110H50-SSAP37+21	6757755
50J4R110H50-SSAP58-A	50J4R110H50-SSAP58-A	6757752
50J4R124X50-SSAP55+21	50J4R124X50-SSAP55+21	6757817
50J4R124X50-SSAP76-A	50J4R124X50-SSAP76-A	6757750
50J4R128H50-SSAP55+21	50J4R128H50-SSAP55+21	6757756
50J4R128H50-SSAP76-A	50J4R128H50-SSAP76-A	6757816
50J5R065E04-CSD12X55	50J5R065E04-CSD12X55	6761741
50J5R080XC5-CSD12X55	50J5R080XC5-CSD12X55	6761742
50J5R100H50-CSD12X55	50J5R100H50-CSD12X55	6761740
50L2R100B50-SZP50-C	50L2R100B50-SZP50-C	6761645
50L2R100E05-SZP50	50L2R100E05-SZP50	6761660
50T03R-S90AD11E37-C	50T03R-S90AD11E37-C	6759650
50T03R-S90AD16E40-C	50T03R-S90AD16E40-C	6922411
50T05R-C90SD12X55	50T05R-C90SD12X55	6761739
52A04R-S19PD09-C	52A04R-S19PD09-C	6761258
52A04R-SCMORD16	52A04R-SCMORD16	6757565
52A04R-SMOZD12-C	52A04R-SMOZD12-C	6923288

ANSI	ISO	EDP
52A05R-SCMORD12	52A05R-SCMORD12	6757417
52A05R-SMORC10-C	52A05R-SMORC10-C	7444333
52A05R-SMORC12-C	52A05R-SMORC12-C	6920712
52A05R-SMOSN11-C	52A05R-SMOSN11-C	7799342
52A05R-SMOZD09-C	52A05R-SMOZD09-C	7049099
52A06R-SMORC10-C	52A06R-SMORC10-C	7444334
52A06R-SMOSN11-C	52A06R-SMOSN11-C	7799343
56A05R-S45OE06Z-C	56A05R-S45OE06Z-C	6922508
600A06R-IS45OE09Z-C	600A06R-IS45OE09Z-C	7275072
600A08R-IS45OE09Z-C	600A08R-IS45OE09Z-C	7216309
600A09R-IS45OE06Z-C	600A09R-IS45OE06Z-C	7275033
600A12R-IS45OE06Z-C	600A12R-IS45OE06Z-C	7275034
600B08R-IS45HN09CF	600B08R-IS45HN09CF	6790770
600B08R-IS57PN13	600B08R-IS57PN13	6792990
600B10R-IS45SE09F	600B10R-IS45SE09F	6789745
600B10R-IS90AD16E	600B10R-IS90AD16E	6798492
600B12R-IS45HN09CF	600B12R-IS45HN09CF	6790771
600B14R-IS45SE09F	600B14R-IS45SE09F	6789746
600H08N-IS90SN12N4	600H08N-IS90SN12N4	6789682
600H08N-IS90SN12N5	600H08N-IS90SN12N5	6789683
600H08N-IS90SN12N6	600H08N-IS90SN12N6	6789684
63A04R-S45OE06Z-C	63A04R-S45OE06Z-C	6922500
63A04R-S90AD16E-C	63A04R-S90AD16E-C	6760177
63A04R-S90LN12-C	63A04R-S90LN12-C	6760304
63A04R-S90LN16-C	63A04R-S90LN16-C	6760308
63A04R-S90VC22C	63A04R-S90VC22C	6757987
63A04R-SMORC16-C	63A04R-SMORC16-C	7155920
63A04R-SMOZD12-C	63A04R-SMOZD12-C	6759668
63A05R-S19PD09-C	63A05R-S19PD09-C	6761259
63A05R-S45OD05-C	63A05R-S45OD05-C	7342883
63A05R-S45OD06D	63A05R-S45OD06D	6756816
63A05R-S45SE09F-C	63A05R-S45SE09F-C	6761625
63A05R-S45SN12Z-C	63A05R-S45SN12Z-C	6758340
63A05R-S90LN16-C	63A05R-S90LN16-C	6760309
63A05R-SMORC12-C	63A05R-SMORC12-C	7155897
63A05R-SMOZD12-C	63A05R-SMOZD12-C	6759669
63A05R-W90X012	63A05R-W90X012	6761749
63A06R-S19PD09-C	63A06R-S19PD09-C	6920668
63A06R-S45HN06C-C	63A06R-S45HN06C-C	6760277
63A06R-S45HN09C-CF	63A06R-S45HN09C-CF	6761565
63A06R-S45OD05-C	63A06R-S45OD05-C	7342884
63A06R-S45OE06Z-C	63A06R-S45OE06Z-C	6922501
63A06R-S45SE09F-C	63A06R-S45SE09F-C	6761702
63A06R-S90AD11E-C	63A06R-S90AD11E-C	6760202
63A06R-S90AD16E-C	63A06R-S90AD16E-C	6760176
63A06R-S90LN12-C	63A06R-S90LN12-C	6760305
63A06R-S90SD12-C	63A06R-S90SD12-C	6756790
63A06R-S90TN10-C	63A06R-S90TN10-C	7178524
63A06R-SMORC10-C	63A06R-SMORC10-C	7444335
63A06R-SMOSN11-C	63A06R-SMOSN11-C	7799344
63A06R-SMOZD09-C	63A06R-SMOZD09-C	7049110
63A07R-S90S009-C	63A07R-S90S009-C	6758310
63A07R-SMORC10-C	63A07R-SMORC10-C	7444336
63A07R-W90X012	63A07R-W90X012	6761750
63A08R-S45HN06C-C	63A08R-S45HN06C-C	6760270
63A08R-SMOSN11-C	63A08R-SMOSN11-C	7799345
63A09R-S90AD11E-C	63A09R-S90AD11E-C	6760203
63A09R-S90TN10-C	63A09R-S90TN10-C	7178525
63A10R-C90AD15-C	63A10R-C90AD15-C	6761710
63A6R-S90AP16D	63A6R-S90AP16D	6757026
63A9R-S90AP10D	63A9R-S90AP10D	6757035
63J2R155G50-SLSN104-C	63J2R155G50-SLSN104-C	6760429
63J2R155H50-SLSN104-C	63J2R155H50-SLSN104-C	6760428
63J2R175X50-SLSN104-C	63J2R175X50-SLSN104-C	6760427
63J3R140H50-SAD16E68-C	63J3R140H50-SAD16E68-C	6922412
63J3R155G50-SAD16E95-C	63J3R155G50-SAD16E95-C	6922413
63J3R155H50-SAD16E95-C	63J3R155H50-SAD16E95-C	6922414
63J3R155X50-SAD16E80-C	63J3R155X50-SAD16E80-C	6922415
63J4R146X50-SSAP74+21	63J4R146X50-SSAP74+21	6757818

ANSI	ISO	EDP
63J4R146X50-SSAP95-A	63J4R146X50-SSAP95-A	6757815
63J4R150H50-SSAP74+21	63J4R150H50-SSAP74+21	6757757
63J4R150H50-SSAP95-A	63J4R150H50-SSAP95-A	6757790
63J6R095XC6-CSD12X66	63J6R095XC6-CSD12X66	6761745
63J6R110H50-CSD12X66	63J6R110H50-CSD12X66	6761744
63T04R-S90AD16E40-C	63T04R-S90AD16E40-C	6922416
63T04R-S90AD16E68-C	63T04R-S90AD16E68-C	6922417
63T06R-C90SD12X66	63T06R-C90SD12X66	6761743
66A05R-SCMORD16	66A05R-SCMORD16	6757418
66A05R-SMORC16-C	66A05R-SMORC16-C	6920714
66A05R-SMOZD12-C	66A05R-SMOZD12-C	6923289
66A06R-S19PD09-C	66A06R-S19PD09-C	6761260
66A06R-S19PD09-CF	66A06R-S19PD09-CF	6920710
66A06R-SCMORD12	66A06R-SCMORD12	6757635
66A06R-SMORC10-C	66A06R-SMORC10-C	7444337
66A06R-SMORC12-C	66A06R-SMORC12-C	6920713
66A06R-SMOSN11-C	66A06R-SMOSN11-C	7799346
66A06R-SMOZD09-C	66A06R-SMOZD09-C	7049111
66A07R-SMORC10-C	66A07R-SMORC10-C	7444338
66A08R-SMOSN11-C	66A08R-SMOSN11-C	7799347
70A06R-S45OE06Z-C	70A06R-S45OE06Z-C	6922509
800C08R-IS45OE09Z-C	800C08R-IS45OE09Z-C	7275073
800C10R-IS45HN09CF	800C10R-IS45HN09CF	6790772
800C10R-IS45OE09Z-C	800C10R-IS45OE09Z-C	7275074
800C10R-IS57PN13	800C10R-IS57PN13	6792991
800C11R-IS45OE06Z-C	800C11R-IS45OE06Z-C	7275035
800C14R-IS45OE06Z-C	800C14R-IS45OE06Z-C	7275036
80A04R-S90LN16-C	80A04R-S90LN16-C	6760310
80A04R-SMORC20-C	80A04R-SMORC20-C	7155924
80A05R-S19PD09-C	80A05R-S19PD09-C	6761261
80A05R-S45OE06Z-C	80A05R-S45OE06Z-C	6922502
80A05R-S45OE09Z-C	80A05R-S45OE09Z-C	7056831
80A05R-S90AD16E-C	80A05R-S90AD16E-C	6760178
80A05R-S90LN12-C	80A05R-S90LN12-C	6760291
80A05R-S90VC22C	80A05R-S90VC22C	6757988
80A05R-SMORC12-C	80A05R-SMORC12-C	7155898
80A05R-SMORC16-C	80A05R-SMORC16-C	7155921
80A05R-SMOZD12-C	80A05R-SMOZD12-C	6759670
80A06R-S19PD09-C	80A06R-S19PD09-C	6920669
80A06R-S45HN09C-CF	80A06R-S45HN09C-CF	6761569
80A06R-S45OD05-C	80A06R-S45OD05-C	7342885
80A06R-S45OD06D	80A06R-S45OD06D	6756817
80A06R-S45OE06Z-C	80A06R-S45OE06Z-C	6922503
80A06R-S45SE09F-C	80A06R-S45SE09F-C	6761668
80A06R-S45SN12Z-C	80A06R-S45SN12Z-C	6758341
80A06R-S90LN16-C	80A06R-S90LN16-C	6760311
80A06R-S90SD12-C	80A06R-S90SD12-C	6760182
80A06R-SCMORD16	80A06R-SCMORD16	6757637
80A06R-W90X012	80A06R-W90X012	6761752
80A07R-S45HN06C-C	80A07R-S45HN06C-C	6760278
80A07R-S90AD16E-C	80A07R-S90AD16E-C	6760175
80A07R-S90LN12-C	80A07R-S90LN12-C	6760292
80A07R-SMOSN11-C	80A07R-SMOSN11-C	7799348
80A08R-C60HN09	80A08R-C60HN09	6761686
80A08R-S45HN09C-CF	80A08R-S45HN09C-CF	6761568
80A08R-S45OD05-C	80A08R-S45OD05-C	7342886
80A08R-S45SE09F-C	80A08R-S45SE09F-C	6761684
80A09R-S90S009-C	80A09R-S90S009-C	6758311
80A09R-SMOSN11-C	80A09R-SMOSN11-C	7799349
80A09R-W90X012	80A09R-W90X012	6761753
80A10R-C90AD15-C	80A10R-C90AD15-C	6761711
80A10R-S45HN06C-C	80A10R-S45HN06C-C	6760279
80A10R-S90AD11E-C	80A10R-S90AD11E-C	6760204
80A10R-S90TN10-C	80A10R-S90TN10-C	7178526
80A12R-C60HN09	80A12R-C60HN09	6761687
80A14R-C90AD15-C	80A14R-C90AD15-C	6761712
80B07R-SCMORD12	80B07R-SCMORD12	6757636
80B5R-S90AP16D	80B5R-S90AP16D	6757027
80B7R-S90AP16D	80B7R-S90AP16D	6757028
80F8N-S90SN11N4	80F8N-S90SN11N4	6758320
80F8N-S90SN11N5	80F8N-S90SN11N5	6758321
80F8N-S90SN12N6	80F8N-S90SN12N6	6758322
80F8N-S90SN12N8	80F8N-S90SN12N8	6758450

ANSI	ISO	EDP
80J2R190G50-SLSN134-C	80J2R190G50-SLSN134-C	6760430
80J2R190H50-SLSN134-C	80J2R190H50-SLSN134-C	6760431
80J2R210X50-SLSN134-C	80J2R210X50-SLSN134-C	6760426
80J4R165G50-SAD16E108-C	80J4R165G50-SAD16E108-C	6922418
80J4R165H50-SAD16E108-C	80J4R165H50-SAD16E108-C	6922419
80J4R165X50-SAD16E95-C	80J4R165X50-SAD16E95-C	6922420
80J6R151X50-SSAP95-A	80J6R151X50-SSAP95-A	6757751
80J6R155H50-SSAP95-A	80J6R155H50-SSAP95-A	6757753
80J8R130H50-CSD12X88	80J8R130H50-CSD12X88	6761747
80T04R-S90AD16E55-C	80T04R-S90AD16E55-C	6922421
80T04R-S90AD16E80-C	80T04R-S90AD16E80-C	6922422
80T08R-C90SD12X88	80T08R-C90SD12X88	6761746
8N1R027B16-SSO09-C	8N1R027B16-SSO09-C	6758332
90A07R-S45OE06Z-C	90A07R-S45OE06Z-C	6922510
PPH-08/02-QC08-130HSCW	PPH-08/02-QC08-130HSCW	7024708
PPH-08/02-QC12-092	PPH-08/02-QC12-092	7024709
PPH-08/02-QC12-110	PPH-08/02-QC12-110	7024730
PPH-08/02-QC12-110HSCW	PPH-08/02-QC12-110HSCW	7024731
PPH-08/02-QC12-132	PPH-08/02-QC12-132	7024732
PPH-08/02-QC12-132HSCW	PPH-08/02-QC12-132HSCW	7024733
PPH-10/02-QC10-140HSCW	PPH-10/02-QC10-140HSCW	7024734
PPH-10/02-QC12-092	PPH-10/02-QC12-092	7024735
PPH-10/02-QC12-092HSCW	PPH-10/02-QC12-092HSCW	7024736
PPH-10/02-QC12-110	PPH-10/02-QC12-110	7024737
PPH-10/02-QC12-110HSCW	PPH-10/02-QC12-110HSCW	7024738
PPH-10/02-QC12-132	PPH-10/02-QC12-132	7024739
PPH-10/02-QC12-132HSCW	PPH-10/02-QC12-132HSCW	7024740
PPH-12/02-QC12-083	PPH-12/02-QC12-083	7024741
PPH-12/02-QC12-083HSCW	PPH-12/02-QC12-083HSCW	7024742
PPH-12/02-QC12-110	PPH-12/02-QC12-110	7024743
PPH-12/02-QC12-110HSCW	PPH-12/02-QC12-110HSCW	7024744
PPH-12/02-QC12-145	PPH-12/02-QC12-145	7024745
PPH-12/02-QC16-145	PPH-12/02-QC16-145	7024746
PPH-12/02-QC16-145HSCW	PPH-12/02-QC16-145HSCW	7024747
PPH-16/02-QC16-092	PPH-16/02-QC16-092	7024749
PPH-16/02-QC16-092HSCW	PPH-16/02-QC16-092HSCW	7024750
PPH-16/02-QC16-123	PPH-16/02-QC16-123	7024751
PPH-16/02-QC16-123HSCW	PPH-16/02-QC16-123HSCW	7024752
PPH-16/02-QC16-166	PPH-16/02-QC16-166	7024753
PPH-16/02-QC20-166	PPH-16/02-QC20-166	7024754
PPH-16/02-QC20-166HSCW	PPH-16/02-QC20-166HSCW	7024755
PPH-20/02-QC20-104	PPH-20/02-QC20-104	7024757
PPH-20/02-QC20-104HSCW	PPH-20/02-QC20-104HSCW	7024758
PPH-20/02-QC20-141	PPH-20/02-QC20-141	7024759
PPH-20/02-QC20-141HSCW	PPH-20/02-QC20-141HSCW	7024760
PPH-20/02-QC20-191	PPH-20/02-QC20-191	7024761
PPH-20/02-QC25-191	PPH-20/02-QC25-191	7024762
PPH-20/02-QC25-191HSCW	PPH-20/02-QC25-191HSCW	7024763
PPH-25/02-QC25-121	PPH-25/02-QC25-121	7024764
PPH-25/02-QC25-166	PPH-25/02-QC25-166	7024765
PPH-25/02-QC32-215	PPH-25/02-QC32-215	7024766
PPH-32/02-QC32-186	PPH-32/02-QC32-186	7024767
PPH-32/02-QC32-240	PPH-32/02-QC32-240	7024768



ANSI	ISO	EDP
802D-0594-118-S100	802D-0594-118-S100	6801090
802D-0625-125-S100	802D-0625-125-S100	6801091
802D-0656-131-S100	802D-0656-131-S100	6801092
802D-0687-137-S100	802D-0687-137-S100	6801093
802D-0709-141-S100	802D-0709-141-S100	6801094
802D-0750-150-S100	802D-0750-150-S100	6801095
802D-0766-153-S100	802D-0766-153-S100	6801096
802D-0787-157-S100	802D-0787-157-S100	6801097
802D-0812-162-S100	802D-0812-162-S100	6801098
802D-0827-165-S100	802D-0827-165-S100	6801099
802D-0937-187-S100	802D-0937-187-S100	6801100
802D-0906-181-S100	802D-0906-181-S100	6801101
802D-0922-184-S100	802D-0922-184-S100	6801102
802D-0937-187-S100	802D-0937-187-S100	6801103
802D-0984-196-S125	802D-0984-196-S125	6801104
802D-1000-200-S125	802D-1000-200-S125	6801105
802D-1032-206-S125	802D-1032-206-S125	6801106
802D-1062-212-S125	802D-1062-212-S125	6801107
802D-1109-221-S125	802D-1109-221-S125	6801108
802D-1125-225-S125	802D-1125-225-S125	6801109
802D-1172-234-S125	802D-1172-234-S125	6801110
802D-1187-237-S125	802D-1187-237-S125	6801111
802D-1250-250-S150	802D-1250-250-S150	6801112
802D-1312-262-S150	802D-1312-262-S150	6801113
802D-1344-268-S150	802D-1344-268-S150	6801114
802D-1375-275-S150	802D-1375-275-S150	6801115
802D-1437-287-S150	802D-1437-287-S150	6801116
802D-1500-300-S150	802D-1500-300-S150	6801117
802D-15-30-S25	802D-15-30-S25	6820734
802D-16-32-S25	802D-16-32-S25	6820735
802D-17-34-S25	802D-17-34-S25	6820736
802D-1750-350-S150	802D-1750-350-S150	6801118
802D-18-36-S25	802D-18-36-S25	6820737
802D-19-38-S25	802D-19-38-S25	6820738
802D-2000-400-S150	802D-2000-400-S150	6801119
802D-20-40-S25	802D-20-40-S25	6820739
802D-21-42-S25	802D-21-42-S25	6820770
802D-22-44-S25	802D-22-44-S25	6820771
802D-23-46-S25	802D-23-46-S25	6820772
802D-24-48-S25	802D-24-48-S25	6820773
802D-25-50-S32	802D-25-50-S32	6820774
802D-26-52-S32	802D-26-52-S32	6820775
802D-27-54-S32	802D-27-54-S32	6820776
802D-28-56-S32	802D-28-56-S32	6820777
802D-29-58-S32	802D-29-58-S32	6820778
802D-30-60-S32	802D-30-60-S32	6820779
802D-32-64-S32	802D-32-64-S32	6820780
802D-32-64-S40	802D-32-64-S40	6820781
802D-34-68-S32	802D-34-68-S32	6820782
802D-34-68-S40	802D-34-68-S40	6820783
802D-36-72-S32	802D-36-72-S32	6820784
802D-36-72-S40	802D-36-72-S40	6820785
802D-38-76-S32	802D-38-76-S32	6820786
802D-38-76-S40	802D-38-76-S40	6820787
802D-40-80-S32	802D-40-80-S32	6820788
802D-40-80-S40	802D-40-80-S40	6820789
803D-0594-178-S100	803D-0594-178-S100	6801120
803D-0625-187-S100	803D-0625-187-S100	6801121
803D-0656-196-S100	803D-0656-196-S100	6801122
803D-0687-206-S100	803D-0687-206-S100	6801123
803D-0709-212-S100	803D-0709-212-S100	6801124
803D-0750-225-S100	803D-0750-225-S100	6801125
803D-0766-229-S100	803D-0766-229-S100	6801126
803D-0787-236-S100	803D-0787-236-S100	6801127
803D-0812-243-S100	803D-0812-243-S100	6801128
803D-0827-248-S100	803D-0827-248-S100	6801129
803D-0875-262-S100	803D-0875-262-S100	6801130
803D-0906-271-S100	803D-0906-271-S100	6801131
803D-0922-276-S100	803D-0922-276-S100	6801132
803D-0937-281-S100	803D-0937-281-S100	6801133
803D-0984-295-S125	803D-0984-295-S125	6801134
803D-1000-300-S125	803D-1000-300-S125	6801135
803D-1032-310-S125	803D-1032-310-S125	6865420
803D-1062-318-S125	803D-1062-318-S125	6801137
803D-1109-332-S125	803D-1109-332-S125	6801138
803D-1125-337-S125	803D-1125-337-S125	6801139

ANSI	ISO	EDP
803D-1172-351-S125	803D-1172-351-S125	6801140
803D-1187-356-S125	803D-1187-356-S125	6801141
803D-1250-375-S150	803D-1250-375-S150	6801142
803D-1312-393-S150	803D-1312-393-S150	6801143
803D-1344-403-S150	803D-1344-403-S150	6801144
803D-1375-412-S150	803D-1375-412-S150	6801145
803D-1437-431-S150	803D-1437-431-S150	6801146
803D-15-46,5-S25	803D-15-46,5-S25	6820790
803D-1500-450-S150	803D-1500-450-S150	6801147
803D-15-45-S25	803D-15-45-S25	6820791
803D-16,5-49,5-S25	803D-16,5-49,5-S25	6820792
803D-16-48-S25	803D-16-48-S25	6820793
803D-17,5-52,5-S25	803D-17,5-52,5-S25	6820794
803D-1750-525-S150	803D-1750-525-S150	6801148
803D-17-51-S25	803D-17-51-S25	6820795
803D-18,5-55,5-S25	803D-18,5-55,5-S25	6820796
803D-18-54-S25	803D-18-54-S25	6820797
803D-19,5-58,5-S25	803D-19,5-58,5-S25	6820798
803D-19-57-S25	803D-19-57-S25	6820799
803D-20,5-61,5-S25	803D-20,5-61,5-S25	6820800
803D-2000-600-S150	803D-2000-600-S150	6801149
803D-20-60-S25	803D-20-60-S25	6820801
803D-21,5-64,5-S25	803D-21,5-64,5-S25	6820802
803D-21-63-S25	803D-21-63-S25	6820803
803D-22,5-67,5-S25	803D-22,5-67,5-S25	6820804
803D-22-66-S25	803D-22-66-S25	6820805
803D-23,5-70,5-S25	803D-23,5-70,5-S25	6820806
803D-23-69-S25	803D-23-69-S25	6820807
803D-24,5-73,5-S25	803D-24,5-73,5-S25	6820808
803D-24-72-S25	803D-24-72-S25	6820809
803D-25,5-76,5-S32	803D-25,5-76,5-S32	6820810
803D-25-75-S32	803D-25-75-S32	6820811
803D-26,5-79,5-S32	803D-26,5-79,5-S32	6820812
803D-26-78-S32	803D-26-78-S32	6820813
803D-27-81-S32	803D-27-81-S32	6820814
803D-28-84-S32	803D-28-84-S32	6820815
803D-29-87-S32	803D-29-87-S32	6820816
803D-30-90-S32	803D-30-90-S32	6820817
803D-31-93-S32	803D-31-93-S32	6820818
803D-32-96-S32	803D-32-96-S32	6820819
803D-32-96-S40	803D-32-96-S40	6820820
803D-33-99-S32	803D-33-99-S32	6820821
803D-33-99-S40	803D-33-99-S40	6820822
803D-34-102-S32	803D-34-102-S32	6820823
803D-34-102-S40	803D-34-102-S40	6820824
803D-35-105-S32	803D-35-105-S32	6820825
803D-35-105-S40	803D-35-105-S40	6820826
803D-36-108-S32	803D-36-108-S32	6820827
803D-36-108-S40	803D-36-108-S40	6820828
803D-37-111-S32	803D-37-111-S32	6820829
803D-37-111-S40	803D-37-111-S40	6820830
803D-38-114-S32	803D-38-114-S32	6820831
803D-38-114-S40	803D-38-114-S40	6820832
803D-39-117-S32	803D-39-117-S32	6820833
803D-39-117-S40	803D-39-117-S40	6820834
803D-40-120-S32	803D-40-120-S32	6820835
803D-40-120-S40	803D-40-120-S40	6820836
803D-41-123-S40	803D-41-123-S40	6758967
803D-42-126-S40	803D-42-126-S40	6758974
803D-43-129-S40	803D-43-129-S40	6758975
803D-44-132-S40	803D-44-132-S40	6758976
803D-45-135-S40	803D-45-135-S40	6758977
803D-46-138-S40	803D-46-138-S40	6758978
803D-47-141-S40	803D-47-141-S40	6758979
803D-48-144-S40	803D-48-144-S40	6758980
803D-49-147-S40	803D-49-147-S40	6758986
803D-50-150-S40	803D-50-150-S40	6758981
803D-51-153-S40	803D-51-153-S40	6758982
803D-52-156-S40	803D-52-156-S40	6758983
803D-53-159-S40	803D-53-159-S40	6758984
803D-54-162-S40	803D-54-162-S40	6758985
803D-55-165-S40	803D-55-165-S40	6758986
803D-56-168-S40	803D-56-168-S40	6758987
803D-57-171-S40	803D-57-171-S40	6758988
803D-58-174-S40	803D-58-174-S40	6758969
804D-0594-237-S100	804D-0594-237-S100	6801150

ANSI	ISO	EDP
804D-0625-250-S100	804D-0625-250-S100	6801151
804D-0656-262-S100	804D-0656-262-S100	6801152
804D-0687-274-S100	804D-0687-274-S100	6801153
804D-0709-283-S100	804D-0709-283-S100	6801154
804D-0750-300-S100	804D-0750-300-S100	6801155
804D-0766-306-S100	804D-0766-306-S100	6801156
804D-0787-314-S100	804D-0787-314-S100	6801157
804D-0812-324-S100	804D-0812-324-S100	6801158
804D-0827-330-S100	804D-0827-330-S100	6801159
804D-0875-350-S100	804D-0875-350-S100	6801160
804D-0906-362-S100	804D-0906-362-S100	6801161
804D-0922-368-S100	804D-0922-368-S100	6801162
804D-0937-374-S100	804D-0937-374-S100	6801163
804D-0984-393-S125	804D-0984-393-S125	6801164
804D-1000-400-S125	804D-1000-400-S125	6801165
804D-1032-412-S125	804D-1032-412-S125	6801166
804D-1062-424-S125	804D-1062-424-S125	6801167
804D-1109-443-S125	804D-1109-443-S125	6801168
804D-1125-450-S125	804D-1125-450-S125	6801169
804D-1172-468-S125	804D-1172-468-S125	6801170
804D-1187-474-S125	804D-1187-474-S125	6801171
804D-1250-500-S150	804D-1250-500-S150	6801172
804D-1312-524-S150	804D-1312-524-S150	6801173
804D-1344-537-S150	804D-1344-537-S150	6801174
804D-1375-550-S150	804D-1375-550-S150	6801175
804D-1437-574-S150	804D-1437-574-S150	6801176
804D-1500-600-S150	804D-1500-600-S150	6801177
804D-1750-700-S150	804D-1750-700-S150	6801178
804D-17-68-S25	804D-17-68-S25	6758989
804D-18-72-S25	804D-18-72-S25	6758990
804D-19-76-S25	804D-19-76-S25	6758991
804D-2000-800-S150	804D-2000-800-S150	6801179
804D-20-80-S25	804D-20-80-S25	6758992
804D-21-84-S25	804D-21-84-S25	6758993
804D-22-88-S25	804D-22-88-S25	6758994
804D-23-92-S25	804D-23-92-S25	6758995
804D-24-96-S25	804D-24-96-S25	6758996
804D-25-100-S32	804D-25-100-S32	6758997
804D-26-104-S32	804D-26-104-S32	6758998
804D-27-108-S32	804D-27-108-S32	6758999
804D-28-112-S32	804D-28-112-S32	6759000
804D-29-116-S32	804D-29-116-S32	6759001
804D-30-120-S32	804D-30-120-S32	6759002
804D-31-124-S32	804D-31-124-S32	6759003
804D-32-128-S32	804D-32-128-S32	6759004
804D-33-132-S32	804D-33-132-S32	6759005
804D-34-136-S32	804D-34-136-S32	6759006
804D-35-140-S32	804D-35-140-S32	6759007
804D-36-144-S32	804D-36-144-S32	6759008
804D-37-148-S32	804D-37-148-S32	6759009
804D-38-152-S32	804D-38-152-S32	6759010
804D-39-156-S32	804D-39-156-S32	6759011
804D-40-160-S32	804D-40-160-S32	6759012
804D-41-164-S40	804D-41-164-S40	6760972
804D-42-168-S40	804D-42-168-S40	6760973
804D-43-172-S40	804D-43-172-S40	6760974
804D-44-176-S40	804D-44-176-S40	6760975
804D-45-180-S40	804D-45-180-S40	676

ANSI	ISO	EDP
805D-24-120-S25	805D-24-120-S25	6759014
805D-25-125-S32	805D-25-125-S32	6759015
805D-26-130-S32	805D-26-130-S32	6759016
805D-27-135-S32	805D-27-135-S32	6759017
805D-28-140-S32	805D-28-140-S32	6759018
805D-29-145-S32	805D-29-145-S32	6759019
805D-30-150-S32	805D-30-150-S32	6759020
805D-31-155-S32	805D-31-155-S32	6759021

# SIMPLY RELIABLE

As a professional you can judge the quality of work by just looking at the chip. Our chip is a clean and uncomplicated shape that in itself tells a story. It is a clear and consistent signal and that's why we use it as a symbol for being **Simply Reliable**.

Como profesional se puede juzgar la calidad del trabajo sólo mirando la viruta. La viruta es una forma limpia y sin complicaciones, que en sí misma cuenta una historia. Es una señal clara y consistente y es por eso que la usamos como un símbolo por ser **simplemente fiables**.

Un copeau peut vous raconter une histoire de part sa forme et son fractionnement. En tant que professionnel, vous pouvez juger de la qualité d'un usinage rien qu'en le regardant. Le copeau envoie un message clair et évident, c'est pourquoi nous l'avons choisi comme symbole, efficace **tout simplement**.

## Argentina

T: 54 (11) 6777-6777  
F: 54 (11) 4441-4467  
info.ar@dormerpramet.com

## Austria

T: +31 10 2080 240  
info.at@dormerpramet.com

## Belgium & Luxembourg

T: +32 3 440 59 01  
info.be@dormerpramet.com

## Brazil

T: +55 11 5660 3000  
info.br@dormerpramet.com

## Canada

T: (888) 336 7637  
En Français: (888) 368 8457  
F: (905) 542 7000  
cs.canada@dormerpramet.com

## China

T: +86 21 2416 0508  
info.cn@dormerpramet.com

## Croatia

T: +385 98 407 489  
info.hr@dormerpramet.com

## Czech Republic

T: +420 583 381 111  
F: +420 583 215 401  
info.cz@dormerpramet.com

## Denmark

T: 808 82106  
info.se@dormerpramet.com

## Finland

T: 0205 44 7003  
info.fi@dormerpramet.com

## France

T: +33 (0)2 47 62 57 01  
F: +33 (0)2 47 62 52 00  
info.fr@dormerpramet.com

## Germany

T: +49 9131 933 08 70  
F: +49 9131 933 08 742  
info.de@dormerpramet.com

## Hungary

T: +36-96 / 522-846  
F: +36-96 / 522-847  
info.hu@dormerpramet.com

## India

T: +91 11 4601 5686  
info.in@dormerpramet.com

## Italy

T: +39 02 38 04 51  
info.it@dormerpramet.com

## Kazakhstan

T: +7 771 305 11 45  
info.kz@dormerpramet.com

## Mexico

T: +52 (555) 7293981  
F: +52 (555) 7293981  
cs.mexico@dormerpramet.com

## Netherlands

T: +31 10 2080 240  
info.nl@dormerpramet.com

## Norway

T: 800 10 113  
info.se@dormerpramet.com

## Poland

T: +48 32 78-15-890  
F: +48 32 78-60-406  
info.pl@dormerpramet.com

## Portugal

T: +351 21 424 54 21  
info.pt@dormerpramet.com

## Romania

T: +(0)730 015 885  
info.ro@dormerpramet.com

## Russia

T: +7 495 775 10 28  
F: +7 (499) 763 38 90  
info.ru@dormerpramet.com

## Slovakia

T: +421 (41) 764 54 60  
F: +421 (41) 763 74 49  
info.sk@dormerpramet.com

## Slovenia

T: +385 98 407 489  
info.si@dormerpramet.com

## Spain

T: +34 935717722  
info.es@dormerpramet.com

## Sweden

responsible for **Iceland**  
T: +46 35 16 52 96  
info.se@dormerpramet.com

## Switzerland

T: +31 10 2080 240  
info.ch@dormerpramet.com

## Turkey

T: +90 533 212 45 47  
info.tr@dormerpramet.com

## Ukraine

T: +38 056 376 51 19  
F: +38 056 376 51 20  
info.ua@dormerpramet.com

## United Kingdom

responsible for **Ireland**  
T: 0870 850 4466  
F: 0870 850 8866  
info.uk@dormerpramet.com

## United States of America

T: (800) 877-3745  
cs@dormerpramet.com

## Other countries

### South America

T: +55 11 5660 3000  
F: +55 11 5667 5883  
info.br@dormerpramet.com

### Central and Eastern Europe

T: +420 583 381 526  
F: +420 583 381 401  
info.rcee@dormerpramet.com

### Rest of the World

Dormer Pramet International UK  
T: +44 1246 571338  
F: +44 1246 571339  
info.int@dormerpramet.com

### Dormer Pramet International CZ

T: +420 583 381 520  
F: +420 583 215 401  
info.int.cz@dormerpramet.com

EDP# 7939451



3 603603 790339

2021.1