

DORMER PRAMET

**FRÄSER MIT
WENDESCHNEIDPLATTEN 2024**



FRÄSER MIT WENDESCHNEIDPLATTEN – ALLGEMEINER INHALT

FRÄSER MIT WENDESCHNEIDPLATTEN	Planfräsen	 Negative Wendeschneidplatten	SON06C	SHN06C	SHN09C	SPN13				7	
		 Positive quadratische Wendeschneidplatten	SSD13F	SSE09	SSN12Z	FSB22X					25
		 Positive achteckige und runde Wendeschneidplatten	SOD05	SOD06D	SOE06Z						41
	Eckfräsen	 Negative Wendeschneidplatten	STN10	STN16	SLN12	SLN16	SLN12X				65
		 Positive rhombische Wendeschneidplatten (A-Form)	SAD07D	SAD11E	SAD16E	SAP10D	SAP16D				89
		 Positive quadratische und dreieckige Wendeschneidplatten	SSO09	SSD12	FTB27X						121
	Tiefes Eckfräsen	 Walzenstirnfräser	J(T)-SAD11E	J(T)-SAD16E	J(T)-SSAP	J(T)-CSD12X	J(T)-SLSN				133
	Kopierfräsen	 Runder Plattensitz (RD.. WSP mit 15° Freiwinkel)	SRD05	SRD07	SRD10	SRD12	SRD16				159
		 Sitz mit Zentrierflächen (RC...WSP mit 7° Freiwinkel)	SRC10	SRC12	SRC16	SRC20					185
	Profilfräsen	 Kugelkopf	L2-SZP	K2-SRC	K2-SLC	K2-PPH	K3-CXP				205
 Troidale Form		SVC22C	SCN05C	SWN04						239	
Fräsen mit hohem Vorschub	 Negative Wendeschneidplatten	SBN10	SSN11							251	
	 Positive Wendeschneidplatten	SSO12	SPD09	SZD07	SZD09					265	
Anfasen	 Positive Wendeschneidplatten	SSD09	N-SSO09	STC	2516	2636	J(T)-SXP16			291	
Nutfräsen	 Scheiben – und T-Nutenfräser	S90SN	S90CN (XN)	F-SCC						313	
Andere Fräswendeschneidplatten										330	
ANLEITUNGEN	Wie kann man Katalogdaten lesen? (ISO 13399, Icons, Navigation)									352	
	Sorten-Navigator und Detailbeschreibung									362	
	Fräser mit Wendeschneidplatten – Technische Informationen									366	
	Formeln für die Bearbeitung, Korrekturen und technische Details									372	
	Werkstoffmaterialgruppen (WMG)									376	

PRODUKTFAMILIE		PRODUKTFAMILIE		PRODUKTFAMILIE		PRODUKTFAMILIE	
2		S90		SOE		SSE	
2516	301	S90CN(XN)	320	SOE06Z	55	SSE09	31
2636	304	S90SN	314	SON		SSN	
F		SAD		SON06C	8	SSN11	258
FSB22X	38	SAD07D	90	SPD		SSN12Z	35
F-SCC	325	SAD11E	97	SPD09	270	SSO	
FTB27X	128	SAD16E	106	SPN		SSO09	122
J(T)		SAP		SPN13	21	SSO12	266
J(T)-CSD12X	150	SAP10D	114	SRC		STC	
J(T)-SAD11E	134	SAP16D	117	SRC10	186	STC	298
J(T)-SAD16E	139	SBN		SRC12	190	STN	
J(T)-SLSN	153	SBN10	252	SRC16	194	STN10	66
J(T)-SSAP	145	SCN		SRC20	198	STN16	70
J(T)-SXP16	307	SCN05C	243	SRD		SVC	
K2		SHN		SRD05	160	SVC22C	240
K2-PPH	222	SHN06C	13	SRD07	163	SWN	
K2-SLC	218	SHN09C	17	SRD10	168	SWN04C	246
K2-SRC	211	SLN		SRD12	174	SZD	
K3-CXP	234	SLN12	75	SRD16	180	SZD07	276
L2		SLN12X	85	SSD		SZD09	280
L2-SZP	206	SLN16	81	SSD09	292	SZD12	284
N		SOD		SSD12	125		
N-SS009	295	SOD05	42	SSD13F	26		
		SOD06D	51				











PRODUKTFAMILIE		PRODUKTFAMILIE		PRODUKTFAMILIE		PRODUKTFAMILIE	
A		O		S		T	
ADEX 07-FA	92	ODEW 06	52	SBKX 22	39	TBMR 27	129
ADEX 07-HF	93	ODKT 05IM	43	SBMR 22	39	TCMT	302
ADEX 11-FA	101	ODMT 05	333	SDET 13	27	TCMT	305
ADEX 11-FA	137	ODMT 05IM	44	SDEW 09	293	TCXT 16 STC	299
ADEX 11-HF	101	ODMT 06	52	SDEX 09	293	TNGX 10	67
ADEX 16	109	OEHT 06	56	SDGX 12	151	TNGX 10-FA	68
ADEX 16	142	OEHT 06-FA	57	SDKT 12IM	45	TNGX 16	71
ADEX 16-FA	109	OFKR 07	334	SDMT 12	126	TNGX 16-FA	72
ADEX 16-FA	142	ONMX 06	9	SDMT 12IM	46	TPCN 16	346
ADEX 16-HF	110	P		SDMT 13	28	TPKN	347
ADKT 15	330	PDKT 09	272	SDMX 12	151	TPKR	348
ADKX 15	330	PDKX 09	272	SEEN	337	TPUN	348
ADMX 07	91	PDMW 09	273	SEER	338	V	
ADMX 11	99	PDMX 09	271	SEET 09	33	VCGT 22-FA	241
ADMX 11	135	PNMQ 13	22	SEET 12	338	W	
ADMX 16	107	PNMU 13	22	SEET 12-FA	340	WNHX 04	247
ADMX 16	140	PPH	224	SEET 12-PM	339	X	
ANHX 10	254	PPHF	226	SEEW 12	340	XDET 13	29
APET 15	146	PPHT	225	SEMT 09	32	XDHW	349
APET 16-FA	119	R		SNGX 11	259	XEHT 06	58
APEW 15	146	RC	212	SNGX 13	154	XNGX 06	15
APKT 10	115	RCMT 10	187	SNHF	341	XNGX 09	19
APKT 16	118	RCMT 12	191	SNHN	341	XNGX 13	23
APMT 16	331	RCMT 16	195	SNHQ AZ	316	XNHQ	322
B		RCMT 20	199	SNHQ TRL	317	XP	235
BNGX 10	253	RDET	334	SNKT 12	36	XPHT 16	308
C		RDGT 07	164	SNMT 12	36	XPHT 16-FA	308
CCMX	326	RDGT 10	169	SNMX 17	10	Z	
CNHQ	322	RDGT 12	175	SNUN	342	ZDCW 07	277
CNHX 05	244	RDGT 12IM	44	SOHT 12	267	ZDCW 09	281
CNM	332	RDGT 16	181	SOMT 05	342	ZDEW 12	285
H		RDHT 07-FA	165	SOMT 09	123	ZP	208
HNEF 09	332	RDHT 10-FA	171	SOMT 09	296		
HNGX 06	14	RDHT 12-FA	177	SPET 12	147		
HNGX 09	18	RDHT 16-FA	182	SPET 12 AD	147		
HNMF 09	333	RDHX 05	161	SPEW 12 AD	148		
L		RDHX 07	164	SPGN	343		
LC	219	RDHX 10	170	SPGN 25 DZ	343		
LNET 16	154	RDHX 12	176	SPKN	344		
LNEX 12	86	RDHX 16	182	SPKR	345		
LNGU 12	78	RDHX 20	335	SPUN	345		
LNGU 16	82	RDMT 10	169				
LNGU 16-FA	83	RDMT 12	175				
LNGX 12	76	RDMT 12IM	45				
LNGX 12-FA	78	RDMX 10	170				
LNMU 16	82	RDMX 12	176				
		RDMX 16	181				
		REHT 16	57				
		RPET 12	335				
		RPET 15	53				
		RPEW 12	336				
		RPEX	336				

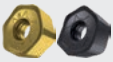
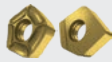

PLANFRÄSEN

WENDEPLATTENFRÄSER – AUSWAHLHILFE

PLANFRÄSEN

	SON06C	SHN06C	SHN09C	SPN13										
	43°		45°		45°		57°							
	APMX (mm)	4.0 (7.0)	APMX (mm)	3.0	APMX (mm)	5.0	APMX (mm)	10.0						
	DC (mm)	50 – 250	DC (mm)	25 – 125	DC (mm)	50 – 315	DC (mm)	100 – 315						
Zylindrischer Schaft														
Weldon														
			DC = 25, 32 (mm)											
Modular														
Aufsteckfräser														
			DC = 40 – 125 (mm)											
Seite	8		13		17		21							
ISO	P	M	K	S	H	P	M	K	H	P	M	K	S	H
Schneidplattenform														
Wendeschneidplatten	ONMX 0605 SNMX 1705		HNGX 0604 XNGX 0604		HNGX 0906 XNGX 0906		PNM. 1308 XN.. 1308							
Anzahl der Schneiden	16 / 8		12 / 1		12 / 1		10 / 1							
Planfräsen 	■		■		■		■							
Fasenfräsen 	■		■		■									
Progressives Tauchfräsen 			■		■									
Rampen 	▣		■		■									

SON06C

P M K S H

PRAMET

S

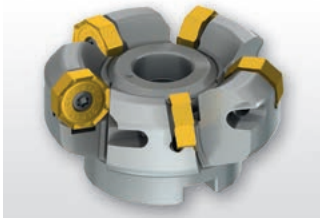

ECON ON06 43° Planfräser in doppelt negativer Ausführung und Innenkühlung

Hoch wirtschaftlicher und produktiver Planfräser mit zwei Arten von doppelseitigen negativen Wendeschneidplatten. Wirtschaftliche achteckige ON..06- mit 16 Schneidkanten und APMX von 4 mm und produktivem quadratischen SN.. 17 Wendeschneidplatten mit 8 Schneidkanten und APMX von 7 mm. Aufsteckausführung mit ungleicher Zahnteilung erhältlich. Trägerwerkzeug für längere Standzeiten ausgelegt.

KAPR	43°
APMX	4.0 (7.0) mm

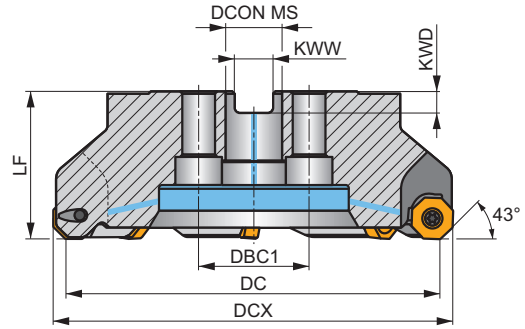
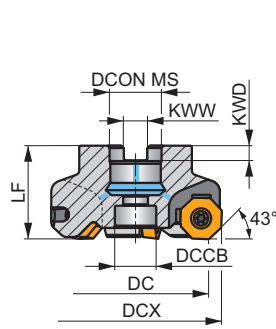
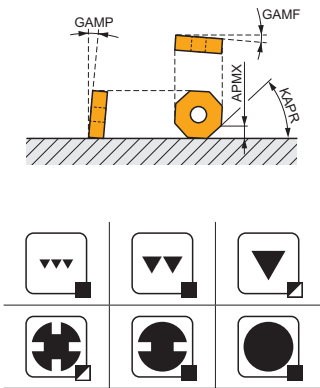

0.04 - 0.25



Produkt	DC	DCX	D CON MS	DCCB	DBC1	LF	KWW	KWD	GAMP	GAMP									
	(mm)	(mm)	(mm)	(mm)	(mm)	(mm)	(mm)	(mm)	(°)	(°)									
50A04R-S450N06-C	50	60.8	22	16.5	-	40	10.4	6.3	-10	-5	4	✓	9400	✓	0.42	GI342	C0621	-	-
50A05R-S450N06-C	50	60.8	22	16.5	-	40	10.4	6.3	-10	-5	5	-	9400	✓	0.39	GI342	C0621	-	-
63A05R-S450N06-C	63	73.8	22	18.1	-	40	10.4	6.3	-10	-5	5	✓	8400	✓	0.71	GI342	C0621	-	-
63A06R-S450N06-C	63	73.8	22	18.1	-	40	10.4	6.3	-10	-5	6	✓	8400	✓	0.55	GI342	C0621	-	-
80A06R-S450N06-C	80	90.8	27	22.1	-	50	12.4	7	-10	-5	6	✓	7500	✓	1.27	GI342	C0622	-	-
80A08R-S450N06-C	80	90.8	27	22.1	-	50	12.4	7	-10	-5	8	-	7500	✓	1.19	GI342	C0622	-	-
100A08R-S450N06-C	100	110.8	32	30.1	-	50	14.4	8	-10	-5	8	✓	6700	✓	1.88	GI342	C0620	AC002	-
100A10R-S450N06-C	100	110.8	32	30.1	-	50	14.4	8	-10	-5	10	-	6700	✓	1.81	GI342	C0620	AC002	-
125A08R-S450N06-C	125	135.8	40	56.1	-	63	16.4	9	-10	-5	8	✓	6000	✓	3.80	GI342	C0620	AC003	-
125A10R-S450N06-C	125	135.8	40	56.1	-	63	16.4	9	-10	-5	10	✓	6000	✓	3.65	GI342	C0620	AC003	-
125A12R-S450N06-C	125	135.8	40	56.1	-	63	16.4	9	-11	-5	12	-	6000	✓	3.70	GI342	C0620	AC003	-
160C08R-S450N06-C	160	170.8	40	-	66.7	63	16.4	9.25	-10	-5	8	✓	5700	✓	6.48	GI342	C0623	-	-
160C12R-S450N06-C	160	170.8	40	-	66.7	63	16.4	9.25	-10	-5	12	✓	5700	✓	5.74	GI342	C0623	-	-
160C14R-S450N06-C	160	170.8	40	-	66.7	63	16.4	9.25	-11	-5	14	-	5700	✓	5.65	GI342	C0623	-	-
200C12R-S450N06-C	200	210.8	60	-	101.6	63	25.8	14.25	-10	-5	12	✓	4700	✓	9.06	GI342	C0624	-	-
200C16R-S450N06-C	200	210.8	60	-	101.6	63	25.8	14.25	-10	-5	16	-	4700	✓	9.02	GI342	C0624	-	-
250C14R-S450N06-C	250	260.8	60	-	101.6	63	25.8	14.25	-10	-5	14	✓	4300	✓	15.71	GI342	C0625	-	-
250C18R-S450N06-C	250	260.8	60	-	101.6	63	25.8	14.25	-10	-5	18	-	4300	✓	15.51	GI342	C0625	-	-

GI342	ONMX 0605..	ONMX 0605..-W..	SNMX 1705..

C0620	US 45013A-T20P	5.0	M 5	13	SDR T20P-T	-	-	-	-

CO621	US 45013A-T20P	5.0	M 5	13	SDR T20P-T	HS 1030C	-	-	-
CO622	US 45013A-T20P	5.0	M 5	13	SDR T20P-T	HS 1230C	-	-	-
CO623	US 45013A-T20P	5.0	M 5	13	SDR T20P-T	HS 1240C	CAC 160C	HSD 0825C	HXK 5
CO624	US 45013A-T20P	5.0	M 5	13	SDR T20P-T	HS 1655C	CAC 200C	HSD 1025C	HXK 7
CO625	US 45013A-T20P	5.0	M 5	13	SDR T20P-T	HS 1655C	CAC 250C	HSD 1025C	HXK 7

AC002	KS 1635	K.FMH32
AC003	KS 2040	K.FMH40

ONMX 06



	IC	D1	S
	(mm)	(mm)	(mm)
0605	17.000	5.70	7.08

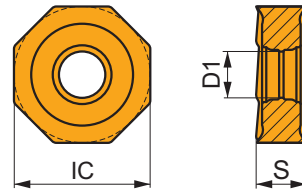

Eignung und Startwerte für Schnittgeschwindigkeit (vc), Vorschub (f) und Schnitttiefe (ap). Weitere Informationen finden Sie in unserer Zerspanungsrechner-App.

Produkt	RE (mm)	P			M			K			N			S			H		
		vc (m/min)	f (mm/tooth)	ap (mm)	vc (m/min)	f (mm/tooth)	ap (mm)	vc (m/min)	f (mm/tooth)	ap (mm)	vc (m/min)	f (mm/tooth)	ap (mm)	vc (m/min)	f (mm/tooth)	ap (mm)	vc (m/min)	f (mm/tooth)	ap (mm)

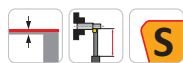
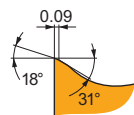
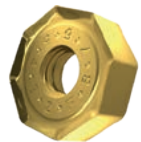

F Geometrie ist scharf und wird zum Schlichten verwendet, geeignet für Anwendungen mit großem Überhang oder dünnwandigen und schlanken Werkstücken. Entwickelt mit hoch positivem Spanwinkel, schmaler Fase und Verrundung der Schneidkante für eine leichte Bearbeitung.

ONMX 060508SR-F:8215	0.8	275	0.10	2.0	165	0.09	2.0	-	-	-	-	-	65	0.07	1.6	-	-	-
ONMX 060508SR-F:M6330	0.8	230	0.10	2.0	165	0.09	2.0	-	-	-	-	-	65	0.07	1.6	-	-	-
ONMX 060508SR-F:M8330	0.8	270	0.10	2.0	160	0.09	2.0	-	-	-	-	-	65	0.07	1.6	-	-	-
ONMX 060508SR-F:M8340	0.8	245	0.10	2.0	145	0.09	2.0	-	-	-	-	-	60	0.07	1.6	-	-	-
ONMX 060508SR-F:M9340	0.8	320	0.10	2.0	190	0.09	2.0	-	-	-	-	-	80	0.07	1.6	-	-	-

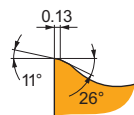

M Geometrie ist vielseitig und die erste Wahl für unterschiedlichste Arbeitsbedingungen. Ausgelegt mit positivem Spanwinkel, mittlerer Fase und verrundeter Schneidkante für mittlere Zerspanungsaufgaben.

ONMX 060508SR-M:8215	0.8	230	0.20	2.0	135	0.18	2.0	-	-	-	-	-	55	0.14	1.6	45	0.14	1.0
ONMX 060508SR-M:M6330	0.8	195	0.20	2.0	140	0.18	2.0	-	-	-	-	-	55	0.14	1.6	-	-	-
ONMX 060508SR-M:M8330	0.8	230	0.20	2.0	135	0.18	2.0	-	-	-	-	-	55	0.14	1.6	45	0.14	1.0
ONMX 060508SR-M:M8340	0.8	210	0.20	2.0	125	0.18	2.0	-	-	-	-	-	50	0.14	1.6	-	-	-
ONMX 060508SR-M:M9325	0.8	285	0.20	2.0	-	-	-	-	-	-	-	-	-	-	-	55	0.14	1.0
ONMX 060508SR-M:M9340	0.8	255	0.20	2.0	150	0.18	2.0	-	-	-	-	-	60	0.14	1.6	-	-	-

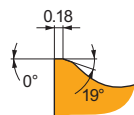
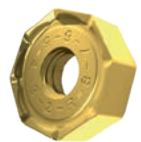

R Geometrie ist stark und wird zum Schruppen und unter schweren Arbeitsbedingungen verwendet. Ausgelegt mit leicht positivem Spanwinkel, breiter Fase und verrundeter Schneidkante für die Schruppbearbeitung.

ONMX 060508SR-R:8215	0.8	210	0.30	2.0	-	-	-	195	0.30	2.0	-	-	-	-	-	40	0.21	1.0
ONMX 060508SR-R:M5315	0.8	255	0.30	2.0	-	-	-	240	0.30	2.0	-	-	-	-	-	50	0.21	1.0
ONMX 060508SR-R:M8330	0.8	210	0.30	2.0	-	-	-	195	0.30	2.0	-	-	-	-	-	40	0.21	1.0

Eignung und Startwerte für Schnittgeschwindigkeit (vc), Vorschub (f) und Schnitttiefe (ap). Weitere Informationen finden Sie in unserer Zerspanungsrechner-App.

Produkt	RE (mm)	P			M			K			N			S			H		
		vc (m/min)	f (mm/tooth)	ap (mm)	vc (m/min)	f (mm/tooth)	ap (mm)	vc (m/min)	f (mm/tooth)	ap (mm)	vc (m/min)	f (mm/tooth)	ap (mm)	vc (m/min)	f (mm/tooth)	ap (mm)	vc (m/min)	f (mm/tooth)	ap (mm)

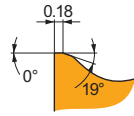
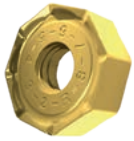

R geometrie ist stark und wird zum Schruppen und unter schweren Arbeitsbedingungen verwendet. Ausgelegt mit leicht positivem Spanwinkel, breiter Fasse und verrundeter Schneidkante für die Schruppbearbeitung.

ONMX 060508SR-R:M8340	0.8	190	0.30	2.0	–	–	–	180	0.30	2.0	–	–	–	–	–	–	–	–	–	
ONMX 060508SR-R:M9325	0.8	250	0.30	2.0	–	–	–	235	0.30	2.0	–	–	–	–	–	–	–	50	0.21	1.0

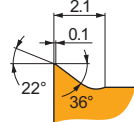
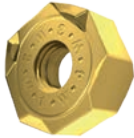

W wiper-Ausführung für verbesserte Oberflächengüte bei der Bearbeitung mit großen Fräsern und hohem Vorschub.

ONMX 060508SR-W:8215	0.8	340	0.10	0.3	200	0.09	0.3	–	–	–	–	–	–	–	–	–	–	–	–	–
ONMX 060508SR-W:M8330	0.8	325	0.10	0.3	195	0.09	0.3	–	–	–	–	–	–	–	–	–	–	–	–	–

SNMX 17



	IC (mm)	D1 (mm)	S (mm)
1705	17.000	5.70	5.56

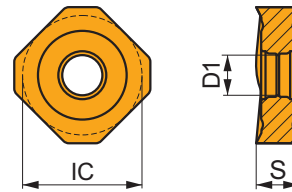

Eignung und Startwerte für Schnittgeschwindigkeit (vc), Vorschub (f) und Schnitttiefe (ap). Weitere Informationen finden Sie in unserer Zerspanungsrechner-App.

Produkt	RE (mm)	P			M			K			N			S			H		
		vc (m/min)	f (mm/tooth)	ap (mm)	vc (m/min)	f (mm/tooth)	ap (mm)	vc (m/min)	f (mm/tooth)	ap (mm)	vc (m/min)	f (mm/tooth)	ap (mm)	vc (m/min)	f (mm/tooth)	ap (mm)	vc (m/min)	f (mm/tooth)	ap (mm)

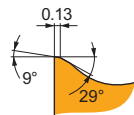
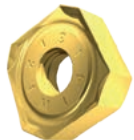

M geometrie ist vielseitig und die erste Wahl für unterschiedlichste Arbeitsbedingungen. Ausgelegt mit positivem Spanwinkel, mittlerer Fasse und verrundeter Schneidkante für mittlere Zerspanungsaufgaben.

SNMX 170508SR-M:8215	0.8	265	0.20	4.0	155	0.18	4.0	–	–	–	–	–	–	65	0.14	3.2	50	0.14	1.0
SNMX 170508SR-M:M6330	0.8	225	0.20	4.0	160	0.18	4.0	–	–	–	–	–	–	65	0.14	3.2	–	–	–
SNMX 170508SR-M:M8330	0.8	265	0.20	4.0	155	0.18	4.0	–	–	–	–	–	–	65	0.14	3.2	50	0.14	1.0
SNMX 170508SR-M:M8340	0.8	240	0.20	4.0	140	0.18	4.0	–	–	–	–	–	–	60	0.14	3.2	–	–	–
SNMX 170508SR-M:M9325	0.8	325	0.20	4.0	–	–	–	–	–	–	–	–	–	–	–	–	65	0.14	1.0
SNMX 170508SR-M:M9340	0.8	295	0.20	4.0	175	0.18	4.0	–	–	–	–	–	–	70	0.14	3.2	–	–	–

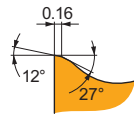
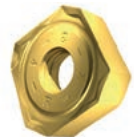

R geometrie ist stark und wird zum Schruppen und unter schweren Arbeitsbedingungen verwendet. Ausgelegt mit leicht positivem Spanwinkel, breiter Fasse und verrundeter Schneidkante für die Schruppbearbeitung.

SNMX 170508SR-R:8215	0.8	240	0.30	4.0	–	–	–	225	0.30	4.0	–	–	–	–	–	–	45	0.21	1.0
SNMX 170508SR-R:M5315	0.8	300	0.30	4.0	–	–	–	285	0.30	4.0	–	–	–	–	–	–	60	0.21	1.0
SNMX 170508SR-R:M8330	0.8	240	0.30	4.0	–	–	–	225	0.30	4.0	–	–	–	–	–	–	45	0.21	1.0
SNMX 170508SR-R:M8340	0.8	220	0.30	4.0	–	–	–	205	0.30	4.0	–	–	–	–	–	–	–	–	–
SNMX 170508SR-R:M9325	0.8	290	0.30	4.0	–	–	–	275	0.30	4.0	–	–	–	–	–	–	55	0.21	1.0



a_e / DC	5%	10%	15%	20%	25%	30%	40%	50%	60%	70%	75%	80%	90%	100%
	1.48	1.35	1.27	1.22	1.19	1.16	1.11	1.08	1.05	1.03	1.00	1.00	1.00	1.00
	2.20	1.60	1.35	1.20	1.10	0.95	0.85	0.75	0.85	0.95	1.00	1.00	1.00	1.00
	0.64	0.64	0.64	0.64	0.64	0.65	0.65	0.67	0.68	0.71	0.72	0.74	0.79	1.00

	ONMX 06-F	ONMX 06-M	ONMX 06-R	ONMX 06-W	SNMX 17-M	SNMX 17-R
	0.80	0.80	0.80	0.80	0.80	0.80
	0.75	0.75	0.75	4.30	0.70	0.70

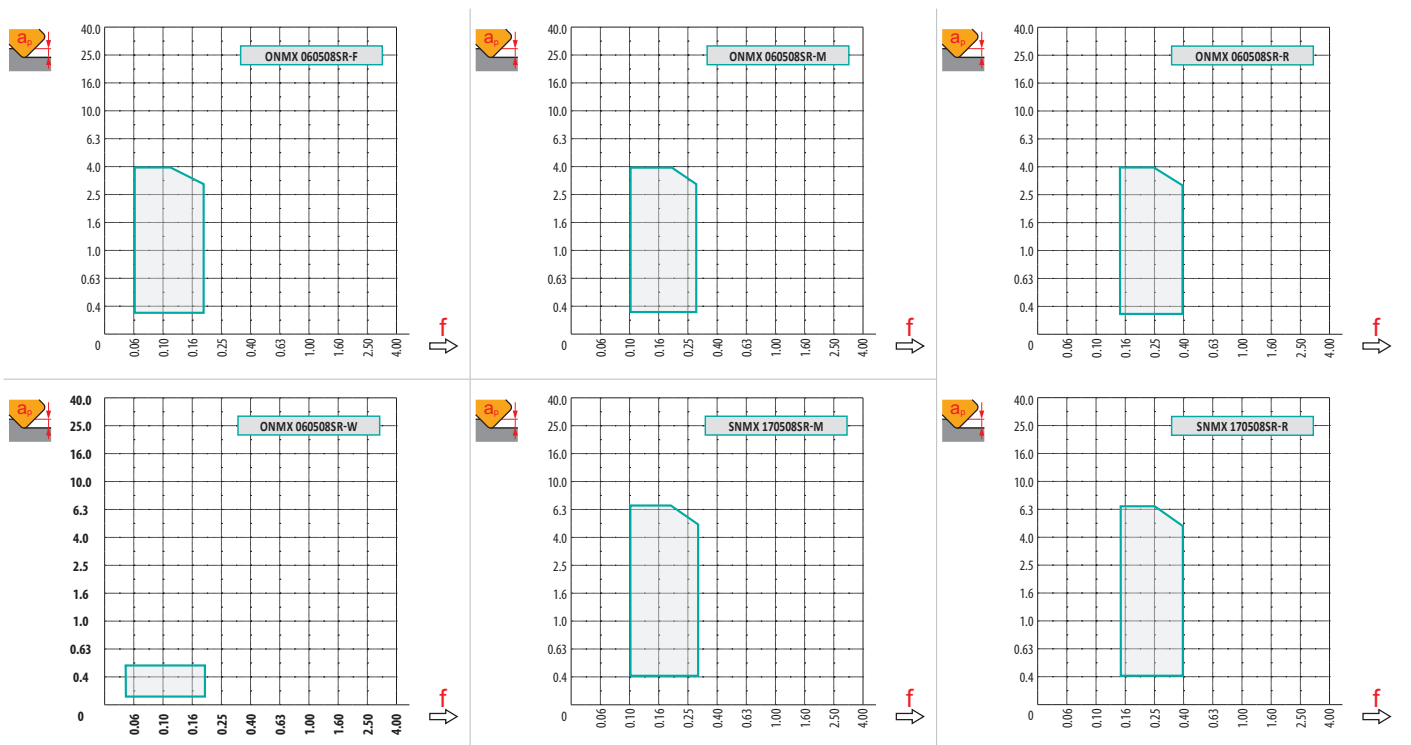

		0.50	1.00	1.50	2.00	2.50	3.00	3.50	4.00
50		51.06	52.11	53.19	54.27	55.35	56.43	57.51	58.59
63		64.06	65.11	66.19	67.27	68.35	69.43	70.51	71.59
80		81.06	82.11	83.19	84.27	85.35	86.43	87.51	88.59
100		101.06	102.11	103.19	104.27	105.35	106.43	107.51	108.59
125		126.06	127.11	128.19	129.27	130.35	131.43	132.51	133.59
160		161.06	162.11	163.19	164.27	165.35	166.43	167.51	168.59
200		201.06	202.11	203.19	204.27	205.35	206.43	207.51	208.59
250		251.06	252.11	253.19	254.27	255.35	256.43	257.51	258.59

DC		S							
		0.00	1.00	2.00	3.00	4.00	5.00	6.00	7.00
50	DEF	47.24	49.40	51.56	53.73	55.90	58.06	60.23	62.40
63		60.24	62.40	64.56	66.73	68.90	71.06	73.23	75.40
80		77.24	79.40	81.56	83.73	85.90	88.06	90.23	92.40
100		97.24	99.40	101.56	103.73	105.90	108.06	110.23	112.40
125		122.24	124.40	126.56	128.73	130.90	133.06	135.23	137.40
160		157.24	159.40	161.56	163.73	165.90	168.06	170.23	172.40
200		197.24	199.40	201.56	203.73	205.90	208.06	210.23	212.40
250		247.24	249.40	251.56	253.73	255.90	258.06	260.23	262.40

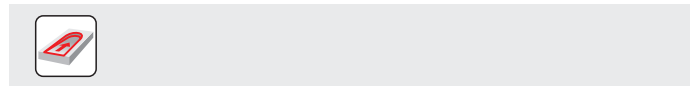
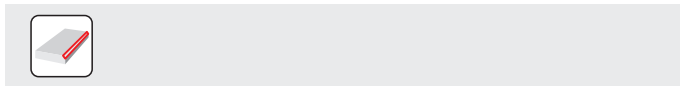

DC	X.V	f _{max}
50	1.35	0.36
63	1.39	0.40
80	1.44	0.45
100	1.48	0.51
125	1.53	0.57
160	1.58	0.64
200	1.63	0.72
250	1.68	0.80

DC	O	
	RPMX	APMX/I
50	0.3	0.4/100
63	0.2	0.25/100
80	0.2	0.2/100
100	0.1	0.1/100
125	0.1	0.05/100

DC	S	
	RPMX	APMX/I
47.24	0.1	0.1/100
60.24	0.1	0.05/100
77.24	0.1	0.05/100

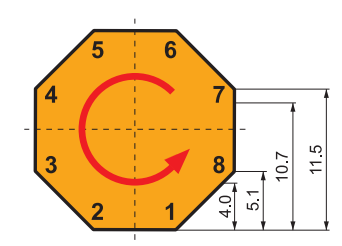

-> 4.0	16
-> 5.1	14
-> 10.7	8
-> 11.5	6

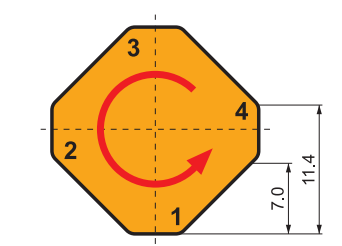

-> 7.0	8
-> 11.4	4

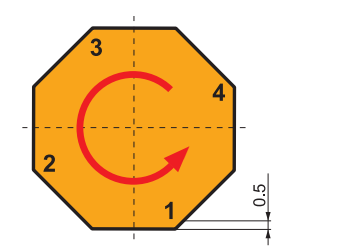

ONMX 06-W	
-> 0.5	8

SHN06C



PRAMET



ECON HN06 45° Planfräser in doppelt negativer Ausführung und Innenkühlung

Hochproduktive 45°-Planfräser mit doppelseitigen HN.. 06-Wendeschneidplatten mit einem APMX von 3 mm. Schruppen, Schlichten und Anfasen. Wirtschaftliche WSP mit 12 Schneidkanten. Ungleiche Zahnteilung. Als Weldon-, modularer Schaft und Aufsteckfräser erhältlich. Körper für längere Standzeiten oberflächenbehandelt.

KAPR	45°
APMX	3.0 mm

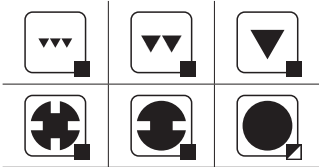
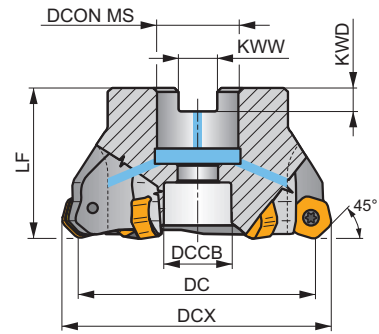
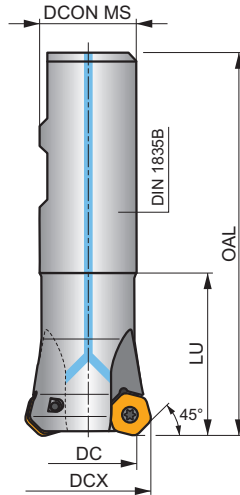
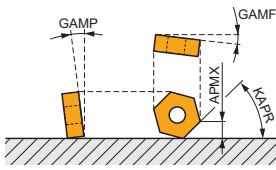

	0.06 - 0.15				
	0.06 - 0.15				

Produkt	DC	DCX	OAL	DCON MS	DCCB	LU	LF	KWW	KWD	GAMF	GAMP								
	(mm)	(mm)	(mm)	(mm)	(mm)	(mm)	(mm)	(mm)	(mm)	(°)	(°)			kg					
25N2R042B25-SHN06C-C	25	32.2	99	25	-	42	-	-	-	-7	-7	2	-	17400	✓	0.35	GI204	FA010	-
32N3R042B32-SHN06C-C	32	39.3	103	32	-	42	-	-	-	-7	-7	3	-	15400	✓	0.59	GI204	FA010	-
40A05R-S45HN06C-C	40	47.3	-	16	14	-	40	8.4	5.6	-7	-7	5	✓	13800	✓	0.37	GI204	FA012	-
50A04R-S45HN06C-C	50	57.3	-	22	18	-	40	10.4	6.3	-7	-7	4	✓	12300	✓	0.54	GI204	FA013	-
50A06R-S45HN06C-C	50	57.3	-	22	18	-	40	10.4	6.3	-7	-7	6	✓	12300	✓	0.41	GI204	FA013	-
63A06R-S45HN06C-C	63	70.3	-	22	18	-	40	10.4	6.3	-7	-7	6	✓	11000	✓	0.68	GI204	FA013	-
63A08R-S45HN06C-C	63	70.3	-	22	18	-	40	10.4	6.3	-7	-7	8	✓	11000	✓	0.68	GI204	FA013	-
80A07R-S45HN06C-C	80	86.8	-	27	38	-	50	12.4	7	-7	-7	7	✓	9700	✓	1.10	GI204	FA011	AC001
80A10R-S45HN06C-C	80	86.8	-	27	38	-	50	12.4	7	-7	-7	10	✓	9700	✓	1.10	GI204	FA011	AC001
100A08R-S45HN06C-C	100	107.1	-	32	45	-	50	14.4	8	-7	-7	8	✓	8700	✓	2.00	GI204	FA011	AC002
100A12R-S45HN06C-C	100	107.1	-	32	45	-	50	14.4	8	-7	-7	12	✓	8700	✓	1.82	GI204	FA011	AC002
125A10R-S45HN06C-C	125	132.2	-	40	56	-	63	16.4	9	-7	-7	10	✓	7800	✓	3.53	GI204	FA011	AC003

GI204	HNGX 0604AN..	XNGX 0604AN..

FA010	US 3007-T09P	2.0	M 3	7.3	-	-	Flag T09P
FA011	US 3007-T09P	2.0	M 3	7.3	D-T07P/T09P	FG-15	-
FA012	US 3007-T09P	2.0	M 3	7.3	D-T07P/T09P	FG-15	HS 0830C
FA013	US 3007-T09P	2.0	M 3	7.3	D-T07P/T09P	FG-15	HS 1030C

AC001	KS 1230	K.FMH27
AC002	KS 1635	K.FMH32
AC003	KS 2040	K.FMH40

HNGX 06



	IC	D1	S
	(mm)	(mm)	(mm)
0604	10.500	3.70	4.76

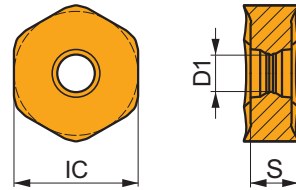

Eignung und Startwerte für Schnittgeschwindigkeit (vc), Vorschub (f) und Schnitttiefe (ap). Weitere Informationen finden Sie in unserer Zerspanungsrechner-App.

Produkt	RE (mm)	P			M			K			N			S			H		
		vc (m/min)	f (mm/tooth)	ap (mm)	vc (m/min)	f (mm/tooth)	ap (mm)	vc (m/min)	f (mm/tooth)	ap (mm)	vc (m/min)	f (mm/tooth)	ap (mm)	vc (m/min)	f (mm/tooth)	ap (mm)	vc (m/min)	f (mm/tooth)	ap (mm)

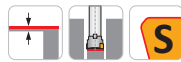
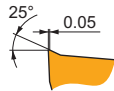

F geometrie mit hoch positiven Design zum Schlichten.

HNGX 0604ANSN-F:8215	☹	–	■	315	0.11	1.7	▣	185	0.10	1.7	■	–	–	–	–	–	–	–	–	–
HNGX 0604ANSN-F:M6330	☹	–	■	265	0.11	1.7	▣	185	0.10	1.7	■	–	–	–	–	–	–	–	–	–
HNGX 0604ANSN-F:M8330	☹	–	■	305	0.11	1.7	▣	180	0.10	1.7	■	–	–	–	–	–	–	–	–	–
HNGX 0604ANSN-F:M8340	☹	–	■	285	0.11	1.7	▣	170	0.10	1.7	■	–	–	–	–	–	–	–	–	–
HNGX 0604ANSN-F:M9340	☹	–	■	365	0.11	1.7	▣	215	0.10	1.7	■	–	–	–	–	–	–	–	–	–

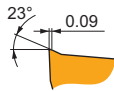

M geometrie mit sehr positiven Design zur mittleren Bearbeitung.

HNGX 0604ANSN-M:8215	☹	–	■	300	0.13	2.0	▣	180	0.13	2.0	■	285	0.13	2.0	–	–	–	–	–	–
HNGX 0604ANSN-M:M5315	☹	–	▣	425	0.13	2.0	–	–	–	–	■	400	0.13	2.0	–	–	–	–	–	–
HNGX 0604ANSN-M:M6330	☹	–	■	255	0.13	2.0	▣	180	0.13	2.0	■	–	–	–	–	–	–	–	–	–
HNGX 0604ANSN-M:M8310	☹	–	■	325	0.13	2.0	▣	165	0.13	2.0	■	305	0.13	2.0	–	–	–	–	–	–
HNGX 0604ANSN-M:M8330	☹	–	■	295	0.13	2.0	▣	175	0.13	2.0	■	280	0.13	2.0	–	–	–	–	–	–
HNGX 0604ANSN-M:M8340	☹	–	■	265	0.13	2.0	▣	155	0.13	2.0	▣	250	0.13	2.0	–	–	–	–	–	–
HNGX 0604ANSN-M:M9315	☹	–	■	410	0.13	2.0	–	–	–	–	■	385	0.13	2.0	–	–	–	–	–	–
HNGX 0604ANSN-M:M9325	☹	–	■	375	0.13	2.0	–	–	–	–	■	355	0.13	2.0	–	–	–	–	–	–
HNGX 0604ANSN-M:M9340	☹	–	■	345	0.13	2.0	▣	205	0.13	2.0	■	–	–	–	–	–	–	–	–	–

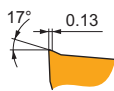

R geometrie mit sehr positiven Design zur mittleren bis schweren Bearbeitung.

HNGX 0604ANSN-R:8215	☹	–	■	280	0.18	1.8	▣	165	0.18	1.8	■	265	0.18	1.8	–	–	–	–	▣	55	0.12	1.0
HNGX 0604ANSN-R:M5315	☹	–	▣	370	0.18	1.8	–	–	–	–	■	350	0.18	1.8	–	–	–	–	▣	70	0.12	1.0
HNGX 0604ANSN-R:M8310	☹	–	■	300	0.18	1.8	▣	150	0.18	1.8	■	285	0.18	1.8	–	–	–	–	▣	60	0.12	1.0
HNGX 0604ANSN-R:M8330	☹	–	■	275	0.18	1.8	▣	165	0.18	1.8	■	260	0.18	1.8	–	–	–	–	▣	55	0.12	1.0
HNGX 0604ANSN-R:M8340	☹	–	■	250	0.18	1.8	▣	150	0.18	1.8	▣	235	0.18	1.8	–	–	–	–	–	–	–	–
HNGX 0604ANSN-R:M9325	☹	–	■	345	0.18	1.8	–	–	–	–	■	325	0.18	1.8	–	–	–	–	▣	65	0.12	1.0

XNGX 06



	IC	D1	S
	(mm)	(mm)	(mm)
0604	10.500	3.70	4.76

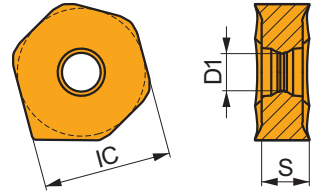

Eignung und Startwerte für Schnittgeschwindigkeit (vc), Vorschub (f) und Schnitttiefe (ap). Weitere Informationen finden Sie in unserer Zerspanungsrechner-App.

Produkt	RE (mm)	P			M			K			N			S			H		
		vc (m/min)	f (mm/tooth)	ap (mm)	vc (m/min)	f (mm/tooth)	ap (mm)	vc (m/min)	f (mm/tooth)	ap (mm)	vc (m/min)	f (mm/tooth)	ap (mm)	vc (m/min)	f (mm/tooth)	ap (mm)	vc (m/min)	f (mm/tooth)	ap (mm)

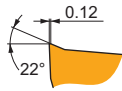

W wiper-Design für verbesserte Oberflächengüte.

XNGX 0604ANSN:8215	RE		290	0.13	1.8	170	0.12	1.8	275	0.13	1.8								
---------------------------	----	--	-----	------	-----	-----	------	-----	-----	------	-----	--	--	--	--	--	--	--	--



a_e / DC	5 %	10 %	15 %	20 %	25 %	30 %	40 %	50 %	60 %	70 %	75 %	80 %	90 %	100 %
	1.48	1.35	1.27	1.22	1.19	1.16	1.11	1.08	1.05	1.03	1.00	1.00	1.00	1.00
	2.20	1.60	1.35	1.20	1.10	0.95	0.85	0.75	0.85	0.95	1.00	1.00	1.00	1.00
	0.64	0.64	0.64	0.64	0.64	0.65	0.65	0.67	0.68	0.71	0.72	0.74	0.79	1.00

	HNGX 06-F	HNGX 06-M	HNGX 06-R	XNGX 06
	-	-	-	-
	1.12	0.80	0.80	4.15

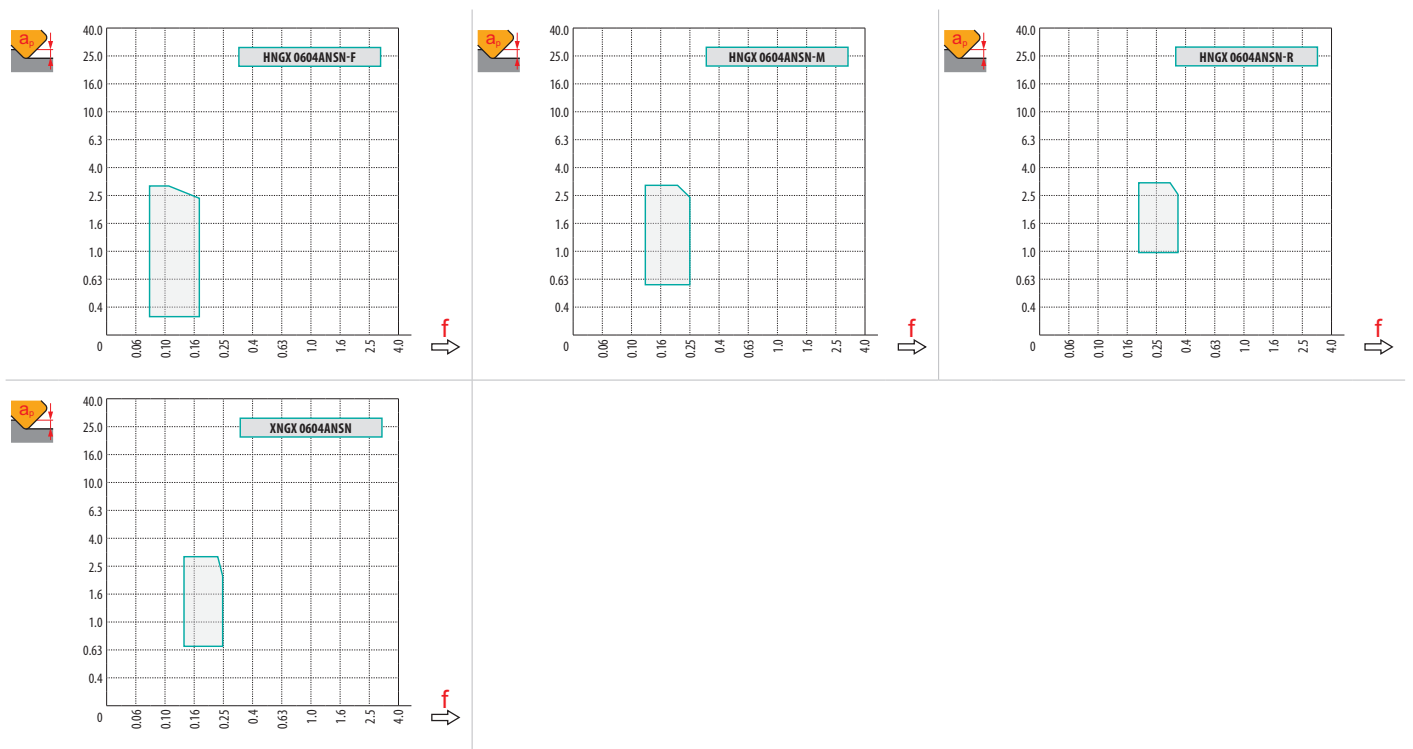

DC	X.V	f_{max}	DC	RPMX	APMX/I	a_e		
25	1.31	0.24	25	2.7°	3.0/65	0.9		
32	1.36	0.28	32	1.9°	3.0/89			
40	1.40	0.31	40	1.5°	2.5/100			
50	1.45	0.35	50	1.1°	1.9/100			
63	1.49	0.39	63	0.9°	1.4/100			
80	1.54	0.44	80	0.6°	1.0/100			
100	1.59	0.49	100	0.5°	0.8/100			
125	1.64	0.55	125	0.4°	0.6/100			

SHN09C



PRAMET

S



ECON HN09 45° Planfräser in doppelt negativer Ausführung und Innenkühlung

Hochproduktive 45°-Planfräser mit doppelseitigen HN..09-Wendeschneidplatten mit einem APMX von 5 mm. Schruppen, Schlichten und Anfasen. Wirtschaftliche WSP mit 12 Schneidkanten. Ungleiche Zahnteilung. Nur als Aufsteckfräser. Körper für längere Standzeiten oberflächenbehandelt.

KAPR	45°
APMX	5.0 mm

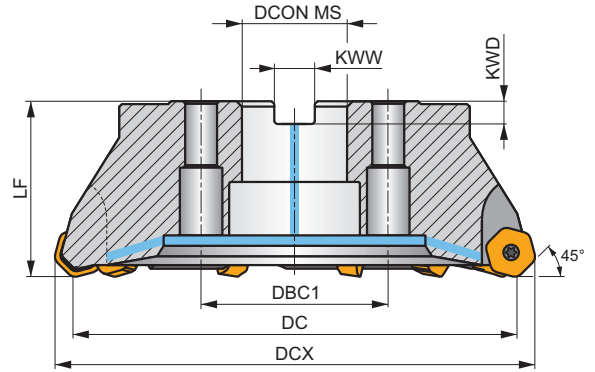
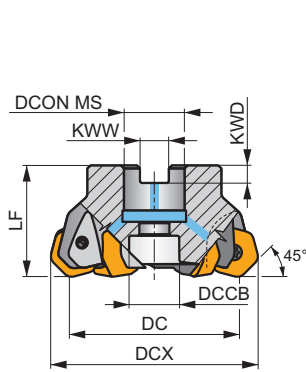
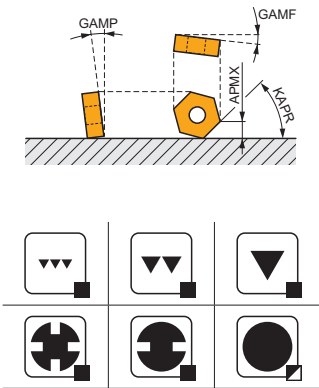

0.08 - 0.25



Produkt	DC	DCX	LF	D CON MS	DCCB	DBC1	KWW	KWD	GAMP	GAMP									
	(mm)	(mm)	(mm)	(mm)	(mm)	(mm)	(mm)	(mm)	(°)	(°)									
50A04R-S45HN09C-CF	50	61.7	40	22	18	-	10.4	6.3	-7	-7	4	✓	7900	✓	0.38	GI252	FA023	-	-
63A06R-S45HN09C-CF	63	74.7	40	22	18	-	10.4	6.3	-7	-7	6	✓	7000	✓	0.54	GI252	FA023	-	-
80A06R-S45HN09C-CF	80	91.7	50	27	38	-	12.4	7	-7	-7	6	✓	6200	✓	1.06	GI252	FA021	AC001	-
80A08R-S45HN09C-CF	80	91.7	50	27	38	-	12.4	7	-7	-7	8	✓	6200	✓	1.06	GI252	FA021	AC001	-
100A06R-S45HN09C-CF	100	111.7	50	32	45	-	14.4	8	-7	-7	6	✓	5600	✓	1.95	GI252	FA021	AC002	-
100A08R-S45HN09C-CF	100	111.7	50	32	45	-	14.4	8	-7	-7	8	✓	5600	✓	1.99	GI252	FA021	AC002	-
100A10R-S45HN09C-CF	100	111.7	50	32	45	-	14.4	8	-8	-7	10	-	5600	✓	1.99	GI252	FA021	AC002	-
125A06R-S45HN09C-CF	125	136.7	63	40	56	-	16.4	9	-7	-7	6	✓	5000	✓	3.36	GI252	FA021	AC003	-
125A08R-S45HN09C-CF	125	136.7	63	40	56	-	16.4	9	-7	-7	8	✓	4900	✓	3.66	GI252	FA021	AC003	-
125A10R-S45HN09C-CF	125	136.7	63	40	56	-	16.4	9	-7	-7	10	✓	5000	✓	3.52	GI252	FA021	AC003	-
125A12R-S45HN09C-CF	125	136.7	63	40	56	-	16.4	9	-8	-7	12	-	5000	✓	3.36	GI252	FA021	AC003	-
160C08R-S45HN09C-CF	160	171.7	63	40	-	66.7	16.4	9	-7	-7	8	✓	4400	✓	6.24	GI252	FA026	-	-
160C12R-S45HN09C-CF	160	171.7	63	40	-	66.7	16.4	9	-7	-7	12	✓	4400	✓	6.45	GI252	FA026	-	-
160C14R-S45HN09C-CF	160	171.7	63	40	-	66.7	16.4	9	-7	-7	14	✓	4400	✓	6.39	GI252	FA026	-	-
200C10R-S45HN09C-CF	200	211.7	63	60	-	101.6	25.7	14	-7	-7	10	✓	3900	✓	11.37	GI252	FA027	-	-
250C14R-S45HN09C-CF	250	261.7	63	60	-	101.6	25.7	14	-7	-7	14	✓	3500	✓	18.50	GI252	FA028	-	-
315C16R-S45HN09C-CF	315	326.7	80	60	-	101.6	25.7	14	-7	-7	16	✓	3100	✓	37.00	GI252	FA029	-	-

GI252	HNGX 0906AN..	XNGX 0906AN..

FA021	US 54511-T15P	5.0	M 4.5	11	D-T08P/T15P	FG-15	-	-
FA023	US 54511-T15P	5.0	M 4.5	11	D-T08P/T15P	FG-15	HS 1030C	-

FA026	US 54511-T15P	5.0	M 4.5	11	D-T08P/T15P	FG-15	HS 1240C	CAC 160C	HSD 0825C	HXK 5	-	-
FA027	US 54511-T15P	5.0	M 4.5	11	D-T08P/T15P	FG-15	HS 1655C	CAC 200C	HSD 1025C	HXK 7	-	-
FA028	US 54511-T15P	5.0	M 4.5	11	D-T08P/T15P	FG-15	HS 1655C	CAC 250C	HSD 1025C	HXK 7	-	-
FA029	US 54511-T15P	5.0	M 4.5	11	D-T08P/T15P	FG-15	HS 1655C	CAC 315C	HSD 1035C	HXK 7	CACP 3150C	RRH 34

AC001	KS 1230	K.FMH27
AC002	KS 1635	K.FMH32
AC003	KS 2040	K.FMH40

HNGX 09



	IC	D1	S
	(mm)	(mm)	(mm)
0906	16.500	4.90	6.35

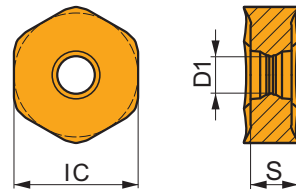

Eignung und Startwerte für Schnittgeschwindigkeit (vc), Vorschub (f) und Schnitttiefe (ap). Weitere Informationen finden Sie in unserer Zerspanungsrechner-App.

Produkt	RE (mm)	P			M			K			N			S			H		
		vc (m/min)	f (mm/tooth)	ap (mm)	vc (m/min)	f (mm/tooth)	ap (mm)	vc (m/min)	f (mm/tooth)	ap (mm)	vc (m/min)	f (mm/tooth)	ap (mm)	vc (m/min)	f (mm/tooth)	ap (mm)	vc (m/min)	f (mm/tooth)	ap (mm)

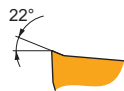

FF geometrie mit sehr positiven Design zur leichten Bearbeitung.

HNGX 0906ANEN-FF:8215	●	-	■	345	0.10	1.0	■	205	0.09	1.0	■	-	-	-	-	-	-	-	-
HNGX 0906ANEN-FF:M8330	●	-	■	335	0.10	1.0	■	200	0.09	1.0	■	-	-	-	-	-	-	-	-
HNGX 0906ANEN-FF:M9340	●	-	■	405	0.10	1.0	■	240	0.09	1.0	■	-	-	-	-	-	-	-	-

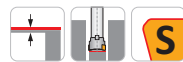
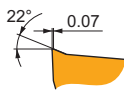

F geometrie mit hoch positiven Design zum Schlichten bis mittleren Bearbeitung.

HNGX 0906ANSN-F:8215	⊕	-	■	300	0.12	2.1	■	180	0.11	2.1	■	-	-	-	-	-	-	-	-
HNGX 0906ANSN-F:M6330	⊕	-	■	255	0.12	2.1	■	180	0.11	2.1	■	-	-	-	-	-	-	-	-
HNGX 0906ANSN-F:M8310	⊕	-	■	330	0.12	2.1	■	165	0.11	2.1	■	-	-	-	-	-	-	-	-
HNGX 0906ANSN-F:M8330	⊕	-	■	300	0.12	2.1	■	180	0.11	2.1	■	-	-	-	-	-	-	-	-
HNGX 0906ANSN-F:M8340	⊕	-	■	270	0.12	2.1	■	160	0.11	2.1	■	-	-	-	-	-	-	-	-

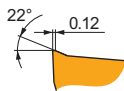

M geometrie mit sehr positiven Design zur mittleren Bearbeitung.

HNGX 0906ANSN-M:8215	⊕	-	■	255	0.20	2.7	■	150	0.18	2.7	■	240	0.20	2.7	-	-	-	-	-
HNGX 0906ANSN-M:M5315	⊕	-	■	340	0.20	2.7	■	-	-	-	■	320	0.20	2.7	-	-	-	-	-

Eignung und Startwerte für Schnittgeschwindigkeit (vc), Vorschub (f) und Schnitttiefe (ap). Weitere Informationen finden Sie in unserer Zerspanungsrechner-App.

Produkt	RE (mm)	P			M			K			N			S			H		
		vc (m/min)	f (mm/tooth)	ap (mm)	vc (m/min)	f (mm/tooth)	ap (mm)	vc (m/min)	f (mm/tooth)	ap (mm)	vc (m/min)	f (mm/tooth)	ap (mm)	vc (m/min)	f (mm/tooth)	ap (mm)	vc (m/min)	f (mm/tooth)	ap (mm)

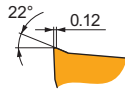

M geometrie mit sehr positiven Design zur mittleren Bearbeitung.

HNGX 0906ANSN-M:M6330	✳	–	■	220	0.20	2.7	▣	155	0.18	2.7	■	–	–	–	–	–	–	–	–	–
HNGX 0906ANSN-M:M8310	✳	–	■	280	0.20	2.7	▣	140	0.18	2.7	■	265	0.20	2.7	–	–	–	–	–	–
HNGX 0906ANSN-M:M8330	✳	–	■	255	0.20	2.7	▣	150	0.18	2.7	■	240	0.20	2.7	–	–	–	–	–	–
HNGX 0906ANSN-M:M8340	✳	–	■	235	0.20	2.7	▣	140	0.18	2.7	▣	220	0.20	2.7	–	–	–	–	–	–
HNGX 0906ANSN-M:M9315	✳	–	■	340	0.20	2.7	▣	–	–	–	■	320	0.20	2.7	–	–	–	–	–	–
HNGX 0906ANSN-M:M9325	✳	–	■	315	0.20	2.7	▣	–	–	–	■	295	0.20	2.7	–	–	–	–	–	–
HNGX 0906ANSN-M:M9340	✳	–	■	290	0.20	2.7	▣	170	0.18	2.7	■	–	–	–	–	–	–	–	–	–

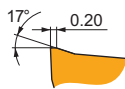

R geometrie mit positiven Design zur mittleren bis schweren Bearbeitung.

HNGX 0906ANSN-R:8215	✳	–	■	240	0.25	3.0	▣	140	0.25	3.0	■	225	0.25	3.0	–	–	–	–	▣	45	0.13	1.0
HNGX 0906ANSN-R:M5315	✳	–	▣	305	0.25	3.0	▣	–	–	–	■	285	0.25	3.0	–	–	–	–	▣	60	0.13	1.0
HNGX 0906ANSN-R:M8310	✳	–	■	260	0.25	3.0	▣	130	0.25	3.0	■	245	0.25	3.0	–	–	–	–	▣	50	0.13	1.0
HNGX 0906ANSN-R:M8330	✳	–	■	240	0.25	3.0	▣	140	0.25	3.0	■	225	0.25	3.0	–	–	–	–	▣	45	0.13	1.0
HNGX 0906ANSN-R:M8340	✳	–	■	220	0.25	3.0	▣	130	0.25	3.0	▣	205	0.25	3.0	–	–	–	–	–	–	–	–
HNGX 0906ANSN-R:M9315	✳	–	■	310	0.25	3.0	▣	–	–	–	■	290	0.25	3.0	–	–	–	–	▣	60	0.13	1.0
HNGX 0906ANSN-R:M9325	✳	–	■	295	0.25	3.0	▣	–	–	–	■	280	0.25	3.0	–	–	–	–	▣	55	0.13	1.0

XNGX 09

PRAMET

	IC (mm)	D1 (mm)	S (mm)
0906	16.500	4.90	6.35

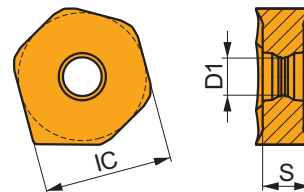

Eignung und Startwerte für Schnittgeschwindigkeit (vc), Vorschub (f) und Schnitttiefe (ap). Weitere Informationen finden Sie in unserer Zerspanungsrechner-App.

Produkt	RE (mm)	P			M			K			N			S			H		
		vc (m/min)	f (mm/tooth)	ap (mm)	vc (m/min)	f (mm/tooth)	ap (mm)	vc (m/min)	f (mm/tooth)	ap (mm)	vc (m/min)	f (mm/tooth)	ap (mm)	vc (m/min)	f (mm/tooth)	ap (mm)	vc (m/min)	f (mm/tooth)	ap (mm)

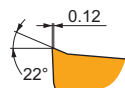

W wiper-Design für verbesserte Oberflächengüte.

XNGX 0906ANSN:8215	✳	–	■	245	0.20	2.7	▣	145	0.18	2.7	■	230	0.20	2.7	–	–	–	–	–	–	–
XNGX 0906ANSN:M8330	✳	–	■	245	0.20	2.7	▣	145	0.18	2.7	■	230	0.20	2.7	–	–	–	–	–	–	–



a_e / DC	5 %	10 %	15 %	20 %	25 %	30 %	40 %	50 %	60 %	70 %	75 %	80 %	90 %	100 %
	1.48	1.35	1.27	1.22	1.19	1.16	1.11	1.08	1.05	1.03	1.00	1.00	1.00	1.00
	2.20	1.60	1.35	1.20	1.10	0.95	0.85	0.75	0.85	0.95	1.00	1.00	1.00	1.00
	0.64	0.64	0.64	0.64	0.64	0.65	0.65	0.67	0.68	0.71	0.72	0.74	0.79	1.00

	HNGX 09-FF	HNGX 09-F	HNGX 09-M	HNGX 09-R	XNGX 09
	-	-	-	-	-
	1.50	1.17	1.17	1.17	7.53

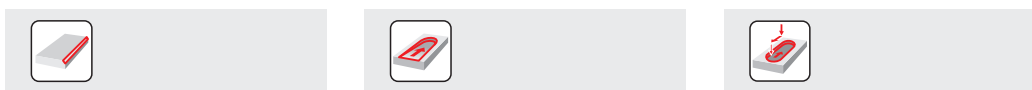
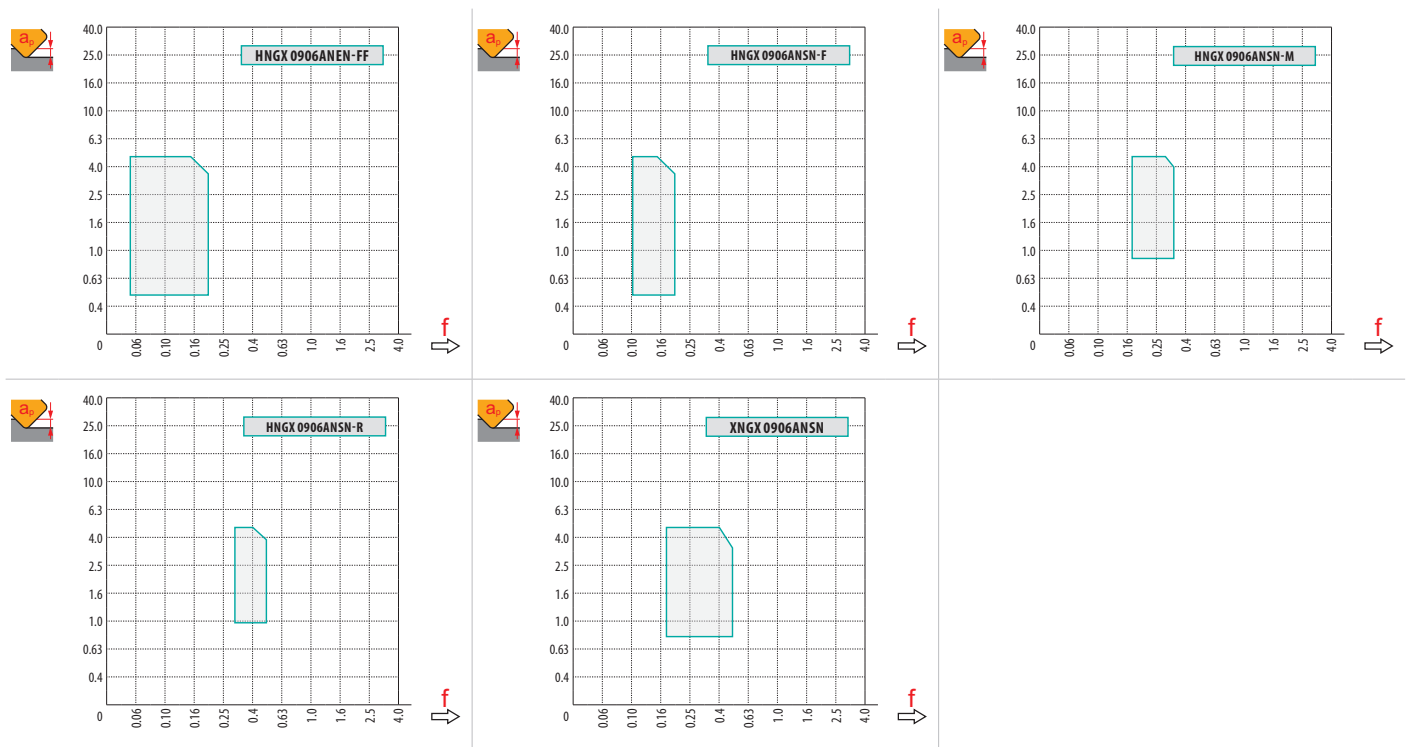

DC	X.V	f_{max}
50	1.35	0.36
63	1.39	0.40
80	1.44	0.45
100	1.48	0.51
125	1.53	0.57
160	1.58	0.64
200	1.63	0.72
250	1.68	0.80
315	1.74	0.90

DC	RPMX	APMX/II
50	2.1°	3.5/100
63	1.5°	2.5/100
80	1.1°	1.8/100
100	0.9°	1.4/100
125	0.7°	1.1/100
160	0.5°	0.7/100

a_e	1.9
-------	-----

SPN13



PRAMET



PENTA HD 57° Planfräser in doppelt negativer Ausführung zum schweren Planfräsen

Hochproduktive 57°-Planfräser mit doppelseitigen PN.. 13- und XN.. 13-Wendeschneidplatten mit einem APMX von 10 mm. Geeignet zum Planfräsen. Nur als Aufsteckfräser. Ein mit einer Unterlegplatte geschützter Plattensitz. Körper für längere Standzeiten oberflächenbehandelt.

PENTA HD

KAPR	57°
APMX	10.0 mm

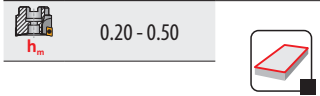
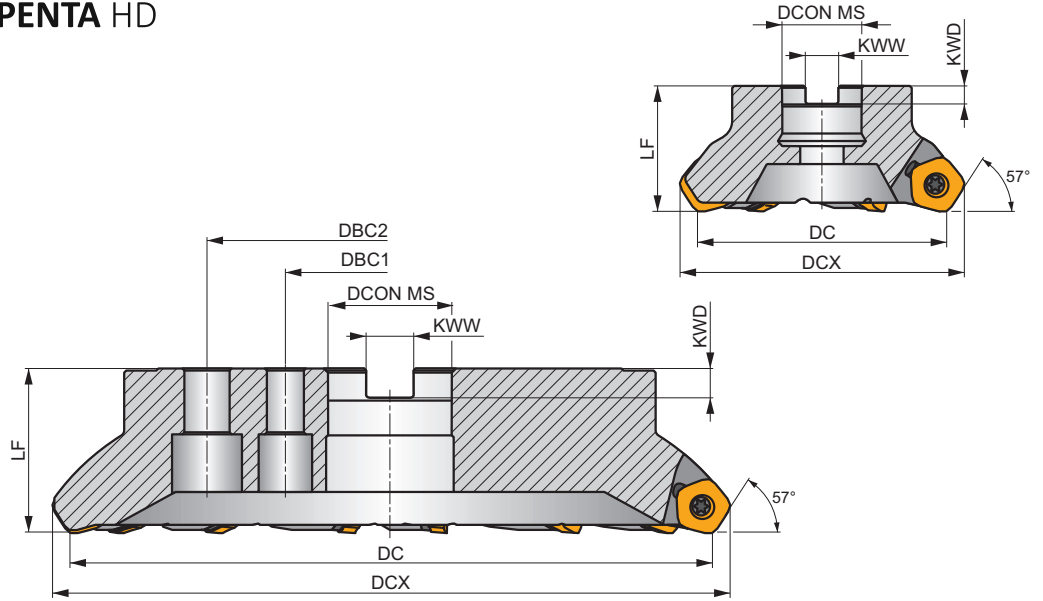
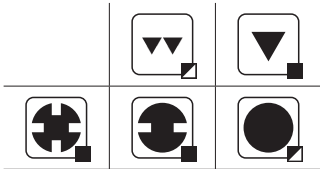
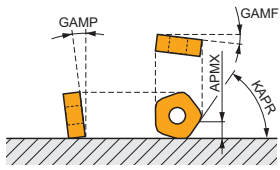

Produkt	DC	DCX	LF	DCON MS	DBC1	DBC2	KWW	KWD	GAMF	GAMP						
	(mm)	(mm)	(mm)	(mm)	(mm)	(mm)	(mm)	(mm)	(°)	(°)			kg			
100A05R-S57PN13	100	115.8	50	32	-	-	14.4	8	-8.2	-4	5	-	3400	-	1.22	GI261 FA081 AC002
125A06R-S57PN13	125	140.8	63	40	-	-	16.4	9	-7	-4	6	-	3100	-	2.79	GI261 FA081 AC003
160C08R-S57PN13	160	175.8	63	40	66.7	-	16.4	9	-6	-4	8	-	2700	-	3.58	GI261 FA081 -
200C10R-S57PN13	200	215.8	63	60	101.6	-	25.7	14	-5	-4	10	-	2400	-	9.17	GI261 FA081 -
250C12R-S57PN13	250	265.8	63	60	101.6	-	25.7	14	-5	-4	12	-	2200	-	15.39	GI261 FA081 -
315C14R-S57PN13	315	330.8	80	60	101.6	177.8	25.7	14	-5	-4	14	-	1900	-	29.17	GI261 FA081 -

GI261	PNMU 1308DN..	XNGX 1308DNSN	PNMQ 1308DN..

FA081	SPN 13T3DN	US 64010-T15P	SDRT15P	US 68026-T30P	15.0	M 8	26	SDRT30P-T

AC002	KS 1635	K.FMH32
AC003	KS 2040	K.FMH40

PNMU 13



	BS	IC	D1	L	S
	(mm)	(mm)	(mm)	(mm)	(mm)
1308	3.00	24.400	10.00	13.00	7.94

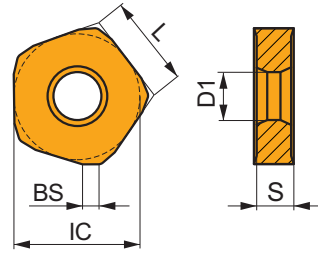

Eignung und Startwerte für Schnittgeschwindigkeit (vc), Vorschub (f) und Schnitttiefe (ap). Weitere Informationen finden Sie in unserer Zerspanungsrechner-App.

Produkt	RE (mm)	P			M			K			N			S			H		
		vc (m/min)	f (mm/tooth)	ap (mm)	vc (m/min)	f (mm/tooth)	ap (mm)	vc (m/min)	f (mm/tooth)	ap (mm)	vc (m/min)	f (mm/tooth)	ap (mm)	vc (m/min)	f (mm/tooth)	ap (mm)	vc (m/min)	f (mm/tooth)	ap (mm)

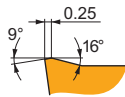

M geometrie mit positiven Design zur Schruppbearbeitung.

PNMU 1308DNSR-M:8215	✳	–	█	165	0.35	6.5	▣	95	0.32	6.5	█	155	0.35	6.5	–	–	–	▣	40	0.28	5.2	█	30	0.18	2.0
PNMU 1308DNSR-M:M8330	✳	–	█	190	0.35	6.5	▣	110	0.32	6.5	█	180	0.35	6.5	–	–	–	▣	45	0.28	5.2	█	35	0.18	2.0
PNMU 1308DNSR-M:M8345	✳	–	█	135	0.35	6.5	▣	80	0.32	6.5	–	–	–	–	–	–	–	▣	30	0.28	5.2	–	–	–	
PNMU 1308DNSR-M:M9315	✳	–	█	210	0.35	6.5	–	–	–	–	█	195	0.35	6.5	–	–	–	–	–	–	–	▣	40	0.18	2.0
PNMU 1308DNSR-M:M9340	✳	–	█	170	0.35	6.5	▣	100	0.32	6.5	–	–	–	–	–	–	–	▣	40	0.28	5.2	–	–	–	

PNMQ 13



	BS	IC	D1	L	S
	(mm)	(mm)	(mm)	(mm)	(mm)
1308	3.00	24.400	10.00	13.00	7.94

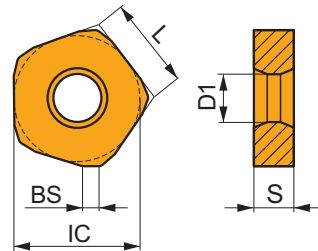

Eignung und Startwerte für Schnittgeschwindigkeit (vc), Vorschub (f) und Schnitttiefe (ap). Weitere Informationen finden Sie in unserer Zerspanungsrechner-App.

Produkt	RE (mm)	P			M			K			N			S			H		
		vc (m/min)	f (mm/tooth)	ap (mm)	vc (m/min)	f (mm/tooth)	ap (mm)	vc (m/min)	f (mm/tooth)	ap (mm)	vc (m/min)	f (mm/tooth)	ap (mm)	vc (m/min)	f (mm/tooth)	ap (mm)	vc (m/min)	f (mm/tooth)	ap (mm)

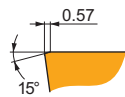

SN ohne Spanwinkel, besonders geeignet für die Schruppbearbeitung.

PNMQ 1308DNSN:M8330	✳	–	▣	165	0.60	6.5	–	–	–	–	█	155	0.60	6.5	–	–	–	–	–	–	–	▣	30	0.30	2.0
PNMQ 1308DNSN:M8345	✳	–	▣	120	0.60	6.5	–	–	–	–	–	–	–	–	–	–	–	–	–	–	–	–	–	–	

XNGX 13



	IC	D1	S
	(mm)	(mm)	(mm)
1308	24.180	10.00	7.94

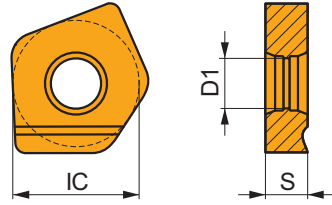

Eignung und Startwerte für Schnittgeschwindigkeit (vc), Vorschub (f) und Schnitttiefe (ap). Weitere Informationen finden Sie in unserer Zerspanungsrechner-App.

Produkt	RE (mm)	P			M			K			N			S			H		
		vc (m/min)	f (mm/tooth)	ap (mm)	vc (m/min)	f (mm/tooth)	ap (mm)	vc (m/min)	f (mm/tooth)	ap (mm)	vc (m/min)	f (mm/tooth)	ap (mm)	vc (m/min)	f (mm/tooth)	ap (mm)	vc (m/min)	f (mm/tooth)	ap (mm)

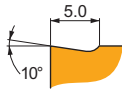

W wiper-Design für verbesserte Oberflächengüte.

XNGX 1308DNSN:M8330	✳	-	■	245	0.45	2.5	■	-	-	-	■	230	0.45	2.5	■	-	-	-	■	-	-	-
----------------------------	---	---	---	-----	------	-----	---	---	---	---	---	-----	------	-----	---	---	---	---	---	---	---	---







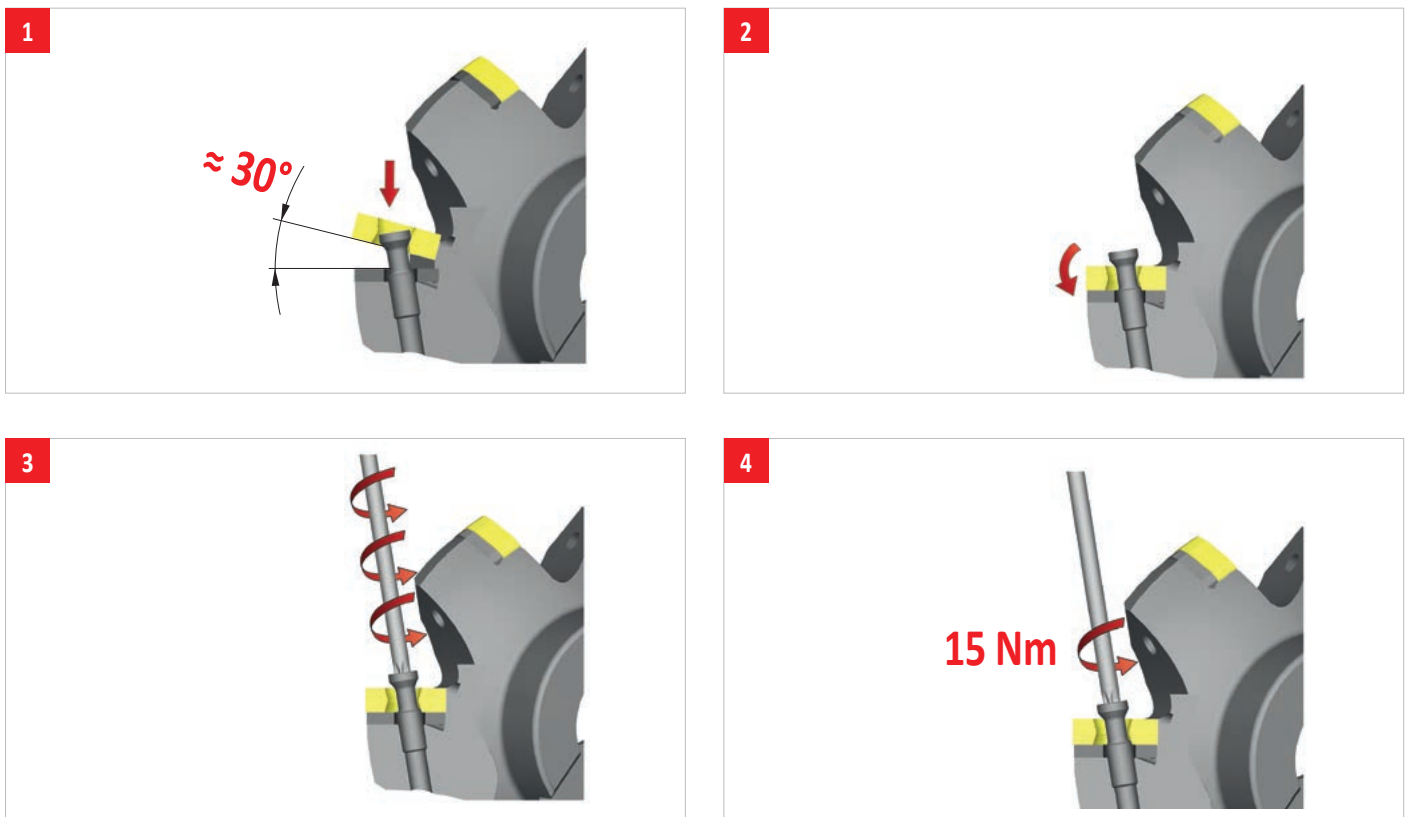
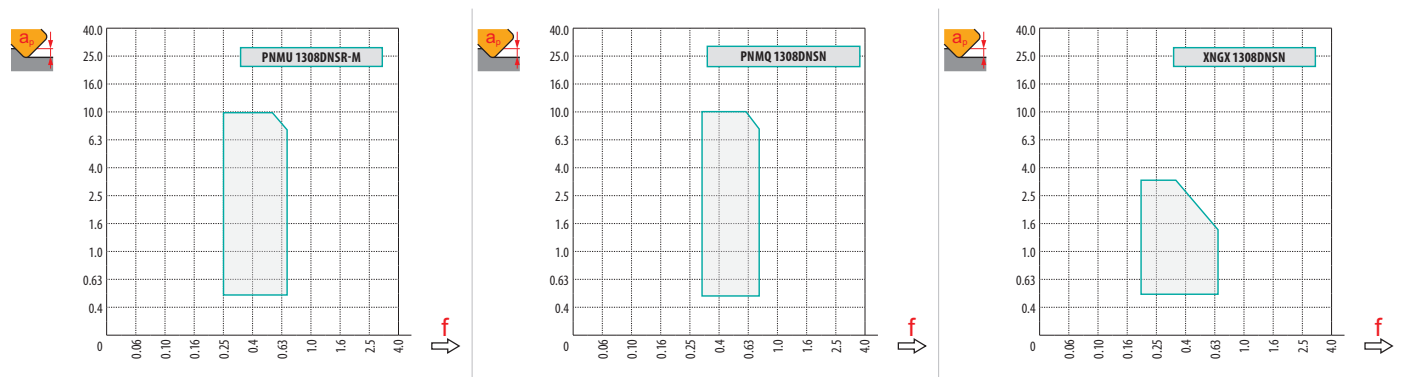









a_e / DC	5 %	10 %	15 %	20 %	25 %	30 %	40 %	50 %	60 %	70 %	75 %	80 %	90 %	100 %
	1.48	1.35	1.27	1.22	1.19	1.16	1.11	1.08	1.05	1.03	1.00	1.00	1.00	1.00
	2.20	1.60	1.35	1.20	1.10	0.95	0.85	0.75	0.85	0.95	1.00	1.00	1.00	1.00
	0.64	0.64	0.64	0.64	0.64	0.65	0.65	0.67	0.68	0.71	0.72	0.74	0.79	1.00

	PNMU 13-M	PNMQ 13	XNGX 13
	-	-	-
	3.00	3.00	12.71



WENDEPLATTENFRÄSER – AUSWAHLHILFE

PLANFRÄSEN

	SSD13F	SSE09	SSN12Z	FSB22X																
	45°		45°		45°		60°													
	APMX (mm)	6.4	APMX (mm)	4.5	APMX (mm)	6.5	APMX (mm)	15.0												
	DC (mm)	32 – 250	DC (mm)	20 – 160	DC (mm)	63 – 125	DC (mm)	125 – 250												
Zylindrischer Schaft																				
Weldon		DC = 32, 40 (mm)		DC = 20 – 32 (mm)																
Modular																				
Aufsteckfräser		DC = 40 – 250 (mm)		DC = 32 – 160 (mm)																
Seite	📖 26		📖 31		📖 35		📖 38													
ISO	P	M	K	N	S	H	P	M	K	S	P	M	K	S	P	M	K	S		
Schneidplattenform																				
Wendeschneidplatten	SDET 13T3 SDMT 13T3 XDET 13T3		SE.T 09T3		SN.T 1205		SB.. 2207													
Anzahl der Schneiden	4 / 4 / 1		4		4		4 / 1													
Planfräsen 	■		■		■		■													
Fasenfräsen 	■		■		■															
Schraubenlinien- interpolation 	▣																			
Progressives Tauchfräsen 	▣																			
Rampen 	▣																			

SSD13F

P **M** **K** **N** **S** **H**

PRAMET

S



VER SD13 45° Planfräser mit positiver Ausführung und Innenkühlung

Äußerst vielseitiger 45° Planfräser mit einseitiger SD.. 13 Wendeschneidplatten mit APMX von 6,4 mm. Geeignet für ein breites Anwendungsspektrum in allen Werkstückstoffen. Weldon- und Aufsteckausführung erhältlich, mit ungleicher Zahnteilung. Trägerwerkzeug ausgelegt für längere Standzeit, Vollhartmetallunterlegplatte auf dem Plattensitz für höhere Prozesssicherheit.

KAPR	45°
APMX	6.4 mm

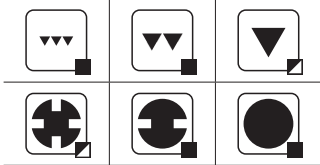
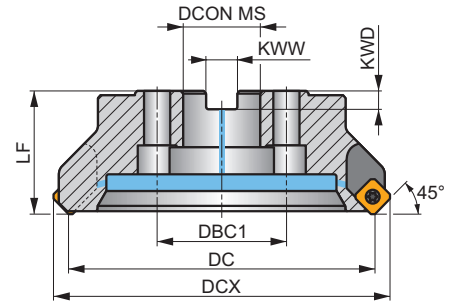
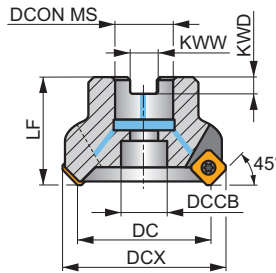
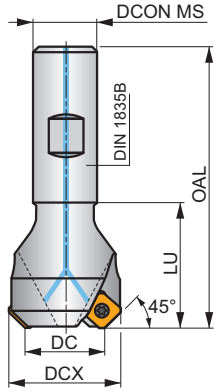
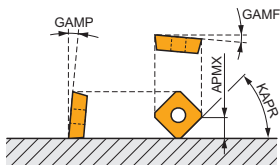

h_m	0.04 - 0.28
h_m	0.04 - 0.32



Produkt	DC	DCX	OAL	DCON MS	DCCB	DBC1	LU	LF	KWW	KWD	GAMF	GAMP								
	(mm)	(mm)	(mm)	(mm)	(mm)	(mm)	(mm)	(mm)	(mm)	(mm)	(°)	(°)								
32N3R045B25-SSD13F-C	32	44.9	120	25	-	-	45	-	-	-	-15	15	3	-	16100	✓	0.43	GI341	CO610	-
40N3R045B32-SSD13F-C	40	53.5	120	32	-	-	45	-	-	-	-7	15	3	-	14400	✓	0.72	GI341	CO610	-
40A03R-S45SD13F-C	40	53.5	-	16	14	-	-	40	8.4	5.6	-7	15	3	-	14400	✓	0.27	GI341	CO611	-
50A04R-S45SD13F-C	50	63.5	-	22	18	-	-	40	10.4	6.3	-7	15	4	✓	12900	✓	0.51	GI341	CO612	-
63A05R-S45SD13F-C	63	76.4	-	22	18	-	-	40	10.4	6.3	-7	15	5	✓	11500	✓	0.53	GI341	CO612	-
80A07R-S45SD13F-C	80	93.4	-	27	22	-	-	50	12.4	7	-7	15	7	✓	10200	✓	1.21	GI341	CO613	AC001
100A08R-S45SD13F-C	100	112.9	-	32	45	-	-	50	14.4	8	-12	15	8	✓	9100	✓	1.83	GI341	CO613	AC002
100A10R-S45SD13F-C	100	112.9	-	32	45	-	-	50	14.4	8	-12	15	10	-	9100	✓	1.94	GI341	CO613	AC002
125A08R-S45SD13F-C	125	137.8	-	40	56	-	-	63	16.4	9	-12	15	8	✓	8100	✓	3.41	GI341	CO613	AC003
125A12R-S45SD13F-C	125	137.8	-	40	56	-	-	63	16.4	9	-12	15	12	-	8100	✓	3.31	GI341	CO613	AC003
160C10R-S45SD13F-C	160	172.8	-	40	-	66.7	-	63	16.4	9	-12	15	10	✓	7200	✓	6.68	GI341	CO614	-
160C14R-S45SD13F-C	160	172.8	-	40	-	66.7	-	63	16.4	9	-12	15	14	✓	7200	✓	6.62	GI341	CO614	-
200C12R-S45SD13F-C	200	212.8	-	60	-	101.6	-	63	25.7	14	-12	15	12	✓	6400	✓	9.06	GI341	CO615	-
200C16R-S45SD13F-C	200	212.8	-	60	-	101.6	-	63	25.7	14	-12	15	16	✓	6400	✓	11.85	GI341	CO615	-
250C14R-S45SD13F-C	250	262.8	-	60	-	101.6	-	63	25.7	14	-12	15	14	✓	5700	✓	19.50	GI341	CO616	-
250C20R-S45SD13F-C	250	262.8	-	60	-	101.6	-	63	25.7	14	-12	15	20	✓	5700	✓	19.20	GI341	CO616	-

GI341	SDET 13T3..	SDMT 13T3..	XDET 13T3..

C0610	US 63513-T15P	3.0	M 3.5	13	Flag T15P	-	-	-	SDW 1103AF	MS 3507	HXK 3.5	-	-	-
C0611	US 63513-T15P	3.0	M 3.5	13	-	D-T08P/T15P	FG-15	HS 0830C	SDW 1103AF	MS 3507	HXK 3.5	-	-	-
C0612	US 63513-T15P	3.0	M 3.5	13	-	D-T08P/T15P	FG-15	HSD 1025C	SDW 1103AF	MS 3507	HXK 3.5	-	-	-
C0613	US 63513-T15P	3.0	M 3.5	13	-	D-T08P/T15P	FG-15	-	SDW 1103AF	MS 3507	HXK 3.5	-	-	-
C0614	US 63513-T15P	3.0	M 3.5	13	-	D-T08P/T15P	FG-15	HS 1240C	SDW 1103AF	MS 3507	HXK 3.5	CAC 160C	HSD 0825C	HXK 5
C0615	US 63513-T15P	3.0	M 3.5	13	-	D-T08P/T15P	FG-15	HS 1655C	SDW 1103AF	MS 3507	HXK 3.5	CAC 200C	HSD 1025C	HXK 7
C0616	US 63513-T15P	3.0	M 3.5	13	-	D-T08P/T15P	FG-15	HS 1655C	SDW 1103AF	MS 3507	HXK 3.5	CAC 250C	HSD 1025C	HXK 7

AC001	KS 1230	K.FMH27
AC002	KS 1635	K.FMH32
AC003	KS 2040	K.FMH40

SDET 13



	IC	D1	M	S
	(mm)	(mm)	(mm)	(mm)
13T3	13.385	4.40	1.5	3.97

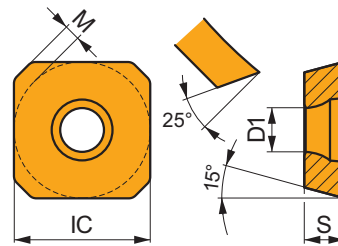

Eignung und Startwerte für Schnittgeschwindigkeit (vc), Vorschub (f) und Schnitttiefe (ap). Weitere Informationen finden Sie in unserer Zerspanungsrechner-App.

Produkt	RE (mm)	P			M			K			N			S			H		
		vc (m/min)	f (mm/tooth)	ap (mm)	vc (m/min)	f (mm/tooth)	ap (mm)	vc (m/min)	f (mm/tooth)	ap (mm)	vc (m/min)	f (mm/tooth)	ap (mm)	vc (m/min)	f (mm/tooth)	ap (mm)	vc (m/min)	f (mm/tooth)	ap (mm)

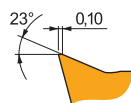
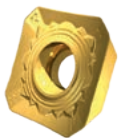

F geometrie ist scharf und wird zum Schlichten verwendet, geeignet für Anwendungen mit großem Überhang oder dünnwandigen und schlanken Werkstücken. Entwickelt mit hoch positivem Spanwinkel, schmaler Fase und verrundung der Schneidkante für eine leichte Bearbeitung.

SDET 13T3AFSN-F:M6330	☼	-	■	250	0.15	3.0	■	175	0.14	3.0	■	-	-	-	■	70	0.11	2.4	-	-	-	
SDET 13T3AFSN-F:M8310	☼	-	■	315	0.15	3.0	■	160	0.14	3.0	■	295	0.15	3.0	■	-	-	-	-	-	-	
SDET 13T3AFSN-F:M8330	☼	-	■	285	0.15	3.0	■	170	0.14	3.0	■	270	0.15	3.0	■	855	0.18	3.0	■	70	0.11	2.4
SDET 13T3AFSN-F:M8340	☼	-	■	265	0.15	3.0	■	155	0.14	3.0	■	250	0.15	3.0	■	-	-	-	■	65	0.11	2.4
SDET 13T3AFSN-F:M9340	☼	-	■	330	0.15	3.0	■	195	0.14	3.0	■	-	-	-	■	80	0.11	2.4	-	-	-	

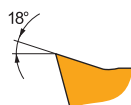
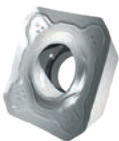

FA geometrie ist scharf und wird für die Bearbeitung von Nichteisenlegierungen verwendet, geeignet für Anwendungen mit großem Überhang oder dünnwandigen und schlanken Werkstücken. Polierte und geschliffene Ausführung mit hoch positivem Spanwinkel.

SDET 13T3AFFN-FA:HF7	☼	-	■	-	-	-	■	-	-	-	■	360	0.12	3.0	■	-	-	-	-	-	-
SDET 13T3AFFN-FA:M0315	☼	-	■	-	-	-	■	-	-	-	■	840	0.12	3.0	■	-	-	-	-	-	-

SDMT 13



	IC	D1	M	S
	(mm)	(mm)	(mm)	(mm)
13T3	13.385	4.40	1.5	3.97

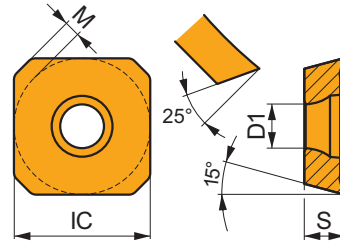

Eignung und Startwerte für Schnittgeschwindigkeit (vc), Vorschub (f) und Schnitttiefe (ap). Weitere Informationen finden Sie in unserer Zerspanungsrechner-App.

Produkt	RE (mm)	P			M			K			N			S			H		
		vc	f	ap	vc	f	ap	vc	f	ap	vc	f	ap	vc	f	ap	vc	f	ap
		(m/min)	(mm/tooth)	(mm)	(m/min)	(mm/tooth)	(mm)	(m/min)	(mm/tooth)	(mm)	(m/min)	(mm/tooth)	(mm)	(m/min)	(mm/tooth)	(mm)	(m/min)	(mm/tooth)	(mm)

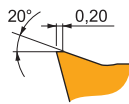

M geometrie ist vielseitig und die erste Wahl für unterschiedlichste Arbeitsbedingungen. Ausgelegt mit positivem Spanwinkel, mittlerer Fase und verrundeter Schneidkante für mittlere Zerspanungsaufgaben.

SDMT 13T3AFSN-M:8215	☉	–	■	245	0.30	3.0	▣	145	0.27	3.0	■	230	0.30	3.0	–	–	–	▣	60	0.24	2.4	■	45	0.21	1.0
SDMT 13T3AFSN-M:M6330	☉	–	■	215	0.30	3.0	■	150	0.27	3.0	–	–	–	–	–	–	–	■	60	0.24	2.4	–	–	–	
SDMT 13T3AFSN-M:M8330	☉	–	■	245	0.30	3.0	■	145	0.27	3.0	■	230	0.30	3.0	–	–	–	▣	60	0.24	2.4	▣	45	0.21	1.0
SDMT 13T3AFSN-M:M8340	☉	–	■	225	0.30	3.0	■	135	0.27	3.0	▣	210	0.30	3.0	–	–	–	■	55	0.24	2.4	–	–	–	
SDMT 13T3AFSN-M:M9325	☉	–	■	295	0.30	3.0	–	–	–	–	■	280	0.30	3.0	–	–	–	–	–	–	–	▣	55	0.21	1.0
SDMT 13T3AFSN-M:M9340	☉	–	■	265	0.30	3.0	■	155	0.27	3.0	–	–	–	–	–	–	–	■	65	0.24	2.4	–	–	–	

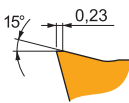

R geometrie ist stark und wird zum Schruppen und unter schweren Arbeitsbedingungen verwendet. Ausgelegt mit leicht positivem Spanwinkel, breiter Fase und verrundeter Schneidkante für die Schruppbearbeitung.

SDMT 13T3AFSN-R:M5315	☉	–	▣	285	0.35	3.0	–	–	–	■	270	0.35	3.0	–	–	–	–	–	–	–	■	55	0.25	1.0
SDMT 13T3AFSN-R:M8310	☉	–	■	255	0.35	3.0	▣	130	0.32	3.0	■	240	0.35	3.0	–	–	–	–	–	–	■	50	0.25	1.0
SDMT 13T3AFSN-R:M8330	☉	–	■	240	0.35	3.0	▣	140	0.32	3.0	■	225	0.35	3.0	–	–	–	–	–	–	▣	45	0.25	1.0
SDMT 13T3AFSN-R:M8340	☉	–	■	220	0.35	3.0	▣	130	0.32	3.0	▣	205	0.35	3.0	–	–	–	–	–	–	–	–	–	–
SDMT 13T3AFSN-R:M9325	☉	–	■	280	0.35	3.0	–	–	–	–	■	265	0.35	3.0	–	–	–	–	–	–	▣	55	0.25	1.0

XDET 13



	IC	D1	S
	(mm)	(mm)	(mm)
13T3	13.385	4.40	3.97

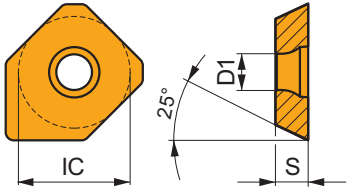

Eignung und Startwerte für Schnittgeschwindigkeit (vc), Vorschub (f) und Schnitttiefe (ap). Weitere Informationen finden Sie in unserer Zerspanungsrechner-App.

Produkt	RE (mm)	P			M			K			N			S			H		
		vc (m/min)	f (mm/tooth)	ap (mm)	vc (m/min)	f (mm/tooth)	ap (mm)	vc (m/min)	f (mm/tooth)	ap (mm)	vc (m/min)	f (mm/tooth)	ap (mm)	vc (m/min)	f (mm/tooth)	ap (mm)	vc (m/min)	f (mm/tooth)	ap (mm)



W wiper-Ausführung für verbesserte Oberflächengüte bei der Bearbeitung mit großen Fräsern und hohem Vorschub.

XDET 13T3AFER:8215	RE	–	420	0.10	0.2	250	0.09	0.2	395	0.10	0.2	–	–	–	–	–	–	–
XDET 13T3AFER:M8330	RE	–	395	0.10	0.2	235	0.09	0.2	375	0.10	0.2	–	–	–	–	–	–	–



a_e / DC	5 %	10 %	15 %	20 %	25 %	30 %	40 %	50 %	60 %	70 %	75 %	80 %	90 %	100 %
	1.48	1.35	1.27	1.22	1.19	1.16	1.11	1.08	1.05	1.03	1.00	1.00	1.00	1.00
	2.20	1.60	1.35	1.20	1.10	0.95	0.85	0.75	0.85	0.95	1.00	1.00	1.00	1.00
	0.64	0.64	0.64	0.64	0.64	0.65	0.65	0.67	0.68	0.71	0.72	0.74	0.79	1.00

	SDET 13-F	SDMT 13-M	SDMT 13-R	SDET 13-FA	XDET 13
	-	-	-	-	-
	1.75	1.75	1.75	1.75	8.19

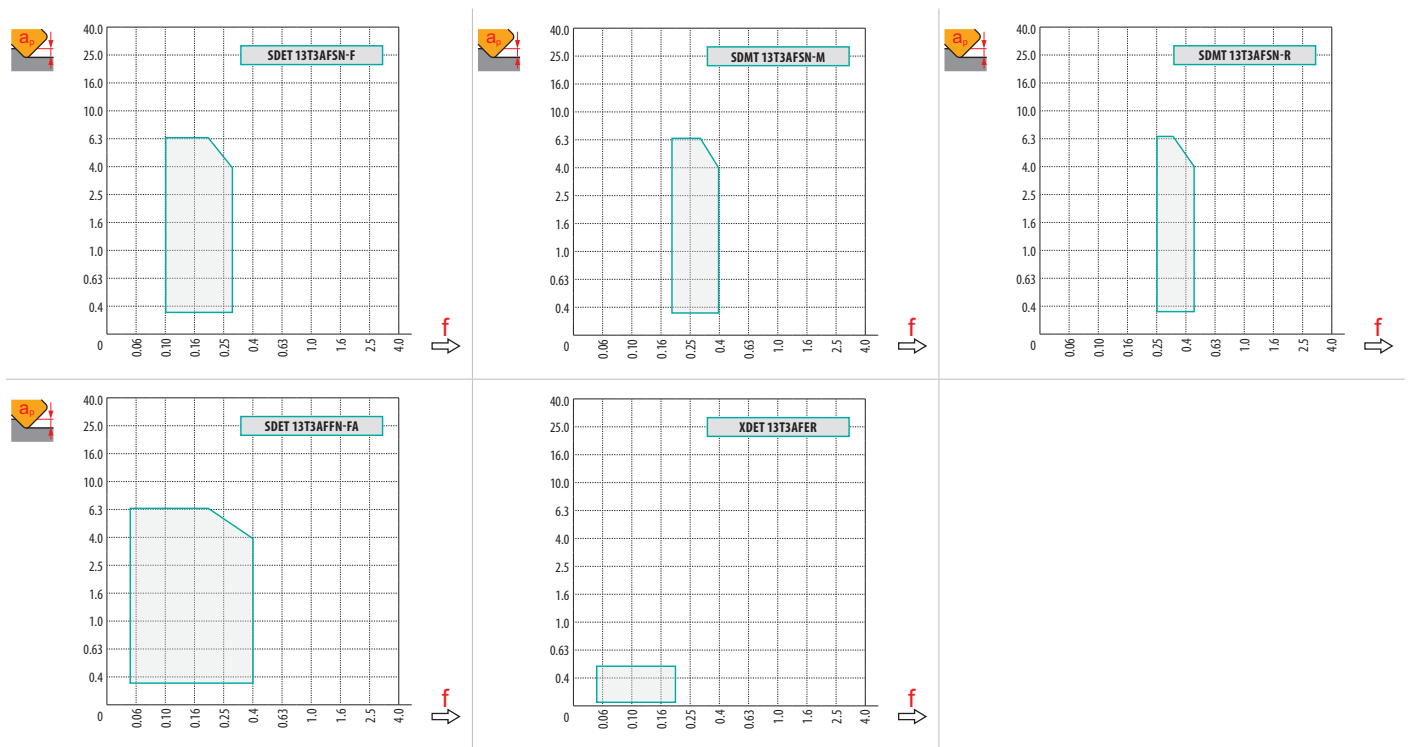

		f_{max}		RPMX	APMX/I		DMIN	DMAX			a_e
32	1.22	0.15	32	14.1°	6.4/27	32	60.0	89.8	1.7	1.7	1.5
40	1.26	0.16	40	11.8°	6.4/32	40	75.0	107.0	1.7	1.7	
50	1.30	0.18	50	9.8°	6.4/39	50	94.0	127.0	1.7	1.7	
63	1.34	0.20	63	7.7°	6.4/49	63	120.0	152.8	1.7	1.7	
80	1.39	0.22	80	5.2°	6.4/72	80	155.0	186.8	1.7	1.7	
100	1.43	0.24	100	4.1°	6.4/91	100	193.0	225.8	1.7	1.7	
125	1.48	0.26	125	3.2°	5.45/100	125	245.0	275.6	1.7	1.7	
160	1.53	0.29	160	1.0°	1.6/100	160	322.0	345.6	1.7	1.7	
200	1.58	0.33	200	0.4°	0.55/100	200	405.0	425.6	1.7	1.7	
250	1.63	0.36	250	0.3°	0.4/100	250	505.0	525.6	1.7	1.7	

SSE09



PRAMET



45°-Planfräser mit positiver Ausführung und Innenkühlung

Hochproduktive 45°-Planfräser mit einseitigen SE.. 09-Wendeschneidplatten mit einem APMX von 4,5 mm. Geeignet zum Planfräsen und Anfasen. Als Weldon- und Aufsteckfräser mit ungleicher Zahnteilung erhältlich. Körper für längere Standzeiten oberflächenbehandelt.

KAPR	45°
APMX	4.5 mm

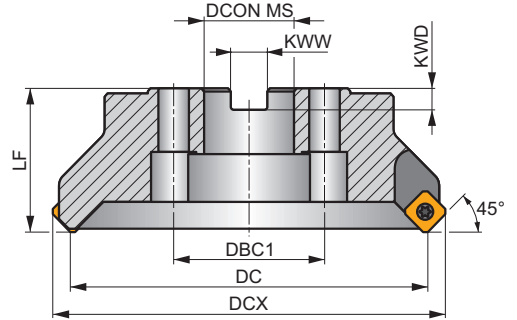
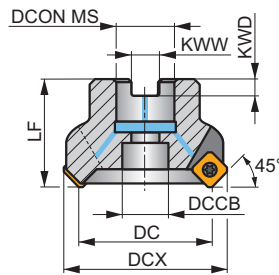
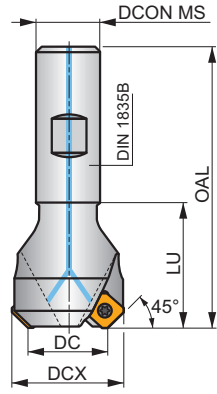
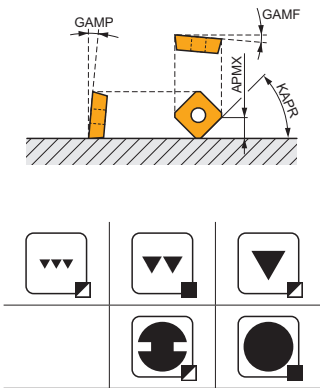

	0.06 - 0.18		
	0.06 - 0.2		

Produkt	DC	DCX	OAL	DCON MS	DCCB	DBC1	LU	LF	KWW	KWD	GAMF	GAMP	max.		kg	FA				
	(mm)	(mm)	(mm)	(mm)	(mm)	(mm)	(mm)	(mm)	(mm)	(mm)	(°)	(°)								
20N2R032B20-SSE09-C	20	29.8	82	20	-	-	32	-	-	-	-5	20	2	-	24600	✓	0.26	G147	FA010	-
25N3R042B25-SSE09-C	25	34.8	98	25	-	-	42	-	-	-	-5	20	3	-	22000	✓	0.44	G147	FA010	-
32N4R042B32-SSE09-C	32	42	102	32	-	-	42	-	-	-	-5	20	4	-	19400	✓	0.68	G147	FA010	-
32A04R-S45SE09F-C	32	42	-	16	14	-	-	40	8.4	6.4	-5	20	4	✓	19400	✓	0.24	G147	FA012	-
40A04R-S45SE09F-C	40	53.2	-	16	14	-	-	40	8.4	6.4	-5	20	4	✓	17400	✓	0.30	G147	FA012	-
50A05R-S45SE09F-C	50	59.6	-	22	18	-	-	40	10.4	6.4	-5	20	5	✓	15600	✓	0.55	G147	FA013	-
63A05R-S45SE09F-C	63	75.8	-	22	18	-	-	40	10.4	6.4	-5	20	5	✓	13900	✓	0.66	G147	FA013	-
63A06R-S45SE09F-C	63	75.8	-	22	18	-	-	40	10.4	6.4	-5	20	6	✓	13900	✓	0.58	G147	FA013	-
80A06R-S45SE09F-C	80	89.6	-	27	38	-	-	50	12.4	7	-5	20	6	✓	12300	✓	1.14	G147	FA011	AC001
80A08R-S45SE09F-C	80	89.6	-	27	38	-	-	50	12.4	7	-5	20	8	✓	12300	✓	1.13	G147	FA011	AC001
100A08R-S45SE09F-C	100	110	-	32	45	-	-	50	14.4	8	-5	20	8	✓	11000	✓	1.83	G147	FA011	AC002
100A10R-S45SE09F-C	100	110	-	32	45	-	-	50	14.4	8	-5	20	10	✓	10900	✓	1.82	G147	FA011	AC002
125A09R-S45SE09F-C	125	134.5	-	40	60	-	-	63	16.4	9	-5	20	9	✓	9800	✓	3.87	G147	FA011	AC003
125A12R-S45SE09F-C	125	134.5	-	40	60	-	-	63	16.4	9	-5	20	12	✓	9800	✓	3.87	G147	FA011	AC003
160C10R-S45SE09F	160	169.6	-	40	-	66.7	-	63	16.4	9	-5	20	10	✓	8700	-	6.21	G147	FA014	-

G147	SEET 09T3AF.	SEMT 09T3AF.

FA010	US 3007-T09P	2.0	M 3	7.3	-	-	Flag T09P	-	-
FA011	US 3007-T09P	2.0	M 3	7.3	D-T07P/T09P	FG-15	-	-	-
FA012	US 3007-T09P	2.0	M 3	7.3	D-T07P/T09P	FG-15	-	-	HS 0830C
FA013	US 3007-T09P	2.0	M 3	7.3	D-T07P/T09P	FG-15	-	-	HS 1030C

FA014	US 3007-T09P	2.0	M 3	7.3	D-T07P/T09P	FG-15	-	HS 1240C

AC001	KS 1230	K.FMH27
AC002	KS 1635	K.FMH32
AC003	KS 2040	K.FMH40

SEMT 09



	IC	D1	M	S
	(mm)	(mm)	(mm)	(mm)
09T3	9.525	3.50	1.2	3.97

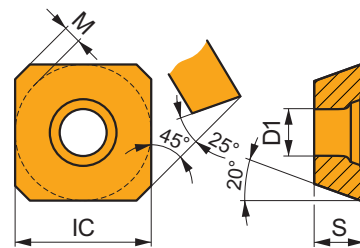

Eignung und Startwerte für Schnittgeschwindigkeit (vc), Vorschub (f) und Schnitttiefe (ap). Weitere Informationen finden Sie in unserer Zerspanungsrechner-App.

Produkt	RE (mm)	P			M			K			N			S			H		
		vc	f	ap	vc	f	ap	vc	f	ap	vc	f	ap	vc	f	ap	vc	f	ap
	(mm)	(m/min)	(mm/tooth)	(mm)	(m/min)	(mm/tooth)	(mm)	(m/min)	(mm/tooth)	(mm)	(m/min)	(mm/tooth)	(mm)	(m/min)	(mm/tooth)	(mm)	(m/min)	(mm/tooth)	(mm)

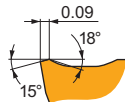
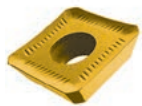

AFSN positive Ausführung zur leichten bis mittleren Bearbeitung.

SEMT 09T3AFSN:8215	☹	-	■	295	0.18	1.8	▣	175	0.16	1.8	■	280	0.18	1.8	-	-	-	-	-	-
SEMT 09T3AFSN:M8330	☹	-	■	290	0.18	1.8	▣	170	0.16	1.8	■	275	0.18	1.8	-	-	-	-	-	-
SEMT 09T3AFSN:M8340	☹	-	■	265	0.18	1.8	▣	155	0.16	1.8	▣	250	0.18	1.8	-	-	-	-	-	-
SEMT 09T3AFSN:M9325	☹	-	■	365	0.18	1.8	-	-	-	-	■	345	0.18	1.8	-	-	-	-	-	-

SEET 09



	IC	D1	M	S
	(mm)	(mm)	(mm)	(mm)
09T3	9.525	3.50	1.2	3.97

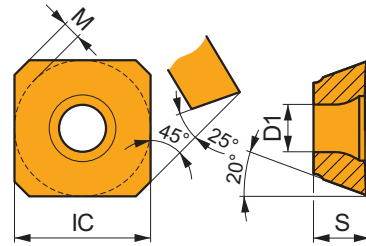

Eignung und Startwerte für Schnittgeschwindigkeit (vc), Vorschub (f) und Schnitttiefe (ap). Weitere Informationen finden Sie in unserer Zerspanungsrechner-App.

Produkt	RE (mm)	P			M			K			N			S			H		
		vc	f	ap	vc	f	ap	vc	f	ap	vc	f	ap	vc	f	ap	vc	f	ap
		(m/min)	(mm/tooth)	(mm)	(m/min)	(mm/tooth)	(mm)	(m/min)	(mm/tooth)	(mm)	(m/min)	(mm/tooth)	(mm)	(m/min)	(mm/tooth)	(mm)	(m/min)	(mm/tooth)	(mm)

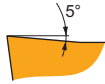

AFEN positive Ausführung zur leichten bis mittleren Bearbeitung.

SEET 09T3AFEN:M6330	☹	–	■	255	0.14	2.5	☑	180	0.13	2.5	■	–	–	–	■	75	0.10	2.0	■	–	–	–
SEET 09T3AFEN:M8330	☹	–	■	295	0.14	2.5	☑	175	0.13	2.5	■	–	–	–	■	70	0.10	2.0	■	–	–	–
SEET 09T3AFEN:M8340	☹	–	■	270	0.14	2.5	☑	160	0.13	2.5	■	–	–	–	■	65	0.10	2.0	■	–	–	–
SEET 09T3AFEN:M9340	☹	–	■	345	0.14	2.5	☑	205	0.13	2.5	■	–	–	–	■	85	0.10	2.0	■	–	–	–



a_e / DC	5 %	10 %	15 %	20 %	25 %	30 %	40 %	50 %	60 %	70 %	75 %	80 %	90 %	100 %
	1.48	1.35	1.27	1.22	1.19	1.16	1.11	1.08	1.05	1.03	1.00	1.00	1.00	1.00
	2.20	1.60	1.35	1.20	1.10	0.95	0.85	0.75	0.85	0.95	1.00	1.00	1.00	1.00
	0.64	0.64	0.64	0.64	0.64	0.65	0.65	0.67	0.68	0.71	0.72	0.74	0.79	1.00

	SEET 09	SEMT 09
	-	-
	1.28	1.25

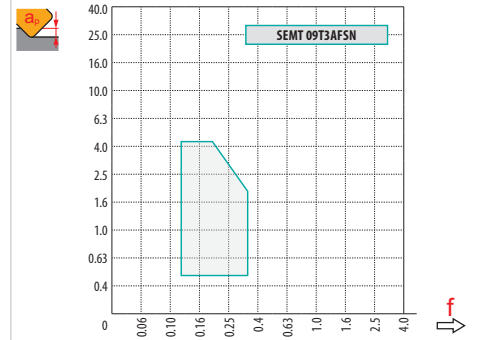
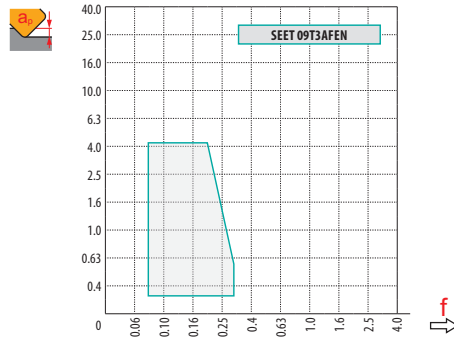

DC	X.V	f_{max}
20	1.20	0.18
25	1.24	0.20
32	1.29	0.23
40	1.33	0.25
50	1.37	0.28
63	1.41	0.32
80	1.46	0.36
100	1.50	0.40
125	1.55	0.45
160	1.60	0.51

SSN12Z



PRAMET



45° Planfräser in positiver Ausführung und Innenkühlung

Hochproduktive 45°-Planfräser mit einseitigem SN.. 12-Wendeschneidplatten mit einem APMX von 6,5 mm. Geeignet zum Planfräsen und Anfasen. Nur als Aufsteckfräser. Körper für längere Standzeiten oberflächenbehandelt.

KAPR	45°
APMX	6.5 mm

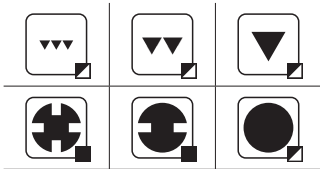
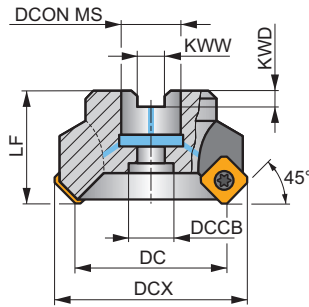
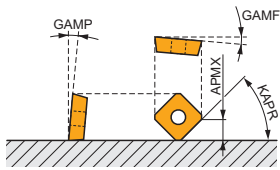

0.12 - 0.35



Produkt	DC	DCX	LF	D CON MS	DCCB	DBC1	KWW	KWD	GAMF	GAMP								
	(mm)	(mm)	(mm)	(mm)	(mm)	(mm)	(mm)	(mm)	(°)	(°)								
63A05R-S45SN12Z-C	63	78	40	22	18	-	10.4	6.3	-5.5	7.5	5	-	8600	✓	0.62	GI156	FA071	-
80A06R-S45SN12Z-C	80	95	50	27	38	-	12.4	7	-5.5	7.5	6	-	7700	✓	1.36	GI156	FA071	AC001
100A07R-S45SN12Z-C	100	115	50	32	45	-	14.4	8	-5.5	7.5	7	-	6900	✓	1.70	GI156	FA071	AC002
125A08R-S45SN12Z-C	125	140	63	40	56	-	16.4	9	-5.5	7.5	8	-	6100	✓	3.42	GI156	FA071	AC003

GI156	SNKT 1205AZ..	SNMT 1205AZ..

FA071	US 4511-T20	5.0	M 4.5	11	SDRT20-T

AC001	KS 1230	K.FMH27
AC002	KS 1635	K.FMH32
AC003	KS 2040	K.FMH40

SNMT 12



	IC (mm)	D1 (mm)	S (mm)
1205	12.700	5.20	5.56

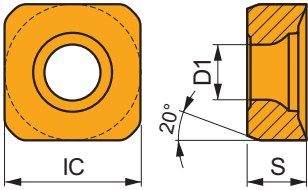

Eignung und Startwerte für Schnittgeschwindigkeit (vc), Vorschub (f) und Schnitttiefe (ap). Weitere Informationen finden Sie in unserer Zerspanungsrechner-App.

Produkt	RE (mm)	P			M			K			N			S			H		
		vc (m/min)	f (mm/tooth)	ap (mm)	vc (m/min)	f (mm/tooth)	ap (mm)	vc (m/min)	f (mm/tooth)	ap (mm)	vc (m/min)	f (mm/tooth)	ap (mm)	vc (m/min)	f (mm/tooth)	ap (mm)	vc (m/min)	f (mm/tooth)	ap (mm)

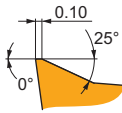

M geometrie mit sehr positiven Design zur mittleren Bearbeitung.

SNMT 1205AZSR-M:8215	☉	–	300	0.25	3.2	180	0.23	3.2	285	0.25	3.2	–	–	–	75	0.18	2.6	–	–	–
SNMT 1205AZSR-M:M8330	☉	–	300	0.25	3.2	180	0.23	3.2	285	0.25	3.2	–	–	–	75	0.18	2.6	–	–	–
SNMT 1205AZSR-M:M8340	☉	–	275	0.25	3.2	165	0.23	3.2	260	0.25	3.2	–	–	–	65	0.18	2.6	–	–	–
SNMT 1205AZSR-M:M9325	☉	–	365	0.25	3.2	–	–	–	345	0.25	3.2	–	–	–	–	–	–	–	–	–

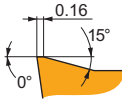

R geometrie mit positiven Design zur mittleren bis schweren Bearbeitung.

SNMT 1205AZSR-R:8215	☉	–	290	0.27	3.5	170	0.24	3.5	275	0.27	3.5	–	–	–	70	0.22	2.8	–	–	–
SNMT 1205AZSR-R:M5315	☉	–	365	0.27	3.5	–	–	–	345	0.27	3.5	–	–	–	–	–	–	–	–	–
SNMT 1205AZSR-R:M8330	☉	–	290	0.27	3.5	170	0.24	3.5	275	0.27	3.5	–	–	–	70	0.22	2.8	–	–	–
SNMT 1205AZSR-R:M8340	☉	–	270	0.27	3.5	160	0.24	3.5	255	0.27	3.5	–	–	–	65	0.22	2.8	–	–	–
SNMT 1205AZSR-R:M9325	☉	–	355	0.27	3.5	–	–	–	335	0.27	3.5	–	–	–	–	–	–	–	–	–

SNKT 12



	IC (mm)	D1 (mm)	S (mm)
1205	12.700	5.20	5.56

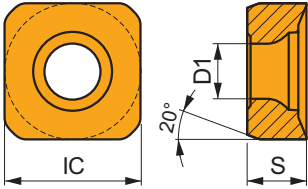

Eignung und Startwerte für Schnittgeschwindigkeit (vc), Vorschub (f) und Schnitttiefe (ap). Weitere Informationen finden Sie in unserer Zerspanungsrechner-App.

Produkt	RE (mm)	P			M			K			N			S			H		
		vc (m/min)	f (mm/tooth)	ap (mm)	vc (m/min)	f (mm/tooth)	ap (mm)	vc (m/min)	f (mm/tooth)	ap (mm)	vc (m/min)	f (mm/tooth)	ap (mm)	vc (m/min)	f (mm/tooth)	ap (mm)	vc (m/min)	f (mm/tooth)	ap (mm)

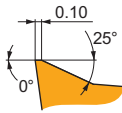

M geometrie mit sehr positiven Design zur mittleren Bearbeitung.

SNKT 1205AZSR-M:M8330	☉	–	305	0.24	3.2	180	0.22	3.2	285	0.24	3.2	–	–	–	75	0.17	2.6	–	–	–
SNKT 1205AZSR-M:M8340	☉	–	275	0.24	3.2	165	0.22	3.2	260	0.24	3.2	–	–	–	65	0.17	2.6	–	–	–



a_e / DC	5 %	10 %	15 %	20 %	25 %	30 %	40 %	50 %	60 %	70 %	75 %	80 %	90 %	100 %
	1.48	1.35	1.27	1.22	1.19	1.16	1.11	1.08	1.05	1.03	1.00	1.00	1.00	1.00
	2.20	1.60	1.35	1.20	1.10	0.95	0.85	0.75	0.85	0.95	1.00	1.00	1.00	1.00
	0.64	0.64	0.64	0.64	0.64	0.65	0.65	0.67	0.68	0.71	0.72	0.74	0.79	1.00

	SNMT 12-M	SNMT 12-R	SNKT 12-M
	-	-	-
	0.95	1.03	1.59

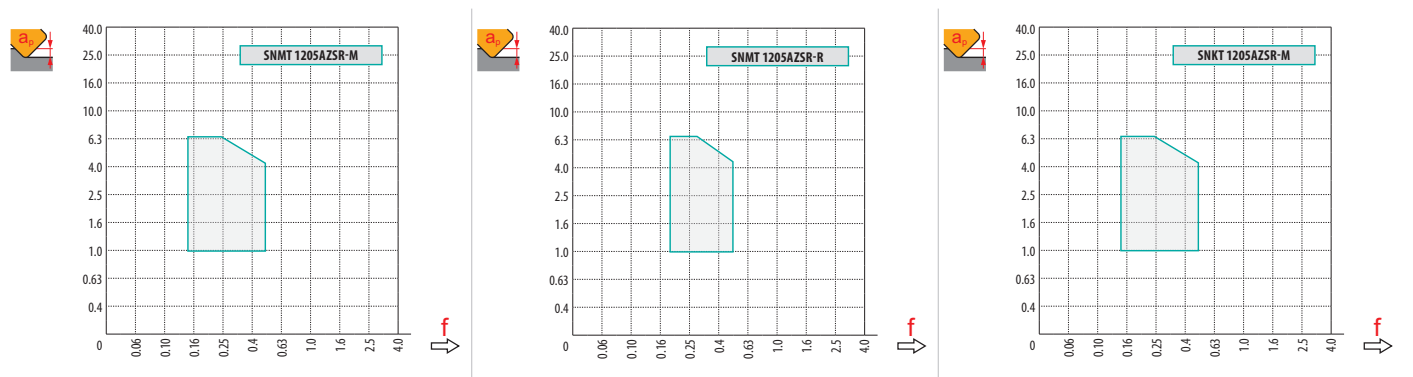

		f_{max}
63	1.34	0.53
80	1.39	0.60
100	1.43	0.67
125	1.47	0.74

FSB22X



PRAMET



ROUGH SB 60° Planfräser in positiver Ausführung zum schweren Planfräsen

Hochproduktive 60°-Planfräser mit einseitigem SB.. 22-Wendeschneidplatten mit APMX von 15 mm. Optimiert für schweres Planfräsen mit weicher Schneidwirkung. Ungleiche Zahnteilung. Nur als Aufsteckfräser. Körper für längere Standzeiten oberflächenbehandelt.

ROUGH SB

KAPR	60°
APMX	15.0 mm

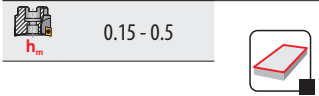
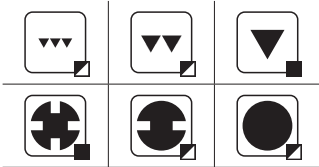
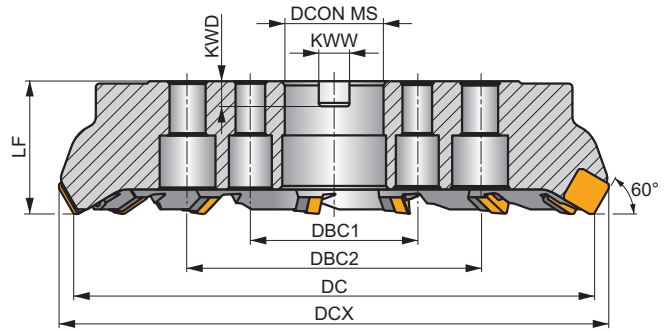
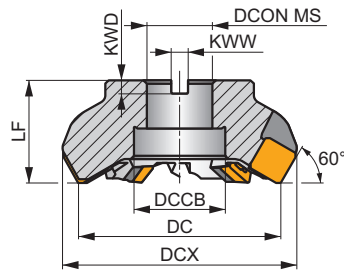
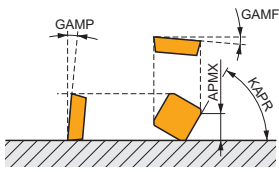

Produkt	DC	DCX	LF	DCON MS	DCCB	DBC1	DBC2	KWW	KWD	GAMF	GAMP					kg				
	(mm)	(mm)	(mm)	(mm)	(mm)	(mm)	(mm)	(mm)	(mm)	(°)	(°)									
125B07R-F60SB22X	125	144.4	63	40	56	-	-	16.4	9	-9	9	7	✓	-	-	3.73	GI144	FA111	AC003	
160C08R-F60SB22X	160	178.7	63	40	-	66.7	-	16.4	9	-9	9	8	✓	-	-	6.46	GI144	FA114	-	
200C08R-F60SB22X	200	217.9	63	60	-	101.6	-	25.7	14	-9	9	8	✓	-	-	10.59	GI144	FA115	-	
250C09R-F60SB22X	250	267.4	63	60	-	101.6	-	25.7	14	-9	9	9	✓	-	-	17.54	GI144	FA115	-	

GI144	SBKX 2207DZ..	SBMR 2207DZ..

FA111	LNX 220616	US 6013-T20P	SDR T20P-T	KU SBMR 2207	DS 01Z	KL 04	-
FA114	LNX 220616	US 6013-T20P	SDR T20P-T	KU SBMR 2207	DS 01Z	KL 04	HS 1240
FA115	LNX 220616	US 6013-T20P	SDR T20P-T	KU SBMR 2207	DS 01Z	KL 04	HS 1655

AC003	KS 2040	K.FMH40

SBMR 22



	IC (mm)	M (mm)	S (mm)	BS (mm)
2207	22.000	2.8	8.00	1.99

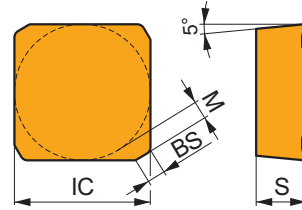

Eignung und Startwerte für Schnittgeschwindigkeit (vc), Vorschub (f) und Schnitttiefe (ap). Weitere Informationen finden Sie in unserer Zerspanungsrechner-App.

Produkt	RE (mm)	P			M			K			N			S			H		
		vc (m/min)	f (mm/tooth)	ap (mm)	vc (m/min)	f (mm/tooth)	ap (mm)	vc (m/min)	f (mm/tooth)	ap (mm)	vc (m/min)	f (mm/tooth)	ap (mm)	vc (m/min)	f (mm/tooth)	ap (mm)	vc (m/min)	f (mm/tooth)	ap (mm)

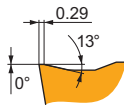
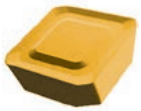

DZSR stabile Ausführung zur schweren Bearbeitung.

SBMR 2207DZSR:M8326	☹	–	140	0.38	8.5	–	–	–	130	0.38	8.5	–	–	–	–	–	–	–	–
SBMR 2207DZSR:M8346	☹	–	120	0.38	8.5	70	0.38	8.5	–	–	–	–	–	–	–	–	–	–	

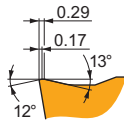
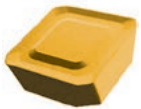

R geometrie mit stabilen Design zur schweren Bearbeitung.

SBMR 2207DZSR-R:M5326	☹	–	160	0.44	9.8	–	–	–	150	0.44	9.8	–	–	–	–	–	–	–
SBMR 2207DZSR-R:M8326	☹	–	135	0.44	9.8	–	–	–	125	0.44	9.8	–	–	–	–	–	–	–
SBMR 2207DZSR-R:M8346	☹	–	115	0.44	9.8	65	0.40	9.8	–	–	–	–	–	–	–	–	–	

SBKX 22



	IC (mm)	M (mm)	S (mm)	BS (mm)
2207	22.000	3.2	8.00	11.84

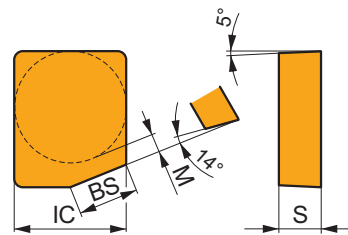

Eignung und Startwerte für Schnittgeschwindigkeit (vc), Vorschub (f) und Schnitttiefe (ap). Weitere Informationen finden Sie in unserer Zerspanungsrechner-App.

Produkt	RE (mm)	P			M			K			N			S			H		
		vc (m/min)	f (mm/tooth)	ap (mm)	vc (m/min)	f (mm/tooth)	ap (mm)	vc (m/min)	f (mm/tooth)	ap (mm)	vc (m/min)	f (mm/tooth)	ap (mm)	vc (m/min)	f (mm/tooth)	ap (mm)	vc (m/min)	f (mm/tooth)	ap (mm)

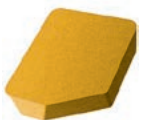

DZER ohne Spanwinkel, Wiper-Design für verbesserte Oberflächengüte.

SBKX 2207DZER:M8326	☹	–	100	0.60	8.5	–	–	–	95	0.60	8.5	–	–	–	–	–	–	–
----------------------------	---	---	-----	------	-----	---	---	---	----	------	-----	---	---	---	---	---	---	---







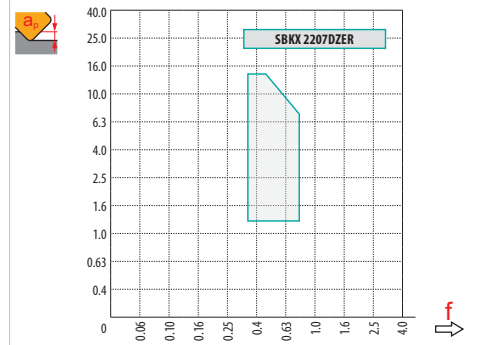
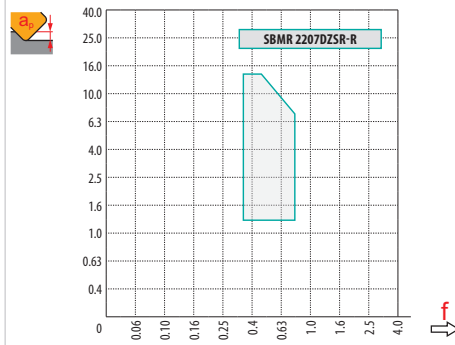
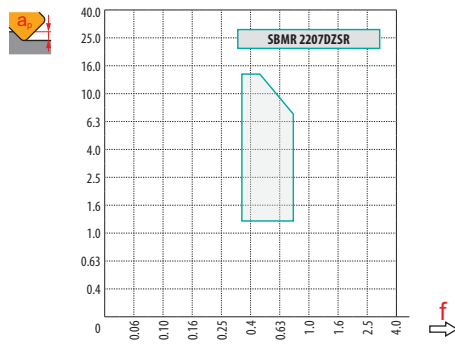











a_e / DC	5 %	10 %	15 %	20 %	25 %	30 %	40 %	50 %	60 %	70 %	75 %	80 %	90 %	100 %
	1.48	1.35	1.27	1.22	1.19	1.16	1.11	1.08	1.05	1.03	1.00	1.00	1.00	1.00
	2.20	1.60	1.35	1.20	1.10	0.95	0.85	0.75	0.85	0.95	1.00	1.00	1.00	1.00
	0.64	0.64	0.64	0.64	0.64	0.65	0.65	0.67	0.68	0.71	0.72	0.74	0.79	1.00

	SBMR 22	SBMR 22-R	SBKX 22
	-	-	-
	1.99	1.99	11.84



WENDEPLATTENFRÄSER – AUSWAHLHILFE

PLANFRÄSEN

	SOD05	SOD06D	SOE06Z		
	45°	45°	43°		
	APMX (mm) 2.7 (10.0)	APMX (mm) 3.1 (8.6)	APMX (mm) 3.3 (9.9)		
	DCX (mm) 32 – 125	DC (mm) 63 – 160	DC (mm) 50 – 200		
Zylindrischer Schaft	 DC = 32, 40 (mm)				
Weldon					
Modular					
Aufsteckfräser	 DC = 40 – 125 (mm)				
Seite	42	51	55		
ISO	P M K N	P M K S H	P M N S		
Schneidplattenform					
Wendeschneidplatten	OD.. 0505 RD.. 1205 SD.. 1205	OD.. 0605 RPE. 1505	OEHT 0604 REHT 1604 XEHT 0604		
Anzahl der Schneiden	8 / 8 / 4	8 / 8	8 / 8 / 1		
Planfräsen	 ■	■	■		
Fasenfräsen	 ■	■	■		
Schraubenlinien- interpolation	 ■		▣		
Progressives Tauchfräsen	 ■		▣		
Rampen	 ■		▣		
Fräsen geformter Flächen (Kopierfräsen)	 ■		▣		
Flaches Eckfräsen	 ■				
Flaches Nutfräsen	 ■				
Tauchfräsen	 ■				

SOD05

P M K N

PRAMET

S



Universeller Planfräser in positiver Ausführung und Innenkühlung

Highly productive universal face mill utilising single-sided positive inserts with APMX up to 2.7 (10) mm. Unique insert seat fits OD.. 05, RD.. 12 and SD.. 12 style inserts, suited for wide range of applications. Differential tooth pitch. Arbor and cylindrical style. Body treated for longer tool life.

KAPR	45°
APMX	2.7 (10.0) mm

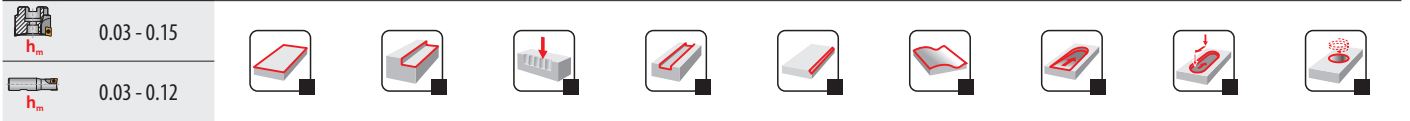
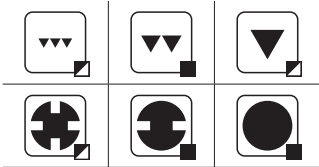
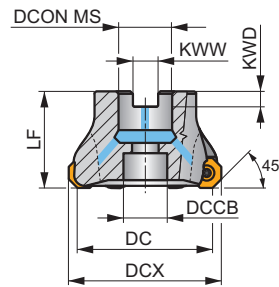
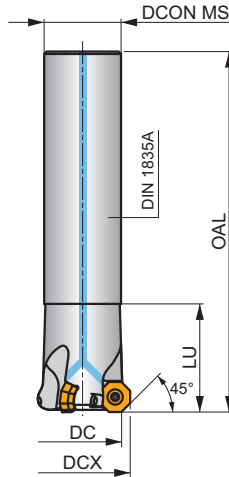
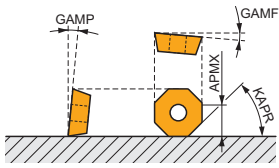

Produkt	DCX	DC	OAL	DCON MS	DCCB	LU	LF	KAPR	KWW	KWD	GAMP	GAMP	max.			kg	ISO 8030			
	(mm)	(mm)	(mm)	(mm)	(mm)	(mm)	(mm)	(°)	(mm)	(mm)	(°)	(°)								
32N3R045A25-SOD05-C	32	24.7	130	25	-	45	-	45	-	-	-10	8	3	-	17700	✓	0.41	GI326	FA049	-
40N3R045A32-SOD05-C	40	32.6	150	32	-	45	-	45	-	-	-7	8	3	-	15800	✓	0.86	GI326	FA040	-
40A03R-S450D05-C	40	32.7	-	16	14	-	40	45	8.4	5.6	-10	8	3	-	15800	✓	0.18	GI326	FA042	-
50A04R-S450D05-C	50	42.6	-	22	18	-	40	45	10.4	6.3	-7	8	4	-	14100	✓	0.28	GI326	FA043	-
50A05R-S450D05-C	50	42.6	-	22	18	-	40	45	10.4	6.3	-7	8	5	-	14100	✓	0.28	GI326	FA043	-
63A05R-S450D05-C	63	55.6	-	22	18	-	40	45	10.4	6.3	-7	8	5	✓	12600	✓	0.39	GI326	FA043	-
63A06R-S450D05-C	63	55.6	-	22	18	-	40	45	10.4	6.3	-7	8	6	✓	12600	✓	0.50	GI326	FA043	-
80A06R-S450D05-C	80	72.6	-	27	38	-	50	45	12.4	7	-7	8	6	✓	11100	✓	0.73	GI326	FA041	AC001
80A08R-S450D05-C	80	72.6	-	27	38	-	50	45	12.4	7	-7	8	8	✓	11100	✓	0.66	GI326	FA041	AC001
100A07R-S450D05-C	100	92.6	-	32	45	-	50	45	14.4	8	-7	8	7	✓	10000	✓	1.09	GI326	FA041	AC002
125A08R-S450D05-C	125	117.6	-	40	56	-	63	45	16.4	9	-7	8	8	✓	8900	✓	2.20	GI326	FA041	AC003

GI326	OD.. 0505..	RD.. 1205..	SDKT 1205..	SDMT 1205..SN

FA040	US 45014-T20P	5.0	M 5	13	Flag T20P	-	-
FA041	US 45014-T20P	5.0	M 5	13	-	SDR T20P-T	-
FA042	US 45014-T20P	5.0	M 5	13	-	SDR T20P-T	HS 90835
FA043	US 45014-T20P	5.0	M 5	13	-	SDR T20P-T	HS 1030C
FA049	US 45011-T20P	5.0	M 5	11	Flag T20P	-	-

AC001	KS 1230	K.FMH27
AC002	KS 1635	K.FMH32
AC003	KS 2040	K.FMH40

ODKT 05IM



	IC	D1	S	BS
	(mm)	(mm)	(mm)	(mm)
0505	12.700	5.50	5.56	1.00

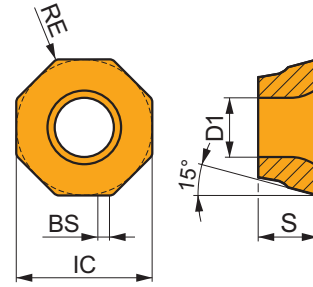

Eignung und Startwerte für Schnittgeschwindigkeit (vc), Vorschub (f) und Schnitttiefe (ap). Weitere Informationen finden Sie in unserer Zerspanungsrechner-App.

Produkt	RE (mm)	P			M			K			N			S			H		
		vc (m/min)	f (mm/tooth)	ap (mm)	vc (m/min)	f (mm/tooth)	ap (mm)	vc (m/min)	f (mm/tooth)	ap (mm)	vc (m/min)	f (mm/tooth)	ap (mm)	vc (m/min)	f (mm/tooth)	ap (mm)	vc (m/min)	f (mm/tooth)	ap (mm)

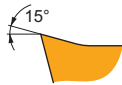
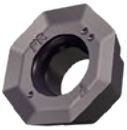

F geometrie, 45° WSP zum Planfräsen, mit hoch positiven Design zur leichten Bearbeitung.

ODKT 0505ADFR-F:M8310	● 0.8	■ 275	■ 0.15	■ 2.5	■ 140	■ 0.14	■ 2.5	■ -	■ -	■ -	■ -	■ -	■ -	■ -	■ -	■ -	■ -	■ -	■ -
------------------------------	-------	-------	--------	-------	-------	--------	-------	-----	-----	-----	-----	-----	-----	-----	-----	-----	-----	-----	-----

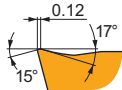

FM geometrie, 45° WSP zum Planfräsen, mit positiven Design zur leichten bis mittleren Bearbeitung.

ODKT 0505ADSR-FM:M6330	● 0.8	■ 190	■ 0.25	■ 2.5	■ 135	■ 0.23	■ 2.5	■ -	■ -	■ -	■ -	■ -	■ -	■ -	■ -	■ -	■ -	■ -	■ -
ODKT 0505ADSR-FM:M8310	● 0.8	■ 240	■ 0.25	■ 2.5	■ 120	■ 0.23	■ 2.5	■ 225	■ 0.25	■ 2.5	■ -	■ -	■ -	■ -	■ -	■ -	■ -	■ -	■ -
ODKT 0505ADSR-FM:M8330	● 0.8	■ 225	■ 0.25	■ 2.5	■ 135	■ 0.23	■ 2.5	■ 210	■ 0.25	■ 2.5	■ -	■ -	■ -	■ -	■ -	■ -	■ -	■ -	■ -
ODKT 0505ADSR-FM:M8345	● 0.8	■ 160	■ 0.25	■ 2.5	■ 95	■ 0.23	■ 2.5	■ -	■ -	■ -	■ -	■ -	■ -	■ -	■ -	■ -	■ -	■ -	■ -
ODKT 0505ADSR-FM:M9340	● 0.8	■ 245	■ 0.25	■ 2.5	■ 145	■ 0.23	■ 2.5	■ -	■ -	■ -	■ -	■ -	■ -	■ -	■ -	■ -	■ -	■ -	■ -

ODMT 05IM



	IC (mm)	D1 (mm)	S (mm)
0505	12.700	5.50	5.56

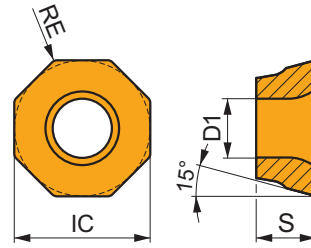

Eignung und Startwerte für Schnittgeschwindigkeit (vc), Vorschub (f) und Schnitttiefe (ap). Weitere Informationen finden Sie in unserer Zerspanungsrechner-App.

Produkt	RE (mm)	P			M			K			N			S			H		
		vc (m/min)	f (mm/tooth)	ap (mm)	vc (m/min)	f (mm/tooth)	ap (mm)	vc (m/min)	f (mm/tooth)	ap (mm)	vc (m/min)	f (mm/tooth)	ap (mm)	vc (m/min)	f (mm/tooth)	ap (mm)	vc (m/min)	f (mm/tooth)	ap (mm)

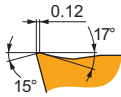

FM geometrie, 45° WSP zum Planfräsen, mit positiven Design zur leichten bis mittleren Bearbeitung.

ODMT 0505ADSR-FM:M8340	0.8	200	0.25	2.5	120	0.23	2.5	190	0.25	2.5	-	-	-	-	-	-	-	-	-
ODMT 0505ADSR-FM:M9340	0.8	245	0.25	2.5	145	0.23	2.5	-	-	-	-	-	-	-	-	-	-	-	-

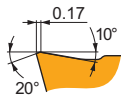

R geometrie, 45° WSP zum Planfräsen, mit positiven Design bei instabilen Schnittbedingungen.

ODMT 050508SN-R:M8330	0.8	190	0.25	2.5	-	-	-	180	0.25	2.5	-	-	-	-	-	-	-	-	-
ODMT 050508SN-R:M9340	0.8	210	0.25	2.5	-	-	-	-	-	-	-	-	-	-	-	-	-	-	-

RDGT 12IM



	INSD (mm)	D1 (mm)	S (mm)
1205	12.700	5.50	5.56

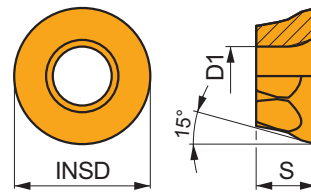

Eignung und Startwerte für Schnittgeschwindigkeit (vc), Vorschub (f) und Schnitttiefe (ap). Weitere Informationen finden Sie in unserer Zerspanungsrechner-App.

Produkt	RE (mm)	P			M			K			N			S			H		
		vc (m/min)	f (mm/tooth)	ap (mm)	vc (m/min)	f (mm/tooth)	ap (mm)	vc (m/min)	f (mm/tooth)	ap (mm)	vc (m/min)	f (mm/tooth)	ap (mm)	vc (m/min)	f (mm/tooth)	ap (mm)	vc (m/min)	f (mm/tooth)	ap (mm)

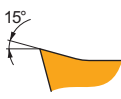

F geometrie mit hoch positiven Design zum Schlichten.

RDGT 120500FN-F:M8310	-	210	0.20	1.5	105	0.18	1.5	-	-	-	-	-	-	-	-	-	-	-	-
------------------------------	---	-----	------	-----	-----	------	-----	---	---	---	---	---	---	---	---	---	---	---	---

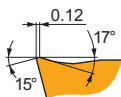

FM geometrie mit positiven Design zur leichten bis mittleren Bearbeitung.

RDGT 120500SN-FM:M8330	-	190	0.20	1.5	110	0.18	1.5	180	0.20	1.5	-	-	-	-	-	-	-	-	-
-------------------------------	---	-----	------	-----	-----	------	-----	-----	------	-----	---	---	---	---	---	---	---	---	---

Eignung und Startwerte für Schnittgeschwindigkeit (vc), Vorschub (f) und Schnitttiefe (ap). Weitere Informationen finden Sie in unserer Zerspanungsrechner-App.

Produkt	RE (mm)	P			M			K			N			S			H		
		vc (m/min)	f (mm/tooth)	ap (mm)	vc (m/min)	f (mm/tooth)	ap (mm)	vc (m/min)	f (mm/tooth)	ap (mm)	vc (m/min)	f (mm/tooth)	ap (mm)	vc (m/min)	f (mm/tooth)	ap (mm)	vc (m/min)	f (mm/tooth)	ap (mm)

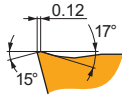

FM geometrie mit positiven Design zur leichten bis mittleren Bearbeitung.

RDGT 120500SN-FM:M8345	●	-	■	140	0.20	1.5	■	80	0.18	1.5	■	-	-	-	-	-	-	-	-
------------------------	---	---	---	-----	------	-----	---	----	------	-----	---	---	---	---	---	---	---	---	---

RDMT 12IM



	INSD (mm)	D1 (mm)	S (mm)
1205	12.700	5.50	5.56

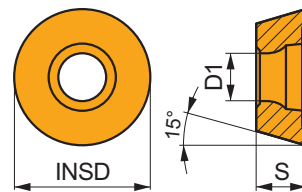

Eignung und Startwerte für Schnittgeschwindigkeit (vc), Vorschub (f) und Schnitttiefe (ap). Weitere Informationen finden Sie in unserer Zerspanungsrechner-App.

Produkt	RE (mm)	P			M			K			N			S			H		
		vc (m/min)	f (mm/tooth)	ap (mm)	vc (m/min)	f (mm/tooth)	ap (mm)	vc (m/min)	f (mm/tooth)	ap (mm)	vc (m/min)	f (mm/tooth)	ap (mm)	vc (m/min)	f (mm/tooth)	ap (mm)	vc (m/min)	f (mm/tooth)	ap (mm)

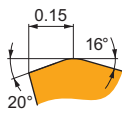

R geometrie, WSP zum Kopier- und Profilverfahren, mit positiven Design bei instabilen Schnittbedingungen.

RDMT 120500SN-R:M8330	●	-	■	175	0.30	1.5	■	-	-	-	■	165	0.30	1.5	-	-	-	-	-
RDMT 120500SN-R:M8340	●	-	■	160	0.30	1.5	■	-	-	-	■	150	0.30	1.5	-	-	-	-	-

SDKT 12IM



	IC (mm)	D1 (mm)	S (mm)
1205	12.700	5.50	5.56

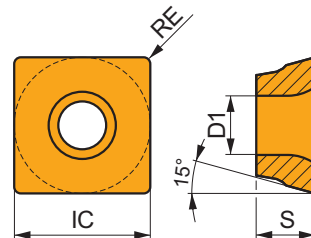

Eignung und Startwerte für Schnittgeschwindigkeit (vc), Vorschub (f) und Schnitttiefe (ap). Weitere Informationen finden Sie in unserer Zerspanungsrechner-App.

Produkt	RE (mm)	P			M			K			N			S			H		
		vc (m/min)	f (mm/tooth)	ap (mm)	vc (m/min)	f (mm/tooth)	ap (mm)	vc (m/min)	f (mm/tooth)	ap (mm)	vc (m/min)	f (mm/tooth)	ap (mm)	vc (m/min)	f (mm/tooth)	ap (mm)	vc (m/min)	f (mm/tooth)	ap (mm)

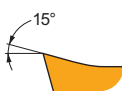

F geometrie, 90° WSP zum Schulterfräsen, mit hoch positiven Design zur leichten Bearbeitung.

SDKT 1205PDFR-F:8215	●	0.8	■	285	0.10	4.0	■	170	0.09	4.0	■	-	-	-	■	855	0.12	4.0	-
----------------------	---	-----	---	-----	------	-----	---	-----	------	-----	---	---	---	---	---	-----	------	-----	---

Eignung und Startwerte für Schnittgeschwindigkeit (vc), Vorschub (f) und Schnitttiefe (ap). Weitere Informationen finden Sie in unserer Zerspanungsrechner-App.

Produkt	RE (mm)	P			M			K			N			S			H		
		vc (m/min)	f (mm/tooth)	ap (mm)	vc (m/min)	f (mm/tooth)	ap (mm)	vc (m/min)	f (mm/tooth)	ap (mm)	vc (m/min)	f (mm/tooth)	ap (mm)	vc (m/min)	f (mm/tooth)	ap (mm)	vc (m/min)	f (mm/tooth)	ap (mm)

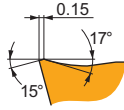
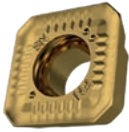

FM geometrie, 90° WSP zum Schulterfräsen, mit positiven Design zur leichten bis mittleren Bearbeitung.

SDKT 1205AESN-FM:M8330	0.8	280	0.15	4.0	165	0.15	4.0	265	0.15	4.0	-	-	-	-	-	-	-	-
SDKT 1205AESN-FM:M8345	-	205	0.15	4.0	120	0.15	4.0	-	-	-	-	-	-	-	-	-	-	-
SDKT 1205PDSR-FM:M8330	0.8	255	0.15	4.0	150	0.15	4.0	240	0.15	4.0	-	-	-	-	-	-	-	-
SDKT 1205PDSR-FM:M8345	0.8	185	0.15	4.0	110	0.15	4.0	-	-	-	-	-	-	-	-	-	-	-

SDMT 12IM



	IC (mm)	D1 (mm)	S (mm)
1205	12.700	5.50	5.56

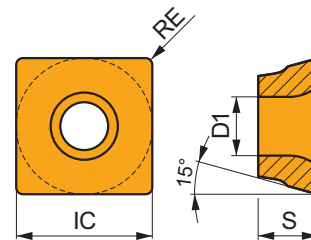

Eignung und Startwerte für Schnittgeschwindigkeit (vc), Vorschub (f) und Schnitttiefe (ap). Weitere Informationen finden Sie in unserer Zerspanungsrechner-App.

Produkt	RE (mm)	P			M			K			N			S			H		
		vc (m/min)	f (mm/tooth)	ap (mm)	vc (m/min)	f (mm/tooth)	ap (mm)	vc (m/min)	f (mm/tooth)	ap (mm)	vc (m/min)	f (mm/tooth)	ap (mm)	vc (m/min)	f (mm/tooth)	ap (mm)	vc (m/min)	f (mm/tooth)	ap (mm)

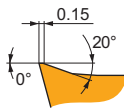
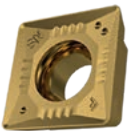

F geometrie, 90° WSP zum Schulterfräsen, mit positiven Design zur leichten bis mittleren Bearbeitung.

SDMT 120508SN-F:M8310	0.8	265	0.15	4.0	135	0.15	4.0	-	-	-	-	-	-	-	-	-	-	-
SDMT 120508SN-F:M8330	0.8	245	0.15	4.0	145	0.15	4.0	-	-	-	735	0.18	4.0	-	-	-	-	-

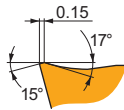
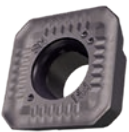

FM geometrie, 90° WSP zum Schulterfräsenzur, mit positiven Design zur mittleren Bearbeitung.

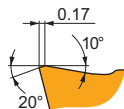
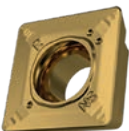

SDMT 120508SN-FM:M8345	0.8	175	0.15	4.0	105	0.15	4.0	-	-	-	-	-	-	-	-	-	-	-
------------------------	-----	-----	------	-----	-----	------	-----	---	---	---	---	---	---	---	---	---	---	---









R geometrie, 90° WSP zum Schulterfräsen, mit positiven Design bei instabilen Schnittbedingungen.



SDMT 120508SN-R:M8330	0.8	225	0.20	4.0	-	-	-	210	0.20	4.0	-	-	-	-	-	-	-	-
SDMT 120508SN-R:M8345	0.8	165	0.20	4.0	-	-	-	-	-	-	-	-	-	-	-	-	-	-
SDMT 1205AESN-R:M8330	-	265	0.20	4.0	-	-	-	250	0.20	4.0	-	-	-	-	-	-	-	-
SDMT 1205AESN-R:M8340	-	240	0.20	4.0	-	-	-	225	0.20	4.0	-	-	-	-	-	-	-	-



a_e / DCX	5 %	10 %	15 %	20 %	25 %	30 %	40 %	50 %	60 %	70 %	75 %	80 %	90 %	100 %
 X.V	1.48	1.35	1.27	1.22	1.19	1.16	1.11	1.08	1.05	1.03	1.00	1.00	1.00	1.00
 X.f	2.20	1.60	1.35	1.20	1.10	0.95	0.85	0.75	0.85	0.95	1.00	1.00	1.00	1.00
 X.f	0.64	0.64	0.64	0.64	0.64	0.65	0.65	0.67	0.68	0.71	0.72	0.74	0.79	1.00

	ODKT 05-F	ODKT 05-FM	ODMT 05-FM	ODMT 05-R
	0.4	0.8	0.8	0.8
	1.00	1.00	–	–

	RDGT 12-F	RDGT 12-FM	RDGT 12-R
	6.35	6.35	6.35
	–	–	–

	SDKT 12-F	SDKT 12-FM	SDMT 12-F	SDMT 12-R
	0.8	0.8	0.8	0.8
	2.30	2.30	–	–

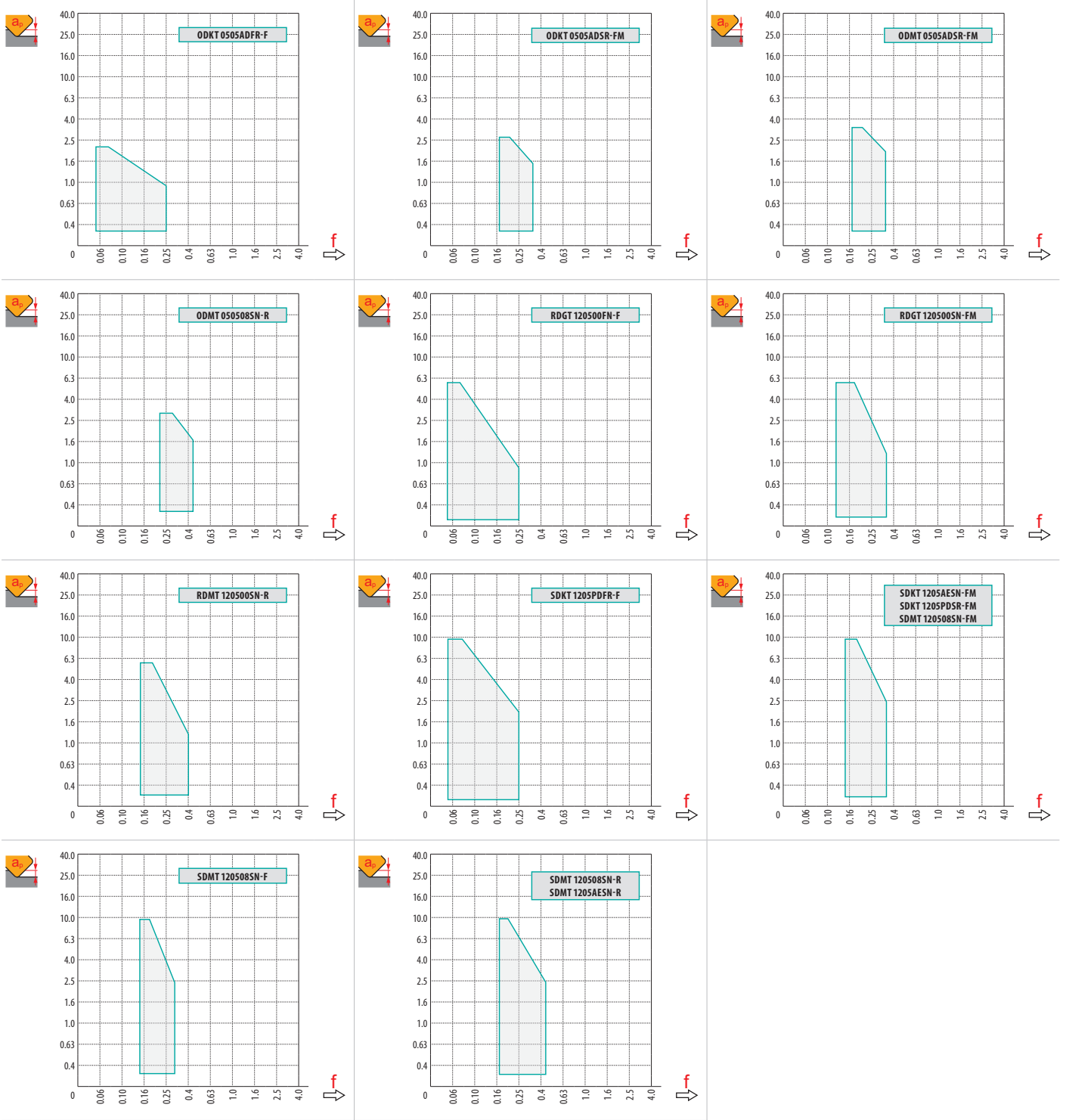

		R													
			0.25	0.50	0.60	0.70	0.80	1.00	1.25	1.50	2.00	3.00	4.00	5.00	6.00
32			23.43	24.80	25.23	25.62	25.99	26.63	27.33	27.94	28.94	30.39	31.31	31.83	32.00
40			31.43	32.80	33.23	33.62	33.99	34.63	35.33	35.94	36.94	38.39	39.31	39.83	40.00
50			41.43	42.80	43.23	43.62	43.99	44.63	45.33	45.94	46.94	48.39	49.31	49.83	50.00
63			54.43	55.80	56.23	56.62	56.99	57.63	58.33	58.94	59.94	61.39	62.31	62.83	63.00
80			71.43	72.80	73.23	73.62	73.99	74.63	75.33	75.94	76.94	78.39	79.31	79.83	80.00
100			91.43	92.80	93.23	93.62	93.99	94.63	95.33	95.94	96.94	98.39	99.31	99.83	100.00
125		116.43	117.80	118.23	118.62	118.99	119.63	120.33	120.94	121.94	123.39	124.31	124.83	125.00	



		f_{max}
32	1.36	0.28
40	1.40	0.31
50	1.43	0.33
63	1.47	0.37
80	1.52	0.42
100	1.57	0.47
125	1.62	0.52



S



10.0



S

a_p	1.0	5.0	10.0
	0.35	0.21	0.15



50	4.1°	7.05/100
63	2.7°	4.6/100
80	1.8°	3/100
100	1.7°	2.85/100
125	0.7°	1.1/100

50	3.8°	6.2/95
63	2.5°	4.25/100
80	1.7°	2.85/100
100	1.6°	2.65/100
125	0.3°	0.4/100



	DMIN	DMAX		
50	78.0	100.0	4.5	4.5
63	105.0	126.0	4.5	4.5
80	138.0	160.0	4.5	4.5
100	178.0	200.0	4.5	4.5
125	229.0	250.0	4.0	4.5

	DMIN	DMAX		
50	78.0	100.0	4.5	4.5
63	105.0	126.0	4.5	4.5
80	138.0	160.0	4.5	4.5
100	178.0	200.0	4.5	4.5
125	230.0	250.0	4.0	4.5



2.4

2.3



R

	μm	3	5	10	15	20	30	40	50	60	80	100
32		0.620	0.800	1.131	1.386	1.600	1.960	2.263	2.530	2.771	3.200	3.578
40		0.693	0.894	1.265	1.549	1.789	2.191	2.530	2.828	3.098	3.578	4.000
50		0.775	1.000	1.414	1.732	2.000	2.449	2.828	3.162	3.464	4.000	4.472
63		0.869	1.122	1.587	1.944	2.245	2.750	3.175	3.550	3.888	4.490	5.020
80		0.980	1.265	1.789	2.191	2.530	3.098	3.578	4.000	4.382	5.060	5.657
100		1.095	1.414	2.000	2.449	2.828	3.464	4.000	4.472	4.899	5.657	6.325
125		1.225	1.581	2.236	2.739	3.162	3.873	4.472	5.000	5.477	6.325	7.071



3

5

10

15

20

30

40

50

60

80

100

6.0



0.379

0.490

0.693

0.849

0.980

1.200

1.386

1.549

1.697

1.960

2.191



ODKT 05

ODMT 05

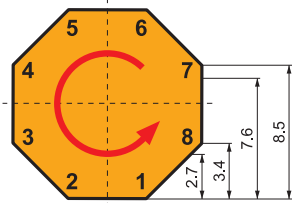

a_p	
-> 2.7	8
-> 3.4	7
-> 7.6	4
-> 8.5	2

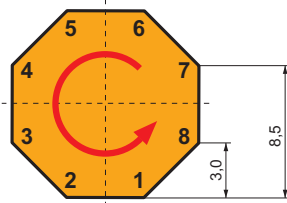

a_p	
-> 3.0	8
-> 8.5	4

SOD06D

P
M
K
S
H

PRAMET

S

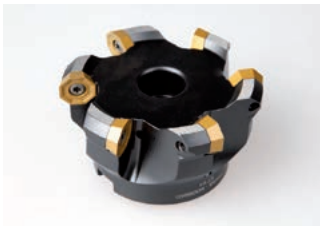

Universeller Planfräser in positiver Ausführung und Innenkühlung

Highly productive universal face mill utilising single sided positive inserts with APMX of up to 3.1 (8.6) mm. Unique insert seat fits OD.. 06 and RP.. 15 style inserts, suited for face milling and chamfering. Arbor style only with differential tooth pitch. Body treated for longer tool life.

KAPR	45°
APMX	3.1 (8.6) mm

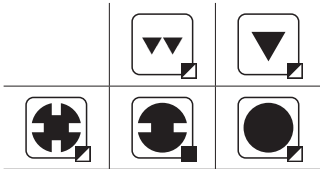
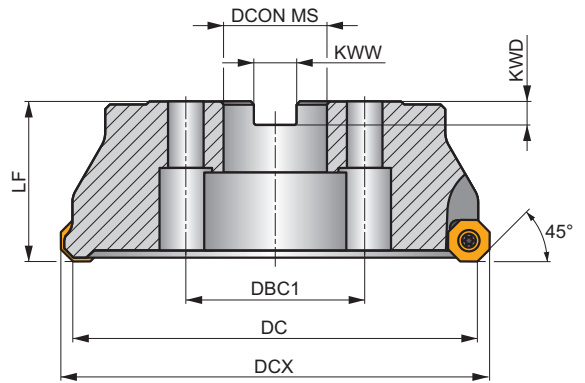
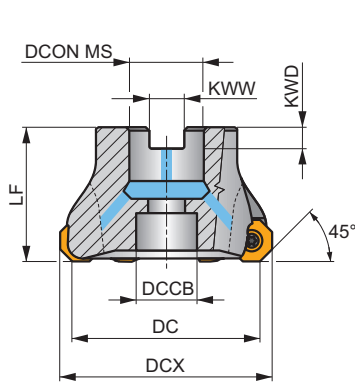
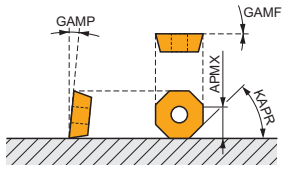

0.12 - 0.22



Produkt	DC (mm)	DCX (mm)	LF (mm)	DCON MS (mm)	DCCB (mm)	DBC1 (mm)	KWW (mm)	KWD (mm)	GAMF (°)	GAMP (°)							
63A05R-S450D06D	63	72.5	40	22	18	-	10.4	6.3	0	5	5	✓	8800	✓	0.55	GI059	FA071
80A06R-S450D06D	80	89.5	50	27	20	-	12.4	7	0	5	6	✓	7800	✓	1.19	GI059	FA071
100A07R-S450D06D	100	109.5	50	32	27	-	14.4	8	0	5	7	✓	7000	✓	2.07	GI059	FA071
125A08R-S450D06D	125	134.5	63	40	33	-	16.4	9	0	5	8	✓	6300	✓	4.05	GI059	FA071
160C09R-S450D06D	160	169.5	63	40	56	66.7	16.4	9	0	5	9	✓	5500	-	6.49	GI059	FA071

GI059	OD.. 0605ZZ..	RP.. 1505MO..

FA071	US 4511-T20	5.0	M 4.5	11	SDR T20-T

ODMT 06



	IC (mm)	D1 (mm)	S (mm)
0605	15.875	5.50	5.56

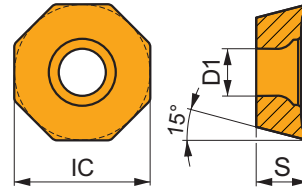

Eignung und Startwerte für Schnittgeschwindigkeit (vc), Vorschub (f) und Schnitttiefe (ap). Weitere Informationen finden Sie in unserer Zerspanungsrechner-App.

Produkt	RE (mm)	P			M			K			N			S			H		
		vc (m/min)	f (mm/tooth)	ap (mm)	vc (m/min)	f (mm/tooth)	ap (mm)	vc (m/min)	f (mm/tooth)	ap (mm)	vc (m/min)	f (mm/tooth)	ap (mm)	vc (m/min)	f (mm/tooth)	ap (mm)	vc (m/min)	f (mm/tooth)	ap (mm)

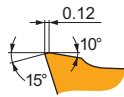

ZZN leicht positive Ausführung, 45° WSP zum Planfräsen, zur mittleren Bearbeitung.

ODMT 0605ZZN:M5315	☹	–	☑	255	0.24	3.0	–	–	–	☹	240	0.24	3.0	–	–	–	–	–	–	–	–	–	–
ODMT 0605ZZN:M8330	☹	–	☹	200	0.24	3.0	–	–	–	☹	190	0.24	3.0	–	–	–	–	–	–	–	–	–	–
ODMT 0605ZZN:M8340	☹	–	☹	185	0.24	3.0	–	–	–	☑	175	0.24	3.0	–	–	–	–	–	–	–	–	–	–
ODMT 0605ZZN:M9325	☹	–	☹	245	0.24	3.0	–	–	–	☹	230	0.24	3.0	–	–	–	–	–	–	–	–	–	–

ODEW 06



	IC (mm)	D1 (mm)	S (mm)
0605	15.875	5.50	5.56

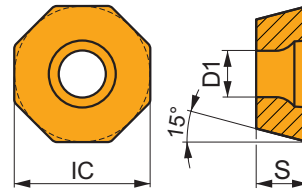

Eignung und Startwerte für Schnittgeschwindigkeit (vc), Vorschub (f) und Schnitttiefe (ap). Weitere Informationen finden Sie in unserer Zerspanungsrechner-App.

Produkt	RE (mm)	P			M			K			N			S			H		
		vc (m/min)	f (mm/tooth)	ap (mm)	vc (m/min)	f (mm/tooth)	ap (mm)	vc (m/min)	f (mm/tooth)	ap (mm)	vc (m/min)	f (mm/tooth)	ap (mm)	vc (m/min)	f (mm/tooth)	ap (mm)	vc (m/min)	f (mm/tooth)	ap (mm)

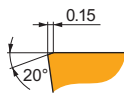

ZZN ohne Spanwinkel, 45° WSP zum Planfräsen, zur mittleren Bearbeitung.

ODEW 0605ZZN:M8330	☹	–	☑	210	0.26	2.5	–	–	–	☹	195	0.26	2.5	–	–	–	–	–	–	☑	40	0.13	1.0
---------------------------	---	---	---	-----	------	-----	---	---	---	---	-----	------	-----	---	---	---	---	---	---	---	----	------	-----

RPET 15



	INSD	D1	S
	(mm)	(mm)	(mm)
1505	15.785	5.50	5.56

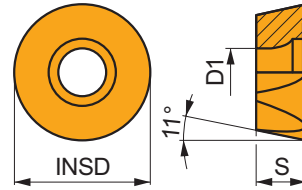

Eignung und Startwerte für Schnittgeschwindigkeit (vc), Vorschub (f) und Schnitttiefe (ap). Weitere Informationen finden Sie in unserer Zerspanungsrechner-App.

Produkt	RE (mm)	P			M			K			N			S			H		
		vc (m/min)	f (mm/tooth)	ap (mm)	vc (m/min)	f (mm/tooth)	ap (mm)	vc (m/min)	f (mm/tooth)	ap (mm)	vc (m/min)	f (mm/tooth)	ap (mm)	vc (m/min)	f (mm/tooth)	ap (mm)	vc (m/min)	f (mm/tooth)	ap (mm)

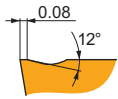

M geometrie, WSP zum Kopier- und Profilverfahren, mit positiven Design zur leichten Bearbeitung bis zur Schruppbearbeitung.

RPET 1505MOS-M:M8330	✳	-	■	230	0.40	1.0	■	135	0.36	1.0	■	215	0.40	1.0	-	-	-	■	55	0.28	0.8	-	-	-
-----------------------------	---	---	---	-----	------	-----	---	-----	------	-----	---	-----	------	-----	---	---	---	---	----	------	-----	---	---	---



a_e / DC	5 %	10 %	15 %	20 %	25 %	30 %	40 %	50 %	60 %	70 %	75 %	80 %	90 %	100 %
	1.48	1.35	1.27	1.22	1.19	1.16	1.11	1.08	1.05	1.03	1.00	1.00	1.00	1.00
	2.20	1.60	1.35	1.20	1.10	0.95	0.85	0.75	0.85	0.95	1.00	1.00	1.00	1.00
	0.64	0.64	0.64	0.64	0.64	0.65	0.65	0.67	0.68	0.71	0.72	0.74	0.79	1.00

	ODMT 06	ODEW 06	RPET 15-M
	-	-	7.89
	1.73	5.92	-

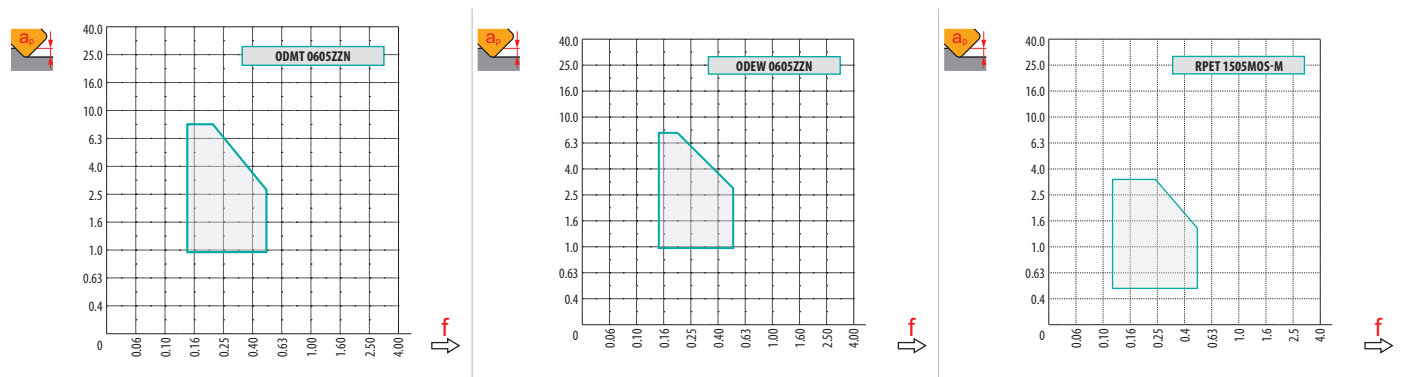

		R								
		0.00	0.50	0.75	1.25	1.50	2.00	2.50	3.00	4.00
63		56.63	62.17	63.36	65.18	65.91	67.16	68.19	69.05	70.41
80		73.63	79.17	80.36	82.18	82.91	84.16	85.19	86.05	87.41
100		93.63	99.17	100.36	102.18	102.91	104.16	105.19	106.05	107.41
125		118.63	124.17	125.36	127.18	127.91	129.16	130.19	131.05	132.41
160		153.63	159.17	160.36	162.18	162.91	164.16	165.19	166.05	167.41



		f_{max}
63	1.49	0.78
80	1.54	0.88
100	1.59	0.98
125	1.64	1.10
160	1.70	1.24

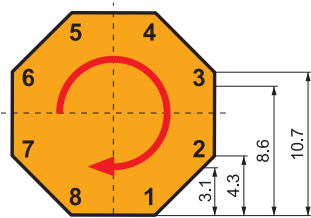

→ 3.1	8
→ 4.3	7
→ 8.6	4
→ 10.7	2

SOE06Z

P **M** **N** **S**

PRAMET

S



Universeller Planfräser in positiver Ausführung und Innenkühlung

Hochproduktiver universeller Planfräser mit positiven einseitigen Wendeschneidplatten mit einem APMX von 4 mm für RE.. 16WSP. Einzigartiger Plattensitz für OE.. 06-, RE.. 16- und XE.. 06-Wendeschneidplatten, geeignet für eine Vielzahl von Anwendungen. Aufsteckfräser mit ungleicher Zahnteilung. Körper für längere Standzeiten oberflächenbehandelt.

KAPR	43°
APMX	3.3 (9.9) mm

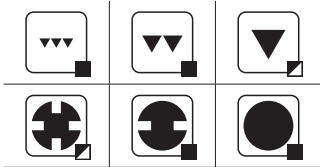
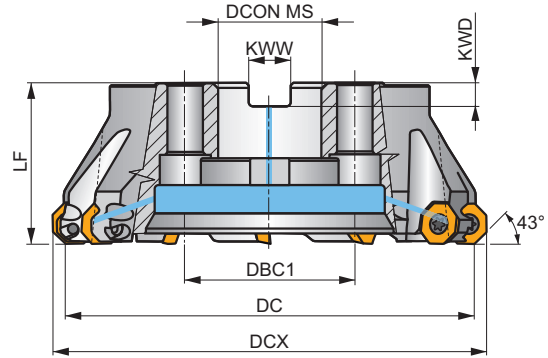
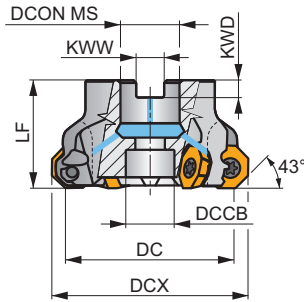
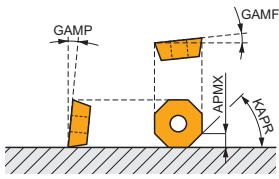

0.06 - 0.20



Produkt	DC	DCX	LF	DCON MS	DCCB	DBC1	KWW	KWD	GAMF	GAMP											
	(mm)	(mm)	(mm)	(mm)	(mm)	(mm)	(mm)	(mm)	(°)	(°)											
50A04R-S450E06Z-C	50	60.2	40	22	18	-	10.4	6.3	6	10	4	✓	10700	✓	0.47	GI283	FA053	-			
50A05R-S450E06Z-C	50	60	40	22	18	-	10.4	6.3	1	10	5	✓	10700	✓	0.47	GI283	FA053	-			
56A05R-S450E06Z-C	56	66	40	22	18	-	10.4	6.3	6	10	5	✓	10100	✓	0.52	GI283	FA053	-			
63A04R-S450E06Z-C	63	73.2	40	22	18	-	10.4	6.3	6	10	4	✓	9600	✓	0.58	GI283	FA053	-			
63A06R-S450E06Z-C	63	73	40	22	18	-	10.4	6.3	1	10	6	✓	9600	✓	0.60	GI283	FA053	-			
70A06R-S450E06Z-C	70	80	40	22	18	-	10.4	6.3	6	10	6	✓	9100	✓	0.69	GI283	FA053	-			
80A05R-S450E06Z-C	80	90.2	50	27	38	-	12.4	7	6	10	5	✓	8500	✓	1.02	GI283	FA051	AC001			
80A06R-S450E06Z-C	80	90.2	50	27	38	-	12.4	7	6	10	6	✓	8500	✓	1.03	GI283	FA051	AC001			
90A07R-S450E06Z-C	90	100	50	32	45	-	14.4	8	6	10	7	✓	8000	✓	1.59	GI283	FA051	AC002			
100A06R-S450E06Z-C	100	110.2	50	32	45	-	14.4	8	6	10	6	✓	7600	✓	1.85	GI283	FA051	AC002			
100A08R-S450E06Z-C	100	109.9	50	32	45	-	14.4	8	1	10	8	✓	7600	✓	1.87	GI283	FA051	AC002			
125A07R-S450E06Z-C	125	135.2	63	40	56	-	16.4	9	6	10	7	✓	6800	✓	3.31	GI283	FA051	AC003			
125A09R-S450E06Z-C	125	134.9	63	40	56	-	16.4	9	1	10	9	✓	6800	✓	3.35	GI283	FA051	AC003			
160C09R-S450E06Z-C	160	170.2	63	40	-	66.7	16.4	9	6	10	9	✓	6000	✓	6.08	GI283	FA056	-			
160C12R-S450E06Z-C	160	169.9	63	40	-	66.7	16.4	9	1	10	12	✓	6000	✓	7.06	GI283	FA056	-			
200C11R-S450E06Z-C	200	210.2	63	60	-	101.6	25.7	14	6	10	11	✓	5300	✓	10.80	GI283	FA057	-			
200C14R-S450E06Z-C	200	209.9	63	60	-	101.6	25.7	14	1	10	14	✓	5300	✓	11.15	GI283	FA057	-			

GI283	OEHT 0604AE..	XEHT 0604AE..

FA051	US 5011-T20P	5.0	M 5	11	SDR T20P-T	-	-	-	-
FA053	US 5011-T20P	5.0	M 5	11	SDR T20P-T	HS 1030C	-	-	-

FA056	US 5011-T20P	5.0	M 5	11	SDR T20P-T	HS 1240C	CAC 160C	HSD 0825C	HXK 5
FA057	US 5011-T20P	5.0	M 5	11	SDR T20P-T	HS 1655C	CAC 200C	HSD 1025C	HXK 7

AC001	KS 1230	K.FMH27
AC002	KS 1635	K.FMH32
AC003	KS 2040	K.FMH40

OEHT 06



	IC	D1	S
	(mm)	(mm)	(mm)
0604	16.050	5.50	4.76

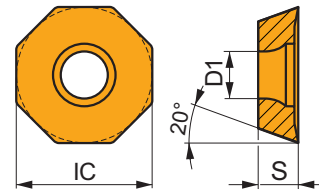

Eignung und Startwerte für Schnittgeschwindigkeit (vc), Vorschub (f) und Schnitttiefe (ap). Weitere Informationen finden Sie in unserer Zerspanungsrechner-App.

Produkt	RE (mm)	P			M			K			N			S			H		
		vc (m/min)	f (mm/tooth)	ap (mm)	vc (m/min)	f (mm/tooth)	ap (mm)	vc (m/min)	f (mm/tooth)	ap (mm)	vc (m/min)	f (mm/tooth)	ap (mm)	vc (m/min)	f (mm/tooth)	ap (mm)	vc (m/min)	f (mm/tooth)	ap (mm)

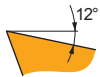
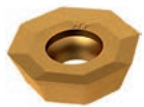

MF geometrie, 45° WSP zum Planfräsen, mit scharfen positiven Design zur leichten bis mittleren Bearbeitung und potentiellen Schlichtbearbeitung.

OEHT 0604AEER-MF:M6330	☺	-	255	0.12	2.2	180	0.11	2.2	-	-	-	-	-	-	75	0.10	1.8	-	-	-
OEHT 0604AEER-MF:M8330	☺	-	295	0.12	2.2	175	0.11	2.2	-	-	-	885	0.14	2.2	70	0.10	1.8	-	-	-
OEHT 0604AEER-MF:M8340	☺	-	275	0.12	2.2	165	0.11	2.2	-	-	-	-	-	-	65	0.10	1.8	-	-	-

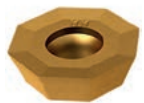

MM geometrie, 45° WSP zum Planfräsen, mit scharfen positiven Design zur leichten bis mittleren Bearbeitung.

OEHT 0604AEER-MM:M6330	☺	-	245	0.16	2.2	170	0.14	2.2	-	-	-	-	-	-	70	0.11	1.8	-	-	-
OEHT 0604AEER-MM:M8330	☺	-	280	0.16	2.2	165	0.14	2.2	-	-	-	840	0.19	2.2	70	0.11	1.8	-	-	-
OEHT 0604AEER-MM:M8340	☺	-	255	0.16	2.2	150	0.14	2.2	-	-	-	-	-	-	60	0.11	1.8	-	-	-
OEHT 0604AEER-MM:M8345	☺	-	205	0.16	2.2	120	0.14	2.2	-	-	-	-	-	-	50	0.11	1.8	-	-	-
OEHT 0604AEER-MM:M9340	☺	-	320	0.16	2.2	190	0.14	2.2	-	-	-	-	-	-	80	0.11	1.8	-	-	-

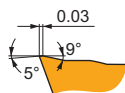

M geometrie, 45° WSP zum Planfräsen, mit leicht positiven Design zur leichten bis mittleren Bearbeitung.

OEHT 0604AESR-M:M6330	☺	-	210	0.24	3.2	150	0.22	3.2	-	-	-	-	-	-	60	0.17	2.6	-	-	-
OEHT 0604AESR-M:M8310	☺	-	265	0.24	3.2	135	0.22	3.2	-	-	-	-	-	-	-	-	-	-	-	-
OEHT 0604AESR-M:M8330	☺	-	245	0.24	3.2	145	0.22	3.2	-	-	-	-	-	-	60	0.17	2.6	-	-	-
OEHT 0604AESR-M:M8340	☺	-	220	0.24	3.2	130	0.22	3.2	-	-	-	-	-	-	55	0.17	2.6	-	-	-
OEHT 0604AESR-M:M9325	☺	-	295	0.24	3.2	-	-	-	-	-	-	-	-	-	-	-	-	-	-	-

REHT 16



	INSD (mm)	D1 (mm)	S (mm)
1604	16.000	5.50	4.76

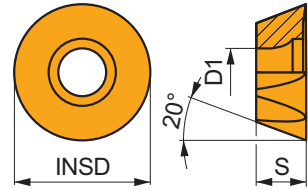

Eignung und Startwerte für Schnittgeschwindigkeit (vc), Vorschub (f) und Schnitttiefe (ap). Weitere Informationen finden Sie in unserer Zerspanungsrechner-App.

Produkt	RE (mm)	P			M			K			N			S			H		
		vc (m/min)	f (mm/tooth)	ap (mm)	vc (m/min)	f (mm/tooth)	ap (mm)	vc (m/min)	f (mm/tooth)	ap (mm)	vc (m/min)	f (mm/tooth)	ap (mm)	vc (m/min)	f (mm/tooth)	ap (mm)	vc (m/min)	f (mm/tooth)	ap (mm)

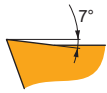
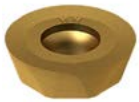

MM geometrie, WSP zum Kopier- und Profilfräsen, mit leicht positiven Design zur leichten bis mittleren Bearbeitung.

REHT 1604MOEN-MM:M6330	☼	–	255	0.20	2.0	180	0.18	2.0	–	–	–	–	–	–	–	75	0.14	1.6	–	–	–
REHT 1604MOEN-MM:M8340	☼	–	270	0.20	2.0	160	0.18	2.0	–	–	–	–	–	–	–	65	0.14	1.6	–	–	–
REHT 1604MOEN-MM:M9340	☼	–	330	0.20	2.0	195	0.18	2.0	–	–	–	–	–	–	–	80	0.14	1.6	–	–	–

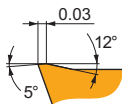

M geometrie, WSP zum Kopier- und Profilfräsen, mit positiven Design zur leichten bis mittleren Bearbeitung.

REHT 1604MOSN-M:M8310	☼	–	285	0.30	2.0	145	0.27	2.0	–	–	–	–	–	–	–	–	–	–	–	–	–
REHT 1604MOSN-M:M8330	☼	–	270	0.30	2.0	160	0.27	2.0	–	–	–	–	–	–	–	65	0.21	1.6	–	–	–
REHT 1604MOSN-M:M8340	☼	–	245	0.30	2.0	145	0.27	2.0	–	–	–	–	–	–	–	60	0.21	1.6	–	–	–

OEHT 06-FA



	IC (mm)	D1 (mm)	S (mm)
0604	16.050	5.50	4.76

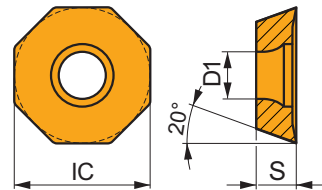

Eignung und Startwerte für Schnittgeschwindigkeit (vc), Vorschub (f) und Schnitttiefe (ap). Weitere Informationen finden Sie in unserer Zerspanungsrechner-App.

Produkt	RE (mm)	P			M			K			N			S			H		
		vc (m/min)	f (mm/tooth)	ap (mm)	vc (m/min)	f (mm/tooth)	ap (mm)	vc (m/min)	f (mm/tooth)	ap (mm)	vc (m/min)	f (mm/tooth)	ap (mm)	vc (m/min)	f (mm/tooth)	ap (mm)	vc (m/min)	f (mm/tooth)	ap (mm)

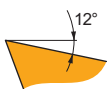

FA geometrie, 45° WSP zum Planfräsen, mit hoch positiven Design zur feinen Schlichtbearbeitung bis zur mittleren Bearbeitung.

OEHT 0604AEFR-FA:HF7	●	–	–	–	–	–	–	–	–	–	–	–	–	–	–	330	0.18	2.0	–	–	–
OEHT 0604AEFR-FA:M0315	●	–	–	–	–	–	–	–	–	–	–	–	–	–	–	765	0.18	2.0	–	–	–

XEHT 06



	IC	D1	S
	(mm)	(mm)	(mm)
0604	16.050	5.50	4.76

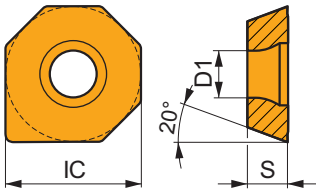

Eignung und Startwerte für Schnittgeschwindigkeit (vc), Vorschub (f) und Schnitttiefe (ap). Weitere Informationen finden Sie in unserer Zerspanungsrechner-App.

Produkt	RE (mm)	P			M			K			N			S			H		
		vc (m/min)	f (mm/tooth)	ap (mm)	vc (m/min)	f (mm/tooth)	ap (mm)	vc (m/min)	f (mm/tooth)	ap (mm)	vc (m/min)	f (mm/tooth)	ap (mm)	vc (m/min)	f (mm/tooth)	ap (mm)	vc (m/min)	f (mm/tooth)	ap (mm)

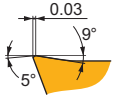

W leicht positive Wiper-geometrie für verbesserte Oberflächengüte.

XEHT 0604AESR:M8310	●	–	■	265	0.24	3.2	▣	135	0.22	3.2	■	–	–	–	■	–	–	–	■	–	–	–
XEHT 0604AESR:M8330	⊛	–	■	245	0.24	3.2	▣	145	0.22	3.2	■	–	–	–	■	–	–	–	■	–	–	–



a_e / DC	5 %	10 %	15 %	20 %	25 %	30 %	40 %	50 %	60 %	70 %	75 %	80 %	90 %	100 %
	1.48	1.35	1.27	1.22	1.19	1.16	1.11	1.08	1.05	1.03	1.00	1.00	1.00	1.00
	2.20	1.60	1.35	1.20	1.10	0.95	0.85	0.75	0.85	0.95	1.00	1.00	1.00	1.00
	0.64	0.64	0.64	0.64	0.64	0.65	0.65	0.67	0.68	0.71	0.72	0.74	0.79	1.00

	OEHT 06-MF	OEHT 06-MM	OEHT 06-M	OEHT 06-FA	XEHT 06	REHT 16-MM	REHT 16-M
	-	-	-	-	-	8.00	8.00
	1.36	1.36	1.36	1.36	9.91	-	-

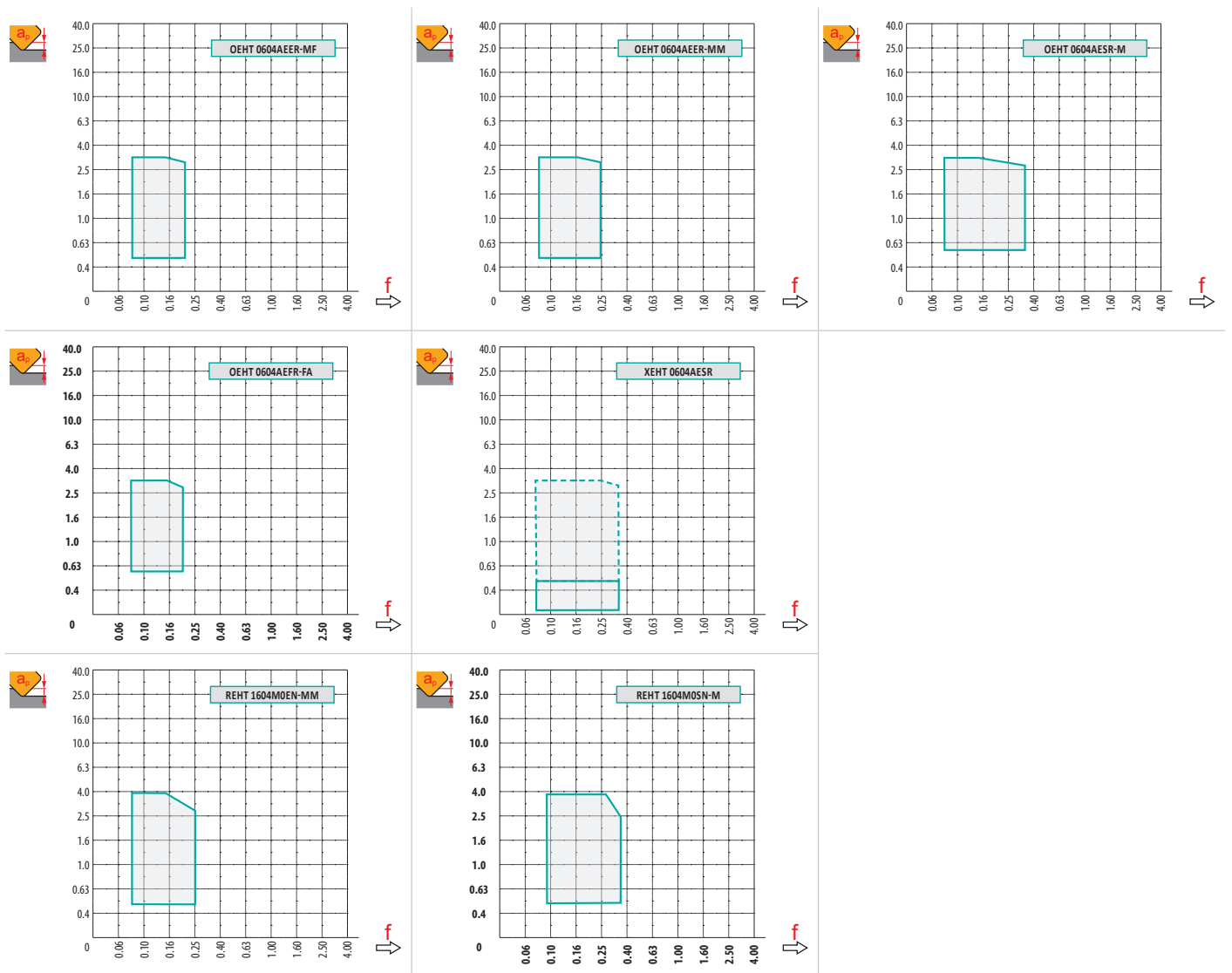

	R									
		0.00	0.50	0.75	1.25	1.50	2.00	2.50	3.00	4.00
50		43.90	49.47	50.66	52.49	53.23	54.48	55.52	56.39	57.76
56		49.80	55.37	56.56	58.39	59.13	60.38	61.42	62.29	63.66
63		56.90	62.47	63.66	65.49	66.23	67.48	68.52	69.39	70.76
70		63.80	69.37	70.56	72.39	73.13	74.38	75.42	76.29	77.66
80		73.90	79.47	80.66	82.49	83.23	84.48	85.52	86.39	87.76
90		83.80	89.37	90.56	92.39	93.13	94.38	95.42	96.29	97.66
100		93.90	99.47	100.66	102.49	103.23	104.48	105.52	106.39	107.76
125		118.90	124.47	125.66	127.49	128.23	129.48	130.52	131.39	132.76
160		153.90	159.47	160.66	162.49	163.23	164.48	165.52	166.39	167.76
200		193.90	199.47	200.66	202.49	203.23	204.48	205.52	206.39	207.76

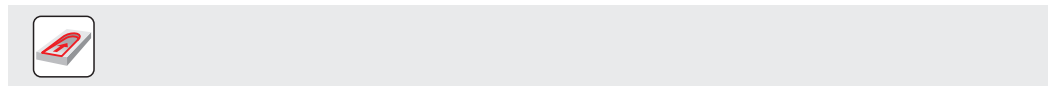
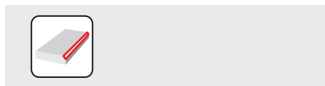

		f_{max}
50	1.43	0.33
56	1.45	0.35
63	1.47	0.37
70	1.49	0.39
80	1.52	0.42
90	1.55	0.44
100	1.57	0.47
125	1.62	0.52
160	1.68	0.59
200	1.73	0.66

O		
	RPMX	APMX/I
50	4.9°	8.4/100
56	4.2°	7.2/100
63	3.6°	6.1/100
70	3.1°	5.3/100
80	2.6°	4.4/100
90	2.3°	3.9/100
100	2.0°	3.3/100
125	1.5°	2.5/100

R		
	RPMX	APMX/I
59.9	4.6°	7.9/100
65.8	4.0°	6.8/100
72.9	3.0°	5.1/100
79.8	2.7°	4.6/100
89.9	2.2°	3.7/100
99.8	2.0°	3.3/100
109.9	1.8°	3.0/100
134.9	1.3°	2.1/100

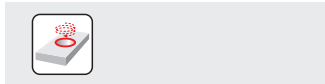

O				
	DMIN	DMAX		
50	91.5	120.0	5.9	5.9
56	103.2	131.5	5.9	5.9
63	117.4	146.0	5.9	5.9
70	131.2	159.5	5.9	5.9
80	151.4	180.0	5.9	5.9
90	171.2	199.5	5.9	5.9
100	191.4	220.0	5.9	5.9
125	241.3	270.0	5.9	5.9

R				
	DMIN	DMAX		
59.9	91.5	119.5	5.9	5.9
65.8	103.5	131.0	5.9	5.9
72.9	118.0	145.5	5.9	5.9
79.8	131.5	159.0	5.9	5.9
89.9	151.5	179.5	5.9	5.9
99.8	171.5	199.0	5.9	5.9
109.9	191.5	219.5	5.9	5.9
134.9	241.5	269.5	5.9	5.9

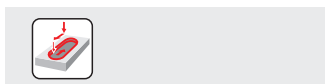

	O	R
	3.1	3.0



R

DCX	μm	3	5	10	15	20	30	40	50	60	80	100
59.9		0.848	1.095	1.548	1.896	2.189	2.681	3.096	3.461	3.792	4.378	4.895
65.8		0.889	1.147	1.622	1.987	2.294	2.810	3.245	3.628	3.974	4.589	5.130
72.9		0.935	1.207	1.708	2.091	2.415	2.958	3.415	3.818	4.183	4.830	5.400
79.8		0.979	1.263	1.787	2.188	2.527	3.095	3.573	3.995	4.376	5.053	5.650
89.9		1.039	1.341	1.896	2.322	2.682	3.285	3.793	4.240	4.645	5.364	5.997
99.8		1.094	1.413	1.998	2.447	2.826	3.461	3.996	4.468	4.894	5.651	6.318

RE	μm	3	5	10	15	20	30	40	50	60	80	100
8.0		0.438	0.566	0.800	0.980	1.131	1.386	1.600	1.789	1.960	2.263	2.530

i

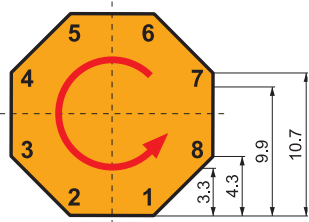

-> 3.3	8
-> 4.3	7
-> 9.9	4
-> 10.7	2

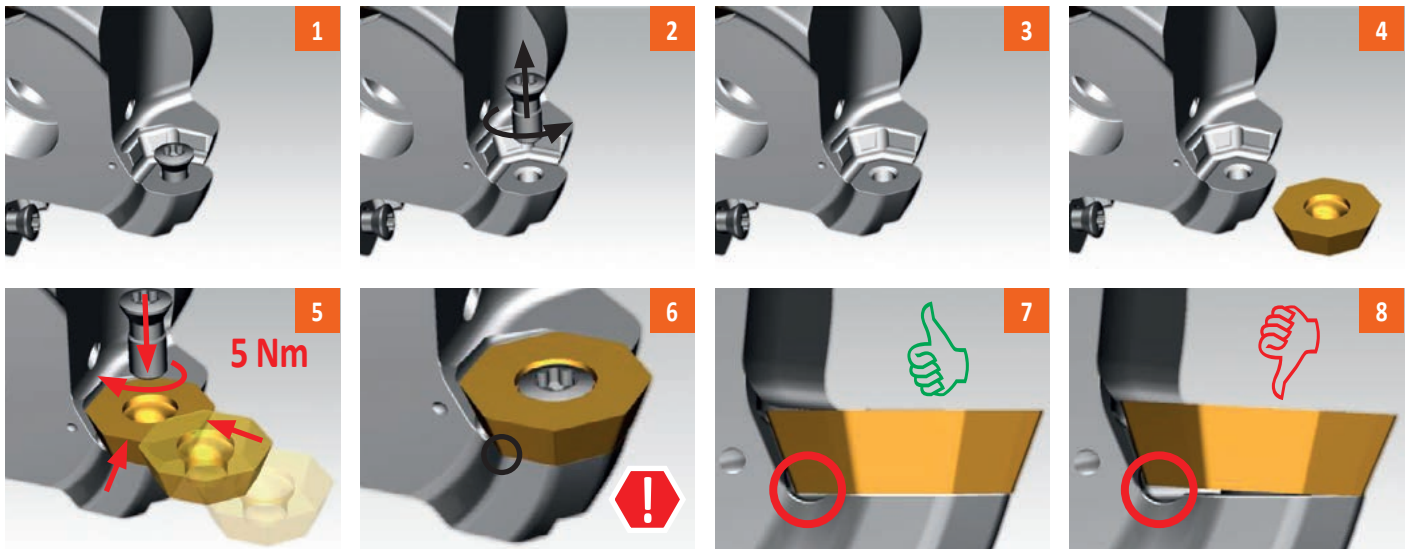



ECKFRÄSEN

WENDEPLATTENFRÄSER – AUSWAHLHILFE

PLANFRÄSEN

	STN10		STN16		SLN12		SLN16		SLN12X									
	90°		90°		90°		90°		90°									
	APMX (mm)	5.0	APMX (mm)	10.0	APMX (mm)	9.0	APMX (mm)	13.0	APMX (mm)	10.0								
	DC (mm)	18 – 80	DC (mm)	25 – 175	DC (mm)	25 – 125	DC (mm)	63 – 175	DC (mm)	25 – 125								
Zylindrischer Schaft		DC = 18 – 35 (mm)		DC = 25 – 35 (mm)		DC = 25, 32 (mm)				DC = 25 – 40 (mm)								
Weldon		DC = 20 – 32 (mm)		DC = 25 – 40 (mm)		DC = 25 – 40 (mm)				DC = 25 – 40 (mm)								
Modular		DC = 20 – 32 (mm)		DC = 25 – 40 (mm)		DC = 25 – 40 (mm)												
Aufsteckfräser		DC = 40 – 80 (mm)		DC = 40 – 175 (mm)		DC = 40 – 125 (mm)				DC = 40 – 125 (mm)								
Seite	📖 66		📖 70		📖 75		📖 81		📖 85									
ISO	P	M	K	N	P	M	K	N	P	M	K	N	H	P	M	K	N	H
Schneidplattenform																		
Wendeschneidplatten	TNGX 1004		TNGX 1606		LNG 1205		LN.U 1607		LNEX 1210									
Anzahl der Schneiden	6		6		4		4		4									
Planfräsen	■		■		■		■		■									
Fasenfräsen	▣		▣		▣		▣		▣									
Schraubenlinien- interpolation	■		■		■		■		■									
Progressives Tauchfräsen	▣		■		■		■		■									
Rampen	▣		■		▣		■		■									
Fräsen geformter Flächen (Kopierfräsen)	▣		■		▣		■		▣									
Flaches Eckfräsen	■		■		▣		■		■									
Flaches Nutfräsen	■		■		▣		▣		■									

STN10

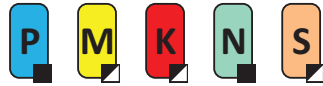

PRAMET

S



ECON TN10 Eckfräser mit Innenkühlung

90° Schafffräser und Messerköpfe mit doppelseitigen TNGX 10 Wendeschneidplatten mit 6 Schneidkanten und APMX von 5 mm. Geeignet für eine Vielzahl an Anwendungen. Erhältlich mit zylindrischem, Weldon-, modularem Schaft und als Aufsteckfräser mit oder ohne ungleicher Teilung. Für längere Standzeiten ist der Körper oberflächenbehandelt.

ECON TN

KAPR	90°
APMX	5.0 mm

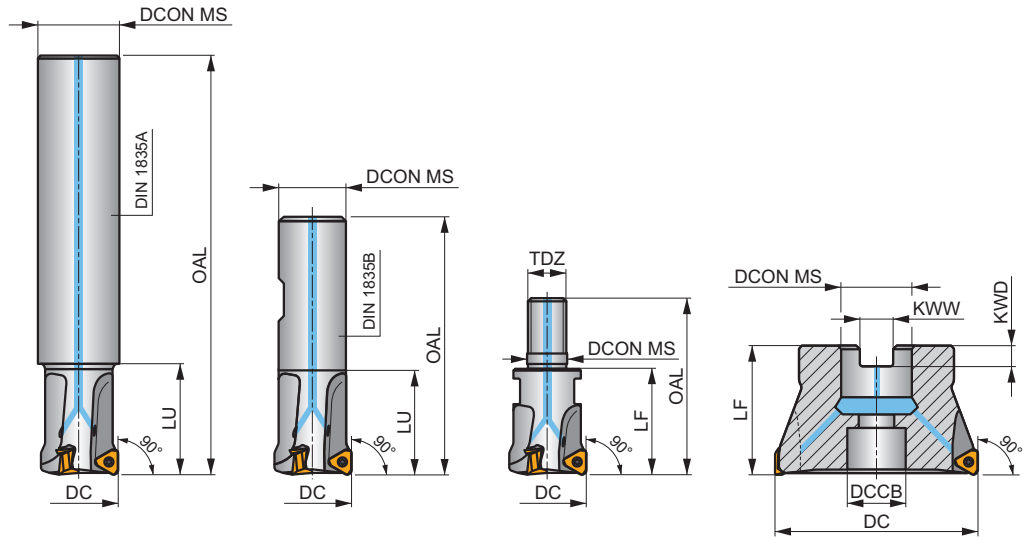
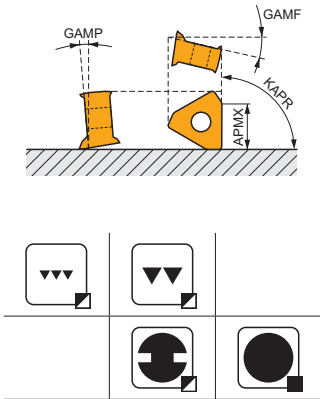

Produkt	DC (mm)	OAL (mm)	DCON MS (mm)	DCCB (mm)	LU (mm)	LF (mm)	TDZ	KWW (mm)	KWD (mm)	GAMF (°)	GAMP (°)	max.	kg	G1292	SQ300	SQ302	SQ303		
																		(mm)	(mm)
18A2R050A20-STN10-C	18	180	20	-	50	-	-	-	-	-17.1	-11	2	-	29100	✓	0.39	GI292	SQ300	-
20A2R029A20-STN10-C	20	150	20	-	29	-	-	-	-	-16.5	-11	2	-	27600	✓	0.35	GI292	SQ300	-
20A3R029A20-STN10-C	20	150	20	-	29	-	-	-	-	-16.5	-11	3	-	27600	✓	0.34	GI292	SQ300	-
22A3R050A25-STN10-C	22	180	25	-	50	-	-	-	-	-16.5	-11	3	-	26300	✓	0.58	GI292	SQ300	-
25A3R034A25-STN10-C	25	170	25	-	34	-	-	-	-	-16	-11	3	-	24700	✓	0.58	GI292	SQ300	-
25A4R034A25-STN10-C	25	170	25	-	34	-	-	-	-	-16	-11	4	✓	24700	✓	0.58	GI292	SQ300	-
30A4R050A32-STN10-C	30	200	32	-	50	-	-	-	-	-16	-11	4	✓	22500	✓	1.06	GI292	SQ300	-
32A4R037A32-STN10-C	32	195	32	-	37	-	-	-	-	-16	-11	4	✓	21800	✓	1.08	GI292	SQ300	-
32A5R037A32-STN10-C	32	195	32	-	37	-	-	-	-	-16	-11	5	✓	21800	✓	1.08	GI292	SQ300	-
35A5R080A32-STN10-C	35	200	32	-	80	-	-	-	-	-16	-11	5	✓	20800	✓	1.07	GI292	SQ300	-
20A2R032B20-STN10-C	20	90	20	-	32	-	-	-	-	-16.5	-11	2	-	27600	✓	0.20	GI292	SQ300	-
20A3R032B20-STN10-C	20	90	20	-	32	-	-	-	-	-16.5	-11	3	-	27600	✓	0.19	GI292	SQ300	-
25A3R042B25-STN10-C	25	100	25	-	42	-	-	-	-	-16	-11	3	-	24700	✓	0.31	GI292	SQ300	-
25A4R042B25-STN10-C	25	100	25	-	42	-	-	-	-	-16	-11	4	✓	24700	✓	0.31	GI292	SQ300	-
32A4R042B32-STN10-C	32	110	32	-	42	-	-	-	-	-16	-11	4	✓	21800	✓	0.57	GI292	SQ300	-
32A5R042B32-STN10-C	32	110	32	-	42	-	-	-	-	-16	-11	5	✓	21800	✓	0.56	GI292	SQ300	-
20A2R026M10-STN10-C	20	45	10.5	-	-	26	M10	-	-	-16.5	-11	2	-	-	✓	0.06	GI292	SQ300	-
20A3R026M10-STN10-C	20	45	10.5	-	-	26	M10	-	-	-16.5	-11	3	-	-	✓	0.06	GI292	SQ300	-
25A3R033M12-STN10-C	25	55	12.5	-	-	33	M12	-	-	-16	-11	3	-	-	✓	0.10	GI292	SQ300	-
25A4R033M12-STN10-C	25	55	12.5	-	-	33	M12	-	-	-16	-11	4	✓	-	✓	0.10	GI292	SQ300	-
32A4R043M16-STN10-C	32	66	17	-	-	43	M16	-	-	-16	-11	4	✓	-	✓	0.21	GI292	SQ300	-
32A5R043M16-STN10-C	32	66	17	-	-	43	M16	-	-	-16	-11	5	✓	-	✓	0.21	GI292	SQ300	-
40A04R-S90TN10-C	40	-	16	14	-	40	-	8.4	5.6	-15	-11	4	✓	19500	✓	0.34	GI292	SQ302	-
40A06R-S90TN10-C	40	-	16	14	-	40	-	8.4	5.6	-15	-11	6	✓	19500	✓	0.34	GI292	SQ302	-
50A05R-S90TN10-C	50	-	22	18	-	40	-	10.4	6.3	-15	-11	5	✓	17400	✓	0.48	GI292	SQ303	-
50A07R-S90TN10-C	50	-	22	18	-	40	-	10.4	6.3	-15	-11	7	✓	17400	✓	0.49	GI292	SQ303	-
63A06R-S90TN10-C	63	-	22	18	-	40	-	10.4	6.3	-15	-11	6	✓	15500	✓	0.63	GI292	SQ303	-

Produkt	DC	OAL	D CONIMS	DCB	LU	LF	TDZ	KWW	KWD	GAMF	GAMP	max.		kg	GI292	SQ303	AC001		
	(mm)	(mm)	(mm)	(mm)	(mm)	(mm)	(mm)	(mm)	(mm)	(°)	(°)	15500	13800						
63A09R-S90TN10-C	63	-	22	18	-	40	-	10.4	6.3	-15	-11	9	✓	15500	✓	0.63	GI292	SQ303	-
80A10R-S90TN10-C	80	-	27	38	-	50	-	12.4	7	-15	-11	10	✓	13800	✓	1.03	GI292	SQ301	AC001

	TNGX 1004..
--	-------------

SQ300	US 52506-T07P	0.8	M 2.5	6	-	-	Flag T07P	-
SQ301	US 52506-T07P	0.8	M 2.5	6	D-T07P/T09P	FG-15	-	-
SQ302	US 52506-T07P	0.8	M 2.5	6	D-T07P/T09P	FG-15	-	HS 0830C
SQ303	US 52506-T07P	0.8	M 2.5	6	D-T07P/T09P	FG-15	-	HS 1030C

AC001	KS 1230	K.FMH27
-------	---------	---------

TNGX 10



IC	D1	L	S	
(mm)	(mm)	(mm)	(mm)	
1004	6.000	2.80	10.39	4.69

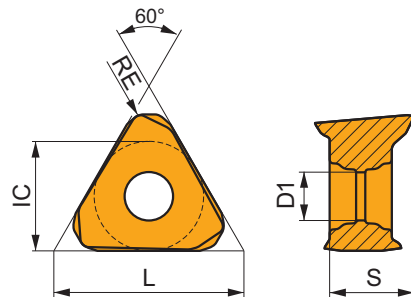

Eignung und Startwerte für Schnittgeschwindigkeit (vc), Vorschub (f) und Schnitttiefe (ap). Weitere Informationen finden Sie in unserer Zerspanungsrechner-App.

Produkt	RE (mm)	P			M			K			N			S			H		
		vc	f	ap	vc	f	ap	vc	f	ap	vc	f	ap	vc	f	ap			

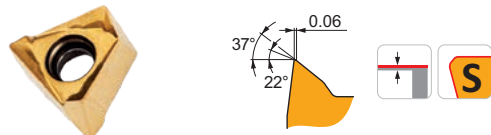

F Geometrie mit hoch positiven Design zum Schlichten.

TNGX 100402SR-F:M8330	● 0.2	■ 205	■ 0.09	■ 2.0	■ 120	■ 0.08	■ 2.0	■ 190	■ 0.09	■ 2.0	-	-	-	-	-	-	-	-
TNGX 100402SR-F:M8340	● 0.2	■ 190	■ 0.09	■ 2.0	■ 110	■ 0.08	■ 2.0	■ 180	■ 0.09	■ 2.0	-	-	-	-	-	-	-	-
TNGX 100404SR-F:8215	● 0.4	■ 225	■ 0.09	■ 2.0	■ 135	■ 0.08	■ 2.0	■ 210	■ 0.09	■ 2.0	-	-	-	-	-	-	-	-
TNGX 100404SR-F:M6330	● 0.4	■ 190	■ 0.09	■ 2.0	■ 135	■ 0.08	■ 2.0	-	-	-	-	-	-	-	-	-	-	-
TNGX 100404SR-F:M8330	● 0.4	■ 220	■ 0.09	■ 2.0	■ 130	■ 0.08	■ 2.0	■ 205	■ 0.09	■ 2.0	-	-	-	-	-	-	-	-
TNGX 100404SR-F:M8340	● 0.4	■ 200	■ 0.09	■ 2.0	■ 120	■ 0.08	■ 2.0	■ 190	■ 0.09	■ 2.0	-	-	-	-	-	-	-	-
TNGX 100404SR-F:M9340	● 0.4	■ 270	■ 0.09	■ 2.0	■ 160	■ 0.08	■ 2.0	-	-	-	-	-	-	-	-	-	-	-
TNGX 100408SR-F:8215	● 0.8	■ 270	■ 0.09	■ 2.0	■ 160	■ 0.08	■ 2.0	■ 255	■ 0.09	■ 2.0	-	-	-	-	-	-	-	-
TNGX 100408SR-F:M6330	● 0.8	■ 225	■ 0.09	■ 2.0	■ 160	■ 0.08	■ 2.0	-	-	-	-	-	-	-	-	-	-	-
TNGX 100408SR-F:M8330	● 0.8	■ 260	■ 0.09	■ 2.0	■ 155	■ 0.08	■ 2.0	■ 245	■ 0.09	■ 2.0	-	-	-	-	-	-	-	-
TNGX 100408SR-F:M8340	● 0.8	■ 240	■ 0.09	■ 2.0	■ 140	■ 0.08	■ 2.0	■ 225	■ 0.09	■ 2.0	-	-	-	-	-	-	-	-
TNGX 100408SR-F:M9340	● 0.8	■ 320	■ 0.09	■ 2.0	■ 190	■ 0.08	■ 2.0	-	-	-	-	-	-	-	-	-	-	-

Eignung und Startwerte für Schnittgeschwindigkeit (vc), Vorschub (f) und Schnitttiefe (ap). Weitere Informationen finden Sie in unserer Zerspanungsrechner-App.

Produkt	RE (mm)	P			M			K			N			S			H		
		vc (m/min)	f (mm/tooth)	ap (mm)	vc (m/min)	f (mm/tooth)	ap (mm)	vc (m/min)	f (mm/tooth)	ap (mm)	vc (m/min)	f (mm/tooth)	ap (mm)	vc (m/min)	f (mm/tooth)	ap (mm)	vc (m/min)	f (mm/tooth)	ap (mm)

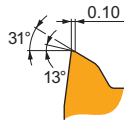

M geometrie mit positiven Design zur leichten bis mittleren Bearbeitung.

TNGX 100404SR-M:8215	● 0.4	■ 205	0.13	2.0	■ 120	0.12	2.0	■ 190	0.13	2.0	–	–	–	■ 50	0.09	1.6	–	–	–
TNGX 100404SR-M:M6330	● 0.4	■ 175	0.13	2.0	■ 125	0.12	2.0	–	–	–	–	–	–	■ 50	0.09	1.6	–	–	–
TNGX 100404SR-M:M8330	● 0.4	■ 205	0.13	2.0	■ 120	0.12	2.0	■ 190	0.13	2.0	–	–	–	■ 50	0.09	1.6	–	–	–
TNGX 100404SR-M:M8340	● 0.4	■ 185	0.13	2.0	■ 110	0.12	2.0	■ 175	0.13	2.0	–	–	–	■ 45	0.09	1.6	–	–	–
TNGX 100404SR-M:M9340	● 0.4	■ 240	0.13	2.0	■ 140	0.12	2.0	–	–	–	–	–	–	■ 60	0.09	1.6	–	–	–
TNGX 100408SR-M:8215	● 0.8	■ 245	0.13	2.0	■ 145	0.12	2.0	■ 230	0.13	2.0	–	–	–	■ 60	0.09	1.6	–	–	–
TNGX 100408SR-M:M6330	● 0.8	■ 210	0.13	2.0	■ 150	0.12	2.0	–	–	–	–	–	–	■ 60	0.09	1.6	–	–	–
TNGX 100408SR-M:M8310	● 0.8	■ 270	0.13	2.0	■ 135	0.12	2.0	■ 255	0.13	2.0	–	–	–	–	–	–	–	–	–
TNGX 100408SR-M:M8330	● 0.8	■ 245	0.13	2.0	■ 145	0.12	2.0	■ 230	0.13	2.0	–	–	–	■ 60	0.09	1.6	–	–	–
TNGX 100408SR-M:M8340	● 0.8	■ 220	0.13	2.0	■ 130	0.12	2.0	■ 205	0.13	2.0	–	–	–	■ 55	0.09	1.6	–	–	–
TNGX 100408SR-M:M8345	● 0.8	■ 180	0.13	2.0	■ 105	0.12	2.0	–	–	–	–	–	–	■ 45	0.09	1.6	–	–	–
TNGX 100408SR-M:M9340	● 0.8	■ 285	0.13	2.0	■ 170	0.12	2.0	–	–	–	–	–	–	■ 70	0.09	1.6	–	–	–
TNGX 100412SR-M:M8330	● 1.2	■ 255	0.13	2.0	■ 150	0.12	2.0	■ 240	0.13	2.0	–	–	–	■ 60	0.09	1.6	–	–	–
TNGX 100412SR-M:M8340	● 1.2	■ 230	0.13	2.0	■ 135	0.12	2.0	■ 215	0.13	2.0	–	–	–	■ 55	0.09	1.6	–	–	–
TNGX 100416SR-M:M8310	● 1.6	■ 300	0.13	2.0	■ 150	0.12	2.0	■ 285	0.13	2.0	–	–	–	–	–	–	–	–	–
TNGX 100416SR-M:M8330	● 1.6	■ 270	0.13	2.0	■ 160	0.12	2.0	■ 255	0.13	2.0	–	–	–	■ 65	0.09	1.6	–	–	–
TNGX 100416SR-M:M8340	● 1.6	■ 245	0.13	2.0	■ 145	0.12	2.0	■ 230	0.13	2.0	–	–	–	■ 60	0.09	1.6	–	–	–

TNGX 10-FA



	IC (mm)	D1 (mm)	L (mm)	S (mm)
1004	6.000	2.80	10.39	4.69

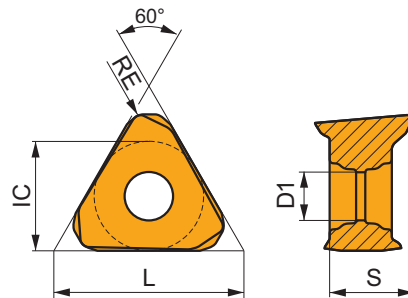

Eignung und Startwerte für Schnittgeschwindigkeit (vc), Vorschub (f) und Schnitttiefe (ap). Weitere Informationen finden Sie in unserer Zerspanungsrechner-App.

Produkt	RE (mm)	P			M			K			N			S			H		
		vc (m/min)	f (mm/tooth)	ap (mm)	vc (m/min)	f (mm/tooth)	ap (mm)	vc (m/min)	f (mm/tooth)	ap (mm)	vc (m/min)	f (mm/tooth)	ap (mm)	vc (m/min)	f (mm/tooth)	ap (mm)	vc (m/min)	f (mm/tooth)	ap (mm)

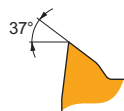
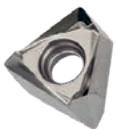

FA geometrie mit hoch positiven Design zur feinen Schlichtbearbeitung bis zur mittleren Bearbeitung.

TNGX 100404FR-FA:HF7	● 0.4	–	–	–	–	–	–	–	–	–	■ 345	0.10	1.5	–	–	–	–	–	–
TNGX 100404FR-FA:M0315	● 0.4	–	–	–	–	–	–	–	–	–	■ 780	0.10	1.5	–	–	–	–	–	–
TNGX 100408FR-FA:HF7	● 0.8	–	–	–	–	–	–	–	–	–	■ 345	0.10	1.5	–	–	–	–	–	–
TNGX 100408FR-FA:M0315	● 0.8	–	–	–	–	–	–	–	–	–	■ 780	0.10	1.5	–	–	–	–	–	–



a_e / DC	5%	10%	15%	20%	25%	30%	40%	50%	60%	70%	75%	80%	90%	100%
	1.48	1.35	1.27	1.22	1.19	1.16	1.11	1.08	1.05	1.03	1.00	1.00	1.00	1.00
	2.20	1.60	1.35	1.20	1.10	0.95	0.85	0.75	0.85	0.95	1.00	1.00	1.00	1.00
	0.64	0.64	0.64	0.64	0.64	0.65	0.65	0.67	0.68	0.71	0.72	0.74	0.79	1.00

	TNGX 10-F			TNGX 10-M				TNGX 10-FA	
	0.2	0.4	0.8	0.4	0.8	1.2	1.6	0.4	0.8
	1.53	1.34	0.92	1.34	0.92			1.33	0.93

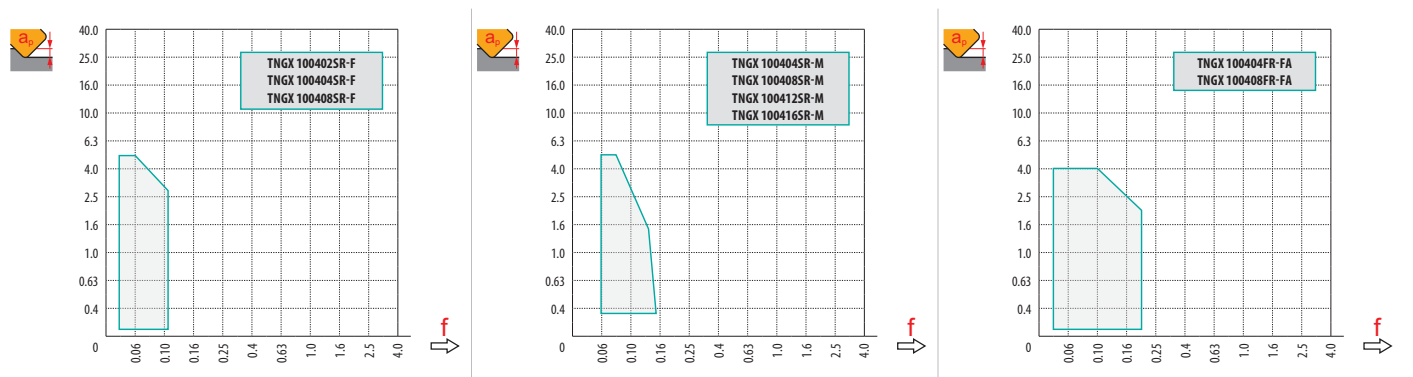

1.5	1.0 3.0 5.0	0.2
	0.10 0.08 0.04	

	RPMX	APMX/l		DMIN	DMAX		
18	1.80°	3.05/100	18	33	36	1.2	1.2
20	1.60°	2.70/100	20	37	40	1.2	1.2
22	1.20°	2.00/100	22	41	44	1.0	1.0
25	1.00°	1.70/100	25	47	50	1.0	1.0
30	0.90°	1.45/100	30	57	60	1.0	1.0
32	0.80°	1.30/100	32	61	64	1.0	1.0
35	0.65°	1.00/100	35	67	70	0.9	0.9
40	0.60°	0.90/100	40	77	80	0.9	0.9
50	0.50°	0.70/100	50	97	100	0.9	0.9
63	0.40°	0.50/100	63	123	126	0.9	0.9
80	0.25°	0.30/100	80	157	160	0.9	0.9

STN16

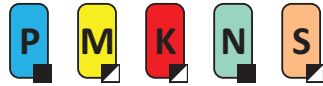

PRAMET



ECON TN16 Eckfräser mit Innenkühlung

90° Schafffräser und Messerköpfe mit doppelseitigen TNGX 16 Wendeschneidplatten mit 6 Schneidkanten und APMX von 10 mm. Geeignet für eine Vielzahl an Anwendungen. Erhältlich mit zylindrischem, Weldon-, modularem Schaft und als Aufsteckfräser (mit ungleicher Teilung). Für längere Standzeiten ist der Körper oberflächenbehandelt.

ECON TN

KAPR	90°
APMX	10.0 mm

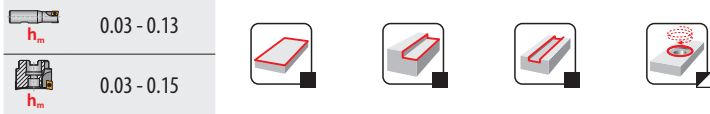
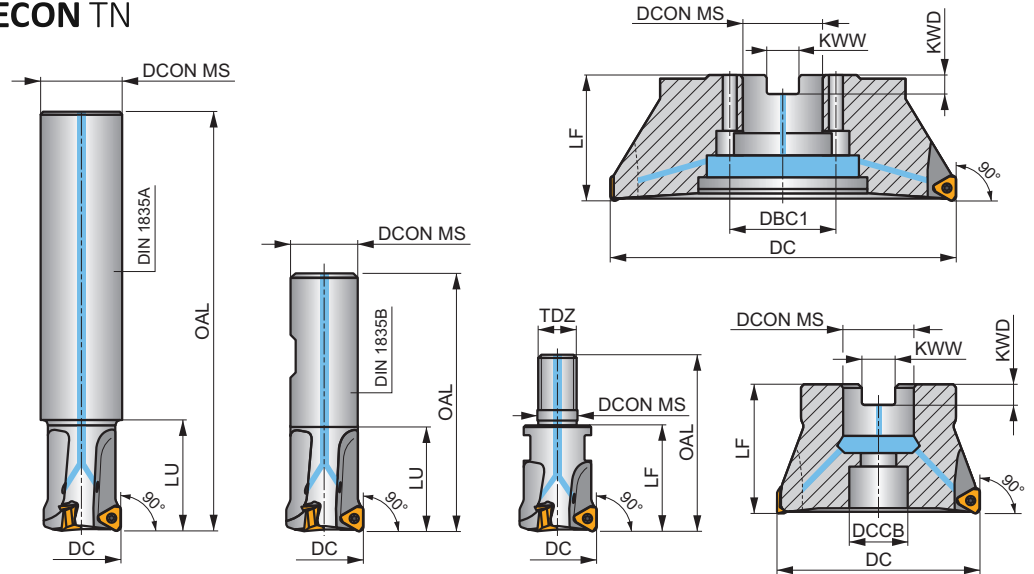
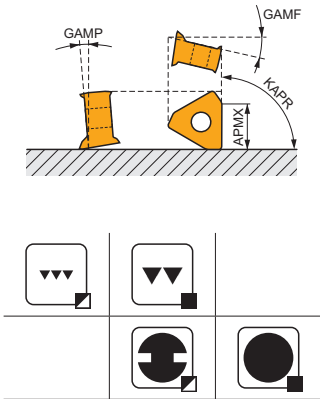

Produkt	DC (mm)	OAL (mm)	DCON MS (mm)	DCCB (mm)	DBC1 (mm)	LU (mm)	LF (mm)	TDZ (mm)	KWW (mm)	KWD (mm)	GAMP (°)	GAMP (°)	max.	kg	C382	C384	C386	C388	C390			
																				20000	17500	20000
25A2R034A25-STN16-C	25	170	25	-	-	34	-	-	-	-	-18.5	-9.5	2	-	0.54	GI340	C0382					
32A2R034A32-STN16-C	32	195	32	-	-	34	-	-	-	-	-16	-9.5	2	-	1.05	GI340	C0382					
25A2R080A25-STN16-C	25	170	25	-	-	80	-	-	-	-	-18.5	-9.5	2	-	0.48	GI340	C0382					
32A2R080A32-STN16-C	32	195	32	-	-	80	-	-	-	-	-16	-9.5	2	-	0.96	GI340	C0382					
32A3R034A32-STN16-C	32	195	32	-	-	34	-	-	-	-	-16	-9.5	3	-	1.04	GI340	C0382					
35A3R034A32-STN16-C	35	195	32	-	-	34	-	-	-	-	-16	-9.5	3	-	1.07	GI340	C0382					
25A2R042B25-STN16-C	25	110	25	-	-	42	-	-	-	-	-18.5	-9.5	2	-	0.29	GI340	C0382					
32A3R042B32-STN16-C	32	110	32	-	-	42	-	-	-	-	-16	-9.5	3	-	0.52	GI340	C0382					
40A4R050B32-STN16-C	40	120	32	-	-	50	-	-	-	-	-16	-9.5	4	-	0.68	GI340	C0382					
25A2R033M12-STN16-C	25	55	12.5	-	-	-	33	M12	-	-	-18.5	-9.5	2	-	0.10	GI340	C0382					
32A2R043M16-STN16-C	32	66	17	-	-	-	43	M16	-	-	-16	-9.5	2	-	0.18	GI340	C0382					
32A3R043M16-STN16-C	32	66	17	-	-	-	43	M16	-	-	-16	-9.5	3	-	0.17	GI340	C0382					
40A3R043M16-STN16-C	40	66	17	-	-	-	43	M16	-	-	-16	-9.5	3	-	0.20	GI340	C0382					
40A4R043M16-STN16-C	40	66	17	-	-	-	43	M16	-	-	-16	-9.5	4	-	0.21	GI340	C0382					
40A03R-S90TN16-C	40	40	16	12.4	-	-	40	-	8.4	5.6	-16	-9.5	3	-	0.32	GI340	C0384					
40A04R-S90TN16-C	40	40	16	12.4	-	-	40	-	8.4	5.6	-16	-9.5	4	-	0.31	GI340	C0384					
50A04R-S90TN16-C	50	40	22	18.1	-	-	40	-	10.4	6.3	-16	-9.5	4	✓	0.34	GI340	C0386					
50A05R-S90TN16-C	50	40	22	18.1	-	-	40	-	10.4	6.3	-16	-9.5	5	✓	0.32	GI340	C0386					
63A04R-S90TN16-C	63	40	22	18.1	-	-	40	-	10.4	6.3	-16	-9.5	4	✓	0.47	GI340	C0386					
63A06R-S90TN16-C	63	40	22	18.1	-	-	40	-	10.4	6.3	-16	-9.5	6	✓	0.48	GI340	C0386					
80A05R-S90TN16-C	80	50	27	22.1	-	-	50	-	12.4	7	-16	-9.5	5	✓	1.15	GI340	C0388					
80A07R-S90TN16-C	80	50	27	22.1	-	-	50	-	12.4	7	-16	-9.5	7	✓	1.17	GI340	C0388					
100A06R-S90TN16-C	100	50	32	45.1	-	-	50	-	14.4	8	-16	-9.5	6	✓	1.79	GI340	C0390					
100A08R-S90TN16-C	100	50	32	45.1	-	-	50	-	14.4	8	-16	-9.5	8	✓	1.66	GI340	C0390					
115A06R-S90TN16-C	115	50	32	45.1	-	-	50	-	14.4	8	-16	-9.5	6	✓	2.21	GI340	C0390					
125A07R-S90TN16-C	125	63	40	56.1	-	-	63	-	16.4	9	-16	-9.5	7	✓	3.05	GI340	C0390					
125A09R-S90TN16-C	125	63	40	56.1	-	-	63	-	16.4	9	-16	-9.5	9	✓	3.14	GI340	C0390					

Produkt	DC	OAL	D CON MS	DCB	DBC1	LU	LF	TDZ	KWW	KWD	GAMF	GAMP	max.			kg		
	(mm)	(mm)	(mm)	(mm)	(mm)	(mm)	(mm)	(mm)	(mm)	(mm)	(°)	(°)						
140A08R-S90TN16-C	140	63	40	56.1	-	-	63	-	16.4	9	-16	-9.5	8	✓	8500	✓	3.69	GI340 C0390
160C10R-S90TN16-C	160	63	40	-	66.7	-	63	-	16.4	9.2	-16	-9.5	10	✓	8000	✓	5.16	GI340 C0394
175C10R-S90TN16-C	175	63	40	-	66.7	-	63	-	16.4	9.2	-16	-9.5	10	✓	7500	✓	6.89	GI340 C0394

	GI340		TNGX 1606..
--	-------	--	-------------

C0382	US 44010-T15P	3.5	M 4	10	-	-	Flag T15P	-	-	-	-
C0384	US 44010-T15P	3.5	M 4	10	D-T08P/T15P	FG-15	-	HS 90835	-	-	-
C0386	US 44010-T15P	3.5	M 4	10	D-T08P/T15P	FG-15	-	HS 1030C	-	-	-
C0388	US 44010-T15P	3.5	M 4	10	D-T08P/T15P	FG-15	-	HS 1230C	-	-	-
C0390	US 44010-T15P	3.5	M 4	10	D-T08P/T15P	FG-15	-	-	-	-	-
C0394	US 44010-T15P	3.5	M 4	10	D-T08P/T15P	FG-15	-	HS 1240C	HSD 0825C	CAC 160C	-

TNGX 16



	IC	D1	L	S
	(mm)	(mm)	(mm)	(mm)
1606	9.525	4.40	16.50	6.58

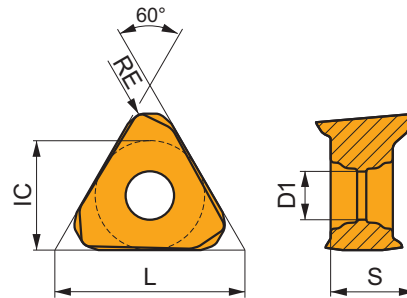

Eignung und Startwerte für Schnittgeschwindigkeit (vc), Vorschub (f) und Schnitttiefe (ap). Weitere Informationen finden Sie in unserer Zerspanungsrechner-App.

Produkt	RE (mm)	P			M			K			N			S			H		
		vc	f	ap	vc	f	ap	vc	f	ap	vc	f	ap	vc	f	ap	vc	f	ap
		(m/min)	(mm/tooth)	(mm)	(m/min)	(mm/tooth)	(mm)	(m/min)	(mm/tooth)	(mm)	(m/min)	(mm/tooth)	(mm)	(m/min)	(mm/tooth)	(mm)	(m/min)	(mm/tooth)	(mm)

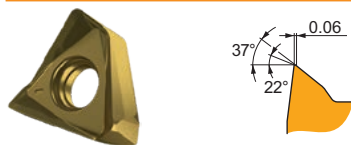

F Geometrie mit hoch positiven Design zum Schlichten.

TNGX 160604SR-F:M8330	● 0.4	■ 205	■ 0.10	■ 3.0	■ 120	■ 0.09	■ 3.0	■ 190	■ 0.10	■ 3.0	■ -	■ -	■ -	■ -	■ -	■ -	■ -	■ -	■ -	■ -
TNGX 160604SR-F:M8340	● 0.4	■ 190	■ 0.10	■ 3.0	■ 110	■ 0.09	■ 3.0	■ 180	■ 0.10	■ 3.0	■ -	■ -	■ -	■ -	■ -	■ -	■ -	■ -	■ -	■ -
TNGX 160608SR-F:8215	● 0.8	■ 250	■ 0.10	■ 3.0	■ 150	■ 0.09	■ 3.0	■ 235	■ 0.10	■ 3.0	■ -	■ -	■ -	■ -	■ -	■ -	■ -	■ -	■ -	■ -
TNGX 160608SR-F:M6330	● 0.8	■ 215	■ 0.10	■ 3.0	■ 150	■ 0.09	■ 3.0	■ -	■ -	■ -	■ -	■ -	■ -	■ -	■ -	■ -	■ -	■ -	■ -	■ -
TNGX 160608SR-F:M8310	● 0.8	■ 280	■ 0.10	■ 3.0	■ 140	■ 0.09	■ 3.0	■ 265	■ 0.10	■ 3.0	■ -	■ -	■ -	■ -	■ -	■ -	■ -	■ -	■ -	■ -
TNGX 160608SR-F:M8330	● 0.8	■ 245	■ 0.10	■ 3.0	■ 145	■ 0.09	■ 3.0	■ 230	■ 0.10	■ 3.0	■ -	■ -	■ -	■ -	■ -	■ -	■ -	■ -	■ -	■ -
TNGX 160608SR-F:M8340	● 0.8	■ 225	■ 0.10	■ 3.0	■ 135	■ 0.09	■ 3.0	■ 210	■ 0.10	■ 3.0	■ -	■ -	■ -	■ -	■ -	■ -	■ -	■ -	■ -	■ -

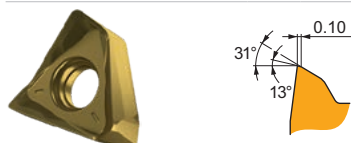

M Geometrie mit positiven Design zur leichten bis mittleren Bearbeitung.

TNGX 160604SR-M:8215	● 0.4	■ 180	■ 0.18	■ 3.0	■ 105	■ 0.16	■ 3.0	■ 170	■ 0.18	■ 3.0	■ -	■ -	■ -	■ 45	■ 0.13	■ 2.4	■ -	■ -	■ -	■ -
TNGX 160604SR-M:M6330	● 0.4	■ 155	■ 0.18	■ 3.0	■ 110	■ 0.16	■ 3.0	■ -	■ -	■ -	■ -	■ -	■ -	■ 45	■ 0.13	■ 2.4	■ -	■ -	■ -	■ -
TNGX 160604SR-M:M8310	● 0.4	■ 205	■ 0.15	■ 3.0	■ 100	■ 0.14	■ 3.0	■ 190	■ 0.15	■ 3.0	■ -	■ -	■ -	■ -	■ -	■ -	■ -	■ -	■ -	■ -
TNGX 160604SR-M:M8330	● 0.4	■ 180	■ 0.18	■ 3.0	■ 105	■ 0.16	■ 3.0	■ 170	■ 0.18	■ 3.0	■ -	■ -	■ -	■ 45	■ 0.13	■ 2.4	■ -	■ -	■ -	■ -

Eignung und Startwerte für Schnittgeschwindigkeit (vc), Vorschub (f) und Schnitttiefe (ap). Weitere Informationen finden Sie in unserer Zerspanungsrechner-App.

Produkt	RE (mm)	P			M			K			N			S			H		
		vc (m/min)	f (mm/tooth)	ap (mm)	vc (m/min)	f (mm/tooth)	ap (mm)	vc (m/min)	f (mm/tooth)	ap (mm)	vc (m/min)	f (mm/tooth)	ap (mm)	vc (m/min)	f (mm/tooth)	ap (mm)	vc (m/min)	f (mm/tooth)	ap (mm)

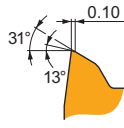
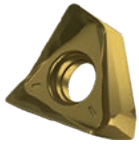

M geometrie mit positiven Design zur leichten bis mittleren Bearbeitung.

TNGX 160604SR-M:M8340	● 0.4	■ 165	■ 0.18	■ 3.0	■ 95	■ 0.16	■ 3.0	■ 155	■ 0.18	■ 3.0	■ —	■ —	■ —	■ 40	■ 0.13	■ 2.4	■ —	■ —	■ —
TNGX 160608SR-M:8215	● 0.8	■ 215	■ 0.18	■ 3.0	■ 125	■ 0.16	■ 3.0	■ 200	■ 0.18	■ 3.0	■ —	■ —	■ —	■ 50	■ 0.13	■ 2.4	■ —	■ —	■ —
TNGX 160608SR-M:M6330	● 0.8	■ 185	■ 0.18	■ 3.0	■ 130	■ 0.16	■ 3.0	■ —	■ —	■ —	■ —	■ —	■ —	■ 55	■ 0.13	■ 2.4	■ —	■ —	■ —
TNGX 160608SR-M:M8310	● 0.8	■ 245	■ 0.15	■ 3.0	■ 120	■ 0.14	■ 3.0	■ 230	■ 0.15	■ 3.0	■ —	■ —	■ —	■ —	■ —	■ —	■ —	■ —	■ —
TNGX 160608SR-M:M8330	● 0.8	■ 215	■ 0.18	■ 3.0	■ 125	■ 0.16	■ 3.0	■ 200	■ 0.18	■ 3.0	■ —	■ —	■ —	■ 50	■ 0.13	■ 2.4	■ —	■ —	■ —
TNGX 160608SR-M:M8340	● 0.8	■ 195	■ 0.18	■ 3.0	■ 115	■ 0.16	■ 3.0	■ 185	■ 0.18	■ 3.0	■ —	■ —	■ —	■ 45	■ 0.13	■ 2.4	■ —	■ —	■ —
TNGX 160608SR-M:M8345	● 0.8	■ 155	■ 0.18	■ 3.0	■ 90	■ 0.16	■ 3.0	■ —	■ —	■ —	■ —	■ —	■ —	■ 35	■ 0.13	■ 2.4	■ —	■ —	■ —
TNGX 160608SR-M:M9325	● 0.8	■ 285	■ 0.15	■ 3.0	■ —	■ —	■ —	■ 270	■ 0.15	■ 3.0	■ —	■ —	■ —	■ —	■ —	■ —	■ —	■ —	■ —
TNGX 160608SR-M:M9340	● 0.8	■ 245	■ 0.18	■ 3.0	■ 145	■ 0.16	■ 3.0	■ —	■ —	■ —	■ —	■ —	■ 60	■ 0.13	■ 2.4	■ —	■ —	■ —	
TNGX 160612SR-M:M8330	● 1.2	■ 230	■ 0.18	■ 3.0	■ 135	■ 0.16	■ 3.0	■ 215	■ 0.18	■ 3.0	■ —	■ —	■ —	■ 55	■ 0.13	■ 2.4	■ —	■ —	■ —
TNGX 160612SR-M:M8340	● 1.2	■ 205	■ 0.18	■ 3.0	■ 120	■ 0.16	■ 3.0	■ 190	■ 0.18	■ 3.0	■ —	■ —	■ —	■ 50	■ 0.13	■ 2.4	■ —	■ —	■ —
TNGX 160616SR-M:M8310	● 1.6	■ 275	■ 0.15	■ 3.0	■ 140	■ 0.14	■ 3.0	■ 260	■ 0.15	■ 3.0	■ —	■ —	■ —	■ —	■ —	■ —	■ —	■ —	■ —
TNGX 160616SR-M:M8330	● 1.6	■ 240	■ 0.18	■ 3.0	■ 140	■ 0.16	■ 3.0	■ 225	■ 0.18	■ 3.0	■ —	■ —	■ —	■ 60	■ 0.13	■ 2.4	■ —	■ —	■ —
TNGX 160616SR-M:M8340	● 1.6	■ 220	■ 0.18	■ 3.0	■ 130	■ 0.16	■ 3.0	■ 205	■ 0.18	■ 3.0	■ —	■ —	■ —	■ 55	■ 0.13	■ 2.4	■ —	■ —	■ —

TNGX 16-FA



	IC (mm)	D1 (mm)	L (mm)	S (mm)
1606	9.525	4.40	16.50	6.58

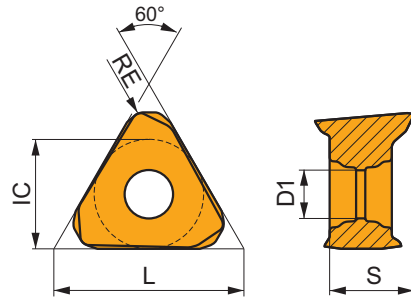

Eignung und Startwerte für Schnittgeschwindigkeit (vc), Vorschub (f) und Schnitttiefe (ap). Weitere Informationen finden Sie in unserer Zerspanungsrechner-App.

Produkt	RE (mm)	P			M			K			N			S			H		
		vc (m/min)	f (mm/tooth)	ap (mm)	vc (m/min)	f (mm/tooth)	ap (mm)	vc (m/min)	f (mm/tooth)	ap (mm)	vc (m/min)	f (mm/tooth)	ap (mm)	vc (m/min)	f (mm/tooth)	ap (mm)	vc (m/min)	f (mm/tooth)	ap (mm)

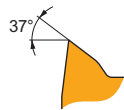
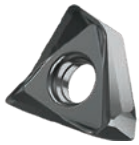

FA geometrie mit hoch positiven Design zur feinen Schlichtbearbeitung bis zur mittleren Bearbeitung.

TNGX 160604FR-FA:HF7	● 0.4	■ —	■ —	■ —	■ —	■ —	■ —	■ —	■ —	■ —	■ 255	■ 0.14	■ 2.0	■ —	■ —	■ —	■ —	■ —	■ —
TNGX 160604FR-FA:M0315	● 0.4	■ —	■ —	■ —	■ —	■ —	■ —	■ —	■ —	■ —	■ 585	■ 0.14	■ 2.0	■ —	■ —	■ —	■ —	■ —	■ —
TNGX 160608FR-FA:HF7	● 0.8	■ —	■ —	■ —	■ —	■ —	■ —	■ —	■ —	■ —	■ 300	■ 0.14	■ 2.0	■ —	■ —	■ —	■ —	■ —	■ —
TNGX 160608FR-FA:M0315	● 0.8	■ —	■ —	■ —	■ —	■ —	■ —	■ —	■ —	■ —	■ 690	■ 0.14	■ 2.0	■ —	■ —	■ —	■ —	■ —	■ —



a_e / DC	5 %	10 %	15 %	20 %	25 %	30 %	40 %	50 %	60 %	70 %	75 %	80 %	90 %	100 %
	1.48	1.35	1.27	1.22	1.19	1.16	1.11	1.08	1.05	1.03	1.00	1.00	1.00	1.00
	2.20	1.60	1.35	1.20	1.10	0.95	0.85	0.75	0.85	0.95	1.00	1.00	1.00	1.00
	0.64	0.64	0.64	0.64	0.64	0.65	0.65	0.67	0.68	0.71	0.72	0.74	0.79	1.00

	TNGX 16-F		TNGX 16-M				TNGX 16-FA	
	0.4	0.8	0.4	0.8	1.2	1.6	0.4	0.8
	2.10	1.9	2.10	1.90	1.73	1.14	2.10	1.90

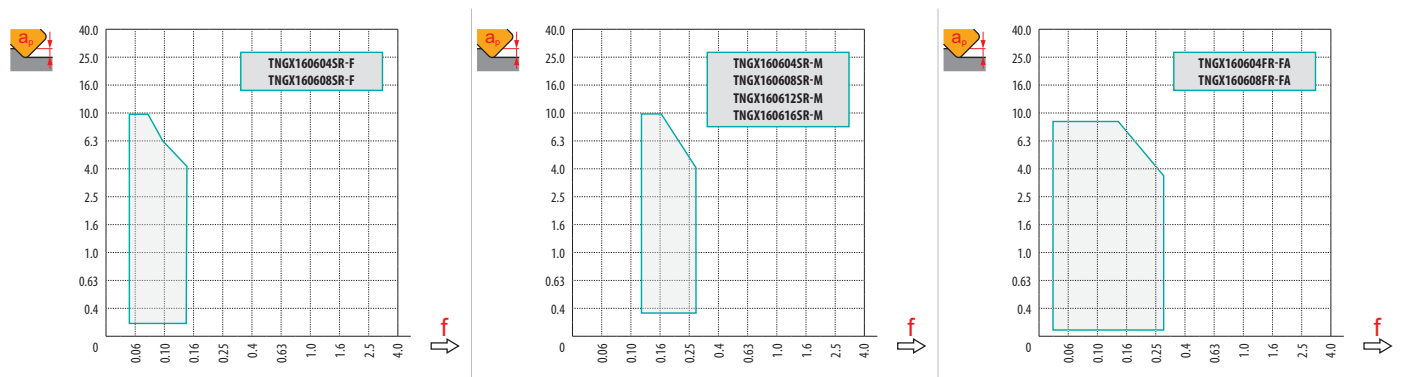

a	3.0	4.5	6.0
	0.18	0.14	0.10



DC	min	$d_{min} = DC^*$		min	$d = 1.25 DC$		min	$d = 1.5 DC$		min	$d = 1.75 DC$		min	$d \geq 2 DC$	
		SMAX	$a_{e max}$		SMAX	$a_{e max}$		SMAX	$a_{e max}$		SMAX	$a_{e max}$		SMAX	$a_{e max}$
25	25	0.14	1.3	31	0.22	2.2	38	0.33	3.0	44	0.60	4.0	50	0.70	5.0
32	32	0.16	1.5	40	0.33	2.8	48	0.44	4.0	56	0.70	5.0	64	0.90	6.5
40	40	0.22	2.0	50	0.38	3.5	60	0.55	5.0	70	0.90	6.5	80	1.15	8.0
50	50	0.27	2.5	63	0.50	4.5	75	0.70	6.5	88	1.00	8.0	100	1.40	10.0
63	63	0.33	3.2	80	0.60	5.5	95	0.90	8.0	110	1.45	10.0	125	1.80	12.5
80	80	0.55	4.0	100	1.00	7.0	120	1.45	10.0	140	2.15	13.0	160	2.60	16.0
100	100	0.70	5.0	125	1.20	9.0	150	1.80	12.5	175	2.70	16.5	200	3.30	20.0
115	115	0.85	6.0	145	1.50	10.0	175	1.90	14.5	200	2.80	19.0	230	3.80	23.0
125	125	0.90	6.5	155	1.60	11.0	190	2.30	15.5	220	3.10	20.0	250	4.10	25.0
140	140	1.00	7.0	175	1.80	12.5	210	2.60	17.5	245	3.70	23.0	280	4.60	28.0
160	160	1.20	8.0	200	2.00	14.0	240	2.90	20.0	280	4.30	26.0	320	5.30	32.0
175	175	1.30	8.8	220	2.20	15.5	265	3.20	22.0	305	4.70	29.0	350	5.80	35.0

* Überprüfen Sie die Reduzierung der Vorschubgeschwindigkeit, wenn der Bohrungsdurchmesser zwischen $d_{min} - 1.5 DC$ liegt.

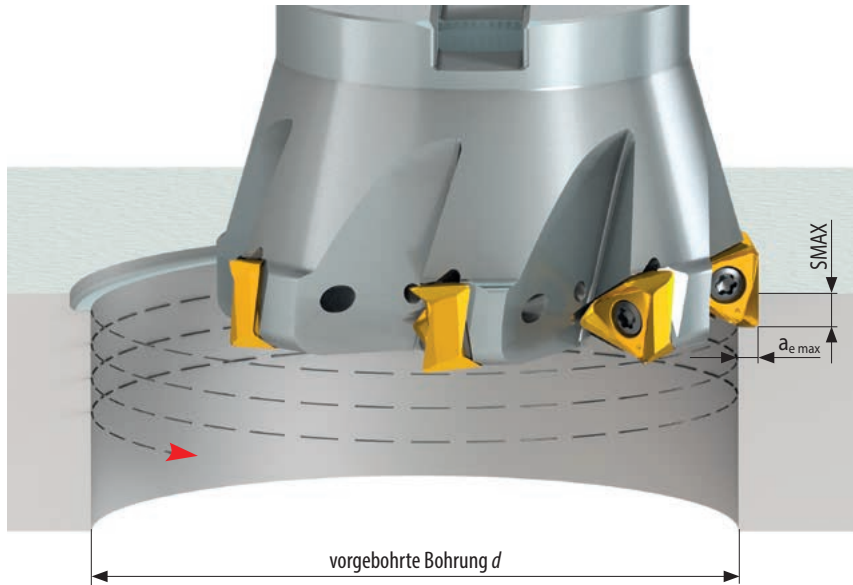

SLN12



PRAMET



ECON LN12 Eckfräser mit Innenkühlung

90° Schafffräser und Messerköpfe mit doppelseitigen LN.. 12 Wendeschneidplatten mit APMX von 9 mm. Geeignet für eine Vielzahl an Anwendungen. Erhältlich mit zylindrischem, Weldon-, modularem Schaft und als Aufsteckfräser (mit ungleicher Teilung). Für längere Standzeiten ist der Körper oberflächenbehandelt.

ECON LN

KAPR	90°
APMX	9.0 mm

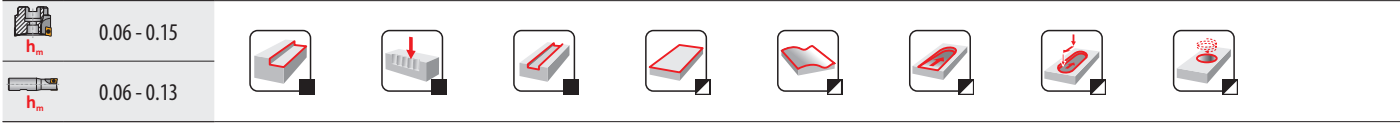
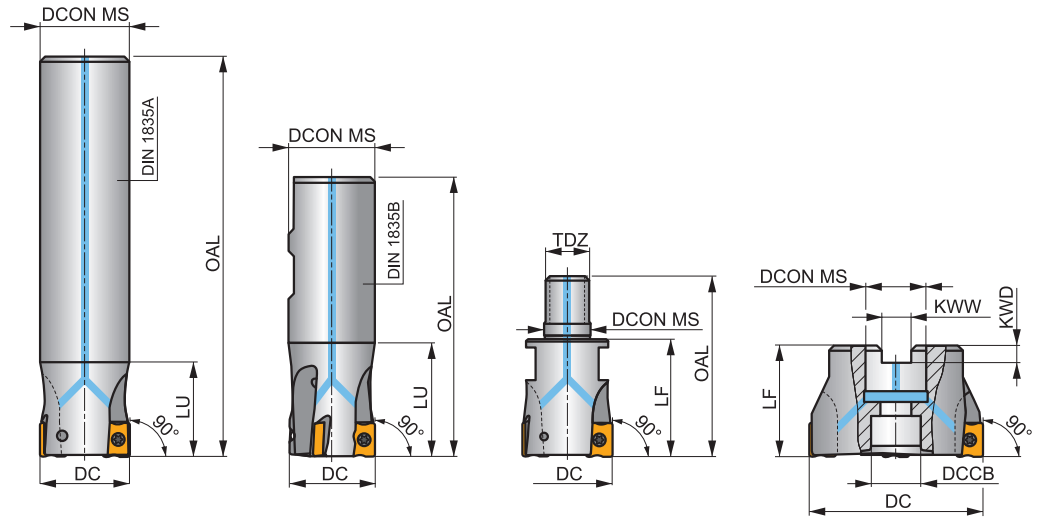
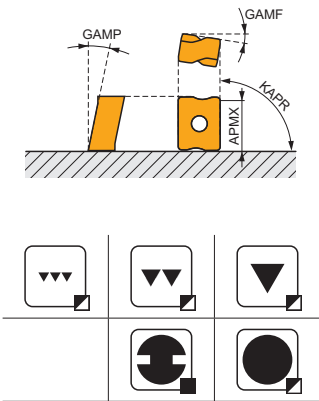

Produkt	DC (mm)	OAL (mm)	DCON MS (mm)	DCCB (mm)	LU (mm)	LF (mm)	TDZ (mm)	KWW (mm)	KWD (mm)	GAMF (°)	GAMP (°)	max.	kg	G1205	SQ340	AC001-003	
																	19500
25A2R034A25-SLN12-C	25	170	25	-	34	-	-	-	-	-23	-8	2	-	19500	✓	0.58	G1205 SQ340 -
25A2R080A25-SLN12-C	25	170	25	-	80	-	-	-	-	-23	-8	2	-	19500	✓	0.54	G1205 SQ340 -
32A2R034A32-SLN12-C	32	195	32	-	34	-	-	-	-	-15	-6	2	-	17300	✓	1.05	G1205 SQ340 -
32A2R090A32-SLN12-C	32	195	32	-	90	-	-	-	-	-15	-6	2	-	17300	✓	0.98	G1205 SQ340 -
25A2R042B25-SLN12-C	25	99	25	-	42	-	-	-	-	-23	-8	2	-	19500	✓	0.30	G1205 SQ340 -
32A3R042B32-SLN12-C	32	103	32	-	42	-	-	-	-	-15	-6	3	-	17300	✓	0.50	G1205 SQ340 -
40A4R050B32-SLN12-C	40	111	32	-	50	-	-	-	-	-15	-6	4	✓	15500	✓	0.62	G1205 SQ340 -
25A2R033M12-SLN12-C	25	55	12.5	-	-	33	-	-	-	-22	-6	2	-	✓	0.11	G1205 SQ340 -	
32A2R043M16-SLN12-C	32	66	17	-	-	43	-	-	-	-15	-6	2	-	✓	0.22	G1205 SQ340 -	
32A3R043M16-SLN12-C	32	66	17	-	-	43	-	-	-	-15	-6	3	-	✓	0.22	G1205 SQ340 -	
40A3R043M16-SLN12-C	40	66	17	-	-	43	-	-	-	-15	-6	3	-	✓	0.28	G1205 SQ340 -	
40A04R-S90LN12-C	40	-	16	14	-	40	-	8.4	5.6	-15	-6	4	✓	15500	✓	0.33	G1205 SQ342 -
50A04R-S90LN12-C	50	-	22	18	-	40	-	10.4	6.3	-14.5	-6	4	✓	13800	✓	0.47	G1205 SQ343 -
50A05R-S90LN12-C	50	-	22	18	-	40	-	10.4	6.3	-14.5	-6	5	✓	13800	✓	0.40	G1205 SQ343 -
63A04R-S90LN12-C	63	-	22	18	-	40	-	10.4	6.3	-14	-6	4	✓	12300	✓	0.55	G1205 SQ343 -
63A06R-S90LN12-C	63	-	22	18	-	40	-	10.4	6.3	-14	-6	6	✓	12300	✓	0.50	G1205 SQ343 -
80A05R-S90LN12-C	80	-	27	38	-	50	-	12.4	7	-14	-6	5	✓	10900	✓	1.16	G1205 SQ341 AC001
80A07R-S90LN12-C	80	-	27	38	-	50	-	12.4	7	-14	-6	7	✓	10900	✓	1.11	G1205 SQ341 AC001
100A06R-S90LN12-C	100	-	32	45	-	50	-	14.4	8	-14	-6	6	✓	9800	✓	1.78	G1205 SQ341 AC002
100A08R-S90LN12-C	100	-	32	45	-	50	-	14.4	8	-14	-6	8	✓	9800	✓	1.93	G1205 SQ341 AC002
110A06R-S90LN12-C	110	-	32	45	-	50	-	14.4	8	-14	-6	6	✓	9300	✓	2.09	G1205 SQ341 AC002
125A07R-S90LN12-C	125	-	40	56	-	63	-	16.4	9	-14	-6	7	✓	8700	✓	3.40	G1205 SQ341 AC003
125A09R-S90LN12-C	125	-	40	56	-	63	-	16.4	9	-14	-6	9	✓	8700	✓	3.35	G1205 SQ341 AC003



SQ340	US 44012-T15P	3.5	M 4	12	–	–	–	Flag T15P	–
SQ341	US 44012-T15P	3.5	M 4	12	D-T08P/T15P	FG-15	–	–	–
SQ342	US 44012-T15P	3.5	M 4	12	D-T08P/T15P	FG-15	–	–	HS 0830C
SQ343	US 44012-T15P	3.5	M 4	12	D-T08P/T15P	FG-15	–	–	HS 1030C

AC001		KS 1230	K.FMH27
AC002		KS 1635	K.FMH32
AC003		KS 2040	K.FMH40

LNGX 12



	W1	D1	L	S
	(mm)	(mm)	(mm)	(mm)
1205	9.500	4.50	12.00	5.96

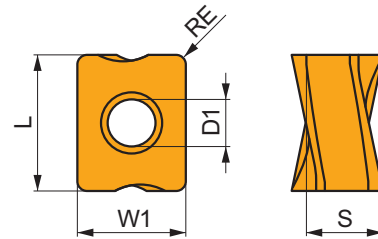

Eignung und Startwerte für Schnittgeschwindigkeit (vc), Vorschub (f) und Schnitttiefe (ap). Weitere Informationen finden Sie in unserer Zerspanungsrechner-App.

Produkt	RE (mm)	P			M			K			N			S			H					
		vc	f	ap	vc	f	ap	vc	f	ap	vc	f	ap	vc	f	ap	vc	f	ap			
		(m/min)	(mm/tooth)	(mm)	(m/min)	(mm/tooth)	(mm)	(m/min)	(mm/tooth)	(mm)	(m/min)	(mm/tooth)	(mm)	(m/min)	(mm/tooth)	(mm)	(m/min)	(mm/tooth)	(mm)	(m/min)	(mm/tooth)	(mm)

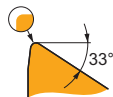

F Geometrie mit hoch positiven Design zum Schlichten.

LNGX 120504ER-F:8215	● 0.4	200	0.15	1.5	–	–	–	190	0.15	1.5	–	–	–	–	–	–	–	–	–	–	–	–
LNGX 120504ER-F:M8330	● 0.4	200	0.15	1.5	–	–	–	190	0.15	1.5	–	–	–	–	–	–	–	–	–	–	–	–
LNGX 120504ER-F:M8340	● 0.4	180	0.15	1.5	–	–	–	170	0.15	1.5	–	–	–	–	–	–	–	–	–	–	–	–
LNGX 120508ER-F:8215	⊕ 0.8	240	0.15	1.5	–	–	–	225	0.15	1.5	–	–	–	–	–	–	–	–	–	–	–	–
LNGX 120508ER-F:M8310	⊕ 0.8	260	0.15	1.5	–	–	–	245	0.15	1.5	–	–	–	–	–	–	–	–	–	–	–	–
LNGX 120508ER-F:M8330	⊕ 0.8	235	0.15	1.5	–	–	–	220	0.15	1.5	–	–	–	–	–	–	–	–	–	–	–	–
LNGX 120508ER-F:M8340	⊕ 0.8	215	0.15	1.5	–	–	–	200	0.15	1.5	–	–	–	–	–	–	–	–	–	–	–	–

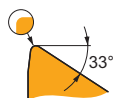

M Geometrie mit positiven Design zur leichten bis mittleren Bearbeitung.

LNGX 120504ER-M:M8330	● 0.4	185	0.15	3.0	–	–	–	175	0.15	3.0	–	–	–	–	–	–	–	–	–	–	–	–
LNGX 120504ER-M:M8340	⊕ 0.4	170	0.15	3.0	–	–	–	160	0.15	3.0	–	–	–	–	–	–	–	–	–	–	–	–
LNGX 120508ER-M:8215	⊕ 0.8	220	0.15	3.0	–	–	–	205	0.15	3.0	–	–	–	–	–	–	–	–	–	–	–	–
LNGX 120508ER-M:M8310	⊕ 0.8	240	0.15	3.0	–	–	–	225	0.15	3.0	–	–	–	–	–	–	–	–	–	–	–	–
LNGX 120508ER-M:M8330	⊕ 0.8	220	0.15	3.0	–	–	–	205	0.15	3.0	–	–	–	–	–	–	–	–	–	–	–	–
LNGX 120508ER-M:M8340	⊕ 0.8	200	0.15	3.0	–	–	–	190	0.15	3.0	–	–	–	–	–	–	–	–	–	–	–	–
LNGX 120508ER-M:M9315	⊕ 0.8	300	0.15	3.0	–	–	–	285	0.15	3.0	–	–	–	–	–	–	–	–	–	–	–	–
LNGX 120508ER-M:M9325	⊕ 0.8	280	0.15	3.0	–	–	–	265	0.15	3.0	–	–	–	–	–	–	–	–	–	–	–	–
LNGX 120508ER-M:M9340	⊕ 0.8	250	0.15	3.0	–	–	–	–	–	–	–	–	–	–	–	–	–	–	–	–	–	–
LNGX 120510ER-M:M8330	⊕ 1.0	230	0.15	3.0	–	–	–	215	0.15	3.0	–	–	–	–	–	–	–	–	–	–	–	–
LNGX 120512ER-M:M8330	⊕ 1.2	230	0.15	3.0	–	–	–	215	0.15	3.0	–	–	–	–	–	–	–	–	–	–	–	–

Eignung und Startwerte für Schnittgeschwindigkeit (vc), Vorschub (f) und Schnitttiefe (ap). Weitere Informationen finden Sie in unserer Zerspanungsrechner-App.

Produkt	RE (mm)	P			M			K			N			S			H		
		vc (m/min)	f (mm/tooth)	ap (mm)	vc (m/min)	f (mm/tooth)	ap (mm)	vc (m/min)	f (mm/tooth)	ap (mm)	vc (m/min)	f (mm/tooth)	ap (mm)	vc (m/min)	f (mm/tooth)	ap (mm)	vc (m/min)	f (mm/tooth)	ap (mm)

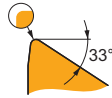

M geometrie mit positiven Design zur leichten bis mittleren Bearbeitung.

LNGX 120512ER-M:M8340	1.2	210	0.15	3.0	-	-	-	195	0.15	3.0	-	-	-	-	-	-	-	-
LNGX 120516ER-M:M8330	1.6	240	0.15	3.0	-	-	-	225	0.15	3.0	-	-	-	-	-	-	-	-
LNGX 120516ER-M:M8340	1.6	220	0.15	3.0	-	-	-	205	0.15	3.0	-	-	-	-	-	-	-	-
LNGX 120520ER-M:M8310	2.0	280	0.15	3.0	-	-	-	265	0.15	3.0	-	-	-	-	-	-	-	-
LNGX 120520ER-M:M8330	2.0	255	0.15	3.0	-	-	-	240	0.15	3.0	-	-	-	-	-	-	-	-
LNGX 120520ER-M:M8340	2.0	230	0.15	3.0	-	-	-	215	0.15	3.0	-	-	-	-	-	-	-	-

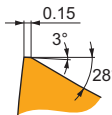

R geometrie mit positiven Design für instabile Schnittbedingungen.

LNGX 120508SR-R:8215	0.8	205	0.20	3.5	-	-	-	190	0.20	3.5	-	-	-	-	-	-	-	-
LNGX 120508SR-R:M5315	0.8	265	0.20	3.5	-	-	-	250	0.20	3.5	-	-	-	-	-	-	-	-
LNGX 120508SR-R:M8310	0.8	220	0.20	3.5	-	-	-	205	0.20	3.5	-	-	-	-	-	-	-	-
LNGX 120508SR-R:M8330	0.8	205	0.20	3.5	-	-	-	190	0.20	3.5	-	-	-	-	-	-	-	-
LNGX 120508SR-R:M8340	0.8	185	0.20	3.5	-	-	-	175	0.20	3.5	-	-	-	-	-	-	-	-
LNGX 120508SR-R:M9315	0.8	265	0.20	3.5	-	-	-	250	0.20	3.5	-	-	-	-	-	-	-	-
LNGX 120508SR-R:M9325	0.8	250	0.20	3.5	-	-	-	235	0.20	3.5	-	-	-	-	-	-	-	-
LNGX 120508SR-R:M9340	0.8	225	0.20	3.5	-	-	-	-	-	-	-	-	-	-	-	-	-	-
LNGX 120516SR-R:8215	1.6	225	0.20	3.5	-	-	-	210	0.20	3.5	-	-	-	-	-	-	-	-
LNGX 120516SR-R:M8330	1.6	225	0.20	3.5	-	-	-	210	0.20	3.5	-	-	-	-	-	-	-	-
LNGX 120516SR-R:M8340	1.6	205	0.20	3.5	-	-	-	190	0.20	3.5	-	-	-	-	-	-	-	-
LNGX 120516SR-R:M9325	1.6	275	0.20	3.5	-	-	-	260	0.20	3.5	-	-	-	-	-	-	-	-

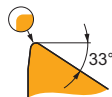

MF geometrie mit hoch positiven Design zur leichten Bearbeitung.

LNGX 120504ER-MF:M6330	0.4	175	0.15	1.0	125	0.14	1.0	-	-	-	-	-	-	-	-	-	-	-
LNGX 120504ER-MF:M9340	0.4	240	0.15	1.0	140	0.14	1.0	-	-	-	-	-	-	-	-	-	-	-
LNGX 120508ER-MF:M6330	0.8	210	0.15	1.0	150	0.14	1.0	-	-	-	-	-	-	-	-	-	-	-
LNGX 120508ER-MF:M8340	0.8	225	0.15	1.0	135	0.14	1.0	-	-	-	-	-	-	-	-	-	-	-
LNGX 120508ER-MF:M9340	0.8	285	0.15	1.0	170	0.14	1.0	-	-	-	-	-	-	-	-	-	-	-

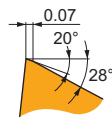
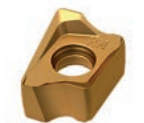

MM geometrie mit positiven Design zur leichten bis mittleren Bearbeitung.

LNGX 120508SR-MM:M6330	0.8	190	0.15	2.8	135	0.14	2.8	-	-	-	-	-	-	-	-	-	-	-
LNGX 120508SR-MM:M8340	0.8	200	0.15	2.8	120	0.14	2.8	-	-	-	-	-	-	-	-	-	-	-
LNGX 120508SR-MM:M8345	0.8	160	0.15	2.8	95	0.14	2.8	-	-	-	-	-	-	-	-	-	-	-
LNGX 120508SR-MM:M9340	0.8	255	0.15	2.8	150	0.14	2.8	-	-	-	-	-	-	-	-	-	-	-

LNGU 12



	W1	D1	L	S
	(mm)	(mm)	(mm)	(mm)
1205	9.500	4.50	12.00	5.96

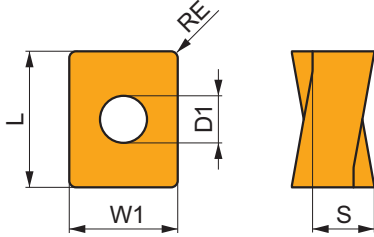

Eignung und Startwerte für Schnittgeschwindigkeit (vc), Vorschub (f) und Schnitttiefe (ap). Weitere Informationen finden Sie in unserer Zerspanungsrechner-App.

Produkt	RE (mm)	P			M			K			N			S			H		
		vc (m/min)	f (mm/tooth)	ap (mm)	vc (m/min)	f (mm/tooth)	ap (mm)	vc (m/min)	f (mm/tooth)	ap (mm)	vc (m/min)	f (mm/tooth)	ap (mm)	vc (m/min)	f (mm/tooth)	ap (mm)	vc (m/min)	f (mm/tooth)	ap (mm)



M geometrie mit positiven Design zur mittleren Bearbeitung.

LNGU 120525ER-M:M8330	✳	2.5	255	0.15	3.0	—	—	—	240	0.15	3.0	—	—	—	—	—	—	—	—
LNGU 120525ER-M:M8340	✳	2.5	230	0.15	3.0	—	—	—	215	0.15	3.0	—	—	—	—	—	—	—	—
LNGU 120530ER-M:M8330	✳	3.0	255	0.15	3.0	—	—	—	240	0.15	3.0	—	—	—	—	—	—	—	—
LNGU 120530ER-M:M8340	✳	3.0	230	0.15	3.0	—	—	—	215	0.15	3.0	—	—	—	—	—	—	—	—

LNGX 12-FA



	W1	D1	L	S
	(mm)	(mm)	(mm)	(mm)
1205	9.500	4.50	12.00	5.96

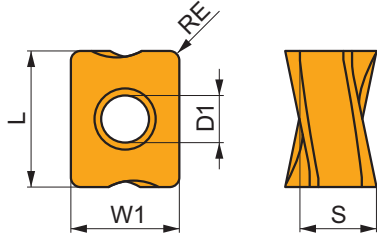

Eignung und Startwerte für Schnittgeschwindigkeit (vc), Vorschub (f) und Schnitttiefe (ap). Weitere Informationen finden Sie in unserer Zerspanungsrechner-App.

Produkt	RE (mm)	P			M			K			N			S			H		
		vc (m/min)	f (mm/tooth)	ap (mm)	vc (m/min)	f (mm/tooth)	ap (mm)	vc (m/min)	f (mm/tooth)	ap (mm)	vc (m/min)	f (mm/tooth)	ap (mm)	vc (m/min)	f (mm/tooth)	ap (mm)	vc (m/min)	f (mm/tooth)	ap (mm)



FA geometrie mit hoch positiven Design zur feinen Schlichtbearbeitung bis zur mittleren Bearbeitung.

LNGX 120504FR-FA:HF7	●	0.4	—	—	—	—	—	—	270	0.30	2.0	—	—	—	—	—	—	—	—
LNGX 120508FR-FA:HF7	●	0.8	—	—	—	—	—	—	315	0.30	2.0	—	—	—	—	—	—	—	—
LNGX 120508FR-FA:M0315	●	0.8	—	—	—	—	—	—	720	0.30	2.0	—	—	—	—	—	—	—	—



a_e / DC	5 %	10 %	15 %	20 %	25 %	30 %	40 %	50 %	60 %	70 %	75 %	80 %	90 %	100 %
	1.48	1.35	1.27	1.22	1.19	1.16	1.11	1.08	1.05	1.03	1.00	1.00	1.00	1.00
	2.20	1.60	1.35	1.20	1.10	0.95	0.85	0.75	0.85	0.95	1.00	1.00	1.00	1.00
	0.64	0.64	0.64	0.64	0.64	0.65	0.65	0.67	0.68	0.71	0.72	0.74	0.79	1.00

	LNGX 12-F		LNGX 12-M						LNGU 12-M	
	0.4	0.8	0.4	0.8	1.0	1.2	1.6	2.0	2.5	3.0
	2.29	1.89	2.29	1.89	1.69	1.49	1.09	0.68	0.87	0.36

	LNGX 12-R		LNGX 12-MF		LNGX 12-MM	LNGX 12-FA	
	0.8	1.6	0.4	0.8	0.8	0.4	0.8
	1.88	1.08	2.28	1.88	1.88	2.30	1.89

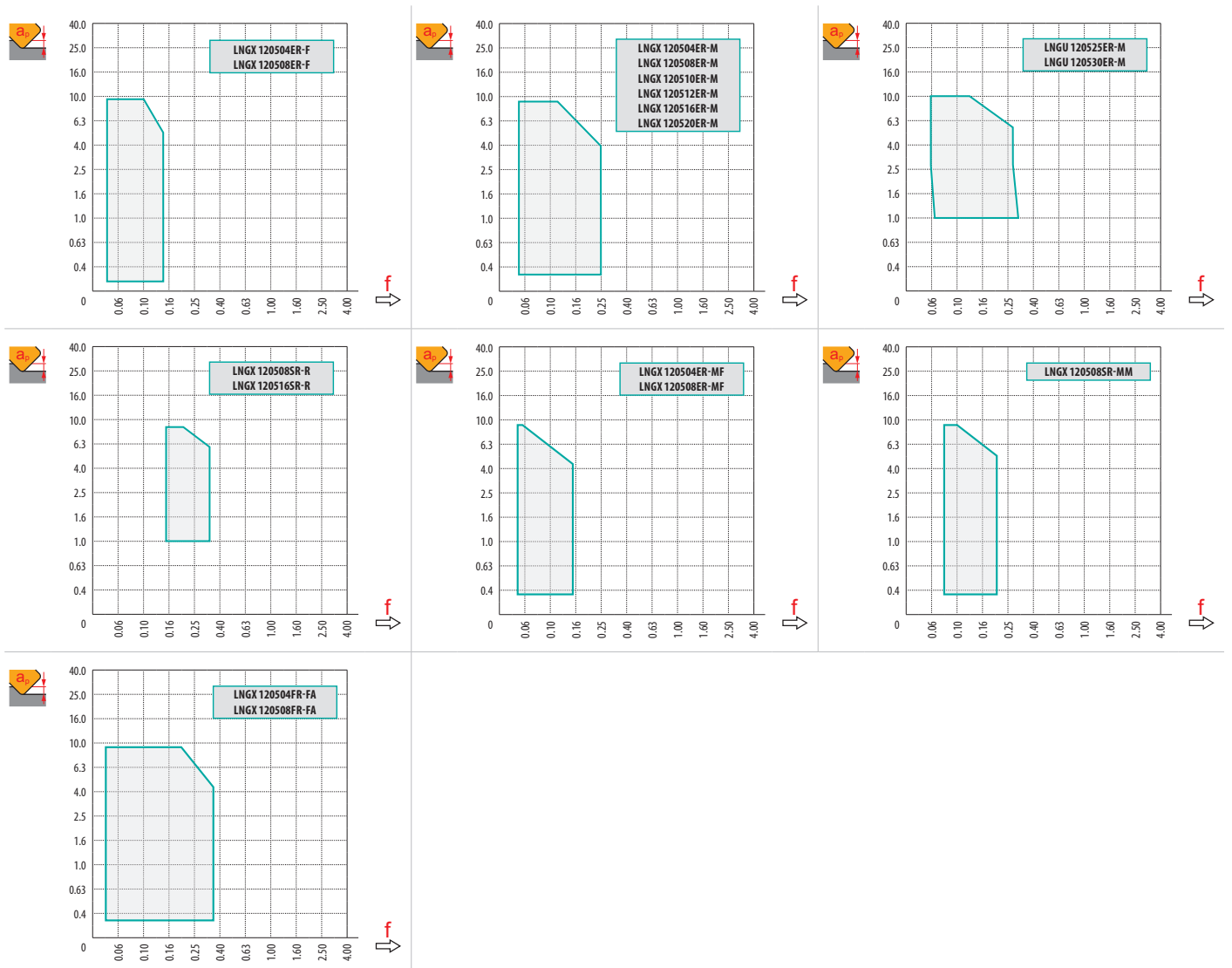

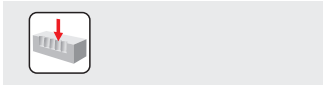

max
3.5

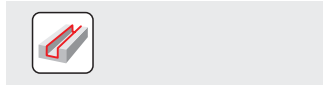

	1.0	5.0	9.0
	0.19	0.13	0.08

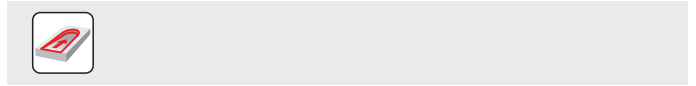

LNGX 12		
	RPMX	APMX/II
25	1.3°	2.1/100
32	0.7°	1.1/100
40	0.5°	0.7/100
50	0.4°	0.5/100
63	0.2°	0.3/100
80	0.2°	0.2/100

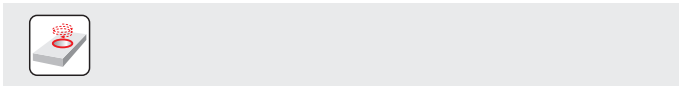

LNGX 12				
	DMIN	DMAX		
25	35.0	50.0	0.7	1.7
32	49.0	64.0	0.6	1.2
40	65.0	80.0	0.6	1.0
50	85.0	100.0	0.7	1.0
63	111.0	126.0	0.6	0.8
80	145.0	160.0	0.7	0.8

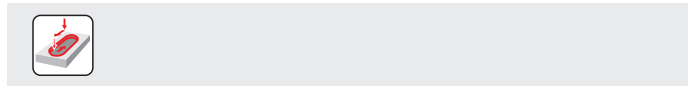

0.2

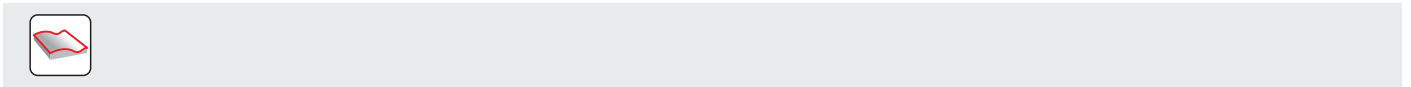

		3	5	10	15	20	30	40	50	60	80	100
25		0.548	0.707	1.000	1.225	1.414	1.732	2.000	2.236	2.449	2.828	3.162
32		0.620	0.800	1.131	1.386	1.600	1.960	2.263	2.530	2.771	3.200	3.578
40		0.693	0.894	1.265	1.549	1.789	2.191	2.530	2.828	3.098	3.578	4.000
50		0.775	1.000	1.414	1.732	2.000	2.449	2.828	3.162	3.464	4.000	4.472
63		0.869	1.122	1.587	1.944	2.245	2.750	3.175	3.550	3.888	4.490	5.020
80	0.980	1.265	1.789	2.191	2.530	3.098	3.578	4.000	4.382	5.060	5.657	

		3	5	10	15	20	30	40	50	60	80	100
1.6		0.196	0.253	0.358	0.438	0.506	0.620	0.716	0.800	0.876	1.012	1.131
2.0		0.219	0.283	0.400	0.490	0.566	0.693	0.800	0.894	0.980	1.131	1.265
2.5		0.245	0.316	0.447	0.548	0.632	0.775	0.894	1.000	1.095	1.265	1.414
3.0		0.268	0.346	0.490	0.600	0.693	0.849	0.980	1.095	1.200	1.386	1.549

SLN16

P **K** **N** **H**

PRAMET

S



ECON LN16 Eckfräser mit Innenkühlung

90° Messerkopf mit doppelseitigen LN.. 16 Wendeschneidplatten mit APMX von 13 mm. Geeignet für eine Vielzahl an Anwendungen. Erhältlich als Aufsteckfräser mit ungleicher Teilung. Für längere Standzeiten ist der Körper oberflächenbehandelt.

ECON LN

KAPR	90°
APMX	13.0 mm

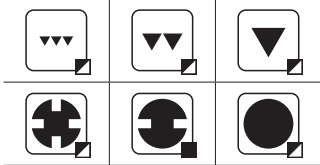
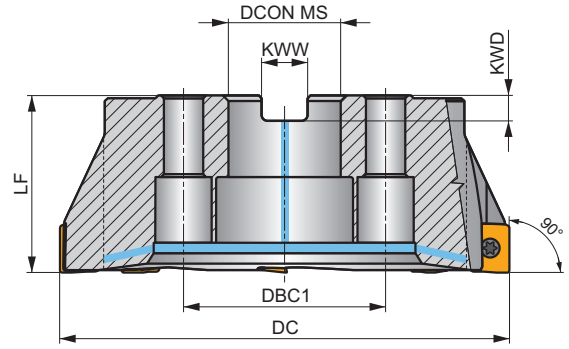
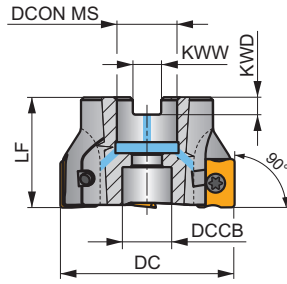
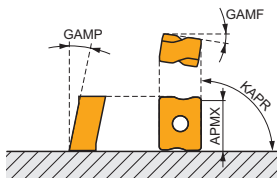

0.08 - 0.2



Produkt	DC	LF	DCON MS	DCCB	DBC1	KWW	KWD	GAMF	GAMP								
	(mm)	(mm)	(mm)	(mm)	(mm)	(mm)	(mm)	(°)	(°)								
63A04R-S90LN16-C	63	40	22	18	-	10.4	6.3	-10.5	-6	4	✓	7600	✓	0.46	GI207	SQ353	-
63A05R-S90LN16-C	63	40	22	18	-	10.4	6.3	-10.5	-6	5	✓	7600	✓	0.46	GI207	SQ353	-
80A04R-S90LN16-C	80	50	27	38	-	12.4	7	-10.5	-6	4	✓	6800	✓	0.98	GI207	SQ351	AC001
80A06R-S90LN16-C	80	50	27	38	-	12.4	7	-10.5	-6	6	✓	6800	✓	0.89	GI207	SQ351	AC001
100A05R-S90LN16-C	100	50	32	45	-	14.4	8	-10.5	-6	5	✓	6100	✓	0.98	GI207	SQ351	AC002
100A07R-S90LN16-C	100	50	32	45	-	14.4	8	-10.5	-6	7	✓	6100	✓	1.78	GI207	SQ351	AC002
125A06R-S90LN16-C	125	63	40	56	-	16.4	9	-10.5	-6	6	✓	5400	✓	3.39	GI207	SQ351	AC003
125A08R-S90LN16-C	125	63	40	56	-	16.4	9	-10.5	-6	8	✓	5400	✓	3.28	GI207	SQ351	AC003
140A06R-S90LN16-C	140	63	40	56	-	16.4	9	-10.5	-6	6	✓	5100	✓	3.91	GI207	SQ351	AC003
160C08R-S90LN16-C	160	63	40	-	66.7	16.4	9	-10.5	-6	8	✓	4700	✓	6.19	GI207	SQ356	-
175C08R-S90LN16-C	175	63	40	-	66.7	16.4	9	-10.5	-6	8	✓	4500	✓	7.11	GI207	SQ356	-

GI207	LNMU 1607..	LNGU 1607..

SQ351	US 45012-T20P	5.0	M 5	12	SDR T20P-T	-	-	-	-
SQ353	US 45012-T20P	5.0	M 5	12	SDR T20P-T	HS 1030C	-	-	-
SQ356	US 45012-T20P	5.0	M 5	12	SDR T20P-T	HS 1240C	CAC 160C	HSD 0825C	HXK 5

AC001	KS 1230	K.FMH27
AC002	KS 1635	K.FMH32
AC003	KS 2040	K.FMH40

LNGU 16



	W1	D1	L	S
	(mm)	(mm)	(mm)	(mm)
1607	13.200	5.70	16.60	7.50

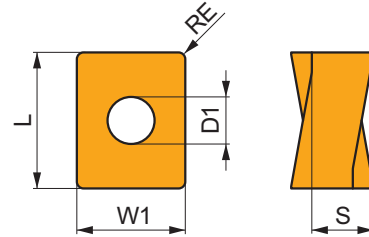

Eignung und Startwerte für Schnittgeschwindigkeit (vc), Vorschub (f) und Schnitttiefe (ap). Weitere Informationen finden Sie in unserer Zerspanungsrechner-App.

Produkt	RE (mm)	P			M			K			N			S			H		
		vc (m/min)	f (mm/tooth)	ap (mm)	vc (m/min)	f (mm/tooth)	ap (mm)	vc (m/min)	f (mm/tooth)	ap (mm)	vc (m/min)	f (mm/tooth)	ap (mm)	vc (m/min)	f (mm/tooth)	ap (mm)	vc (m/min)	f (mm/tooth)	ap (mm)

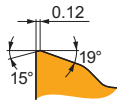
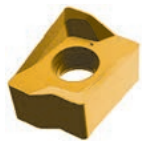

M geometrie mit sehr positiven Design zur mittleren Bearbeitung.

LNGU 160708SR-M:8215	0.8	200	0.18	5.0	—	—	—	190	0.18	5.0	—	—	—	—	—	—	40	0.12	1.0
LNGU 160708SR-M:M8340	0.8	180	0.18	5.0	—	—	—	170	0.18	5.0	—	—	—	—	—	—	—	—	—
LNGU 160708SR-M:M9315	0.8	265	0.18	5.0	—	—	—	250	0.18	5.0	—	—	—	—	—	—	50	0.12	1.0
LNGU 160708SR-M:M9325	0.8	250	0.18	5.0	—	—	—	235	0.18	5.0	—	—	—	—	—	—	50	0.12	1.0

LNMU 16



	W1	D1	L	S
	(mm)	(mm)	(mm)	(mm)
1607	13.200	5.70	16.60	7.50

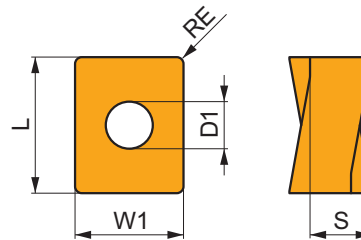

Eignung und Startwerte für Schnittgeschwindigkeit (vc), Vorschub (f) und Schnitttiefe (ap). Weitere Informationen finden Sie in unserer Zerspanungsrechner-App.

Produkt	RE (mm)	P			M			K			N			S			H		
		vc (m/min)	f (mm/tooth)	ap (mm)	vc (m/min)	f (mm/tooth)	ap (mm)	vc (m/min)	f (mm/tooth)	ap (mm)	vc (m/min)	f (mm/tooth)	ap (mm)	vc (m/min)	f (mm/tooth)	ap (mm)	vc (m/min)	f (mm/tooth)	ap (mm)



F geometrie mit hoch positiven Design zum Schlichten.

LNMU 160708ER-F:M8330	0.8	230	0.16	1.7	—	—	—	—	—	—	—	—	—	—	—	—	—	—	—
LNMU 160708ER-F:M8340	0.8	210	0.16	1.7	—	—	—	—	—	—	—	—	—	—	—	—	—	—	—

Eignung und Startwerte für Schnittgeschwindigkeit (vc), Vorschub (f) und Schnitttiefe (ap). Weitere Informationen finden Sie in unserer Zerspanungsrechner-App.

Produkt	RE (mm)	P			M			K			N			S			H		
		vc (m/min)	f (mm/tooth)	ap (mm)	vc (m/min)	f (mm/tooth)	ap (mm)	vc (m/min)	f (mm/tooth)	ap (mm)	vc (m/min)	f (mm/tooth)	ap (mm)	vc (m/min)	f (mm/tooth)	ap (mm)	vc (m/min)	f (mm/tooth)	ap (mm)

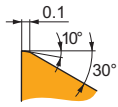

M geometrie mit positiven Design zur mittleren Bearbeitung.

LNMU 160708SR-M:8215	0.8	200	0.18	5.0	-	-	-	190	0.18	5.0	-	-	-	-	-	-	-	-
LNMU 160708SR-M:M6330	0.8	170	0.18	5.0	-	-	-	-	-	-	-	-	-	-	-	-	-	-
LNMU 160708SR-M:M8330	0.8	200	0.18	5.0	-	-	-	190	0.18	5.0	-	-	-	-	-	-	-	-
LNMU 160708SR-M:M8340	0.8	180	0.18	5.0	-	-	-	170	0.18	5.0	-	-	-	-	-	-	-	-
LNMU 160708SR-M:M9325	0.8	250	0.18	5.0	-	-	-	235	0.18	5.0	-	-	-	-	-	-	-	-
LNMU 160720SR-M:M8330	2.0	230	0.18	5.0	-	-	-	215	0.18	5.0	-	-	-	-	-	-	-	-
LNMU 160720SR-M:M8340	2.0	210	0.18	5.0	-	-	-	195	0.18	5.0	-	-	-	-	-	-	-	-
LNMU 160730SR-M:M8330	3.0	230	0.18	5.0	-	-	-	215	0.18	5.0	-	-	-	-	-	-	-	-
LNMU 160730SR-M:M8340	3.0	210	0.18	5.0	-	-	-	195	0.18	5.0	-	-	-	-	-	-	-	-
LNMU 160740SR-M:M8340	4.0	210	0.18	5.0	-	-	-	195	0.18	5.0	-	-	-	-	-	-	-	-

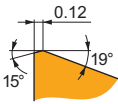

R geometrie mit stabilen positiven Design zur mittleren Bearbeitung.

LNMU 160708SR-R:M5315	0.8	265	0.18	6.3	-	-	-	250	0.18	6.3	-	-	-	-	-	50	0.12	1.0
LNMU 160708SR-R:M8330	0.8	195	0.18	6.3	-	-	-	185	0.18	6.3	-	-	-	-	-	35	0.12	1.0
LNMU 160708SR-R:M8340	0.8	175	0.18	6.3	-	-	-	165	0.18	6.3	-	-	-	-	-	-	-	-
LNMU 160708SR-R:M9315	0.8	260	0.18	6.3	-	-	-	245	0.18	6.3	-	-	-	-	-	50	0.12	1.0
LNMU 160708SR-R:M9325	0.8	240	0.18	6.3	-	-	-	225	0.18	6.3	-	-	-	-	-	45	0.12	1.0
LNMU 160716SR-R:M8330	1.6	215	0.18	6.3	-	-	-	200	0.18	6.3	-	-	-	-	-	40	0.12	1.1
LNMU 160716SR-R:M8340	1.6	195	0.18	6.3	-	-	-	185	0.18	6.3	-	-	-	-	-	-	-	-
LNMU 160716SR-R:M9315	1.6	285	0.18	6.3	-	-	-	270	0.18	6.3	-	-	-	-	-	55	0.12	1.1
LNMU 160716SR-R:M9325	1.6	265	0.18	6.3	-	-	-	250	0.18	6.3	-	-	-	-	-	50	0.12	1.1

LNGU 16-FA



	W1 (mm)	D1 (mm)	L (mm)	S (mm)
1607	13.200	5.70	16.60	7.50

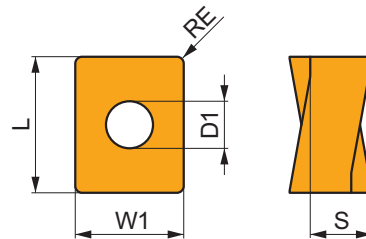

Eignung und Startwerte für Schnittgeschwindigkeit (vc), Vorschub (f) und Schnitttiefe (ap). Weitere Informationen finden Sie in unserer Zerspanungsrechner-App.

Produkt	RE (mm)	P			M			K			N			S			H		
		vc (m/min)	f (mm/tooth)	ap (mm)	vc (m/min)	f (mm/tooth)	ap (mm)	vc (m/min)	f (mm/tooth)	ap (mm)	vc (m/min)	f (mm/tooth)	ap (mm)	vc (m/min)	f (mm/tooth)	ap (mm)	vc (m/min)	f (mm/tooth)	ap (mm)

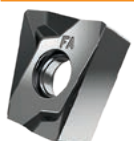

FA geometrie mit hoch positiven Design zur feinen Schlichtbearbeitung bis zur mittleren Bearbeitung.

LNGU 160708FR-FA:HF7	0.8	-	-	-	-	-	-	-	-	-	300	0.30	3.0	-	-	-	-	-
----------------------	-----	---	---	---	---	---	---	---	---	---	-----	------	-----	---	---	---	---	---



a_e / DC	5%	10%	15%	20%	25%	30%	40%	50%	60%	70%	75%	80%	90%	100%
	1.48	1.35	1.27	1.22	1.19	1.16	1.11	1.08	1.05	1.03	1.00	1.00	1.00	1.00
	2.20	1.60	1.35	1.20	1.10	0.95	0.85	0.75	0.85	0.95	1.00	1.00	1.00	1.00
	0.64	0.64	0.64	0.64	0.64	0.65	0.65	0.67	0.68	0.71	0.72	0.74	0.79	1.00

	LNMU 16-F	LNMU 16-M			LNMU 16-R		LNGU 16-M	LNGU 16-FA	
	0.8	0.8	2.0	3.0	4.0	0.8	1.6	0.8	0.8
	3.30	3.30	2.11	1.12	0.10	3.30	2.50	3.24	3.30

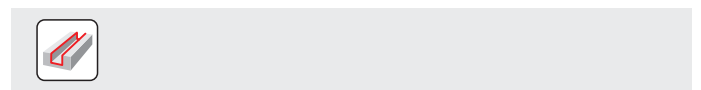
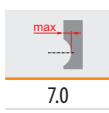
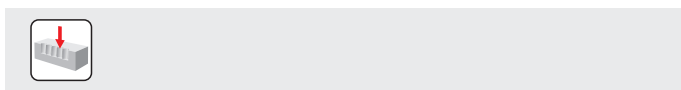
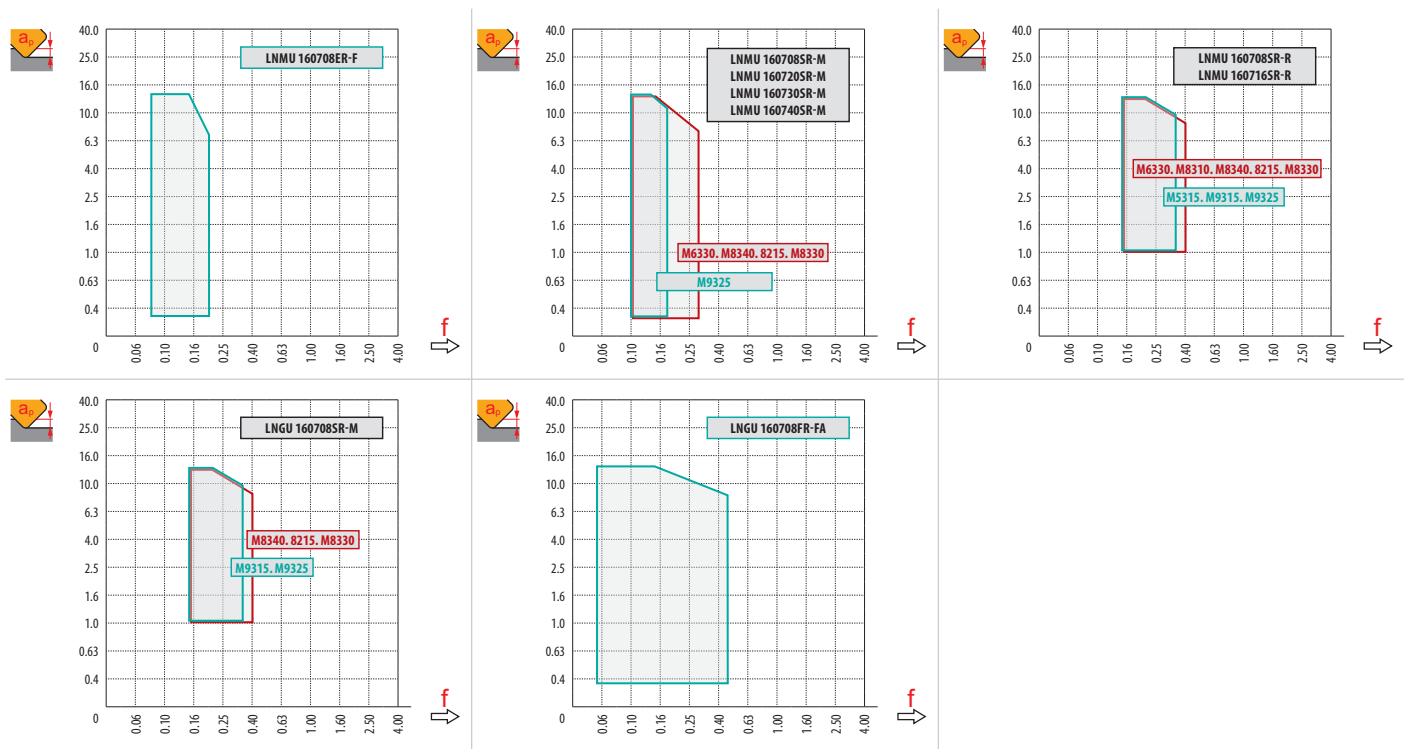

	1.0	6.0	13.0
	0.31	0.24	0.13

SLN12X



PRAMET



PROD LN12 90° Tangentialer Eckfräser mit Innenkühlung

Hochproduktive 90°-Eckfräser mit tangentialer LNE12-Wendeschneidplatte mit 4 Schneidkanten und APMX von 10 mm. Geeignet für eine Vielzahl von Anwendungen. Erhältlich in zylindrischer, Weldon- und Aufsteck-Ausführung. Der robuste Fräskörper sorgt für eine lange Standzeit und eine ausgezeichnete Bruchsicherheit.

KAPR	90°
APMX	10.0 mm

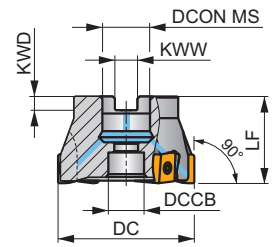
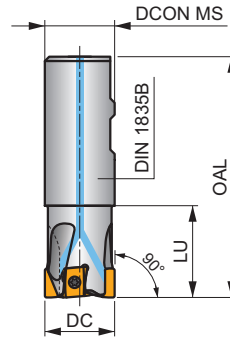
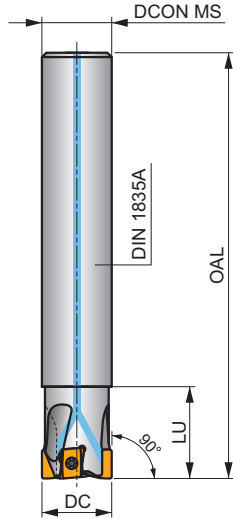
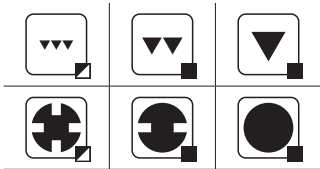
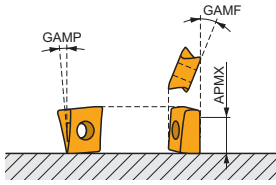

	0.06 - 0.18
	0.06 - 0.20



Produkt	DC	OAL	DCON MS	DCCB	LU	LF	KWW	KWD	GAMF	GAMP					kg		
	(mm)	(mm)	(mm)	(mm)	(mm)	(mm)	(mm)	(mm)	(°)	(°)							
25A2R042A25-SLN12X-C	25	170	25	-	42	-	-	-	-30	-5	2	-	17300	✓	0.55	GI206	C0382
25A2R080A25-SLN12X-C	25	170	25	-	80	-	-	-	-30	-5	2	-	17300	✓	0.50	GI206	C0382
32A3R042A32-SLN12X-C	32	195	32	-	42	-	-	-	-22.5	-5	3	-	15300	✓	1.08	GI206	SQ340
32A3R090A32-SLN12X-C	32	195	32	-	90	-	-	-	-22.5	-5	3	-	15300	✓	1.02	GI206	SQ340
40A4R050A32-SLN12X-C	40	195	32	-	50	-	-	-	-22.5	-5	4	-	13700	✓	1.17	GI206	SQ340
25A2R042B25-SLN12X-C	25	100	25	-	42	-	-	-	-30	-5	2	-	17300	✓	0.29	GI206	C0382
32A3R042B32-SLN12X-C	32	110	32	-	42	-	-	-	-22.5	-5	3	-	15300	✓	0.58	GI206	SQ340
40A4R050B32-SLN12X-C	40	120	32	-	50	-	-	-	-22.5	-5	4	-	13700	✓	0.73	GI206	SQ340
40A03R-S90LN12X-C	40	-	16	12.4	-	40	8.4	5.6	-22.5	-5	3	-	13700	✓	0.15	GI206	SQ345
40A04R-S90LN12X-C	40	-	16	12.4	-	40	8.4	5.6	-22.5	-5	4	✓	13700	✓	0.23	GI206	SQ345
50A05R-S90LN12X-C	50	-	22	16.5	-	40	10.4	6.3	-19.5	-5	5	-	12300	✓	0.34	GI206	SQ343
50A06R-S90LN12X-C	50	-	22	16.5	-	40	10.4	6.3	-19.5	-5	6	-	12300	✓	0.34	GI206	SQ343
52A05R-S90LN12X-C	52	-	22	16.5	-	40	10.4	6.3	-19.5	-5	5	-	12300	✓	0.37	GI206	SQ343
63A06R-S90LN12X-C	63	-	22	16.5	-	40	10.4	6.3	-19.5	-5	6	✓	10900	✓	0.61	GI206	SQ343
63A08R-S90LN12X-C	63	-	22	16.5	-	40	10.4	6.3	-19.5	-5	8	-	10900	✓	0.50	GI206	SQ343
66A06R-S90LN12X-C	66	-	22	16.5	-	40	10.4	6.3	-19.5	-5	6	✓	10900	✓	0.54	GI206	SQ343
80A07R-S90LN12X-C	80	-	27	38.1	-	50	12.4	7	-19.5	-5	7	✓	9700	✓	1.00	GI206	SQ341
80A10R-S90LN12X-C	80	-	27	38.1	-	50	12.4	7	-19.5	-5	10	-	9700	✓	0.98	GI206	SQ341
100A08R-S90LN12X-C	100	-	32	45.1	-	50	14.4	8	-17.5	-5	8	✓	8700	✓	1.90	GI206	SQ341
100A11R-S90LN12X-C	100	-	32	45.1	-	50	14.4	8	-17.5	-5	11	-	8700	✓	1.88	GI206	SQ341
125A12R-S90LN12X-C	125	-	40	56.1	-	63	16.4	9	-17.5	-5	12	✓	7800	✓	3.39	GI206	SQ341

Icon 1	Icon 2	Nm	Icon 4	Icon 5	Icon 6	Icon 7	Icon 8	Icon 9
C0382	US 44010-T15P	3.5	M 4	10	—	—	Flag T15P	—
SQ340	US 44012-T15P	3.5	M 4	12	—	—	Flag T15P	—
SQ341	US 44012-T15P	3.5	M 4	12	D-T08P/T15P	FG-15	—	—
SQ343	US 44012-T15P	3.5	M 4	12	D-T08P/T15P	FG-15	—	HS 1030C
SQ345	US 44012-T15P	3.5	M 4	12	D-T08P/T15P	FG-15	—	HS 90835

LNEX 12



Icon	W1	D1	L	S
	(mm)	(mm)	(mm)	(mm)
1210	6.000	4.40	13.30	10.26

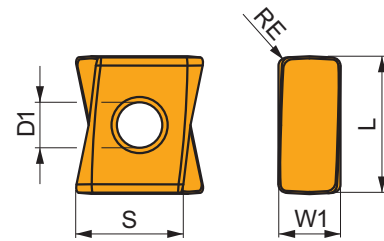

Eignung und Startwerte für Schnittgeschwindigkeit (vc), Vorschub (f) und Schnitttiefe (ap). Weitere Informationen finden Sie in unserer Zerspanungsrechner-App.

Produkt	RE	P			M			K			N			S			H					
		vc	f	ap	vc	f	ap	vc	f	ap	vc	f	ap	vc	f	ap	vc	f	ap			
	(mm)	(m/min)	(mm/tooth)	(mm)	(m/min)	(mm/tooth)	(mm)	(m/min)	(mm/tooth)	(mm)	(m/min)	(mm/tooth)	(mm)	(m/min)	(mm/tooth)	(mm)	(m/min)	(mm/tooth)	(mm)	(m/min)	(mm/tooth)	(mm)

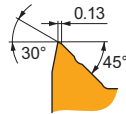

F geometrie ist scharf und wird für leichte und mittlere Bearbeitungen verwendet, geeignet für Anwendungen mit großem Überhang. Ausgelegt mit hoch positivem Spanwinkel, schmaler Fase und verrundung der Schneidkante für leichte bis mittlere Bearbeitungen.

LNEX 121008SR-F:M6330	✳	0.8	■	220	0.17	3.0	■	155	0.15	3.0	■	—	—	—	—	—	—	—	—	—	—	—
LNEX 121008SR-F:M8310	✳	0.8	■	280	0.17	3.0	■	140	0.15	3.0	■	265	0.17	3.0	■	—	—	—	■	55	0.11	1.0
LNEX 121008SR-F:M8330	✳	0.8	■	260	0.17	3.0	■	155	0.15	3.0	■	245	0.17	3.0	■	—	—	—	■	50	0.11	1.0
LNEX 121008SR-F:M8340	✳	0.8	■	235	0.17	3.0	■	140	0.15	3.0	■	220	0.17	3.0	■	—	—	—	—	—	—	—
LNEX 121012SR-F:M6330	✳	1.2	■	230	0.17	3.0	■	165	0.15	3.0	■	—	—	—	—	—	—	—	—	—	—	—
LNEX 121012SR-F:M8310	✳	1.2	■	295	0.17	3.0	■	150	0.15	3.0	■	280	0.17	3.0	■	—	—	—	■	55	0.11	1.0
LNEX 121012SR-F:M8330	✳	1.2	■	270	0.17	3.0	■	160	0.15	3.0	■	255	0.17	3.0	■	—	—	—	■	50	0.11	1.0

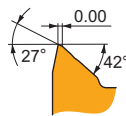

M geometrie ist vielseitig und die erste Wahl für unterschiedlichste Arbeitsbedingungen. Ausgelegt mit positivem Spanwinkel, mittlerer Fase und verrundeter Schneidkante für die mittlere Bearbeitung.

LNEX 121008SR-M:M6330	✳	0.8	■	210	0.20	3.5	■	—	—	—	■	—	—	—	—	—	—	—	—	—	—	—
LNEX 121008SR-M:M8310	✳	0.8	■	265	0.20	3.5	■	—	—	—	■	250	0.20	3.5	■	—	—	—	■	50	0.16	1.0
LNEX 121008SR-M:M8330	✳	0.8	■	245	0.20	3.5	■	—	—	—	■	230	0.20	3.5	■	—	—	—	■	45	0.16	1.0
LNEX 121008SR-M:M8340	✳	0.8	■	220	0.20	3.5	■	—	—	—	■	205	0.20	3.5	■	—	—	—	—	—	—	—
LNEX 121008SR-M:M9315	✳	0.8	■	320	0.20	3.5	■	—	—	—	■	300	0.20	3.5	■	—	—	—	■	60	0.16	1.0
LNEX 121008SR-M:M9325	✳	0.8	■	300	0.20	3.5	■	—	—	—	■	285	0.20	3.5	■	—	—	—	■	60	0.16	1.0
LNEX 121008SR-M:M9340	✳	0.8	■	270	0.20	3.5	■	—	—	—	■	—	—	—	■	—	—	—	—	—	—	—
LNEX 121012SR-M:M8310	✳	1.2	■	280	0.20	3.5	■	—	—	—	■	265	0.20	3.5	■	—	—	—	■	55	0.16	1.0
LNEX 121012SR-M:M8330	✳	1.2	■	255	0.20	3.5	■	—	—	—	■	240	0.20	3.5	■	—	—	—	■	50	0.16	1.0
LNEX 121012SR-M:M8340	✳	1.2	■	235	0.20	3.5	■	—	—	—	■	220	0.20	3.5	■	—	—	—	—	—	—	—
LNEX 121016SR-M:M8310	✳	1.6	■	295	0.20	3.5	■	—	—	—	■	280	0.20	3.5	■	—	—	—	■	55	0.16	1.0
LNEX 121016SR-M:M8330	✳	1.6	■	270	0.20	3.5	■	—	—	—	■	255	0.20	3.5	■	—	—	—	■	50	0.16	1.0
LNEX 121016SR-M:M8340	✳	1.6	■	245	0.20	3.5	■	—	—	—	■	230	0.20	3.5	■	—	—	—	—	—	—	—
LNEX 121020SR-M:M8330	✳	2.0	■	285	0.20	3.5	■	—	—	—	■	270	0.20	3.5	■	—	—	—	■	55	0.16	1.0
LNEX 121020SR-M:M8340	✳	2.0	■	255	0.20	3.5	■	—	—	—	■	240	0.20	3.5	■	—	—	—	—	—	—	—
LNEX 121024SR-M:M8330	✳	2.4	■	285	0.20	3.5	■	—	—	—	■	270	0.20	3.5	■	—	—	—	■	55	0.16	1.0
LNEX 121024SR-M:M8340	✳	2.4	■	255	0.20	3.5	■	—	—	—	■	240	0.20	3.5	■	—	—	—	—	—	—	—



a_e / DC	5 %	10 %	15 %	20 %	25 %	30 %	40 %	50 %	60 %	70 %	75 %	80 %	90 %	100 %
	1.48	1.35	1.27	1.22	1.19	1.16	1.11	1.08	1.05	1.03	1.00	1.00	1.00	1.00
	2.20	1.60	1.35	1.20	1.10	0.95	0.85	0.75	0.85	0.95	1.00	1.00	1.00	1.00
	0.64	0.64	0.64	0.64	0.64	0.65	0.65	0.67	0.68	0.71	0.72	0.74	0.79	1.00

	LNEX 12-F		LNEX 12-M				
	0.8	1.2	0.8	1.2	1.6	2.0	2.4
	2.25	1.73	2.25	1.73	1.33	1.15	0.79

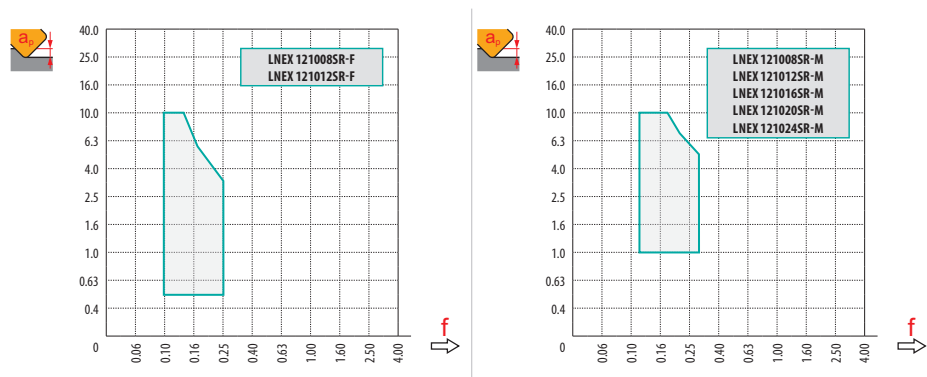







		2.0	3.0	4.0	5.0
2.5		0.30	0.20	0.20	0.15

	RPMX	APMX/I
25	0.80°	1.40/100
32	0.60°	1.00/100
40	0.35°	0.60/100
50	0.30°	0.50/100
52	0.30°	0.50/100
63	0.20°	0.35/100

	DMIN	DMAX		
25	44.0	48.0	0.6	0.7
32	58.0	62.0	0.8	1.0
40	74.0	78.0	0.7	0.8
50	94.0	98.0	0.7	0.8
52	98.0	102.0	0.7	0.8
63	120.0	124.0	0.3	0.4





























		3	5	10	15	20	30	40	50	60	80	100
25		0.548	0.707	1.000	1.225	1.414	1.732	2.000	2.236	2.449	2.828	3.162
32		0.620	0.800	1.131	1.386	1.600	1.960	2.263	2.530	2.771	3.200	3.578
40		0.693	0.894	1.265	1.549	1.789	2.191	2.530	2.828	3.098	3.578	4.000
50		0.775	1.000	1.414	1.732	2.000	2.449	2.828	3.162	3.464	4.000	4.472
52		0.869	1.122	1.587	1.944	2.245	2.750	3.175	3.550	3.888	4.490	5.020
63		0.980	1.265	1.789	2.191	2.530	3.098	3.578	4.000	4.382	5.060	5.657

		3	5	10	15	20	30	40	50	60	80	100
0.8		0.155	0.200	0.283	0.346	0.400	0.490	0.566	0.632	0.693	0.800	0.894
1.2		0.170	0.219	0.310	0.379	0.438	0.537	0.620	0.693	0.759	0.876	0.980
1.6		0.196	0.253	0.358	0.438	0.506	0.620	0.716	0.800	0.876	1.012	1.131
2.0		0.219	0.283	0.400	0.490	0.566	0.693	0.800	0.894	0.980	1.131	1.265
2.4		0.245	0.316	0.447	0.548	0.632	0.775	0.894	1.000	1.095	1.265	1.414

WENDEPLATTENFRÄSER – AUSWAHLHILFE

PLANFRÄSEN

	SAD07D	SAD11E	SAD16E	SAP10D	SAP16D																							
	90°		90°		90°		90°		90°																			
	APMX (mm)	5.0	APMX (mm)	9.0	APMX (mm)	13.0	APMX (mm)	9.0	APMX (mm)	13.0																		
	DC (mm)	10 – 32	DC (mm)	16 – 125	DC (mm)	25 – 175	DC (mm)	10 – 25	DC (mm)	25 – 125																		
Zylindrischer Schaft		DC = 10 – 25 (mm)		DC = 16 – 35 (mm)		DC = 25, 32 (mm)																						
Weldon				DC = 16 – 32 (mm)		DC = 25 – 40 (mm)		DC = 10 – 25 (mm)		DC = 25 – 40 (mm)																		
Modular		DC = 12 – 32 (mm)		DC = 16 – 40 (mm)		DC = 32, 40 (mm)																						
Aufsteckfräser				DC = 40 – 125 (mm)		DC = 40 – 175 (mm)				DC = 40 – 125 (mm)																		
Seite	📖 90		📖 97		📖 106		📖 114		📖 117																			
ISO	P	M	K	N	S	P	M	K	N	S	H	P	M	K	N	S	H	P	M	K	N	S	P	M	K	N	S	
Schneidplattenform																												
Wendeschneidplatten	AD.X 0702		AD.X 11T3		AD.X 1606		APKT 1003		APT 1604																			
Anzahl der Schneiden	2		2		2		2		2																			
Planfräsen 	■		■		■		■		■																			
Fasenfräsen 	■		■		■		■		■																			
Schraubenlinien- interpolation 	■		■		■		■		■																			
Progressives Tauchfräsen 	■		■		■		■		■																			
Rampen 	■		■		■		■		■																			
Fräsen geformter Flächen (Kopierfräsen) 	■		■		■		■		■																			
Flaches Eckfräsen 	▣		▣		▣		▣		▣																			
Flaches Nutfräsen 	▣		■		■																							

SAD07D



PRAMET



FORCE AD11 Eckfräser mit Innenkühlung

90° Schaftfräser mit positiven AD.. 07 Wendeschneidplatten und APMX von 5 mm. Geeignet für viele Anwendung, wie z.B. Plan-, Schulter-, Nut-, Helix-, Trochoiden-, Rampen- und Tauchfräsen. Erhältlich mit zylindrischem und modularem Schaft und mit ungleicher Teilung. Für längere Standzeiten ist der Körper oberflächenbehandelt.

FORCE AD

KAPR	90°
APMX	5.0 mm

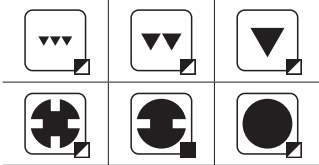
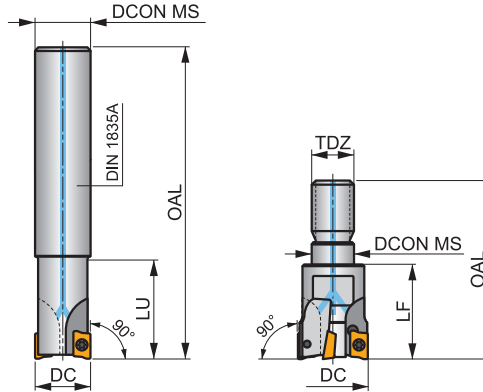
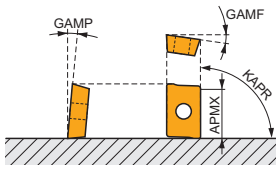

h_m 0.03 - 0.08



Produkt	DC	OAL	D CON MS	LU	LF	TDZ	GAMF	GAMP				kg			
	(mm)	(mm)	(mm)	(mm)	(mm)	(°)	(°)	max.							
10A2R016A08-SAD07D-C	10	100	8	16	-	-	-12	8	2	-	61600	✓	0.05	GI276	SQ010
10A2R016A10-SAD07D-C	10	80	10	16	-	-	-12	8	2	-	61600	✓	0.05	GI276	SQ010
10A2R018A08-SAD07D-CF	10	100	8	18	-	-	-12	8	2	-	61600	✓	0.06	GI276	SQ010
10A2R018A10-SAD07D-CF	10	80	10	18	-	-	-12	8	2	-	61600	✓	0.05	GI276	SQ010
12A2R018A10-SAD07D-C	12	120	10	18	-	-	-10	8	2	-	56300	✓	0.09	GI276	SQ010
12A2R018A12-SAD07D-C	12	90	12	18	-	-	-10	8	2	-	56300	✓	0.09	GI276	SQ010
12A3R018A12-SAD07D-C	12	90	12	18	-	-	-10	8	3	-	56200	✓	0.09	GI276	SQ010
12A3R020A12-SAD07D-CF	12	90	12	20	-	-	-10	8	3	-	56200	✓	0.09	GI276	SQ010
14A3R018A12-SAD07D-C	14	140	12	18	-	-	-9	8	3	-	52100	✓	0.13	GI276	SQ010
14A3R018A14-SAD07D-C	14	90	14	18	-	-	-9	8	3	-	52100	✓	0.11	GI276	SQ010
14A3R020A12-SAD07D-CF	14	140	12	20	-	-	-9	8	3	-	52100	✓	0.14	GI276	SQ010
14A3R020A14-SAD07D-CF	14	90	14	20	-	-	-9	8	3	-	52100	✓	0.11	GI276	SQ010
16A3R019A14-SAD07D-C	16	160	14	19	-	-	-8	8	3	-	48700	✓	0.21	GI276	SQ011
16A3R019A16-SAD07D-C	16	110	16	19	-	-	-8	8	3	-	48700	✓	0.18	GI276	SQ011
16A4R019A16-SAD07D-C	16	110	16	19	-	-	-8	8	4	-	48700	✓	0.18	GI276	SQ011
18A4R019A16-SAD07D-C	18	180	16	19	-	-	-7.5	8	4	✓	45900	✓	0.28	GI276	SQ011
18A4R019A18-SAD07D-C	18	110	18	19	-	-	-7.5	8	4	✓	45900	✓	0.22	GI276	SQ011
20A4R020A18-SAD07D-C	20	200	18	20	-	-	-7	8	4	✓	43600	✓	0.37	GI276	SQ011
20A4R020A20-SAD07D-C	20	125	20	20	-	-	-7	8	4	✓	43600	✓	0.29	GI276	SQ011
20A5R020A20-SAD07D-C	20	125	20	20	-	-	-7	8	5	✓	43600	✓	0.30	GI276	SQ011
25A5R024A25-SAD07D-C	25	140	25	24	-	-	-6.5	8	5	✓	39000	✓	0.51	GI276	SQ011
25A6R024A25-SAD07D-C	25	140	25	24	-	-	-6.5	8	6	✓	39000	✓	0.51	GI276	SQ011
12A2R020M06-SAD07D-C	12	35	6.5	-	20	M6	-10	8	2	-	-	✓	0.04	GI276	SQ010
14A3R020M08-SAD07D-C	14	38	8.5	-	20	M8	-9	8	3	-	-	✓	0.04	GI276	SQ010
14A3R023M08-SAD07D-CF	14	41	8.5	-	23	M8	-9	8	3	-	-	✓	0.05	GI276	SQ010
16A4R023M08-SAD07D-C	16	41	8.5	-	23	M8	-8	8	4	✓	-	✓	0.05	GI276	SQ011
20A5R030M10-SAD07D-C	20	49	10.5	-	30	M10	-7	8	5	✓	-	✓	0.08	GI276	SQ011

Produkt	DC	OAL	DCONIMS	LU	LF	TDZ	GAMF	GAMP								
	(mm)	(mm)	(mm)	(mm)	(mm)		(°)	(°)								
25A6R035M12-SAD07D-C	25	57	12.5	-	35	M12	-6.5	8	6	✓	-	✓	0.13	GI276	SQ011	
32A8R043M16-SAD07D-C	32	66	17	-	43	M16	-6	8	8	✓	-	✓	0.24	GI276	SQ011	

GI276	ADMX 0702..	ADEX 0702..

SQ010	US 62003A-T06P	0.6	M 2	3	Flag T06P
SQ011	US 62004A-T06P	0.6	M 2	4	Flag T06P

ADMX 07



	W1	D1	L	S
	(mm)	(mm)	(mm)	(mm)
0702	4.482	2.20	6.95	2.48

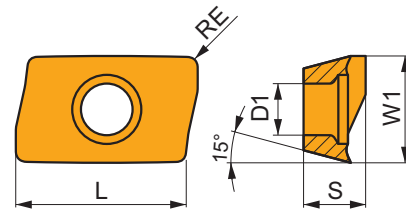

Eignung und Startwerte für Schnittgeschwindigkeit (vc), Vorschub (f) und Schnitttiefe (ap). Weitere Informationen finden Sie in unserer Zerspanungsrechner-App.

Produkt		P			M			K			N			S			H		
		vc	f	ap	vc	f	ap	vc	f	ap	vc	f	ap	vc	f	ap	vc	f	ap
	(mm)	(m/min)	(mm/tooth)	(mm)	(m/min)	(mm/tooth)	(mm)	(m/min)	(mm/tooth)	(mm)	(m/min)	(mm/tooth)	(mm)	(m/min)	(mm/tooth)	(mm)	(m/min)	(mm/tooth)	(mm)

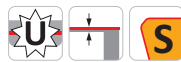
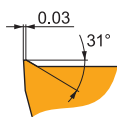

F geometrie mit sehr scharfen und positiven Design zur leichten Bearbeitung.

ADMX 070202SR-F:M8330	●	0.2	220	0.07	2.0	130	0.06	2.0	-	-	-	660	0.08	2.0	55	0.05	1.6	-	-	-
ADMX 070204SR-F:M6330	●	0.4	200	0.07	2.0	140	0.06	2.0	-	-	-	-	-	-	60	0.05	1.6	-	-	-
ADMX 070204SR-F:M8330	●	0.4	235	0.07	2.0	140	0.06	2.0	-	-	-	705	0.08	2.0	55	0.05	1.6	-	-	-
ADMX 070204SR-F:M8340	●	0.4	215	0.07	2.0	125	0.06	2.0	-	-	-	-	-	-	50	0.05	1.6	-	-	-
ADMX 070208SR-F:M8310	⊕	0.8	320	0.07	2.0	160	0.06	2.0	-	-	-	-	-	-	-	-	-	-	-	-
ADMX 070208SR-F:M8330	⊕	0.8	280	0.07	2.0	165	0.06	2.0	-	-	-	840	0.08	2.0	70	0.05	1.6	-	-	-
ADMX 070208SR-F:M8340	⊕	0.8	255	0.07	2.0	150	0.06	2.0	-	-	-	-	-	-	60	0.05	1.6	-	-	-

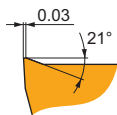

M geometrie mit positiven Design zur leichten bis mittleren Bearbeitung.

ADMX 070202SR-M:M8330	●	0.2	205	0.09	2.2	120	0.08	2.2	190	0.09	2.2	615	0.11	2.2	50	0.06	1.8	-	-	-
ADMX 070202SR-M:M8340	●	0.2	185	0.09	2.2	110	0.08	2.2	175	0.09	2.2	-	-	-	45	0.06	1.8	-	-	-
ADMX 070204SR-M:8215	●	0.4	225	0.09	2.2	135	0.08	2.2	210	0.09	2.2	675	0.11	2.2	55	0.06	1.8	-	-	-
ADMX 070204SR-M:M6330	●	0.4	190	0.09	2.2	135	0.08	2.2	-	-	-	-	-	-	55	0.06	1.8	-	-	-
ADMX 070204SR-M:M8310	●	0.4	245	0.09	2.2	120	0.08	2.2	230	0.09	2.2	-	-	-	-	-	-	-	-	-
ADMX 070204SR-M:M8330	●	0.4	220	0.09	2.2	130	0.08	2.2	205	0.09	2.2	660	0.11	2.2	55	0.06	1.8	-	-	-
ADMX 070204SR-M:M8340	●	0.4	200	0.09	2.2	120	0.08	2.2	190	0.09	2.2	-	-	-	50	0.06	1.8	-	-	-
ADMX 070204SR-M:M9340	●	0.4	265	0.09	2.2	155	0.08	2.2	-	-	-	-	-	-	65	0.06	1.8	-	-	-
ADMX 070208SR-M:8215	⊕	0.8	270	0.09	2.2	160	0.08	2.2	255	0.09	2.2	810	0.11	2.2	65	0.06	1.8	-	-	-

Eignung und Startwerte für Schnittgeschwindigkeit (vc), Vorschub (f) und Schnitttiefe (ap). Weitere Informationen finden Sie in unserer Zerspanungsrechner-App.

Produkt	RE (mm)	P			M			K			N			S			H		
		vc (m/min)	f (mm/tooth)	ap (mm)	vc (m/min)	f (mm/tooth)	ap (mm)	vc (m/min)	f (mm/tooth)	ap (mm)	vc (m/min)	f (mm/tooth)	ap (mm)	vc (m/min)	f (mm/tooth)	ap (mm)	vc (m/min)	f (mm/tooth)	ap (mm)

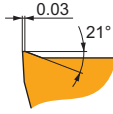

M geometrie mit positiven Design zur leichten bis mittleren Bearbeitung.

ADMX 070208SR-M:M6330	0.8	225	0.09	2.2	160	0.08	2.2	-	-	-	-	-	-	65	0.06	1.8	-	-	-
ADMX 070208SR-M:M8310	0.8	290	0.09	2.2	145	0.08	2.2	275	0.09	2.2	-	-	-	-	-	-	-	-	-
ADMX 070208SR-M:M8330	0.8	260	0.09	2.2	155	0.08	2.2	245	0.09	2.2	780	0.11	2.2	65	0.06	1.8	-	-	-
ADMX 070208SR-M:M8340	0.8	240	0.09	2.2	140	0.08	2.2	225	0.09	2.2	-	-	-	60	0.06	1.8	-	-	-
ADMX 070208SR-M:M9340	0.8	315	0.09	2.2	185	0.08	2.2	-	-	-	-	-	-	75	0.06	1.8	-	-	-
ADMX 070216SR-M:M8330	1.6	290	0.09	2.2	170	0.08	2.2	275	0.09	2.2	870	0.11	2.2	70	0.06	1.8	-	-	-
ADMX 070220SR-M:M8310	2.0	340	0.09	2.2	170	0.08	2.2	320	0.09	2.2	-	-	-	-	-	-	-	-	-
ADMX 070220SR-M:M8330	2.0	300	0.09	2.2	180	0.08	2.2	285	0.09	2.2	900	0.11	2.2	75	0.06	1.8	-	-	-
ADMX 070220SR-M:M8340	2.0	275	0.09	2.2	165	0.08	2.2	260	0.09	2.2	-	-	-	65	0.06	1.8	-	-	-

ADEX 07-FA



	W1 (mm)	D1 (mm)	L (mm)	S (mm)
0702	4.497	2.20	6.95	2.48

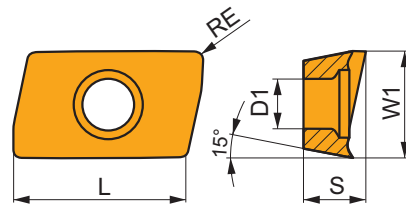

Eignung und Startwerte für Schnittgeschwindigkeit (vc), Vorschub (f) und Schnitttiefe (ap). Weitere Informationen finden Sie in unserer Zerspanungsrechner-App.

Produkt	RE (mm)	P			M			K			N			S			H		
		vc (m/min)	f (mm/tooth)	ap (mm)	vc (m/min)	f (mm/tooth)	ap (mm)	vc (m/min)	f (mm/tooth)	ap (mm)	vc (m/min)	f (mm/tooth)	ap (mm)	vc (m/min)	f (mm/tooth)	ap (mm)	vc (m/min)	f (mm/tooth)	ap (mm)

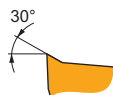

FA geometrie mit hoch positiven Design zur feinen Schlichtbearbeitung bis zur mittleren Bearbeitung.

ADEX 070204FR-FA:HF7	0.4	-	-	-	-	-	-	-	-	-	240	0.18	3.0	-	-	-	-	-	-
ADEX 070204FR-FA:M0315	0.4	-	-	-	-	-	-	-	-	-	555	0.18	3.0	-	-	-	-	-	-
ADEX 070208FR-FA:HF7	0.8	-	-	-	-	-	-	-	-	-	285	0.18	3.0	-	-	-	-	-	-

ADEX 07-HF



	W1 (mm)	D1 (mm)	L (mm)	S (mm)
0702	4.439	2.20	6.45	2.48

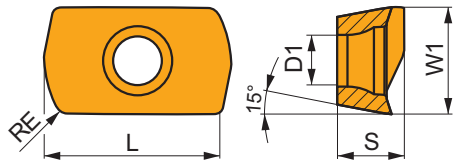

Eignung und Startwerte für Schnittgeschwindigkeit (vc), Vorschub (f) und Schnitttiefe (ap). Weitere Informationen finden Sie in unserer Zerspanungsrechner-App.

Produkt	RE (mm)	P			M			K			N			S			H		
		vc (m/min)	f (mm/tooth)	ap (mm)	vc (m/min)	f (mm/tooth)	ap (mm)	vc (m/min)	f (mm/tooth)	ap (mm)	vc (m/min)	f (mm/tooth)	ap (mm)	vc (m/min)	f (mm/tooth)	ap (mm)	vc (m/min)	f (mm/tooth)	ap (mm)

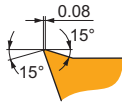

HF geometrie mit sehr positiven Design für die Hochvorschubbearbeitung.

ADEX 070206SR-HF:M6330	0.6	200	0.60	0.3	140	0.54	0.3	-	-	-	-	-	-	-	-	-	-	-
ADEX 070206SR-HF:M8330	0.6	225	0.60	0.3	135	0.54	0.3	-	-	-	-	-	-	-	-	-	-	-
ADEX 070206SR-HF:M8340	0.6	215	0.60	0.3	125	0.54	0.3	-	-	-	-	-	-	-	-	-	-	-



a_e / DC	5%	10%	15%	20%	25%	30%	40%	50%	60%	70%	75%	80%	90%	100%
	1.48	1.35	1.27	1.22	1.19	1.16	1.11	1.08	1.05	1.03	1.00	1.00	1.00	1.00
	2.20	1.60	1.35	1.20	1.10	0.95	0.85	0.75	0.85	0.95	1.00	1.00	1.00	1.00
	0.64	0.64	0.64	0.64	0.64	0.65	0.65	0.67	0.68	0.71	0.72	0.74	0.79	1.00

	ADMX 07-F			ADMX 07-M					ADEX 07-HF	ADEX 07-FA	
	0.2	0.4	0.8	0.2	0.4	0.8	1.6	2.0	0.6	0.4	0.8
	1.38	0.89	0.54	1.38	0.89	0.54	0.7	0.33	-	0.94	0.55

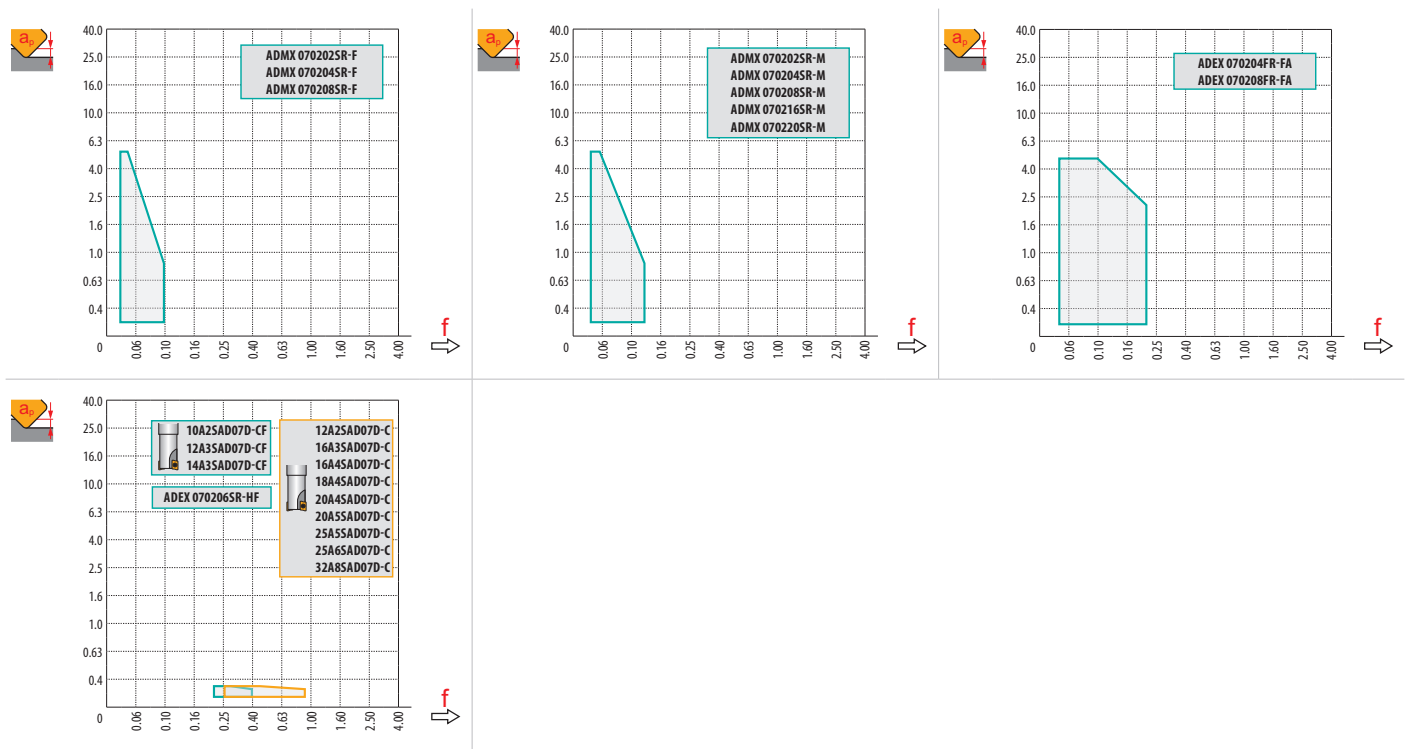

ADEX 07-HF					
		0	0.1	0.2	0.3
10		5.6	7.8	8.7	9.4
12		7.6	9.8	10.7	11.4
14		9.6	11.8	12.7	13.4
16		11.6	13.8	14.7	15.4
18		13.6	15.8	16.7	17.4
20		15.6	17.8	18.7	19.4
25		20.6	22.8	23.7	24.4
32		27.6	29.8	30.7	31.4

HFC			
	0.1	0.2	0.3
	0.9	0.8	0.6

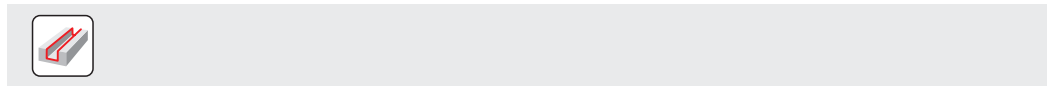
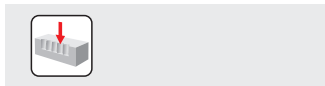

	max
	3.0

	1.0	3.0	5.0
	0.13	0.08	0.05

	HFC		
	0.1	0.2	0.3
	0.7	0.6	0.4



	RPMX	APMX/l
10	5.2°	5.0/56
12	3.4°	5.0/86
14	2.5°	4.2/100
16	1.9°	3.2/100
18	1.7°	2.8/100
20	1.5°	2.5/100
25	1.1°	1.8/100
32	0.8°	1.2/100

HFC		
	RPMX	APMX/l
10	3.5°	0.3/6
12	2.2°	0.3/9
14	1.6°	0.3/12
16	1.3°	0.3/15
18	1.1°	0.3/17
20	0.9°	0.3/21
25	0.7°	0.3/26
32	0.5°	0.3/36



	DMIN	DMAX		
10	12.0	20.0	0.5	2.8
12	16.0	24.0	0.7	2.2
14	20.0	28.0	0.8	1.9
16	24.0	32.0	0.8	1.6
18	28.0	36.0	0.9	1.6
20	32.0	40.0	0.9	1.6
25	42.0	50.0	1.0	1.5
32	56.0	64.0	1.0	1.4

HFC				
	DMIN	DMAX		
10	12	20	0.30	0.30
12	16	24	0.30	0.30
14	20	28	0.30	0.30
16	24	32	0.30	0.30
18	28	36	0.30	0.30
20	32	40	0.30	0.30
25	42	50	0.30	0.30
32	56	64	0.30	0.30



	0.5
--	-----

	HFC
	0.3



		3	5	10	15	20	30	40	50	60	80	100
10		0.346	0.447	0.632	0.775	0.894	1.095	1.265	1.414	1.549	1.789	2.000
12		0.379	0.490	0.693	0.849	0.980	1.200	1.386	1.549	1.697	1.960	2.191
14		0.410	0.529	0.748	0.917	1.058	1.296	1.497	1.673	1.833	2.117	2.366
16		0.438	0.566	0.800	0.980	1.131	1.386	1.600	1.789	1.960	2.263	2.530
18		0.465	0.600	0.849	1.039	1.200	1.470	1.697	1.897	2.078	2.400	2.683
20		0.490	0.632	0.894	1.095	1.265	1.549	1.789	2.000	2.191	2.530	2.828
25		0.548	0.707	1.000	1.225	1.414	1.732	2.000	2.236	2.449	2.828	3.162
32		0.620	0.800	1.131	1.386	1.600	1.960	2.263	2.530	2.771	3.200	3.578

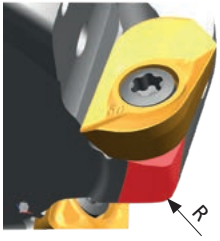

ADMX 07	R
ADMX 070216SR-M	1
ADMX 070220SR-M	1.5
ADEX 070206SR-HF	1

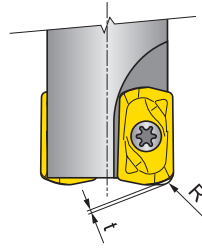

ADEX 07	R	t
ADEX 070206SR-HF	0.8	0.18

SAD11E



PRAMET



FORCE AD11 Eckfräser mit Innenkühlung

90° Schafffräser und Messerköpfe mit positiven AD.. 11 Wendeschneidplatten mit APMX von 9 mm. Geeignet fürs Plan-, Schulter-, Nut-, Helix-, Trochoiden-, Rampen- und Tauchfräsen. Erhältlich mit zylindrischem, Weldon, Morsekegel-, modularem Schaft und als Aufsteckfräser (mit ungleicher Teilung). Für längere Standzeiten ist der Körper oberflächenbehandelt.

FORCE AD

KAPR	90°
APMX	9.0 mm

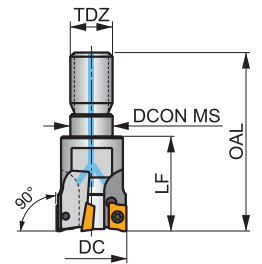
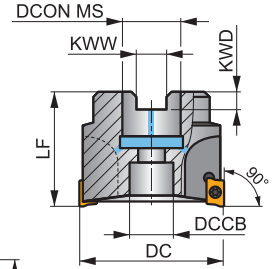
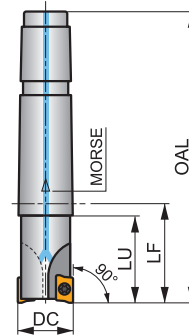
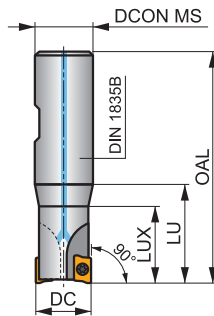
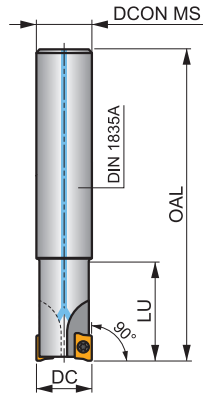
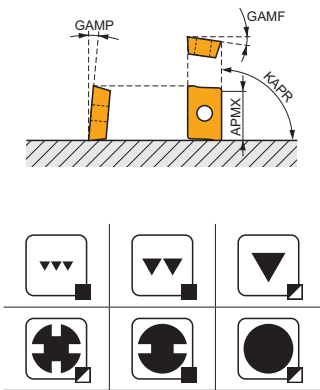

	0.06 – 0.13
	0.08 – 0.16



Produkt	DC	OAL	DCON MS	DCCB	LU	LUX	LF	TDZ	CZC MS	KWW	KWD	GAMF	GAMP	max.			kg	Tools		
	(mm)	(mm)	(mm)	(mm)	(mm)	(mm)	(mm)	(mm)	(mm)	(mm)	(mm)	(°)	(°)							
16A2R024A14-SAD11E-C	16	160	14	-	24	-	-	-	-	-	-	-12.8	4	2	-	30100	✓	0.19	GI169 SQ025	-
16A2R024A16-SAD11E-C	16	135	16	-	24	-	-	-	-	-	-	-12.8	4	2	-	30100	✓	0.19	GI169 SQ025	-
16A2R050A16-SAD11E-C	16	135	16	-	50	-	-	-	-	-	-	-12.8	4	2	-	30100	✓	0.20	GI169 SQ025	-
18A2R029A20-SAD11E-C	18	150	20	-	29	-	-	-	-	-	-	-12	4.5	2	-	28400	✓	0.35	GI169 SQ025	-
20A2R029A20-SAD11E-C	20	150	20	-	29	-	-	-	-	-	-	-11.5	5	2	-	27000	✓	0.33	GI169 SQ020	-
20A2R070A20-SAD11E-C	20	150	20	-	70	-	-	-	-	-	-	-11.5	5	2	-	27000	✓	0.32	GI169 SQ020	-
20A3R029A18-SAD11E-C	20	200	18	-	29	-	-	-	-	-	-	-11.5	5	3	-	27000	✓	0.36	GI169 SQ025	-
20A3R029A20-SAD11E-C	20	150	20	-	29	-	-	-	-	-	-	-11.5	5	3	-	27000	✓	0.31	GI169 SQ025	-
22A3R029A20-SAD11E-C	22	200	20	-	29	-	-	-	-	-	-	-11.5	5	3	-	25600	✓	0.45	GI169 SQ025	-
25A3R034A25-SAD11E-C	25	170	25	-	34	-	-	-	-	-	-	-10.2	5	3	-	24100	✓	0.42	GI169 SQ020	-
25A3R080A25-SAD11E-C	25	170	25	-	80	-	-	-	-	-	-	-10.2	5	3	-	24100	✓	0.52	GI169 SQ020	-
25A4R034A25-SAD11E-C	25	170	25	-	34	-	-	-	-	-	-	-10.2	5	4	-	24100	✓	0.56	GI169 SQ025	-
25A4R040A25-SAD11E-C	25	250	25	-	40	-	-	-	-	-	-	-10.2	5	4	-	24100	✓	0.85	GI169 SQ025	-
30A3R080A32-SAD11E-C	30	200	32	-	80	-	-	-	-	-	-	-9.3	7	3	-	22000	✓	0.98	GI169 SQ020	-
32A3R090A32-SAD11E-C	32	195	32	-	90	-	-	-	-	-	-	-9	5	3	-	21300	✓	0.99	GI169 SQ020	-
32A5R034A32-SAD11E-C	32	195	32	-	34	-	-	-	-	-	-	-9	8	5	-	21300	✓	1.03	GI169 SQ025	-
35A5R025A32-SAD11E-C	35	200	32	-	25	-	-	-	-	-	-	-9	8	5	-	20300	✓	1.11	GI169 SQ020	-
16A2R027B16-SAD11E-C	16	75	16	-	27	-	-	-	-	-	-	-12.8	4	2	-	30100	✓	0.11	GI169 SQ025	-
20A2R032B20-SAD11E-C	20	82	20	-	32	-	-	-	-	-	-	-11.5	5	2	-	27000	✓	0.13	GI169 SQ020	-
20A3R032B20-SAD11E-C	20	82	20	-	32	-	-	-	-	-	-	-11.5	5	3	-	27000	✓	0.13	GI169 SQ025	-
25A3R042B25-SAD11E-C	25	98	25	-	42	-	-	-	-	-	-	-10.2	5	3	-	24100	✓	0.29	GI169 SQ020	-
25A4R042B25-SAD11E-C	25	98	25	-	42	-	-	-	-	-	-	-10.2	5	4	-	24100	✓	0.31	GI169 SQ025	-
32A4R042B32-SAD11E-C	32	102	32	-	42	-	-	-	-	-	-	-9	8	4	-	21300	✓	0.27	GI169 SQ020	-
32A5R042B32-SAD11E-C	32	102	32	-	42	-	-	-	-	-	-	-9	8	5	-	21300	✓	0.32	GI169 SQ025	-
16A2R030E02-SAD11E-C	16	94	-	-	25	-	30	-	2	-	-	-12.8	4	2	-	30100	✓	0.13	GI169 SQ025	-
20A3R035E03-SAD11E-C	20	116	-	-	30	-	35	-	3	-	-	-11.5	5	3	-	27000	✓	0.27	GI169 SQ025	-
25A4R043E03-SAD11E-C	25	124	-	-	38	-	43	-	3	-	-	-10.2	5	4	-	24100	✓	0.31	GI169 SQ025	-

Produkt	DC	OAL	D CON MS	DCCB	LU	LUX	LF	TDZ	CZC MS	KWW	KWD	GAMF	GAMP								
	(mm)	(mm)	(mm)	(mm)	(mm)	(mm)	(mm)			(mm)	(mm)	(°)	(°)								
16A2R024M08-SAD11E-C	16	38	8.5	-	-	-	24	M8	-	-	-	-12.8	4	2	-	-	✓	0.04	GI169	SQ025	-
20A2R026M10-SAD11E-C	20	45	11	-	-	-	26	M10	-	-	-	-11.5	5	2	-	-	✓	0.06	GI169	SQ020	-
20A3R026M10-SAD11E-C	20	45	10.5	-	-	-	26	M10	-	-	-	-11.5	5	3	-	-	✓	0.06	GI169	SQ025	-
25A3R033M12-SAD11E-C	25	55	12.5	-	-	-	33	M12	-	-	-	-10.2	5	3	-	-	✓	0.10	GI169	SQ020	-
25A4R033M12-SAD11E-C	25	55	12.5	-	-	-	33	M12	-	-	-	-10.2	5	4	-	-	✓	0.09	GI169	SQ025	-
32A4R043M16-SAD11E-C	32	66	17	-	-	-	43	M16	-	-	-	-9	8	4	-	-	✓	0.20	GI169	SQ020	-
32A5R043M16-SAD11E-C	32	66	17	-	-	-	43	M16	-	-	-	-9	8	5	-	-	✓	0.20	GI169	SQ025	-
40A4R043M16-SAD11E-C	40	66	17	-	-	-	43	M16	-	-	-	-8.1	11	4	-	-	✓	0.27	GI169	SQ020	-
40A6R043M16-SAD11E-C	40	66	17	-	-	-	43	M16	-	-	-	-8.1	11	6	-	-	✓	0.21	GI169	SQ020	-
40A04R-S90AD11E-C	40	-	16	14	-	-	40	-	-	8.4	5.6	-8.1	11	4	✓	19100	✓	0.16	GI169	SQ022	-
40A05R-S90AD11E-C	40	-	16	14	-	-	40	-	-	8.4	5.6	-8.1	11	5	✓	19000	✓	0.31	GI169	SQ022	-
40A06R-S90AD11E-C	40	-	16	14	-	-	40	-	-	8.4	5.6	-8.1	11	6	✓	19100	✓	0.20	GI169	SQ022	-
50A05R-S90AD11E-C	50	-	22	18	-	-	40	-	-	10.4	6.3	-7.2	12	5	✓	17000	✓	0.31	GI169	SQ023	-
50A07R-S90AD11E-C	50	-	22	18	-	-	40	-	-	10.4	6.3	-7.2	12	7	✓	17000	✓	0.44	GI169	SQ023	-
63A06R-S90AD11E-C	63	-	22	18	-	-	40	-	-	10.4	6.3	-6.5	12	6	✓	15200	✓	0.54	GI169	SQ023	-
63A09R-S90AD11E-C	63	-	22	18	-	-	40	-	-	10.4	6.3	-6.5	12	9	✓	15200	✓	0.61	GI169	SQ023	-
80A10R-S90AD11E-C	80	-	27	38	-	-	50	-	-	12.4	7	-6	12	10	✓	13500	✓	1.04	GI169	SQ021	AC001
100A11R-S90AD11E-C	100	-	32	45	-	-	50	-	-	14.4	8	-5.5	12	11	✓	12100	✓	1.89	GI169	SQ021	AC002
125A12R-S90AD11E-C	125	-	40	56	-	-	63	-	-	16.4	9	-5.2	12	12	✓	10800	✓	2.97	GI169	SQ021	AC003

GI169	ADMX 11T3..	ADEX 11T3..

SQ020	US 62506-T07P	1.2	M 2.5	6	-	-	Flag T07P	-
SQ021	US 62506-T07P	1.2	M 2.5	6	D-T07P/T09P	FG-15	-	-
SQ022	US 62506-T07P	1.2	M 2.5	6	D-T07P/T09P	FG-15	-	HS 0830C
SQ023	US 62506-T07P	1.2	M 2.5	6	D-T07P/T09P	FG-15	-	HS 1030C
SQ025	US 62505-T07P	1.2	M 2.5	5	-	-	Flag T07P	-

AC001		KS 1230	K.FMH27
AC002		KS 1635	K.FMH32
AC003		KS 2040	K.FMH40

Eignung und Startwerte für Schnittgeschwindigkeit (vc), Vorschub (f) und Schnitttiefe (ap). Weitere Informationen finden Sie in unserer Zerspanungsrechner-App.

Produkt	RE (mm)	P			M			K			N			S			H		
		vc (m/min)	f (mm/tooth)	ap (mm)	vc (m/min)	f (mm/tooth)	ap (mm)	vc (m/min)	f (mm/tooth)	ap (mm)	vc (m/min)	f (mm/tooth)	ap (mm)	vc (m/min)	f (mm/tooth)	ap (mm)	vc (m/min)	f (mm/tooth)	ap (mm)

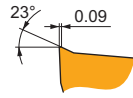
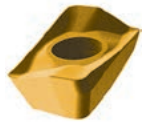

M geometrie mit positiven Design zur leichten bis mittleren Bearbeitung.

ADMX 11T325SR-M:M6330	2.5	240	0.15	4.0	170	0.14	4.0	-	-	-	-	-	-	70	0.12	3.2	-	-	-
ADMX 11T325SR-M:M8340	2.5	255	0.15	4.0	150	0.14	4.0	240	0.15	4.0	-	-	-	60	0.12	3.2	-	-	-
ADMX 11T330SR-M:M6330	3.0	240	0.15	4.0	170	0.14	4.0	-	-	-	-	-	-	70	0.12	3.2	-	-	-
ADMX 11T330SR-M:M8330	3.0	280	0.15	4.0	165	0.14	4.0	265	0.15	4.0	-	-	-	70	0.12	3.2	-	-	-
ADMX 11T330SR-M:M8340	3.0	255	0.15	4.0	150	0.14	4.0	240	0.15	4.0	-	-	-	60	0.12	3.2	-	-	-

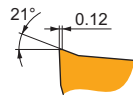
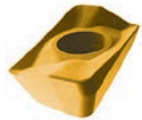

R geometrie mit positiven Design für weniger stabile Bearbeitungsbedingungen.

ADMX 11T308PR-R:R215	0.8	230	0.18	4.0	135	0.16	4.0	215	0.18	4.0	-	-	-	55	0.16	3.2	45	0.12	0.7
ADMX 11T308PR-R:M5315	0.8	310	0.18	4.0	-	-	-	290	0.18	4.0	-	-	-	-	-	-	60	0.13	0.7
ADMX 11T308PR-R:M8310	0.8	250	0.18	4.0	125	0.16	4.0	235	0.18	4.0	-	-	-	-	-	-	50	0.12	0.7
ADMX 11T308PR-R:M8330	0.8	230	0.18	4.0	135	0.16	4.0	215	0.18	4.0	-	-	-	55	0.16	3.2	45	0.12	0.7
ADMX 11T308PR-R:M8340	0.8	210	0.18	4.0	125	0.16	4.0	195	0.18	4.0	-	-	-	50	0.16	3.2	-	-	-
ADMX 11T308PR-R:M9315	0.8	310	0.18	4.0	-	-	-	290	0.18	4.0	-	-	-	-	-	-	60	0.13	0.7
ADMX 11T308PR-R:M9325	0.8	290	0.18	4.0	-	-	-	275	0.18	4.0	-	-	-	-	-	-	55	0.13	0.7
ADMX 11T316PR-R:R215	1.6	255	0.18	4.0	150	0.16	4.0	240	0.18	4.0	-	-	-	60	0.16	3.2	50	0.12	0.7
ADMX 11T316PR-R:M8330	1.6	255	0.18	4.0	150	0.16	4.0	240	0.18	4.0	-	-	-	60	0.16	3.2	50	0.12	0.7
ADMX 11T316PR-R:M9325	1.6	320	0.18	4.0	-	-	-	300	0.18	4.0	-	-	-	-	-	-	60	0.12	0.7

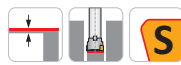
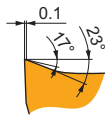

MF geometrie mit hoch positiven Design zur leichten bis zur Schlichtbearbeitung.

ADMX 11T304SR-MF:M6330	0.4	215	0.08	2.5	150	0.07	2.5	-	-	-	-	-	-	60	0.06	2.0	-	-	-
ADMX 11T304SR-MF:M8340	0.4	220	0.08	2.5	130	0.07	2.5	-	-	-	-	-	-	55	0.06	2.0	-	-	-
ADMX 11T308SR-MF:M6330	0.8	255	0.08	2.5	180	0.07	2.5	-	-	-	-	-	-	75	0.06	2.0	-	-	-
ADMX 11T308SR-MF:M8340	0.8	265	0.08	2.5	155	0.07	2.5	-	-	-	-	-	-	65	0.06	2.0	-	-	-

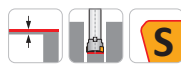
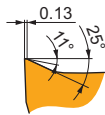

MM geometrie mit sehr positiven Design zur leichten bis mittleren Bearbeitung.

ADMX 11T304SR-MM:M6330	0.4	185	0.14	2.5	130	0.13	2.5	-	-	-	-	-	-	55	0.11	2.0	-	-	-
ADMX 11T304SR-MM:M8340	0.4	195	0.14	2.5	115	0.13	2.5	-	-	-	-	-	-	45	0.11	2.0	-	-	-
ADMX 11T308SR-MM:M6330	0.8	225	0.14	2.5	155	0.13	2.5	-	-	-	-	-	-	65	0.11	2.0	-	-	-
ADMX 11T308SR-MM:M8340	0.8	235	0.14	2.5	140	0.13	2.5	-	-	-	-	-	-	55	0.11	2.0	-	-	-
ADMX 11T308SR-MM:M8345	0.8	190	0.14	2.5	110	0.13	2.5	-	-	-	-	-	-	45	0.11	2.0	-	-	-
ADMX 11T308SR-MM:M9340	0.8	300	0.14	2.5	180	0.13	2.5	-	-	-	-	-	-	75	0.11	2.0	-	-	-
ADMX 11T312SR-MM:M6330	1.2	235	0.14	2.5	165	0.13	2.5	-	-	-	-	-	-	70	0.11	2.0	-	-	-
ADMX 11T312SR-MM:M8340	1.2	245	0.14	2.5	145	0.13	2.5	-	-	-	-	-	-	60	0.11	2.0	-	-	-

ADEX 11-FA



	W1	D1	L	S
	(mm)	(mm)	(mm)	(mm)
11T3	6.450	2.90	9.70	3.91

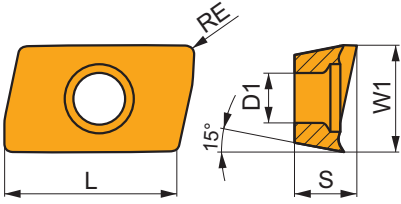

Eignung und Startwerte für Schnittgeschwindigkeit (vc), Vorschub (f) und Schnitttiefe (ap). Weitere Informationen finden Sie in unserer Zerspanungsrechner-App.

Produkt	RE (mm)	P			M			K			N			S			H		
		vc	f	ap	vc	f	ap	vc	f	ap	vc	f	ap	vc	f	ap	vc	f	ap
		(m/min)	(mm/tooth)	(mm)	(m/min)	(mm/tooth)	(mm)	(m/min)	(mm/tooth)	(mm)	(m/min)	(mm/tooth)	(mm)	(m/min)	(mm/tooth)	(mm)	(m/min)	(mm/tooth)	(mm)

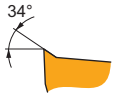

FA geometrie mit hoch positiven Design zur feinen Schlichtbearbeitung bis zur mittleren Bearbeitung.

ADEX 11T304FR-FA:HF7	● 0.4	-	-	-	-	-	-	-	-	-	■ 210	0.30	5.0	-	-	-	-	-	-
ADEX 11T304FR-FA:M0315	● 0.4	-	-	-	-	-	-	-	-	-	■ 480	0.30	5.0	-	-	-	-	-	-
ADEX 11T308FR-FA:HF7	● 0.8	-	-	-	-	-	-	-	-	-	■ 240	0.30	5.0	-	-	-	-	-	-
ADEX 11T308FR-FA:M0315	● 0.8	-	-	-	-	-	-	-	-	-	■ 570	0.30	5.0	-	-	-	-	-	-
ADEX 11T312FR-FA:HF7	● 1.2	-	-	-	-	-	-	-	-	-	■ 255	0.30	5.0	-	-	-	-	-	-
ADEX 11T316FR-FA:HF7	● 1.6	-	-	-	-	-	-	-	-	-	■ 270	0.18	5.0	-	-	-	-	-	-

ADEX 11-HF



	W1	D1	L	S
	(mm)	(mm)	(mm)	(mm)
11T3	6.450	2.90	10.67	3.82

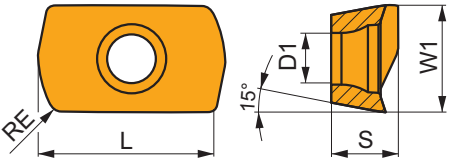

Eignung und Startwerte für Schnittgeschwindigkeit (vc), Vorschub (f) und Schnitttiefe (ap). Weitere Informationen finden Sie in unserer Zerspanungsrechner-App.

Produkt	RE (mm)	P			M			K			N			S			H		
		vc	f	ap	vc	f	ap	vc	f	ap	vc	f	ap	vc	f	ap	vc	f	ap
		(m/min)	(mm/tooth)	(mm)	(m/min)	(mm/tooth)	(mm)	(m/min)	(mm/tooth)	(mm)	(m/min)	(mm/tooth)	(mm)	(m/min)	(mm/tooth)	(mm)	(m/min)	(mm/tooth)	(mm)

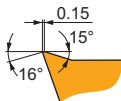

HF geometrie mit sehr positiven Design für die Hochvorschubbearbeitung.

ADEX 11T308SR-HF:8215	● 0.8	■ 215	0.68	0.4	■ 125	0.61	0.4	-	-	-	-	-	-	-	-	-	-	-	-
ADEX 11T308SR-HF:M6330	● 0.8	■ 185	0.68	0.4	■ 130	0.61	0.4	-	-	-	-	-	-	-	-	-	-	-	-
ADEX 11T308SR-HF:M8310	● 0.8	■ 220	0.68	0.4	■ 110	0.52	0.4	-	-	-	-	-	-	-	-	-	-	-	-
ADEX 11T308SR-HF:M8330	● 0.8	■ 215	0.68	0.4	■ 125	0.61	0.4	-	-	-	-	-	-	-	-	-	-	-	-
ADEX 11T308SR-HF:M8340	● 0.8	■ 200	0.68	0.4	■ 120	0.61	0.4	-	-	-	-	-	-	-	-	-	-	-	-
ADEX 11T308SR-HF:M9340	● 0.8	■ 220	0.68	0.4	■ 130	0.61	0.4	-	-	-	-	-	-	-	-	-	-	-	-

Eignung und Startwerte für Schnittgeschwindigkeit (vc), Vorschub (f) und Schnitttiefe (ap). Weitere Informationen finden Sie in unserer Zerspanungsrechner-App.

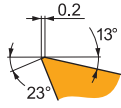

Produkt	RE (mm)	P			M			K			N			S			H		
		vc (m/min)	f (mm/tooth)	ap (mm)	vc (m/min)	f (mm/tooth)	ap (mm)	vc (m/min)	f (mm/tooth)	ap (mm)	vc (m/min)	f (mm/tooth)	ap (mm)	vc (m/min)	f (mm/tooth)	ap (mm)	vc (m/min)	f (mm/tooth)	ap (mm)









HF2 geometrie mit positiven Design für die Hochvorschubbearbeitung.

ADEX 11T308SR-HF2:M8310	0.8	220	0.68	0.4	110	0.61	0.4	205	0.68	0.4	–	–	–	–	–	–	40	0.48	0.3
ADEX 11T308SR-HF2:M8330	0.8	215	0.68	0.4	125	0.61	0.4	200	0.68	0.4	–	–	–	50	0.48	0.3	40	0.48	0.3
ADEX 11T308SR-HF2:M8340	0.8	200	0.68	0.4	120	0.61	0.4	190	0.68	0.4	–	–	–	50	0.48	0.3	–	–	–
ADEX 11T308SR-HF2:M9325	0.8	250	0.68	0.4	–	–	–	235	0.68	0.4	–	–	–	–	–	–	50	0.48	0.3



a_e / DC	5 %	10 %	15 %	20 %	25 %	30 %	40 %	50 %	60 %	70 %	75 %	80 %	90 %	100 %
	1.48	1.35	1.27	1.22	1.19	1.16	1.11	1.08	1.05	1.03	1.00	1.00	1.00	1.00
	2.20	1.60	1.35	1.20	1.10	0.95	0.85	0.75	0.85	0.95	1.00	1.00	1.00	1.00
	0.64	0.64	0.64	0.64	0.64	0.65	0.65	0.67	0.68	0.71	0.72	0.74	0.79	1.00

	ADMX 11-F		ADMX 11-M									ADMX 11-R		ADMX 11-MF	
	0.4	0.8	0.2	0.4	0.8	1.0	1.2	1.6	2.0	2.5	3.0	0.8	1.6	0.4	0.8
	1.89	1.48	2.09	1.89	1.48	1.27	1.08	0.68	1.61	1.13	0.66	1.48	0.68	1.89	1.48

	ADMX 11-MM			ADEX 11-HF	ADEX 11-HF2	ADEX 11-FA			
	0.4	0.8	1.2	0.8	0.8	0.4	0.8	1.2	1.6
	1.89	1.48	1.08	0.17	0.17	1.77	1.39	1.0	0.62

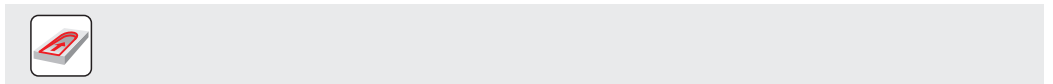
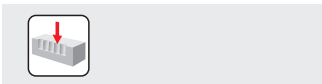
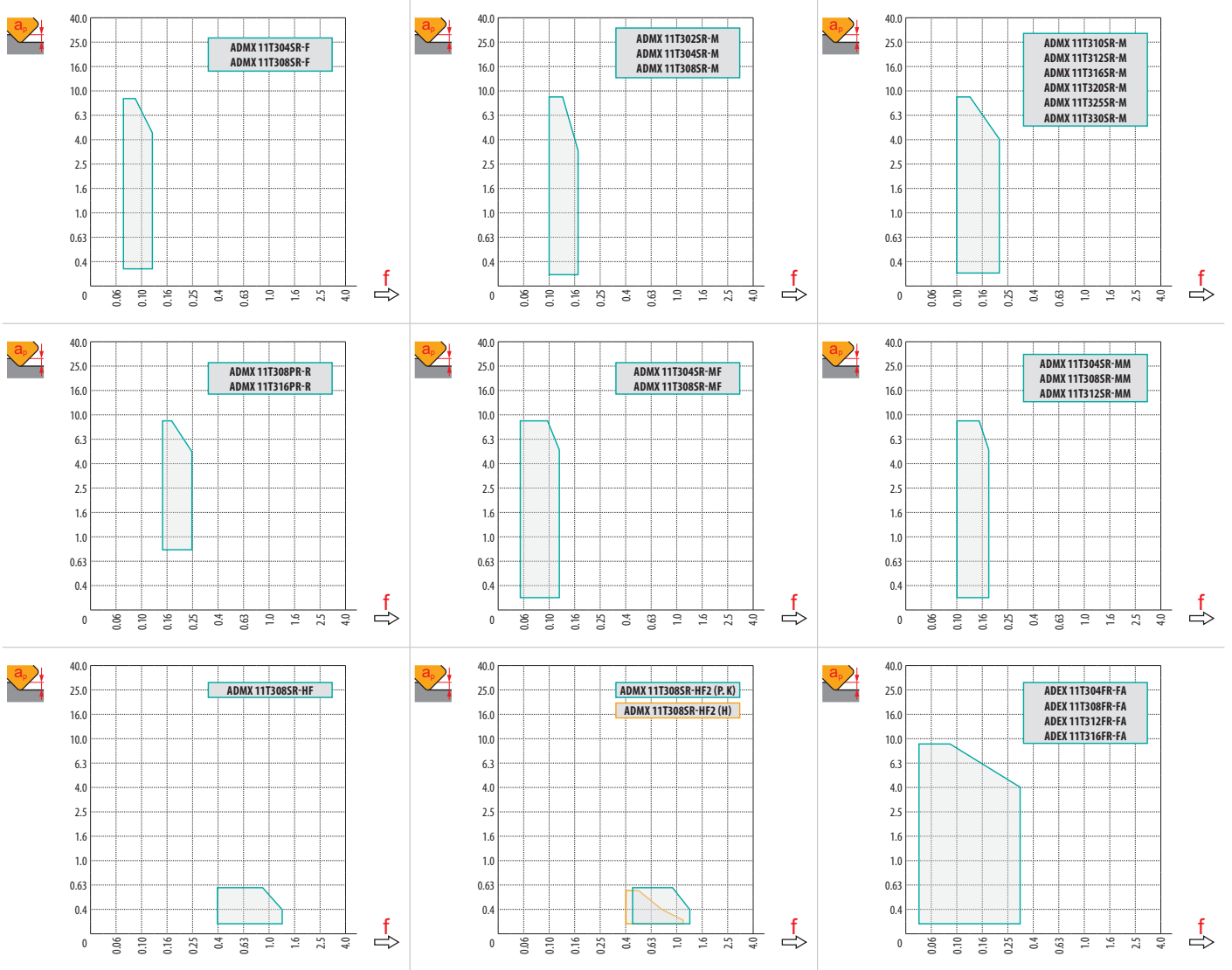

max
4.5

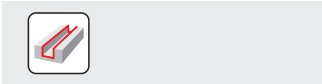

1.0 5.0 9.0

0.20 0.13 0.10

DC	RPMX	APMX/I
16	13.5°	9.0/40
18	10.0°	9.0/53
20	9.0°	9.0/59
25	6.0°	9.0/87
32	5.3°	9.0/99
40	3.8°	6.5/100
50	2.8°	4.7/100
63	1.8°	3.0/100
80	1.6°	2.6/100

HFC			
DC	RPMX *	RPMX **	APMX/I
16	4.1°	5.7°	0.6/8
18	2.8°	4.5°	0.6/12
20	2.3°	4.3°	0.6/15
25	1.3°	6.7°	0.6/26
32	0.7°	4.3°	0.6/49
40	0.3°	2.9°	0.6/100
50	0.1°	2.1°	0.6/100
63	-	-	-
80	-	-	-

* HFC-Fräsen
** Konventionelles Fräsen



DC	D _{MIN}	D _{MAX}	S _{MAX} D _{MIN}	S _{MAX} D _{MAX}
16	27.0	32.0	8.3	9.0
18	32.0	36.0	7.5	9.0
20	35.0	40.0	7.5	9.0
25	45.0	50.0	6.5	7.5
32	59.0	64.0	4.0	4.5
40	75.0	80.0	1.5	2.0
50	-	-	-	-

HFC				
DC	D _{MIN}	D _{MAX}	S _{MAX} D _{MIN}	S _{MAX} D _{MAX}
16	21.0	32.0	0.6	0.6
18	29.0	36.0	0.6	0.6
20	29.0	40.0	0.6	0.6
25	39.0	50.0	0.6	0.6
32	53.0	64.0	0.6	0.6
40	68.5	80.0	0.6	0.6
50	88.5	100.0	0.6	0.6

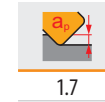

DC	μm	3	5	10	15	20	30	40	50	60	80	100
16		0.438	0.566	0.800	0.980	1.131	1.386	1.600	1.789	1.960	2.263	2.530
18		0.465	0.600	0.849	1.039	1.200	1.470	1.697	1.897	2.078	2.400	2.683
20		0.490	0.632	0.894	1.095	1.265	1.549	1.789	2.000	2.191	2.530	2.828
25		0.548	0.707	1.000	1.225	1.414	1.732	2.000	2.236	2.449	2.828	3.162
32		0.620	0.800	1.131	1.386	1.600	1.960	2.263	2.530	2.771	3.200	3.578
40		0.693	0.894	1.265	1.549	1.789	2.191	2.530	2.828	3.098	3.578	4.000
50		0.775	1.000	1.414	1.732	2.000	2.449	2.828	3.162	3.464	4.000	4.472
63		0.869	1.122	1.587	1.944	2.245	2.750	3.175	3.550	3.888	4.490	5.020
80		0.980	1.265	1.789	2.191	2.530	3.098	3.578	4.000	4.382	5.060	5.657

RE	μm	3	5	10	15	20	30	40	50	60	80	100
1.0		0.155	0.200	0.283	0.346	0.400	0.490	0.566	0.632	0.693	0.800	0.894
1.2		0.170	0.219	0.310	0.379	0.438	0.537	0.620	0.693	0.759	0.876	0.980
1.6		0.196	0.253	0.358	0.438	0.506	0.620	0.716	0.800	0.876	1.012	1.131
2.0		0.219	0.283	0.400	0.490	0.566	0.693	0.800	0.894	0.980	1.131	1.265
2.5		0.245	0.316	0.447	0.548	0.632	0.775	0.894	1.000	1.095	1.265	1.414
3.0		0.268	0.346	0.490	0.600	0.693	0.849	0.980	1.095	1.200	1.386	1.549

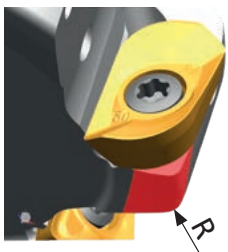

ADMX/ADEX 11	R
ADMX 11T320SR-M	1.0
ADMX 11T325SR-M	1.8
ADMX 11T330SR-M	1.8
ADEX 11T308SR-HF	1.4
ADEX 11T308SR-HF2	1.4

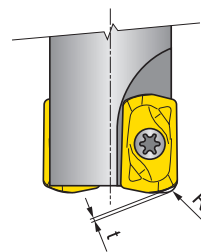

ADEX 11	R	t
ADEX 11T308SR-HF	1.42	0.35
ADEX 11T308SR-HF2	1.34	0.38

SAD16E

P M K N S H

PRAMET

S



FORCE AD16 Eckfräser mit Innenkühlung

90° Schafffräser und Messerköpfe mit positiven AD.. 16 Wendeschneidplatten mit APMX von 13 mm. Geeignet fürs Plan-, Schulter-, Nut-, Helix-, Trochoiden-, Rampen- und Tauchfräsen. Erhältlich mit zylindrischem, Weldon, Morsekegel-, modularem Schaft und als Aufsteckfräser (mit ungleicher Teilung). Für längere Standzeiten ist der Körper oberflächenbehandelt.

KAPR	90°
APMX	13.0 mm

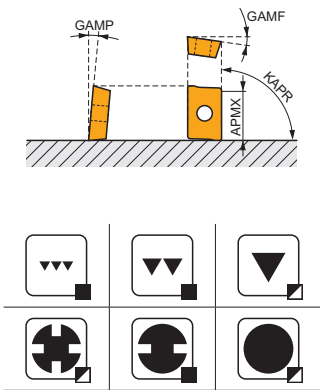

FORCE AD

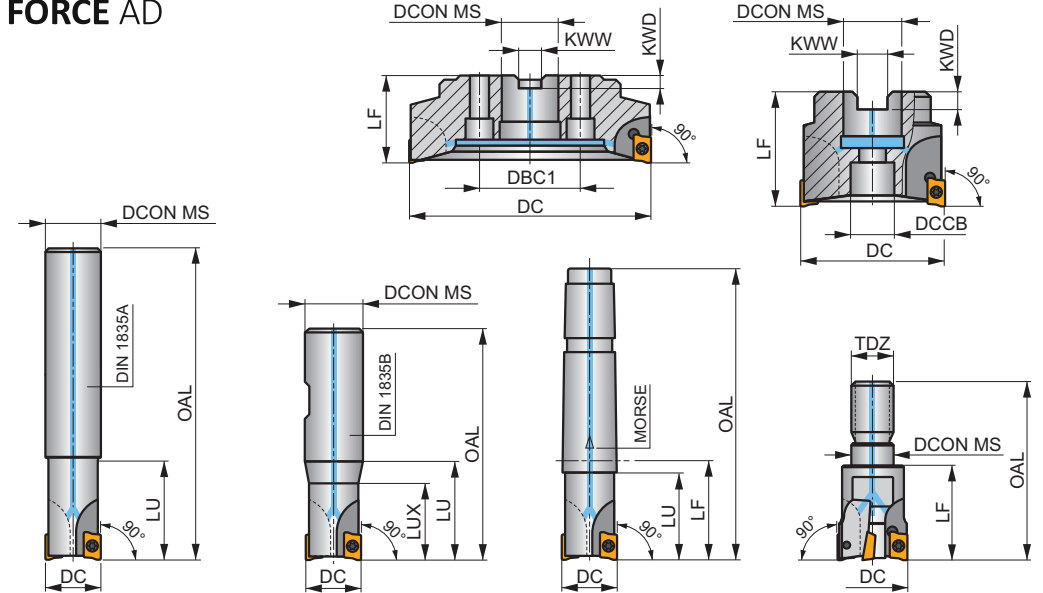

Produkt	DC	OAL	DCON MS	DCCB	DBC1	LU	LUX	LF	TDZ	CZC MS	KWW	KWD	GAMF	GAMP	max.			kg	ISO 6462 DIN 9030		
	(mm)	(mm)	(mm)	(mm)	(mm)	(mm)	(mm)	(mm)			(mm)	(mm)	(°)	(°)							
25A2R033A25-SAD16E-C	25	165	25	-	-	33	-	-	-	-	-	-	-13	5	2	-	18700	✓	0.52	GI165 SQ030	-
25A2R038A25-SAD16E-C	25	200	25	-	-	38	-	-	-	-	-	-	-13	5	2	-	18700	✓	0.66	GI165 SQ030	-
32A3R033A32-SAD16E-C	32	195	32	-	-	33	-	-	-	-	-	-	-12	7	3	-	16500	✓	1.03	GI165 SQ030	-
32A3R048A32-SAD16E-C	32	250	32	-	-	48	-	-	-	-	-	-	-12	7	3	-	16500	✓	1.35	GI165 SQ030	-
25A2R042B25-SAD16E-C	25	98	25	-	-	-	42	-	-	-	-	-	-13	5	2	-	18700	✓	0.29	GI165 SQ030	-
32A3R040B32-SAD16E-C	32	100	32	-	-	-	40	-	-	-	-	-	-12	7	3	-	16500	✓	0.51	GI165 SQ030	-
40A3R050B32-SAD16E-C	40	110	32	-	-	-	50	-	-	-	-	-	-8.2	10.5	3	-	14800	✓	0.51	GI165 SQ030	-
40A4R050B32-SAD16E-C	40	110	32	-	-	-	50	-	-	-	-	-	-8.2	10.5	4	-	14800	✓	0.64	GI165 SQ030	-
25A2R043E03-SAD16E-C	25	98	-	-	-	38	-	43	-	3	-	-	-13	5	2	-	18600	✓	0.31	GI165 SQ030	-
32A3R043E03-SAD16E-C	32	100	-	-	-	38	-	43	-	3	-	-	-12	7	3	-	16500	✓	0.33	GI165 SQ030	-
40A3R054E04-SAD16E-C	40	110	-	-	-	48	-	54	-	4	-	-	-8.2	10.5	3	-	14700	✓	0.74	GI165 SQ030	-
40A4R054E04-SAD16E-C	40	110	-	-	-	48	-	54	-	4	-	-	-8.2	10.5	4	-	14700	✓	0.70	GI165 SQ030	-
32A3R043M16-SAD16E-C	32	66	17	-	-	-	43	M16	-	-	-	-	-12	7	3	-	-	✓	0.20	GI165 SQ030	-
40A4R043M16-SAD16E-C	40	66	17	-	-	-	43	M16	-	-	-	-	-8.2	10.5	4	-	-	✓	0.26	GI165 SQ030	-
40A04R-S90AD16E-C	40	-	16	14	-	-	40	-	-	8.4	5.6	-8.2	10.5	4	-	✓	14700	✓	0.21	GI165 SQ032	-
50A03R-S90AD16E-C	50	-	22	18	-	-	40	-	-	10.4	6.3	-7	11	3	-	✓	13200	✓	0.43	GI165 SQ033	-
50A05R-S90AD16E-C	50	-	22	18	-	-	40	-	-	10.4	6.3	-7	11	5	✓	13200	✓	0.40	GI165 SQ033	-	
63A04R-S90AD16E-C	63	-	22	18	-	-	40	-	-	10.4	6.3	-6	12	4	✓	11800	✓	0.60	GI165 SQ033	-	
63A06R-S90AD16E-C	63	-	22	18	-	-	40	-	-	10.4	6.3	-6	12	6	✓	11800	✓	0.59	GI165 SQ033	-	
80A05R-S90AD16E-C	80	-	27	38	-	-	50	-	-	12.4	7	-5	12	5	✓	10400	✓	1.09	GI165 SQ031 AC001	-	
80A07R-S90AD16E-C	80	-	27	38	-	-	50	-	-	12.4	7	-5	13	7	✓	10400	✓	0.97	GI165 SQ031 AC001	-	
100A06R-S90AD16E-C	100	-	32	45	-	-	50	-	-	14.4	8	-4	12	6	✓	9300	✓	1.85	GI165 SQ031 AC002	-	
100A08R-S90AD16E-C	100	-	32	45	-	-	50	-	-	14.4	8	-4	12	8	✓	9300	✓	1.89	GI165 SQ031 AC002	-	
125A09R-S90AD16E-C	125	-	40	56	-	-	63	-	-	16.4	9	-3.8	12	9	✓	8400	✓	3.65	GI165 SQ031 AC003	-	
140A08R-S90AD16E-C	140	-	40	56	-	-	63	-	-	16.4	9	-3.8	12	8	✓	7900	✓	4.06	GI165 SQ031	-	
160C10R-S90AD16E-C	160	-	40	-	66.7	-	63	-	-	16.4	9.2	-3.8	10	10	✓	7300	✓	6.04	GI165 SQ036	-	
175C10R-S90AD16E-C	175	-	40	-	66.7	-	63	-	-	16.4	9.2	-3.8	12	10	✓	7000	✓	6.86	GI165 SQ036	-	

GI165	ADMX 1606..	ADEX 1606..
-------	-------------	-------------

SQ030	US 4008-T15P	3.5	M 4	8	–	–	Flag T15P	–	–	–	–
SQ031	US 4011-T15P	3.5	M 4	10.6	D-T08P/T15P	FG-15	–	–	–	–	–
SQ032	US 4008-T15P	3.5	M 4	8	D-T08P/T15P	FG-15	–	HS 0830C	–	–	–
SQ033	US 4011-T15P	3.5	M 4	10.6	D-T08P/T15P	FG-15	–	HS 1030C	–	–	–
SQ036	US 4011-T15P	3.5	M 4	10.6	D-T08P/T15P	FG-15	–	HS 1240C	CAC 160C	HSD 0825C	HXK 5

AC001	KS 1230	K.FMH27
AC002	KS 1635	K.FMH32
AC003	KS 2040	K.FMH40

ADMX 16



	W1	D1	L	S
	(mm)	(mm)	(mm)	(mm)
1606	9.950	4.50	16.00	6.25

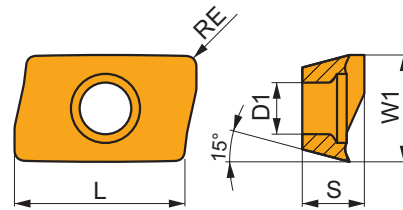

Eignung und Startwerte für Schnittgeschwindigkeit (vc), Vorschub (f) und Schnitttiefe (ap). Weitere Informationen finden Sie in unserer Zerspanungsrechner-App.

Produkt	RE (mm)	P			M			K			N			S			H		
		vc (m/min)	f (mm/tooth)	ap (mm)	vc (m/min)	f (mm/tooth)	ap (mm)	vc (m/min)	f (mm/tooth)	ap (mm)	vc (m/min)	f (mm/tooth)	ap (mm)	vc (m/min)	f (mm/tooth)	ap (mm)	vc (m/min)	f (mm/tooth)	ap (mm)

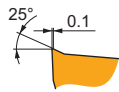
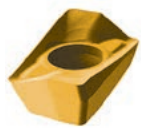

F geometrie mit hoch positiven Design zum Schlichten bis mittleren Bearbeitung.

ADMX 160608SR-F:8215	0.8	290	0.10	2.0	170	0.09	2.0	275	0.10	2.0	870	0.12	2.0	70	0.07	1.6	–	–	–
ADMX 160608SR-F:M8310	0.8	320	0.10	2.0	160	0.09	2.0	300	0.10	2.0	–	–	–	–	–	–	–	–	–
ADMX 160608SR-F:M8330	0.8	285	0.10	2.0	170	0.09	2.0	270	0.10	2.0	855	0.12	2.0	70	0.07	1.6	–	–	–
ADMX 160608SR-F:M8340	0.8	260	0.10	2.0	155	0.09	2.0	245	0.10	2.0	–	–	–	65	0.07	1.6	–	–	–
ADMX 160608SR-F:M9340	0.8	340	0.10	2.0	200	0.09	2.0	–	–	–	–	–	–	85	0.07	1.6	–	–	–

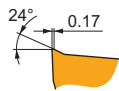
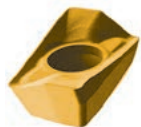

M geometrie mit positiven Design zur leichten bis mittleren Bearbeitung.

ADMX 160604SR-M:8215	0.4	190	0.18	5.0	110	0.16	5.0	180	0.18	5.0	–	–	–	45	0.13	4.0	–	–	–
ADMX 160604SR-M:M8330	0.4	190	0.18	5.0	110	0.16	5.0	180	0.18	5.0	–	–	–	45	0.13	4.0	–	–	–
ADMX 160604SR-M:M8340	0.4	170	0.18	5.0	100	0.16	5.0	160	0.18	5.0	–	–	–	40	0.13	4.0	–	–	–
ADMX 160608SR-M:8215	0.8	225	0.18	5.0	135	0.16	5.0	210	0.18	5.0	–	–	–	55	0.13	4.0	–	–	–
ADMX 160608SR-M:M5315	0.8	305	0.18	5.0	–	–	–	285	0.18	5.0	–	–	–	–	–	–	–	–	–
ADMX 160608SR-M:M8310	0.8	250	0.18	5.0	125	0.16	5.0	235	0.18	5.0	–	–	–	–	–	–	–	–	–
ADMX 160608SR-M:M8330	0.8	225	0.18	5.0	135	0.16	5.0	210	0.18	5.0	–	–	–	55	0.13	4.0	–	–	–
ADMX 160608SR-M:M8340	0.8	205	0.18	5.0	120	0.16	5.0	190	0.18	5.0	–	–	–	50	0.13	4.0	–	–	–
ADMX 160608SR-M:M9315	0.8	305	0.18	5.0	–	–	–	285	0.18	5.0	–	–	–	–	–	–	–	–	–
ADMX 160608SR-M:M9325	0.8	280	0.18	5.0	–	–	–	265	0.18	5.0	–	–	–	–	–	–	–	–	–
ADMX 160608SR-M:M9340	0.8	255	0.18	5.0	150	0.16	5.0	–	–	–	–	–	–	60	0.13	4.0	–	–	–

Eignung und Startwerte für Schnittgeschwindigkeit (vc), Vorschub (f) und Schnitttiefe (ap). Weitere Informationen finden Sie in unserer Zerspanungsrechner-App.

Produkt	RE (mm)	P			M			K			N			S			H		
		vc	f	ap	vc	f	ap	vc	f	ap	vc	f	ap	vc	f	ap	vc	f	ap
		(m/min)	(mm/tooth)	(mm)	(m/min)	(mm/tooth)	(mm)	(m/min)	(mm/tooth)	(mm)	(m/min)	(mm/tooth)	(mm)	(m/min)	(mm/tooth)	(mm)	(m/min)	(mm/tooth)	(mm)

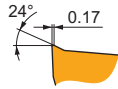
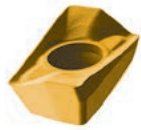

M geometrie mit positiven Design zur leichten bis mittleren Bearbeitung.

ADMX 160616SR-M:8215	1.6	250	0.18	5.0	150	0.16	5.0	235	0.18	5.0	-	-	-	60	0.13	4.0	-	-	-
ADMX 160616SR-M:M8310	1.6	275	0.18	5.0	140	0.16	5.0	260	0.18	5.0	-	-	-	-	-	-	-	-	-
ADMX 160616SR-M:M8330	1.6	250	0.18	5.0	150	0.16	5.0	235	0.18	5.0	-	-	-	60	0.13	4.0	-	-	-
ADMX 160616SR-M:M8340	1.6	225	0.18	5.0	135	0.16	5.0	210	0.18	5.0	-	-	-	55	0.13	4.0	-	-	-
ADMX 160616SR-M:M9325	1.6	310	0.18	5.0	-	-	-	290	0.18	5.0	-	-	-	-	-	-	-	-	-
ADMX 160620SR-M:M8330	2.0	265	0.18	5.0	155	0.16	5.0	250	0.18	5.0	-	-	-	65	0.13	4.0	-	-	-
ADMX 160620SR-M:M8340	2.0	240	0.18	5.0	140	0.16	5.0	225	0.18	5.0	-	-	-	60	0.13	4.0	-	-	-
ADMX 160630SR-M:M8330	3.0	265	0.18	5.0	155	0.16	5.0	250	0.18	5.0	-	-	-	65	0.13	4.0	-	-	-
ADMX 160630SR-M:M8340	3.0	240	0.18	5.0	140	0.16	5.0	225	0.18	5.0	-	-	-	60	0.13	4.0	-	-	-
ADMX 160632SR-M:M6330	3.2	225	0.18	5.0	155	0.16	5.0	-	-	-	-	-	-	65	0.13	4.0	-	-	-
ADMX 160632SR-M:M8330	3.2	265	0.18	5.0	155	0.16	5.0	250	0.18	5.0	-	-	-	65	0.13	4.0	-	-	-
ADMX 160632SR-M:M8340	3.2	240	0.18	5.0	140	0.16	5.0	225	0.18	5.0	-	-	-	60	0.13	4.0	-	-	-
ADMX 160632SR-M:M9325	3.2	325	0.18	5.0	-	-	-	305	0.18	5.0	-	-	-	-	-	-	-	-	-
ADMX 160640SR-M:M8330	4.0	265	0.18	5.0	155	0.16	5.0	250	0.18	5.0	-	-	-	65	0.13	4.0	-	-	-
ADMX 160640SR-M:M8340	4.0	240	0.18	5.0	140	0.16	5.0	225	0.18	5.0	-	-	-	60	0.13	4.0	-	-	-
ADMX 160650SR-M:M8330	5.0	265	0.18	5.0	155	0.16	5.0	250	0.18	5.0	-	-	-	65	0.13	4.0	-	-	-
ADMX 160650SR-M:M8340	5.0	240	0.18	5.0	140	0.16	5.0	225	0.18	5.0	-	-	-	60	0.13	4.0	-	-	-

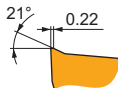
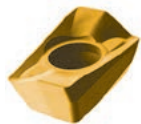

R geometrie mit positiven Design für mittlere bis weniger stabile Bearbeitungsbedingungen.

ADMX 160608PR-R:8215	0.8	205	0.25	6.0	120	0.23	6.0	190	0.25	6.0	-	-	-	50	0.20	4.8	40	0.16	1.1
ADMX 160608PR-R:M5315	0.8	260	0.25	6.0	-	-	-	245	0.25	6.0	-	-	-	-	-	-	50	0.16	1.1
ADMX 160608PR-R:M8310	0.8	220	0.25	6.0	110	0.23	6.0	205	0.25	6.0	-	-	-	40	0.16	1.1	-	-	-
ADMX 160608PR-R:M8330	0.8	205	0.25	6.0	120	0.23	6.0	190	0.25	6.0	-	-	-	50	0.20	4.8	40	0.16	1.1
ADMX 160608PR-R:M8340	0.8	190	0.25	6.0	110	0.23	6.0	180	0.25	6.0	-	-	-	45	0.20	4.8	-	-	-
ADMX 160608PR-R:M9315	0.8	265	0.25	6.0	-	-	-	250	0.25	6.0	-	-	-	-	-	-	50	0.16	1.1
ADMX 160608PR-R:M9325	0.8	250	0.25	6.0	-	-	-	235	0.25	6.0	-	-	-	-	-	-	50	0.16	1.1
ADMX 160616PR-R:M8330	1.6	225	0.25	6.0	135	0.23	6.0	210	0.25	6.0	-	-	-	55	0.20	4.8	45	0.16	1.1
ADMX 160616PR-R:M8340	1.6	210	0.25	6.0	125	0.23	6.0	195	0.25	6.0	-	-	-	50	0.20	4.8	-	-	-
ADMX 160616PR-R:M9315	1.6	295	0.25	6.0	-	-	-	280	0.25	6.0	-	-	-	-	-	-	55	0.16	1.1

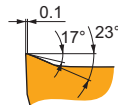

MF geometrie mit hoch positiven Design zur Schlichtbearbeitung.

ADMX 160608SR-MF:M6330	0.8	215	0.08	4.0	150	0.07	4.0	-	-	-	-	-	-	60	0.06	3.2	-	-	-
ADMX 160608SR-MF:M8340	0.8	225	0.08	4.0	135	0.07	4.0	-	-	-	-	-	-	55	0.06	3.2	-	-	-
ADMX 160608SR-MF:M9340	0.8	305	0.08	4.0	180	0.07	4.0	-	-	-	-	-	-	75	0.06	3.2	-	-	-

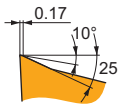

MM geometrie mit sehr positiven Design zur leichten bis mittleren Bearbeitung.

ADMX 160604SR-MM:M6330	0.4	145	0.18	4.0	105	0.16	4.0	-	-	-	-	-	-	40	0.14	3.2	-	-	-
ADMX 160604SR-MM:M8340	0.4	160	0.18	4.0	95	0.16	4.0	-	-	-	-	-	-	40	0.14	3.2	-	-	-
ADMX 160608SR-MM:M6330	0.8	175	0.18	4.0	125	0.16	4.0	-	-	-	-	-	-	50	0.14	3.2	-	-	-
ADMX 160608SR-MM:M8340	0.8	190	0.18	4.0	110	0.16	4.0	-	-	-	-	-	-	45	0.14	3.2	-	-	-
ADMX 160608SR-MM:M8345	0.8	150	0.18	4.0	90	0.16	4.0	-	-	-	-	-	-	35	0.14	3.2	-	-	-
ADMX 160608SR-MM:M9340	0.8	235	0.18	4.0	140	0.16	4.0	-	-	-	-	-	-	55	0.14	3.2	-	-	-
ADMX 160616SR-MM:M6330	1.6	195	0.18	4.0	140	0.16	4.0	-	-	-	-	-	-	55	0.14	3.2	-	-	-
ADMX 160616SR-MM:M8340	1.6	210	0.18	4.0	125	0.16	4.0	-	-	-	-	-	-	50	0.14	3.2	-	-	-
ADMX 160616SR-MM:M8345	1.6	165	0.18	4.0	95	0.16	4.0	-	-	-	-	-	-	40	0.14	3.2	-	-	-
ADMX 160616SR-MM:M9340	1.6	260	0.18	4.0	155	0.16	4.0	-	-	-	-	-	-	65	0.14	3.2	-	-	-

ADEX 16



	W1	D1	L	S
	(mm)	(mm)	(mm)	(mm)
1606	9.950	4.50	16.00	6.25

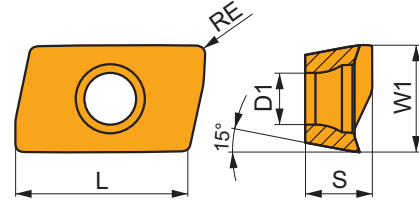

Eignung und Startwerte für Schnittgeschwindigkeit (vc), Vorschub (f) und Schnitttiefe (ap). Weitere Informationen finden Sie in unserer Zerspanungsrechner-App.

Produkt	RE (mm)	P			M			K			N			S			H		
		vc	f	ap	vc	f	ap	vc	f	ap	vc	f	ap	vc	f	ap	vc	f	ap
		(m/min)	(mm/tooth)	(mm)	(m/min)	(mm/tooth)	(mm)	(m/min)	(mm/tooth)	(mm)	(m/min)	(mm/tooth)	(mm)	(m/min)	(mm/tooth)	(mm)	(m/min)	(mm/tooth)	(mm)

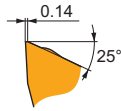
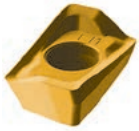

FM geometrie mit sehr positiven Design zur mittleren Bearbeitung.

ADEX 160608SR-FM:8215	● 0.8	■ 260	■ 0.16	■ 2.0	■ 155	■ 0.14	■ 2.0	■ 245	■ 0.16	■ 2.0	■ -	■ -	■ -	■ 65	■ 0.11	■ 1.6	■ -	■ -	■ -
ADEX 160608SR-FM:M8330	● 0.8	■ 255	■ 0.16	■ 2.0	■ 150	■ 0.14	■ 2.0	■ 240	■ 0.16	■ 2.0	■ -	■ -	■ -	■ 60	■ 0.11	■ 1.6	■ -	■ -	■ -
ADEX 160608SR-FM:M8340	● 0.8	■ 235	■ 0.16	■ 2.0	■ 140	■ 0.14	■ 2.0	■ 220	■ 0.16	■ 2.0	■ -	■ -	■ -	■ 55	■ 0.11	■ 1.6	■ -	■ -	■ -

ADEX 16-FA



	W1	D1	L	S
	(mm)	(mm)	(mm)	(mm)
1606	9.950	4.50	16.00	6.17

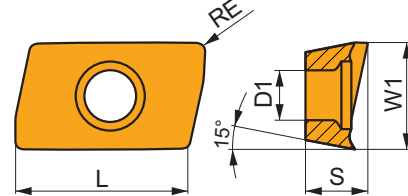

Eignung und Startwerte für Schnittgeschwindigkeit (vc), Vorschub (f) und Schnitttiefe (ap). Weitere Informationen finden Sie in unserer Zerspanungsrechner-App.

Produkt	RE (mm)	P			M			K			N			S			H		
		vc	f	ap	vc	f	ap	vc	f	ap	vc	f	ap	vc	f	ap	vc	f	ap
		(m/min)	(mm/tooth)	(mm)	(m/min)	(mm/tooth)	(mm)	(m/min)	(mm/tooth)	(mm)	(m/min)	(mm/tooth)	(mm)	(m/min)	(mm/tooth)	(mm)	(m/min)	(mm/tooth)	(mm)

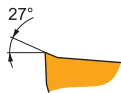

FA geometrie mit hoch positiven Design zur feinen Schlichtbearbeitung bis zur mittleren Bearbeitung.

ADEX 160604FR-FA:HF7	● 0.4	■ -	■ -	■ -	■ -	■ -	■ -	■ -	■ -	■ -	■ 195	■ 0.28	■ 6.0	■ -	■ -	■ -	■ -	■ -	■ -
ADEX 160604FR-FA:M0315	● 0.4	■ -	■ -	■ -	■ -	■ -	■ -	■ -	■ -	■ -	■ 480	■ 0.28	■ 6.0	■ -	■ -	■ -	■ -	■ -	■ -
ADEX 160608FR-FA:HF7	● 0.8	■ -	■ -	■ -	■ -	■ -	■ -	■ -	■ -	■ -	■ 240	■ 0.28	■ 6.0	■ -	■ -	■ -	■ -	■ -	■ -
ADEX 160608FR-FA:M0315	● 0.8	■ -	■ -	■ -	■ -	■ -	■ -	■ -	■ -	■ -	■ 570	■ 0.28	■ 6.0	■ -	■ -	■ -	■ -	■ -	■ -
ADEX 160616FR-FA:HF7	● 1.6	■ -	■ -	■ -	■ -	■ -	■ -	■ -	■ -	■ -	■ 255	■ 0.28	■ 6.0	■ -	■ -	■ -	■ -	■ -	■ -
ADEX 160616FR-FA:M0315	● 1.6	■ -	■ -	■ -	■ -	■ -	■ -	■ -	■ -	■ -	■ 630	■ 0.28	■ 6.0	■ -	■ -	■ -	■ -	■ -	■ -
ADEX 160630FR-FA:HF7	● 3.0	■ -	■ -	■ -	■ -	■ -	■ -	■ -	■ -	■ -	■ 270	■ 0.28	■ 6.0	■ -	■ -	■ -	■ -	■ -	■ -

ADEX 16-HF



	W1	D1	L	S
	(mm)	(mm)	(mm)	(mm)
1606	9.950	4.50	16.00	5.88

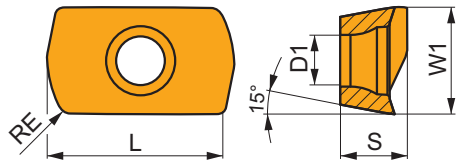

Eignung und Startwerte für Schnittgeschwindigkeit (vc), Vorschub (f) und Schnitttiefe (ap). Weitere Informationen finden Sie in unserer Zerspanungsrechner-App.

Produkt	RE (mm)	P			M			K			N			S			H		
		vc (m/min)	f (mm/tooth)	ap (mm)	vc (m/min)	f (mm/tooth)	ap (mm)	vc (m/min)	f (mm/tooth)	ap (mm)	vc (m/min)	f (mm/tooth)	ap (mm)	vc (m/min)	f (mm/tooth)	ap (mm)	vc (m/min)	f (mm/tooth)	ap (mm)

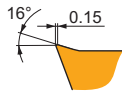

HF geometrie mit sehr positiven Design für die Hochvorschubbearbeitung.

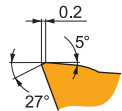

ADEX 160612SR-HF:8215	1.2	195	1.00	0.6	115	0.90	0.6	-	-	-	-	-	-	-	-	-	-	-
ADEX 160612SR-HF:M8310	1.2	205	1.00	0.6	100	0.77	0.6	-	-	-	-	-	-	-	-	-	-	-
ADEX 160612SR-HF:M8330	1.2	200	1.00	0.6	120	0.90	0.6	-	-	-	-	-	-	-	-	-	-	-
ADEX 160612SR-HF:M8340	1.2	185	1.00	0.6	110	0.90	0.6	-	-	-	-	-	-	-	-	-	-	-
ADEX 160612SR-HF:M9340	1.2	195	1.00	0.6	115	0.90	0.6	-	-	-	-	-	-	-	-	-	-	-









HF2 geometrie mit positiven Design für die Hochvorschubbearbeitung.

ADEX 160612SR-HF2:M8310	1.2	205	0.90	0.6	100	0.81	0.6	190	0.90	0.6	-	-	-	-	-	-	40	0.63	0.5
ADEX 160612SR-HF2:M8330	1.2	205	0.90	0.6	120	0.81	0.6	190	0.90	0.6	50	0.81	0.5	40	0.63	0.5	-	-	-
ADEX 160612SR-HF2:M8340	1.2	190	0.90	0.6	110	0.81	0.6	180	0.90	0.6	45	0.81	0.5	-	-	-	-	-	-
ADEX 160612SR-HF2:M9325	1.2	230	0.90	0.6	-	-	-	215	0.90	0.6	-	-	-	45	0.63	0.5	-	-	-



a_e DC	5 %	10 %	15 %	20 %	25 %	30 %	40 %	50 %	60 %	70 %	75 %	80 %	90 %	100 %
	1.48	1.35	1.27	1.22	1.19	1.16	1.11	1.08	1.05	1.03	1.00	1.00	1.00	1.00
	2.20	1.60	1.35	1.20	1.10	0.95	0.85	0.75	0.85	0.95	1.00	1.00	1.00	1.00
	0.64	0.64	0.64	0.64	0.64	0.65	0.65	0.67	0.68	0.71	0.72	0.74	0.79	1.00

	ADMX 16-F	ADEX 16-FM	ADMX 16-M										ADMX 16-R	
	0.8	0.8	0.4	0.8	1.6	2.0	3.0	3.2	4.0	5.0		0.8	1.6	
	2.99	2.18	3.39	2.99	1.62	1.23	0.28	0.09	2.69	1.52		2.99	1.62	

	ADMX 16-MF	ADMX 16-MM				ADEX 16-HF	ADEX 16-HF2	ADEX 16-FA			
	0.8	0.4	0.8	1.6	1.2	1.2	0.4	0.8	1.6	3.0	
	2.99	3.39	2.99	1.62	0.52	0.52	2.84	2.44	1.65	0.69	

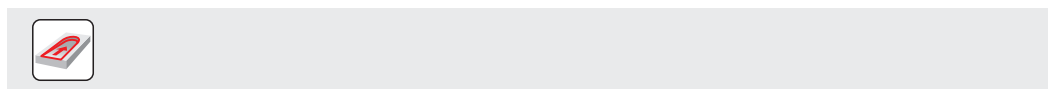
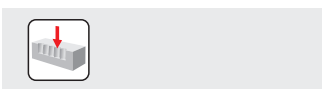
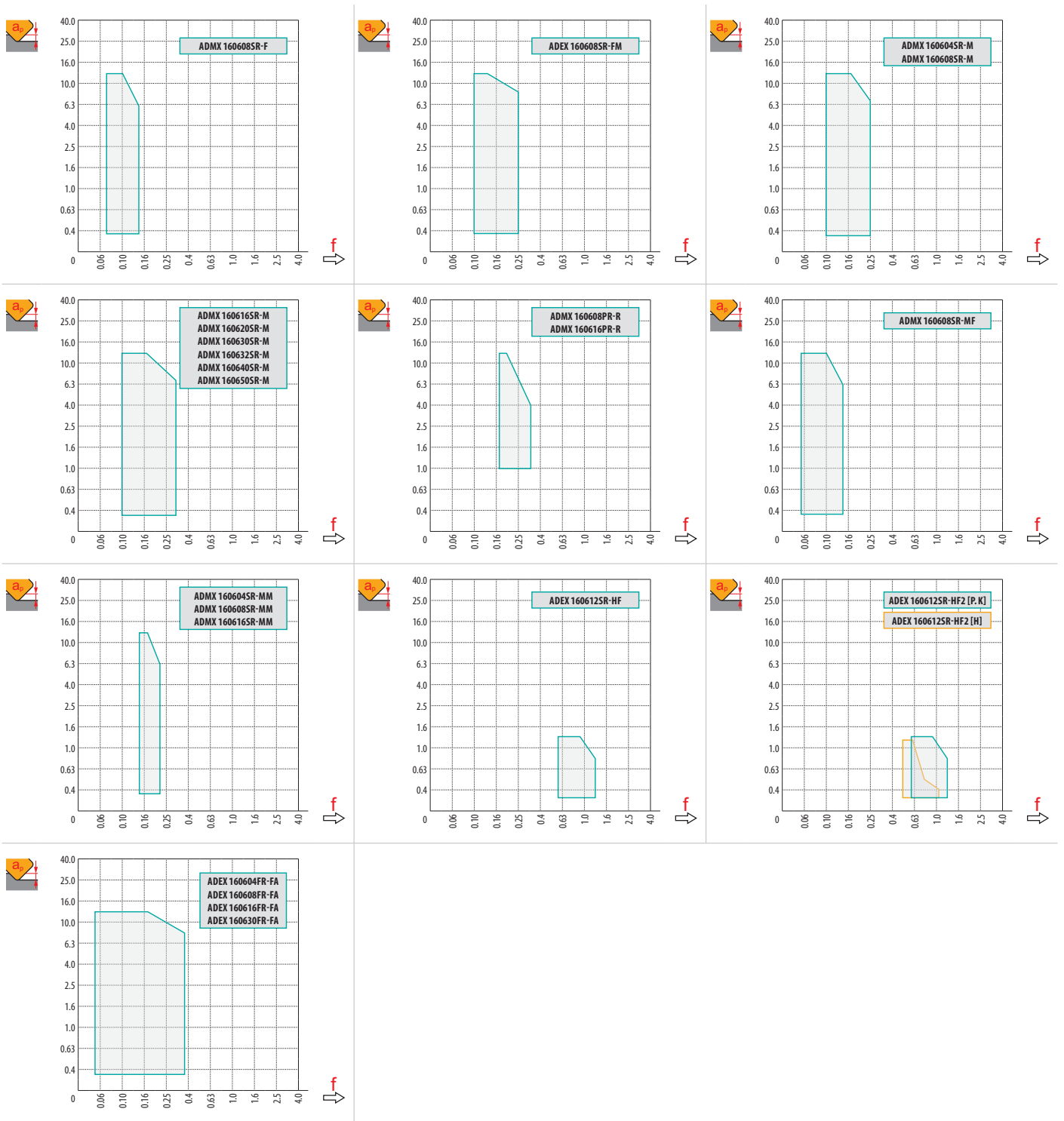

max
7.5

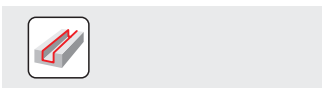

	1.0	6.0	13.0
	0.28	0.19	0.10

DC	RPMX	APMX/I
25	12.5°	13.0/60
32	7.5°	13.0/100
40	5.0°	8.6/100
50	3.5°	6.0/100
63	2.5°	4.2/100
80	2.0°	3.3/100

HFC			
DC	RPMX *	RPMX **	APMX/I
25	4.0°	8.0°	1.3/19
32	2.0°	7.5°	1.3/38
40	1.2°	4.5°	1.3/65
50	0.8°	3.0°	1.3/100
63	0.5°	2.0°	0.8/100
80	0.4°	1.5°	0.6/100

* HFC-Fräsen
** Konventionelles Fräsen



	D _{MIN}	D _{MAX}	D _{MIN}	D _{MAX}
25	42.0	50.0	10.0	12.5
32	55.0	64.0	6.5	9.0
40	72.0	80.0	5.0	8.0
50	92.0	100.0	4.5	6.0
63	118.0	126.0	4.0	5.0
80	136.0	160.0	1.5	2.0

HFC				
	D _{MIN}	D _{MAX}	D _{MIN}	D _{MAX}
25	42.0	50.0	1.3	1.3
32	55.0	64.0	1.3	1.3
40	72.0	80.0	1.3	1.3
50	92.0	100.0	1.3	1.3
63	118.0	126.0	1.3	1.3
80	136.0	160.0	1.3	1.3

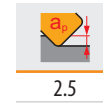

		3	5	10	15	20	30	40	50	60	80	100
25		0.548	0.707	1.000	1.225	1.414	1.732	2.000	2.236	2.449	2.828	3.162
32		0.620	0.800	1.131	1.386	1.600	1.960	2.263	2.530	2.771	3.200	3.578
40		0.693	0.894	1.265	1.549	1.789	2.191	2.530	2.828	3.098	3.578	4.000
50		0.775	1.000	1.414	1.732	2.000	2.449	2.828	3.162	3.464	4.000	4.472
63		0.869	1.122	1.587	1.944	2.245	2.750	3.175	3.550	3.888	4.490	5.020
80		0.980	1.265	1.789	2.191	2.530	3.098	3.578	4.000	4.382	5.060	5.657

		3	5	10	15	20	30	40	50	60	80	100
1.6		0.196	0.253	0.358	0.438	0.506	0.620	0.716	0.800	0.876	1.012	1.131
2.0		0.219	0.283	0.400	0.490	0.566	0.693	0.800	0.894	0.980	1.131	1.265
3.0		0.268	0.346	0.490	0.600	0.693	0.849	0.980	1.095	1.200	1.386	1.549
3.2		0.277	0.358	0.506	0.620	0.716	0.876	1.012	1.131	1.239	1.431	1.600
4.0		0.310	0.400	0.566	0.693	0.800	0.980	1.131	1.265	1.386	1.600	1.789
5.0		0.346	0.447	0.632	0.775	0.894	1.095	1.265	1.414	1.549	1.789	2.000

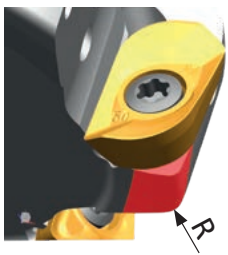

ADMX/ADEX 16	R
ADMX 160630SR-M	2.5
ADMX 160632SR-M	2.5
ADMX 160640SR-M	4.0
ADMX 160650SR-M	4.5
ADEX 160612SR-HF	3.0
ADEX 160612SR-HF2	3.0

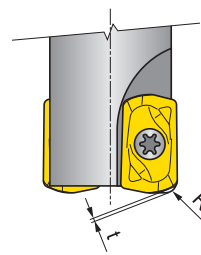

ADEX 16	R	t
ADEX 160612SR-HF	2.59	0.56
ADEX 160612SR-HF2	2.48	0.57

SAP10D

P M K N S

PRAMET

S



Eckfräser für APKT 10 Wendeschneidplatten mit Innenkühlung

90° Schatfräser und Messerköpfe mit positiven APKT 10 Wendeschneidplatten mit APMX von 9 mm. Geeignet fürs Plan-, Schulter-, Nut-, Helix-, Trochoiden-, Rampen- und Tauchfräsen. Erhältlich mit Weldonchaft und als Aufsteckfräser (mit ungleicher Teilung). Für längere Standzeiten ist der Körper oberflächenbehandelt.

KAPR	90°
APMX	9.0 mm

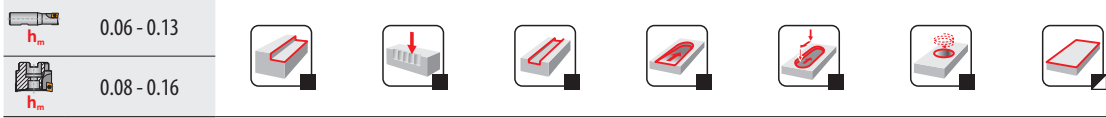
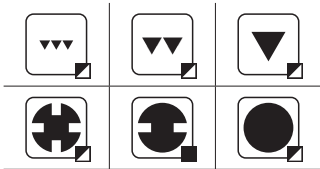
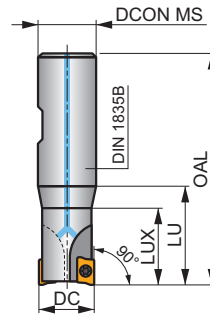
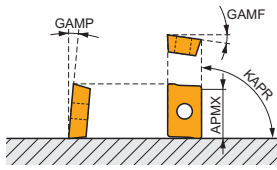

Produkt	DC	OAL	DCON MS	DCCB	LU	LUX	LF	KWW	KWD	GAMF	GAMP							
	(mm)	(mm)	(mm)	(mm)	(mm)	(mm)	(mm)	(mm)	(mm)	(°)	(°)			max.				
10A1R020B16-SAP10D-C	10	78	16	-	30	20	-	-	-	12	2	1	-	39000	✓	0.09	G1081	SQ215
12A1R027B16-SAP10D-C	12	75	16	-	27	-	-	-	-	12	2	1	-	35600	✓	0.10	G1081	SQ210
16A2R032B16-SAP10D-C	16	80	16	-	32	-	-	-	-	12	4	2	-	30800	✓	0.12	G1081	SQ210
20A3R032B20-SAP10D-C	20	82	20	-	32	-	-	-	-	12	4	3	-	27600	✓	0.13	G1081	SQ210
25A3R042B25-SAP10D-C	25	98	25	-	42	-	-	-	-	12	4	3	-	24700	✓	0.36	G1081	SQ210

G1081	APKT 1003..

SQ210	US 2506-T07P	1.2	M 2.5	6.3	Flag T07P
SQ215	US 2505-T07P	1.2	M 2.5	5.2	Flag T07P

APKT 10



	W1 (mm)	D1 (mm)	L (mm)	S (mm)
1003	6.700	2.88	11.00	3.50

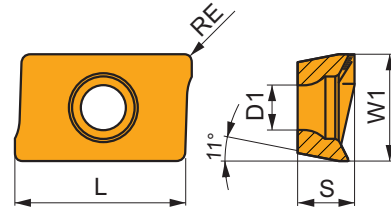

Eignung und Startwerte für Schnittgeschwindigkeit (vc), Vorschub (f) und Schnitttiefe (ap). Weitere Informationen finden Sie in unserer Zerspanungsrechner-App.

Produkt	RE (mm)	P			M			K			N			S			H		
		vc (m/min)	f (mm/tooth)	ap (mm)	vc (m/min)	f (mm/tooth)	ap (mm)	vc (m/min)	f (mm/tooth)	ap (mm)	vc (m/min)	f (mm/tooth)	ap (mm)	vc (m/min)	f (mm/tooth)	ap (mm)	vc (m/min)	f (mm/tooth)	ap (mm)

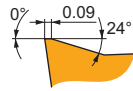
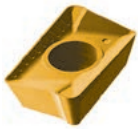

M geometrie mit sehr positiven Design zur leichten bis mittleren Bearbeitung.

APKT 1003PDER-M:8215	0.5	285	0.12	4.0	170	0.11	4.0	270	0.12	4.0	-	-	-	70	0.11	3.2	-	-	-
APKT 1003PDER-M:M8330	0.5	285	0.12	4.0	170	0.11	4.0	270	0.12	4.0	-	-	-	70	0.11	3.2	-	-	-
APKT 1003PDER-M:M8340	0.5	255	0.12	4.0	150	0.11	4.0	240	0.12	4.0	-	-	-	60	0.11	3.2	-	-	-
APKT 1003PDER-M:M9325	0.5	360	0.12	4.0	-	-	-	340	0.12	4.0	-	-	-	-	-	-	-	-	-
APKT 1003PDER-M:M9340	0.5	335	0.12	4.0	200	0.11	4.0	-	-	-	-	-	-	80	0.11	3.2	-	-	-



a_e / DC	5 %	10 %	15 %	20 %	25 %	30 %	40 %	50 %	60 %	70 %	75 %	80 %	90 %	100 %
	1.48	1.35	1.27	1.22	1.19	1.16	1.11	1.08	1.05	1.03	1.00	1.00	1.00	1.00
	2.20	1.60	1.35	1.20	1.10	0.95	0.85	0.75	0.85	0.95	1.00	1.00	1.00	1.00
	0.64	0.64	0.64	0.64	0.64	0.65	0.65	0.67	0.68	0.71	0.72	0.74	0.79	1.00

	APKT 10-M
	0.5
	0.84

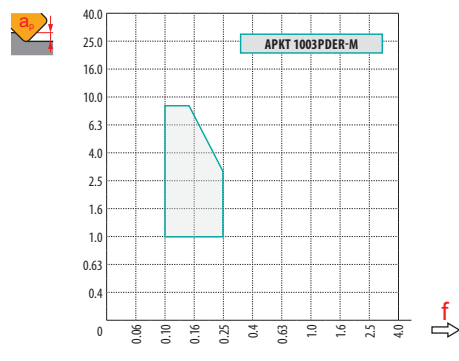

4.5

	1.0	3.0	5.0
	0.20	0.13	0.10

	RPMX	APMX/I
10	7.3°	9.0/72
12	6.2°	9.0/84
16	2.4°	4.0/100
20	2.2°	3.7/100
25	2.2°	3.7/100

	DMIN	DMAX		
10	11.0	20.0	0.4	3.8
12	13.0	24.0	0.3	3.9
16	20.5	32.0	0.6	2.0
20	27.2	40.0	0.9	2.4
25	37.9	50.0	1.6	3.0

0.3

SAP16D



PRAMET



Eckfräser für APKT 16 Wendeschneidplatten mit Innenkühlung

90° Schaftfräser und Messerköpfe mit positiven APKT 16 Wendeschneidplatten und APMX von 13 mm. Geeignet fürs Plan-, Schulter-, Nut- und Tauchfräsen. Erhältlich mit Weldonschaft und als Aufsteckfräser (mit ungleicher Teilung). Für längere Standzeiten ist der Körper oberflächenbehandelt.

KAPR	90°
APMX	13.0 mm

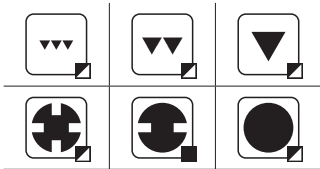
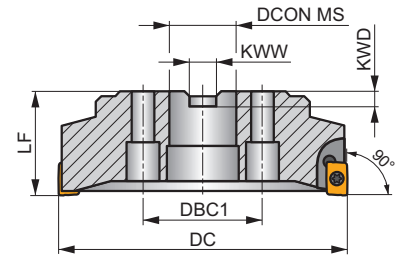
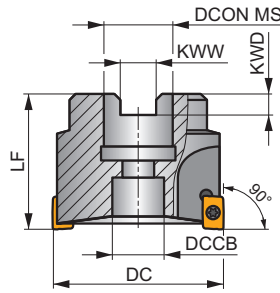
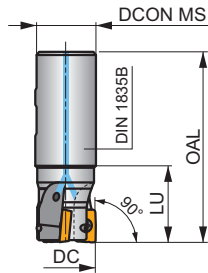
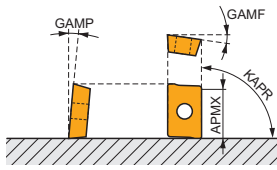

	0.06 - 0.18
	0.10 - 0.22



Produkt	DC	OAL	DCON MS	DCCB	DBC1	LU	LF	KWW	KWD	GAMF	GAMP	max.			kg	ISO 8030			
	(mm)	(mm)	(mm)	(mm)	(mm)	(mm)	(mm)	(mm)	(mm)	(°)	(°)	mm	mm	mm		mm	mm	mm	
25A2R042B25-SAP16D-C	25	98	25	-	-	42	-	-	-	0	6	2	-	16800	✓	0.31	GI080	SQ030	-
32A3R040B32-SAP16D-C	32	100	32	-	-	50	-	-	-	0	8	3	-	14800	✓	0.51	GI080	SQ220	-
40A4R050B32-SAP16D-C	40	110	32	-	-	50	-	-	-	0	8	4	-	13200	✓	0.67	GI080	SQ220	-
40A4R-S90AP16D	40	40	16	11	-	-	40	8.4	5.6	0	6	4	✓	13200	-	0.23	GI080	SQ031	-
50A5R-S90AP16D	50	40	22	18	-	-	40	10.4	6.3	0	6	5	✓	11800	-	0.35	GI080	SQ031	-
63A6R-S90AP16D	63	40	22	18	-	-	40	10.4	6.3	0	6	6	✓	10600	-	0.50	GI080	SQ031	-
80B5R-S90AP16D	80	50	27	38	-	-	50	12.4	7	0	6	5	✓	9400	-	0.97	GI080	SQ031	AC001
80B7R-S90AP16D	80	50	27	38	-	-	50	12.4	7	0	6	7	✓	9400	-	0.99	GI080	SQ031	AC001
100B8R-S90AP16D	100	50	32	45	-	-	50	14.4	8	0	6	8	✓	8400	-	1.50	GI080	SQ031	AC002
125B9R-S90AP16D	125	63	40	56	-	-	63	16.4	9	0	6	9	✓	7500	-	2.80	GI080	SQ031	AC003

GI080	APKT 1604..	APET 1604..

SQ030	US 4008-T15P	3.5	M 4	8	-	-	Flag T15P
SQ031	US 4011-T15P	3.5	M 4	10.6	D-T08P/T15P	FG-15	-
SQ220	US 4011-T15P	3.5	M 4	10.6	-	-	Flag T15P

AC001	KS 1230	K.FMH27

AC002	KS 1635	K.FMH32
AC003	KS 2040	K.FMH40

APKT 16



	W1	D1	L	S
	(mm)	(mm)	(mm)	(mm)
1604	9.440	4.60	17.00	5.67

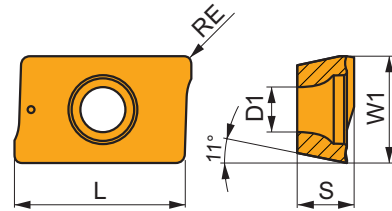

Eignung und Startwerte für Schnittgeschwindigkeit (vc), Vorschub (f) und Schnitttiefe (ap). Weitere Informationen finden Sie in unserer Zerspanungsrechner-App.

Produkt	RE (mm)	P			M			K			N			S			H		
		vc	f	ap	vc	f	ap	vc	f	ap	vc	f	ap	vc	f	ap	vc	f	ap
	(mm)	(m/min)	(mm/tooth)	(mm)	(m/min)	(mm/tooth)	(mm)	(m/min)	(mm/tooth)	(mm)	(m/min)	(mm/tooth)	(mm)	(m/min)	(mm/tooth)	(mm)	(m/min)	(mm/tooth)	(mm)

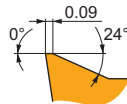
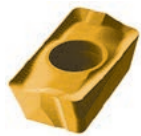

GM geometrie mit sehr positiven Design zur leichten bis mittleren Bearbeitung.

APKT 1604PDR-GM:M8330	⊕ 0.8	235	0.20	8.0	140	0.18	8.0	220	0.20	8.0	–	–	–	55	0.16	6.4	–	–	–
APKT 1604PDR-GM:M8340	⊕ 0.8	210	0.20	8.0	125	0.18	8.0	195	0.20	8.0	–	–	–	50	0.16	6.4	–	–	–
APKT 1604PDR-GM:M9315	● 0.8	310	0.20	8.0	–	–	–	290	0.20	8.0	–	–	–	–	–	–	–	–	–
APKT 1604PDR-GM:M9325	● 0.8	285	0.20	8.0	–	–	–	270	0.20	8.0	–	–	–	–	–	–	–	–	–
APKT 1604PDR-GM:M9340	⊕ 0.8	260	0.20	8.0	155	0.18	8.0	–	–	–	–	–	–	65	0.16	6.4	–	–	–

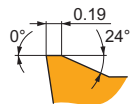

HM geometrie mit positiven Design für mittlere bis instabile Schnittbedingungen.

APKT 160404-HM:M8340	⊕ 0.4	160	0.30	6.0	95	0.27	6.0	150	0.30	6.0	–	–	–	40	0.24	4.8	–	–	–
APKT 160416-HM:M8340	⊕ 1.6	210	0.30	6.0	125	0.27	6.0	195	0.30	6.0	–	–	–	50	0.24	4.8	–	–	–
APKT 160431-HM:M8340	⊕ 3.1	220	0.30	6.0	130	0.27	6.0	205	0.30	6.0	–	–	–	55	0.24	4.8	–	–	–
APKT 1604PDR-HM:8215	⊕ 0.8	220	0.30	6.0	130	0.27	6.0	205	0.30	6.0	–	–	–	55	0.24	4.8	–	–	–
APKT 1604PDR-HM:M5315	● 0.8	270	0.30	6.0	–	–	–	255	0.30	6.0	–	–	–	–	–	–	–	–	–
APKT 1604PDR-HM:M8330	⊕ 0.8	220	0.30	6.0	130	0.27	6.0	205	0.30	6.0	–	–	–	55	0.24	4.8	–	–	–
APKT 1604PDR-HM:M8340	⊕ 0.8	200	0.30	6.0	120	0.27	6.0	190	0.30	6.0	–	–	–	50	0.24	4.8	–	–	–
APKT 1604PDR-HM:M9325	⊕ 0.8	260	0.30	6.0	–	–	–	245	0.30	6.0	–	–	–	–	–	–	–	–	–

APET 16-FA



	W1 (mm)	D1 (mm)	L (mm)	S (mm)
1604	9.600	4.50	17.00	4.76

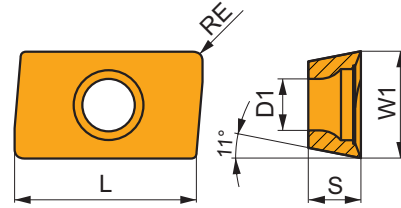

Eignung und Startwerte für Schnittgeschwindigkeit (vc), Vorschub (f) und Schnitttiefe (ap). Weitere Informationen finden Sie in unserer Zerspanungsrechner-App.

Produkt	RE (mm)	P			M			K			N			S			H		
		vc (m/min)	f (mm/tooth)	ap (mm)	vc (m/min)	f (mm/tooth)	ap (mm)	vc (m/min)	f (mm/tooth)	ap (mm)	vc (m/min)	f (mm/tooth)	ap (mm)	vc (m/min)	f (mm/tooth)	ap (mm)	vc (m/min)	f (mm/tooth)	ap (mm)

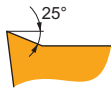

FA geometrie mit hoch positiven Design zur feinen Schlichtbearbeitung bis zur mittleren Bearbeitung.

APET 160408FR-FA:HF7	● 0.8										■ 255	0.24	8.0						
-----------------------------	-------	--	--	--	--	--	--	--	--	--	-------	------	-----	--	--	--	--	--	--



a_e / DC	5 %	10 %	15 %	20 %	25 %	30 %	40 %	50 %	60 %	70 %	75 %	80 %	90 %	100 %
	1.48	1.35	1.27	1.22	1.19	1.16	1.11	1.08	1.05	1.03	1.00	1.00	1.00	1.00
	2.20	1.60	1.35	1.20	1.10	0.95	0.85	0.75	0.85	0.95	1.00	1.00	1.00	1.00
	0.64	0.64	0.64	0.64	0.64	0.65	0.65	0.67	0.68	0.71	0.72	0.74	0.79	1.00

	APKT 16-GM	APKT 16-HM			
	0.8	0.4	0.8	1.6	3.1
	1.39	1.87	1.48	0.64	1.30

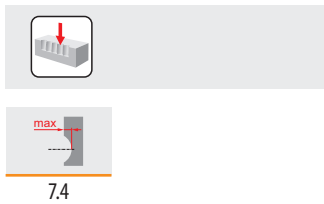
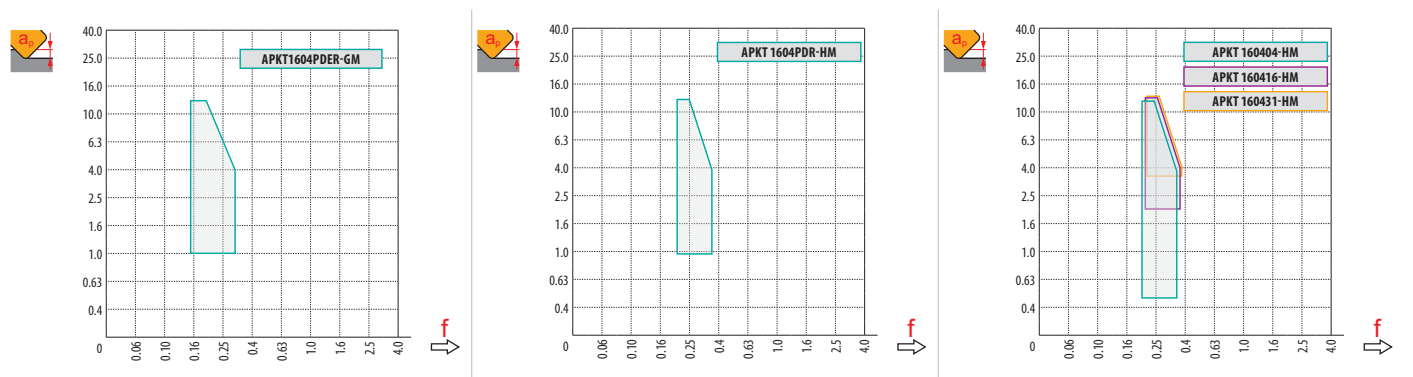

	1.0	6.0	13.0
	0.28	0.19	0.13





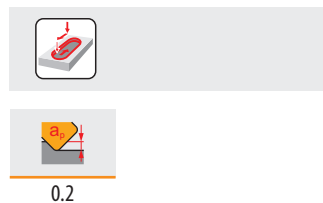





DC	DMIN	DMAX		
			DMIN	DMAX
25	34.7	50.0	1.2	3.1
32	48.5	64.0	0.9	1.7
40	63.5	80.0	1.3	2.2
50	83.5	100.0	0.9	1.4
63	110.0	126.0	1.0	1.4
80	144.0	160.0	1.1	1.3

DC	RPMX	APMX/I
25	2.3	3.9/100
32	1.0	1.6/100
40	1.0	1.6/100
50	0.5	0.7/100
63	0.4	0.5/100
80	0.3	0.4/100



WENDEPLATTENFRÄSER – AUSWAHLHILFE

PLANFRÄSEN

	SSO09	SSD12	FTB27X			
	90°		90°		90°	
	APMX (mm) 8.0	APMX (mm) 10.0	APMX (mm) 18.0			
	DC (mm) 20 – 80	DC (mm) 50 – 160	DC (mm) 175, 260			
Zylindrischer Schaft						
Weldon		DC = 20 – 32 (mm)				
Modular						
Aufsteckfräser						
Seite	122	125	128			
ISO	P M K S	P M K N S	P M K			
Schneidplattenform						
Wendeschneidplatten	SOMT 09T3	SDMT 1205	TBMR 2707			
Anzahl der Schneiden	4	4	3			
Flaches Eckfräsen 	■	■	■			
Flaches Nutfräsen 	■	■	▣			
Tauchfräsen 	■	■				
Planfräsen 	▣	▣	▣			

SS009

P M K S

PRAMET

S



90° Eckfräser für SOMT 09 Wendeschneidplatten mit Innenkühlung

90° Schaftfräser und Messerköpfe mit positiven SOMT 09 Wendeschneidplatten und APMX von 8 mm. Geeignet fürs Plan-, Schulter-, Nut- und Tauchfräsen. Erhältlich mit Weldonschaft und als Aufsteckfräser mit ungleicher Teilung. Für längere Standzeiten ist der Körper oberflächenbehandelt.

KAPR	90°
APMX	8.0 mm

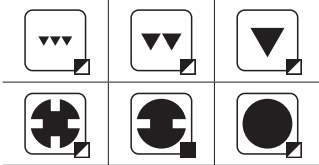
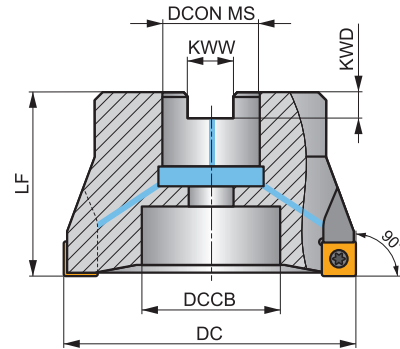
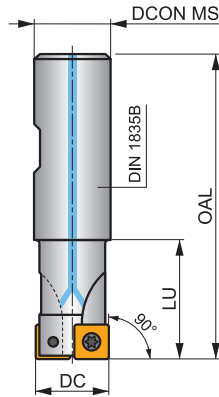
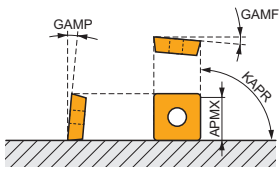

h_m	0.07 - 0.18				
h_m	0.07 - 0.22				

Produkt	DC	OAL	DCON MS	DCCB	LU	LF	KWW	KWD	GAMP	GAMP								
	(mm)	(mm)	(mm)	(mm)	(mm)	(mm)	(mm)	(mm)	(°)	(°)			kg					
20A2R032B20-SS009-C	20	82	20	-	32	-	-	-	-12	6	2	-	23800	✓	0.21	GI146	SQ400	-
25A3R042B25-SS009-C	25	98	25	-	42	-	-	-	-12	6	3	-	21300	✓	0.31	GI146	SQ400	-
32A4R042B32-SS009-C	32	102	32	-	42	-	-	-	-10	10	4	✓	18800	✓	0.55	GI146	SQ400	-
40A05R-S90S009-C	40	-	16	14	-	40	8.4	5.6	-9.1	10	5	-	16800	✓	0.29	GI146	SQ402	-
50A06R-S90S009-C	50	-	22	18	-	40	10.4	6.4	-8.8	10	6	-	15100	✓	0.33	GI146	SQ403	-
63A07R-S90S009-C	63	-	22	18	-	40	10.4	6.4	-8.6	10	7	-	13400	✓	0.62	GI146	SQ403	-
80A09R-S90S009-C	80	-	27	38	-	50	12.4	7	-8.1	10	9	-	11900	✓	1.03	GI146	SQ401	AC001

	GI146		SOMT 09T3..
--	-------	--	-------------

SQ400	US 3006-T09P	2.0	M 3	6	-	-	Flag T09P	-
SQ401	US 3006-T09P	2.0	M 3	6	D-T07P/T09P	FG-15	-	-
SQ402	US 3006-T09P	2.0	M 3	6	D-T07P/T09P	FG-15	-	HS 0830C
SQ403	US 3006-T09P	2.0	M 3	6	D-T07P/T09P	FG-15	-	HS 1030C

	AC001		KS 1230		K.FMH27
--	-------	--	---------	--	---------

SOMT 09



	IC (mm)	D1 (mm)	L (mm)	S (mm)
09T3	9.550	3.50	9.55	3.97

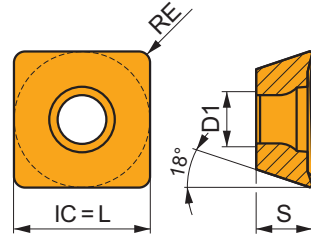

Eignung und Startwerte für Schnittgeschwindigkeit (vc), Vorschub (f) und Schnitttiefe (ap). Dies gilt für einen Einstellwinkel von 90°. Weitere Berechnungen finden Sie in unserer App.

Produkt	RE (mm)	P			M			K			N			S			H		
		vc (m/min)	f (mm/tooth)	ap (mm)	vc (m/min)	f (mm/tooth)	ap (mm)	vc (m/min)	f (mm/tooth)	ap (mm)	vc (m/min)	f (mm/tooth)	ap (mm)	vc (m/min)	f (mm/tooth)	ap (mm)	vc (m/min)	f (mm/tooth)	ap (mm)

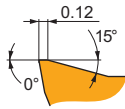
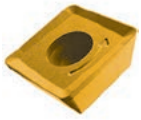

M geometrie mit positiven Design zur mittleren Bearbeitung.

SOMT 09T308-M:8215	0.8	275	0.14	2.5	165	0.13	2.5	260	0.14	2.5	-	-	-	65	0.13	2.0	-	-	-
SOMT 09T308-M:M5315	0.8	390	0.14	2.5	-	-	-	370	0.14	2.5	-	-	-	-	-	-	-	-	-
SOMT 09T308-M:M8330	0.8	270	0.14	2.5	160	0.13	2.5	255	0.14	2.5	-	-	-	65	0.13	2.0	-	-	-
SOMT 09T308-M:M8340	0.8	250	0.14	2.5	150	0.13	2.5	235	0.14	2.5	-	-	-	60	0.13	2.0	-	-	-
SOMT 09T308-M:M9315	0.8	380	0.14	2.5	-	-	-	360	0.14	2.5	-	-	-	-	-	-	-	-	-

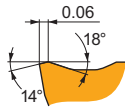
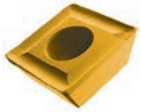

MI geometrie mit stabilen positiven Design zur mittleren Bearbeitung.

SOMT 09T304-MI:8215	0.4	230	0.14	2.5	135	0.13	2.5	215	0.14	2.5	-	-	-	55	0.10	2.0	-	-	-
SOMT 09T304-MI:M8310	0.4	255	0.14	2.5	130	0.13	2.5	240	0.14	2.5	-	-	-	-	-	-	-	-	-
SOMT 09T304-MI:M8330	0.4	230	0.14	2.5	135	0.13	2.5	215	0.14	2.5	-	-	-	55	0.10	2.0	-	-	-
SOMT 09T304-MI:M8340	0.4	210	0.14	2.5	125	0.13	2.5	195	0.14	2.5	-	-	-	50	0.10	2.0	-	-	-
SOMT 09T304-MI:M9315	0.4	320	0.14	2.5	-	-	-	300	0.14	2.5	-	-	-	-	-	-	-	-	-
SOMT 09T304-MI:M9340	0.4	265	0.14	2.5	155	0.13	2.5	-	-	-	-	-	-	65	0.10	2.0	-	-	-

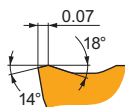
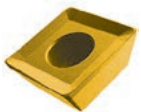

P geometrie mit sehr positiven Design zur mittleren Bearbeitung.

SOMT 09T304-P:M8330	0.4	250	0.14	2.5	150	0.13	2.5	235	0.14	2.5	-	-	-	60	0.10	2.0	-	-	-
SOMT 09T304-P:M8340	0.4	230	0.14	2.5	135	0.13	2.5	215	0.14	2.5	-	-	-	55	0.10	2.0	-	-	-
SOMT 09T304-P:M9325	0.4	320	0.14	2.5	-	-	-	300	0.14	2.5	-	-	-	-	-	-	-	-	-



a_e / DC	5 %	10 %	15 %	20 %	25 %	30 %	40 %	50 %	60 %	70 %	75 %	80 %	90 %	100 %
	1.48	1.35	1.27	1.22	1.19	1.16	1.11	1.08	1.05	1.03	1.00	1.00	1.00	1.00
	2.20	1.60	1.35	1.20	1.10	0.95	0.85	0.75	0.85	0.95	1.00	1.00	1.00	1.00
	0.64	0.64	0.64	0.64	0.64	0.65	0.65	0.67	0.68	0.71	0.72	0.74	0.79	1.00

	SOMT 09-M	SOMT 09-MI	SOMT 09-P
	0.8	0.4	0.4
	0.90	1.30	1.30

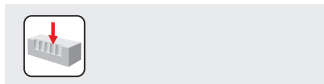
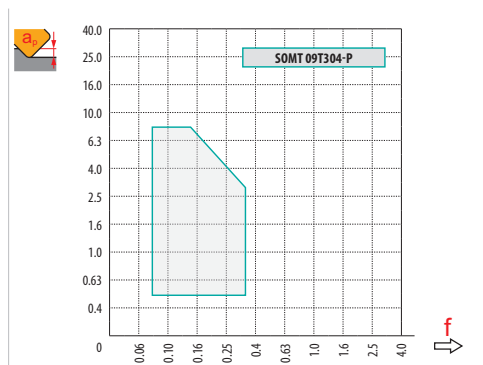
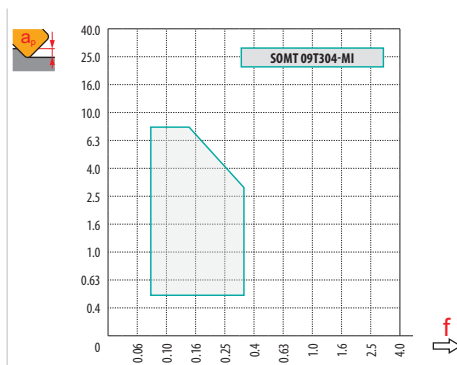
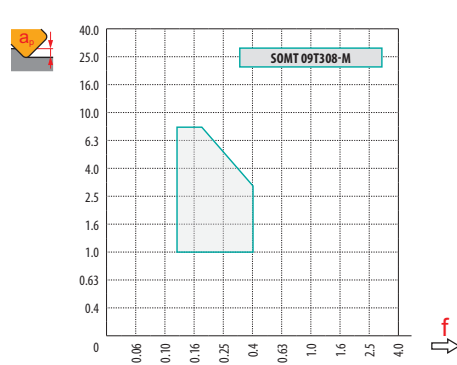

max.
 6.0

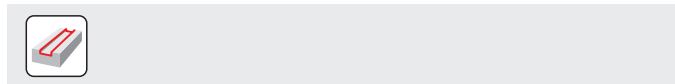

	1.0	4.0	8.0
	0.28	0.19	0.09

SSD12

P M K N S

PRAMET

S



90° Eckfräser für SDMT 12 Wendeschneidplatten mit Innenkühlung

90° Messerkopf mit positiven SDMT 12 Wendeschneidplatten und APMX von 10 mm. Geeignet fürs Plan-, Schulter-, Nut- und Tauchfräsen. Erhältlich als Aufsteckfräser. Für längere Standzeiten ist der Körper oberflächenbehandelt.

KAPR	90°
APMX	10.0 mm

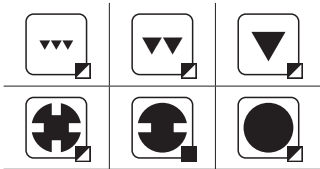
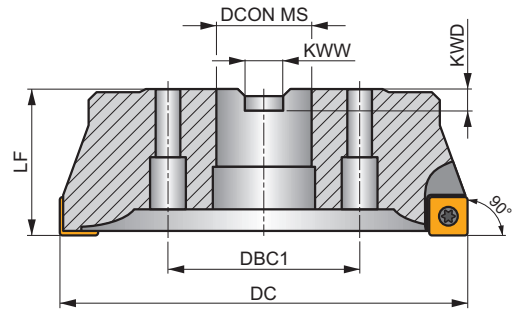
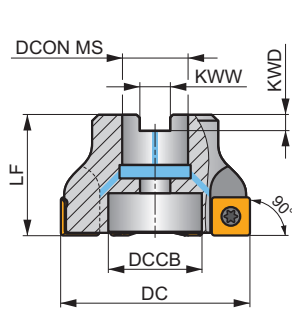
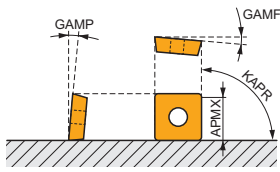

0.09 - 0.25



Produkt	DC	LF	DCON MS	DCCB	DBC1	KWW	KWD	GAMP	GAMP					kg			
	(mm)	(mm)	(mm)	(mm)	(mm)	(mm)	(mm)	(°)	(°)								
50A05R-S90SD12-C	50	40	22	18	-	10.4	6.3	-5	8	5	-	13000	✓	0.34	GI057	SQ413	-
63A06R-S90SD12-C	63	40	22	18	-	10.4	6.3	-5	8	6	-	11600	✓	0.53	GI057	SQ413	-
80A06R-S90SD12-C	80	50	27	38	-	12.4	7	-5	8	6	-	10300	✓	1.16	GI057	SQ411	AC001
100A08R-S90SD12-C	100	50	32	45	-	14.4	8	-5	8	8	-	9200	✓	1.69	GI057	SQ411	AC002
125A09R-S90SD12-C	125	63	40	56	-	16.4	9	-5	8	9	-	8300	✓	3.19	GI057	SQ411	AC003
160C12R-S90SD12	160	63	40	-	66.7	16.4	9	-5	8	12	-	7300	-	5.70	GI057	SQ411	-

	GI057		SDMT 1205..
--	-------	--	-------------

SQ411	SSN 100312	MS 3510	HXK 3.5	US 3511-T15	3.0	M 3.5	11	D-T07/T15	FG-15	-
SQ413	-	-	-	US 3511-T15	3.0	M 3.5	11	D-T07/T15	FG-15	HS 1030C

AC001	KS 1230	K.FMH27
AC002	KS 1635	K.FMH32
AC003	KS 2040	K.FMH40

SDMT 12



	IC	D1	L	S
	(mm)	(mm)	(mm)	(mm)
1205	12.700	4.40	12.70	5.00

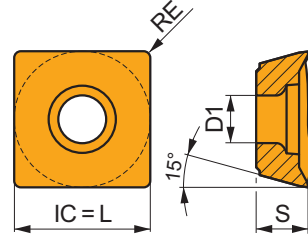

Eignung und Startwerte für Schnittgeschwindigkeit (vc), Vorschub (f) und Schnitttiefe (ap). Weitere Informationen finden Sie in unserer Zerspanungsrechner-App.

Produkt	RE (mm)	P			M			K			N			S			H					
		vc	f	ap	vc	f	ap	vc	f	ap	vc	f	ap	vc	f	ap	vc	f	ap			
		(m/min)	(mm/tooth)	(mm)	(m/min)	(mm/tooth)	(mm)	(m/min)	(mm/tooth)	(mm)	(m/min)	(mm/tooth)	(mm)	(m/min)	(mm/tooth)	(mm)	(m/min)	(mm/tooth)	(mm)	(m/min)	(mm/tooth)	(mm)

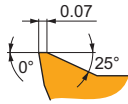

F positive geometrie zur leichten bis mittleren Bearbeitung.

SDMT 120508SR-F-M8330	0.8	275	0.10	3.0	165	0.09	3.0	260	0.10	3.0	825	0.12	3.0	65	0.08	2.4	-	-	-
SDMT 120508SR-F-M8340	0.8	250	0.10	3.0	150	0.09	3.0	235	0.10	3.0	-	-	-	60	0.08	2.4	-	-	-

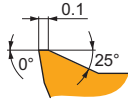
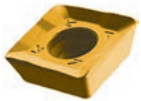

M geometrie mit positiven Design zur leichten bis mittleren Bearbeitung.

SDMT 120508SR-M-M8215	0.8	245	0.16	3.5	145	0.14	3.5	230	0.16	3.5	-	-	-	60	0.11	2.8	-	-	-
SDMT 120508SR-M-M8330	0.8	240	0.16	3.5	140	0.14	3.5	225	0.16	3.5	-	-	-	60	0.11	2.8	-	-	-
SDMT 120508SR-M-M8340	0.8	220	0.16	3.5	130	0.14	3.5	205	0.16	3.5	-	-	-	55	0.11	2.8	-	-	-
SDMT 120508SR-M-M9325	0.8	305	0.16	3.5	-	-	-	285	0.16	3.5	-	-	-	-	-	-	-	-	-

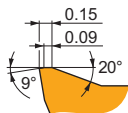

R geometrie mit stabilen positiven Design zur mittleren Bearbeitung.

SDMT 120508PR-R-M8330	0.8	220	0.25	3.5	130	0.23	3.5	205	0.25	3.5	-	-	-	55	0.23	2.8	-	-	-
SDMT 120508PR-R-M8340	0.8	195	0.25	3.5	115	0.23	3.5	185	0.25	3.5	-	-	-	45	0.23	2.8	-	-	-
SDMT 120508PR-R-M9315	0.8	280	0.25	3.5	-	-	-	265	0.25	3.5	-	-	-	-	-	-	-	-	-
SDMT 120508PR-R-M9325	0.8	265	0.25	3.5	-	-	-	250	0.25	3.5	-	-	-	-	-	-	-	-	-



a_e / DC	5 %	10 %	15 %	20 %	25 %	30 %	40 %	50 %	60 %	70 %	75 %	80 %	90 %	100 %
	1.48	1.35	1.27	1.22	1.19	1.16	1.11	1.08	1.05	1.03	1.00	1.00	1.00	1.00
	2.20	1.60	1.35	1.20	1.10	0.95	0.85	0.75	0.85	0.95	1.00	1.00	1.00	1.00
	0.64	0.64	0.64	0.64	0.64	0.65	0.65	0.67	0.68	0.71	0.72	0.74	0.79	1.00

	SDMT 12-F	SDMT 12-M	SDMT 12-R
	0.8	0.8	0.8
	—	—	—

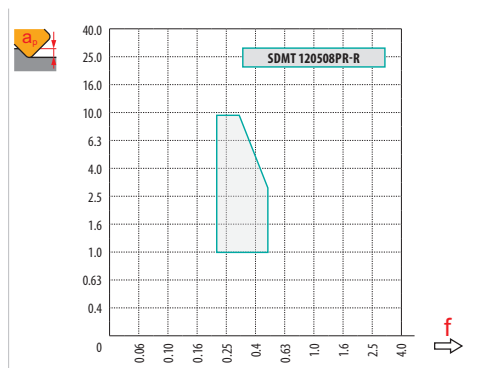
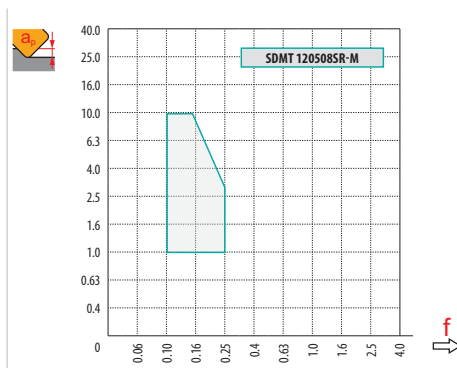
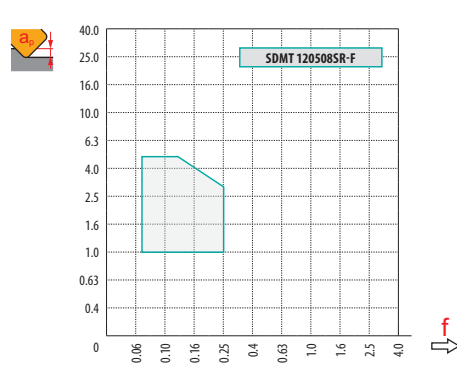

max

8.0

	1.0	5.0	10.0
	0.39	0.25	0.14

FTB27X



PRAMET



ROUGH TB Eckfräser für TBMR 27 Wendeschneidplatten zum schweren Fräsen

90° Messerkopf mit positiven TBMR 27 Wendeschneidplatten und APMX von 18 mm. Geeignet für das schwere Planen, Schulter- und Nutfräsen. Erhältlich als Aufsteckfräser mit ungleicher Teilung. Für längere Standzeiten ist der Körper oberflächenbehandelt.

ROUGH TB

KAPR	90°
APMX	18.0 mm

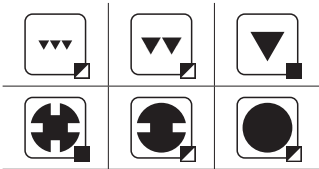
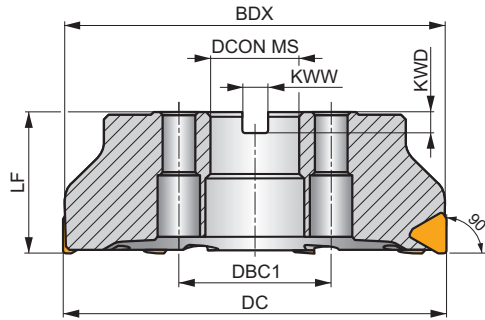
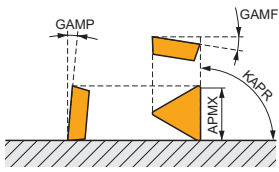

0.15 - 0.38



Produkt	DC	BDX	LF	D CON MS	DCCB	DBC1	KWW	KWD	GAMF	GAMP								
	(mm)	(mm)	(mm)	(mm)	(mm)	(mm)	(mm)	(mm)	(°)	(°)								
175C08R-F90TB27X	175	169.6	63	40	-	66.7	16.4	16.4	-9	9	8	✓	-	-	7.59	G1163	SQ424	-
260C12R-F90TB27X	260	253.4	63	60	-	101.6	25.7	25.7	-9	9	12	✓	-	-	18.21	G1163	SQ425	-

G1163	TBMR 2707PZ..																	

SQ424	LNK 220616	US 6013-T20P	SDR T20P-T	KU TBMR 2707	DS 01Z	KL 04	HS 1240
SQ425	LNK 220616	US 6013-T20P	SDR T20P-T	KU TBMR 2707	DS 01Z	KL 04	HS 1655

TBMR 27



	BS (mm)	IC (mm)	L (mm)	M (mm)	S (mm)
2707	4.61	15.875	27.50	3.2	7.94

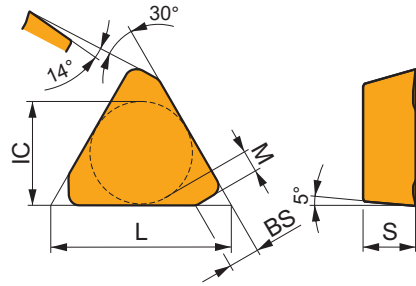

Eignung und Startwerte für Schnittgeschwindigkeit (vc), Vorschub (f) und Schnitttiefe (ap). Weitere Informationen finden Sie in unserer Zerspanungsrechner-App.

Produkt	RE (mm)	P			M			K			N			S			H		
		vc (m/min)	f (mm/tooth)	ap (mm)	vc (m/min)	f (mm/tooth)	ap (mm)	vc (m/min)	f (mm/tooth)	ap (mm)	vc (m/min)	f (mm/tooth)	ap (mm)	vc (m/min)	f (mm/tooth)	ap (mm)	vc (m/min)	f (mm/tooth)	ap (mm)

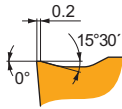

PZSR starke Ausführung zur schweren Bearbeitung.

TBMR 2707PZSR:M8326	☹	–	☑	130	0.20	11.0	–	–	–	☑	120	0.20	11.0	–	–	–	–	–	–	–	–	–	–
TBMR 2707PZSR:M8346	☹	–	☑	110	0.20	11.0	☑	65	0.20	11.0	–	–	–	–	–	–	–	–	–	–	–	–	–



a_e / DC	5 %	10 %	15 %	20 %	25 %	30 %	40 %	50 %	60 %	70 %	75 %	80 %	90 %	100 %
	1.48	1.35	1.27	1.22	1.19	1.16	1.11	1.08	1.05	1.03	1.00	1.00	1.00	1.00
	2.20	1.60	1.35	1.20	1.10	0.95	0.85	0.75	0.85	0.95	1.00	1.00	1.00	1.00
	0.64	0.64	0.64	0.64	0.64	0.65	0.65	0.67	0.68	0.71	0.72	0.74	0.79	1.00

	TBMR 27
	-
	2.70

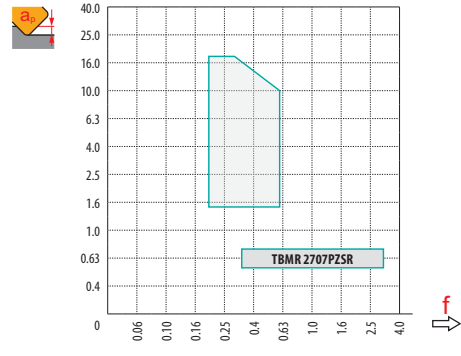

	1.5	8.0	18.0
	0.60	0.39	0.24



TIEFES ECKFRÄSEN

WENDEPLATTENFRÄSER – AUSWAHLHILFE

PLANFRÄSEN

	J(T)-SAD11E	J(T)-SAD16E	J(T)-SSAP	J(T)-CSD12X	J(T)-SLSN	
	90°		90°		90°	
	APMX (mm) 37.0 – 56.0	APMX (mm) 40.0 – 108.0	APMX (mm) 58.0 – 95.0	APMX (mm) 44.1 – 87.3	APMX (mm) 104.0 – 134.0	
	DC (mm) 25 – 50	DC (mm) 50 – 100	DC (mm) 50 – 80	DC (mm) 40 – 80	DC (mm) 63, 80	
Zylindrischer Schaft	DC = 25 – 40 (mm)					
Weldon	DC = 25 – 40 (mm)			DC = 50 (mm)		
Modular		DC = 50 – 80 (mm)		DC = 40 – 63 (mm)		
Aufsteckfräser	DC = 50 (mm)	DC = 50 – 100 (mm)		DC = 50 – 80 (mm)		
Seite	134	139	145	150	153	
ISO	P M K N S H	P M K N S H	P M K N S H	P M S	P K	
Schneidplattenform						
Wendeschneidplatten	AD 11T3	AD.. 1606	APE. 150412 SPE. 1204	SD.X 1205	LNET 1606 SN.. 1305	
Anzahl der Schneiden	2	2	2 / 4	4	2 / 8	
Tiefes Eckfräsen	■	■	■	■	■	
Tiefes Nutfräsen	■	■	■	■	■	
Planfräsen	▣	▣	▣	▣	▣	
Tauchfräsen	▣	▣	▣		▣	

J(T)-SAD11E



PRAMET



HELICAL AD11 Walzenstirnfräser mit Innenkühlung

90° Walzenstirnfräser mit positiven ADMX 11 Wendeschneidplatten mit APMX von 36 bis 56 mm und Innenkühlung. Geeignet fürs Schulter-, Nut-, Plan- und Tauchfräsen. Erhältlich mit Weldon- oder Morsekegelschaft und als Aufsteckfräser. Für längere Standzeiten ist der Körper oberflächenbehandelt.

FORCE AD

KAPR	90°
APMX	37.0 - 56.0 mm

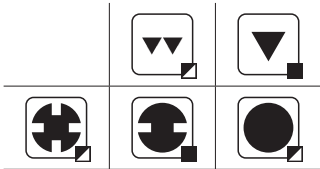
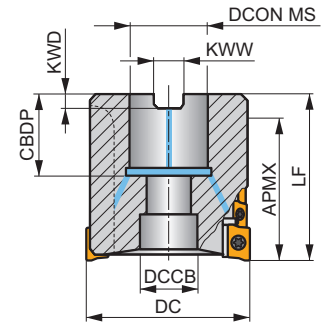
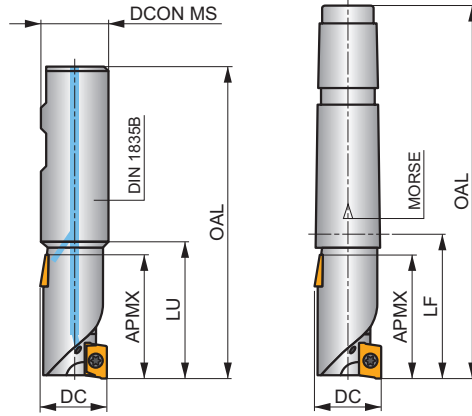
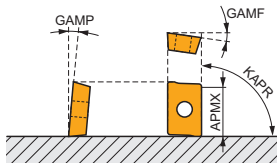

	0.05 - 0.08				
	0.05 - 0.08				

Produkt	DC	OAL	DCON MS	DCCB	LU	LF	APMX	CBDDP	CZC MS	GAMF	GAMP	NOF							
	(mm)	(mm)	(mm)	(mm)	(mm)	(mm)	(mm)	(mm)	(mm)	(°)	(°)								
25J2R50B25-SAD11E38-C	25	106	25	-	50	-	38.00	-	-	-10.5	5	2	8	-	24100	✓	0.32	G1184	SQ210
32J2R60B32-SAD11E47-C	32	120	32	-	60	-	47.00	-	-	-9	8	2	10	-	21300	✓	0.60	G1184	SQ210
40J2R60B40-SAD11E47-C	40	130	40	-	60	-	47.00	-	-	-8.1	11	2	10	-	19100	✓	1.07	G1184	SQ210
40J3R70B32-SAD11E56-C	40	130	32	-	70	-	56.00	-	-	-8.1	11	3	18	-	19100	✓	0.76	G1184	SQ210
40J3R70B40-SAD11E56-C	40	140	40	-	70	-	56.00	-	-	-8.1	11	3	18	-	19100	✓	1.07	G1184	SQ210
25J2R55E03-SAD11E38-C	25	136	-	-	-	55	38.00	-	3	-10.5	5	2	8	-	24100	✓	0.32	G1184	SQ210
32J2R65E04-SAD11E47-C	32	167.5	-	-	-	65	47.00	-	4	-9	8	2	10	-	21300	✓	0.71	G1184	SQ210
40J3R75E04-SAD11E56-C	40	177.5	-	-	-	75	56.00	-	4	-8.1	11	3	18	-	19100	✓	0.85	G1184	SQ210
50T03R-S90AD11E37-C	50	-	22	18	-	58	37.00	21	-	-7.2	12	3	12	-	17000	✓	0.66	G1184	SQ903

G1184	ADMX 11T3..	ADEX 11T3..-FA

SQ210	US 2506-T07P	1.2	M 2.5	6.3	-	-	Flag T07P	-
SQ903	US 2506-T07P	1.2	M 2.5	6.3	D-T07P/T09P	FG-15	-	HS 1030C

ADMX 11



	W1 (mm)	D1 (mm)	L (mm)	S (mm)
11T3	6.530	2.90	11.00	3.97

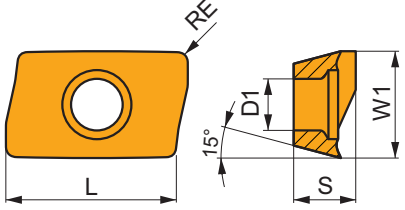

Eignung und Startwerte für Schnittgeschwindigkeit (vc), Vorschub (f) und Schnitttiefe (ap). Weitere Informationen finden Sie in unserer Zerspanungsrechner-App.

Produkt	RE (mm)	P			M			K			N			S			H		
		vc (m/min)	f (mm/tooth)	ap (mm)	vc (m/min)	f (mm/tooth)	ap (mm)	vc (m/min)	f (mm/tooth)	ap (mm)	vc (m/min)	f (mm/tooth)	ap (mm)	vc (m/min)	f (mm/tooth)	ap (mm)	vc (m/min)	f (mm/tooth)	ap (mm)

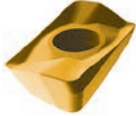

F geometrie mit sehr scharfen und positiven Design zur leichten Bearbeitung.

ADMX 11T304SR-F:8215	● 0.4	245	0.10	2.0	145	0.09	2.0	230	0.10	2.0	735	0.12	2.0	60	0.08	1.6	–	–	–
ADMX 11T304SR-F:M8330	● 0.4	240	0.10	2.0	140	0.09	2.0	225	0.10	2.0	720	0.12	2.0	60	0.08	1.6	–	–	–
ADMX 11T304SR-F:M8340	● 0.4	220	0.10	2.0	130	0.09	2.0	205	0.10	2.0	–	–	–	55	0.08	1.6	–	–	–
ADMX 11T304SR-F:M9340	● 0.4	285	0.10	2.0	170	0.09	2.0	–	–	–	–	–	–	70	0.08	1.6	–	–	–
ADMX 11T308SR-F:8215	⊕ 0.8	290	0.10	2.0	170	0.09	2.0	275	0.10	2.0	870	0.12	2.0	70	0.08	1.6	–	–	–
ADMX 11T308SR-F:M8330	⊕ 0.8	285	0.10	2.0	170	0.09	2.0	270	0.10	2.0	855	0.12	2.0	70	0.08	1.6	–	–	–
ADMX 11T308SR-F:M8340	⊕ 0.8	260	0.10	2.0	155	0.09	2.0	245	0.10	2.0	–	–	–	65	0.08	1.6	–	–	–
ADMX 11T308SR-F:M9340	⊕ 0.8	340	0.10	2.0	200	0.09	2.0	–	–	–	–	–	–	85	0.08	1.6	–	–	–

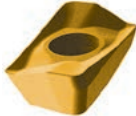

M geometrie mit positiven Design zur leichten bis mittleren Bearbeitung.

ADMX 11T302SR-M:M8330	● 0.2	190	0.15	4.0	110	0.14	4.0	180	0.15	4.0	–	–	–	45	0.12	3.2	–	–	–
ADMX 11T302SR-M:M8340	⊕ 0.2	170	0.15	4.0	100	0.14	4.0	160	0.15	4.0	–	–	–	40	0.12	3.2	–	–	–
ADMX 11T304SR-M:8215	● 0.4	205	0.15	4.0	120	0.14	4.0	190	0.15	4.0	–	–	–	50	0.12	3.2	–	–	–
ADMX 11T304SR-M:M8310	● 0.4	220	0.15	4.0	110	0.14	4.0	205	0.15	4.0	–	–	–	–	–	–	–	–	–
ADMX 11T304SR-M:M8330	⊕ 0.4	205	0.15	4.0	120	0.14	4.0	190	0.15	4.0	–	–	–	50	0.12	3.2	–	–	–
ADMX 11T304SR-M:M8340	⊕ 0.4	185	0.15	4.0	110	0.14	4.0	175	0.15	4.0	–	–	–	45	0.12	3.2	–	–	–
ADMX 11T304SR-M:M9325	● 0.4	255	0.15	4.0	–	–	–	240	0.15	4.0	–	–	–	–	–	–	–	–	–
ADMX 11T304SR-M:M9340	● 0.4	235	0.15	4.0	140	0.14	4.0	–	–	–	–	–	–	55	0.12	3.2	–	–	–
ADMX 11T308SR-M:8215	⊕ 0.8	245	0.15	4.0	145	0.14	4.0	230	0.15	4.0	–	–	–	60	0.12	3.2	–	–	–
ADMX 11T308SR-M:M5315	⊕ 0.8	335	0.15	4.0	–	–	–	315	0.15	4.0	–	–	–	–	–	–	–	–	–
ADMX 11T308SR-M:M8310	⊕ 0.8	265	0.15	4.0	135	0.14	4.0	250	0.15	4.0	–	–	–	–	–	–	–	–	–
ADMX 11T308SR-M:M8330	⊕ 0.8	245	0.15	4.0	145	0.14	4.0	230	0.15	4.0	–	–	–	60	0.12	3.2	–	–	–
ADMX 11T308SR-M:M8340	⊕ 0.8	220	0.15	4.0	130	0.14	4.0	205	0.15	4.0	–	–	–	55	0.12	3.2	–	–	–
ADMX 11T308SR-M:M9315	⊕ 0.8	330	0.15	4.0	–	–	–	310	0.15	4.0	–	–	–	–	–	–	–	–	–
ADMX 11T308SR-M:M9325	⊕ 0.8	305	0.15	4.0	–	–	–	285	0.15	4.0	–	–	–	–	–	–	–	–	–
ADMX 11T308SR-M:M9340	⊕ 0.8	275	0.15	4.0	165	0.14	4.0	–	–	–	–	–	–	65	0.12	3.2	–	–	–
ADMX 11T310SR-M:M8330	⊕ 1.0	255	0.15	4.0	150	0.14	4.0	240	0.15	4.0	–	–	–	60	0.12	3.2	–	–	–
ADMX 11T310SR-M:M8340	⊕ 1.0	230	0.15	4.0	135	0.14	4.0	215	0.15	4.0	–	–	–	55	0.12	3.2	–	–	–
ADMX 11T312SR-M:8215	⊕ 1.2	255	0.15	4.0	150	0.14	4.0	240	0.15	4.0	–	–	–	60	0.12	3.2	–	–	–
ADMX 11T312SR-M:M8330	⊕ 1.2	255	0.15	4.0	150	0.14	4.0	240	0.15	4.0	–	–	–	60	0.12	3.2	–	–	–
ADMX 11T312SR-M:M8340	⊕ 1.2	230	0.15	4.0	135	0.14	4.0	215	0.15	4.0	–	–	–	55	0.12	3.2	–	–	–
ADMX 11T316SR-M:8215	⊕ 1.6	270	0.15	4.0	160	0.14	4.0	255	0.15	4.0	–	–	–	65	0.12	3.2	–	–	–
ADMX 11T316SR-M:M6330	⊕ 1.6	230	0.15	4.0	165	0.14	4.0	–	–	–	–	–	–	65	0.12	3.2	–	–	–
ADMX 11T316SR-M:M8310	⊕ 1.6	295	0.15	4.0	150	0.14	4.0	280	0.15	4.0	–	–	–	–	–	–	–	–	–
ADMX 11T316SR-M:M8330	⊕ 1.6	270	0.15	4.0	160	0.14	4.0	255	0.15	4.0	–	–	–	65	0.12	3.2	–	–	–
ADMX 11T316SR-M:M8340	⊕ 1.6	240	0.15	4.0	140	0.14	4.0	225	0.15	4.0	–	–	–	60	0.12	3.2	–	–	–
ADMX 11T320SR-M:M6330	⊕ 2.0	240	0.15	4.0	170	0.14	4.0	–	–	–	–	–	–	70	0.12	3.2	–	–	–
ADMX 11T320SR-M:M8330	⊕ 2.0	280	0.15	4.0	165	0.14	4.0	265	0.15	4.0	–	–	–	70	0.12	3.2	–	–	–
ADMX 11T320SR-M:M8340	⊕ 2.0	255	0.15	4.0	150	0.14	4.0	240	0.15	4.0	–	–	–	60	0.12	3.2	–	–	–

Eignung und Startwerte für Schnittgeschwindigkeit (vc), Vorschub (f) und Schnitttiefe (ap). Weitere Informationen finden Sie in unserer Zerspanungsrechner-App.

Produkt	RE (mm)	P			M			K			N			S			H		
		vc (m/min)	f (mm/tooth)	ap (mm)	vc (m/min)	f (mm/tooth)	ap (mm)	vc (m/min)	f (mm/tooth)	ap (mm)	vc (m/min)	f (mm/tooth)	ap (mm)	vc (m/min)	f (mm/tooth)	ap (mm)	vc (m/min)	f (mm/tooth)	ap (mm)

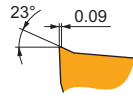
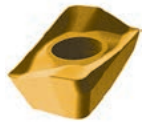

M geometrie mit positiven Design zur leichten bis mittleren Bearbeitung.

ADMX 11T325SR-M:M6330	2.5	240	0.15	4.0	170	0.14	4.0	-	-	-	-	-	-	70	0.12	3.2	-	-	-
ADMX 11T325SR-M:M8340	2.5	255	0.15	4.0	150	0.14	4.0	240	0.15	4.0	-	-	-	60	0.12	3.2	-	-	-
ADMX 11T330SR-M:M6330	3.0	240	0.15	4.0	170	0.14	4.0	-	-	-	-	-	-	70	0.12	3.2	-	-	-
ADMX 11T330SR-M:M8330	3.0	280	0.15	4.0	165	0.14	4.0	265	0.15	4.0	-	-	-	70	0.12	3.2	-	-	-
ADMX 11T330SR-M:M8340	3.0	255	0.15	4.0	150	0.14	4.0	240	0.15	4.0	-	-	-	60	0.12	3.2	-	-	-

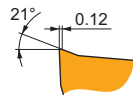
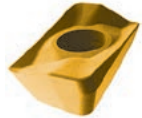

R geometrie mit positiven Design für weniger stabile Bearbeitungsbedingungen.

ADMX 11T308PR-R:R215	0.8	230	0.18	4.0	135	0.16	4.0	215	0.18	4.0	-	-	-	55	0.16	3.2	45	0.12	0.7
ADMX 11T308PR-R:M5315	0.8	310	0.18	4.0	-	-	-	290	0.18	4.0	-	-	-	-	-	-	60	0.13	0.7
ADMX 11T308PR-R:M8310	0.8	250	0.18	4.0	125	0.16	4.0	235	0.18	4.0	-	-	-	-	-	-	50	0.12	0.7
ADMX 11T308PR-R:M8330	0.8	230	0.18	4.0	135	0.16	4.0	215	0.18	4.0	-	-	-	55	0.16	3.2	45	0.12	0.7
ADMX 11T308PR-R:M8340	0.8	210	0.18	4.0	125	0.16	4.0	195	0.18	4.0	-	-	-	50	0.16	3.2	-	-	-
ADMX 11T308PR-R:M9315	0.8	310	0.18	4.0	-	-	-	290	0.18	4.0	-	-	-	-	-	-	60	0.13	0.7
ADMX 11T308PR-R:M9325	0.8	290	0.18	4.0	-	-	-	275	0.18	4.0	-	-	-	-	-	-	55	0.13	0.7
ADMX 11T316PR-R:R215	1.6	255	0.18	4.0	150	0.16	4.0	240	0.18	4.0	-	-	-	60	0.16	3.2	50	0.12	0.7
ADMX 11T316PR-R:M8330	1.6	255	0.18	4.0	150	0.16	4.0	240	0.18	4.0	-	-	-	60	0.16	3.2	50	0.12	0.7
ADMX 11T316PR-R:M9325	1.6	320	0.18	4.0	-	-	-	300	0.18	4.0	-	-	-	-	-	-	60	0.12	0.7

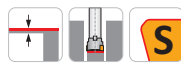
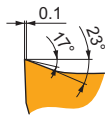

MF geometrie mit hoch positiven Design zur leichten bis zur Schlichtbearbeitung.

ADMX 11T304SR-MF:M6330	0.4	215	0.08	2.5	150	0.07	2.5	-	-	-	-	-	-	60	0.06	2.0	-	-	-
ADMX 11T304SR-MF:M8340	0.4	220	0.08	2.5	130	0.07	2.5	-	-	-	-	-	-	55	0.06	2.0	-	-	-
ADMX 11T308SR-MF:M6330	0.8	255	0.08	2.5	180	0.07	2.5	-	-	-	-	-	-	75	0.06	2.0	-	-	-
ADMX 11T308SR-MF:M8340	0.8	265	0.08	2.5	155	0.07	2.5	-	-	-	-	-	-	65	0.06	2.0	-	-	-

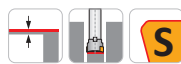
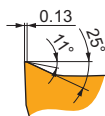

MM geometrie mit sehr positiven Design zur leichten bis mittleren Bearbeitung.

ADMX 11T304SR-MM:M6330	0.4	185	0.14	2.5	130	0.13	2.5	-	-	-	-	-	-	55	0.11	2.0	-	-	-
ADMX 11T304SR-MM:M8340	0.4	195	0.14	2.5	115	0.13	2.5	-	-	-	-	-	-	45	0.11	2.0	-	-	-
ADMX 11T308SR-MM:M6330	0.8	225	0.14	2.5	155	0.13	2.5	-	-	-	-	-	-	65	0.11	2.0	-	-	-
ADMX 11T308SR-MM:M8340	0.8	235	0.14	2.5	140	0.13	2.5	-	-	-	-	-	-	55	0.11	2.0	-	-	-
ADMX 11T308SR-MM:M8345	0.8	190	0.14	2.5	110	0.13	2.5	-	-	-	-	-	-	45	0.11	2.0	-	-	-
ADMX 11T308SR-MM:M9340	0.8	300	0.14	2.5	180	0.13	2.5	-	-	-	-	-	-	75	0.11	2.0	-	-	-
ADMX 11T312SR-MM:M6330	1.2	235	0.14	2.5	165	0.13	2.5	-	-	-	-	-	-	70	0.11	2.0	-	-	-
ADMX 11T312SR-MM:M8340	1.2	245	0.14	2.5	145	0.13	2.5	-	-	-	-	-	-	60	0.11	2.0	-	-	-

ADEX 11-FA



	W1 (mm)	D1 (mm)	L (mm)	S (mm)
11T3	6.450	2.90	9.70	3.91

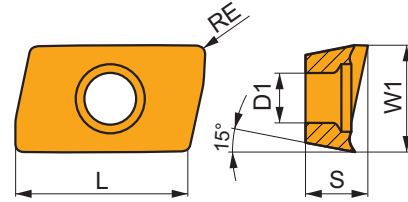

Eignung und Startwerte für Schnittgeschwindigkeit (vc), Vorschub (f) und Schnitttiefe (ap). Weitere Informationen finden Sie in unserer Zerspanungsrechner-App.

Produkt	RE (mm)	P			M			K			N			S			H		
		vc (m/min)	f (mm/tooth)	ap (mm)	vc (m/min)	f (mm/tooth)	ap (mm)	vc (m/min)	f (mm/tooth)	ap (mm)	vc (m/min)	f (mm/tooth)	ap (mm)	vc (m/min)	f (mm/tooth)	ap (mm)	vc (m/min)	f (mm/tooth)	ap (mm)

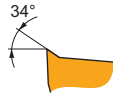

FA geometrie mit hoch positiven Design zur feinen Schlichtbearbeitung bis zur mittleren Bearbeitung.

ADEX 11T304FR-FA:HF7	● 0.4	—	—	—	—	—	—	—	—	—	■ 210	0.30	5.0	—	—	—	—	—	—
ADEX 11T304FR-FA:M0315	● 0.4	—	—	—	—	—	—	—	—	—	■ 480	0.30	5.0	—	—	—	—	—	—
ADEX 11T308FR-FA:HF7	● 0.8	—	—	—	—	—	—	—	—	—	■ 240	0.30	5.0	—	—	—	—	—	—
ADEX 11T308FR-FA:M0315	● 0.8	—	—	—	—	—	—	—	—	—	■ 570	0.30	5.0	—	—	—	—	—	—
ADEX 11T312FR-FA:HF7	● 1.2	—	—	—	—	—	—	—	—	—	■ 255	0.30	5.0	—	—	—	—	—	—
ADEX 11T316FR-FA:HF7	● 1.6	—	—	—	—	—	—	—	—	—	■ 270	0.18	5.0	—	—	—	—	—	—



a_e / DC	5 %	10 %	15 %	20 %	25 %	30 %	40 %	50 %	60 %	70 %	75 %	80 %	90 %	100 %
	0.89	0.81	0.76	0.73	0.71	0.70	0.67	0.65	0.63	0.62	0.60	0.60	0.60	0.45



	1		2.5		5		7.5		10		15		20	
	f_{min}	f_{max}	f_{min}	f_{max}	f_{min}	f_{max}	f_{min}	f_{max}	f_{min}	f_{max}	f_{min}	f_{max}	f_{min}	f_{max}
25	0.25	0.40	0.16	0.26	0.12	0.19	0.10	0.15	0.09	0.14	0.07	0.12	0.07	0.11
32	0.28	0.45	0.18	0.29	0.13	0.21	0.11	0.17	0.09	0.15	0.08	0.13	0.07	0.12
40	0.32	0.51	0.20	0.32	0.14	0.23	0.12	0.19	0.10	0.17	0.09	0.14	0.08	0.13
50	0.35	0.57	0.23	0.36	0.16	0.26	0.13	0.21	0.12	0.19	0.10	0.15	0.09	0.14

	25		32		40		50	
	f_{min}	f_{max}	f_{min}	f_{max}	f_{min}	f_{max}	f_{min}	f_{max}
25	0.08	0.13	-	-	-	-	-	-
32	0.07	0.11	0.08	0.13	-	-	-	-
40	0.07	0.12	0.07	0.11	0.08	0.13	-	-
50	0.08	0.13	0.07	0.12	0.07	0.11	0.08	0.13

	ADMX 11-F		ADMX 11-M									ADMX 11-R		ADMX 11-MF		ADMX 11-MM			ADEX 11-FA			
	0.4	0.8	0.2	0.4	0.8	1.0	1.2	1.6	2.0	2.5	3.0	0.8	1.6	0.4	0.8	0.4	0.8	1.2	0.4	0.8	1.2	1.6
	1.89	1.48	2.09	1.89	1.48	1.27	1.08	0.68	1.61	1.13	0.66	1.48	0.68	1.89	1.48	1.89	1.48	1.08	1.77	1.39	1.0	0.62



ISO				
25J2R50B25-SAD11E38-C	25	2	38	34.5
32J2R60B32-SAD11E47-C	32	2	47	43.5
40J2R60B40-SAD11E47-C	40	2	47	43.5
40J3R70B32-SAD11E56-C	40	3	56	52.5
40J3R70B40-SAD11E56-C	40	3	56	52.5
25J2R55E03-SAD11E38-C	25	2	38	34.5
32J2R65E04-SAD11E47-C	32	2	47	43.5
40J3R75E04-SAD11E56-C	40	3	56	52.5
50T03R-S90AD11E37-C	50	3	37	33.5



ADMX/ADEX 11	R
ADMX 11T320SR-M	1.0
ADMX 11T325SR-M	1.8
ADMX 11T330SR-M	1.8



	4.5
--	-----

J(T)-SAD16E



PRAMET

S



HELICAL AD16 Walzenstirnfräser mit Innenkühlung

90° Walzenstirnfräser mit positiven AD.. 16 Wendeschneidplatten mit APMX von 40 bis 108 mm und Innenkühlung. Geeignet fürs Schulter-, Nut-, Plan und Tauchfräsen. Erhältlich als Aufsteckfräser, DIN 69871, BT und DIN 2080 mit oder ohne ungleicher Teilung. Für längere Standzeiten ist der Körper oberflächenbehandelt.

FORCE AD

KAPR	90°
APMX	40.0 - 108.0 mm

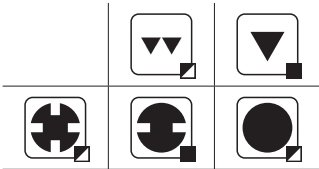
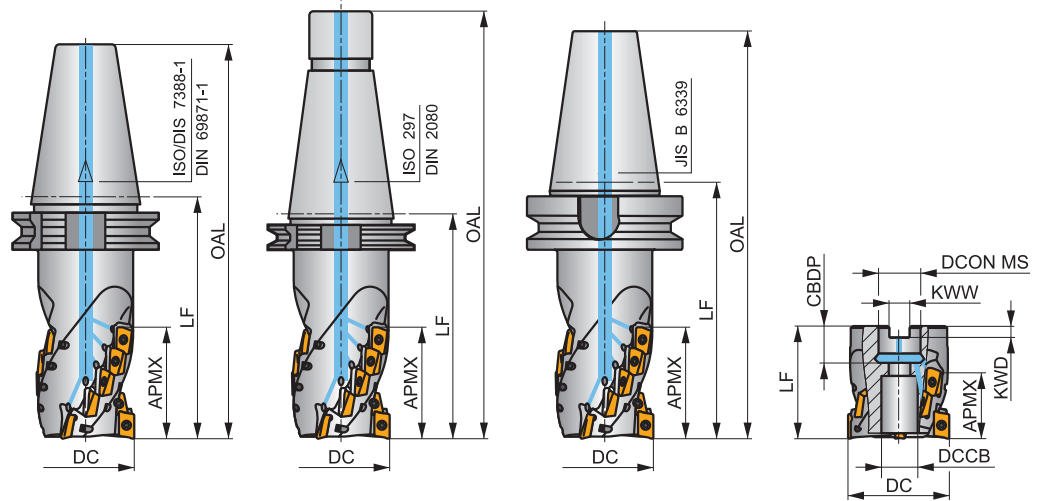
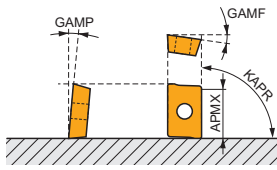

	0.08 - 0.1				
	0.08 - 0.1				

Produkt	DC	OAL	DCON MS	DCCB	LF	APMX	CBDP	CZC MS	GAME	GAMP	NOF							ISO 13399		
																		(mm)	(mm)	(mm)
50J3R100H50-SAD16E54-C	50	202	-	-	100	54.00	-	50	-6	12	3	12	-	13200	✓	4.08	GI282	SQ031		
50J3R140H50-SAD16E80-C	50	242	-	-	140	80.00	-	50	-6	12	3	18	-	13200	✓	4.38	GI282	SQ031		
63J3R140H50-SAD16E68-C	63	242	-	-	140	68.00	-	50	-6	12	3	15	-	11700	✓	5.34	GI282	SQ031		
63J3R155H50-SAD16E95-C	63	257	-	-	155	95.00	-	50	-6	12	3	21	-	11700	✓	5.43	GI282	SQ031		
80J4R165H50-SAD16E108-C	80	257	-	-	165	108.00	-	50	-6	12	4	32	✓	10400	✓	7.37	GI282	SQ031		
50J3R140G50-SAD16E80-C	50	267	-	-	140	80.00	-	50	-6	12	3	18	-	13200	✓	4.48	GI282	SQ031		
63J3R155G50-SAD16E95-C	63	282	-	-	155	95.00	-	50	-6	12	3	21	-	11700	✓	5.52	GI282	SQ031		
80J4R165G50-SAD16E108-C	80	292	-	-	165	108.00	-	50	-6	12	4	32	✓	10400	✓	7.51	GI282	SQ031		
50J3R140X50-SAD16E68-C	50	242	-	-	140	68.00	-	50	-6	12	3	15	-	13200	✓	5.28	GI282	SQ031		
63J3R155X50-SAD16E80-C	63	257	-	-	155	80.00	-	50	-6	12	3	18	-	11700	✓	6.19	GI282	SQ031		
80J4R165X50-SAD16E95-C	80	267	-	-	165	95.00	-	50	-6	12	4	28	✓	10400	✓	7.84	GI282	SQ031		
50T03R-S90AD16E40-C	50	-	22	18	70	40.00	21	-	-6	12	3	9	-	13200	✓	0.63	GI282	SQ913		
63T04R-S90AD16E40-C	63	-	27	22	70	40.00	22	-	-6	12	4	12	✓	11700	✓	1.14	GI282	SQ914		
63T04R-S90AD16E68-C	63	-	27	22	100	68.00	22	-	-6	12	4	20	✓	11700	✓	1.86	GI282	SQ914		
80T04R-S90AD16E55-C	80	-	32	30	85	55.00	25	-	-6	12	4	16	✓	10400	✓	2.56	GI282	SQ915		
80T04R-S90AD16E80-C	80	-	32	30	115	80.00	25	-	-6	12	4	24	✓	10400	✓	3.17	GI282	SQ915		
100T05R-S90AD16E80-C	100	-	40	36	120	80.00	30	-	-6	12	5	30	✓	9300	✓	5.31	GI282	SQ916		

GI282	ADMX 1606..	ADEX 1606..-FA	ADEX 1606..-FM

SQ031	US 4011-T15P	3.5	M 4	10.6	D-T08P/T15P	FG-15	-
SQ913	US 4011-T15P	3.5	M 4	10.6	D-T08P/T15P	FG-15	HS 1030C
SQ914	US 4011-T15P	3.5	M 4	10.6	D-T08P/T15P	FG-15	HS 1230C
SQ915	US 4011-T15P	3.5	M 4	10.6	D-T08P/T15P	FG-15	HS 1630C
SQ916	US 4011-T15P	3.5	M 4	10.6	D-T08P/T15P	FG-15	HS 2040C

ADMX 16



	W1	D1	L	S
	(mm)	(mm)	(mm)	(mm)
1606	9.950	4.50	16.00	6.25

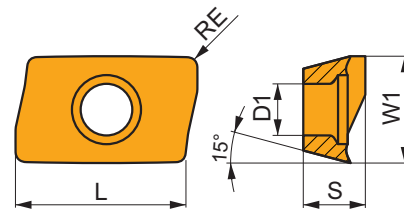

Eignung und Startwerte für Schnittgeschwindigkeit (vc), Vorschub (f) und Schnitttiefe (ap). Weitere Informationen finden Sie in unserer Zerspanungsrechner-App.

Produkt	RE (mm)	P			M			K			N			S			H		
		vc	f	ap	vc	f	ap	vc	f	ap	vc	f	ap	vc	f	ap	vc	f	ap
		(m/min)	(mm/tooth)	(mm)	(m/min)	(mm/tooth)	(mm)	(m/min)	(mm/tooth)	(mm)	(m/min)	(mm/tooth)	(mm)	(m/min)	(mm/tooth)	(mm)	(m/min)	(mm/tooth)	(mm)

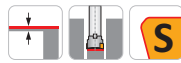
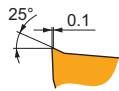
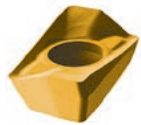

F geometrie mit hoch positiven Design zum Schlichten bis mittleren Bearbeitung.

ADMX 160608SR-F:8215	● 0.8	■ 290	■ 0.10	■ 2.0	■ 170	■ 0.09	■ 2.0	■ 275	■ 0.10	■ 2.0	■ 870	■ 0.12	■ 2.0	■ 70	■ 0.07	■ 1.6	-	-	-
ADMX 160608SR-F:M8310	● 0.8	■ 320	■ 0.10	■ 2.0	■ 160	■ 0.09	■ 2.0	■ 300	■ 0.10	■ 2.0	-	-	-	-	-	-	-	-	-
ADMX 160608SR-F:M8330	● 0.8	■ 285	■ 0.10	■ 2.0	■ 170	■ 0.09	■ 2.0	■ 270	■ 0.10	■ 2.0	■ 855	■ 0.12	■ 2.0	■ 70	■ 0.07	■ 1.6	-	-	-
ADMX 160608SR-F:M8340	● 0.8	■ 260	■ 0.10	■ 2.0	■ 155	■ 0.09	■ 2.0	■ 245	■ 0.10	■ 2.0	-	-	-	■ 65	■ 0.07	■ 1.6	-	-	-
ADMX 160608SR-F:M9340	● 0.8	■ 340	■ 0.10	■ 2.0	■ 200	■ 0.09	■ 2.0	-	-	-	-	-	-	■ 85	■ 0.07	■ 1.6	-	-	-

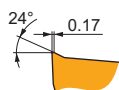
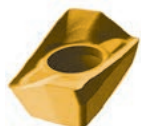

M geometrie mit positiven Design zur leichten bis mittleren Bearbeitung.

ADMX 160604SR-M:8215	● 0.4	■ 190	■ 0.18	■ 5.0	■ 110	■ 0.16	■ 5.0	■ 180	■ 0.18	■ 5.0	-	-	-	■ 45	■ 0.13	■ 4.0	-	-	-
ADMX 160604SR-M:M8330	● 0.4	■ 190	■ 0.18	■ 5.0	■ 110	■ 0.16	■ 5.0	■ 180	■ 0.18	■ 5.0	-	-	-	■ 45	■ 0.13	■ 4.0	-	-	-
ADMX 160604SR-M:M8340	● 0.4	■ 170	■ 0.18	■ 5.0	■ 100	■ 0.16	■ 5.0	■ 160	■ 0.18	■ 5.0	-	-	-	■ 40	■ 0.13	■ 4.0	-	-	-
ADMX 160608SR-M:8215	● 0.8	■ 225	■ 0.18	■ 5.0	■ 135	■ 0.16	■ 5.0	■ 210	■ 0.18	■ 5.0	-	-	-	■ 55	■ 0.13	■ 4.0	-	-	-
ADMX 160608SR-M:M5315	● 0.8	■ 305	■ 0.18	■ 5.0	-	-	-	■ 285	■ 0.18	■ 5.0	-	-	-	-	-	-	-	-	-
ADMX 160608SR-M:M8310	● 0.8	■ 250	■ 0.18	■ 5.0	■ 125	■ 0.16	■ 5.0	■ 235	■ 0.18	■ 5.0	-	-	-	-	-	-	-	-	-
ADMX 160608SR-M:M8330	● 0.8	■ 225	■ 0.18	■ 5.0	■ 135	■ 0.16	■ 5.0	■ 210	■ 0.18	■ 5.0	-	-	-	■ 55	■ 0.13	■ 4.0	-	-	-
ADMX 160608SR-M:M8340	● 0.8	■ 205	■ 0.18	■ 5.0	■ 120	■ 0.16	■ 5.0	■ 190	■ 0.18	■ 5.0	-	-	-	■ 50	■ 0.13	■ 4.0	-	-	-
ADMX 160608SR-M:M9315	● 0.8	■ 305	■ 0.18	■ 5.0	-	-	-	■ 285	■ 0.18	■ 5.0	-	-	-	-	-	-	-	-	-
ADMX 160608SR-M:M9325	● 0.8	■ 280	■ 0.18	■ 5.0	-	-	-	■ 265	■ 0.18	■ 5.0	-	-	-	-	-	-	-	-	-
ADMX 160608SR-M:M9340	● 0.8	■ 255	■ 0.18	■ 5.0	■ 150	■ 0.16	■ 5.0	-	-	-	-	-	-	■ 60	■ 0.13	■ 4.0	-	-	-
ADMX 160616SR-M:8215	● 1.6	■ 250	■ 0.18	■ 5.0	■ 150	■ 0.16	■ 5.0	■ 235	■ 0.18	■ 5.0	-	-	-	■ 60	■ 0.13	■ 4.0	-	-	-
ADMX 160616SR-M:M8310	● 1.6	■ 275	■ 0.18	■ 5.0	■ 140	■ 0.16	■ 5.0	■ 260	■ 0.18	■ 5.0	-	-	-	-	-	-	-	-	-
ADMX 160616SR-M:M8330	● 1.6	■ 250	■ 0.18	■ 5.0	■ 150	■ 0.16	■ 5.0	■ 235	■ 0.18	■ 5.0	-	-	-	■ 60	■ 0.13	■ 4.0	-	-	-
ADMX 160616SR-M:M8340	● 1.6	■ 225	■ 0.18	■ 5.0	■ 135	■ 0.16	■ 5.0	■ 210	■ 0.18	■ 5.0	-	-	-	■ 55	■ 0.13	■ 4.0	-	-	-
ADMX 160616SR-M:M9325	● 1.6	■ 310	■ 0.18	■ 5.0	-	-	-	■ 290	■ 0.18	■ 5.0	-	-	-	-	-	-	-	-	-
ADMX 160620SR-M:M8330	● 2.0	■ 265	■ 0.18	■ 5.0	■ 155	■ 0.16	■ 5.0	■ 250	■ 0.18	■ 5.0	-	-	-	■ 65	■ 0.13	■ 4.0	-	-	-
ADMX 160620SR-M:M8340	● 2.0	■ 240	■ 0.18	■ 5.0	■ 140	■ 0.16	■ 5.0	■ 225	■ 0.18	■ 5.0	-	-	-	■ 60	■ 0.13	■ 4.0	-	-	-
ADMX 160630SR-M:M8330	● 3.0	■ 265	■ 0.18	■ 5.0	■ 155	■ 0.16	■ 5.0	■ 250	■ 0.18	■ 5.0	-	-	-	■ 65	■ 0.13	■ 4.0	-	-	-
ADMX 160630SR-M:M8340	● 3.0	■ 240	■ 0.18	■ 5.0	■ 140	■ 0.16	■ 5.0	■ 225	■ 0.18	■ 5.0	-	-	-	■ 60	■ 0.13	■ 4.0	-	-	-
ADMX 160632SR-M:M6330	● 3.2	■ 225	■ 0.18	■ 5.0	■ 155	■ 0.16	■ 5.0	-	-	-	-	-	-	■ 65	■ 0.13	■ 4.0	-	-	-
ADMX 160632SR-M:M8330	● 3.2	■ 265	■ 0.18	■ 5.0	■ 155	■ 0.16	■ 5.0	■ 250	■ 0.18	■ 5.0	-	-	-	■ 65	■ 0.13	■ 4.0	-	-	-

Eignung und Startwerte für Schnittgeschwindigkeit (vc), Vorschub (f) und Schnitttiefe (ap). Weitere Informationen finden Sie in unserer Zerspanungsrechner-App.

Produkt	RE (mm)	P			M			K			N			S			H		
		vc (m/min)	f (mm/tooth)	ap (mm)	vc (m/min)	f (mm/tooth)	ap (mm)	vc (m/min)	f (mm/tooth)	ap (mm)	vc (m/min)	f (mm/tooth)	ap (mm)	vc (m/min)	f (mm/tooth)	ap (mm)	vc (m/min)	f (mm/tooth)	ap (mm)

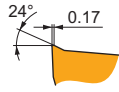
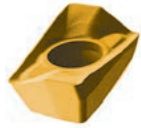

M geometrie mit positiven Design zur leichten bis mittleren Bearbeitung.

ADMX 160632SR-M:M8340	3.2	240	0.18	5.0	140	0.16	5.0	225	0.18	5.0	-	-	-	60	0.13	4.0	-	-	-
ADMX 160632SR-M:M9325	3.2	325	0.18	5.0	-	-	-	305	0.18	5.0	-	-	-	-	-	-	-	-	-
ADMX 160640SR-M:M8330	4.0	265	0.18	5.0	155	0.16	5.0	250	0.18	5.0	-	-	-	65	0.13	4.0	-	-	-
ADMX 160640SR-M:M8340	4.0	240	0.18	5.0	140	0.16	5.0	225	0.18	5.0	-	-	-	60	0.13	4.0	-	-	-
ADMX 160650SR-M:M8330	5.0	265	0.18	5.0	155	0.16	5.0	250	0.18	5.0	-	-	-	65	0.13	4.0	-	-	-
ADMX 160650SR-M:M8340	5.0	240	0.18	5.0	140	0.16	5.0	225	0.18	5.0	-	-	-	60	0.13	4.0	-	-	-

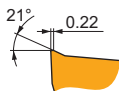
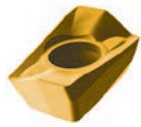

R geometrie mit positiven Design für mittlere bis weniger stabile Bearbeitungsbedingungen.

ADMX 160608PR-R:R215	0.8	205	0.25	6.0	120	0.23	6.0	190	0.25	6.0	-	-	-	50	0.20	4.8	40	0.16	1.1
ADMX 160608PR-R:M5315	0.8	260	0.25	6.0	-	-	-	245	0.25	6.0	-	-	-	-	-	-	50	0.16	1.1
ADMX 160608PR-R:M8310	0.8	220	0.25	6.0	110	0.23	6.0	205	0.25	6.0	-	-	-	-	-	40	0.16	1.1	
ADMX 160608PR-R:M8330	0.8	205	0.25	6.0	120	0.23	6.0	190	0.25	6.0	-	-	-	50	0.20	4.8	40	0.16	1.1
ADMX 160608PR-R:M8340	0.8	190	0.25	6.0	110	0.23	6.0	180	0.25	6.0	-	-	-	45	0.20	4.8	-	-	-
ADMX 160608PR-R:M9315	0.8	265	0.25	6.0	-	-	-	250	0.25	6.0	-	-	-	-	-	-	50	0.16	1.1
ADMX 160608PR-R:M9325	0.8	250	0.25	6.0	-	-	-	235	0.25	6.0	-	-	-	-	-	-	50	0.16	1.1
ADMX 160616PR-R:M8330	1.6	225	0.25	6.0	135	0.23	6.0	210	0.25	6.0	-	-	-	55	0.20	4.8	45	0.16	1.1
ADMX 160616PR-R:M8340	1.6	210	0.25	6.0	125	0.23	6.0	195	0.25	6.0	-	-	-	50	0.20	4.8	-	-	-
ADMX 160616PR-R:M9315	1.6	295	0.25	6.0	-	-	-	280	0.25	6.0	-	-	-	-	-	-	55	0.16	1.1

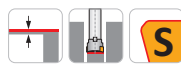
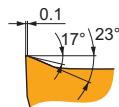

MF geometrie mit hoch positiven Design zur Schlichtbearbeitung.

ADMX 160608SR-MF:M6330	0.8	215	0.08	4.0	150	0.07	4.0	-	-	-	-	-	-	60	0.06	3.2	-	-	-
ADMX 160608SR-MF:M8340	0.8	225	0.08	4.0	135	0.07	4.0	-	-	-	-	-	-	55	0.06	3.2	-	-	-
ADMX 160608SR-MF:M9340	0.8	305	0.08	4.0	180	0.07	4.0	-	-	-	-	-	-	75	0.06	3.2	-	-	-

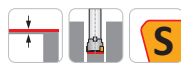
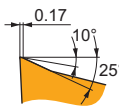
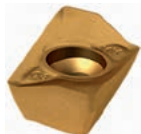

MM geometrie mit sehr positiven Design zur leichten bis mittleren Bearbeitung.

ADMX 160604SR-MM:M6330	0.4	145	0.18	4.0	105	0.16	4.0	-	-	-	-	-	-	40	0.14	3.2	-	-	-
ADMX 160604SR-MM:M8340	0.4	160	0.18	4.0	95	0.16	4.0	-	-	-	-	-	-	40	0.14	3.2	-	-	-
ADMX 160608SR-MM:M6330	0.8	175	0.18	4.0	125	0.16	4.0	-	-	-	-	-	-	50	0.14	3.2	-	-	-
ADMX 160608SR-MM:M8340	0.8	190	0.18	4.0	110	0.16	4.0	-	-	-	-	-	-	45	0.14	3.2	-	-	-
ADMX 160608SR-MM:M8345	0.8	150	0.18	4.0	90	0.16	4.0	-	-	-	-	-	-	35	0.14	3.2	-	-	-
ADMX 160608SR-MM:M9340	0.8	235	0.18	4.0	140	0.16	4.0	-	-	-	-	-	-	55	0.14	3.2	-	-	-
ADMX 160616SR-MM:M6330	1.6	195	0.18	4.0	140	0.16	4.0	-	-	-	-	-	-	55	0.14	3.2	-	-	-
ADMX 160616SR-MM:M8340	1.6	210	0.18	4.0	125	0.16	4.0	-	-	-	-	-	-	50	0.14	3.2	-	-	-
ADMX 160616SR-MM:M8345	1.6	165	0.18	4.0	95	0.16	4.0	-	-	-	-	-	-	40	0.14	3.2	-	-	-
ADMX 160616SR-MM:M9340	1.6	260	0.18	4.0	155	0.16	4.0	-	-	-	-	-	-	65	0.14	3.2	-	-	-

ADEX 16



	W1	D1	L	S
	(mm)	(mm)	(mm)	(mm)
1606	9.950	4.50	16.00	6.25

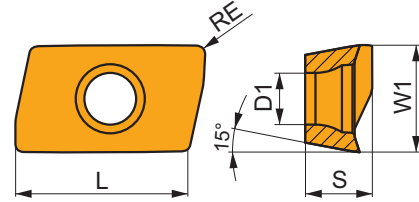

Eignung und Startwerte für Schnittgeschwindigkeit (vc), Vorschub (f) und Schnitttiefe (ap). Weitere Informationen finden Sie in unserer Zerspanungsrechner-App.

Produkt	RE (mm)	P			M			K			N			S			H		
		vc (m/min)	f (mm/tooth)	ap (mm)	vc (m/min)	f (mm/tooth)	ap (mm)	vc (m/min)	f (mm/tooth)	ap (mm)	vc (m/min)	f (mm/tooth)	ap (mm)	vc (m/min)	f (mm/tooth)	ap (mm)	vc (m/min)	f (mm/tooth)	ap (mm)

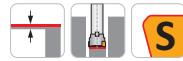
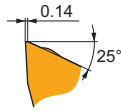

FM geometrie mit sehr positiven Design zur mittleren Bearbeitung.

ADEX 160608SR-FM:8215	0.8	260	0.16	2.0	155	0.14	2.0	245	0.16	2.0	-	-	-	65	0.11	1.6	-	-	-
ADEX 160608SR-FM:M8330	0.8	255	0.16	2.0	150	0.14	2.0	240	0.16	2.0	-	-	-	60	0.11	1.6	-	-	-
ADEX 160608SR-FM:M8340	0.8	235	0.16	2.0	140	0.14	2.0	220	0.16	2.0	-	-	-	55	0.11	1.6	-	-	-

ADEX 16-FA



	W1	D1	L	S
	(mm)	(mm)	(mm)	(mm)
1606	9.950	4.50	16.00	6.17

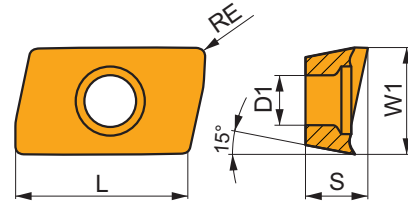

Eignung und Startwerte für Schnittgeschwindigkeit (vc), Vorschub (f) und Schnitttiefe (ap). Weitere Informationen finden Sie in unserer Zerspanungsrechner-App.

Produkt	RE (mm)	P			M			K			N			S			H		
		vc (m/min)	f (mm/tooth)	ap (mm)	vc (m/min)	f (mm/tooth)	ap (mm)	vc (m/min)	f (mm/tooth)	ap (mm)	vc (m/min)	f (mm/tooth)	ap (mm)	vc (m/min)	f (mm/tooth)	ap (mm)	vc (m/min)	f (mm/tooth)	ap (mm)

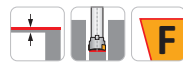
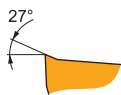

FA geometrie mit hoch positiven Design zur feinen Schlichtbearbeitung bis zur mittleren Bearbeitung.

ADEX 160604FR-FA:HF7	0.4	-	-	-	-	-	-	195	0.28	6.0	-	-	-	-	-	-	-	-	-
ADEX 160604FR-FA:M0315	0.4	-	-	-	-	-	-	480	0.28	6.0	-	-	-	-	-	-	-	-	-
ADEX 160608FR-FA:HF7	0.8	-	-	-	-	-	-	240	0.28	6.0	-	-	-	-	-	-	-	-	-
ADEX 160608FR-FA:M0315	0.8	-	-	-	-	-	-	570	0.28	6.0	-	-	-	-	-	-	-	-	-
ADEX 160616FR-FA:HF7	1.6	-	-	-	-	-	-	255	0.28	6.0	-	-	-	-	-	-	-	-	-
ADEX 160616FR-FA:M0315	1.6	-	-	-	-	-	-	630	0.28	6.0	-	-	-	-	-	-	-	-	-
ADEX 160630FR-FA:HF7	3.0	-	-	-	-	-	-	270	0.28	6.0	-	-	-	-	-	-	-	-	-



a_e / DC	5 %	10 %	15 %	20 %	25 %	30 %	40 %	50 %	60 %	70 %	75 %	80 %	90 %	100 %
	0.89	0.81	0.76	0.73	0.71	0.70	0.66	0.65	0.63	0.62	0.60	0.60	0.60	0.45



	1		2.5		5		7.5		10		15		20	
	f_{min}	f_{max}	f_{min}	f_{max}	f_{min}	f_{max}	f_{min}	f_{max}	f_{min}	f_{max}	f_{min}	f_{max}	f_{min}	f_{max}
50	0.57	0.71	0.36	0.45	0.26	0.32	0.21	0.27	0.19	0.23	0.15	0.19	0.14	0.17
63	0.64	0.80	0.40	0.51	0.29	0.36	0.24	0.30	0.21	0.26	0.17	0.21	0.15	0.19
80	0.72	0.90	0.45	0.57	0.32	0.40	0.27	0.33	0.23	0.29	0.19	0.24	0.17	0.21
100	0.80	1.00	0.51	0.64	0.36	0.45	0.30	0.37	0.26	0.32	0.21	0.27	0.19	0.23

	25		32		40		50		63		80		100	
	f_{min}	f_{max}	f_{min}	f_{max}	f_{min}	f_{max}	f_{min}	f_{max}	f_{min}	f_{max}	f_{min}	f_{max}	f_{min}	f_{max}
50	0.13	0.16	0.12	0.14	0.11	0.14	0.13	0.16	-	-	-	-	-	-
63	0.14	0.17	0.12	0.16	0.12	0.15	0.11	0.14	0.13	0.16	-	-	-	-
80	0.15	0.19	0.14	0.17	0.13	0.16	0.12	0.15	0.11	0.14	0.13	0.16	-	-
100	0.17	0.21	0.15	0.19	0.14	0.17	0.13	0.16	0.12	0.15	0.11	0.14	0.13	0.16

	ADMX 16-F	ADEX 16-FM	ADMX 16-M								ADMX 16-R	
	0.8	0.8	0.4	0.8	1.6	2.0	3.0	3.2	4.0	5.0	0.8	1.6
	2.99	2.18	3.39	2.99	1.62	1.23	0.28	0.09	2.69	1.52	2.99	1.62

	ADMX 16-MF	ADMX 16-MM			ADEX 16-FA			
	0.8	0.4	0.8	1.6	0.4	0.8	1.6	3.0
	2.99	3.39	2.99	1.62	2.84	2.44	1.65	0.69



ISO				
50J3R100H50-SAD16E54-C	50	3	54	50.5
50J3R140H50-SAD16E80-C	50	3	80	76.5
63J3R140H50-SAD16E68-C	63	3	68	64.5
63J3R155H50-SAD16E95-C	63	3	95	91.5
80J4R165H50-SAD16E108-C	80	4	108	104.5
50J3R140G50-SAD16E80-C	50	3	80	76.5
63J3R155G50-SAD16E95-C	63	3	95	91.5
80J4R165G50-SAD16E108-C	80	4	108	104.5
50J3R140X50-SAD16E68-C	50	3	68	64.5
63J3R155X50-SAD16E80-C	63	3	80	76.5
80J4R165X50-SAD16E95-C	80	4	95	91.5
50T03R-S90AD16E40-C	50	3	40	36.5
63T04R-S90AD16E40-C	63	4	40	36.5
63T04R-S90AD16E68-C	63	4	68	64.5
80T04R-S90AD16E55-C	80	4	55	51.5
80T04R-S90AD16E80-C	80	4	80	76.5
100T05R-S90AD16E80-C	100	5	80	76.5



7.5

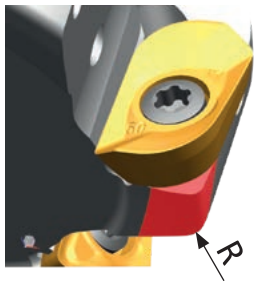

ADMX/ADEX 16	R
ADMX 160630SR-M	2.5
ADMX 160632SR-M	2.5
ADMX 160640SR-M	4.0
ADMX 160650SR-M	4.5

J(T)-SSAP

P M K S

PRAMET

S



Walzenstirnfräser für die mittlere Bearbeitung mit AP. 15 und SP. 12 Wendeschneidplatten

90° Walzenstirnfräser mit AP. 15 und SP. 12 Wendeschneidplatten mit APMX von 58 bis 95 mm. Der Körper hat ein austauschbares Endstück. Geeignet fürs Schulter-, Nut-, Plan- und Tauchfräsen. Verfügbar in DIN 69871 und DIN 2080 SK50 Aufnahmen. Für längere Standzeiten ist der Körper oberflächenbehandelt.

KAPR	90°
APMX	58.0 - 95.0 mm

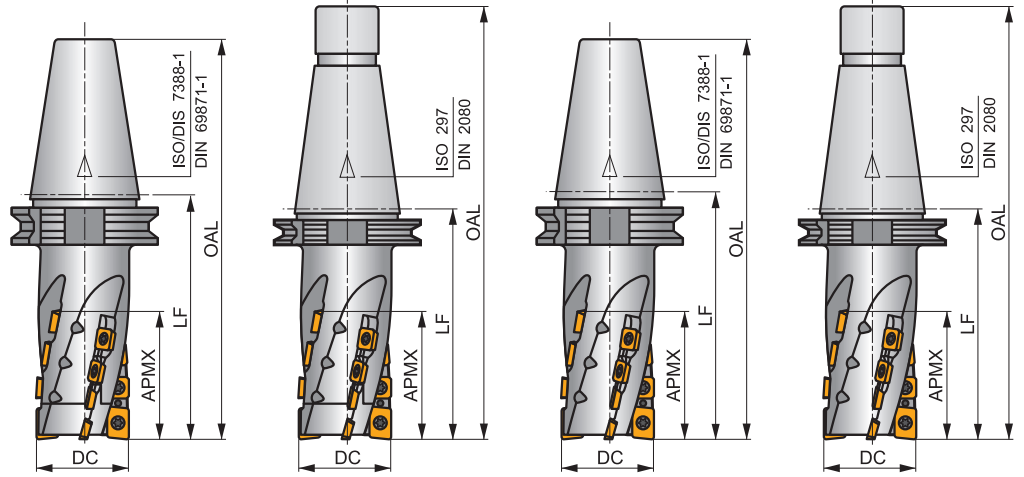
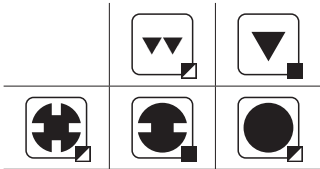
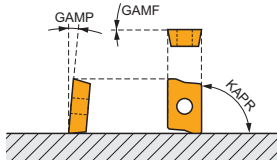

h_m 0.07 - 0.1



Produkt	DC (mm)	OAL (mm)	APMX (mm)	LF (mm)	GAMP (°)	GAMF (°)	CZCMS	NOF	AP	SP	max.	kg	G128	SQ941
50J4R128H50-SSAP55+21	50	230	76.00	128	0	7	50	4	2	16	9500	3.80	G128	SQ942
63J4R150H50-SSAP74+21	63	252	95.00	150	0	7	50	4	2	20	8500	4.50	G128	SQ943
50J4R124X50-SSAP55+21	50	251	76.00	124	0	7	50	4	2	16	9500	4.43	G128	SQ942
63J4R146X50-SSAP74+21	63	273	95.00	146	0	7	50	4	2	20	8500	4.75	G128	SQ943
63J4R150H50-SSAP95-A	63	252	95.00	150	0	7	50	4	2	20	8500	5.32	G128	SQ941
80J6R155H50-SSAP95-A	80	257	95.00	155	0	7	50	6	3	30	7500	6.30	G128	SQ941
50J4R124X50-SSAP76-A	50	251	76.00	124	0	7	50	4	2	16	9500	3.80	G128	SQ941
63J4R146X50-SSAP95-A	63	273	95.00	146	0	7	50	4	2	20	8500	4.50	G128	SQ941
80J6R151X50-SSAP95-A	80	275	95.00	151	0	7	50	6	3	30	7500	6.20	G128	SQ941

G128	APE. 1504..	SPE. 1204..

SQ941	SQ942	SQ943
-	P50X21	P63X21
-	SR 25	SR 26
-	HXK 6	HXK 8
US 4511-T20	US 4511-T20	US 4511-T20
5.0	5.0	5.0
M 4.5	M 4.5	M 4.5
11	11	11
SDRT20-T	SDRT20-T	SDRT20-T

APET 15



	W1	D1	L	S
	(mm)	(mm)	(mm)	(mm)
1504	12.700	5.50	15.90	4.76

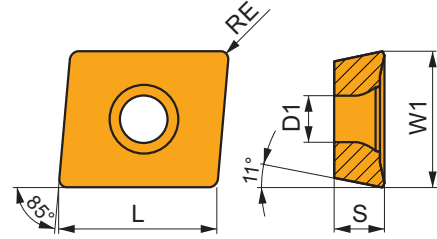

Eignung und Startwerte für Schnittgeschwindigkeit (vc), Vorschub (f) und Schnitttiefe (ap). Weitere Informationen finden Sie in unserer Zerspanungsrechner-App.

Produkt	RE	P			M			K			N			S			H		
		vc	f	ap	vc	f	ap	vc	f	ap	vc	f	ap	vc	f	ap	vc	f	ap
	(mm)	(m/min)	(mm/tooth)	(mm)	(m/min)	(mm/tooth)	(mm)	(m/min)	(mm/tooth)	(mm)	(m/min)	(mm/tooth)	(mm)	(m/min)	(mm/tooth)	(mm)	(m/min)	(mm/tooth)	(mm)

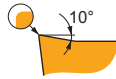
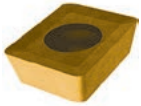

EN Schneidkantenpräparation, positive Geometrie zur leichten bis mittleren Bearbeitung.

APET 150412EN:M8330	1.2	225	0.20	12.0	135	0.18	12.0	210	0.20	12.0	-	-	-	55	0.14	9.6	-	-	-
----------------------------	-----	-----	------	------	-----	------	------	-----	------	------	---	---	---	----	------	-----	---	---	---

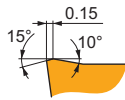
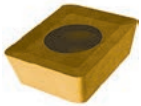

SN Schneidkantenpräparation, positive Geometrie zur mittleren bis leichten Bearbeitung.

APET 150412SN:M8330	1.2	215	0.25	12.0	125	0.23	12.0	200	0.25	12.0	-	-	-	50	0.25	9.6	-	-	-
APET 150412SN:M8340	1.2	190	0.25	12.0	110	0.23	12.0	180	0.25	12.0	-	-	-	45	0.25	9.6	-	-	-

APEW 15



	W1	D1	L	M	S
	(mm)	(mm)	(mm)	(mm)	(mm)
1504	12.700	5.50	15.90	3.7	4.76

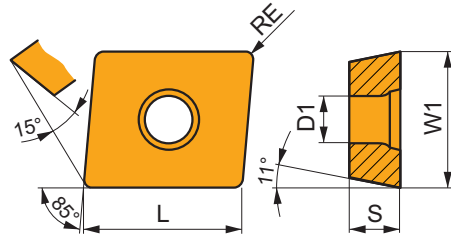

Eignung und Startwerte für Schnittgeschwindigkeit (vc), Vorschub (f) und Schnitttiefe (ap). Weitere Informationen finden Sie in unserer Zerspanungsrechner-App.

Produkt	RE	P			M			K			N			S			H		
		vc	f	ap	vc	f	ap	vc	f	ap	vc	f	ap	vc	f	ap	vc	f	ap
	(mm)	(m/min)	(mm/tooth)	(mm)	(m/min)	(mm/tooth)	(mm)	(m/min)	(mm/tooth)	(mm)	(m/min)	(mm/tooth)	(mm)	(m/min)	(mm/tooth)	(mm)	(m/min)	(mm/tooth)	(mm)

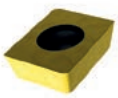

ER Schneidkantenpräparation, ohne Spanwinkel zur leichten bis mittleren Bearbeitung.

APEW 150412ER:M8330	1.2	200	0.20	12.0	-	-	-	190	0.20	12.0	-	-	-	-	-	-	40	0.13	1.0
----------------------------	-----	-----	------	------	---	---	---	-----	------	------	---	---	---	---	---	---	----	------	-----

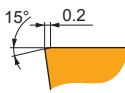
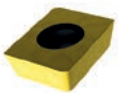

SR Schneidkantenpräparation, ohne Spanbrecher zur mittleren bis schweren Bearbeitung.

APEW 150412SR:M8330	1.2	200	0.20	12.0	-	-	-	190	0.20	12.0	-	-	-	-	-	-	40	0.13	1.0
----------------------------	-----	-----	------	------	---	---	---	-----	------	------	---	---	---	---	---	---	----	------	-----

SPET 12



	IC	D1	L	M	S
	(mm)	(mm)	(mm)	(mm)	(mm)
1204	12.700	5.50	12.70	1.9	4.76

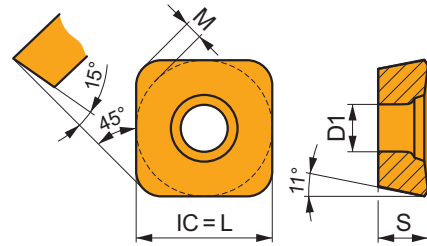

Eignung und Startwerte für Schnittgeschwindigkeit (vc), Vorschub (f) und Schnitttiefe (ap). Weitere Informationen finden Sie in unserer Zerspanungsrechner-App.

Produkt	RE	P			M			K			N			S			H		
		vc	f	ap	vc	f	ap	vc	f	ap	vc	f	ap	vc	f	ap	vc	f	ap
	(mm)	(m/min)	(mm/tooth)	(mm)	(m/min)	(mm/tooth)	(mm)	(m/min)	(mm/tooth)	(mm)	(m/min)	(mm/tooth)	(mm)	(m/min)	(mm/tooth)	(mm)	(m/min)	(mm/tooth)	(mm)

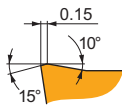

S Schneidkantenpräparation, positive Allzweck-geometrie.

SPET 120408S:M8330	☹	0.8	█	215	0.20	12.0	▣	125	0.18	12.0	█	200	0.20	12.0	█	50	0.18	9.6	█	–	–	–
SPET 120408S:M8340	☹	0.8	█	190	0.20	12.0	▣	110	0.18	12.0	▣	180	0.20	12.0	█	45	0.18	9.6	█	–	–	–

SPET 12 AD



	IC	D1	L	M	S
	(mm)	(mm)	(mm)	(mm)	(mm)
1204	12.700	5.50	12.70	1.9	4.76

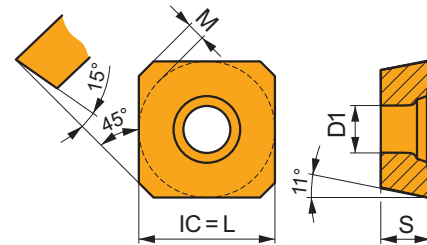

Eignung und Startwerte für Schnittgeschwindigkeit (vc), Vorschub (f) und Schnitttiefe (ap). Weitere Informationen finden Sie in unserer Zerspanungsrechner-App.

Produkt	RE	P			M			K			N			S			H		
		vc	f	ap	vc	f	ap	vc	f	ap	vc	f	ap	vc	f	ap	vc	f	ap
	(mm)	(m/min)	(mm/tooth)	(mm)	(m/min)	(mm/tooth)	(mm)	(m/min)	(mm/tooth)	(mm)	(m/min)	(mm/tooth)	(mm)	(m/min)	(mm/tooth)	(mm)	(m/min)	(mm/tooth)	(mm)

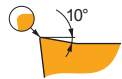
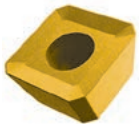

ADEN Schneidkantenpräparation, positive geometrie zur leichten bis mittleren Bearbeitung.

SPET 1204ADEN:M8330	☹	–	█	245	0.20	12.0	▣	145	0.18	12.0	█	230	0.20	12.0	█	60	0.14	9.6	█	–	–	–
SPET 1204ADEN:M8340	☹	–	█	220	0.20	12.0	▣	130	0.18	12.0	▣	205	0.20	12.0	█	55	0.14	9.6	█	–	–	–

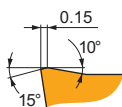
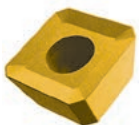

ADSN Schneidkantenpräparation, positive geometrie zur mittleren Bearbeitung.

SPET 1204ADSN:M8330	☹	–	█	245	0.20	12.0	▣	145	0.18	12.0	█	230	0.20	12.0	█	60	0.14	9.6	█	–	–	–
SPET 1204ADSN:M8340	☹	–	█	220	0.20	12.0	▣	130	0.18	12.0	▣	205	0.20	12.0	█	55	0.14	9.6	█	–	–	–

SPEW 12 AD



	IC	D1	L	M	S
	(mm)	(mm)	(mm)	(mm)	(mm)
1204	12.700	5.50	12.70	1.9	4.76

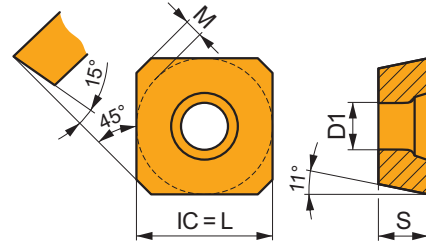

Eignung und Startwerte für Schnittgeschwindigkeit (vc), Vorschub (f) und Schnitttiefe (ap). Weitere Informationen finden Sie in unserer Zerspanungsrechner-App.

Produkt	RE (mm)	P			M			K			N			S			H		
		vc (m/min)	f (mm/tooth)	ap (mm)	vc (m/min)	f (mm/tooth)	ap (mm)	vc (m/min)	f (mm/tooth)	ap (mm)	vc (m/min)	f (mm/tooth)	ap (mm)	vc (m/min)	f (mm/tooth)	ap (mm)	vc (m/min)	f (mm/tooth)	ap (mm)

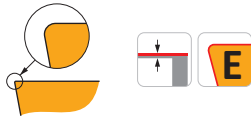
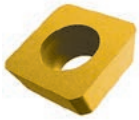

ADEN Schneidkantenpräparation, ohne Spanwinkel zur leichten bis mittleren Bearbeitung.

SPEW 1204ADEN:M8330	RE	220	0.20	12.0	–	–	–	205	0.20	12.0	–	–	–	–	–	–	40	0.10	1.0
----------------------------	----	-----	------	------	---	---	---	-----	------	------	---	---	---	---	---	---	----	------	-----

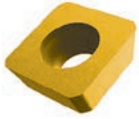

ADSN Schneidkantenpräparation, ohne Spanwinkel zur mittleren Bearbeitung.

SPEW 1204ADSN:M8330	RE	220	0.20	12.0	–	–	–	205	0.20	12.0	–	–	–	–	–	–	40	0.13	1.0
----------------------------	----	-----	------	------	---	---	---	-----	------	------	---	---	---	---	---	---	----	------	-----



a_e / DC	5 %	10 %	15 %	20 %	25 %	30 %	40 %	50 %	60 %	70 %	75 %	80 %	90 %	100 %
	0.89	0.81	0.76	0.73	0.71	0.70	0.67	0.65	0.63	0.62	0.60	0.60	0.60	0.45



	1	2.5	5	7.5	10	15	20	
	f_{min}	f_{max}	f_{min}	f_{max}	f_{min}	f_{max}	f_{min}	f_{max}
50	0.50	0.71	0.32	0.45	0.23	0.32	0.19	0.27
63	0.56	0.80	0.35	0.51	0.25	0.36	0.21	0.30
80	0.63	0.90	0.40	0.57	0.28	0.40	0.23	0.33

	25	32	40	50	63	80
	f_{min}	f_{max}	f_{min}	f_{max}	f_{min}	f_{max}
50	0.11	0.16	0.10	0.14	0.10	0.14
63	0.12	0.17	0.11	0.16	0.10	0.15
80	0.13	0.19	0.12	0.17	0.10	0.16

	APET 15	APEW 15	SPET 12	SPET 12AD	SPEW 12AD
	1.2	1.2	0.8	-	-
	-	-	-	-	-



ISO				
50J4R128H50-SSAP55+21	50	2+2	76	73.6
63J4R150H50-SSAP74+21	63	2+2	95	92.6
50J4R124X50-SSAP55+21	50	2+2	76	73.6
63J4R146X50-SSAP74+21	63	2+2	95	92.6
63J4R150H50-SSAP95-A	63	2+2	95	92.6
80J6R155H50-SSAP95-A	80	3+3	95	92.6
50J4R124X50-SSAP76-A	50	2+2	76	73.6
63J4R146X50-SSAP95-A	63	2+2	95	92.6
80J6R151X50-SSAP95-A	80	3+3	95	92.6

J(T)-CSD12X

P M S

PRAMET

C



MULTISIDE SD Walzenstirnfräser

90° Walzenstirnfräser mit positiven SD.. 12 Wendeschneidplatten und APMX von 44.1 bis 87.3 mm. Geeignet fürs Schulter-, Nut- oder Planfräsen. Erhältlich als Aufsteckfräser, PSC, Morsekegel oder DIN 69871 Aufnahmen. Für längere Standzeiten ist der Körper oberflächenbehandelt.

MULTISIDE SD

KAPR	90°
APMX	44.1 - 87.3 mm

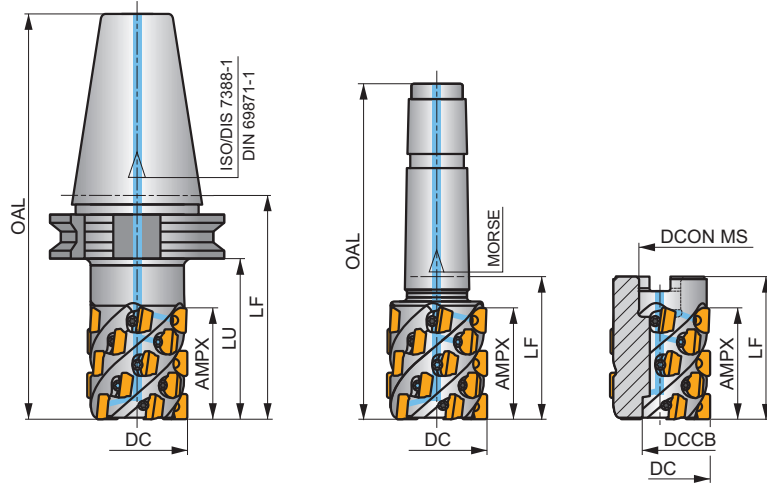
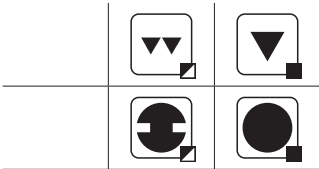
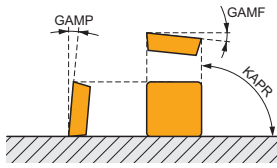

h_m	0.025 - 0.05			
h_m	0.025 - 0.05			

Produkt	DC	OAL	DCON MS	DCCB	LU	LF	APMX	GAMF	GAMP	CZC MS	NOF						
	(mm)	(mm)	(mm)	(mm)	(mm)	(mm)	(mm)	(°)	(°)								
40J4R090H40-CSD12X44	40	158.4	-	-	70	90	44.10	-5	8	40	4	16	-	4000	✓	1.16	GI271 SQ091
50J5R100H50-CSD12X55	50	201.7	-	-	80	100	54.90	-5	8	50	5	25	-	3200	✓	4.20	GI271 SQ091
63J6R110H50-CSD12X66	63	211.7	-	-	90	110	65.70	-5	8	50	6	36	-	2500	✓	4.90	GI271 SQ091
50J5R065E04-CSD12X55	50	167.5	-	-	-	65	54.90	-5	8	4	5	25	-	3200	✓	1.34	GI271 SQ091
50T05R-C90SD12X55	50	-	22	18	-	78	54.90	-5	8	-	5	25	-	3200	✓	1.21	GI271 SQ923
63T06R-C90SD12X66	63	-	27	22	-	90	65.70	-5	8	-	6	36	-	2500	✓	1.72	GI271 SQ924
80T08R-C90SD12X88	80	-	40	36	-	115	87.30	-5	8	-	8	64	-	2000	✓	3.20	GI271 SQ925

GI271	SDGX 1205..	SDMX 1205..

SQ091	US 63511D-T15P	3.0	M 3.5	11	D-T08P/T15P	FG-15	-
SQ923	US 63511D-T15P	3.0	M 3.5	11	D-T08P/T15P	FG-15	HSD 1070
SQ924	US 63511D-T15P	3.0	M 3.5	11	D-T08P/T15P	FG-15	HS 1280
SQ925	US 63511D-T15P	3.0	M 3.5	11	D-T08P/T15P	FG-15	HS 20100

SDGX 12



	IC (mm)	L (mm)	S (mm)	S1 (mm)
1205	12.700	12.70	5.56	6.35

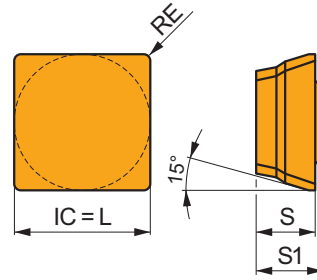

Eignung und Startwerte für Schnittgeschwindigkeit (vc), Vorschub (f) und Schnitttiefe (ap). Weitere Informationen finden Sie in unserer Zerspanungsrechner-App.

Produkt	RE (mm)	P			M			K			N			S			H		
		vc (m/min)	f (mm/tooth)	ap (mm)	vc (m/min)	f (mm/tooth)	ap (mm)	vc (m/min)	f (mm/tooth)	ap (mm)	vc (m/min)	f (mm/tooth)	ap (mm)	vc (m/min)	f (mm/tooth)	ap (mm)	vc (m/min)	f (mm/tooth)	ap (mm)

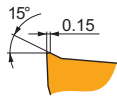
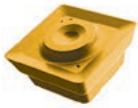

FM geometrie mit positiven Design zur leichten Bearbeitung bis zur schweren Bearbeitung.

SDGX 120508EN-FM:M8330	0.8	220	0.15	12.0	130	0.14	12.0	–	–	–	–	–	–	55	0.11	9.6	–	–	–
SDGX 120508EN-FM:M8345	0.8	155	0.15	12.0	90	0.14	12.0	–	–	–	–	–	–	35	0.11	9.6	–	–	–

SDMX 12



	IC (mm)	L (mm)	S (mm)	S1 (mm)
1205	12.700	12.70	5.56	6.35

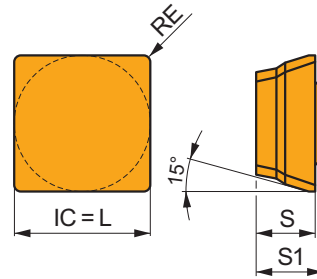

Eignung und Startwerte für Schnittgeschwindigkeit (vc), Vorschub (f) und Schnitttiefe (ap). Weitere Informationen finden Sie in unserer Zerspanungsrechner-App.

Produkt	RE (mm)	P			M			K			N			S			H		
		vc (m/min)	f (mm/tooth)	ap (mm)	vc (m/min)	f (mm/tooth)	ap (mm)	vc (m/min)	f (mm/tooth)	ap (mm)	vc (m/min)	f (mm/tooth)	ap (mm)	vc (m/min)	f (mm/tooth)	ap (mm)	vc (m/min)	f (mm/tooth)	ap (mm)

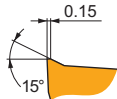
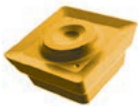

M geometrie mit positiven Design zur leichten bis schweren Bearbeitung.

SDMX 120508EN-M:M8330	0.8	220	0.15	12.0	130	0.14	12.0	–	–	–	–	–	–	55	0.11	9.6	–	–	–
SDMX 120508EN-M:M8345	0.8	155	0.15	12.0	90	0.14	12.0	–	–	–	–	–	–	35	0.11	9.6	–	–	–



a_e / DC	5 %	10 %	15 %	20 %	25 %	30 %	40 %	50 %	60 %	70 %	75 %	80 %	90 %	100 %
	0.89	0.81	0.76	0.73	0.71	0.70	0.66	0.65	0.63	0.62	0.60	0.60	0.60	0.45



	1		2.5		5		7.5		10		15		20	
	f_{min}	f_{max}	f_{min}	f_{max}	f_{min}	f_{max}	f_{min}	f_{max}	f_{min}	f_{max}	f_{min}	f_{max}	f_{min}	f_{max}
40	0.16	0.32	0.10	0.20	0.07	0.14	0.06	0.12	0.05	0.10	0.04	0.09	0.04	0.08
50	0.18	0.35	0.11	0.23	0.08	0.16	0.07	0.13	0.06	0.12	0.05	0.10	0.04	0.09
63	0.20	0.40	0.13	0.25	0.09	0.18	0.07	0.15	0.06	0.13	0.05	0.11	0.05	0.09
80	0.22	0.45	0.14	0.28	0.10	0.20	0.08	0.17	0.07	0.14	0.06	0.12	0.05	0.10

	25		32		40		50		63		80	
	f_{min}	f_{max}	f_{min}	f_{max}	f_{min}	f_{max}	f_{min}	f_{max}	f_{min}	f_{max}	f_{min}	f_{max}
40	0.04	0.07	0.03	0.07	0.04	0.08	-	-	-	-	-	-
50	0.04	0.08	0.04	0.07	0.03	0.07	0.04	0.08	-	-	-	-
63	0.04	0.09	0.04	0.08	0.04	0.07	0.03	0.07	0.04	0.08	-	-
80	0.05	0.09	0.04	0.09	0.04	0.08	0.04	0.07	0.03	0.07	0.04	0.08

	SDGX 12-FM	SDMX 12-M
	0.8	0.8
	2.99	2.99



ISO				
40J4R090H40-CSD12X44	40	4	44.1	42.5
50J5R100H50-CSD12X55	50	5	54.9	53.3
63J6R110H50-CSD12X66	63	6	65.7	64.1
80J8R130H50-CSD12X88	80	8	87.3	85.7
40J4R080XC5-CSD12X44	40	4	44.1	42.5
50J5R080XC5-CSD12X55	50	5	54.9	53.3
63J6R095XC6-CSD12X66	63	6	65.7	64.1
50J5R065E04-CSD12X55	50	5	54.9	53.3
50T05R-C90SD12X55	50	5	54.9	53.3
63T06R-C90SD12X66	63	6	65.7	64.1
80T08R-C90SD12X88	80	8	87.3	85.7

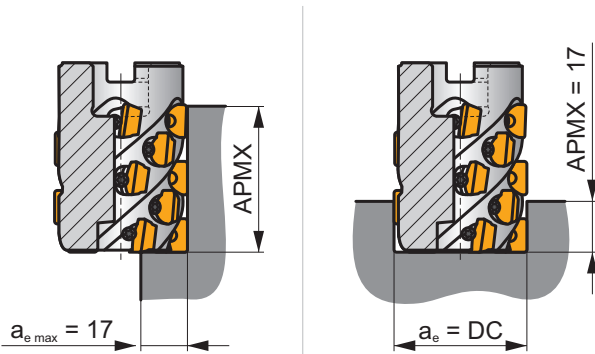

J(T)-SLSN

P **K**

PRAMET

S

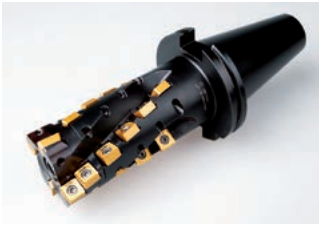

ROUGH SN Walzenstirnfräser für das schwere Fräsen mit Innenkühlung

90° Walzenstirnfräser mit LNET 16 und SN.. 13 Wendeschneidplatten mit APMX von 104 bis 134 mm. Der Körper hat ein austauschbares Endstück. Geeignet fürs Schulter-, Nut-, Plan- und Tauchfräsen. Verfügbar in DIN 69871, BT und DIN 2080 SK50 Aufnahmen. Für längere Standzeiten ist der Körper oberflächenbehandelt.

ROUGH SN

KAPR	90°
APMX	104.0 - 134.0 mm

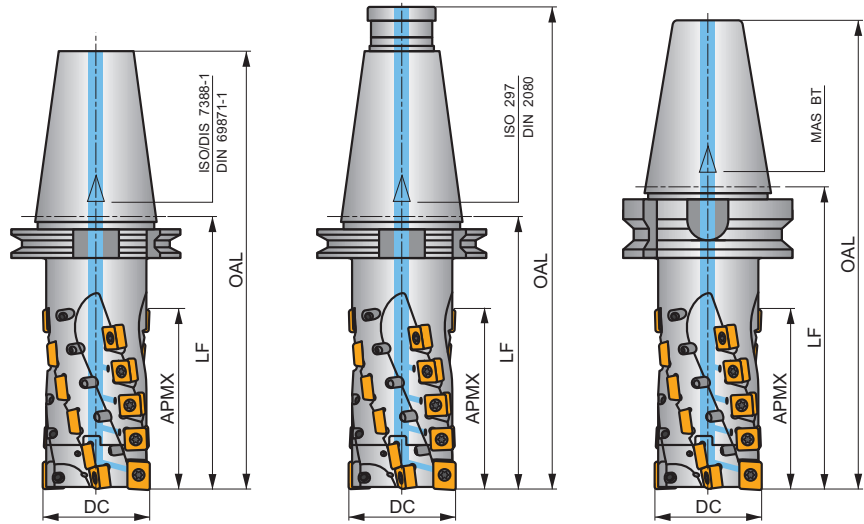
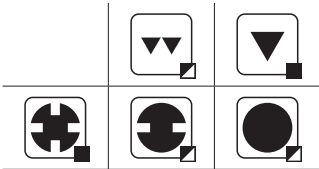
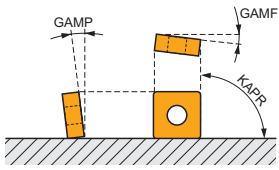

h_m 0.08 - 0.22



Produkt	DC (mm)	OAL (mm)	APMX (mm)	LF (mm)	GAMF (°)	GAMP (°)	CZCMS	NOF	LN	SN	max.	kg	GI209	SQ934	SQ935	
63J2R155H50-SLSN104-C	63	257	104.00	155	-9	-10	50	4	2	20	-	8500	✓	5.03	GI209	SQ934
80J2R190H50-SLSN134-C	80	292	134.00	190	-9	-10	50	4	2	26	-	7500	✓	7.45	GI209	SQ935
63J2R155G50-SLSN104-C	63	282	104.00	155	-9	-10	50	4	2	20	-	8500	✓	5.20	GI209	SQ934
80J2R190G50-SLSN134-C	80	317	134.00	190	-9	-10	50	4	2	26	-	7500	✓	7.40	GI209	SQ935
63J2R175X50-SLSN104-C	63	277	104.00	175	-9	-10	50	4	2	20	-	8500	✓	6.10	GI209	SQ934
80J2R210X50-SLSN134-C	80	312	134.00	210	-9	-10	50	4	2	26	-	7500	✓	8.50	GI209	SQ935

GI209	LNET 1606..	SN.. 1305..

SQ934	EH6326-SL-C	HS 1230	HXK 10	US 45012-T20P	5.0	M 5	12	SDR T20P-T
SQ935	EH8036-SL-C	HS 1640	HXK 14	US 45012-T20P	5.0	M 5	12	SDR T20P-T

SNGX 13



	IC (mm)	D1 (mm)	S (mm)
1305	13.200	5.90	5.96

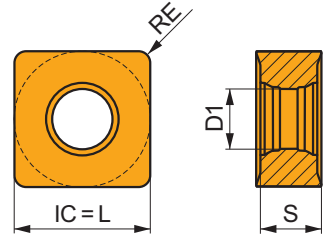

Eignung und Startwerte für Schnittgeschwindigkeit (vc), Vorschub (f) und Schnitttiefe (ap). Weitere Informationen finden Sie in unserer Zerspanungsrechner-App.

Produkt	RE (mm)	P			M			K			N			S			H		
		vc (m/min)	f (mm/tooth)	ap (mm)	vc (m/min)	f (mm/tooth)	ap (mm)	vc (m/min)	f (mm/tooth)	ap (mm)	vc (m/min)	f (mm/tooth)	ap (mm)	vc (m/min)	f (mm/tooth)	ap (mm)	vc (m/min)	f (mm/tooth)	ap (mm)

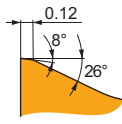

M geometrie mit positiven Design zur leichten Bearbeitung.

SNGX 130512SN-M:M8330	1.2	105	0.15	12.0	–	–	–	95	0.15	12.0	–	–	–	–	–	–	–	–
SNGX 130512SN-M:M8340	1.2	105	0.15	12.0	–	–	–	95	0.15	12.0	–	–	–	–	–	–	–	–

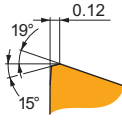

R geometrie mit positiven Design für die Schruppbearbeitung und instabile Bedingungen.

SNGX 130512PN-R:M8330	1.2	95	0.15	12.0	–	–	–	90	0.15	12.0	–	–	–	–	–	–	–	–
SNGX 130512PN-R:M8340	1.2	95	0.15	12.0	–	–	–	90	0.15	12.0	–	–	–	–	–	–	–	–

LNET 16



	W1 (mm)	D1 (mm)	L (mm)	S (mm)
1606	13.200	5.90	16.40	6.38

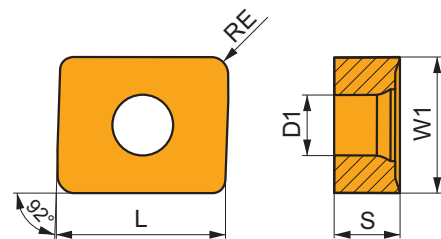

Eignung und Startwerte für Schnittgeschwindigkeit (vc), Vorschub (f) und Schnitttiefe (ap). Weitere Informationen finden Sie in unserer Zerspanungsrechner-App.

Produkt	RE (mm)	P			M			K			N			S			H		
		vc (m/min)	f (mm/tooth)	ap (mm)	vc (m/min)	f (mm/tooth)	ap (mm)	vc (m/min)	f (mm/tooth)	ap (mm)	vc (m/min)	f (mm/tooth)	ap (mm)	vc (m/min)	f (mm/tooth)	ap (mm)	vc (m/min)	f (mm/tooth)	ap (mm)

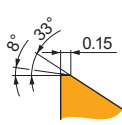

M geometrie mit sehr positiven Design zur mittleren Bearbeitung.

LNET 160616SR-M:M8340	1.6	105	0.15	15.0	–	–	–	95	0.15	15.0	–	–	–	–	–	–	–	–
------------------------------	-----	-----	------	------	---	---	---	----	------	------	---	---	---	---	---	---	---	---

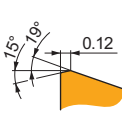

R geometrie mit sehr positiven Design zur mittleren Bearbeitung

LNET 160616SR-R:M8330	1.6	100	0.15	15.0	–	–	–	95	0.15	15.0	–	–	–	–	–	–	–	–
------------------------------	-----	-----	------	------	---	---	---	----	------	------	---	---	---	---	---	---	---	---

Eignung und Startwerte für Schnittgeschwindigkeit (vc), Vorschub (f) und Schnitttiefe (ap). Weitere Informationen finden Sie in unserer Zerspanungsrechner-App.

Produkt	RE (mm)	P			M			K			N			S			H		
		vc (m/min)	f (mm/tooth)	ap (mm)	vc (m/min)	f (mm/tooth)	ap (mm)	vc (m/min)	f (mm/tooth)	ap (mm)	vc (m/min)	f (mm/tooth)	ap (mm)	vc (m/min)	f (mm/tooth)	ap (mm)	vc (m/min)	f (mm/tooth)	ap (mm)

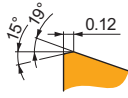

R geometrie mit sehr positiven Design zur mittleren Bearbeitung

LNET 160616SR-R:M8340	1.6	95	0.15	15.0	-	-	-	90	0.15	15.0	-	-	-	-	-	-	-	-
------------------------------	-----	----	------	------	---	---	---	----	------	------	---	---	---	---	---	---	---	---



a_e / DC	5 %	10 %	15 %	20 %	25 %	30 %	40 %	50 %	60 %	70 %	75 %	80 %	90 %	100 %
	1.48	1.35	1.27	1.22	1.19	1.16	1.11	1.08	1.05	1.03	1.00	1.00	1.00	1.00



	1	2.5	5	7.5	10	15	20	
	f_{min}	f_{max}	f_{min}	f_{max}	f_{min}	f_{max}	f_{min}	f_{max}
63	0.64	1.75	0.40	1.11	0.29	0.79	0.24	0.65
80	0.72	1.97	0.45	1.25	0.32	0.89	0.27	0.73

	25	32	40	50	63	80
	f_{min}	f_{max}	f_{min}	f_{max}	f_{min}	f_{max}
63	0.14	0.38	0.12	0.34	0.11	0.30
80	0.15	0.42	0.14	0.38	0.12	0.32

	LNET 16-M	LNET 16-R	SNGX 13-M	SNGX 13-R
RE	1.6	1.6	1.2	1.2
BS	-	-	-	-























ISO				a_e
63J2R155H50-SLSN104-C	63	2+2	104	101.2
80J2R190H50-SLSN134-C	80	2+2	134	131.2
63J2R155G50-SLSN104-C	63	2+2	104	101.2
80J2R190G50-SLSN134-C	80	2+2	134	131.2
63J2R175X50-SLSN104-C	63	2+2	104	101.2
80J2R210X50-SLSN134-C	80	2+2	134	131.2



KOPIERFRÄSEN

WENDEPLATTENFRÄSER – AUSWAHLHILFE

PLANFRÄSEN

	SRD05		SRD07		SRD10		SRD12		SRD16		
	-		-		-		-		-		
	APMX (mm)	1.5	APMX (mm)	2.0	APMX (mm)	2.5	APMX (mm)	3.0	APMX (mm)	4.0	
	DCX (mm)	10 – 15	DCX (mm)	15 – 25	DCX (mm)	20 – 52	DCX (mm)	24 – 80	DCX (mm)	32 – 100	
Zylindrischer Schaft											
Weldon				DCX = 15 (mm)		DCX = 20 (mm)					
Modular				DCX = 15 – 25 (mm)		DCX = 20 – 42 (mm)		DCX = 24 – 42 (mm)		DCX = 32 (mm)	
Aufsteckfräser						DCX = 42, 52 (mm)		DCX = 50 – 80 (mm)		DCX = 52 – 100 (mm)	
Seite		160		163		168		174		180	
ISO	P	K	H	P M K N S H	P M K N S H	P M K N S H	P M K N S H	P M K N S H	P M K N S H		
Schneidplattenform											
Wendeschneidplatten	RD 0501		RD 0702		RD 1003		RD 12T3		RD 1604		
Anzahl der Schneiden	-		-		-		-		-		
Konturfräsen (Kopierfräsen) 	<input checked="" type="checkbox"/>		<input checked="" type="checkbox"/>		<input checked="" type="checkbox"/>		<input checked="" type="checkbox"/>		<input checked="" type="checkbox"/>		
Planfräsen 	<input checked="" type="checkbox"/>		<input checked="" type="checkbox"/>		<input checked="" type="checkbox"/>		<input checked="" type="checkbox"/>		<input checked="" type="checkbox"/>		
Schraubenlinieninterpolation 	<input checked="" type="checkbox"/>		<input checked="" type="checkbox"/>		<input checked="" type="checkbox"/>		<input checked="" type="checkbox"/>		<input checked="" type="checkbox"/>		
Progressives Tauchfräsen 	<input checked="" type="checkbox"/>		<input checked="" type="checkbox"/>		<input checked="" type="checkbox"/>		<input checked="" type="checkbox"/>		<input checked="" type="checkbox"/>		
Rampen 	<input checked="" type="checkbox"/>		<input checked="" type="checkbox"/>		<input checked="" type="checkbox"/>		<input checked="" type="checkbox"/>		<input checked="" type="checkbox"/>		

SRD05



PRAMET

S



Kopierfräser für runde RDHX 05 Wendeschneidplatten mit Innenkühlung

Fräser zum Kopierfräsen mit positiven RDHX 05-Wendeschneidplatten mit einem APMX von 1,5 mm. Innenkühlung. Geeignet fürs Planfräsen, helikale Interpolation, Rampen, progressives Eintauchen und Kopierfräsen. Erhältlich als modularer Fräser. Für längere Standzeiten ist der Körper oberflächenbehandelt.

APMX	1.5 mm
------	--------

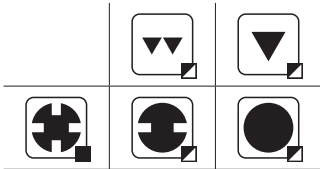
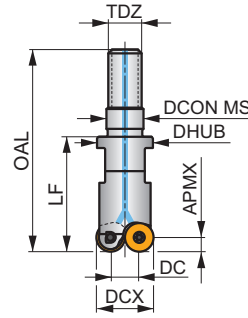
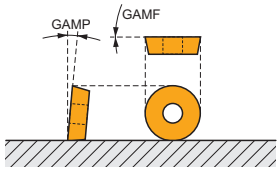

h_m 0.03 - 0.1



Produkt	DCX (mm)	DC (mm)	DHUB (mm)	OAL (mm)	LF (mm)	DCON MS (mm)	TDZ	GAMF (°)	GAMP (°)							
10E2R020M06-SRD05-CF	10	5	9.8	35	20	6.5	M6	5	3	2	-	max.	✓	0.01	G117	C0352
12E3R020M06-SRD05-CF	12	7	10	35	20	6.5	M6	0	3	3	-	max.	✓	0.01	G117	C0352
15E4R020M08-SRD05-CF	15	10	13.5	38	20	8.5	M8	0	3	4	-	max.	✓	0.02	G117	C0352

	G117		RD.. 0501M0..
--	------	--	---------------

	C0352		US 62003B-T06P		0.9		M 2		3		Flag T06P
--	-------	--	----------------	--	-----	--	-----	--	---	--	-----------

RDHX 05



	INSD	D1	S
	(mm)	(mm)	(mm)
0501	5.000	2.20	1.51

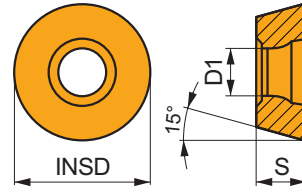

Eignung und Startwerte für Schnittgeschwindigkeit (vc), Vorschub (f) und Schnitttiefe (ap). Weitere Informationen finden Sie in unserer Zerspanungsrechner-App.

Produkt	RE (mm)	P			M			K			N			S			H		
		vc (m/min)	f (mm/tooth)	ap (mm)	vc (m/min)	f (mm/tooth)	ap (mm)	vc (m/min)	f (mm/tooth)	ap (mm)	vc (m/min)	f (mm/tooth)	ap (mm)	vc (m/min)	f (mm/tooth)	ap (mm)	vc (m/min)	f (mm/tooth)	ap (mm)



M0E ohne Spanwinkel zur Schlichtbearbeitung.

RDHX 0501M0E:M8310	✳	-	400	0.10	0.5	-	-	-	380	0.10	0.5	-	-	-	-	-	-	80	0.10	0.3
---------------------------	---	---	-----	------	-----	---	---	---	-----	------	-----	---	---	---	---	---	---	----	------	-----



a_e DCX	5 %	10 %	15 %	20 %	25 %	30 %	40 %	50 %	60 %	70 %	75 %	80 %	90 %	100 %
	1.48	1.35	1.27	1.22	1.19	1.16	1.11	1.08	1.05	1.03	1.00	1.00	1.00	1.00
	2.20	1.60	1.35	1.20	1.10	0.95	0.85	0.75	0.85	0.95	1.00	1.00	1.00	1.00
	0.64	0.64	0.64	0.64	0.64	0.65	0.65	0.67	0.68	0.71	0.72	0.74	0.79	1.00

	RDHX 05
	2.5
	-

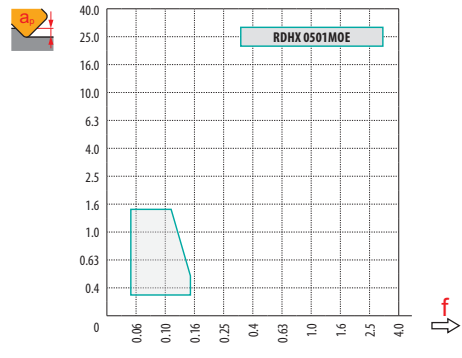

		0.00	0.30	0.50	0.75	1.00	1.25	1.50	2.00	2.50
10		5.0	7.4	8.0	8.6	9.0	9.3	9.6	9.9	10.0
12		7.0	9.4	10.0	10.6	11.0	11.3	11.6	11.9	12.0
15		10.0	12.4	13.0	13.6	14.0	14.3	14.6	14.9	15.0
		-	0.30	0.50	0.75	1.00	1.25	1.50	2.00	2.50
		-	0.25	0.19	0.16	0.14	0.13	0.12	0.10	0.09

	RPMX	APMX/I
10	15.0	1.3/11
12	11.0	1.3/14
15	7.0	1.3/22

	DMIN	DMAX		
10	12.0	20.0	1.2	1.2
12	16.0	24.0	1.2	1.2
15	22.0	30.0	1.2	1.2

1.0

	μm	3	5	10	15	20	30	40	50	60	80	100
10		0.346	0.447	0.632	0.775	0.894	1.095	1.265	1.414	1.549	1.789	2.000
12		0.379	0.490	0.693	0.849	0.980	1.200	1.386	1.549	1.697	1.960	2.191
15		0.424	0.548	0.775	0.949	1.095	1.342	1.549	1.732	1.897	2.191	2.449
		3	5	10	15	20	30	40	50	60	80	100
2.5		0.245	0.316	0.447	0.548	0.632	0.775	0.894	1.000	1.095	1.265	1.414

SRD07

P M K N S H

PRAMET

S

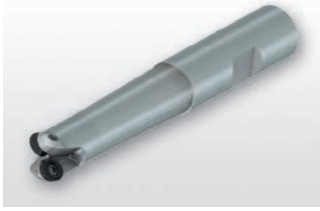

Kopierfräser für runde RD.. 07 Wendeschneidplatten mit Innenkühlung

Fräser zum Kopierfräsen mit positiven RD.. 07-Wendeschneidplatten mit APMX von 2 mm. Innenkühlung. Geeignet fürs Planfräsen, helikale Interpolation, Rampen, progressives Eintauchen und Kopierfräsen. Erhältlich als Weldon- und modularer Schaft. Für längere Standzeiten ist der Körper oberflächenbehandelt.

APMX	2.0 mm
------	--------

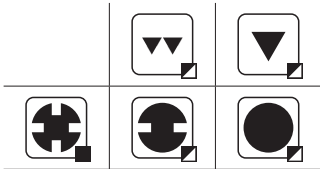
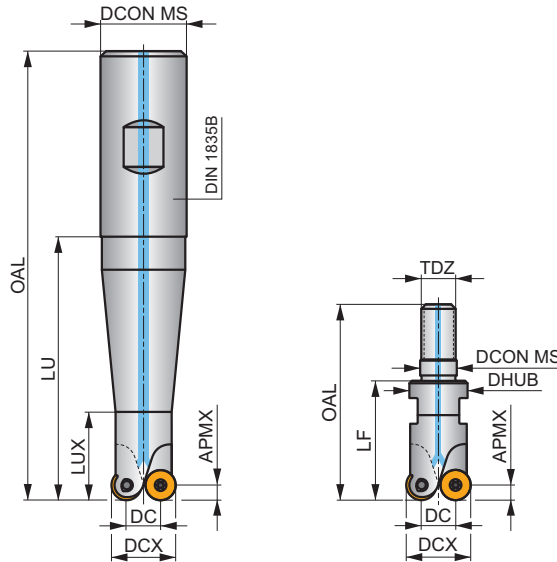
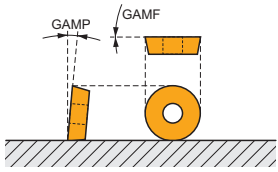

h_m 0.065 - 0.13



Produkt	DCX	DC	OAL	DCON MS	DHUB	LU	LUX	LF	TDZ	GAMF	GAMP							
	(mm)	(mm)	(mm)	(mm)	(mm)	(mm)	(mm)	(mm)	(mm)	(°)	(°)							
15E2R040B16-SRD07-CF	15	8	88	16	-	40	20	-	-	1	0	2	-	44200	✓	0.12	G118	C0354
15E2R060B16-SRD07-CF	15	8	108	16	-	60	20	-	-	1	0	2	-	44200	✓	0.15	G118	C0354
15E2R080B20-SRD07-CF	15	8	130	20	-	80	22	-	-	1	0	2	-	44200	✓	0.22	G118	C0354
15E2R100B20-SRD07-CF	15	8	150	20	-	100	22	-	-	1	0	2	-	44200	✓	0.25	G118	C0354
15E2R120B25-SRD07-CF	15	8	176	25	-	120	22	-	-	1	0	2	-	44200	✓	0.45	G118	C0354
15E2R028M08-SRD07-CF	15	8	46	8.5	13.5	-	-	28	M8	1	0	2	-	44200	✓	0.03	G118	C0354
15E3R028M08-SRD07-CF	15	8	46	10.5	13.5	-	-	28	M8	2	0	3	-	44200	✓	0.05	G118	C0354
20E4R028M10-SRD07-CF	20	13	47	12.5	18	-	-	28	M10	-8	0	4	-	38200	✓	0.07	G118	C0354
25E5R028M12-SRD07-CF	25	18	50	12.5	21	-	-	28	M12	-2	0	5	-	34200	✓	0.09	G118	C0354

G118	RD..07..MO..

C0354	US 42505-T07P	1.2	M 2.5	5	Flag T07P

RDGT 07



	INSD (mm)	D1 (mm)	S (mm)
0702	7.000	2.80	2.38

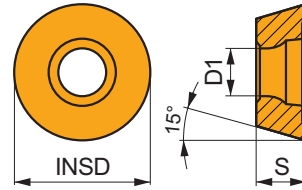

Eignung und Startwerte für Schnittgeschwindigkeit (vc), Vorschub (f) und Schnitttiefe (ap). Weitere Informationen finden Sie in unserer Zerspanungsrechner-App.

Produkt	RE (mm)	P			M			K			N			S			H			
		vc (m/min)	f (mm/tooth)	ap (mm)	vc (m/min)	f (mm/tooth)	ap (mm)	vc (m/min)	f (mm/tooth)	ap (mm)	vc (m/min)	f (mm/tooth)	ap (mm)	vc (m/min)	f (mm/tooth)	ap (mm)	vc (m/min)	f (mm/tooth)	ap (mm)	
	●●●																			
	●●●																			
	●●●																			

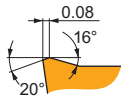

MOT positive Ausführung zum Schlichten.

RDGT 0702MOT:M8325	●●●	–	■	305	0.15	0.5	▣	145	0.14	0.5	■	–	–	–	–	–	–	–	–	–
RDGT 0702MOT:M8345	●●●	–	■	270	0.15	0.5	▣	160	0.14	0.5	■	–	–	–	▣	65	0.12	0.4	–	–

RDHX 07



	INSD (mm)	D1 (mm)	S (mm)
0702	7.000	2.80	2.38
07T1	7.000	2.80	1.98

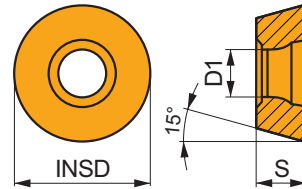

Eignung und Startwerte für Schnittgeschwindigkeit (vc), Vorschub (f) und Schnitttiefe (ap). Weitere Informationen finden Sie in unserer Zerspanungsrechner-App.

Produkt	RE (mm)	P			M			K			N			S			H			
		vc (m/min)	f (mm/tooth)	ap (mm)	vc (m/min)	f (mm/tooth)	ap (mm)	vc (m/min)	f (mm/tooth)	ap (mm)	vc (m/min)	f (mm/tooth)	ap (mm)	vc (m/min)	f (mm/tooth)	ap (mm)	vc (m/min)	f (mm/tooth)	ap (mm)	
	●●●																			
	●●●																			
	●●●																			

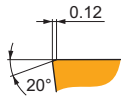

MOT ohne Spanwinkel zur Schlichtbearbeitung.

RDHX 0702MOT:M4303	●●●	–	▣	370	0.15	0.5	■	–	–	–	■	350	0.15	0.5	–	–	–	–	–	–	■	70	0.11	0.5
RDHX 0702MOT:M8310	●●●	–	▣	360	0.15	0.5	■	–	–	–	■	340	0.15	0.5	–	–	–	–	–	–	■	70	0.11	0.5
RDHX 0702MOT:M8325	●●●	–	▣	275	0.15	0.5	■	–	–	–	■	–	–	–	–	–	–	–	–	–	–	–	–	
RDHX 07T1MOT:M8310	●●●	–	▣	360	0.15	0.5	■	–	–	–	■	340	0.15	0.5	–	–	–	–	–	–	■	70	0.11	0.5

RDHT 07-FA



	INSD	D1	S
	(mm)	(mm)	(mm)
0702	7.000	2.80	2.38

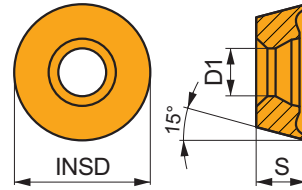

Eignung und Startwerte für Schnittgeschwindigkeit (vc), Vorschub (f) und Schnitttiefe (ap). Weitere Informationen finden Sie in unserer Zerspanungsrechner-App.

Produkt	RE (mm)	P			M			K			N			S			H		
		vc (m/min)	f (mm/tooth)	ap (mm)	vc (m/min)	f (mm/tooth)	ap (mm)	vc (m/min)	f (mm/tooth)	ap (mm)	vc (m/min)	f (mm/tooth)	ap (mm)	vc (m/min)	f (mm/tooth)	ap (mm)	vc (m/min)	f (mm/tooth)	ap (mm)

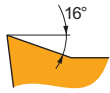
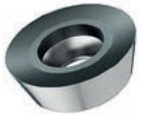

FA geometrie mit hoch positiven Design zur feinen Schlichtbearbeitung bis zur mittleren Bearbeitung.

RDHT 0702M0-FA:HF7	●	-	-	-	-	-	-	-	-	-	■	420	0.18	0.5	-	-	-	-	-
---------------------------	---	---	---	---	---	---	---	---	---	---	---	-----	------	-----	---	---	---	---	---



a_e / DCX	5 %	10 %	15 %	20 %	25 %	30 %	40 %	50 %	60 %	70 %	75 %	80 %	90 %	100 %
	1.48	1.35	1.27	1.22	1.19	1.16	1.11	1.08	1.05	1.03	1.00	1.00	1.00	1.00
	2.20	1.60	1.35	1.20	1.10	0.95	0.85	0.75	0.85	0.95	1.00	1.00	1.00	1.00
	0.64	0.64	0.64	0.64	0.64	0.65	0.65	0.67	0.68	0.71	0.72	0.74	0.79	1.00

	RDHX 07	RDGT 07	RDHT 07-FA
	3.5	3.5	3.5
	—	—	—

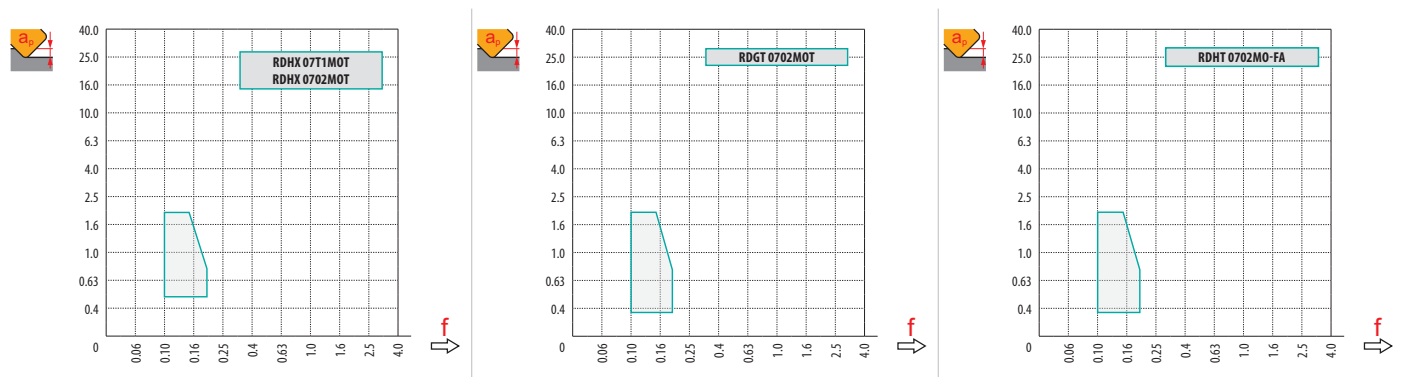

		0.00	0.30	0.50	0.75	1.00	1.25	1.50	2.00	2.50	3.00	3.50
15		8.0	10.8	11.6	12.3	12.9	13.4	13.7	14.3	14.7	14.9	15.0
20		13.0	15.8	16.6	17.3	17.9	18.4	18.7	19.3	19.7	19.9	20.0
25		18.0	20.8	21.6	22.3	22.9	23.4	23.7	24.3	24.7	24.9	25.0
		0.00	0.30	0.50	0.75	1.00	1.25	1.50	2.00	2.50	3.00	3.50
		—	0.29	0.23	0.19	0.16	0.15	0.13	0.12	0.11	0.10	0.09

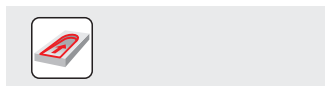

	RPMX	APMX/I
15	11.0	1.7/20
20	7.0	1.7/30
25	6.0	1.7/35

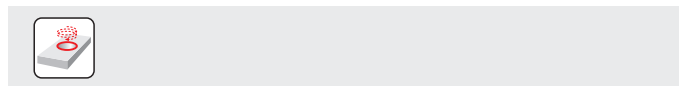



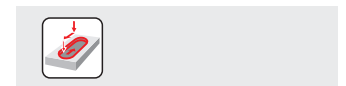





	DMIN	DMAX		
15	17.0	30.0	DMIN	DMAX
20	28.0	40.0	0.4	1.7
25	38.0	50.0	1.7	1.7



1.2



		3	5	10	15	20	30	40	50	60	80	100
15		0.424	0.548	0.775	0.949	1.095	1.342	1.549	1.732	1.897	2.191	2.449
20		0.490	0.632	0.894	1.095	1.265	1.549	1.789	2.000	2.191	2.530	2.828
25		0.548	0.707	1.000	1.225	1.414	1.732	2.000	2.236	2.449	2.828	3.162
		3	5	10	15	20	30	40	50	60	80	100
3.5		0.290	0.374	0.529	0.648	0.748	0.917	1.058	1.183	1.296	1.497	1.673

SRD10

P M K N S H

PRAMET

S

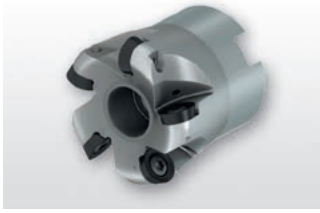

Kopierfräser für runde RD.. 10 Wendeschneidplatten mit Innenkühlung

Fräser zum Kopierfräsen mit positivem RD.. 10 Wendeschneidplatten mit APMX von 2,5 mm. Innenkühlung. Geeignet fürs Planfräsen, helikale Interpolation, Rampen, progressives Eintauchen und Kopierfräsen. Erhältlich als Weldon-, modularer Schaft- und Aufsteckfräser. Für längere Standzeiten ist der Körper oberflächenbehandelt.

APMX	2.5 mm
------	--------

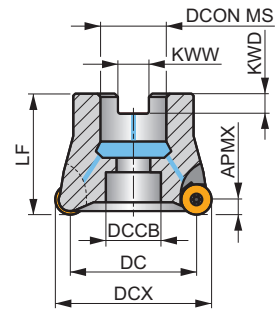
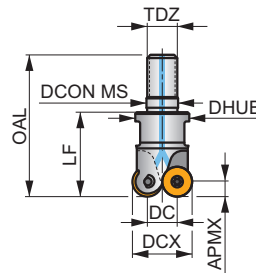
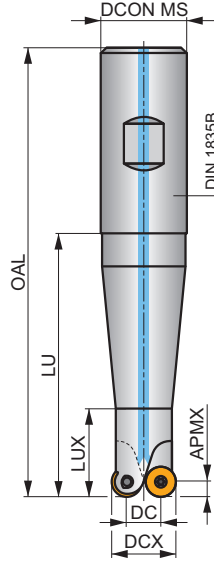
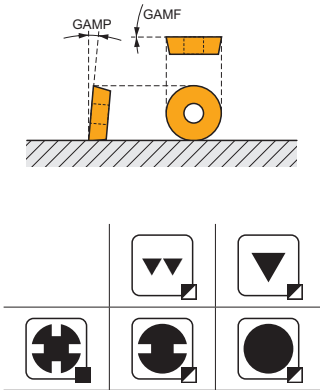

h_m 0.065 - 0.19



Produkt	DCX	DC	OAL	DCON MS	DHUB	DCCB	LU	LUX	LF	TDZ	KWW	KWD	GAMF	GAMP	max.			kg	G		
	(mm)	(mm)	(mm)	(mm)	(mm)	(mm)	(mm)	(mm)	(mm)	(mm)	(mm)	(mm)	(°)	(°)							
	20E2R040B20-SRD10-CF	20	10	90	20	-	40	20	-	-	-	-	-2	0	2	-	30800	✓	0.20	GI119	C0356
	20E2R060B20-SRD10-CF	20	10	110	20	-	60	22	-	-	-	-	-2	0	2	-	30800	✓	0.20	GI119	C0356
	20E2R080B25-SRD10-CF	20	10	136	25	-	80	25	-	-	-	-	-2	0	2	-	30800	✓	0.40	GI119	C0356
	20E2R100B25-SRD10-CF	20	10	156	25	-	100	25	-	-	-	-	-2	0	2	-	30800	✓	0.45	GI119	C0356
	20E2R120B25-SRD10-CF	20	10	176	25	-	120	25	-	-	-	-	-2	0	2	-	30800	✓	0.46	GI119	C0356
	20E2R028M10-SRD10-CF	20	10	47	10.5	18	-	-	28	M10	-	-	-2	0	2	-	30800	✓	0.07	GI119	C0356
	25E2R032M12-SRD10-CF	25	15	54	12.5	21	-	-	32	M12	-	-	0.5	0.5	2	-	27500	✓	0.08	GI119	C0356
	25E3R032M12-SRD10-CF	25	15	54	12.5	21	-	-	32	M12	-	-	0.5	0.5	3	-	27500	✓	0.10	GI119	C0356
	30E4R042M16-SRD10-CF	30	20	65	17	29	-	-	42	M16	-	-	0	0	4	-	25100	✓	0.20	GI119	C0356
	32E4R042M16-SRD10-CF	32	22	65	17	29	-	-	42	M16	-	-	0	0	4	-	24300	✓	0.19	GI119	C0356
	35E5R042M16-SRD10-CF	35	25	65	17	29	-	-	42	M16	-	-	0	0	5	-	23200	✓	0.22	GI119	C0356
	42E4R042M16-SRD10-CF	42	32	65	17	29	-	-	42	M16	-	-	0	0	4	-	21200	✓	0.24	GI119	C0356
	42E5R042M16-SRD10-CF	42	32	65	17	29	-	-	42	M16	-	-	0	0	5	-	21200	✓	0.24	GI119	C0356
	42A05R-SMORD10-CF	42	32	-	16	-	14	-	40	-	8.4	8.4	0	0	5	-	21200	✓	0.20	GI119	C0358
	52A07R-SMORD10-CF	52	42	-	22	-	18	-	40	-	10.4	10.4	0	0	7	-	19100	✓	0.41	GI119	C0360

GI119	RD.. 1003MOT	RDHT 1003MO-FA
-------	--------------	----------------

C0356	US 63507-T15P	3.0	M 3.5	7	Flag T15P	-	-
C0358	US 63507-T15P	3.0	M 3.5	7	D-T08P/T15P	FG-15	HS 0830C
C0360	US 63507-T15P	3.0	M 3.5	7	D-T08P/T15P	FG-15	HS 1030C

RDGT 10



	INSD	D1	S
	(mm)	(mm)	(mm)
1003	10.000	3.90	3.18

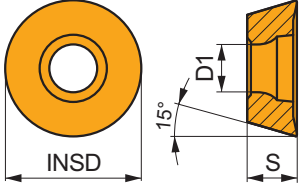

Eignung und Startwerte für Schnittgeschwindigkeit (vc), Vorschub (f) und Schnitttiefe (ap). Weitere Informationen finden Sie in unserer Zerspanungsrechner-App.

Produkt	RE (mm)	P			M			K			N			S			H		
		vc	f	ap	vc	f	ap	vc	f	ap	vc	f	ap	vc	f	ap	vc	f	ap
		(m/min)	(mm/tooth)	(mm)	(m/min)	(mm/tooth)	(mm)	(m/min)	(mm/tooth)	(mm)	(m/min)	(mm/tooth)	(mm)	(m/min)	(mm/tooth)	(mm)	(m/min)	(mm/tooth)	(mm)

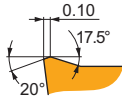

MOT positive Ausführung zum Schlichten.

RDGT 1003MOT:M6330	☼	–	■	290	0.15	1.0	■	205	0.14	1.0	■	–	–	–	■	85	0.12	0.8	■	–	–	–	
RDGT 1003MOT:M8310	☼	–	■	375	0.15	1.0	■	190	0.14	1.0	■	■	355	0.15	1.0	■	–	–	–	■	–	–	–
RDGT 1003MOT:M8325	☼	–	■	280	0.15	1.0	■	130	0.14	1.0	■	■	–	–	–	■	–	–	–	■	–	–	–
RDGT 1003MOT:M8345	☼	–	■	250	0.15	1.0	■	150	0.14	1.0	■	■	–	–	–	■	60	0.12	0.8	■	–	–	–
RDGT 1003MOT:M9340	☼	–	■	395	0.15	1.0	■	235	0.14	1.0	■	■	–	–	–	■	95	0.12	0.8	■	–	–	–

RDMT 10



	INSD	D1	S
	(mm)	(mm)	(mm)
1003	10.000	3.90	3.18

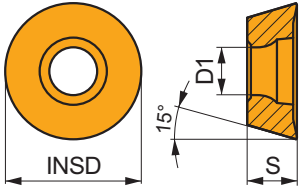

Eignung und Startwerte für Schnittgeschwindigkeit (vc), Vorschub (f) und Schnitttiefe (ap). Weitere Informationen finden Sie in unserer Zerspanungsrechner-App.

Produkt	RE (mm)	P			M			K			N			S			H		
		vc	f	ap	vc	f	ap	vc	f	ap	vc	f	ap	vc	f	ap	vc	f	ap
		(m/min)	(mm/tooth)	(mm)	(m/min)	(mm/tooth)	(mm)	(m/min)	(mm/tooth)	(mm)	(m/min)	(mm/tooth)	(mm)	(m/min)	(mm/tooth)	(mm)	(m/min)	(mm/tooth)	(mm)

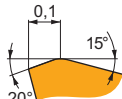

MOT positive Ausführung zum Schlichten.

RDMT 1003MOT:M8325	☼	–	■	280	0.15	1.0	■	130	0.14	1.0	■	■	–	–	–	■	–	–	–	■	–	–	–
RDMT 1003MOT:M8345	☼	–	■	250	0.15	1.0	■	150	0.14	1.0	■	■	–	–	–	■	–	–	–	■	–	–	–

RDMX 10



	INSD	D1	S
	(mm)	(mm)	(mm)
1003	10.000	3.90	3.18

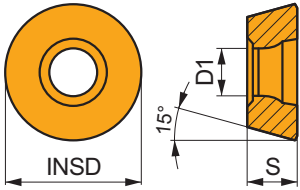

Eignung und Startwerte für Schnittgeschwindigkeit (vc), Vorschub (f) und Schnitttiefe (ap). Weitere Informationen finden Sie in unserer Zerspanungsrechner-App.

Produkt	RE	P			M			K			N			S			H		
		vc	f	ap	vc	f	ap	vc	f	ap	vc	f	ap	vc	f	ap	vc	f	ap
	(mm)	(m/min)	(mm/tooth)	(mm)	(m/min)	(mm/tooth)	(mm)	(m/min)	(mm/tooth)	(mm)	(m/min)	(mm/tooth)	(mm)	(m/min)	(mm/tooth)	(mm)	(m/min)	(mm/tooth)	(mm)

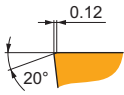
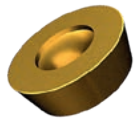

MOT ohne Spanwinkel zur Schlichtbearbeitung.

RDMX 1003MOT:M8310	✳	–	✔	335	0.15	1.0	–	–	–	✔	315	0.15	1.0	–	–	–	–	–	–	–	✔	65	0.11	0.7
RDMX 1003MOT:M8325	✳	–	✔	250	0.15	1.0	–	–	–	–	–	–	–	–	–	–	–	–	–	–	–	–	–	–
RDMX 1003MOT:M8345	✳	–	✔	225	0.15	1.0	–	–	–	–	–	–	–	–	–	–	–	–	–	–	–	–	–	–

RDHX 10



	INSD	D1	S
	(mm)	(mm)	(mm)
1003	10.000	3.90	3.18

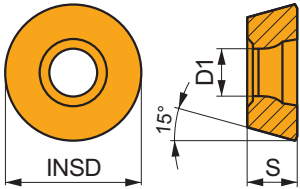

Eignung und Startwerte für Schnittgeschwindigkeit (vc), Vorschub (f) und Schnitttiefe (ap). Weitere Informationen finden Sie in unserer Zerspanungsrechner-App.

Produkt	RE	P			M			K			N			S			H		
		vc	f	ap	vc	f	ap	vc	f	ap	vc	f	ap	vc	f	ap	vc	f	ap
	(mm)	(m/min)	(mm/tooth)	(mm)	(m/min)	(mm/tooth)	(mm)	(m/min)	(mm/tooth)	(mm)	(m/min)	(mm/tooth)	(mm)	(m/min)	(mm/tooth)	(mm)	(m/min)	(mm/tooth)	(mm)

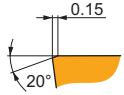

MOT ohne Spanwinkel zur Schlichtbearbeitung.

RDHX 1003MOT:M4303	✳	–	✔	340	0.15	1.0	–	–	–	✔	320	0.15	1.0	–	–	–	–	–	–	–	–	–	–	–	–
RDHX 1003MOT:M8310	✳	–	✔	335	0.15	1.0	–	–	–	✔	315	0.15	1.0	–	–	–	–	–	–	–	–	–	–	–	–
RDHX 1003MOT:M8325	✳	–	✔	250	0.15	1.0	–	–	–	–	–	–	–	–	–	–	–	–	–	–	–	–	–	–	
RDHX 1003MOT:M8345	✳	–	✔	225	0.15	1.0	–	–	–	–	–	–	–	–	–	–	–	–	–	–	–	–	–	–	

RDHT 10-FA



	INSD	D1	S
	(mm)	(mm)	(mm)
1003	10.000	3.90	3.18

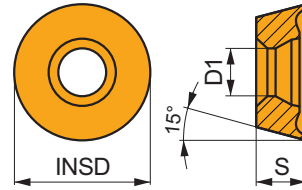

Eignung und Startwerte für Schnittgeschwindigkeit (vc), Vorschub (f) und Schnitttiefe (ap). Weitere Informationen finden Sie in unserer Zerspanungsrechner-App.

Produkt	RE (mm)	P			M			K			N			S			H		
		vc (m/min)	f (mm/tooth)	ap (mm)	vc (m/min)	f (mm/tooth)	ap (mm)	vc (m/min)	f (mm/tooth)	ap (mm)	vc (m/min)	f (mm/tooth)	ap (mm)	vc (m/min)	f (mm/tooth)	ap (mm)	vc (m/min)	f (mm/tooth)	ap (mm)

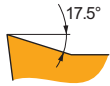
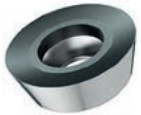

FA geometrie mit hoch positiven Design zur feinen Schlichtbearbeitung bis zur mittleren Bearbeitung.

RDHT 1003MO-FA:HF7	●	-	-	-	-	-	-	-	-	-	■	390	0.18	1.0	-	-	-	-	-
---------------------------	---	---	---	---	---	---	---	---	---	---	---	-----	------	-----	---	---	---	---	---



a_e / DCX	5 %	10 %	15 %	20 %	25 %	30 %	40 %	50 %	60 %	70 %	75 %	80 %	90 %	100 %
	1.48	1.35	1.27	1.22	1.19	1.16	1.11	1.08	1.05	1.03	1.00	1.00	1.00	1.00
	2.20	1.60	1.35	1.20	1.10	0.95	0.85	0.75	0.85	0.95	1.00	1.00	1.00	1.00
	0.64	0.64	0.64	0.64	0.64	0.65	0.65	0.67	0.68	0.71	0.72	0.74	0.79	1.00

	RDHX 10	RDMX 10	RDGT 10	RDHT 10-FA	RDMT 10
	5.0	5.0	5.0	5.0	5.0
	-	-	-	-	-

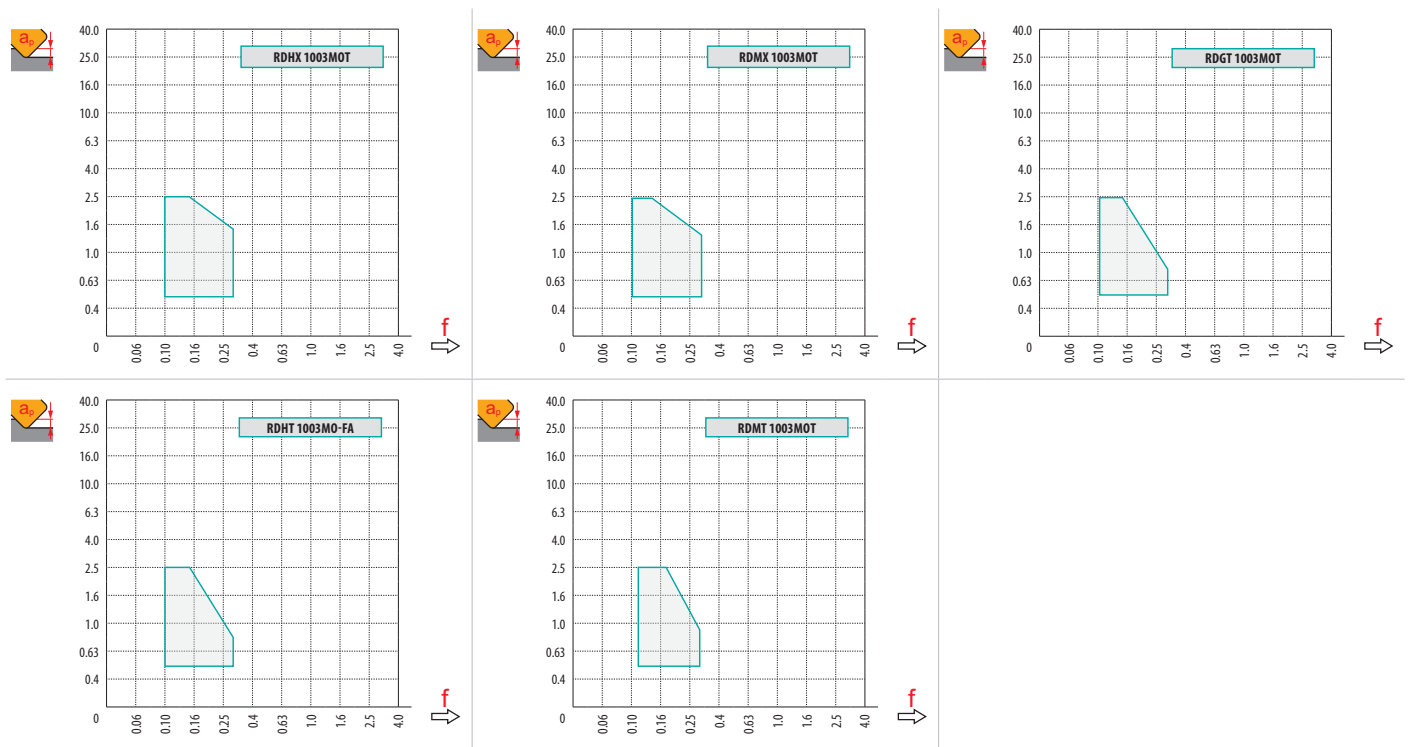

		0.00	0.50	0.75	1.00	1.25	1.50	2.00	2.50	3.00	3.50	4.00	5.00
20		10.0	14.4	15.3	16.0	16.6	17.1	18.0	18.7	19.2	19.5	19.8	20.0
25		15.0	19.4	20.3	21.0	21.6	22.1	23.0	23.7	24.2	24.5	24.8	25.0
30		20.0	24.4	25.3	26.0	26.6	27.1	28.0	28.7	29.2	29.5	29.8	30.0
32		22.0	26.4	27.3	28.0	28.6	29.1	30.0	30.7	31.2	31.5	31.8	32.0
35		25.0	29.4	30.3	31.0	31.6	32.1	33.0	33.7	34.2	34.5	34.8	35.0
42		32.0	36.4	37.3	38.0	38.6	39.1	40.0	40.7	41.2	41.5	41.8	42.0
52		42.0	46.4	47.3	48.0	48.6	49.1	50.0	50.7	51.2	51.5	51.8	52.0
		0.00	0.50	0.75	1.00	1.25	1.50	2.00	2.50	3.00	3.50	4.00	5.00
		-	0.54	0.44	0.39	0.35	0.32	0.28	0.25	0.23	0.22	0.21	0.19

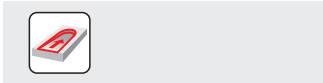

	RPMX	APMX/I
20	20	2.5/15
25	12	2.5/25
30	8	2.5/37
32	7.5	2.5/20
35	7	2.5/42
42	4	2.5/37
52	3	2.5/49

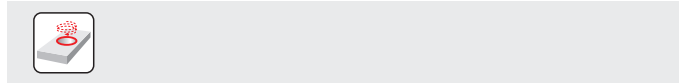

	DMIN	DMAX		
			DMIN	DMAX
20	22.0	40.0	2.5	2.5
25	32.0	50.0	2.5	2.5
30	42.0	60.0	2.5	2.5
32	46.0	64.0	2.5	2.5
35	52.0	70.0	2.5	2.5
42	66.0	84.0	2.5	2.5
52	86.0	104.0	2.5	2.5

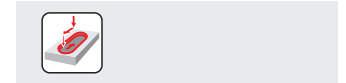

	2.5
--	-----

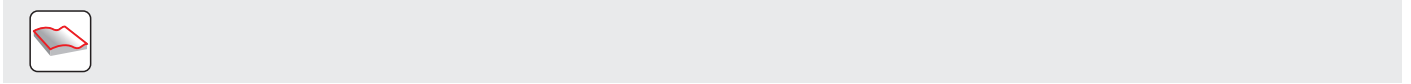

		3	5	10	15	20	30	40	50	60	80	100
20		0.490	0.632	0.894	1.095	1.265	1.549	1.789	2.000	2.191	2.530	2.828
25		0.548	0.707	1.000	1.225	1.414	1.732	2.000	2.236	2.449	2.828	3.162
30		0.600	0.775	1.095	1.342	1.549	1.897	2.191	2.449	2.683	3.098	3.464
32		0.620	0.800	1.131	1.386	1.600	1.960	2.263	2.530	2.771	3.200	3.578
35		0.648	0.837	1.183	1.449	1.673	2.049	2.366	2.646	2.898	3.347	3.742
42		0.710	0.917	1.296	1.587	1.833	2.245	2.592	2.898	3.175	3.666	4.099
52		0.790	1.020	1.442	1.766	2.040	2.498	2.884	3.225	3.533	4.079	4.561
		3	5	10	15	20	30	40	50	60	80	100
5.0		0.346	0.447	0.632	0.775	0.894	1.095	1.265	1.414	1.549	1.789	2.000

SRD12



PRAMET



Kopierfräser für runde RD.. 12 Wendeschneidplatten mit Innenkühlung

Fräser zum Kopierfräsen mit positivem RD.. 12 Wendeschneidplatten mit APMX von 3 mm. Innenkühlung. Geeignet fürs Planfräsen, helikale Interpolation, Rampen, progressives Eintauchen und Kopierfräsen. Erhältlich als modularer Fräser und Aufsteckfräser. Körper für längere Standzeiten oberflächenbehandelt.

APMX	3.0 mm
------	--------

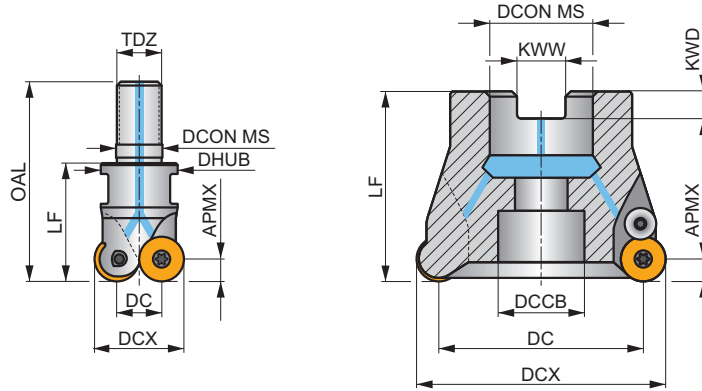
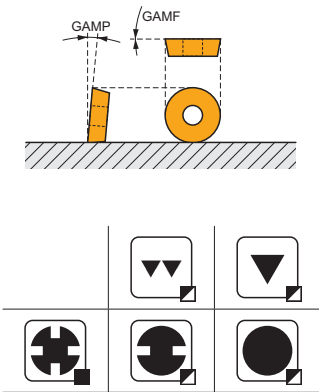

Produkt	DCX	DC	OAL	DCON MS	DHUB	DCCB	LF	TDZ	KWW	KWD	GAMF	GAMP	max.		kg	Icons		
	(mm)	(mm)	(mm)	(mm)	(mm)	(mm)	(mm)	(mm)	(mm)	(mm)	(°)	(°)						
24E2R032M12-SRD12-CF	24	12	54	12.5	21	-	32	M12	-	-	-3	0	2	-	21900	✓	0.10	GI120 C0362
35E3R042M16-SCRD12-CF	35	23	65	17	29	-	42	M16	-	-	0	0	3	-	18100	✓	0.22	GI120 C0364
35E4R042M16-SRD12-CF	35	23	65	17	29	-	42	M16	-	-	0	0	4	-	18100	✓	0.20	GI120 C0362
42E4R042M16-SCRD12-CF	42	30	65	17	29	-	42	M16	-	-	0	0	4	-	16600	✓	0.21	GI120 C0364
42E5R042M16-SRD12-CF	42	30	65	17	29	-	42	M16	-	-	0	0	5	-	16600	✓	0.22	GI120 C0366
50A05R-SCMORD12-CF	50	38	-	22	-	18	50	-	10.4	10.4	2	7	5	-	15200	✓	0.29	GI120 C0366
52A05R-SCMORD12-CF	52	40	-	22	-	18	50	-	10.4	10.4	2	7	5	-	14900	✓	0.44	GI120 C0366
66A06R-SCMORD12-CF	66	54	-	27	-	22	50	-	12.4	12.4	2	7	6	-	13200	✓	0.54	GI120 C0370
80A07R-SCMORD12-CF	80	68	-	27	-	38	52	-	12.4	12.4	2	7	7	-	12000	✓	0.89	GI120 C0372

GI120	RD.. 12T3MOT	RDHT 12T3MO-FA

Icon	Icon	Nm	Icon	Icon	Icon	Icon	Icon	Icon	Icon
C0362	US 3508-T15P	3.5	M 3.5	8	-	-	Flag T15P	-	-
C0364	US 3006-T09P	2.0	M 3	6	D-T07P/T09P	FG-15	-	CS12P	-
C0366	US 3508-T15P	3.5	M 3.5	8	D-T08P/T15P	FG-15	-	CS12P	HS 1030C
C0370	US 3508-T15P	3.5	M 3.5	8	D-T08P/T15P	FG-15	-	CS12P	HS 1230C
C0372	US 3508-T15P	3.5	M 3.5	8	D-T08P/T15P	FG-15	-	CS12P	-

RDGT 12



	INSD	D1	S
	(mm)	(mm)	(mm)
12T3	12.000	3.90	3.97

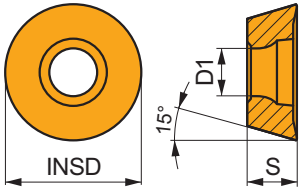

Eignung und Startwerte für Schnittgeschwindigkeit (vc), Vorschub (f) und Schnitttiefe (ap). Weitere Informationen finden Sie in unserer Zerspanungsrechner-App.

Produkt	RE (mm)	P			M			K			N			S			H		
		vc	f	ap	vc	f	ap	vc	f	ap	vc	f	ap	vc	f	ap	vc	f	ap
		(m/min)	(mm/tooth)	(mm)	(m/min)	(mm/tooth)	(mm)	(m/min)	(mm/tooth)	(mm)	(m/min)	(mm/tooth)	(mm)	(m/min)	(mm/tooth)	(mm)	(m/min)	(mm/tooth)	(mm)

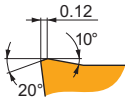

MOT positive Ausführung zum Schlichten.

RDGT 12T3MOT:M6330	✳	–	■	260	0.20	1.5	■	185	0.18	1.5	■	–	–	–	■	75	0.14	1.2	■	–	–	–	
RDGT 12T3MOT:M8310	✳	–	■	330	0.20	1.5	■	165	0.18	1.5	■	■	310	0.20	1.5	■	–	–	–	■	–	–	–
RDGT 12T3MOT:M8325	✳	–	■	250	0.20	1.5	■	120	0.18	1.5	■	■	–	–	–	■	–	–	–	■	–	–	–
RDGT 12T3MOT:M8345	✳	–	■	225	0.20	1.5	■	135	0.18	1.5	■	■	–	–	–	■	55	0.14	1.2	■	–	–	–
RDGT 12T3MOT:M9340	✳	–	■	340	0.20	1.5	■	200	0.18	1.5	■	■	–	–	–	■	85	0.14	1.2	■	–	–	–

RDMT 12



	INSD	D1	S
	(mm)	(mm)	(mm)
12T3	12.000	3.90	3.97

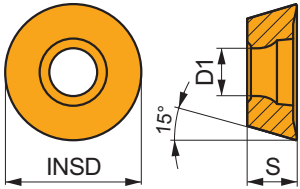

Eignung und Startwerte für Schnittgeschwindigkeit (vc), Vorschub (f) und Schnitttiefe (ap). Weitere Informationen finden Sie in unserer Zerspanungsrechner-App.

Produkt	RE (mm)	P			M			K			N			S			H		
		vc	f	ap	vc	f	ap	vc	f	ap	vc	f	ap	vc	f	ap	vc	f	ap
		(m/min)	(mm/tooth)	(mm)	(m/min)	(mm/tooth)	(mm)	(m/min)	(mm/tooth)	(mm)	(m/min)	(mm/tooth)	(mm)	(m/min)	(mm/tooth)	(mm)	(m/min)	(mm/tooth)	(mm)

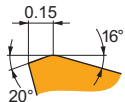

MOT positive Ausführung zum Schlichten.

RDMT 12T3MOT:M8345	✳	–	■	225	0.20	1.5	■	135	0.18	1.5	■	■	–	–	–	■	–	–	–	■	–	–	–
---------------------------	---	---	---	-----	------	-----	---	-----	------	-----	---	---	---	---	---	---	---	---	---	---	---	---	---

RDMX 12



	INSD	D1	S
	(mm)	(mm)	(mm)
12T3	12.000	3.90	3.97

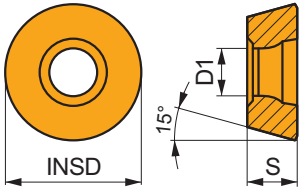

Eignung und Startwerte für Schnittgeschwindigkeit (vc), Vorschub (f) und Schnitttiefe (ap). Weitere Informationen finden Sie in unserer Zerspanungsrechner-App.

Produkt	RE	P			M			K			N			S			H		
		vc	f	ap	vc	f	ap	vc	f	ap	vc	f	ap	vc	f	ap	vc	f	ap
	(mm)	(m/min)	(mm/tooth)	(mm)	(m/min)	(mm/tooth)	(mm)	(m/min)	(mm/tooth)	(mm)	(m/min)	(mm/tooth)	(mm)	(m/min)	(mm/tooth)	(mm)	(m/min)	(mm/tooth)	(mm)

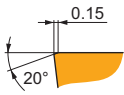
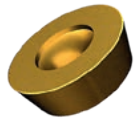

MOT ohne Spanwinkel zur Schlichtbearbeitung.

RDMX 12T3MOT:M8310	✳	–	300	0.20	1.5	–	–	–	285	0.20	1.5	–	–	–	–	–	–	–	–	60	0.10	0.8
RDMX 12T3MOT:M8325	✳	–	225	0.20	1.5	–	–	–	–	–	–	–	–	–	–	–	–	–	–	–	–	–
RDMX 12T3MOT:M8345	✳	–	200	0.20	1.5	–	–	–	–	–	–	–	–	–	–	–	–	–	–	–	–	–

RDHX 12



	INSD	D1	S
	(mm)	(mm)	(mm)
12T3	12.000	3.90	3.97

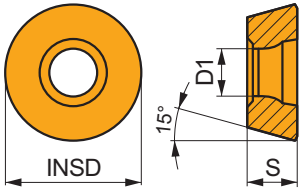

Eignung und Startwerte für Schnittgeschwindigkeit (vc), Vorschub (f) und Schnitttiefe (ap). Weitere Informationen finden Sie in unserer Zerspanungsrechner-App.

Produkt	RE	P			M			K			N			S			H		
		vc	f	ap	vc	f	ap	vc	f	ap	vc	f	ap	vc	f	ap	vc	f	ap
	(mm)	(m/min)	(mm/tooth)	(mm)	(m/min)	(mm/tooth)	(mm)	(m/min)	(mm/tooth)	(mm)	(m/min)	(mm/tooth)	(mm)	(m/min)	(mm/tooth)	(mm)	(m/min)	(mm/tooth)	(mm)

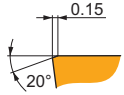

MOT ohne Spanwinkel zur Schlichtbearbeitung.

RDHX 12T3MOT:M4303	✳	–	300	0.20	1.5	–	–	–	285	0.20	1.5	–	–	–	–	–	–	–	–	60	0.14	0.8
RDHX 12T3MOT:M8310	✳	–	300	0.20	1.5	–	–	–	285	0.20	1.5	–	–	–	–	–	–	–	–	60	0.14	0.8
RDHX 12T3MOT:M8325	✳	–	225	0.20	1.5	–	–	–	–	–	–	–	–	–	–	–	–	–	–	–	–	–
RDHX 12T3MOT:M8345	✳	–	200	0.20	1.5	–	–	–	–	–	–	–	–	–	–	–	–	–	–	–	–	–

RDHT 12-FA



	INSD	D1	S
	(mm)	(mm)	(mm)
12T3	12.000	3.90	3.97

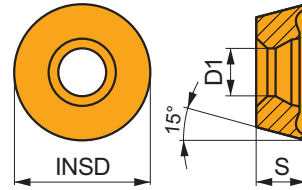

Eignung und Startwerte für Schnittgeschwindigkeit (vc), Vorschub (f) und Schnitttiefe (ap). Weitere Informationen finden Sie in unserer Zerspanungsrechner-App.

Produkt	RE (mm)	P			M			K			N			S			H		
		vc (m/min)	f (mm/tooth)	ap (mm)	vc (m/min)	f (mm/tooth)	ap (mm)	vc (m/min)	f (mm/tooth)	ap (mm)	vc (m/min)	f (mm/tooth)	ap (mm)	vc (m/min)	f (mm/tooth)	ap (mm)	vc (m/min)	f (mm/tooth)	ap (mm)

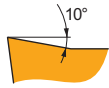
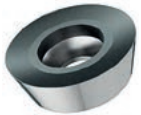

FA geometrie mit hoch positiven Design zur feinen Schlichtbearbeitung bis zur mittleren Bearbeitung.

RDHT 12T3M0-FA:HF7	●	-	-	-	-	-	-	-	-	-	■	360	0.24	1.5	-	-	-	-	-
---------------------------	---	---	---	---	---	---	---	---	---	---	---	-----	------	-----	---	---	---	---	---



a_e / DCX	5 %	10 %	15 %	20 %	25 %	30 %	40 %	50 %	60 %	70 %	75 %	80 %	90 %	100 %
	1.48	1.35	1.27	1.22	1.19	1.16	1.11	1.08	1.05	1.03	1.00	1.00	1.00	1.00
	2.20	1.60	1.35	1.20	1.10	0.95	0.85	0.75	0.85	0.95	1.00	1.00	1.00	1.00
	0.64	0.64	0.64	0.64	0.64	0.65	0.65	0.67	0.68	0.71	0.72	0.74	0.79	1.00

	RDHX 12	RDMX 12	RDGT 12	RDHT 12-FA	RDMT 12
	6.0	6.0	6.0	6.0	6.0
	-	-	-	-	-

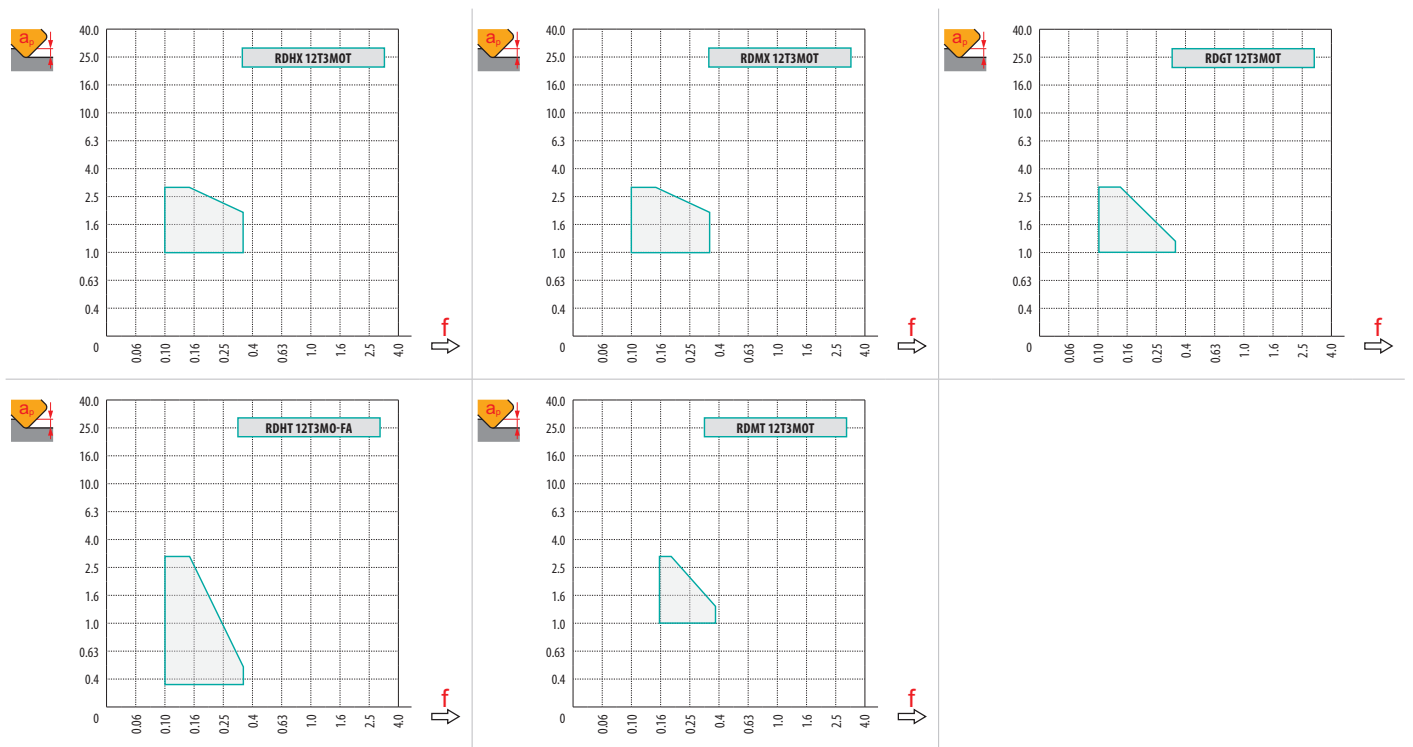

		0.00	0.50	0.75	1.00	1.25	1.50	2.00	2.50	3.00	3.50	4.00	5.00	6.00
24		12.0	16.8	17.8	18.6	19.3	19.9	20.9	21.7	22.4	22.9	23.3	23.8	24.0
35		23.0	27.8	28.8	29.6	30.3	30.9	31.9	32.7	33.4	33.9	34.3	34.8	35.0
42		30.0	34.8	35.8	36.6	37.3	37.9	38.9	39.7	40.4	40.9	41.3	41.8	42.0
50		38.0	42.8	43.8	44.6	45.3	45.9	46.9	47.7	48.4	48.9	49.3	49.8	50.0
52		40.0	44.8	45.8	46.6	47.3	47.9	48.9	49.7	50.4	50.9	51.3	51.8	52.0
66		54.0	58.8	59.8	60.6	61.3	61.9	62.9	63.7	64.4	64.9	65.3	65.8	66.0
80	68.0	72.8	73.8	74.6	75.3	75.9	76.9	77.7	78.4	78.9	79.3	79.8	80.0	
		0.00	0.50	0.75	1.00	1.25	1.50	2.00	2.50	3.00	3.50	4.00	5.00	6.00
		-	0.49	0.40	0.35	0.32	0.29	0.25	0.23	0.21	0.20	0.18	0.17	0.16

	RPMX	APMX/I
24	25.0	3.0/14
35	9.0	3.0/39
42	8.0	3.0/44
50	4.0	3.0/87
52	4.0	3.0/87
66	3.0	3.0/100
80	2.2	3.0/100

	DMIN	DMAX		
			DMIN	DMAX
24	26.0	48.0	3.0	3.0
35	46.0	70.0	3.0	3.0
42	62.0	84.0	3.0	3.0
50	78.0	100.0	2.8	2.8
52	82.0	104.0	2.8	2.8
66	110.0	132.0	2.8	2.8
80	136.0	160.0	2.8	2.8

2.8

		3	5	10	15	20	30	40	50	60	80	100
24		0.537	0.693	0.980	1.200	1.386	1.697	1.960	2.191	2.400	2.771	3.098
35		0.648	0.837	1.183	1.449	1.673	2.049	2.366	2.646	2.898	3.347	3.742
42		0.710	0.917	1.296	1.587	1.833	2.245	2.592	2.898	3.175	3.666	4.099
50		0.775	1.000	1.414	1.732	2.000	2.449	2.828	3.162	3.464	4.000	4.472
52		0.790	1.020	1.442	1.766	2.040	2.498	2.884	3.225	3.533	4.079	4.561
66		0.890	1.149	1.625	1.990	2.298	2.814	3.250	3.633	3.980	4.596	5.138
80		0.980	1.265	1.789	2.191	2.530	3.098	3.578	4.000	4.382	5.060	5.657
		3	5	10	15	20	30	40	50	60	80	100
6.0		0.379	0.490	0.693	0.849	0.980	1.200	1.386	1.549	1.697	1.960	2.191

SRD16

P M K N S H

PRAMET

(S)(C)



Kopierfräser für runde RD.. 16 Wendeschneidplatten mit Innenkühlung

Fräser zum Kopierfräsen mit positivem RD.. 16 Wendeschneidplatten mit APMX von 4 mm. Innenkühlung. Geeignet fürs Planfräsen, helikale Interpolation, Rampen, progressives Eintauchen und Kopierfräsen. Erhältlich als modularer Fräser und Aufsteckfräser. Für längere Standzeiten ist der Körper oberflächenbehandelt.

APMX	4.0 mm
------	--------

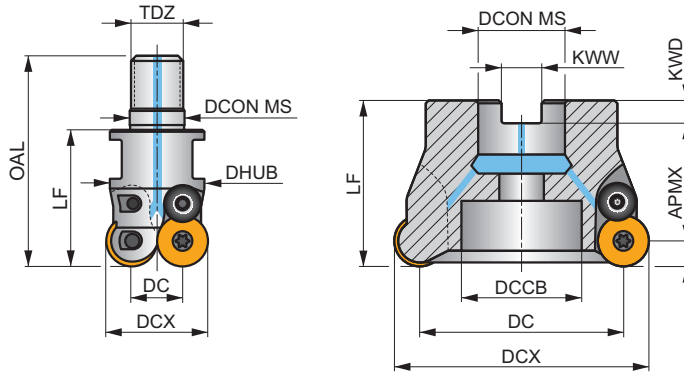
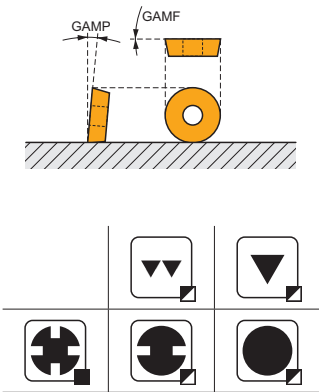

	0.11 - 0.25					
	0.1 - 0.2					

Produkt	DCX	DC	OAL	DCON MS	DHUB	DCCB	LF	TDZ	KWW	KWD	GAMF	GAMP							
	(mm)	(mm)	(mm)	(mm)	(mm)	(mm)	(mm)	(mm)	(mm)	(mm)	(°)	(°)							
32E2R042M16-SCRD16-CF	32	16	65	17	29	-	42	M16	-	-	-2	0	2	-	12600	✓	0.18	GI121	C0374
52A04R-SCMORD16-CF	52	36	-	22	-	16.5	50	-	10.4	10.4	0	7	4	-	9900	✓	0.41	GI121	C0376
66A05R-SCMORD16-CF	66	50	-	27	-	22	50	-	12.4	12.4	0	7	5	-	8800	✓	0.60	GI121	C0378
80A06R-SCMORD16-CF	80	64	-	27	-	38	52	-	12.4	12.4	0	7	6	-	8000	✓	0.87	GI121	C0380
100A07R-SCMORD16-CF	100	84	-	32	-	45	52	-	14.4	14.4	0	7	7	-	7100	✓	1.41	GI121	C0380

GI121	RD.. 1604MOT	RDHT 1604MO-FA

C0374	US 64510-T20P	4.5	M 4.5	10	-	Flag T20P	CS16P	-
C0376	US 64510-T20P	4.5	M 4.5	10	SDR T20P-T	-	CS16P	HS 1030C
C0378	US 64510-T20P	4.5	M 4.5	10	SDR T20P-T	-	CS16P	HS 1230C
C0380	US 64510-T20P	4.5	M 4.5	10	SDR T20P-T	-	CS16P	-

RDGT 16



	INSD	D1	S
	(mm)	(mm)	(mm)
1604	16.000	5.20	4.76

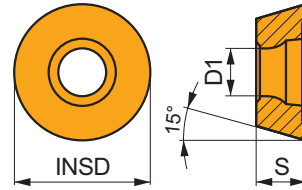

Eignung und Startwerte für Schnittgeschwindigkeit (vc), Vorschub (f) und Schnitttiefe (ap). Weitere Informationen finden Sie in unserer Zerspanungsrechner-App.

Produkt	RE (mm)	P			M			K			N			S			H		
		vc (m/min)	f (mm/tooth)	ap (mm)	vc (m/min)	f (mm/tooth)	ap (mm)	vc (m/min)	f (mm/tooth)	ap (mm)	vc (m/min)	f (mm/tooth)	ap (mm)	vc (m/min)	f (mm/tooth)	ap (mm)	vc (m/min)	f (mm/tooth)	ap (mm)

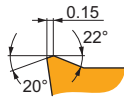

MOT positive Ausführung zum Schlichten.

RDGT 1604MOT:M8310	●	–	285	0.30	2.0	145	0.27	2.0	270	0.30	2.0	–	–	–	–	–	–	–
RDGT 1604MOT:M8325	●	–	220	0.30	2.0	105	0.27	2.0	–	–	–	–	–	–	–	–	–	–
RDGT 1604MOT:M8345	●	–	200	0.30	2.0	120	0.27	2.0	–	–	–	–	–	–	50	0.21	1.6	–

RDMX 16



	INSD	D1	S
	(mm)	(mm)	(mm)
1604	16.000	5.20	4.76

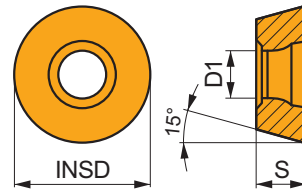

Eignung und Startwerte für Schnittgeschwindigkeit (vc), Vorschub (f) und Schnitttiefe (ap). Weitere Informationen finden Sie in unserer Zerspanungsrechner-App.

Produkt	RE (mm)	P			M			K			N			S			H		
		vc (m/min)	f (mm/tooth)	ap (mm)	vc (m/min)	f (mm/tooth)	ap (mm)	vc (m/min)	f (mm/tooth)	ap (mm)	vc (m/min)	f (mm/tooth)	ap (mm)	vc (m/min)	f (mm/tooth)	ap (mm)	vc (m/min)	f (mm/tooth)	ap (mm)

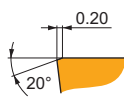
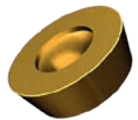

MOT ohne Spanwinkel zur Schlichtbearbeitung.

RDMX 1604MOT:M8310	●	–	255	0.30	2.0	–	–	–	240	0.30	2.0	–	–	–	–	–	–	50	0.15	1.1
---------------------------	---	---	-----	------	-----	---	---	---	-----	------	-----	---	---	---	---	---	---	----	------	-----

RDHX 16



	INSD	D1	S
	(mm)	(mm)	(mm)
1604	16.000	5.20	4.76

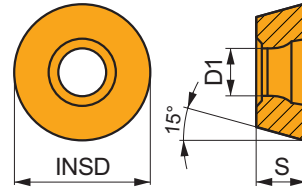

Eignung und Startwerte für Schnittgeschwindigkeit (vc), Vorschub (f) und Schnitttiefe (ap). Weitere Informationen finden Sie in unserer Zerspanungsrechner-App.

Produkt	RE (mm)	P			M			K			N			S			H		
		vc	f	ap	vc	f	ap	vc	f	ap	vc	f	ap	vc	f	ap	vc	f	ap
		(m/min)	(mm/tooth)	(mm)	(m/min)	(mm/tooth)	(mm)	(m/min)	(mm/tooth)	(mm)	(m/min)	(mm/tooth)	(mm)	(m/min)	(mm/tooth)	(mm)	(m/min)	(mm/tooth)	(mm)

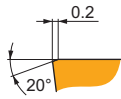

MOT ohne Spanwinkel zur Schlichtbearbeitung.

RDHX 1604MOT:M8310	☼	-	255	0.30	2.0	-	-	-	240	0.30	2.0	-	-	-	-	-	-	50	0.15	1.1
RDHX 1604MOT:M8325	☼	-	195	0.30	2.0	-	-	-	-	-	-	-	-	-	-	-	-	-	-	-
RDHX 1604MOT:M8345	☼	-	180	0.30	2.0	-	-	-	-	-	-	-	-	-	-	-	-	-	-	-
RDHX 1604MOT:M9325	☼	-	290	0.30	2.0	-	-	-	275	0.30	2.0	-	-	-	-	-	-	55	0.15	1.1

RDHT 16-FA



	INSD	D1	S
	(mm)	(mm)	(mm)
1604	16.000	5.20	4.76

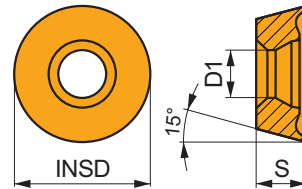

Eignung und Startwerte für Schnittgeschwindigkeit (vc), Vorschub (f) und Schnitttiefe (ap). Weitere Informationen finden Sie in unserer Zerspanungsrechner-App.

Produkt	RE (mm)	P			M			K			N			S			H		
		vc	f	ap	vc	f	ap	vc	f	ap	vc	f	ap	vc	f	ap	vc	f	ap
		(m/min)	(mm/tooth)	(mm)	(m/min)	(mm/tooth)	(mm)	(m/min)	(mm/tooth)	(mm)	(m/min)	(mm/tooth)	(mm)	(m/min)	(mm/tooth)	(mm)	(m/min)	(mm/tooth)	(mm)

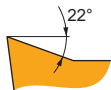

FA geometrie mit hoch positiven Design zur feinen Schlichtbearbeitung bis zur mittleren Bearbeitung.

RDHT 1604MO-FA:HF7	●	-	-	-	-	-	-	-	315	0.36	2.0	-	-	-	-	-	-	-	-	-
--------------------	---	---	---	---	---	---	---	---	-----	------	-----	---	---	---	---	---	---	---	---	---



a_e / DCX	5 %	10 %	15 %	20 %	25 %	30 %	40 %	50 %	60 %	70 %	75 %	80 %	90 %	100 %
	1.48	1.35	1.27	1.22	1.19	1.16	1.11	1.08	1.05	1.03	1.00	1.00	1.00	1.00
	2.20	1.60	1.35	1.20	1.10	0.95	0.85	0.75	0.85	0.95	1.00	1.00	1.00	1.00
	0.64	0.64	0.64	0.64	0.64	0.65	0.65	0.67	0.68	0.71	0.72	0.74	0.79	1.00

	RDHX 16	RDMX 16	RDGT 16	RDHT 16-FA
	8.0	8.0	8.0	8.0
	-	-	-	-

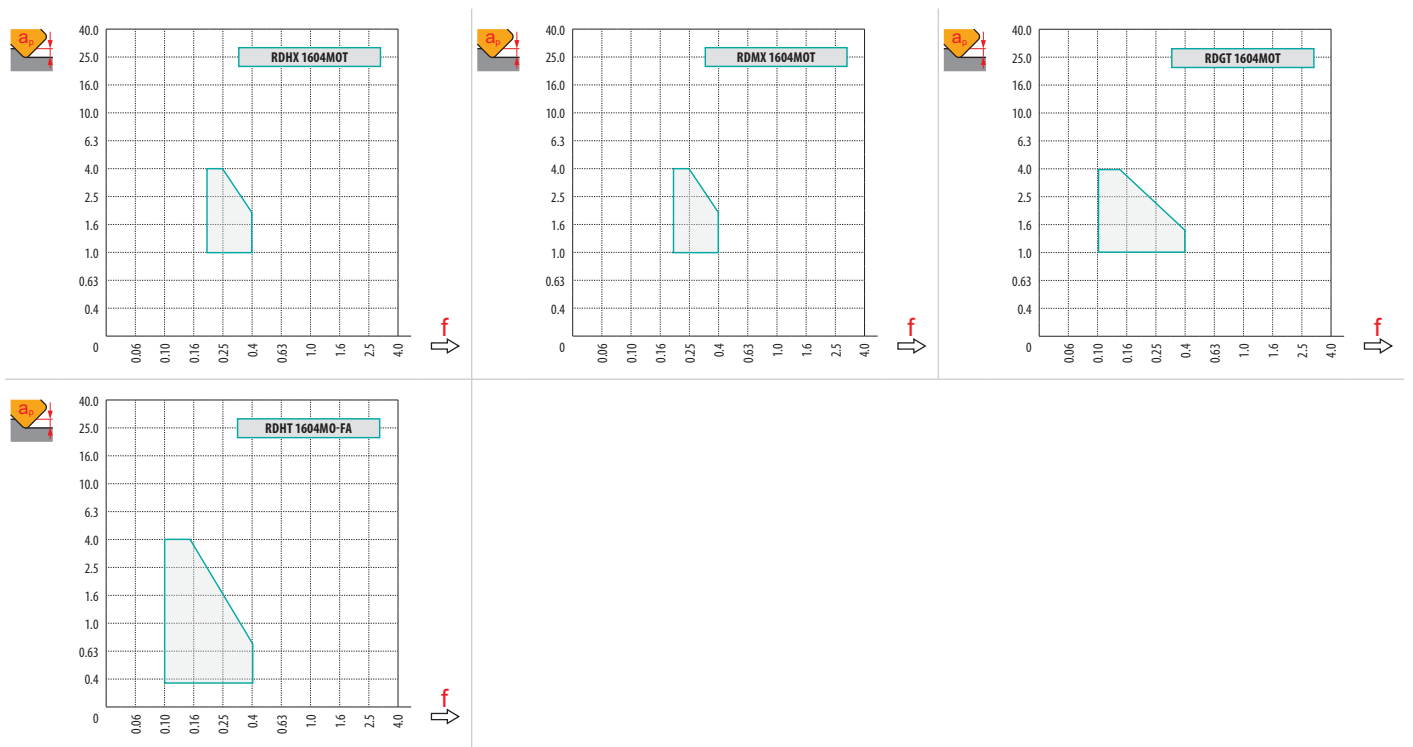

		0.00	0.50	0.75	1.00	1.25	1.50	2.00	2.50	3.00	3.50	4.00	5.00	6.00	7.00	8.00
32		16.0	21.6	22.8	23.7	24.6	25.3	26.6	27.6	28.5	29.2	29.9	30.8	31.5	31.9	32.0
52		36.0	41.6	42.8	43.7	44.6	45.3	46.6	47.6	48.5	49.2	49.9	50.8	51.5	51.9	52.0
66		50.0	55.6	56.8	57.7	58.6	59.3	60.6	61.6	62.5	63.2	63.9	64.8	65.5	65.9	66.0
80		64.0	69.6	70.8	71.7	72.6	73.3	74.6	75.6	76.5	77.2	77.9	78.8	79.5	79.9	80.0
100		84.0	89.6	90.8	91.7	92.6	93.3	94.6	95.6	96.5	97.2	97.9	98.8	99.5	99.9	100.0
		0.00	0.50	0.75	1.00	1.25	1.50	2.00	2.50	3.00	3.50	4.00	5.00	6.00	7.00	8.00
		-	0.91	0.74	0.65	0.58	0.53	0.46	0.42	0.38	0.36	0.34	0.30	0.28	0.26	0.25

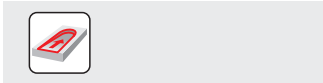

	RPMX	APMX/I
32	25.0	4.0/19
52	8.0	4.0/58
66	6.0	4.0/78
80	4.0	4.0/100
100	3.0	4.0/100

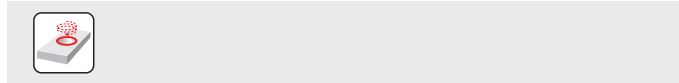

	DMIN	DMAX		
32	34.0	64.0	4.0	4.0
52	74.0	104.0	4.0	4.0
66	102.0	132.0	4.0	4.0
80	130.0	160.0	4.0	4.0
100	170.0	200.0	4.0	4.0

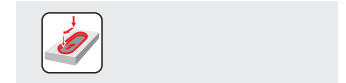



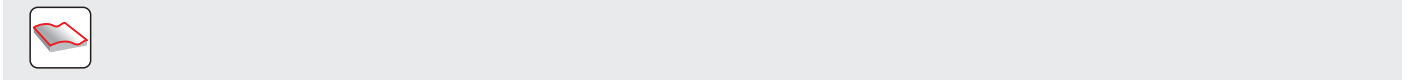











4.0



		3	5	10	15	20	30	40	50	60	80	100
32		0.620	0.800	1.131	1.386	1.600	1.960	2.263	2.530	2.771	3.200	3.578
52		0.790	1.020	1.442	1.766	2.040	2.498	2.884	3.225	3.533	4.079	4.561
66		0.890	1.149	1.625	1.990	2.298	2.814	3.250	3.633	3.980	4.596	5.138
80		0.980	1.265	1.789	2.191	2.530	3.098	3.578	4.000	4.382	5.060	5.657
100		1.095	1.414	2.000	2.449	2.828	3.464	4.000	4.472	4.899	5.657	6.325
		3	5	10	15	20	30	40	50	60	80	100
8.0		0.438	0.566	0.800	0.980	1.131	1.386	1.600	1.789	1.960	2.263	2.530

WENDEPLATTENFRÄSER – AUSWAHLHILFE

PLANFRÄSEN

	SRC10		SRC12		SRC16		SRC20			
	-		-		-		-			
	APMX (mm)	5.0	APMX (mm)	6.0	APMX (mm)	8.0	APMX (mm)	10.0		
	DCX (mm)	25 – 66	DCX (mm)	40 – 100	DCX (mm)	63 – 160	DCX (mm)	80 – 160		
Zylindrischer Schaft										
	DCX = 25, 32 (mm)									
Weldon										
Modular										
	DCX = 25 – 35 (mm)									
Aufsteckfräser										
	DCX = 40 – 66 (mm)									
Seite	186		190		194		198			
ISO	P	M	K	S	H	P	M	K	S	H
Schneidplattenform										
Wendeschneidplatten	RC 10T3		RC 1204		RC 1606		RC 2006			
Anzahl der Schneiden	8		12		8		8			
Konturfräsen (Kopierfräsen)		■	■	■	■	■	■	■		
Planfräsen		■	■	■	■	■	■	■		
Schraubenlinieninterpolation		■	■	■	■	■	■	■		
Progressives Tauchfräsen		■	■	■	■	■	■	■		
Rampen		■	■	■	■	■	■	■		

SRC10



PRAMET



Kopierfräser für runde RCMT 10 Wendeschneidplatten mit Innenkühlung

Fräser zum Kopierfräsen mit positiven RCMT 10-Wendeschneidplatten mit APMX von 5 mm. Innenkühlung. Geeignet fürs Planfräsen, helikale Interpolation, Rampen, progressives Eintauchen und Fräsen mit hohem Vorschub. Erhältlich als Zylinderschaft, modularen Schaft und Aufsteckfräser. Für längere Standzeiten ist der Körper oberflächenbehandelt.

APMX	5.0 mm
------	--------

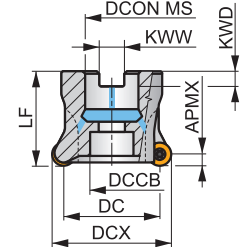
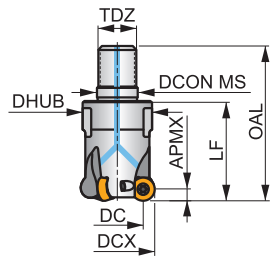
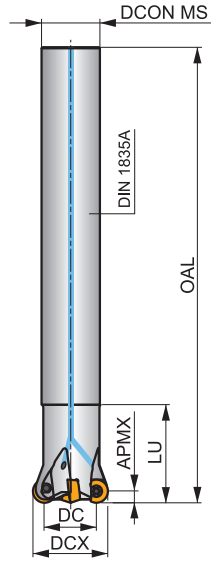
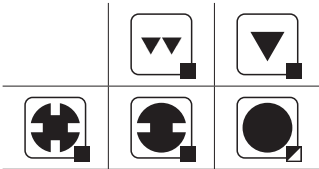
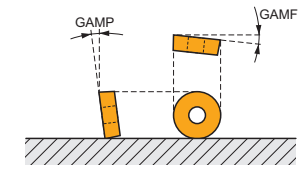

	0.05 - 0.12
	0.08 - 0.15



Produkt	DCX	DC	OAL	DCON MS	DHUB	DCCB	LU	LF	TDZ	KWW	KWD	GAMF	GAMP	max.		kg	C0010 C0012		
	(mm)	(mm)	(mm)	(mm)	(mm)	(mm)	(mm)	(mm)	(mm)	(mm)	(mm)	(°)	(°)						
25E2R034A20-SRC10-C	25	15	170	20	-	-	34	-	-	-	-	-3	-7	2	-	20900	✓	0.40	GI328 C0010
25E3R034A20-SRC10-C	25	15	170	20	-	-	34	-	-	-	-	-3	-7	3	-	20900	✓	0.36	GI328 C0010
32E3R042A25-SRC10-C	32	22	200	25	-	-	42	-	-	-	-	-2.6	-7	4	-	18500	✓	0.67	GI328 C0010
32E4R042A25-SRC10-C	32	22	200	25	-	-	42	-	-	-	-	-2.6	-7	3	-	18500	✓	0.70	GI328 C0010
25E2R032M12-SRC10-C	25	15	54	12.5	21	-	-	32	M12	-	-	-3	-7	2	-	20900	✓	0.11	GI328 C0010
25E3R032M12-SRC10-C	25	15	54	12.5	21	-	-	32	M12	-	-	-3	-7	3	-	20900	✓	0.08	GI328 C0010
32E4R042M16-SRC10-C	32	22	65	17	29	-	-	42	M16	-	-	-2.6	-7	4	-	18500	✓	0.20	GI328 C0010
35E4R042M16-SRC10-C	35	25	65	17	29	-	-	42	M16	-	-	-2.4	-7	4	-	17700	✓	0.20	GI328 C0010
40A05R-SMORC10-C	40	30	-	16	-	14	-	40	-	8.4	5.6	-2.2	-7	5	-	16500	✓	0.21	GI328 C0012
50A05R-SMORC10-C	50	40	-	22	-	18	-	40	-	10.4	6.3	-2	-7	5	-	14800	✓	0.34	GI328 C0013
50A06R-SMORC10-C	50	40	-	22	-	18	-	40	-	10.4	6.3	-2	-7	6	-	14800	✓	0.33	GI328 C0013
52A05R-SMORC10-C	52	42	-	22	-	18	-	40	-	10.4	6.3	-2	-7	5	-	14500	✓	0.35	GI328 C0013
52A06R-SMORC10-C	52	42	-	22	-	18	-	40	-	10.4	6.3	-2	-7	6	-	14500	✓	0.28	GI328 C0013
63A06R-SMORC10-C	63	53	-	22	-	18	-	40	-	10.4	6.3	-1.8	-7	6	-	13200	✓	0.52	GI328 C0013
63A07R-SMORC10-C	63	53	-	22	-	18	-	40	-	10.4	6.3	-1.8	-7	7	-	13200	✓	0.52	GI328 C0013
66A06R-SMORC10-C	66	56	-	27	-	22	-	50	-	12.4	7	-1.4	-7	6	-	12800	✓	0.58	GI328 C0014
66A07R-SMORC10-C	66	56	-	27	-	22	-	50	-	12.4	7	-1.4	-7	7	-	12800	✓	0.60	GI328 C0014

GI328	RCMT 10T3M0..
-------	---------------

C0010	US 63509-T10P	3.0	M 3.5	9	Flag T10P	-
C0012	US 63509-T10P	3.0	M 3.5	9	Flag T10P	HS 0830C

C0013	US 63509-T10P	3.0	M 3.5	9	Flag T10P	HS 1030C
C0014	US 63509-T10P	3.0	M 3.5	9	Flag T10P	HS 1230C

RCMT 10



	INSD	D1	S
	(mm)	(mm)	(mm)
10T3	10.000	3.90	3.97

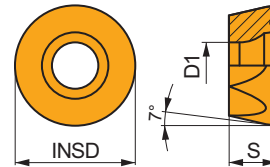

Eignung und Startwerte für Schnittgeschwindigkeit (vc), Vorschub (f) und Schnitttiefe (ap). Weitere Informationen finden Sie in unserer Zerspanungsrechner-App.

Produkt	RE (mm)	P			M			K			N			S			H		
		vc (m/min)	f (mm/tooth)	ap (mm)	vc (m/min)	f (mm/tooth)	ap (mm)	vc (m/min)	f (mm/tooth)	ap (mm)	vc (m/min)	f (mm/tooth)	ap (mm)	vc (m/min)	f (mm/tooth)	ap (mm)	vc (m/min)	f (mm/tooth)	ap (mm)

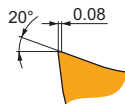

F geometrie mit hoch positiven Design zum Schlichten.

RCMT 10T3MOSN-F:M6330	✱	-	■	340	0.10	1.0	■	240	0.09	1.0	-	-	-	-	-	-	■	100	0.08	0.8	-	-	-
RCMT 10T3MOSN-F:M8330	✱	-	■	395	0.10	1.0	■	235	0.09	1.0	-	-	-	-	-	-	■	95	0.08	0.8	-	-	-

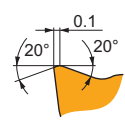

M geometrie mit sehr positiven Design zur mittleren Bearbeitung.

RCMT 10T3MOSN-M:M6330	✱	-	■	310	0.12	1.0	■	220	0.11	1.0	-	-	-	-	-	-	■	90	0.11	0.8	-	-	-	
RCMT 10T3MOSN-M:M8310	✱	-	■	400	0.12	1.0	■	200	0.11	1.0	■	380	0.12	1.0	-	-	-	-	-	-	-	-	-	
RCMT 10T3MOSN-M:M8330	✱	-	■	360	0.12	1.0	■	215	0.11	1.0	■	340	0.12	1.0	-	-	-	■	90	0.11	0.8	-	-	-
RCMT 10T3MOSN-M:M8340	✱	-	■	330	0.12	1.0	■	195	0.11	1.0	■	310	0.12	1.0	-	-	-	■	80	0.11	0.8	-	-	-

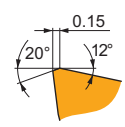

R geometrie mit positiven Design zur Schrappkopierbearbeitung.

RCMT 10T3MOSN-R:M8310	✱	-	■	345	0.17	1.0	-	-	-	-	■	325	0.17	1.0	-	-	-	-	-	-	■	65	0.12	0.7	
RCMT 10T3MOSN-R:M8330	✱	-	■	310	0.17	1.0	-	-	-	-	■	290	0.17	1.0	-	-	-	■	75	0.17	0.8	■	60	0.12	0.7



a_e / DCX	5 %	10 %	15 %	20 %	25 %	30 %	40 %	50 %	60 %	70 %	75 %	80 %	90 %	100 %
	1.48	1.35	1.27	1.22	1.19	1.16	1.11	1.08	1.05	1.03	1.00	1.00	1.00	1.00
	2.20	1.60	1.35	1.20	1.10	0.95	0.85	0.75	0.85	0.95	1.00	1.00	1.00	1.00
	0.64	0.64	0.64	0.64	0.64	0.65	0.65	0.67	0.68	0.71	0.72	0.74	0.79	1.00

	RCMT 10-F	RCMT 10-M	RCMT 10-R
	5.0	5.0	5.0
	—	—	—

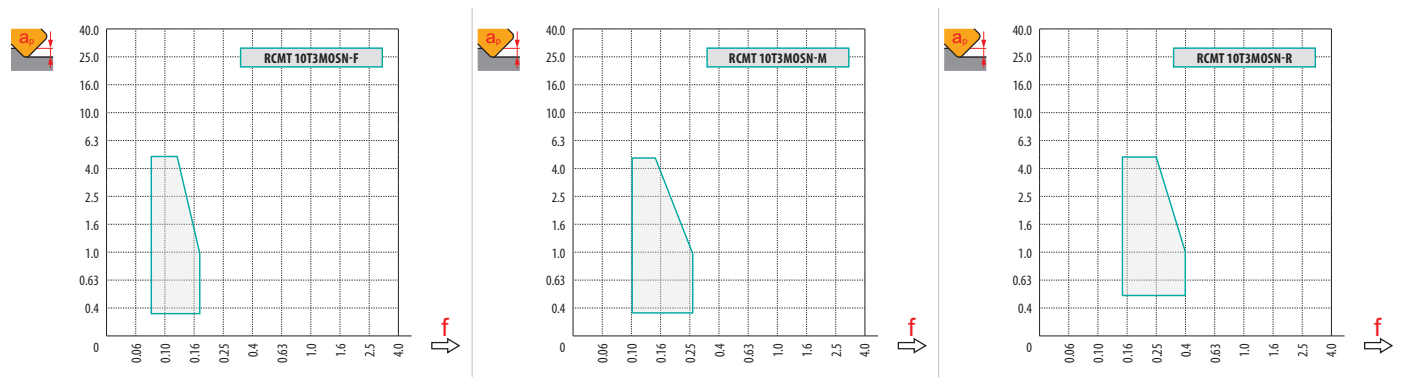

		0.00	0.15	0.30	0.50	0.75	1.00	1.25	1.50	2.00	2.50	3.00	4.00	5.00
25		15.00	17.43	18.41	19.36	20.27	21.00	21.61	22.14	23.00	23.66	24.17	24.80	25.00
32		22.00	24.43	25.41	26.36	27.27	28.00	28.61	29.14	30.00	30.66	31.17	31.80	32.00
35		25.00	27.43	28.41	29.36	30.27	31.00	31.61	32.14	33.00	33.66	34.17	34.80	35.00
40		30.00	32.43	33.41	34.36	35.27	36.00	36.61	37.14	38.00	38.66	39.17	39.80	40.00
50		40.00	42.43	43.41	44.36	45.27	46.00	46.61	47.14	48.00	48.66	49.17	49.80	50.00
52		42.00	44.43	45.41	46.36	47.27	48.00	48.61	49.14	50.00	50.66	51.17	51.80	52.00
63		53.00	55.43	56.41	57.36	58.27	59.00	59.61	60.14	61.00	61.66	62.17	62.80	63.00
66	56.00	58.43	59.41	60.36	61.27	62.00	62.61	63.14	64.00	64.66	65.17	65.80	66.00	
		—	0.15	0.30	0.50	0.75	1.00	1.25	1.50	2.00	2.50	3.00	4.00	5.00
		—	0.90	0.64	0.50	0.41	0.35	0.32	0.29	0.25	0.23	0.21	0.19	0.17

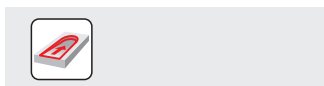

	RPMX	APMX/I
25	13.2	5/23
32	12.6	5/24
35	12.3	5/24
40	9.5	5/31
50	6.4	5/46
52	6.1	5/48
63	4.7	5/62
66	4.4	5/66

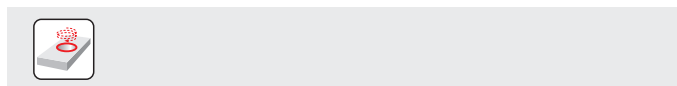

	DMIN	DMAX		
25	32.0	50.0	3.0	3.0
32	45.0	64.0	3.0	3.0
35	51.0	70.0	3.0	3.0
40	61.0	80.0	3.0	3.0
50	81.0	100.0	3.0	3.0
52	85.0	104.0	3.0	3.0
63	107.0	126.0	3.0	3.0
66	113.0	132.0	3.0	3.0

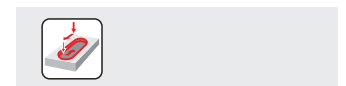

2.24



		3	5	10	15	20	30	40	50	60	80	100
25		0.548	0.707	1.000	1.225	1.414	1.732	2.000	2.236	2.449	2.828	3.162
32		0.620	0.800	1.131	1.386	1.600	1.960	2.263	2.530	2.771	3.200	3.578
35		0.648	0.837	1.183	1.449	1.673	2.049	2.366	2.646	2.898	3.347	3.742
40		0.693	0.894	1.265	1.549	1.789	2.191	2.530	2.828	3.098	3.578	4.000
50		0.775	1.000	1.414	1.732	2.000	2.449	2.828	3.162	3.464	4.000	4.472
52		0.790	1.020	1.442	1.766	2.040	2.498	2.884	3.225	3.533	4.079	4.561
63		0.869	1.122	1.587	1.944	2.245	2.750	3.175	3.550	3.888	4.490	5.020
66	0.890	1.149	1.625	1.990	2.298	2.814	3.250	3.633	3.980	4.596	5.138	
		3	5	10	15	20	30	40	50	60	80	100
5.0		0.346	0.447	0.632	0.775	0.894	1.095	1.265	1.414	1.549	1.789	2.000

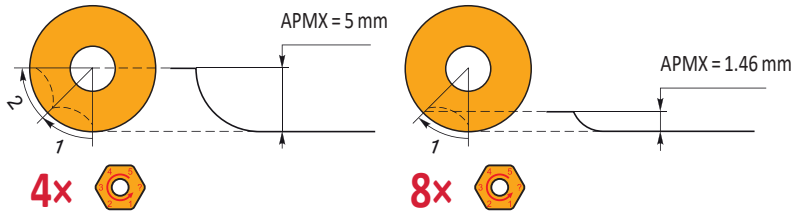

SRC12

P M K S H

PRAMET

S



Kopierfräser für runde RCMT 12 Wendeschneidplatten mit Innenkühlung

Fräser für mittleres Kopierfräsen mit positiver RCMT 12-Wendeschneidplatten mit APMX von 6 mm. Innenkühlung. Geeignet fürs Planfräsen, helikale Interpolation, Rampen, progressives Eintauchen und Fräsen mit hohem Vorschub. Erhältlich als Aufsteckfräser. Für längere Standzeiten ist der Körper oberflächenbehandelt.

APMX	6.0 mm
------	--------

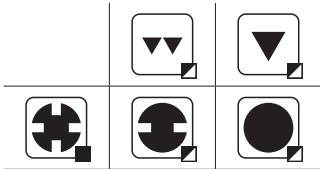
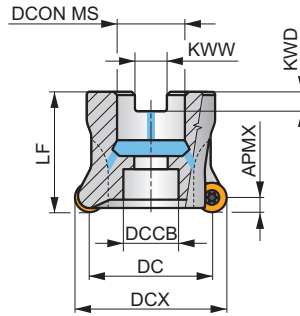
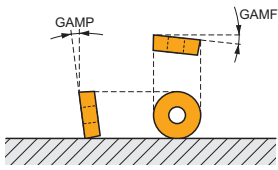

0.1 - 0.2



Produkt	DCX	DC	DCON MS	DCCB	LF	KWW	KWD	GAMF	GAMP								
	(mm)	(mm)	(mm)	(mm)	(mm)	(mm)	(mm)	(°)	(°)								
40A03R-SMORC12-C	40	28	16	12	40	8.4	5.6	-2.1	-7	3	-	14800	✓	0.27	GI279	CO022	-
50A04R-SMORC12-C	50	38	22	18	40	10.4	6.3	-2	-7	4	-	13200	✓	0.36	GI279	CO023	-
52A05R-SMORC12-C	52	40	22	18	40	10.4	6.3	-2	-7	5	-	12900	✓	0.15	GI279	CO023	-
63A05R-SMORC12-C	63	51	22	30	40	10.4	6.3	-2	-7	5	-	11800	✓	0.45	GI279	CO023	-
66A06R-SMORC12-C	66	54	27	22	50	12.4	7	-1.5	-7	6	-	11400	✓	0.65	GI279	CO024	-
80A05R-SMORC12-C	80	68	27	37	50	12.4	7	-1.7	-7	5	-	10400	✓	1.08	GI279	CO024	-
100A06R-SMORC12-C	100	88	32	45	50	14.4	8	-1.8	-7	6	-	9300	✓	1.78	GI279	CO021	AC002

GI279	RCMT 1204M0..

CO021	US 63509-T15P	3.0	M 3.5	10	D-T08P/T15P	FG-15	-
CO022	US 63509-T15P	3.0	M 3.5	10	D-T08P/T15P	FG-15	HS 90835
CO023	US 63509-T15P	3.0	M 3.5	10	D-T08P/T15P	FG-15	HS 1030C
CO024	US 63509-T15P	3.0	M 3.5	10	D-T08P/T15P	FG-15	HS 1230C

AC002	KS 1635	K.FMH32

RCMT 12



	INSD (mm)	D1 (mm)	S (mm)
1204	12.000	4.40	4.76

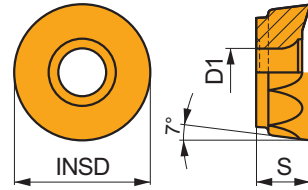

Eignung und Startwerte für Schnittgeschwindigkeit (vc), Vorschub (f) und Schnitttiefe (ap). Weitere Informationen finden Sie in unserer Zerspanungsrechner-App.

Produkt	RE (mm)	P			M			K			N			S			H		
		vc (m/min)	f (mm/tooth)	ap (mm)	vc (m/min)	f (mm/tooth)	ap (mm)	vc (m/min)	f (mm/tooth)	ap (mm)	vc (m/min)	f (mm/tooth)	ap (mm)	vc (m/min)	f (mm/tooth)	ap (mm)	vc (m/min)	f (mm/tooth)	ap (mm)

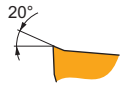

F geometrie mit hoch positiven Design zum Schlichten.

RCMT 1204MOEN-F:M8310	☹	–	■	420	0.10	1.5	▣	210	0.09	1.5	■	–	–	–	–	–	–	–	–	–
RCMT 1204MOEN-F:M8330	☹	–	■	380	0.10	1.5	▣	225	0.09	1.5	■	–	–	–	▣	95	0.07	1.2	–	–

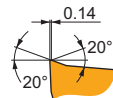

M geometrie mit sehr positiven Design zur mittleren Bearbeitung.

RCMT 1204MOSN-M:M6330	☹	–	■	265	0.20	1.5	▣	185	0.18	1.5	■	–	–	–	■	75	0.16	1.2	–	–
RCMT 1204MOSN-M:M8310	☹	–	■	335	0.20	1.5	▣	170	0.18	1.5	■	315	0.20	1.5	–	–	–	–	–	–
RCMT 1204MOSN-M:M8330	☹	–	■	305	0.20	1.5	▣	180	0.18	1.5	■	285	0.20	1.5	▣	75	0.16	1.2	–	–
RCMT 1204MOSN-M:M8345	☹	–	■	225	0.20	1.5	▣	135	0.18	1.5	■	–	–	–	■	55	0.16	1.2	–	–
RCMT 1204MOSN-M:M9325	☹	–	■	380	0.20	1.5	▣	–	–	–	■	360	0.20	1.5	–	–	–	–	–	–
RCMT 1204MOSN-M:M9340	☹	–	■	345	0.20	1.5	▣	205	0.18	1.5	■	–	–	–	■	85	0.16	1.2	–	–

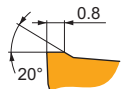

EN-R geometrie mit positiven Design für die Schrupp- und Kopierbearbeitung.

RCMT 1204MOEN-R:M8310	☹	–	■	280	0.30	1.5	▣	140	0.27	1.5	■	265	0.30	1.5	–	–	–	–	■	55	0.15	0.8			
RCMT 1204MOEN-R:M8330	☹	–	■	260	0.30	1.5	▣	155	0.27	1.5	■	245	0.30	1.5	–	–	–	▣	65	0.24	1.2	▣	50	0.15	0.8

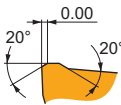

SN-R geometrie mit positiven Design zum Schruppkopierfräsen.

RCMT 1204MOSN-R:M8345	☹	–	■	190	0.35	1.5	▣	–	–	–	■	–	–	–	▣	45	0.25	1.2	–	–		
RCMT 1204MOSN-R:M9315	☹	–	■	315	0.35	1.5	▣	–	–	–	■	295	0.35	1.5	–	–	–	–	▣	60	0.18	0.8



a_e / DCX	5 %	10 %	15 %	20 %	25 %	30 %	40 %	50 %	60 %	70 %	75 %	80 %	90 %	100 %
	1.48	1.35	1.27	1.22	1.19	1.16	1.11	1.08	1.05	1.03	1.00	1.00	1.00	1.00
	2.20	1.60	1.35	1.20	1.10	0.95	0.85	0.75	0.85	0.95	1.00	1.00	1.00	1.00
	0.64	0.64	0.64	0.64	0.64	0.65	0.65	0.67	0.68	0.71	0.72	0.74	0.79	1.00

	RCMT 12-F	RCMT 12-M	RCMT 12 EN-R	RCMT 12 SN-R
	6.0	6.0	6.0	6.0
	-	-	-	-

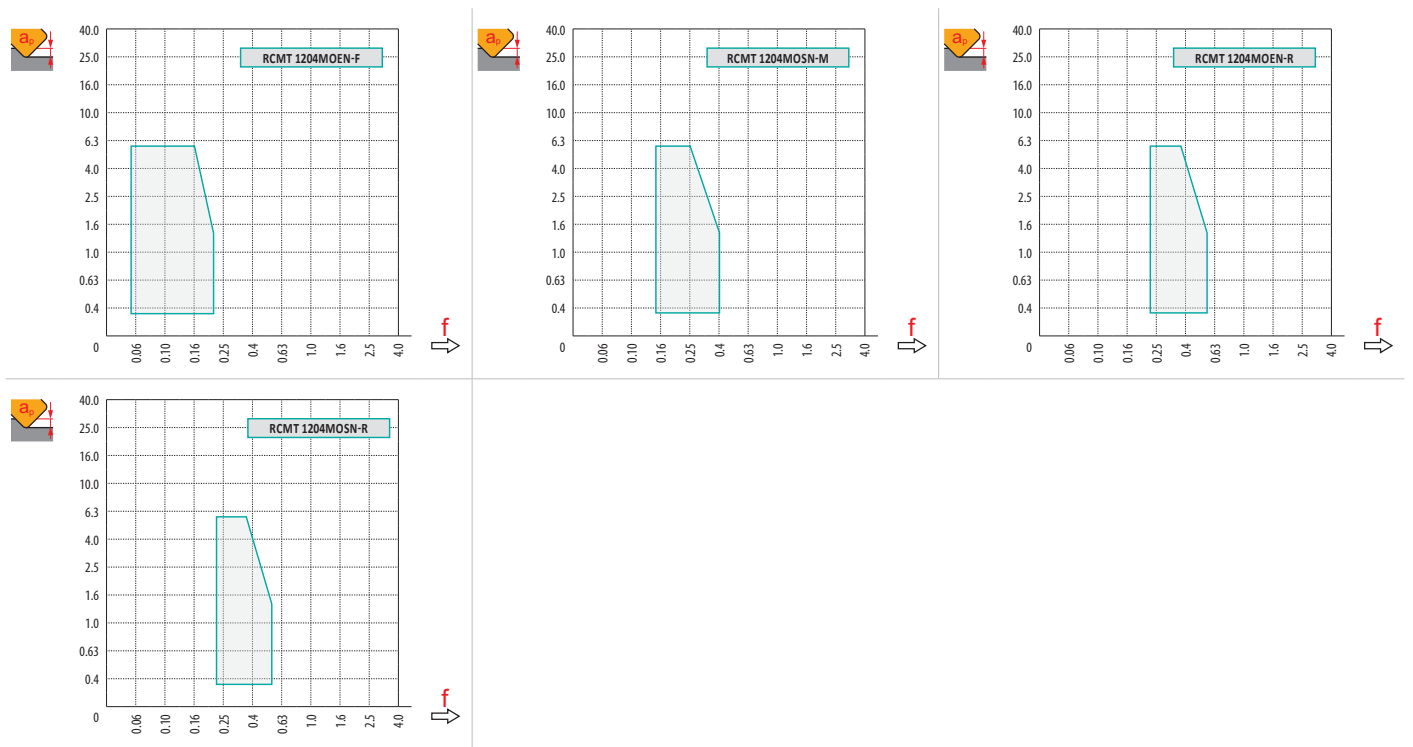

		0.00	0.30	0.50	0.75	1.00	1.25	1.50	2.00	2.50	3.00	4.00	5.00	6.00
40		28.0	31.7	32.8	33.8	34.6	35.3	35.9	36.9	37.7	38.4	39.3	39.8	40.0
50		38.0	41.7	42.8	43.8	44.6	45.3	45.9	46.9	47.7	48.4	49.3	49.8	50.0
52		40.0	43.7	44.8	45.8	46.6	47.3	47.9	48.9	49.7	50.4	51.3	51.8	52.0
63		51.0	54.7	55.8	56.8	57.6	58.3	58.9	59.9	60.7	61.4	62.3	62.8	63.0
66		54.0	57.7	58.8	59.8	60.6	61.3	61.9	62.9	63.7	64.4	65.3	65.8	66.0
80		68.0	71.7	72.8	73.8	74.6	75.3	75.9	76.9	77.7	78.4	79.3	79.8	80.0
100	88.0	91.7	92.8	93.8	94.6	95.3	95.9	96.9	97.7	98.4	99.3	99.8	100.0	
		-	0.30	0.50	0.75	1.00	1.25	1.50	2.00	2.50	3.00	4.00	5.00	6.00
		-	0.95	0.74	0.61	0.53	0.47	0.43	0.38	0.34	0.31	0.28	0.25	0.24

DC	RPMX	APMX/I
40	9.0	6.0/39
50	7.0	6.0/50
52	6.5	6.0/53
63	5.0	6.0/70
66	4.5	6.0/76
80	3.0	5.1/100
100	2.0	3.3/100

DC	DMIN	DMAX	SMAX DMIN	SMAX DMAX
40	56.0	80.0	6.0	6.0
50	76.0	100.0	6.0	6.0
52	80.0	104.0	6.0	6.0
63	102.0	126.0	6.0	6.0
66	108.0	132.0	6.0	6.0
80	136.0	160.0	6.0	6.0
100	176.0	200.0	6.0	6.0

a
3.5

DC	μm	3	5	10	15	20	30	40	50	60	80	100
40		0.693	0.894	1.265	1.549	1.789	2.191	2.530	2.828	3.098	3.578	4.000
50		0.775	1.000	1.414	1.732	2.000	2.449	2.828	3.162	3.464	4.000	4.472
52		0.790	1.020	1.442	1.766	2.040	2.498	2.884	3.225	3.533	4.079	4.561
63		0.869	1.122	1.587	1.944	2.245	2.750	3.175	3.550	3.888	4.490	5.020
66		0.890	1.149	1.625	1.990	2.298	2.814	3.250	3.633	3.980	4.596	5.138
80		0.980	1.265	1.789	2.191	2.530	3.098	3.578	4.000	4.382	5.060	5.657
100		1.095	1.414	2.000	2.449	2.828	3.464	4.000	4.472	4.899	5.657	6.325
RE	μm	3	5	10	15	20	30	40	50	60	80	100
6.0		0.379	0.490	0.693	0.849	0.980	1.200	1.386	1.549	1.697	1.960	2.191

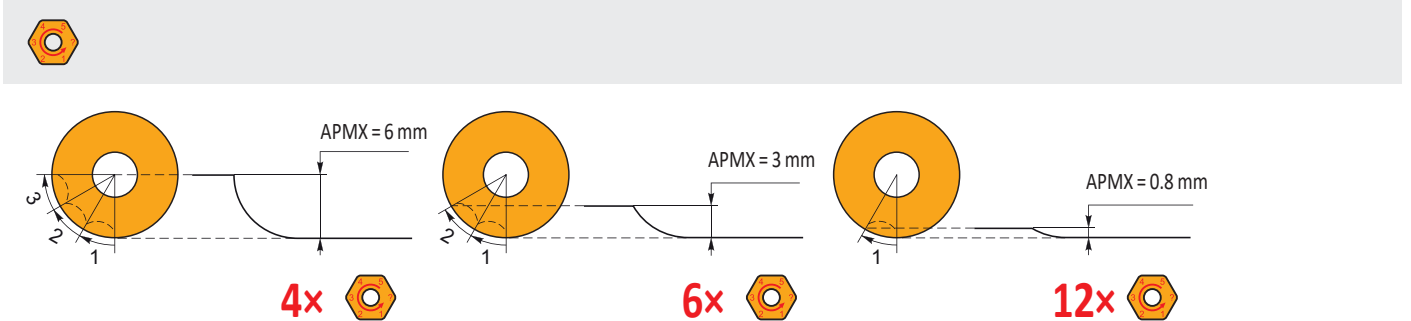

SRC16



PRAMET



Kopierfräser für runde RCMT 16 Wendeschneidplatten mit Innenkühlung

Fräser für mittleres bis schweres Kopierfräsen mit positiven RCMT 16-Wendeschneidplatten mit APMX von 8 mm. Innenkühlung. Geeignet fürs Planfräsen, helikale Interpolation, Rampen, progressives Eintauchen und Fräsen mit hohem Vorschub. Erhältlich als Aufsteckfräser. Für längere Standzeiten ist der Körper oberflächenbehandelt.

APMX	8.0 mm
------	--------

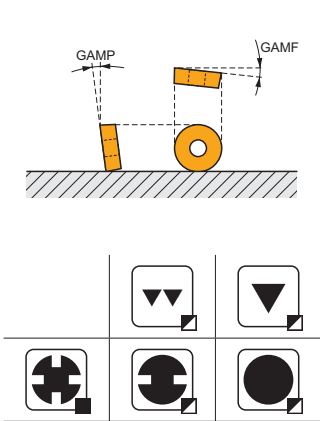

h_{max} 0.1 - 0.25



Produkt	DCX	DC	D CON MS	DCCB	DBC1	LF	KWW	KWD	GAMP	GAMP								
	(mm)	(mm)	(mm)	(mm)	(mm)	(mm)	(mm)	(mm)	(°)	(°)								
63A04R-SMORC16-C	63	47	22	18	-	50	10.4	6.3	-2.6	-7	4	-	9700	✓	0.60	GI280	C0033	-
66A05R-SMORC16-C	66	50	27	22	-	50	12.4	7	-2.5	-7	5	-	9200	✓	0.59	GI280	C0030	-
80A05R-SMORC16-C	80	64	27	37	-	50	12.4	7	-1.7	-7	5	-	8600	✓	0.87	GI280	C0030	-
100A06R-SMORC16-C	100	84	32	45	-	50	14.4	8	-1.7	-7	6	-	7700	✓	1.27	GI280	C0031	AC002
125A07R-SMORC16-C	125	109	40	36	-	63	16.4	9	-1.2	-7	7	-	6500	✓	3.03	GI280	C0032	-
160C08R-SMORC16-C	160	144	40	-	66.7	63	16.4	9	-0.9	-7	8	-	5400	✓	5.63	GI280	C0034	-

	GI280		RCMT 1606M0..
--	-------	--	---------------

C0030	US 65014-T20P	5.0	M 5	14	SDR T20P-T	HS 1230C	-	-	-
C0031	US 65014-T20P	5.0	M 5	14	SDR T20P-T	-	-	-	-
C0032	US 65014-T20P	5.0	M 5	14	SDR T20P-T	HSD 2040	-	-	-
C0033	US 65014-T20P	5.0	M 5	14	SDR T20P-T	HS 1030C	-	-	-
C0034	US 65014-T20P	5.0	M 5	14	SDR T20P-T	HS 1240C	CAC 160C	HSD 0825C	HXK 5

	AC002		KS 1635		K.FMH32
--	-------	--	---------	--	---------

RCMT 16



	INSD	D1	S
	(mm)	(mm)	(mm)
1606	16.000	5.50	6.35

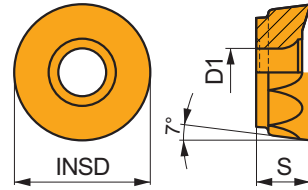

Eignung und Startwerte für Schnittgeschwindigkeit (vc), Vorschub (f) und Schnitttiefe (ap). Weitere Informationen finden Sie in unserer Zerspanungsrechner-App.

Produkt	RE (mm)	P			M			K			N			S			H		
		vc (m/min)	f (mm/tooth)	ap (mm)	vc (m/min)	f (mm/tooth)	ap (mm)	vc (m/min)	f (mm/tooth)	ap (mm)	vc (m/min)	f (mm/tooth)	ap (mm)	vc (m/min)	f (mm/tooth)	ap (mm)	vc (m/min)	f (mm/tooth)	ap (mm)

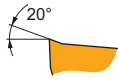

F geometrie mit hoch positiven Design zum Schlichten.

RCMT 1606MOEN-F:M8310	RE	410	0.10	2.0	205	0.09	2.0	-	-	-	-	-	-	-	-	-	-	-
RCMT 1606MOEN-F:M8330	RE	370	0.10	2.0	220	0.09	2.0	-	-	-	-	-	90	0.07	1.6	-	-	-

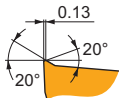

M geometrie mit sehr positiven Design zur mittleren Bearbeitung.

RCMT 1606MOSN-M:M6330	RE	255	0.20	2.0	180	0.18	2.0	-	-	-	-	-	75	0.16	1.6	-	-	-
RCMT 1606MOSN-M:M8330	RE	300	0.20	2.0	180	0.18	2.0	285	0.20	2.0	-	-	75	0.16	1.6	-	-	-
RCMT 1606MOSN-M:M8345	RE	215	0.20	2.0	125	0.18	2.0	-	-	-	-	-	50	0.16	1.6	-	-	-
RCMT 1606MOSN-M:M9325	RE	370	0.20	2.0	-	-	-	350	0.20	2.0	-	-	-	-	-	-	-	-
RCMT 1606MOSN-M:M9340	RE	335	0.20	2.0	200	0.18	2.0	-	-	-	-	-	80	0.16	1.6	-	-	-

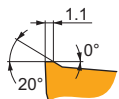

R geometrie mit positiven Design zur Schrappkopierbearbeitung.

RCMT 1606MOSN-R:M8310	RE	250	0.40	2.0	-	-	-	235	0.40	2.0	-	-	-	-	-	-	50	0.20	1.1
RCMT 1606MOSN-R:M8330	RE	240	0.40	2.0	-	-	-	225	0.40	2.0	-	-	60	0.28	1.6	45	0.20	1.1	
RCMT 1606MOSN-R:M8345	RE	175	0.40	2.0	-	-	-	-	-	-	-	-	40	0.28	1.6	-	-	-	



a_e / DCX	5 %	10 %	15 %	20 %	25 %	30 %	40 %	50 %	60 %	70 %	75 %	80 %	90 %	100 %
	1.48	1.35	1.27	1.22	1.19	1.16	1.11	1.08	1.05	1.03	1.00	1.00	1.00	1.00
	2.20	1.60	1.35	1.20	1.10	0.95	0.85	0.75	0.85	0.95	1.00	1.00	1.00	1.00
	0.64	0.64	0.64	0.64	0.64	0.65	0.65	0.67	0.68	0.71	0.72	0.74	0.79	1.00

	RCMT 16-F	RCMT 16-M	RCMT 16-R
	8.0	8.0	8.0
	-	-	-

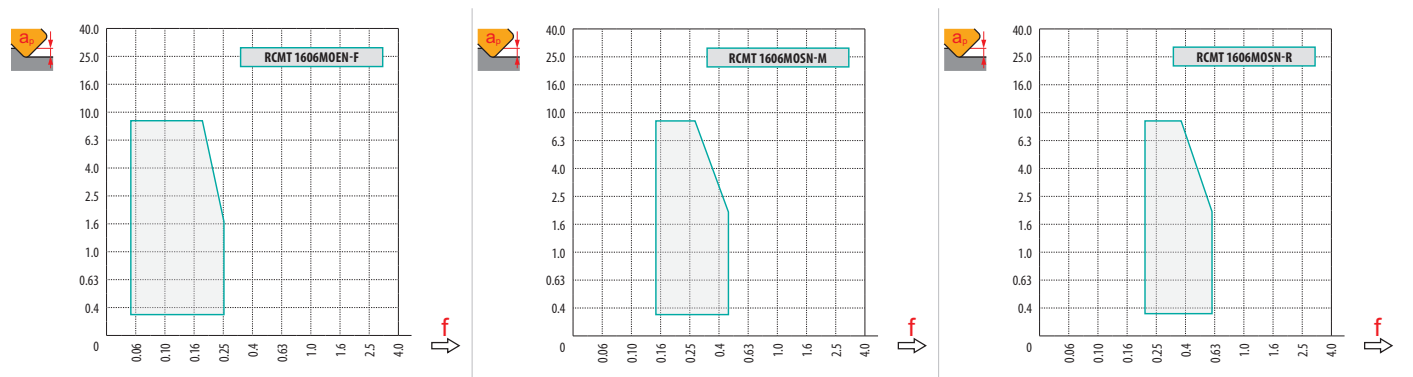

DCX	a_e	0.00	0.30	0.50	0.75	1.00	1.25	1.50	2.00	2.50	3.00	4.00	5.00	6.00	7.00	8.00
63		47.0	51.3	52.6	53.8	54.7	55.6	56.3	57.6	58.6	59.5	60.9	61.8	62.5	62.9	63.0
66		50.0	54.3	55.6	56.8	57.8	58.6	59.3	60.6	61.6	62.5	63.9	64.8	65.5	65.9	66.0
80		64.0	68.3	69.6	70.8	71.7	72.6	73.3	74.6	75.6	76.5	77.9	78.8	79.5	79.9	80.0
100		84.0	88.3	89.6	90.8	91.7	92.6	93.3	94.6	95.6	96.5	97.9	98.8	99.5	99.9	100.0
125		109.0	113.3	114.6	115.8	116.7	117.6	118.3	119.6	120.6	121.5	122.9	123.8	124.5	124.9	125.0
160		144.0	148.3	149.6	150.8	151.7	152.6	153.3	154.6	155.6	156.5	157.9	158.8	159.5	159.9	160.0
	a_e	-	0.30	0.50	0.75	1.00	1.25	1.50	2.00	2.50	3.00	4.00	5.00	6.00	7.00	8.00
		-	1.10	0.85	0.70	0.61	0.54	0.50	0.43	0.39	0.36	0.31	0.28	0.26	0.25	0.24

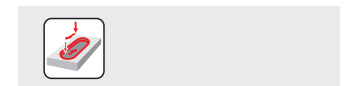
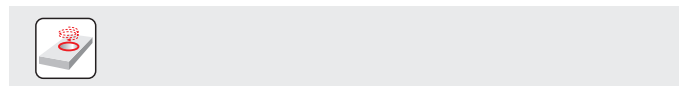
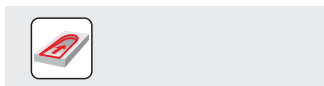

DC	RPMX	APMX/I
63	7.0	8.0/67
66	6.5	8.0/71
80	5.0	8.0/93
100	4.0	6.8/100

DC	DMIN	DMAX	SMAX DMIN	SMAX DMAX
63	94.0	126.0	8.0	8.0
66	100.0	132.0	8.0	8.0
80	128.0	160.0	8.0	8.0
100	168.0	200.0	8.0	8.0

a_e
5.0



	μm	3	5	10	15	20	30	40	50	60	80	100
63		0.869	1.122	1.587	1.944	2.245	2.750	3.175	3.550	3.888	4.490	5.020
66		0.890	1.149	1.625	1.990	2.298	2.814	3.250	3.633	3.980	4.596	5.138
80		0.980	1.265	1.789	2.191	2.530	3.098	3.578	4.000	4.382	5.060	5.657
100		1.095	1.414	2.000	2.449	2.828	3.464	4.000	4.472	4.899	5.657	6.325
125		1.225	1.581	2.236	2.739	3.162	3.873	4.472	5.000	5.477	6.325	7.071
160		1.386	1.789	2.530	3.098	3.578	4.382	5.060	5.657	6.197	7.155	8.000
	μm	3	5	10	15	20	30	40	50	60	80	100
8.0		0.438	0.566	0.800	0.980	1.131	1.386	1.600	1.789	1.960	2.263	2.530

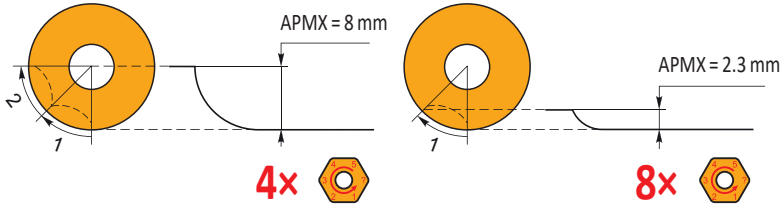

SRC20

P M K S H

PRAMET

S



Kopierfräser für runde RCMT 20 Wendeschneidplatten mit Innenkühlung

Fräser zum schweren Kopierfräsen unter Verwendung positiver RCMT 20-Wendeschneidplatten mit einem APMX von 10 mm. Innenkühlung. Geeignet fürs Planfräsen, helikale Interpolation, Rampen, progressives Eintauchen und Fräsen mit hohem Vorschub. Erhältlich als Aufsteckfräser. Für längere Standzeiten ist der Körper oberflächenbehandelt.

APMX	10.0 mm
------	---------

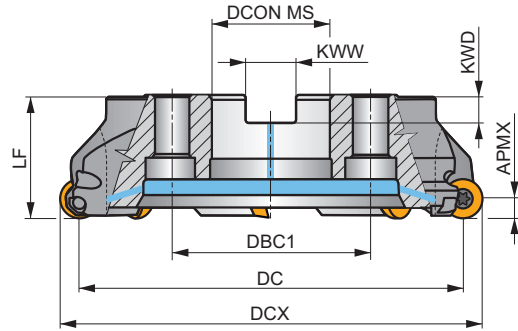
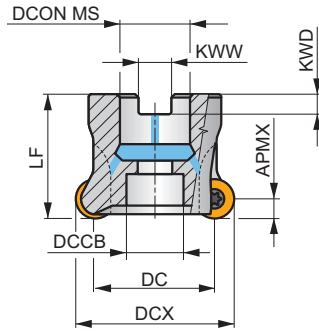
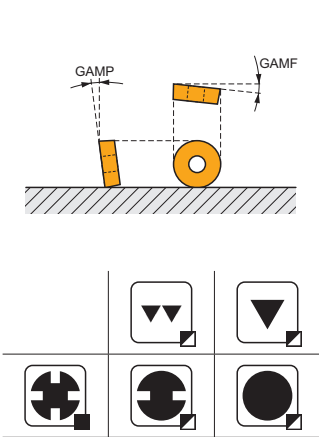

0.11 - 0.32



Produkt	DCX	DC	D CON MS	DCCB	DBC1	Lf	KWW	KWD	GAMP	GAMP								
	(mm)	(mm)	(mm)	(mm)	(mm)	(mm)	(mm)	(mm)	(°)	(°)								
80A04R-SMORC20-C	80	60	27	28	-	50	12.4	7	-2.7	-7	4	-	8500	✓	0.91	G1281	C0040	-
100A05R-SMORC20-C	100	80	32	45	-	50	14.4	8	-1.7	-7	5	-	7600	✓	1.20	G1281	C0041	AC002
125A06R-SMORC20-C	125	105	40	36	-	63	16.4	9	-1	-7	6	-	6500	✓	2.92	G1281	C0042	-
160C07R-SMORC20-C	160	140	40	-	66.7	63	16.4	9	-0.9	-7	7	-	5400	✓	5.37	G1281	C0046	-

G1281	RCMT 2006MO..

C0040	US 66015-T25P	7.5	M 6	15	SDR T25P-T	HS 1230C	-	-	-
C0041	US 66015-T25P	7.5	M 6	15	SDR T25P-T	-	-	-	-
C0042	US 66015-T25P	7.5	M 6	15	SDR T25P-T	HSD 2040	-	-	-
C0046	US 66015-T25P	7.5	M 6	15	SDR T25P-T	HS 1240C	CAC 160C	HSD 0825C	HXK 5

AC002	KS 1635	K.FMH32

RCMT 20



	INSD (mm)	D1 (mm)	S (mm)
2006	20.000	6.50	6.35

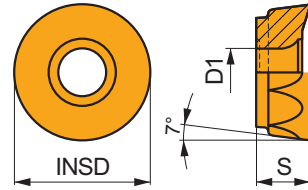

Eignung und Startwerte für Schnittgeschwindigkeit (vc), Vorschub (f) und Schnitttiefe (ap). Weitere Informationen finden Sie in unserer Zerspanungsrechner-App.

Produkt	RE (mm)	P			M			K			N			S			H		
		vc (m/min)	f (mm/tooth)	ap (mm)	vc (m/min)	f (mm/tooth)	ap (mm)	vc (m/min)	f (mm/tooth)	ap (mm)	vc (m/min)	f (mm/tooth)	ap (mm)	vc (m/min)	f (mm/tooth)	ap (mm)	vc (m/min)	f (mm/tooth)	ap (mm)

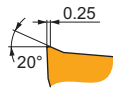

F geometrie mit hoch positiven Design zum Schlichten.

RCMT 2006MOSN-F:M8330	☉	-	320	0.15	3.0	190	0.14	3.0	-	-	-	-	-	-	80	0.11	2.4	-	-	-
------------------------------	---	---	-----	------	-----	-----	------	-----	---	---	---	---	---	---	----	------	-----	---	---	---

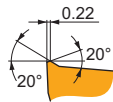

M geometrie mit sehr positiven Design zur mittleren Bearbeitung.

RCMT 2006MOSN-M:M6330	☼	-	225	0.30	3.0	155	0.27	3.0	-	-	-	-	-	-	65	0.21	2.4	-	-	-
RCMT 2006MOSN-M:M8330	☼	-	255	0.30	3.0	150	0.27	3.0	240	0.30	3.0	-	-	-	60	0.21	2.4	-	-	-
RCMT 2006MOSN-M:M8345	☼	-	190	0.30	3.0	110	0.27	3.0	-	-	-	-	-	-	45	0.21	2.4	-	-	-
RCMT 2006MOSN-M:M9315	☼	-	330	0.30	3.0	-	-	-	310	0.30	3.0	-	-	-	-	-	-	-	-	-
RCMT 2006MOSN-M:M9325	☼	-	315	0.30	3.0	-	-	-	295	0.30	3.0	-	-	-	-	-	-	-	-	-
RCMT 2006MOSN-M:M9340	☼	-	275	0.30	3.0	165	0.27	3.0	-	-	-	-	-	-	65	0.21	2.4	-	-	-

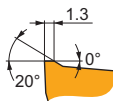

R geometrie mit positiven Design zur Schrappkopierbearbeitung.

RCMT 2006MOSN-R:M8330	☼	-	225	0.45	3.0	-	-	-	210	0.45	3.0	-	-	-	55	0.32	2.4	45	0.23	1.3
RCMT 2006MOSN-R:M8345	☼	-	165	0.45	3.0	-	-	-	-	-	-	-	-	-	40	0.32	2.4	-	-	-
RCMT 2006MOSN-R:M9325	☼	-	260	0.45	3.0	-	-	-	245	0.45	3.0	-	-	-	-	-	-	50	0.23	1.3



a_e / DCX	5 %	10 %	15 %	20 %	25 %	30 %	40 %	50 %	60 %	70 %	75 %	80 %	90 %	100 %
	1.48	1.35	1.27	1.22	1.19	1.16	1.11	1.08	1.05	1.03	1.00	1.00	1.00	1.00
	2.20	1.60	1.35	1.20	1.10	0.95	0.85	0.75	0.85	0.95	1.00	1.00	1.00	1.00
	0.64	0.64	0.64	0.64	0.64	0.65	0.65	0.67	0.68	0.71	0.72	0.74	0.79	1.00

	RCMT 20-F	RCMT 20-M	RCMT 20-R
	10.0	10.0	10.0
	-	-	-

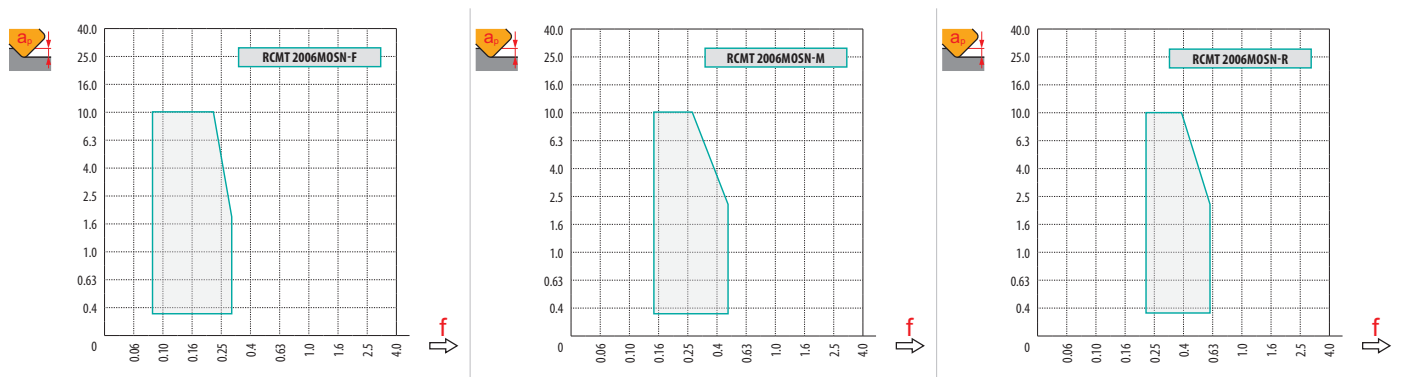

DCX	a_e	0.00	0.30	0.50	0.75	1.00	1.25	1.50	2.00	2.50	3.00	4.00	5.00	6.00	7.00	8.00	9.00	10.00
80		60.0	64.9	66.2	67.6	68.7	69.7	70.5	72.0	73.2	74.3	76.0	77.3	78.3	79.1	79.6	79.9	80.0
100		80.0	84.9	86.2	87.6	88.7	89.7	90.5	92.0	93.2	94.3	96.0	97.3	98.3	99.1	99.6	99.9	100.0
125		105.0	109.9	111.2	112.6	113.7	114.7	115.5	117.0	118.2	119.3	121.0	122.3	123.3	124.1	124.6	124.9	125.0
160		140.0	144.9	146.2	147.6	148.7	149.7	150.5	152.0	153.2	154.3	156.0	157.3	158.3	159.1	159.6	159.9	160.0
	a_e	-	0.30	0.50	0.75	1.00	1.25	1.50	2.00	2.50	3.00	4.00	5.00	6.00	7.00	8.00	9.00	10.00
		-	1.23	0.95	0.78	0.68	0.61	0.55	0.48	0.43	0.40	0.35	0.31	0.29	0.27	0.26	0.25	0.24

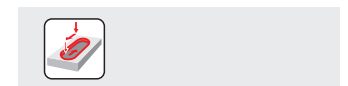
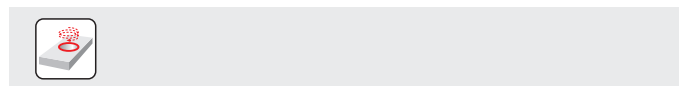
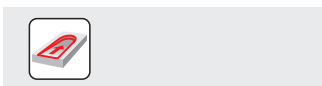

DCX	RPMX	APMX/I
80	7.0	10.0/83
100	5.0	8.6/100

DCX	DMIN	DMAX	SMAX DMIN	SMAX DMAX
80	120.0	160.0	10.0	10.0
100	160.0	200.0	10.0	10.0

a_e
6.0



	μm	3	5	10	15	20	30	40	50	60	80	100
80		0.980	1.265	1.789	2.191	2.530	3.098	3.578	4.000	4.382	5.060	5.657
100		1.095	1.414	2.000	2.449	2.828	3.464	4.000	4.472	4.899	5.657	6.325
125		1.225	1.581	2.236	2.739	3.162	3.873	4.472	5.000	5.477	6.325	7.071
160		1.386	1.789	2.530	3.098	3.578	4.382	5.060	5.657	6.197	7.155	8.000
	μm	3	5	10	15	20	30	40	50	60	80	100
10.0		0.490	0.632	0.894	1.095	1.265	1.549	1.789	2.000	2.191	2.530	2.828

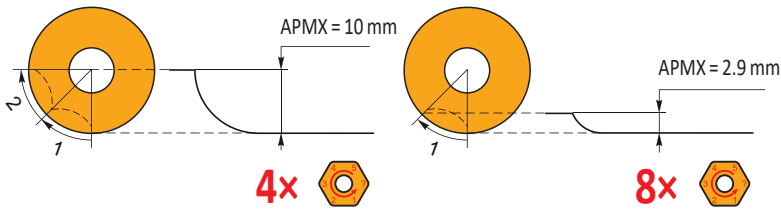



PROFILFRÄSEN

WENDEPLATTENFRÄSER – AUSWAHLHILFE

PLANFRÄSEN

	L2-SZP	K2-SRC	K2-SLC	K2-PPH	K3-CXP	
	-	-	90°	-	-	
	APMX (mm) 8.9 – 44.7	APMX (mm) 0.6 – 3.2	APMX (mm) 1.0 – 3.0	APMX (mm) 0.3 – 4.0	APMX (mm) 8.0 – 16.0	
	DCX (mm) 10 – 50	DCX (mm) 8 – 32	DCX (mm) 12 – 20	DCX (mm) 8 – 32	DCX (mm) 16 – 32	
Zylindrischer Schaft	DCX = 10 – 32 (mm)	DCX = 8 – 32 (mm)		DCX = 8 – 32 (mm)	DCX = 16 – 32 (mm)	
Weldon	DCX = 12 – 50 (mm)				DCX = 16 – 25 (mm)	
Modular	DCX = 10 – 32 (mm)	DCX = 8 – 20 (mm)		DCX = 16, 20 (mm)	DCX = 16 – 25 (mm)	
Morse	DCX = 12 – 32 (mm)					
Seite	206	211	218	222	234	
ISO	P M K S H	P M K H	P M K H	P M K S H	P M K S H	
Schneidplattenform						
Wendeschneidplatten	ZP	RC LC	LC	PPH PPHF PPHT	XP	
Anzahl der Schneiden	2	2	2	2	1	
Konturfräsen (Kopierfräsen)	■	■	■	■	■	
Schraubenlinieninterpolation			▣	▣		
Progressives Tauchfräsen			▣	▣		
Rampen			▣	▣		
Fasenfräsen			▣	▣		

L2-SZP



PRAMET



Kugelkopfräser für ZP.. Wendeschneidplatten

Kugelkopfräser mit ZP..-Wendeschneidplatten mit APMX von 8.9 bis 44.7 mm. Geeignet zum Profilfräsen. Erhältlich in zylindrischer, Weldon, Morsekegel und modularer Ausführung. Körper für längere Standzeiten oberflächenbehandelt.

APMX	8.9 - 44.7 mm
------	---------------

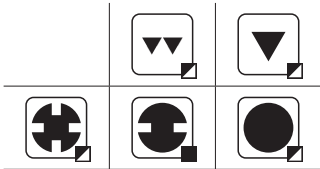
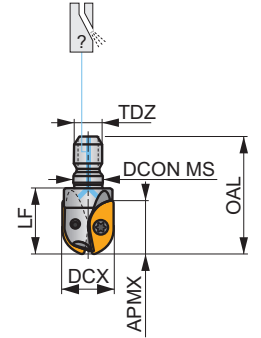
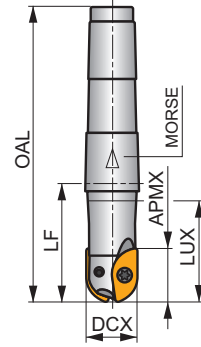
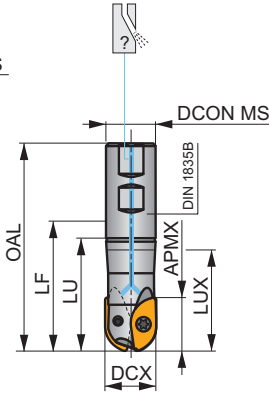
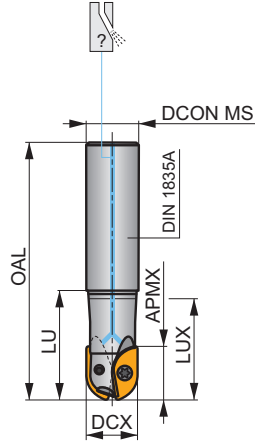
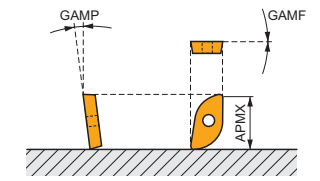

h_m	0.05 - 0.19
-------	-------------



Produkt	DCX	OAL	DCON MS	LU	LUX	LF	TDZ	CZC MS	APMX	GAMF	GAMP						
																	(mm)
10L2R030A10-SZP10	10	130	10	30	30	-	-	-	8.90	0	-10	2	-	35800	-	0.11	GI255 C0510
10L2R050A16-SZP10	10	160	16	50	22.3	-	-	-	8.90	0	-10	2	-	35800	-	0.24	GI255 C0510
12L2R035A12-SZP12	12	140	12	35	35	-	-	-	10.70	0	-10	2	-	21000	-	0.15	GI253 C0510
12L2R045A20-SZP12	12	200	20	-	22	-	-	-	10.70	0	-10	2	-	21000	-	0.48	GI253 C0511
16L2R040A16-SZP16-C	16	160	16	40	40	-	-	-	14.40	0	-10	2	-	20000	✓	0.24	GI256 C0510
16L2R045A20-SZP16-C	16	200	20	-	29.4	-	-	-	14.40	0	-10	2	-	20000	✓	0.43	GI256 C0512
20L2R050A20-SZP20-C	20	250	20	50	-	-	-	-	17.90	0	-10	2	-	24000	✓	0.54	GI254 C0513
20L2R055A25-SZP20-C	20	200	25	-	36.1	-	-	-	17.90	0	-10	2	-	24000	✓	0.68	GI254 C0513
25L2R060A25-SZP25-C	25	250	25	60	-	-	-	-	22.30	0	-10	2	-	24000	✓	0.85	GI257 C0514
25L2R065A32-SZP25-C	25	250	32	-	43	-	-	-	22.30	0	-10	2	-	24000	✓	1.34	GI257 C0514
32L2R070A32-SZP32-C	32	250	32	-	-	-	-	-	28.60	0	-10	2	-	18500	✓	1.43	GI258 C0515
12L2R040B20-SZP12	12	91	20	40	21.5	66.5	-	-	10.70	0	-10	2	-	21000	-	0.19	GI253 C0511
12L2R060B20-SZP12	12	111	20	60	23.8	86.5	-	-	10.70	0	-10	2	-	21000	-	0.22	GI253 C0511
16L2R040B20-SZP16-C	16	91	20	40	28.3	66.5	-	-	14.40	0	-10	2	-	20000	✓	0.15	GI256 C0512
16L2R060B20-SZP16-C	16	111	20	60	32.9	86.5	-	-	14.40	0	-10	2	-	20000	✓	0.21	GI256 C0512
20L2R050B25-SZP20-C	20	107	25	50	35.1	75.5	-	-	17.90	0	-10	2	-	24000	✓	0.30	GI254 C0513
20L2R070B25-SZP20-C	20	127	25	70	39.5	95.5	-	-	17.90	0	-10	2	-	24000	✓	0.36	GI254 C0513
25L2R060B25-SZP25-C	25	117	25	60	-	85.5	-	-	22.30	0	-10	2	-	24000	✓	0.36	GI257 C0514
25L2R080B25-SZP25-C	25	137	25	80	-	105	-	-	22.30	0	-10	2	-	24000	✓	0.42	GI257 C0514
32L2R070B32-SZP32-C	32	131	32	70	-	95.5	-	-	28.60	0	-10	2	-	18500	✓	0.72	GI258 C0515
32L2R100B32-SZP32-C	32	161	32	100	-	125.5	-	-	28.60	0	-10	2	-	18500	✓	0.81	GI258 C0515
40L2R070B32-SZP40-C	40	131	32	70	-	95.5	-	-	35.70	0	-10	2	-	8000	✓	0.81	GI259 C0516
40L2R100B40-SZP40-C	40	171	40	100	-	131	-	-	35.70	0	-10	2	-	8000	✓	1.40	GI259 C0516
50L2R100B50-SZP50-C	50	181	50	100	-	136.5	-	-	44.70	0	-10	2	-	7000	✓	2.25	GI260 C0517
12L2R060E02-SZP12	12	124	-	-	25.8	60	-	2	10.70	0	-10	2	-	21000	-	0.17	GI253 C0511
12L2R090E02-SZP12	12	154	-	-	25.8	90	-	2	10.70	0	-10	2	-	21000	-	0.23	GI253 C0511
16L2R060E02-SZP16	16	124	-	-	42.2	60	-	2	14.40	0	-10	2	-	20000	-	0.19	GI256 C0512

Produkt	DCX	OAL	D CON MS	LU	LUX	LF	TDZ	CZC MS	APMX	GAMIF	GAMP							
	(mm)	(mm)	(mm)	(mm)	(mm)	(mm)			(mm)	(°)	(°)							
16L2R090E02-SZP16	16	154	-	-	75.9	90	-	2	14.40	0	-10	2	-	20000	-	0.23	G1256	C0512
20L2R070E03-SZP20	20	151	-	-	-	70	-	3	17.90	0	-10	2	-	24000	-	0.37	G1254	C0513
20L2R100E03-SZP20	20	181	-	-	77.4	100	-	3	17.90	0	-10	2	-	24000	-	0.42	G1254	C0513
25L2R080E03-SZP25	25	161	-	-	-	80	-	3	22.30	0	-10	2	-	24000	-	0.44	G1257	C0514
25L2R110E04-SZP25	25	213	-	-	92.7	110	-	4	22.30	0	-10	2	-	24000	-	0.83	G1257	C0514
32L2R100E04-SZP32	32	203	-	-	-	100	-	4	28.60	0	-10	2	-	18500	-	0.90	G1258	C0515
32L2R150E04-SZP32	32	253	-	-	-	150	-	4	28.60	0	-10	2	-	18500	-	1.10	G1258	C0515
10L2R025M08-SZP10	10	-	8.5	-	-	25	M8	-	8.90	0	-10	2	-	-	-	0.03	G1255	C0510
12L2R025M06-SZP12	12	-	6.5	-	-	25	M6	-	10.70	0	-10	2	-	-	-	0.05	G1253	C0510
12L2R025M08-SZP12	12	-	8.5	-	-	25	M8	-	10.70	0	-10	2	-	-	-	0.04	G1253	C0511
16L2R025M08-SZP16	16	-	8.5	-	-	25	M8	-	14.40	0	-10	2	-	-	-	0.05	G1256	C0512
20L2R030M10-SZP20-C	20	-	10.5	-	-	30	M10	-	17.90	0	-10	2	-	-	✓	0.07	G1254	C0513
25L2R035M12-SZP25-C	25	-	12.5	-	-	35	M12	-	22.30	0	-10	2	-	-	✓	0.09	G1257	C0514
32L2R045M16-SZP32-C	32	-	17	-	-	45	M16	-	27.90	0	-10	2	-	-	✓	0.15	G1258	C0515

G1253	ZP 12..
G1254	ZP 20..
G1255	ZP 10..
G1256	ZP 16..
G1257	ZP 25..
G1258	ZP 32..
G1259	ZP 40..
G1260	ZP 50..

C0510	-	-	Flag T06P	US 62004-T06P	0.6	M 2	4	-
C0511	-	-	Flag T08P	US 62506-T08P	1.2	M 2.5	6	-
C0512	-	-	Flag T08P	US 62508-T08P	1.2	M 2.5	7	-
C0513	-	-	Flag T10P	US 63510-T10P	2.0	M 3.5	9	-
C0514	-	-	Flag T15P	US 4011A-T15P	3.5	M 4	11	-
C0515	-	-	-	US 65013-T20	5.0	M 5	13	SDR T20
C0516	-	-	-	US 66015-T25P	7.5	M 6	15	SDR T25P
C0517	SZN 400322	US 3508-T15P	Flag T15P	US 68020-T30P	15.0	M 8	20	SDR T30P

ZP



	W1 (mm)	D1 (mm)	S (mm)
10	10.000	2.20	1.70
12	12.000	2.90	2.38
16	16.000	2.90	3.18
20	20.000	4.00	3.97
25	25.000	4.70	4.76
32	32.000	5.90	6.35
40	40.000	7.00	7.94
50	50.000	9.60	7.94

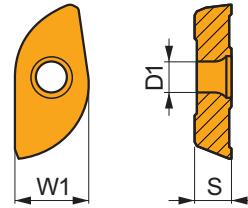

Eignung und Startwerte für Schnittgeschwindigkeit (vc), Vorschub (f) und Schnitttiefe (ap). Weitere Informationen finden Sie in unserer Zerspanungsrechner-App.

Produkt	RE (mm)	P			M			K			N			S			H		
		vc (m/min)	f (mm/tooth)	ap (mm)	vc (m/min)	f (mm/tooth)	ap (mm)	vc (m/min)	f (mm/tooth)	ap (mm)	vc (m/min)	f (mm/tooth)	ap (mm)	vc (m/min)	f (mm/tooth)	ap (mm)	vc (m/min)	f (mm/tooth)	ap (mm)



FM geometrie mit scharfen und neutralen Design zur leichten bis mittleren Bearbeitung.

ZP 10ER-FM:M8310	●	–	■	305	0.36	0.5	■	–	–	–	■	285	0.36	0.5	■	–	–	–	■	60	0.25	0.5
ZP 10ER-FM:M8345	●	–	■	210	0.36	0.5	■	–	–	–	■	–	–	–	■	–	–	–	■	–	–	–
ZP 12ER-FM:M8310	●	–	■	300	0.36	0.6	■	–	–	–	■	285	0.36	0.6	■	–	–	–	■	60	0.25	0.6
ZP 12ER-FM:M8345	●	–	■	205	0.36	0.6	■	–	–	–	■	–	–	–	■	–	–	–	■	–	–	–
ZP 16ER-FM:M8310	●	–	■	290	0.36	0.8	■	–	–	–	■	275	0.36	0.8	■	–	–	–	■	55	0.25	0.8
ZP 20ER-FM:M8310	●	–	■	285	0.36	1.0	■	–	–	–	■	270	0.36	1.0	■	–	–	–	■	55	0.25	1.0
ZP 25ER-FM:M8310	●	–	■	275	0.36	1.3	■	–	–	–	■	260	0.36	1.3	■	–	–	–	■	55	0.25	1.3
ZP 32ER-FM:M8310	●	–	■	270	0.36	1.6	■	–	–	–	■	255	0.36	1.6	■	–	–	–	■	50	0.25	1.6

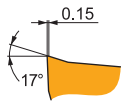

M geometrie mit sehr positiven Design zur mittleren Bearbeitung.

ZP 12ER-M:M8330	●	–	■	280	0.36	0.6	■	165	0.32	0.6	■	265	0.36	0.6	■	–	–	–	■	70	0.25	0.5	■	–	–	–
ZP 12ER-M:M8345	●	–	■	205	0.36	0.6	■	120	0.32	0.6	■	–	–	–	■	–	–	–	■	50	0.25	0.5	■	–	–	–
ZP 16ER-M:M8330	●	–	■	270	0.36	0.8	■	160	0.32	0.8	■	255	0.36	0.8	■	–	–	–	■	65	0.25	0.6	■	–	–	–
ZP 16ER-M:M8340	●	–	■	250	0.36	0.8	■	150	0.32	0.8	■	235	0.36	0.8	■	–	–	–	■	60	0.25	0.6	■	–	–	–
ZP 16ER-M:M8345	●	–	■	200	0.36	0.8	■	120	0.32	0.8	■	–	–	–	■	–	–	–	■	50	0.25	0.6	■	–	–	–
ZP 20ER-M:M8330	●	–	■	265	0.36	1.0	■	155	0.32	1.0	■	250	0.36	1.0	■	–	–	–	■	65	0.25	0.8	■	–	–	–
ZP 20ER-M:M8345	●	–	■	195	0.36	1.0	■	115	0.32	1.0	■	–	–	–	■	–	–	–	■	45	0.25	0.8	■	–	–	–
ZP 25ER-M:M8330	●	–	■	260	0.36	1.3	■	155	0.32	1.3	■	245	0.36	1.3	■	–	–	–	■	65	0.25	1.0	■	–	–	–
ZP 25ER-M:M8345	●	–	■	190	0.36	1.3	■	110	0.32	1.3	■	–	–	–	■	–	–	–	■	45	0.25	1.0	■	–	–	–
ZP 32ER-M:M8330	●	–	■	255	0.36	1.6	■	150	0.32	1.6	■	240	0.36	1.6	■	–	–	–	■	60	0.25	1.3	■	–	–	–

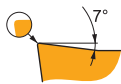

R geometrie mit scharfen leicht positiven Design zur leichten bis mittleren Bearbeitung.

ZP 16ER-R:M8345	●	–	■	190	0.45	0.8	■	110	0.41	0.8	■	–	–	–	■	–	–	–	■	45	0.32	0.8	■	–	–	–
ZP 20ER-R:M8345	●	–	■	185	0.45	1.0	■	110	0.41	1.0	■	–	–	–	■	–	–	–	■	45	0.32	1.0	■	–	–	–
ZP 25ER-R:M8345	●	–	■	180	0.45	1.3	■	105	0.41	1.3	■	–	–	–	■	–	–	–	■	45	0.32	1.3	■	–	–	–
ZP 32ER-R:M8330	●	–	■	240	0.45	1.6	■	140	0.41	1.6	■	225	0.45	1.6	■	–	–	–	■	60	0.32	1.6	■	45	0.32	1.6
ZP 32ER-R:M8345	●	–	■	175	0.45	1.6	■	105	0.41	1.6	■	–	–	–	■	–	–	–	■	40	0.32	1.6	■	–	–	–
ZP 40ER-R:M8345	●	–	■	170	0.45	2.0	■	100	0.41	2.0	■	–	–	–	■	–	–	–	■	40	0.32	2.0	■	–	–	–
ZP 50ER-R:M8345	●	–	■	165	0.45	2.5	■	95	0.41	2.5	■	–	–	–	■	–	–	–	■	40	0.32	2.5	■	–	–	–



a_e / DCX	5 %	10 %	15 %	20 %	25 %	30 %	40 %	50 %	60 %	70 %	75 %	80 %	90 %	100 %
	1.48	1.35	1.27	1.22	1.19	1.16	1.11	1.08	1.05	1.03	1.00	1.00	1.00	1.00
	2.20	1.60	1.35	1.20	1.10	0.95	0.85	0.75	0.85	0.95	1.00	1.00	1.00	1.00
	0.64	0.64	0.64	0.64	0.64	0.65	0.65	0.67	0.68	0.71	0.72	0.74	0.79	1.00

	ZP 10-FM	ZP 12-FM	ZP 16-FM	ZP 20-FM	ZP 25-FM	ZP 32-FM
	5.0	6.0	8.0	10.0	12.5	16.0
	-	-	-	-	-	-

	ZP 12-M	ZP 16-M	ZP 20-M	ZP 25-M	ZP 32-M
	6.0	8.0	10.0	12.5	16.0
	-	-	-	-	-

	ZP 16-R	ZP 20-R	ZP 25-R	ZP 32-R	ZP 40-R	ZP 50-R
	8.0	10.0	12.5	16.0	20.0	25.0
	-	-	-	-	-	-

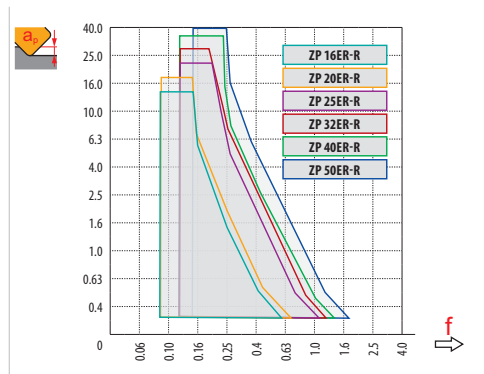
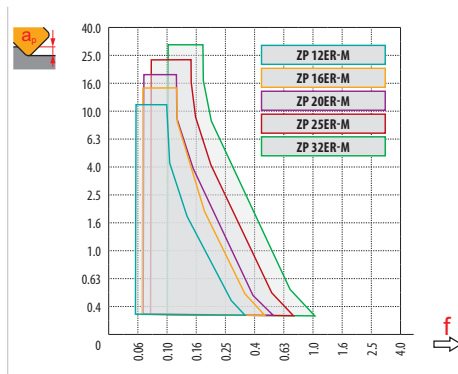
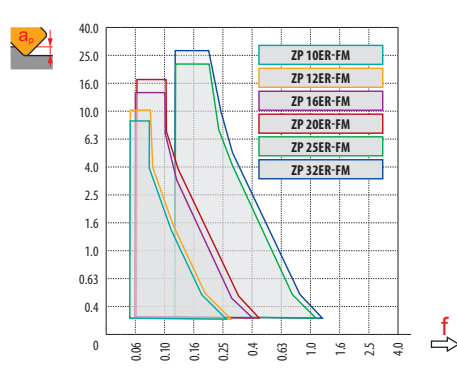

		0.30	0.40	0.50	0.70	1.00	1.25	1.50	2.00	2.50	3.00	4.00	5.00	6.00	8.00	10.00	12.00	15.00	16.00	20.00	22.50	25.00			
10		3.4	3.9	4.4	5.1	6.0	6.6	7.1	8.0	8.7	9.2	9.8	10.0	-	-	-	-	-	-	-	-	-	-		
12		3.7	4.3	4.8	5.6	6.6	7.3	7.9	8.9	9.7	10.4	11.3	11.8	12.0	-	-	-	-	-	-	-	-	-	-	
16		4.3	5.0	5.6	6.5	7.7	8.6	9.3	10.6	11.6	12.5	13.9	14.8	15.5	16.0	-	-	-	-	-	-	-	-	-	-
20		4.9	5.6	6.2	7.4	8.7	9.7	10.5	12.0	13.2	14.3	16.0	17.3	18.3	19.6	20.0	-	-	-	-	-	-	-	-	-
25		5.4	6.3	7.0	8.2	9.8	10.9	11.9	13.6	15.0	16.2	18.3	20.0	21.4	23.3	24.5	25.0	-	-	-	-	-	-	-	-
32		6.2	7.1	7.9	9.4	11.1	12.4	13.5	15.5	17.2	18.7	21.2	23.2	25.0	27.7	29.7	31.2	31.9	32.0	-	-	-	-	-	-
40		6.9	8.0	8.9	10.5	12.5	13.9	15.2	17.4	19.4	21.1	24.0	26.5	28.6	32.0	34.6	37.1	38.7	39.2	40.0	-	-	-	-	-
50	7.7	8.9	9.9	11.7	14.0	15.6	17.1	19.6	21.8	23.7	27.1	30.0	32.5	36.7	40.0	43.3	45.8	46.6	49.0	49.7	50.0	-	-	-	

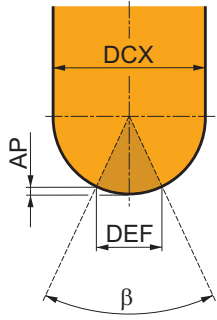

DCX		β	DEF	AP
10	FM	41°	3.496	0.322
12	FM	41°	4.194	0.381
16	FM	42°	5.660	0.520
20	FM	42°	7.100	0.650
25	FM	41°	8.756	0.794
35	FM	41°	11.113	0.998
40	R	41°	14.108	1.298
50	R	45°	19.176	1.915



DCX	μm	3	5	10	15	20	30	40	50	60	80	100
10		0.346	0.447	0.632	0.775	0.894	1.095	1.265	1.414	1.549	1.789	2.000
12		0.379	0.490	0.693	0.849	0.980	1.200	1.386	1.549	1.697	1.960	2.191
16	FE	0.438	0.566	0.800	0.980	1.131	1.386	1.600	1.789	1.960	2.263	2.530
20	FE	0.490	0.632	0.894	1.095	1.265	1.549	1.789	2.000	2.191	2.530	2.828
25		0.548	0.707	1.000	1.225	1.414	1.732	2.000	2.236	2.449	2.828	3.162
32		0.620	0.800	1.131	1.386	1.600	1.960	2.263	2.530	2.771	3.200	3.578
40		0.693	0.894	1.265	1.549	1.789	2.191	2.530	2.828	3.098	3.578	4.000
50		0.775	1.000	1.414	1.732	2.000	2.449	2.828	3.162	3.464	4.000	4.472

DEF	a_e	1%	2.5%	5%	7.5%	10%	15%	20%	25%	30%	35%	40%	45%	50%	60%	70%	75%	80%	90%	100%
19.9%	1.0%	2.86	1.84	1.33	1.12	1.00	0.89	-	-	-	-	-	-	-	-	-	-	-	-	-
31.2%	2.5%	3.58	2.28	1.64	1.36	1.20	1.01	0.92	0.88	0.91	-	-	-	-	-	-	-	-	-	-
43.6%	5.0%	4.22	2.68	1.92	1.58	1.39	1.16	1.03	0.95	0.90	0.88	0.89	-	-	-	-	-	-	-	-
52.7%	7.5%	4.63	2.95	2.10	1.73	1.51	1.26	1.11	1.02	0.96	0.91	0.89	0.88	0.90	-	-	-	-	-	-
60.0%	10.0%	4.94	3.14	2.24	1.84	1.61	1.33	1.18	1.07	1.00	0.95	0.91	0.89	0.88	1.00	-	-	-	-	-
71.4%	15.0%	5.39	3.42	2.43	2.00	1.74	1.44	1.27	1.15	1.07	1.01	0.96	0.93	0.90	0.88	0.93	-	-	-	-
80.0%	20.0%	5.70	3.62	2.57	2.11	1.84	1.52	1.33	1.21	1.12	1.05	1.00	0.96	0.93	0.89	0.88	0.89	1.00	-	-
86.6%	25.0%	5.93	3.76	2.67	2.20	1.91	1.58	1.38	1.25	1.16	1.08	1.03	0.99	0.95	0.90	0.88	0.88	0.89	-	-
91.7%	30.0%	6.10	3.87	2.75	2.26	1.96	1.62	1.42	1.28	1.18	1.11	1.05	1.01	0.97	0.92	0.89	0.88	0.88	0.93	-
95.4%	35.0%	6.23	3.95	2.80	2.30	2.00	1.65	1.44	1.31	1.20	1.13	1.07	1.02	0.98	0.93	0.89	0.88	0.88	0.90	-
98.0%	40.0%	6.31	4.00	2.84	2.33	2.03	1.67	1.46	1.32	1.22	1.14	1.08	1.03	0.99	0.93	0.90	0.89	0.88	0.89	-
99.5%	45.0%	6.36	4.03	2.86	2.35	2.04	1.68	1.47	1.33	1.23	1.15	1.09	1.04	1.00	0.94	0.90	0.89	0.88	0.88	-
100.0%	50.0%	6.38	4.04	2.87	2.35	2.05	1.69	1.48	1.33	1.23	1.15	1.09	1.04	1.00	0.94	0.90	0.89	0.88	0.88	1.00

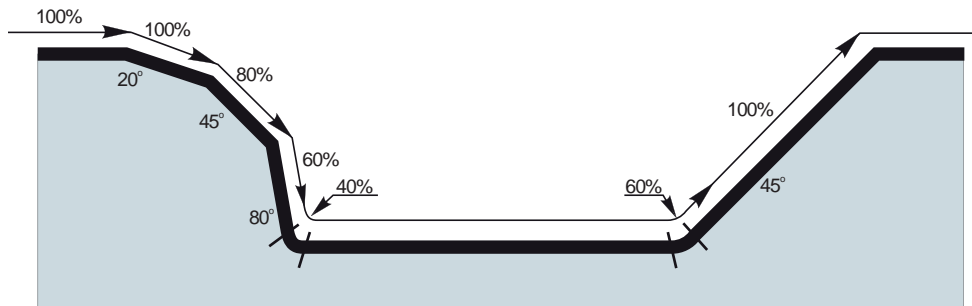

Überhang (Multiplikation des Durchmessers DCX)	< 3.0	3.0 – 3.5	3.6 – 4.0	4.1 – 4.5	> 4.6
Multiplikationsfaktor für die Geschwindigkeit	1.0	0.9	0.8	0.7	0.5

K2-SRC



PRAMET

S



Kopier- und Profil-Schaftfräser

Flexibler Fräser für eine Vielzahl von Werkzeug- und Formenbauanwendungen. Eine Werkzeuglösung für Kugelkopf- und Toruseinsätze. Erhältlich in zylindrischer und modularer Ausführung. Körper für längere Standzeiten oberflächenbehandelt.

APMX	0.6 - 3.2 mm
------	--------------

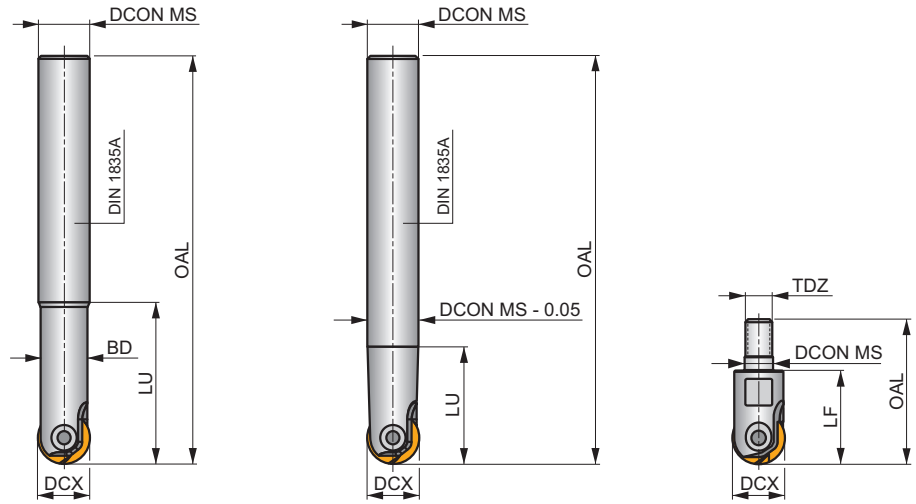
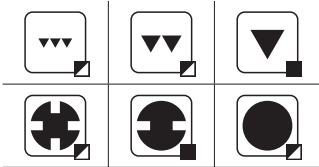
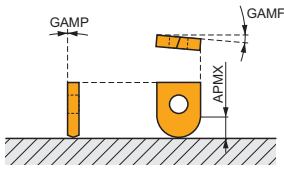

h_m	0.07 - 0.14
-------	-------------



Produkt	DCX	OAL	DCON MS	BD	LU	LF	TDZ			max.		kg		
	(mm)	(mm)	(mm)	(mm)	(mm)	(mm)								
08K2R025A10-SRC08-A	8	110	10	7.5	25	-	-	2	-	56000	-	0.08	GI030	C0530
08K2R050A12-SRC08-A	8	140	12	-	13.5	-	-	2	-	56000	-	0.14	GI030	C0530
10K2R030A12-SRC10-A	10	130	12	9	30	-	-	2	-	42000	-	0.16	GI031	C0531
10K2R060A16-SRC10-A	10	150	16	-	19.5	-	-	2	-	42000	-	0.18	GI031	C0531
12K2R030A12-SRC12-A	12	130	12	10.5	30	-	-	2	-	35000	-	0.11	GI032	C0532
12K2R060A16-SRC12-A	12	160	16	-	24.5	-	-	2	-	35000	-	0.14	GI032	C0532
16K2R035A16-SRC16-A	16	140	16	14	35	-	-	2	-	22000	-	0.23	GI033	C0533
16K2R065A20-SRC16-A	16	175	20	-	31.5	-	-	2	-	22000	-	0.30	GI033	C0533
20K2R045A20-SRC20-A	20	160	20	18	45	-	-	2	-	16000	-	0.40	GI034	C0534
20K2R080A25-SRC20-A	20	190	25	-	33.5	-	-	2	-	16000	-	0.66	GI034	C0534
25K2R045A25-SRC25-A	25	160	25	22.4	45	-	-	2	-	10000	-	0.59	GI035	C0535
32K2R060A32-SRC32-A	32	180	32	28.6	60	-	-	2	-	6000	-	1.10	GI036	C0536
08K2R30M06-SRC08-A	8	45	6.5	-	-	30	M6	2	-	-	-	0.02	GI123	C0530
10K2R30M06-SRC10-A	10	45	6.5	-	-	30	M6	2	-	-	-	0.03	GI124	C0531
12K2R30M06-SRC12-A	12	45	6.5	-	-	30	M6	2	-	-	-	0.15	GI125	C0530
12K2R30M08-SRC12-A	12	48	8.5	-	-	30	M8	2	-	-	-	0.04	GI125	C0532
16K2R35M08-SRC16-A	16	53	8.5	-	-	35	M8	2	-	-	-	0.16	GI033	C0533
20K2R35M10-SRC20-A	20	54	10.5	-	-	35	M10	2	-	-	-	0.08	GI034	C0534

GI030	RC 08	-	LC 08-KP	LC 08-KPF
GI031	RC 10	RC 10-F	LC 10-KP	LC 10-KPF
GI032	RC 12	RC 12-F	-	-
GI033	RC 16	RC 16-F	-	-
GI034	RC 20	-	-	-
GI035	RC 25	-	-	-

GI036	RC 32	-	-	-
GI123	RC 08	-	-	-
GI124	RC 10	RC 10-F	-	-
GI125	RC 12	RC 12-F	-	-

C0530	CS 3007-T08P	1.2	M 3	7	-	-	-	-	Flag T08P
C0531	CS 4008-T15P	3.0	M 4	8	-	D-T08P/T15P	FG-15	-	-
C0532	CS 5009-T20P	5.0	M 5	9	SDRT20P	-	-	-	-
C0533	CS 5013-T20P	5.0	M 5	13	SDRT20P	-	-	-	-
C0534	CS 5015-T20P	5.0	M 5	15	SDRT20P	-	-	-	-
C0535	CS 6020-T20P	7.5	M 6	20	SDRT20P	-	-	-	-
C0536	CS 8025-T30P	15.0	M 8	25	SDRT30P	-	-	-	-

RC



	CDI	D1	INSL	S
	(mm)	(mm)	(mm)	(mm)
08	8.0	3.00	9.5	2.00
10	10.0	4.00	11.5	2.50
12	12.0	5.00	12.0	2.50
16	16.0	5.00	14.0	3.00
20	20.0	5.00	16.0	3.00
25	25.0	6.00	21.5	4.00
32	32.0	8.00	25.8	5.00

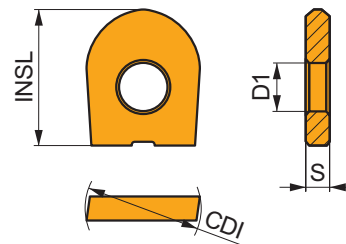

Eignung und Startwerte für Schnittgeschwindigkeit (vc), Vorschub (f) und Schnitttiefe (ap). Weitere Informationen finden Sie in unserer Zerspanungsrechner-App.

Produkt	RE	P			M			K			N			S			H		
		vc	f	ap	vc	f	ap	vc	f	ap	vc	f	ap	vc	f	ap	vc	f	ap
	(mm)	(m/min)	(mm/tooth)	(mm)	(m/min)	(mm/tooth)	(mm)	(m/min)	(mm/tooth)	(mm)	(m/min)	(mm/tooth)	(mm)	(m/min)	(mm/tooth)	(mm)	(m/min)	(mm/tooth)	(mm)



N neutrale Fläche mit positivem Schneidendesign.

RC 08:M4310		-		255	0.36	0.4	-	-	-		240	0.36	0.4	-	-	-	-	-	-		50	0.18	0.8
RC 08:M8310		-		295	0.36	0.4	-	-	-		280	0.36	0.4	-	-	-	-	-	-		55	0.18	0.8
RC 10:M4310		-		250	0.36	0.5	-	-	-		235	0.36	0.5	-	-	-	-	-	-		50	0.18	1.0
RC 10:M8310		-		290	0.36	0.5	-	-	-		275	0.36	0.5	-	-	-	-	-	-		55	0.18	1.0
RC 10:M8330		-		270	0.36	0.5	-	-	-		255	0.36	0.5	-	-	-	-	-	-		50	0.18	1.0
RC 12:M4310		-		245	0.36	0.6	-	-	-		230	0.36	0.6	-	-	-	-	-	-		45	0.18	1.2
RC 12:M8310		-		285	0.36	0.6	-	-	-		270	0.36	0.6	-	-	-	-	-	-		55	0.18	1.2
RC 12:M8330		-		265	0.36	0.6	-	-	-		250	0.36	0.6	-	-	-	-	-	-		50	0.18	1.2
RC 16:M4310		-		235	0.36	0.8	-	-	-		220	0.36	0.8	-	-	-	-	-	-		45	0.18	1.1
RC 16:M8310		-		275	0.36	0.8	-	-	-		260	0.36	0.8	-	-	-	-	-	-		55	0.18	1.1
RC 16:M8330		-		255	0.36	0.8	-	-	-		240	0.36	0.8	-	-	-	-	-	-		50	0.18	1.1
RC 20:M4310		-		235	0.36	1.0	-	-	-		220	0.36	1.0	-	-	-	-	-	-		45	0.18	1.3
RC 20:M8310		-		270	0.36	1.0	-	-	-		255	0.36	1.0	-	-	-	-	-	-		50	0.18	1.3
RC 20:M8330		-		250	0.36	1.0	-	-	-		235	0.36	1.0	-	-	-	-	-	-		50	0.18	1.3
RC 25:M8310		-		260	0.36	1.3	-	-	-		245	0.36	1.3	-	-	-	-	-	-		50	0.18	1.7
RC 25:M8330		-		245	0.36	1.3	-	-	-		230	0.36	1.3	-	-	-	-	-	-		45	0.18	1.7
RC 32:M4310		-		220	0.36	1.6	-	-	-		205	0.36	1.6	-	-	-	-	-	-		40	0.18	2.1
RC 32:M8330		-		240	0.36	1.6	-	-	-		225	0.36	1.6	-	-	-	-	-	-		45	0.18	2.1

Eignung und Startwerte für Schnittgeschwindigkeit (vc), Vorschub (f) und Schnitttiefe (ap). Weitere Informationen finden Sie in unserer Zerspanungsrechner-App.

Produkt	RE (mm)	P			M			K			N			S			H		
		vc (m/min)	f (mm/tooth)	ap (mm)	vc (m/min)	f (mm/tooth)	ap (mm)	vc (m/min)	f (mm/tooth)	ap (mm)	vc (m/min)	f (mm/tooth)	ap (mm)	vc (m/min)	f (mm/tooth)	ap (mm)	vc (m/min)	f (mm/tooth)	ap (mm)



F geometrie ist scharf und eignet sich zum Schlichten.

RC 10-F:M4310	●	–	250	0.36	0.5	125	0.32	0.5	235	0.36	0.5	–	–	–	–	–	–	–	50	0.18	1.0
RC 12-F:M4310	●	–	245	0.36	0.6	120	0.32	0.6	230	0.36	0.6	–	–	–	–	–	–	–	45	0.18	1.2
RC 16-F:M4310	●	–	235	0.36	0.8	115	0.32	0.8	220	0.36	0.8	–	–	–	–	–	–	–	45	0.18	1.1
RC 16-F:M8330	●	–	255	0.36	0.8	150	0.32	0.8	240	0.36	0.8	–	–	–	–	–	–	–	50	0.18	1.1

LC

	CDI (mm)	D1 (mm)	L (mm)	S (mm)
08	8.0	3.00	9.50	2.00
10	10.0	4.00	11.50	2.50

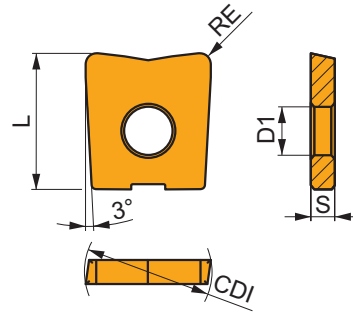

Produkt	RE (mm)	P			M			K			N			S			H		
		vc (m/min)	f (mm/tooth)	ap (mm)	vc (m/min)	f (mm/tooth)	ap (mm)	vc (m/min)	f (mm/tooth)	ap (mm)	vc (m/min)	f (mm/tooth)	ap (mm)	vc (m/min)	f (mm/tooth)	ap (mm)	vc (m/min)	f (mm/tooth)	ap (mm)



KP geometrie ohne Spanwinkel für die leichte bis mittlere Bearbeitung.

LC 0806-KP:M4310	●	0.6	280	0.16	0.3	–	–	–	265	0.16	0.3	–	–	–	–	–	–	–	55	0.11	0.6
LC 0806-KP:M8310	●	0.6	325	0.16	0.3	–	–	–	305	0.16	0.3	–	–	–	–	–	–	–	65	0.11	0.6
LC 0810-KP:M4310	●	1.0	280	0.16	0.5	–	–	–	265	0.16	0.5	–	–	–	–	–	–	–	55	0.11	1.0
LC 1008-KP:M4310	●	0.8	270	0.16	0.4	–	–	–	255	0.16	0.4	–	–	–	–	–	–	–	50	0.08	0.8
LC 1008-KP:M8310	●	0.8	315	0.16	0.4	–	–	–	295	0.16	0.4	–	–	–	–	–	–	–	60	0.08	0.8
LC 1010-KP:M4310	●	1.0	280	0.16	0.5	–	–	–	265	0.16	0.5	–	–	–	–	–	–	–	55	0.08	1.0
LC 1010-KP:M8310	●	1.0	325	0.16	0.5	–	–	–	305	0.16	0.5	–	–	–	–	–	–	–	65	0.08	1.0

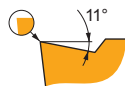

KPF geometrie mit positiven Design zur leichten bis mittleren Bearbeitung.

LC 0806-KPF:M4310	●	0.6	280	0.16	0.3	140	0.14	0.3	265	0.16	0.3	–	–	–	–	–	–	–	55	0.08	0.6
LC 1008-KPF:M4310	●	0.8	270	0.16	0.4	135	0.14	0.4	255	0.16	0.4	–	–	–	–	–	–	–	50	0.08	0.8



	RC 08	RC 10	RC 12	RC 16	RC 20	RC 25	RC 32
	4.0	5.0	6.0	8.0	10.0	12.5	16.0
	-	-	-	-	-	-	-

	RC 10-F	RC 12-F	RC 16-F
	5.0	6.0	8.0
	-	-	-

	LC 08-KP	LC 08-KP	LC 10-KP	LC 10-KP	LC 08-KPF	LC 10-KPF
	0.6	1.0	0.8	1.0	0.6	0.8
	-	-	-	-	-	-

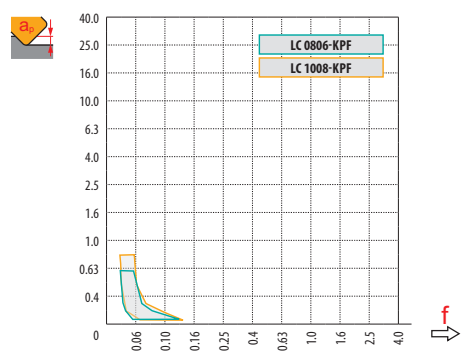
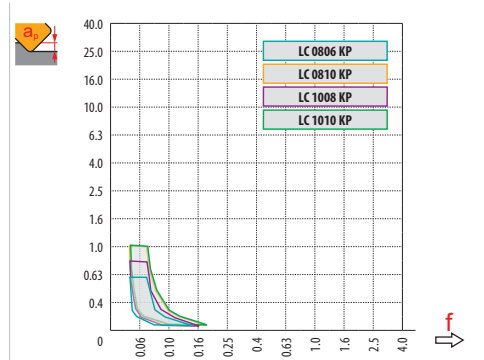
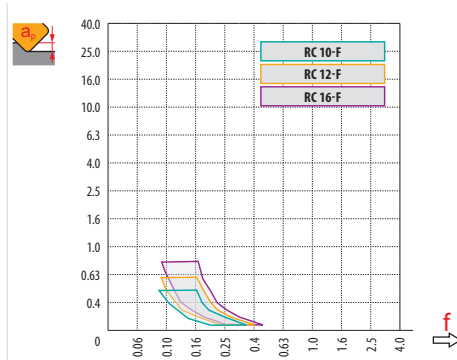
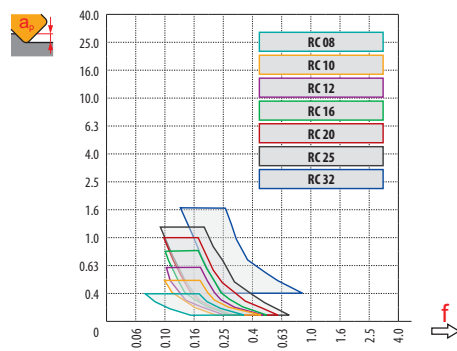

RC 08	8
RC 10 / RC 10-F	10
RC 12 / RC 12-F	12
RC 16 / RC 16-F	16
RC 20	20
RC 25	25
RC 32	32

	0.3	0.4	0.5	0.7	1.0	1.25	1.5	2.0	2.5	3.0	4.0	5.0	6.0	8.0	10.0	12.0	15.0	16.0
	3.0	3.5	3.9	4.5	5.3	5.8	6.2	6.9	7.4	7.7	8.0	-	-	-	-	-	-	-
	3.4	3.9	4.4	5.1	6.0	6.6	7.1	8.0	8.7	9.2	9.8	10.0	-	-	-	-	-	-
	3.7	4.3	4.8	5.6	6.6	7.3	7.9	8.9	9.7	10.4	11.3	11.8	12.0	-	-	-	-	-
	4.3	5.0	5.6	6.5	7.7	8.6	9.3	10.6	11.6	12.5	13.9	14.8	15.5	16.0	-	-	-	-
	4.9	5.6	6.2	7.4	8.7	9.7	10.5	12.0	13.2	14.3	16.0	17.3	18.3	19.6	20.0	-	-	-
	5.4	6.3	7.0	8.2	9.8	10.9	11.9	13.6	15.0	16.2	18.3	20.0	21.4	23.3	24.5	25.0	-	-
6.17	7.11	7.94	9.36	11.14	12.40	13.53	15.49	17.18	18.65	21.17	23.24	24.98	27.71	29.66	30.98	31.94	32.00	



RC 08	8
RC 10 / RC 10-F	10
RC 12 / RC 12-F	12
RC 16 / RC 16-F	16
RC 20	20
RC 25	25
RC 32	32

	3	5	10	15	20	30	40	50	60	80	100
	0.310	0.400	0.566	0.693	0.800	0.980	1.131	1.265	1.386	1.600	1.789
	0.346	0.447	0.632	0.775	0.894	1.095	1.265	1.414	1.549	1.789	2.000
	0.379	0.490	0.693	0.849	0.980	1.200	1.386	1.549	1.697	1.960	2.191
	0.438	0.566	0.800	0.980	1.131	1.386	1.600	1.789	1.960	2.263	2.530
	0.490	0.632	0.894	1.095	1.265	1.549	1.789	2.000	2.191	2.530	2.828
	0.548	0.707	1.000	1.225	1.414	1.732	2.000	2.236	2.449	2.828	3.162
0.620	0.800	1.131	1.386	1.600	1.960	2.263	2.530	2.771	3.200	3.578	

	a_e	1.0 %	2.5 %	5.0 %	7.5 %	10 %	15 %	20 %	25 %	30 %	35 %	40 %	45 %	50 %	60 %	70 %	75 %	80 %	90 %	100 %
19.9%	1.0%	2.86	1.84	1.33	1.12	1.00	0.89	-	-	-	-	-	-	-	-	-	-	-	-	-
31.2%	2.5%	3.58	2.28	1.64	1.36	1.20	1.01	0.92	0.88	0.91	-	-	-	-	-	-	-	-	-	-
43.6%	5.0%	4.22	2.68	1.92	1.58	1.39	1.16	1.03	0.95	0.90	0.88	0.89	-	-	-	-	-	-	-	-
52.7%	7.5%	4.63	2.95	2.10	1.73	1.51	1.26	1.11	1.02	0.96	0.91	0.89	0.88	0.90	-	-	-	-	-	-
60.0%	10.0%	4.94	3.14	2.24	1.84	1.61	1.33	1.18	1.07	1.00	0.95	0.91	0.89	0.88	1.00	-	-	-	-	-
71.4%	15.0%	5.39	3.42	2.43	2.00	1.74	1.44	1.27	1.15	1.07	1.01	0.96	0.93	0.90	0.88	0.93	-	-	-	-
80.0%	20.0%	5.70	3.62	2.57	2.11	1.84	1.52	1.33	1.21	1.12	1.05	1.00	0.96	0.93	0.89	0.88	0.89	1.00	-	-
86.6%	25.0%	5.93	3.76	2.67	2.20	1.91	1.58	1.38	1.25	1.16	1.08	1.03	0.99	0.95	0.90	0.88	0.88	0.89	-	-
91.7%	30.0%	6.10	3.87	2.75	2.26	1.96	1.62	1.42	1.28	1.18	1.11	1.05	1.01	0.97	0.92	0.89	0.88	0.88	0.93	-
95.4%	35.0%	6.23	3.95	2.80	2.30	2.00	1.65	1.44	1.31	1.20	1.13	1.07	1.02	0.98	0.93	0.89	0.88	0.88	0.90	-
98.0%	40.0%	6.31	4.00	2.84	2.33	2.03	1.67	1.46	1.32	1.22	1.14	1.08	1.03	0.99	0.93	0.90	0.89	0.88	0.89	-
99.5%	45.0%	6.36	4.03	2.86	2.35	2.04	1.68	1.47	1.33	1.23	1.15	1.09	1.04	1.00	0.94	0.90	0.89	0.88	0.88	-
100.0%	50.0%	6.38	4.04	2.87	2.35	2.05	1.69	1.48	1.33	1.23	1.15	1.09	1.04	1.00	0.94	0.90	0.89	0.88	0.88	1.00

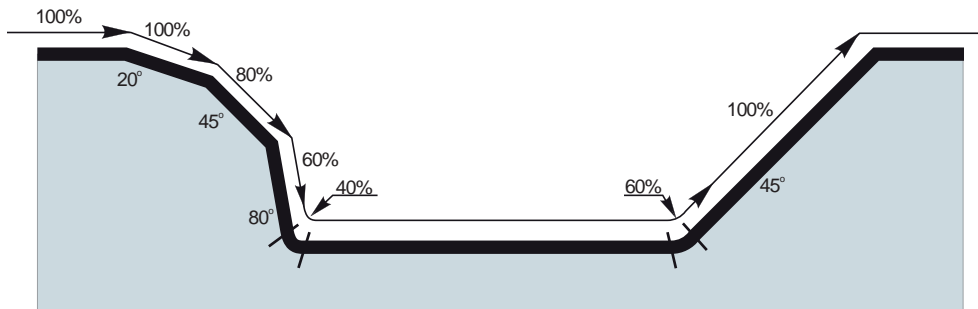



	DCX	RE	a _r														
			0.00	0.30	0.40	0.50	0.60	0.70	0.80	0.90	1.00	1.25	1.50	2.00	2.50	3.00	4.00
LC 0806-KP	8	0.6	6.8	7.8	7.9	8.0	8.0	-	-	-	-	-	-	-	-	-	-
LC 0806-KPF		0.6	6.8	7.8	7.9	8.0	8.0	-	-	-	-	-	-	-	-	-	-
LC 0810-KP		1.0	6.0	7.4	7.6	7.7	7.8	7.9	8.0	8.0	8.0	-	-	-	-	-	-
LC 1008-KP	10	0.8	8.4	9.6	9.8	9.9	9.9	10.0	10.0	-	-	-	-	-	-	-	-
LC 1008-KPF		0.8	8.4	9.6	9.8	9.9	9.9	10.0	10.0	-	-	-	-	-	-	-	-
LC 1010-KP		1.0	8.0	9.4	9.6	9.7	9.8	9.9	10.0	10.0	10.0	-	-	-	-	-	-



DCX	μm	3	5	10	15	20	30	40	50	60	80	100
8	FE	0.310	0.400	0.566	0.693	0.800	0.980	1.131	1.265	1.386	1.600	1.789
		0.346	0.447	0.632	0.775	0.894	1.095	1.265	1.414	1.549	1.789	2.000
RE	μm	3	5	10	15	20	30	40	50	60	80	100
	FE	0.120	0.155	0.219	0.268	0.310	0.379	0.438	0.490	0.537	0.620	0.693
		0.139	0.179	0.253	0.310	0.358	0.438	0.506	0.566	0.620	0.716	0.800
		0.155	0.200	0.283	0.346	0.400	0.490	0.566	0.632	0.693	0.800	0.89



	DCX	RE	max
LC 0806-KP	8	0.6	3.0
LC 0806-KPF		0.6	2.8
LC 0810-KP		1.0	3.0
LC 1008-KP	10	0.8	3.8
LC 1008-KPF		0.8	3.6
LC 1010-KP		1.0	3.8



	DCX	RE	RPMX	APMX/I
LC 0806-KP	8	0.6	2.5	1.5/35
LC 0806-KPF		0.6	2.2	1.5/39
LC 0810-KP		1.0	2.4	1.5/36
LC 1008-KP	10	0.8	2.6	1.5/33
LC 1008-KPF		0.8	2.3	1.5/38
LC 1010-KP		1.0	2.6	1.5/33



	DCX	RE	DMIN	DMAX	SMAX DMIN	SMAX DMAX
LC 0806-KP	8	0.6	9.8	15.9	0.8	1.0
LC 0806-KPF		0.6	10.2	15.9	0.1	0.1
LC 0810-KP		1.0	9.9	15.9	0.1	0.1
LC 1008-KP	10	0.8	12.2	19.9	0.9	1.1
LC 1008-KPF		0.8	12.6	19.9	0.2	0.2
LC 1010-KP		1.0	12.2	19.9	0.2	0.2



	DCX	RE	a _r
LC 0806-KP	8	0.6	0.15
LC 0806-KPF		0.6	0.13
LC 0810-KP		1.0	0.13
LC 1008-KP	10	0.8	0.2
LC 1008-KPF		0.8	0.18
LC 1010-KP		1.0	0.19

Überhang (Multiplikation des Durchmessers DCX)	< 3.0	3.0 – 3.5	3.6 – 4.0	4.1 – 4.5	> 4.6
Multiplikationsfaktor für die Geschwindigkeit	1.0	0.9	0.8	0.7	0.5

K2-SLC

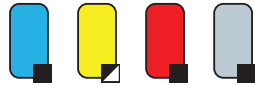

PRAMET



Kopier- und Profilfräser zum Schlichten

Schaftfräser für Schlichtvorgänge in einer Vielzahl von Anwendungen unter Verwendung von LC-Wendeschneidplatten. Hochpräzise Einsätze bieten eine hervorragende Genauigkeit. Zum Profilieren, Anfasen, helix Fräsen, progressiven Eintauchen und Rampen. Erhältlich in zylindrischer Ausführung. Körper für längere Standzeiten oberflächenbehandelt.

APMX	1.0 - 3.0 mm
------	--------------

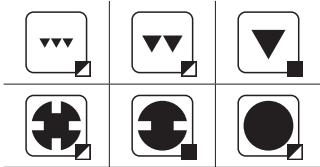
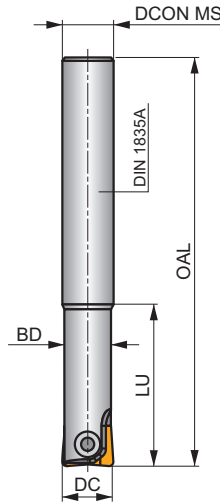
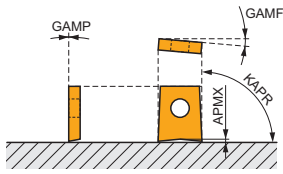

0.03 - 0.10



Produkt	DC (mm)	OAL (mm)	DCON MS (mm)	LU (mm)	BD (mm)							
12K2R030A12-SLC12-A	12	130	12	30	10.5	2	-	35000	-	0.11	G1037	C0532
16K2R035A16-SLC16-A	16	140	16	35	14	2	-	22000	-	0.20	G1038	C0533
20K2R045A20-SLC20-A	20	160	20	45	18	2	-	16000	-	0.38	G1039	C0534

G1037	LC 12-KP	LC 12-KPF
G1038	LC 16-KP	-
G1039	LC 20-KP	-

C0532	CS 5009-T20P	5.0	M 5	9	SDR T20P
C0533	CS 5013-T20P	5.0	M 5	13	SDR T20P
C0534	CS 5015-T20P	5.0	M 5	15	SDRT20P

LC



	CDI (mm)	D1 (mm)	L (mm)	S (mm)
12	12.0	5.00	14.00	2.50
16	16.0	5.00	16.00	3.00
20	20.0	5.00	18.00	3.00

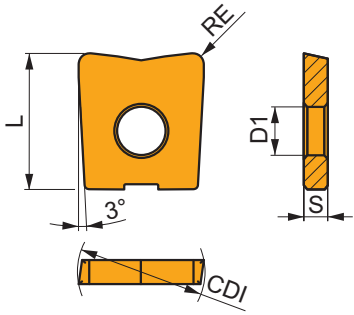

Eignung und Startwerte für Schnittgeschwindigkeit (vc), Vorschub (f) und Schnitttiefe (ap). Weitere Informationen finden Sie in unserer Zerspanungsrechner-App.

Produkt	RE (mm)	P			M			K			N			S			H		
		vc (m/min)	f (mm/tooth)	ap (mm)	vc (m/min)	f (mm/tooth)	ap (mm)	vc (m/min)	f (mm/tooth)	ap (mm)	vc (m/min)	f (mm/tooth)	ap (mm)	vc (m/min)	f (mm/tooth)	ap (mm)	vc (m/min)	f (mm/tooth)	ap (mm)



KP geometrie ohne Spanwinkel für die leichte bis mittlere Bearbeitung.

LC 1210-KP:M4310	1.0	280	0.16	0.5	-	-	-	265	0.16	0.5	-	-	-	-	-	-	55	0.08	1.0
LC 1210-KP:M8310	1.0	325	0.16	0.5	-	-	-	305	0.16	0.5	-	-	-	-	-	-	65	0.08	1.0
LC 1210-KP:M8330	1.0	295	0.16	0.5	-	-	-	280	0.16	0.5	-	-	-	-	-	-	55	0.08	1.0
LC 1610-KP:M4310	1.0	280	0.16	0.5	-	-	-	265	0.16	0.5	-	-	-	-	-	-	55	0.08	1.0
LC 1610-KP:M8310	1.0	325	0.16	0.5	-	-	-	305	0.16	0.5	-	-	-	-	-	-	65	0.08	1.0
LC 1610-KP:M8330	1.0	295	0.16	0.5	-	-	-	280	0.16	0.5	-	-	-	-	-	-	55	0.08	1.0
LC 1613-KP:M4310	1.3	270	0.16	0.7	-	-	-	255	0.16	0.7	-	-	-	-	-	-	50	0.08	1.3
LC 1613-KP:M8310	1.3	315	0.16	0.7	-	-	-	295	0.16	0.7	-	-	-	-	-	-	60	0.08	1.3
LC 2010-KP:M4310	1.0	280	0.16	0.5	-	-	-	265	0.16	0.5	-	-	-	-	-	-	55	0.08	1.0
LC 2010-KP:M8310	1.0	325	0.16	0.5	-	-	-	305	0.16	0.5	-	-	-	-	-	-	65	0.08	1.0
LC 2016-KP:M4310	1.6	280	0.16	0.8	-	-	-	265	0.16	0.8	-	-	-	-	-	-	55	0.08	1.1
LC 2016-KP:M8310	1.6	325	0.16	0.8	-	-	-	305	0.16	0.8	-	-	-	-	-	-	65	0.08	1.1
LC 2040-KP:M8330	4.0	285	0.16	2.0	-	-	-	270	0.16	2.0	-	-	-	-	-	-	55	0.08	2.7

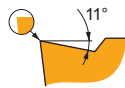

KPF geometrie mit positiven Design zur leichten bis mittleren Bearbeitung.

LC 1210-KPF:M4310	1.0	280	0.16	0.5	140	0.14	0.5	265	0.16	0.5	-	-	-	-	-	-	55	0.08	1.0
LC 1210-KPF:M8330	1.0	295	0.16	0.5	175	0.14	0.5	280	0.16	0.5	-	-	-	-	-	-	55	0.08	1.0



a_e / DC	5%	10%	15%	20%	25%	30%	40%	50%	60%	70%	75%	80%	90%	100%
	1.48	1.35	1.27	1.22	1.19	1.16	1.11	1.08	1.05	1.03	1.00	1.00	1.00	1.00
	2.20	1.60	1.35	1.20	1.10	0.95	0.85	0.75	0.85	0.95	1.00	1.00	1.00	1.00
	0.64	0.64	0.64	0.64	0.64	0.65	0.65	0.67	0.68	0.71	0.72	0.74	0.79	1.00

	LC 1210-KP	LC 1610-KP	LC 1613-KP	LC 2010-KP	LC 2016-KP	LC 2040-KP	LC 1210-KPF
	1.0	1.3	3.0	1.0	1.6	4.0	1.0
	-	-	-	-	-	-	-

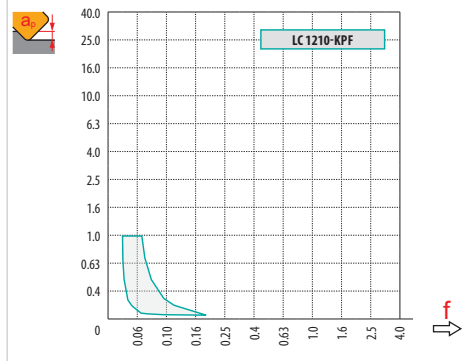
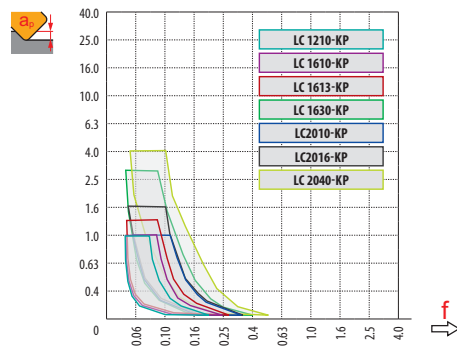

	DC	RE															
			0.0	0.3	0.4	0.5	0.6	0.7	0.8	0.9	1.0	1.25	1.5	2.0	2.5	3.0	4.0
LC 1210-KP	12	1.0	10.0	11.4	11.6	11.7	11.8	11.9	12.0	12.0	12.0	-	-	-	-	-	-
LC 1210-KPF		1.0	10.0	11.4	11.6	11.7	11.8	11.9	12.0	12.0	12.0	-	-	-	-	-	-
LC 1610-KP	16	1.0	14.0	15.4	15.6	15.7	15.8	15.9	16.0	16.0	16.0	-	-	-	-	-	-
LC 1613-KP		1.3	13.4	15.1	15.3	15.4	15.6	15.7	15.8	15.9	15.9	16.0	-	-	-	-	-
LC 2010-KP	20	1.0	18.0	19.4	19.6	19.7	19.8	19.9	20.0	20.0	20.0	-	-	-	-	-	-
LC 2016-KP		1.6	16.8	18.7	18.9	19.1	19.3	19.4	19.6	19.7	19.8	19.9	20.0	-	-	-	-
LC 2040-KP		4.0	12.0	15.0	15.5	15.9	16.2	16.5	16.8	17.1	17.3	17.8	18.2	18.9	19.4	-	-



		3	5	10	15	20	30	40	50	60	80	100
12		0.379	0.490	0.693	0.849	0.980	1.200	1.386	1.549	1.697	1.960	2.191
16		0.438	0.566	0.800	0.980	1.131	1.386	1.600	1.789	1.960	2.263	2.530
20		0.490	0.632	0.894	1.095	1.265	1.549	1.789	2.000	2.191	2.530	2.828
		3	5	10	15	20	30	40	50	60	80	100
1.3		0.177	0.228	0.322	0.395	0.456	0.559	0.645	0.721	0.790	0.912	1.020
1.6		0.196	0.253	0.358	0.438	0.506	0.620	0.716	0.800	0.876	1.012	1.131
2.0		0.219	0.283	0.400	0.490	0.566	0.693	0.800	0.894	0.980	1.131	1.265
4.0		0.310	0.400	0.566	0.693	0.800	0.980	1.131	1.265	1.386	1.600	1.789



LC 1210-KP	12	4.8
LC 1210-KPF	12	4.4
LC 1610-KP	16	6.6
LC 1613-KP	16	6.6
LC 2010-KP	20	8.5
LC 2016-KP	20	8.5
LC 2040-KP	4.0	8.5



LC 1210-KP	12	4.7	1.5/19
LC 1210-KPF	12	3.8	1.5/23
LC 1610-KP	16	4.8	1.5/18
LC 1613-KP	16	4.8	1.5/18
LC 2010-KP	20	5.0	1.5/18
LC 2016-KP	20	4.9	1.6/19
LC 2040-KP	4.0	4.5	4.0/51



		D _{MIN}	D _{MAX}		
LC 1210-KP	12	14.1	23.9	1.0	1.2
LC 1210-KPF	12	15.0	23.9	0.4	0.4
LC 1610-KP	16	18.6	31.9	1.1	1.4
LC 1613-KP	16	18.6	31.9	0.6	0.6
LC 2010-KP	20	22.8	39.9	1.3	1.5
LC 2016-KP	20	22.8	39.9	0.8	0.8
LC 2040-KP	4.0	22.8	39.9	0.5	0.5



LC 1210-KP	12	0.44
LC 1210-KPF	12	0.9
LC 1610-KP	16	0.65
LC 1613-KP	16	0.62
LC 2010-KP	20	0.85
LC 2016-KP	20	0.79
LC 2040-KP	4.0	0.54

Überhang (Multiplikation des Durchmessers DCX)	< 3.0	3 – 3.5	3.6 – 4.0	4.1 – 4.5	> 4.6
Multiplikationsfaktor für die Geschwindigkeit	1.0	0.9	0.8	0.7	0.5

K2-PPH



PRAMET



Kopier- und Profil-Schaftfräser

Flexibler Fräser für eine Vielzahl von Werkzeug- und Formenbauanwendungen. Eine Werkzeugglösung für kugelförmige, torusförmige und für Einsätze mit hohem Vorschub. Hochpräzise Schneideinsätze bieten eine hohe Genauigkeit. Erhältlich in zylindrischer und modularer Ausführung. Körper für längere Standzeiten oberflächenbehandelt.

APMX	0.3 - 4.0 mm
------	--------------

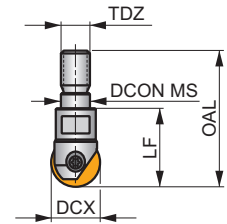
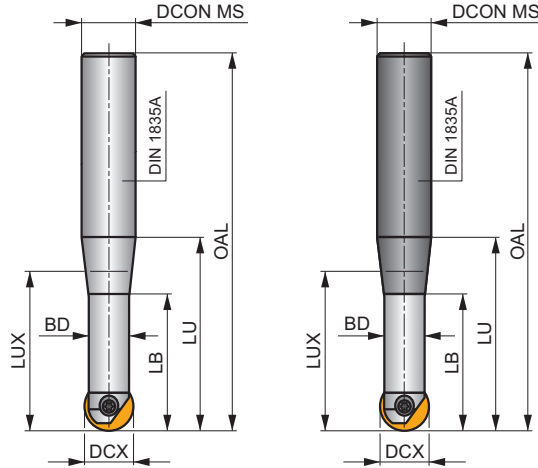
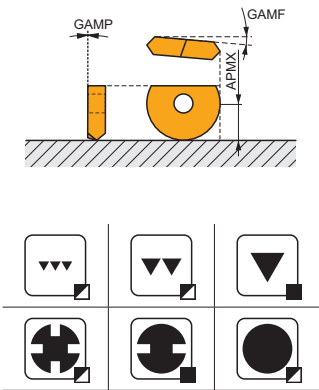

h_m	0.07 - 0.14
-------	-------------



Produkt	DCX	OAL	DCON MS	BD	LB	LU	LUX	LF	TDZ	Carbide	max.	kg	GI284	C0540
	(mm)	(mm)	(mm)	(mm)	(mm)	(mm)	(mm)	(mm)	(mm)					
PPH-08/02-QC12-092	8	92	12	6.5	19	35	23.1	-	-	-	40000	-	0.14	GI284 C0540
PPH-08/02-QC12-110	8	110	12	6.5	33.5	53	41.5	-	-	-	33600	-	0.14	GI284 C0540
PPH-08/02-QC12-132	8	132	12	6.5	19	75	41.8	-	-	-	16800	-	0.15	GI284 C0540
PPH-10/02-QC12-092	10	92	12	8	22.4	38	30	-	-	-	40000	-	0.12	GI285 C0541
PPH-10/02-QC12-110	10	110	12	8	38.7	53	51.9	-	-	-	40000	-	0.15	GI285 C0541
PPH-10/02-QC12-132	10	132	12	8	21.8	75	73.6	-	-	-	20300	-	0.16	GI285 C0541
PPH-12/02-QC16-145	12	145	16	10	22.5	85	63.3	-	-	-	19800	-	0.23	GI286 C0542
PPH-16/02-QC20-166	16	166	20	14	29.5	100	75.5	-	-	-	20000	-	0.37	GI287 C0543
PPH-20/02-QC25-191	20	191	25	17	35	115	82.2	-	-	-	18400	-	0.64	GI288 C0544
PPH-25/02-QC32-215	25	215	32	21	42.5	135	97	-	-	-	16500	-	1.07	GI289 C0545
PPH-12/02-QC12-083	12	83	12	10	-	26	-	-	-	-	40000	-	0.15	GI286 C0542
PPH-12/02-QC12-110	12	110	12	10	-	53	-	-	-	-	40000	-	0.15	GI286 C0542
PPH-16/02-QC16-092	16	92	16	14	-	92	-	-	-	-	36000	-	0.20	GI287 C0543
PPH-16/02-QC16-123	16	123	16	14	-	63	-	-	-	-	36000	-	0.24	GI287 C0543
PPH-20/02-QC20-104	20	104	20	17	-	38	-	-	-	-	40000	-	0.34	GI288 C0544
PPH-20/02-QC20-141	20	141	20	17	-	75	-	-	-	-	40000	-	0.41	GI288 C0544
PPH-25/02-QC25-121	25	121	25	21	-	45	-	-	-	-	40000	-	0.53	GI289 C0545
PPH-25/02-QC25-166	25	166	25	21	-	90	-	-	-	-	37100	-	0.57	GI289 C0545
PPH-32/02-QC32-186	32	186	32	26	-	107	-	-	-	-	32500	-	1.09	GI290 C0546
PPH-32/02-QC32-240	32	240	32	26	-	160	-	-	-	-	14500	-	1.37	GI290 C0546
PPH-08/02-QC12-110HSCW	8	110	12	6.5	19	53	30.1	-	-	✓	40000	-	0.21	GI284 C0540
PPH-08/02-QC12-132HSCW	8	132	12	6.5	19	75	37.1	-	-	✓	23400	-	0.22	GI284 C0540
PPH-10/02-QC12-092HSCW	10	92	12	8	21.9	38.1	90.9	-	-	✓	40000	-	0.20	GI285 C0541
PPH-10/02-QC12-132HSCW	10	132	12	8	21.8	75.1	51.1	-	-	✓	23400	-	0.24	GI285 C0541
PPH-12/02-QC16-145HSCW	12	145	16	10	21.5	85	65.6	-	-	✓	21000	-	0.28	GI286 C0542
PPH-16/02-QC20-166HSCW	16	166	20	14	28.5	100	87.2	-	-	✓	25500	-	0.66	GI287 C0543
PPH-20/02-QC25-191HSCW	20	191	25	17	35	115	75.6	-	-	✓	18500	-	1.07	GI288 C0544
PPH-08/02-QC08-130HSCW	8	130	8	6.5	-	20	-	-	-	✓	40000	-	0.17	GI284 C0540

Produkt	DCX	OAL	DCONIMS	BD	LB	LU	LUX	LF	TDZ	Carbide				
	(mm)	(mm)	(mm)	(mm)	(mm)	(mm)	(mm)	(mm)						
PPH-10/02-QC10-140HSCW	10	140	10	8	-	25	-	-	-	✓	40000	-	0.22	GI285 C0541
PPH-12/02-QC12-083HSCW	12	83	12	10	-	26	-	-	-	✓	40000	-	0.19	GI286 C0542
PPH-12/02-QC12-110HSCW	12	110	12	10	-	53	-	-	-	✓	40000	-	0.22	GI286 C0542
PPH-16/02-QC16-092HSCW	16	92	16	14	-	32	-	-	-	✓	43000	-	0.29	GI287 C0543
PPH-16/02-QC16-123HSCW	16	123	16	14	-	63	-	-	-	✓	43000	-	0.36	GI287 C0543
PPH-20/02-QC20-104HSCW	20	104	20	17	-	38	-	-	-	✓	40000	-	0.50	GI288 C0544
PPH-20/02-QC20-141HSCW	20	141	20	17	-	75	-	-	-	✓	40000	-	0.62	GI288 C0544
PPH-16/02-025-P08	16	-	8.5	-	-	-	-	25	M8	-	-	-	0.10	GI287 C0543
PPH-20/02-030-P10	20	-	10.5	-	-	-	-	30	M10	-	-	-	0.16	GI288 C0544

GI284	PPH 08..	-	PPHT 08..	PPHF 08..
GI285	PPH 10..	PPHE 10..	PPHT 10..	PPHF 10..
GI286	PPH 12..	PPHE 12..	PPHT 12..	PPHF 12..
GI287	PPH 16..	PPHE 16..	PPHT 16..	PPHF 16..
GI288	PPH 20..	PPHE 20..	PPHT 20..	PPHF 20..
GI289	PPH 25..	-	PPHT 25..	-
GI290	PPH 32..	-	-	-

C0540	CS 42506-T07P	1.0	M 2.5	6	D-T07P/T09P	FG-15	-	-
C0541	CS 43008-T08P	1.2	M 3	8	D-T08P/T15P	FG-15	-	-
C0542	CS 43509-T10P	2.0	M 3.5	9	-	-	SDRT10P	-
C0543	CS 44013-T15P	3.0	M 4	13	D-T08P/T15P	FG-15	-	-
C0544	CS 45016-T20P	5.0	M 5	16	-	-	SDRT20P	-
C0545	CS 46020-T25P	7.5	M 6	20	-	-	-	SDRT25P-T
C0546	CS 48025-T40P	15.0	M 8	25	-	-	-	SDRT40P-T

PPH



	CDI (mm)	D1 (mm)	INSL (mm)	S (mm)
0800	8.0	2.50	7.0	2.40
1000	10.0	3.00	8.5	2.60
1200	12.0	3.50	10.0	3.00
1600	16.0	4.00	12.0	4.00
2000	20.0	5.00	15.0	5.00
2500	25.0	6.00	18.5	6.00
3000	30.0	8.00	22.5	7.00
3200	32.0	8.00	23.5	7.00

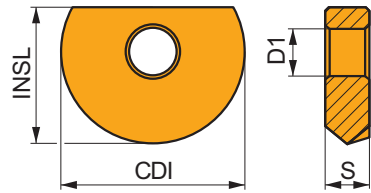

Eignung und Startwerte für Schnittgeschwindigkeit (vc), Vorschub (f) und Schnitttiefe (ap). Weitere Informationen finden Sie in unserer Zerspanungsrechner-App.

Produkt	RE (mm)	P			M			K			N			S			H		
		vc (m/min)	f (mm/tooth)	ap (mm)	vc (m/min)	f (mm/tooth)	ap (mm)	vc (m/min)	f (mm/tooth)	ap (mm)	vc (m/min)	f (mm/tooth)	ap (mm)	vc (m/min)	f (mm/tooth)	ap (mm)	vc (m/min)	f (mm/tooth)	ap (mm)



CL1 scharfe geometrie.

PPH 0800-CL1:2003	☺	–	285	0.36	0.4	145	0.32	0.4	270	0.36	0.4	–	–	–	–	–	–	–	55	0.18	0.8
PPH 1000-CL1:2003	☺	–	280	0.36	0.5	140	0.32	0.5	265	0.36	0.5	–	–	–	–	–	–	–	55	0.18	1.0
PPH 1200-CL1:2003	☺	–	275	0.36	0.6	140	0.32	0.6	260	0.36	0.6	–	–	–	–	–	–	–	55	0.18	1.2
PPH 1600-CL1:2003	☺	–	265	0.36	0.8	135	0.32	0.8	250	0.36	0.8	–	–	–	–	–	–	–	50	0.18	1.1
PPH 2000-CL1:2003	☺	–	260	0.36	1.0	130	0.32	1.0	245	0.36	1.0	–	–	–	–	–	–	–	50	0.18	1.3
PPH 2500-CL1:2003	☺	–	250	0.36	1.3	125	0.32	1.3	235	0.36	1.3	–	–	–	–	–	–	–	50	0.18	1.7
PPH 3000-CL1:2003	☺	–	245	0.36	1.5	120	0.32	1.5	230	0.36	1.5	–	–	–	–	–	–	–	45	0.18	2.0
PPH 3200-CL1:2003	☺	–	245	0.36	1.6	120	0.32	1.6	230	0.36	1.6	–	–	–	–	–	–	–	45	0.18	2.1



CL4 scharfe geometrie für unterbrochene Schnitte.

PPH 0800-CL4:8215	☺	–	270	0.36	0.4	–	–	–	255	0.36	0.4	–	–	–	–	–	–	–	50	0.18	0.8
PPH 1000-CL4:8215	☺	–	265	0.36	0.5	–	–	–	250	0.36	0.5	–	–	–	–	–	–	–	50	0.18	1.0
PPH 1200-CL4:8215	☺	–	255	0.36	0.6	–	–	–	240	0.36	0.6	–	–	–	–	–	–	–	50	0.18	1.2
PPH 1600-CL4:8215	☺	–	250	0.36	0.8	–	–	–	235	0.36	0.8	–	–	–	–	–	–	–	50	0.18	1.1
PPH 2000-CL4:8215	☺	–	245	0.36	1.0	–	–	–	230	0.36	1.0	–	–	–	–	–	–	–	45	0.18	1.3

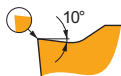

SM1 geometrie mit scharfer Ausführung

PPHE 1000-SM1:8215	☺	–	275	0.31	0.5	165	0.28	0.5	260	0.31	0.5	–	–	–	–	–	–	–	55	0.16	1.0
PPHE 1200-SM1:8215	☺	–	255	0.36	0.6	150	0.32	0.6	240	0.36	0.6	–	–	–	–	–	–	–	50	0.18	1.2
PPHE 1600-SM1:8215	☺	–	260	0.31	0.8	155	0.28	0.8	245	0.31	0.8	–	–	–	–	–	–	–	50	0.16	1.1
PPHE 2000-SM1:8215	☺	–	250	0.31	1.0	150	0.28	1.0	235	0.31	1.0	–	–	–	–	–	–	–	50	0.16	1.3

PPHT



	CDI (mm)	D1 (mm)	INSL (mm)	S (mm)
0800	8.0	2.50	7.0	2.40
1000	10.0	3.00	8.5	2.60
1200	12.0	3.50	10.0	3.00
1600	16.0	4.00	12.0	4.00
2000	20.0	5.00	15.0	5.00
2500	25.0	6.00	18.5	6.00

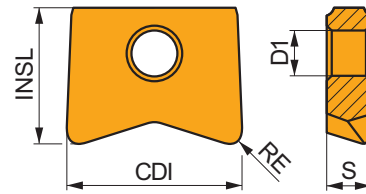

Eignung und Startwerte für Schnittgeschwindigkeit (vc), Vorschub (f) und Schnitttiefe (ap). Weitere Informationen finden Sie in unserer Zerspanungsrechner-App.

Produkt	RE (mm)	P			M			K			N			S			H		
		vc (m/min)	f (mm/tooth)	ap (mm)	vc (m/min)	f (mm/tooth)	ap (mm)	vc (m/min)	f (mm/tooth)	ap (mm)	vc (m/min)	f (mm/tooth)	ap (mm)	vc (m/min)	f (mm/tooth)	ap (mm)			

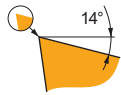

A2 positive geometrie für leichte bis mittlere Bearbeitung.

PPHT 080003-A2:2003	● 0.3	275	0.10	0.3	140	0.09	0.3	260	0.10	0.3	-	-	-	-	-	-	55	0.07	0.3
PPHT 080005-A2:2003	● 0.5	270	0.13	0.3	135	0.12	0.3	255	0.13	0.3	-	-	-	-	-	-	50	0.09	0.5
PPHT 080010-A2:2003	⊕ 1.0	315	0.14	0.5	160	0.13	0.5	295	0.14	0.5	-	-	-	-	-	-	60	0.10	1.0
PPHT 100005-A2:2003	● 0.5	270	0.13	0.3	135	0.12	0.3	255	0.13	0.3	-	-	-	-	-	-	50	0.09	0.5
PPHT 100008-A2:2003	⊕ 0.8	305	0.14	0.4	155	0.13	0.4	285	0.14	0.4	-	-	-	-	-	-	60	0.10	0.8
PPHT 100010-A2:2003	⊕ 1.0	315	0.14	0.5	160	0.13	0.5	295	0.14	0.5	-	-	-	-	-	-	60	0.10	1.0
PPHT 120005-A2:2003	● 0.5	270	0.13	0.3	135	0.12	0.3	255	0.13	0.3	-	-	-	-	-	-	50	0.09	0.5
PPHT 120010-A2:2003	⊕ 1.0	315	0.14	0.5	160	0.13	0.5	295	0.14	0.5	-	-	-	-	-	-	60	0.10	1.0
PPHT 120020-A2:2003	⊕ 2.0	320	0.14	1.0	160	0.13	1.0	300	0.14	1.0	-	-	-	-	-	-	60	0.10	1.3
PPHT 160010-A2:2003	⊕ 1.0	315	0.14	0.5	160	0.13	0.5	295	0.14	0.5	-	-	-	-	-	-	60	0.10	1.0
PPHT 160013-A2:2003	⊕ 1.3	300	0.15	0.6	150	0.13	0.6	285	0.15	0.6	-	-	-	-	-	-	60	0.10	1.3
PPHT 160020-A2:2003	⊕ 2.0	320	0.14	1.0	160	0.13	1.0	300	0.14	1.0	-	-	-	-	-	-	60	0.10	1.3
PPHT 200010-A2:2003	⊕ 1.0	315	0.14	0.5	160	0.13	0.5	295	0.14	0.5	-	-	-	-	-	-	60	0.10	1.0
PPHT 200016-A2:2003	⊕ 1.6	310	0.14	0.8	155	0.13	0.8	290	0.14	0.8	-	-	-	-	-	-	60	0.10	1.1
PPHT 200030-A2:2003	⊕ 3.0	305	0.14	1.5	155	0.13	1.5	285	0.14	1.5	-	-	-	-	-	-	60	0.10	2.0
PPHT 200040-A2:2003	⊕ 4.0	295	0.14	2.0	150	0.13	2.0	280	0.14	2.0	-	-	-	-	-	-	55	0.10	2.7
PPHT 250020-A2:2003	⊕ 2.0	320	0.14	1.0	160	0.13	1.0	300	0.14	1.0	-	-	-	-	-	-	60	0.10	1.3

PPHF



	BS	LE	CDI	D1	INSL	S
	(mm)	(mm)	(mm)	(mm)	(mm)	(mm)
0800	0.40	2.60	8.0	2.50	7.0	2.40
1000	0.50	3.20	10.0	3.00	8.5	2.60
1200	0.60	3.90	12.0	3.50	10.0	3.00
1600	0.80	5.20	16.0	4.00	12.0	4.00
2000	1.00	6.40	20.0	5.00	15.0	5.00

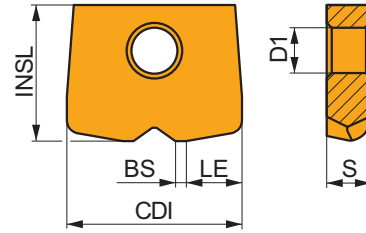

Eignung und Startwerte für Schnittgeschwindigkeit (vc), Vorschub (f) und Schnitttiefe (ap). Weitere Informationen finden Sie in unserer Zerspanungsrechner-App.

Produkt	RE (mm)	P			M			K			N			S			H		
		vc	f	ap	vc	f	ap	vc	f	ap	vc	f	ap	vc	f	ap	vc	f	ap
		(m/min)	(mm/tooth)	(mm)	(m/min)	(mm/tooth)	(mm)	(m/min)	(mm/tooth)	(mm)	(m/min)	(mm/tooth)	(mm)	(m/min)	(mm/tooth)	(mm)	(m/min)	(mm/tooth)	(mm)

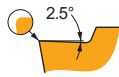
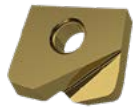

CE1 starke geometrie zur Bearbeitung mit hohem Vorschub.

PPHF 080004-CE1:M8330	●	–	■	200	0.30	0.3	▣	120	0.27	0.3	■	190	0.30	0.3	–	–	–	▣	50	0.27	0.2	▣	40	0.21	0.2
PPHF 100005-CE1:M8330	●	–	■	190	0.35	0.3	▣	110	0.32	0.3	■	180	0.35	0.3	–	–	–	▣	45	0.32	0.2	▣	35	0.25	0.2
PPHF 120006-CE1:M8330	●	–	■	205	0.45	0.4	▣	120	0.41	0.4	■	190	0.45	0.4	–	–	–	▣	50	0.41	0.3	▣	40	0.32	0.3
PPHF 160008-CE1:M8330	●	–	■	190	0.60	0.5	▣	110	0.54	0.5	■	180	0.60	0.5	–	–	–	▣	45	0.54	0.4	▣	35	0.42	0.4
PPHF 200010-CE1:M8330	●	–	■	185	0.75	0.6	▣	110	0.68	0.6	■	175	0.75	0.6	–	–	–	▣	45	0.68	0.5	▣	35	0.53	0.4



a_e DCX	5 %	10 %	15 %	20 %	25 %	30 %	40 %	50 %	60 %	70 %	75 %	80 %	90 %	100 %
	1.48	1.35	1.27	1.22	1.19	1.16	1.11	1.08	1.05	1.03	1.00	1.00	1.00	1.00
	2.20	1.60	1.35	1.20	1.10	0.95	0.85	0.75	0.85	0.95	1.00	1.00	1.00	1.00
	0.64	0.64	0.64	0.64	0.64	0.65	0.65	0.67	0.68	0.71	0.72	0.74	0.79	1.00

	PPH 08-CL1	PPH 10-CL1	PPH 12-CL1	PPH 16-CL1	PPH 20-CL1	PPH 25-CL1	PPH 30-CL1	PPH 32-CL1
	4.0	5.0	6.0	8.0	10.0	12.5	15.0	16.0
	-	-	-	-	-	-	-	-

	PPH 08-CL4	PPH 10-CL4	PPH 12-CL4	PPH 16-CL4	PPH 20-CL4
	4.0	5.0	6.0	8.0	10.0
	-	-	-	-	-

	PPHE 10-SM1	PPHE 12-SM1	PPHE 16-SM1	PPHE 20-SM1
	5.0	6.0	8.0	10.0
	-	-	-	-

	PPHF 08-CE1	PPHF 10-CE1	PPHF 12-CE1	PPHF 16-CE1	PPHF 20-CE1
	0.6	0.8	1.0	1.3	1.6
	0.40	0.50	0.60	0.80	1.00

	PPHT 08-A2	PPHT 08-A2	PPHT 08-A2	PPHT 10-A2	PPHT 10-A2	PPHT 10-A2	PPHT 12-A2	PPHT 12-A2	PPHT 12-A2
	0.3	0.5	1.0	0.5	0.8	1.0	0.5	1.0	2.0
	-	-	-	-	-	-	-	-	-

	PPHT 16-A2	PPHT 16-A2	PPHT 16-A2	PPHT 20-A2	PPHT 20-A2	PPHT 20-A2	PPHT 20-A2	PPHT 25-A2
	1.0	1.3	2.0	1.0	1.6	3.0	4.0	2.0
	-	-	-	-	-	-	-	-

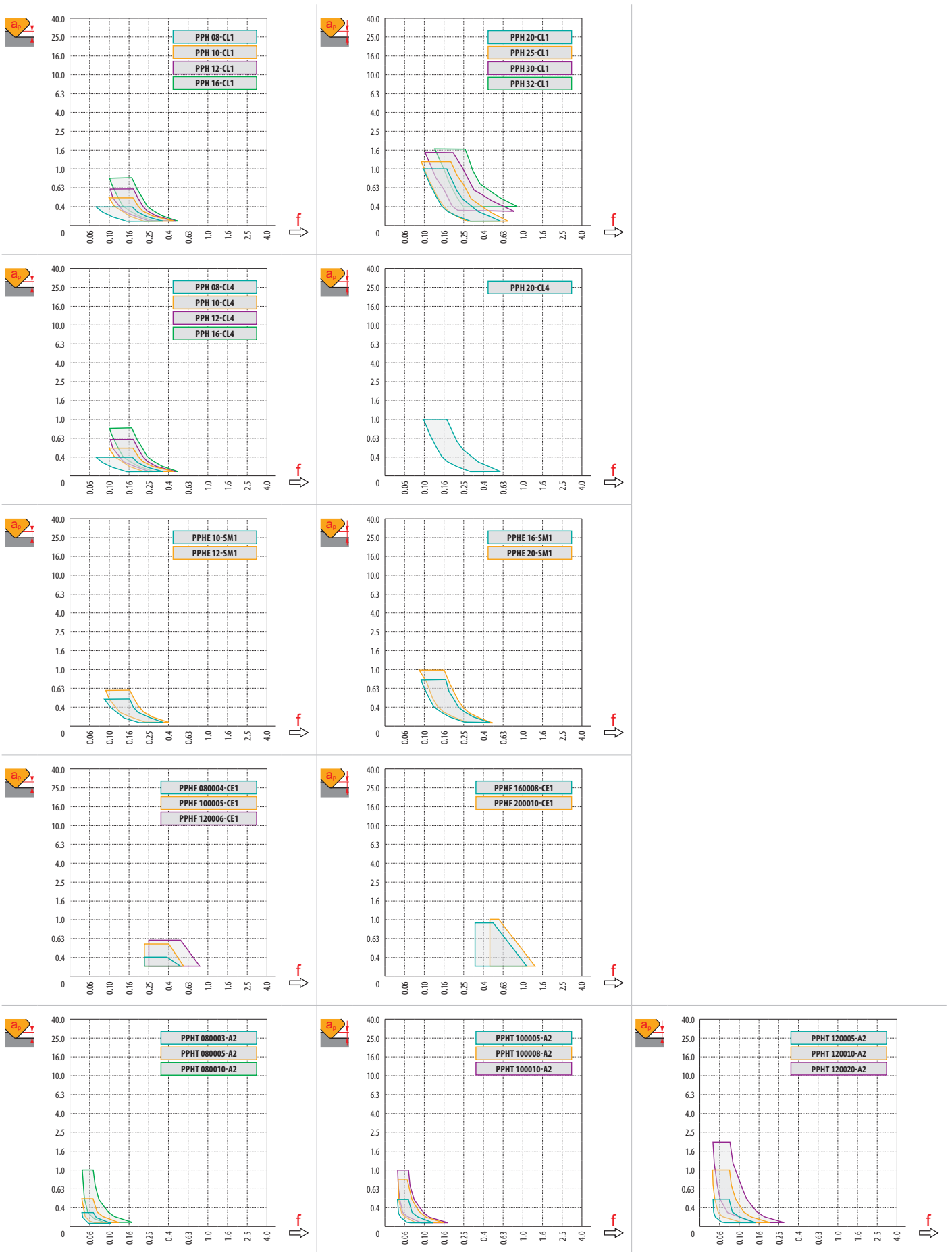

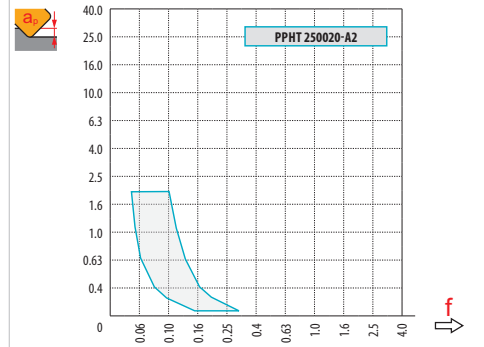
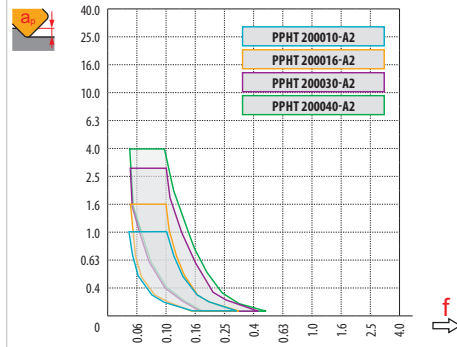
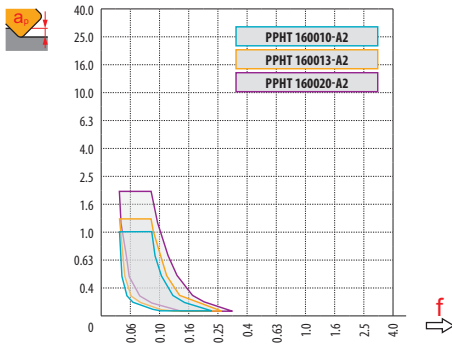

PPH	DCX	DEF	Ra																	
			0.3	0.4	0.5	0.7	1.0	1.25	1.5	2.0	2.5	3.0	4.0	5.0	6.0	8.0	10.0	12.0	15.0	16.0
PPH 08	8		3.0	3.5	3.9	4.5	5.3	5.8	6.2	6.9	7.4	7.7	8.0	-	-	-	-	-	-	-
PPH 10	10		3.4	3.9	4.4	5.1	6.0	6.6	7.1	8.0	8.7	9.2	9.8	10.0	-	-	-	-	-	-
PPH 12	12		3.7	4.3	4.8	5.6	6.6	7.3	7.9	8.9	9.7	10.4	11.3	11.8	12.0	-	-	-	-	-
PPH 16	16		4.3	5.0	5.6	6.5	7.7	8.6	9.3	10.6	11.6	12.5	13.9	14.8	15.5	16.0	-	-	-	-
PPH 20	20		4.9	5.6	6.2	7.4	8.7	9.7	10.5	12.0	13.2	14.3	16.0	17.3	18.3	19.6	20.0	-	-	-
PPH 25	25		5.4	6.3	7.0	8.2	9.8	10.9	11.9	13.6	15.0	16.2	18.3	20.0	21.4	23.3	24.5	25.0	-	-
PPH 32	32		6.17	7.11	7.94	9.36	11.14	12.40	13.53	15.49	17.18	18.65	21.17	23.24	24.98	27.71	29.66	30.98	31.94	32.00

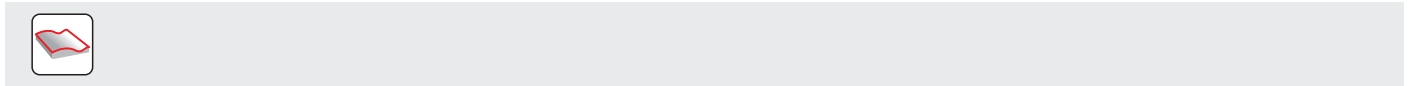

PPH	DCX	μm	Ra										
			3	5	10	15	20	30	40	50	60	80	100
PPH 08	8		0.310	0.400	0.566	0.693	0.800	0.980	1.131	1.265	1.386	1.600	1.789
PPH 10	10		0.346	0.447	0.632	0.775	0.894	1.095	1.265	1.414	1.549	1.789	2.000
PPH 12	12		0.379	0.490	0.693	0.849	0.980	1.200	1.386	1.549	1.697	1.960	2.191
PPH 16	16		0.438	0.566	0.800	0.980	1.131	1.386	1.600	1.789	1.960	2.263	2.530
PPH 20	20		0.490	0.632	0.894	1.095	1.265	1.549	1.789	2.000	2.191	2.530	2.828
PPH 25	25		0.548	0.707	1.000	1.225	1.414	1.732	2.000	2.236	2.449	2.828	3.162
PPH 32	32		0.620	0.800	1.131	1.386	1.600	1.960	2.263	2.530	2.771	3.200	3.578

	a _e	1%	2.5%	5%	7.5%	10%	15%	20%	25%	30%	35%	40%	45%	50%	60%	70%	75%	80%	90%	100%
19.9%	1.0%	2.86	1.84	1.33	1.12	1.00	0.89	-	-	-	-	-	-	-	-	-	-	-	-	-
31.2%	2.5%	3.58	2.28	1.64	1.36	1.20	1.01	0.92	0.88	0.91	-	-	-	-	-	-	-	-	-	-
43.6%	5.0%	4.22	2.68	1.92	1.58	1.39	1.16	1.03	0.95	0.90	0.88	0.89	-	-	-	-	-	-	-	-
52.7%	7.5%	4.63	2.95	2.10	1.73	1.51	1.26	1.11	1.02	0.96	0.91	0.89	0.88	0.90	-	-	-	-	-	-
60.0%	10.0%	4.94	3.14	2.24	1.84	1.61	1.33	1.18	1.07	1.00	0.95	0.91	0.89	0.88	1.00	-	-	-	-	-
71.4%	15.0%	5.39	3.42	2.43	2.00	1.74	1.44	1.27	1.15	1.07	1.01	0.96	0.93	0.90	0.88	0.93	-	-	-	-
80.0%	20.0%	5.70	3.62	2.57	2.11	1.84	1.52	1.33	1.21	1.12	1.05	1.00	0.96	0.93	0.89	0.88	0.89	1.00	-	-
86.6%	25.0%	5.93	3.76	2.67	2.20	1.91	1.58	1.38	1.25	1.16	1.08	1.03	0.99	0.95	0.90	0.88	0.88	0.89	-	-
91.7%	30.0%	6.10	3.87	2.75	2.26	1.96	1.62	1.42	1.28	1.18	1.11	1.05	1.01	0.97	0.92	0.89	0.88	0.88	0.93	-
95.4%	35.0%	6.23	3.95	2.80	2.30	2.00	1.65	1.44	1.31	1.20	1.13	1.07	1.02	0.98	0.93	0.89	0.88	0.88	0.90	-
98.0%	40.0%	6.31	4.00	2.84	2.33	2.03	1.67	1.46	1.32	1.22	1.14	1.08	1.03	0.99	0.93	0.90	0.89	0.88	0.89	-
99.5%	45.0%	6.36	4.03	2.86	2.35	2.04	1.68	1.47	1.33	1.23	1.15	1.09	1.04	1.00	0.94	0.90	0.89	0.88	0.88	-
100.0%	50.0%	6.38	4.04	2.87	2.35	2.05	1.69	1.48	1.33	1.23	1.15	1.09	1.04	1.00	0.94	0.90	0.89	0.88	0.88	1.00

	DCX	RE																			
			0.0	0.3	0.4	0.5	0.6	0.7	0.8	0.9	1.0	1.25	1.5	2.0	2.5	3.0	4.0				
PPHT 08-A2	8	0.3	7.4	8.0	-	-	-	-	-	-	-	-	-	-	-	-	-	-	-	-	
PPHT 08-A2		0.5	7.0	7.9	8.0	8.0	-	-	-	-	-	-	-	-	-	-	-	-	-	-	-
PPHT 08-A2		0.8	6.4	7.6	7.8	7.9	7.9	8.0	8.0	-	-	-	-	-	-	-	-	-	-	-	-
PPHT 08-A2		1.0	6.0	7.4	7.6	7.7	7.8	7.9	8.0	8.0	8.0	-	-	-	-	-	-	-	-	-	-
PPHT 10-A2	10	0.5	9.0	9.9	10.0	10.0	-	-	-	-	-	-	-	-	-	-	-	-	-	-	
PPHT 10-A2		0.8	8.4	9.6	9.8	9.9	9.9	10.0	10.0	-	-	-	-	-	-	-	-	-	-	-	
PPHT 10-A2		1.0	8.0	9.4	9.6	9.7	9.8	9.9	10.0	10.0	-	-	-	-	-	-	-	-	-	-	
PPHT 12-A2	12	0.5	11.0	11.9	12.0	12.0	-	-	-	-	-	-	-	-	-	-	-	-	-	-	
PPHT 12-A2		1.0	10.0	11.4	11.6	11.7	11.8	11.9	12.0	12.0	12.0	-	-	-	-	-	-	-	-	-	
PPHT 12-A2		2.0	8.0	10.1	10.4	10.6	10.9	11.0	11.2	11.3	11.5	11.7	11.9	12.0	-	-	-	-	-	-	
PPHT 16-A2	16	1.0	14.0	15.4	15.6	15.7	15.8	15.9	16.0	16.0	16.0	-	-	-	-	-	-	-	-	-	
PPHT 16-A2		1.3	13.4	15.1	15.3	15.4	15.6	15.7	15.8	15.9	15.9	16.0	-	-	-	-	-	-	-	-	
PPHT 16-A2		2.0	12.0	14.1	14.4	14.6	14.9	15.0	15.2	15.3	15.5	15.7	15.9	16.0	-	-	-	-	-	-	
PPHT 16-A2		3.0	10.0	12.6	13.0	13.3	13.6	13.9	14.1	14.3	14.5	14.9	15.2	15.7	15.9	16.0	-	-	-	-	
PPHT 20-A2	20	1.0	18.0	19.4	19.6	19.7	19.8	19.9	20.0	20.0	20.0	-	-	-	-	-	-	-	-	-	
PPHT 20-A2		1.6	16.8	18.7	18.9	19.1	19.3	19.4	19.6	19.7	19.8	19.9	20.0	-	-	-	-	-	-	-	
PPHT 20-A2		3.0	14.0	16.6	17.0	17.3	17.6	17.9	18.1	18.3	18.5	18.9	19.2	19.7	19.9	20.0	-	-	-	-	
PPHT 20-A2		4.0	12.0	15.0	15.5	15.9	16.2	16.5	16.8	17.1	17.3	17.8	18.2	18.9	19.4	19.7	20.0	-	-	-	
PPHT 25-A2	25	2.0	21.0	23.1	23.4	23.6	23.9	24.0	24.2	24.3	24.5	24.7	24.9	25.0	-	-	-	-	-	-	
PPHF 08-CE1	8	0.6	2.8	6.0	7.1	-	-	-	-	-	-	-	-	-	-	-	-	-	-	-	
PPHF 10-CE1	10	0.8	3.6	6.8	7.9	9.0	-	-	-	-	-	-	-	-	-	-	-	-	-	-	
PPHF 12-CE1	12	1.0	4.2	7.4	8.5	9.6	10.7	11.8	-	-	-	-	-	-	-	-	-	-	-	-	
PPHF 16-CE1	16	1.3	5.6	8.8	9.9	11.0	12.1	13.2	14.2	15.3	-	-	-	-	-	-	-	-	-	-	
PPHF 20-CE1	20	1.6	7.2	10.4	11.5	12.6	13.7	14.8	15.8	16.9	18.0	-	-	-	-	-	-	-	-	-	
PPHF 25-CE1	25	1.9	9.2	12.4	13.5	14.6	15.7	16.8	17.8	18.9	20.0	22.7	-	-	-	-	-	-	-	-	



	μm	3	5	10	15	20	30	40	50	60	80	100
8		0.310	0.400	0.566	0.693	0.800	0.980	1.131	1.265	1.386	1.600	1.789
10		0.346	0.447	0.632	0.775	0.894	1.095	1.265	1.414	1.549	1.789	2.000
12		0.379	0.490	0.693	0.849	0.980	1.200	1.386	1.549	1.697	1.960	2.191
16		0.438	0.566	0.800	0.980	1.131	1.386	1.600	1.789	1.960	2.263	2.530
20		0.490	0.632	0.894	1.095	1.265	1.549	1.789	2.000	2.191	2.530	2.828
25		0.548	0.707	1.000	1.225	1.414	1.732	2.000	2.236	2.449	2.828	3.162
	μm	3	5	10	15	20	30	40	50	60	80	100
1.3		0.177	0.228	0.322	0.395	0.456	0.559	0.645	0.721	0.790	0.912	1.020
1.6		0.196	0.253	0.358	0.438	0.506	0.620	0.716	0.800	0.876	1.012	1.131
1.9		0.214	0.276	0.390	0.477	0.551	0.675	0.780	0.872	0.955	1.103	1.233
2.0		0.219	0.283	0.400	0.490	0.566	0.693	0.800	0.894	0.980	1.131	1.265
3.0		0.268	0.346	0.490	0.600	0.693	0.849	0.980	1.095	1.200	1.386	1.549
4.0		0.310	0.400	0.566	0.693	0.800	0.980	1.131	1.265	1.386	1.600	1.789

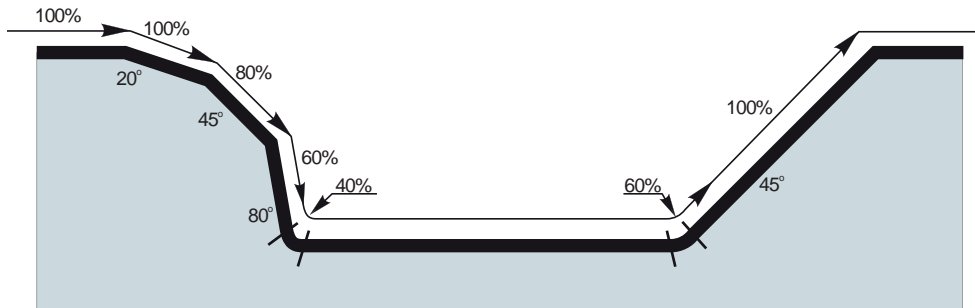

PPHT 08-A2	8	0.3	2.4
PPHT 08-A2		0.5	2.4
PPHT 08-A2		0.8	2.5
PPHT 08-A2		1.0	2.7
PPHT 10-A2		10	0.5
PPHT 10-A2	0.8		3.3
PPHT 10-A2	1.0		3.4
PPHT 12-A2	12	0.5	4.0
PPHT 12-A2		1.0	4.2
PPHT 12-A2		2.0	4.6
PPHT 16-A2	16	1.0	5.7
PPHT 16-A2		1.3	5.8
PPHT 16-A2		2.0	6.0
PPHT 16-A2		3.0	6.4
PPHT 20-A2	20	1.0	7.2
PPHT 20-A2		1.6	7.4
PPHT 20-A2		3.0	7.8
PPHT 20-A2		4.0	8.2
PPHT 25-A2	25	2.0	9.3

PPHF 08-CE1	8	0.6	2.0
PPHF 10-CE1	10	0.8	2.5
PPHF 12-CE1	12	1.0	3.0
PPHF 16-CE1	16	1.3	4.0
PPHF 20-CE1	20	1.6	5.0
PPHF 25-CE1	25	1.9	6.0



PPHT 08-A2	8	0.3	6.3	1.2/11
PPHT 08-A2		0.5	6.1	1.2/12
PPHT 08-A2		0.8	5.7	1.2/12
PPHT 08-A2		1.0	6.8	1.2/11
PPHT 10-A2	10	0.5	6.9	1.5/13
PPHT 10-A2		0.8	6.6	1.5/13
PPHT 10-A2		1.0	7.5	1.5/12
PPHT 12-A2	12	0.5	7.9	1.8/13
PPHT 12-A2		1.0	7.5	1.8/14
PPHT 12-A2		2.0	9.0	1.8/12
PPHT 16-A2	16	1.0	8.9	2.4/16
PPHT 16-A2		1.3	8.9	2.4/16
PPHT 16-A2		2.0	8.5	2.4/17
PPHT 16-A2		3.0	12.3	2.4/11
PPHT 20-A2	20	1.0	9.3	3/19
PPHT 20-A2		1.6	9.1	3/19
PPHT 20-A2		3.0	8.8	3/20
PPHT 20-A2		4.0	11.4	3/15
PPHT 25-A2	25	2.0	8.3	3.7/26

PPHF 08-CE1	8	0.6	8.0	0.4/3
PPHF 10-CE1	10	0.8	8.0	0.5/4
PPHF 12-CE1	12	1.0	8.0	0.6/5
PPHF 16-CE1	16	1.3	8.0	0.8/6
PPHF 20-CE1	20	1.6	8.0	1.0/8
PPHF 25-CE1	25	1.9	8.0	1.2/9



			DMIN	DMAX		
					DMIN	DMAX
PPHT 08-A2	8	0.3	11.0	15.9	0.5	0.5
PPHT 08-A2		0.5	10.9	15.9	0.5	0.5
PPHT 08-A2		0.8	10.7	15.9	0.4	0.4
PPHT 08-A2		1.0	10.3	15.9	0.4	0.4
PPHT 10-A2	10	0.5	13.4	19.9	0.7	0.7
PPHT 10-A2		0.8	13.2	19.9	0.6	0.6
PPHT 10-A2		1.0	12.9	19.9	0.6	0.6
PPHT 12-A2	12	0.5	15.8	23.9	1.0	1.0
PPHT 12-A2		1.0	15.4	23.9	0.8	0.8
PPHT 12-A2		2.0	14.6	23.9	0.7	0.7
PPHT 16-A2	16	1.0	20.4	31.9	1.3	1.3
PPHT 16-A2		1.3	20.2	31.9	1.3	1.3
PPHT 16-A2		2.0	19.7	31.9	1.0	1.0
PPHT 16-A2		3.0	18.9	31.9	1.2	1.2
PPHT 20-A2	20	1.0	25.4	39.9	1.8	1.8
PPHT 20-A2		1.6	24.9	39.9	1.6	1.6
PPHT 20-A2		3.0	24.1	39.9	1.2	1.2
PPHT 20-A2		4.0	23.3	39.9	1.3	1.3
PPHT 25-A2	25	2.0	31.1	49.9	1.8	1.8

			DMIN	DMAX		
					DMIN	DMAX
PPHF 08-CE1	8	0.6	10.0	14.7	0.40	0.40
PPHF 10-CE1	10	0.8	13.0	18.4	0.50	0.50
PPHF 12-CE1	12	1.0	15.7	22.0	0.60	0.60
PPHF 16-CE1	16	1.3	20.9	29.4	0.80	0.80
PPHF 20-CE1	20	1.6	26.2	36.7	1.00	1.00
PPHF 25-CE1	25	1.9	33.0	46.1	1.20	1.20



PPHT 08-A2	8	0.3	0.52
PPHT 08-A2		0.5	0.47
PPHT 08-A2		0.8	0.39
PPHT 08-A2		1.0	0.40
PPHT 10-A2	10	0.5	0.69
PPHT 10-A2		0.8	0.61
PPHT 10-A2		1.0	0.62
PPHT 12-A2	12	0.5	0.97
PPHT 12-A2		1.0	0.79
PPHT 12-A2		2.0	0.68
PPHT 16-A2	16	1.0	1.33
PPHT 16-A2		1.3	1.26
PPHT 16-A2		2.0	1.03
PPHT 16-A2		3.0	1.15
PPHT 20-A2	20	1.0	1.80
PPHT 20-A2		1.6	1.59
PPHT 20-A2		3.0	1.21
PPHT 20-A2		4.0	1.27
PPHT 25-A2	25	2.0	1.83

PPHF 08-CE1	8	0.6	0.40
PPHF 10-CE1	10	0.8	0.50
PPHF 12-CE1	12	1.0	0.60
PPHF 16-CE1	16	1.3	0.80
PPHF 20-CE1	20	1.6	1.00
PPHF 25-CE1	25	1.9	1.20

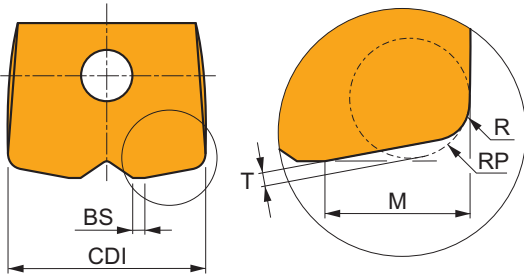

	R	RP	M	T
08	0.6	1.0	2.6	0.3
10	0.8	1.2	3.2	0.4
12	1.0	1.5	3.9	0.4
16	1.3	2.0	5.2	0.6
20	1.6	2.5	6.4	0.7
25	1.9	3.0	7.9	0.9



Überhang (Multiplikation des Durchmessers DCX)	< 3.0	3.0 – 3.5	3.6 – 4.0	4.1 – 4.5	> 4.6
Multiplikationsfaktor für die Geschwindigkeit	1.0	0.9	0.8	0.7	0.5

K3-CXP



PRAMET

C



MULTISIDE XP Profilfräser

Kugelkopffräser mit XP..-Wendeschneidplatten mit APMX von 8 bis 16 mm. Die einzigartige Klemmung ermöglicht die Verwendung von drei Wendeschneidplatten. Erhältlich in zylindrischer und modularer Ausführung. Körper für längere Standzeiten oberflächenbehandelt.

MULTISIDE XP

APMX	8.0 - 16.0 mm
------	---------------

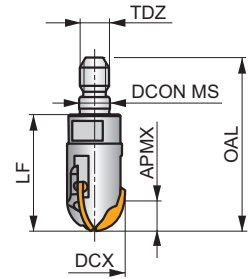
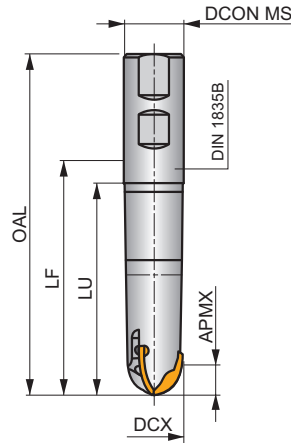
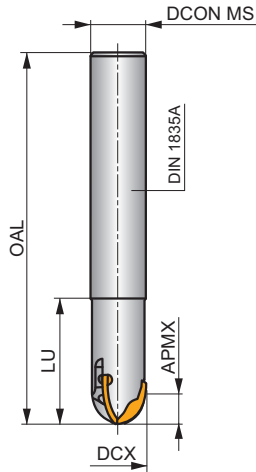
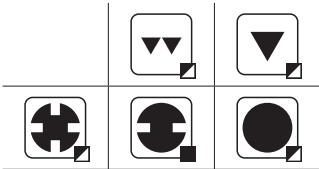
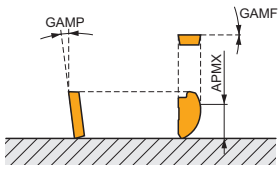

h_m 0.05 - 0.19



Produkt	DCX	OAL	DCON MS	LU	LUX	LF	TDZ	APMX	GAMF	GAMP						
	(mm)	(mm)	(mm)	(mm)	(mm)	(mm)	(mm)	(mm)	(°)	(°)						
16K3R050A16-CXP16	16	200	16	50	-	-	-	8.00	0	-5	3	-	22600	-	0.35	GI267 C0520
16K3R050A20-CXP16	16	200	20	50	-	-	-	8.00	0	-5	3	-	22600	-	0.50	GI267 C0520
20K3R050A20-CXP20	20	200	20	50	-	-	-	10.00	0	-5	3	-	20000	-	0.52	GI268 C0521
20K3R060A25-CXP20	20	250	25	60	-	-	-	10.00	0	-5	3	-	20000	-	0.92	GI268 C0521
25K3R060A25-CXP25	25	250	25	60	-	-	-	12.50	0	-5	3	-	20000	-	0.96	GI269 C0522
32K3R080A32-CXP32	32	250	32	80	-	-	-	16.00	0	-5	3	-	15000	-	1.50	GI270 C0523
16K3R060B20-CXP16	16	111	20	60	-	86.5	-	8.00	0	-5	3	-	22600	-	0.23	GI267 C0520
20K3R070B25-CXP20	20	127	25	70	-	95.5	-	10.00	0	-5	3	-	20000	-	0.41	GI268 C0521
25K3R080B25-CXP25	25	137	25	80	-	105	-	12.50	0	-5	3	-	20000	-	0.49	GI269 C0522
16K3R035M10-CXP16	16	-	10.5	-	-	35	M10	8.00	0	-5	3	-	-	-	0.07	GI267 C0520
20K3R040M10-CXP20	20	-	10.5	-	-	40	M10	10.00	0	-5	3	-	-	-	0.07	GI268 C0521
25K3R045M12-CXP25	25	-	12.5	-	-	45	M12	12.50	0	-5	3	-	-	-	0.16	GI269 C0522

GI267	XP 16..
GI268	XP 20..
GI269	XP 25..
GI270	XP 32..

C0520	US 63009-T09P	1.2	M 3	9	Flag T09P
C0521	US 63513-T15P	3.0	M 3.5	13	Flag T15P
C0522	US 64014-T15P	3.5	M 4	14	Flag T15P
C0523	US 65017-T20P	5.0	M 5	17	Flag T20P

XP



	W1 (mm)	S (mm)
16	16.000	2.00
20	20.000	2.50
25	25.000	3.17
32	32.000	4.00

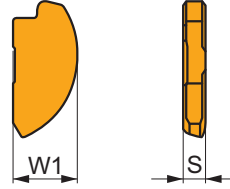

Eignung und Startwerte für Schnittgeschwindigkeit (vc), Vorschub (f) und Schnitttiefe (ap). Weitere Informationen finden Sie in unserer Zerspanungsrechner-App.

Produkt	RE (mm)	P			M			K			N			S			H		
		vc (m/min)	f (mm/tooth)	ap (mm)	vc (m/min)	f (mm/tooth)	ap (mm)	vc (m/min)	f (mm/tooth)	ap (mm)	vc (m/min)	f (mm/tooth)	ap (mm)	vc (m/min)	f (mm/tooth)	ap (mm)	vc (m/min)	f (mm/tooth)	ap (mm)



FM geometrie mit neutralen Design zur leichten Bearbeitung.

XP 16ER-FM:M8310	☹	-	■	285	0.27	0.8	☑	145	0.24	0.8	■	270	0.27	0.8	-	-	-	-	-	-	■	55	0.19	0.8	
XP 20ER-FM:M8330	☹	-	■	260	0.27	1.0	☑	155	0.24	1.0	■	245	0.27	1.0	-	-	-	☑	65	0.19	1.0	☑	50	0.19	1.0
XP 20ER-FM:M8345	☹	-	■	190	0.27	1.0	☑	110	0.24	1.0	-	-	-	-	-	-	-	☑	45	0.19	1.0	-	-	-	
XP 25ER-FM:M8310	☹	-	■	270	0.27	1.3	☑	135	0.24	1.3	■	255	0.27	1.3	-	-	-	-	-	-	■	50	0.19	1.3	
XP 32ER-FM:M8345	☹	-	■	180	0.27	1.6	☑	105	0.24	1.6	-	-	-	-	-	-	-	☑	45	0.19	1.6	-	-	-	



	XP 16-FM	XP 20-FM	XP 25-FM	XP 32-FM
	8.0	10.0	12.5	16.0
	-	-	-	-

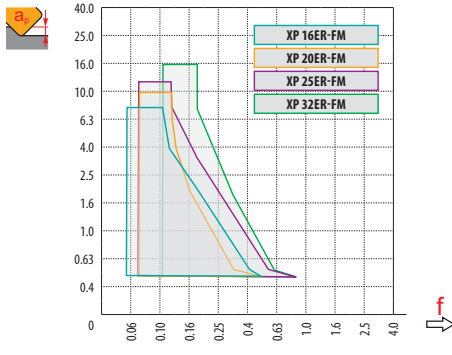

		0.3	0.4	0.5	0.7	1.0	1.25	1.5	2.0	2.5	3.0	4.0	5.0	6.0	8.0	10.0	12.0	15.0	
16		4.3	5.0	5.6	6.5	7.7	8.6	9.3	10.6	11.6	12.5	13.9	14.8	15.5	16.0	-	-	-	
20		4.9	5.6	6.2	7.4	8.7	9.7	10.5	12.0	13.2	14.3	16.0	17.3	18.3	19.6	20.0	-	-	
25		5.4	6.3	7.0	8.2	9.8	10.9	11.9	13.6	15.0	16.2	18.3	20.0	21.4	23.3	24.5	25.0	-	-
32		6.2	7.1	7.9	9.4	11.1	12.4	13.5	15.5	17.2	18.7	21.2	23.2	25.0	27.7	29.7	31.2	31.9	-

Wirksamer Bereich von 1 Schneidkante.

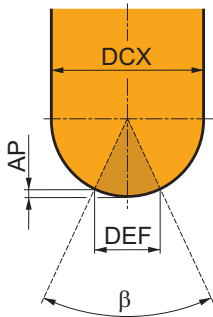

	β		AP
16	41°	5.568	0.51
20	37°	6.314	0.52
25	37°	7.901	0.65
32	37°	10.122	0.83



	μm	3	5	10	15	20	30	40	50	60	80	100
16		0.438	0.566	0.800	0.980	1.131	1.386	1.600	1.789	1.960	2.263	2.530
20		0.490	0.632	0.894	1.095	1.265	1.549	1.789	2.000	2.191	2.530	2.828
25		0.548	0.707	1.000	1.225	1.414	1.732	2.000	2.236	2.449	2.828	3.162
32		0.620	0.800	1.131	1.386	1.600	1.960	2.263	2.530	2.771	3.200	3.578

DEF	a _e	1.0 %	2.5 %	5.0 %	7.5 %	10 %	15 %	20 %	25 %	30 %	35 %	40 %	45 %	50 %	60 %	70 %	75 %	80 %	90 %	100 %		
19.9 %	1.0 %	2.86	1.84	1.33	1.12	1.00	0.89	-	-	-	-	-	-	-	-	-	-	-	-	-	-	-
31.2 %	2.5 %	3.58	2.28	1.64	1.36	1.20	1.01	0.92	0.88	0.91	-	-	-	-	-	-	-	-	-	-	-	-
43.6 %	5.0 %	4.22	2.68	1.92	1.58	1.39	1.16	1.03	0.95	0.90	0.88	0.89	-	-	-	-	-	-	-	-	-	-
52.7 %	7.5 %	4.63	2.95	2.10	1.73	1.51	1.26	1.11	1.02	0.96	0.91	0.89	0.88	0.90	-	-	-	-	-	-	-	-
60.0 %	10.0 %	4.94	3.14	2.24	1.84	1.61	1.33	1.18	1.07	1.00	0.95	0.91	0.89	0.88	1.00	-	-	-	-	-	-	-
71.4 %	15.0 %	5.39	3.42	2.43	2.00	1.74	1.44	1.27	1.15	1.07	1.01	0.96	0.93	0.90	0.88	0.93	-	-	-	-	-	-
80.0 %	20.0 %	5.70	3.62	2.57	2.11	1.84	1.52	1.33	1.21	1.12	1.05	1.00	0.96	0.93	0.89	0.88	0.89	1.00	-	-	-	-
86.6 %	25.0 %	5.93	3.76	2.67	2.20	1.91	1.58	1.38	1.25	1.16	1.08	1.03	0.99	0.95	0.90	0.88	0.88	0.89	-	-	-	-
91.7 %	30.0 %	6.10	3.87	2.75	2.26	1.96	1.62	1.42	1.28	1.18	1.11	1.05	1.01	0.97	0.92	0.89	0.88	0.88	0.93	-	-	-
95.4 %	35.0 %	6.23	3.95	2.80	2.30	2.00	1.65	1.44	1.31	1.20	1.13	1.07	1.02	0.98	0.93	0.89	0.88	0.88	0.90	-	-	-
98.0 %	40.0 %	6.31	4.00	2.84	2.33	2.03	1.67	1.46	1.32	1.22	1.14	1.08	1.03	0.99	0.93	0.90	0.89	0.88	0.88	0.89	-	-
99.5 %	45.0 %	6.36	4.03	2.86	2.35	2.04	1.68	1.47	1.33	1.23	1.15	1.09	1.04	1.00	0.94	0.90	0.89	0.88	0.88	0.88	-	-
100.0 %	50.0 %	6.38	4.04	2.87	2.35	2.05	1.69	1.48	1.33	1.23	1.15	1.09	1.04	1.00	0.94	0.90	0.89	0.88	0.88	0.88	1.00	-

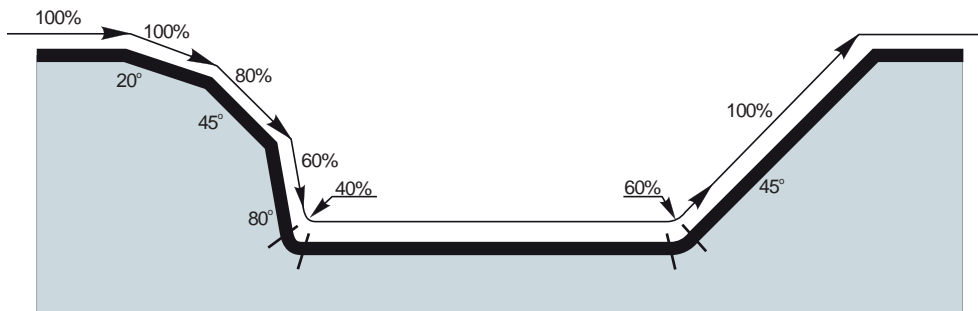

Überhang (Multiplikation des Durchmessers DCX)	< 3.0	3.1 – 4.0	4.1 – 6.0	> 6.1
Multiplikationsfaktor für die Geschwindigkeit	1.0	0.9	0.7	0.5

WENDEPLATTENFRÄSER – AUSWAHLHILFE

PLANFRÄSEN

	SVC22C		SCN05C		SWN04C				
	90°		90° (93°)		90° (93°)				
	APMX (mm)	3.0 (16.0)	APMX (mm)	0.5 (1.0)	APMX (mm)	0.5 (2.0)			
	DC (mm)	32 – 80	DC (mm)	12 – 20	DC (mm)	16 – 35			
Zylindrischer Schaft		DC = 32, 40 (mm)		DC = 12 – 20 (mm)		DC = 16 – 32 (mm)			
Weldon									
Modular		DC = 32, 40 (mm)		DC = 12 – 20 (mm)		DC = 16 – 35 (mm)			
Aufsteckfräser		DC = 50 – 80 (mm)							
Seite	📖 240		📖 243		📖 246				
ISO		N	P	K	H	P	K	H	
Schneidplattenform									
Wendeschneidplatten	VCGT 220530		CN.. 0502		WN.. 0403				
Anzahl der Schneiden	2		4		6				
Konturfräsen (Kopierfräsen)			■		■				
Planfräsen			■		■				
Schraubenlinieninterpolation		■							
Progressives Tauchfräsen		■							
Rampen		▣	■		■				
Flaches Nutfräsen		▣							
Tiefes Eckfräsen		▣	■		■				
Tauchfräsen			■		■				

SVC22C

N

PRAMET

S



Fräser für Nichteisen-Materialien mit Innenkühlung

Hochproduktiver Fräser für Aluminium und Nichteisenwerkstoffe mit VCGT 22-Wendeschneidplatten mit einem APMX von 16 mm. Innenkühlung. Geeignet fürs Plan-, progressives Eintauchen, Schulter-, Rampen- und Nutfräsen. Erhältlich mit zylindrischen, modularen Schaft und als Aufsteckfräser. Körper für längere Standzeiten oberflächenbehandelt.

KAPR	90°
APMX	3.0 (16.0) mm

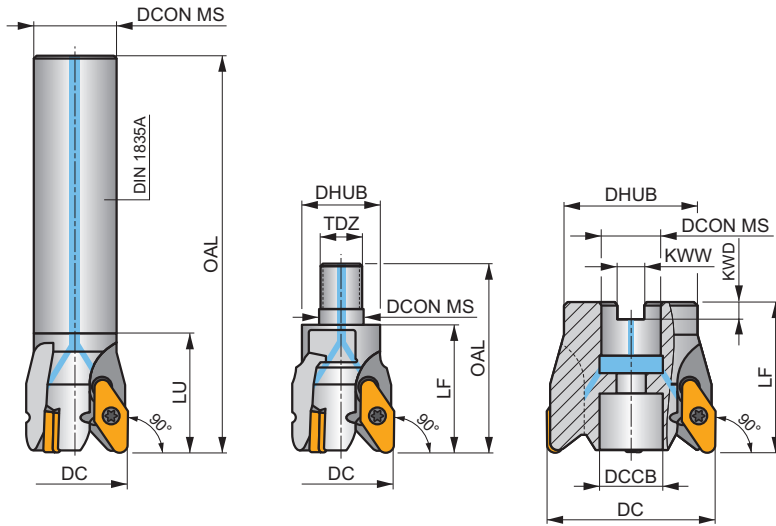
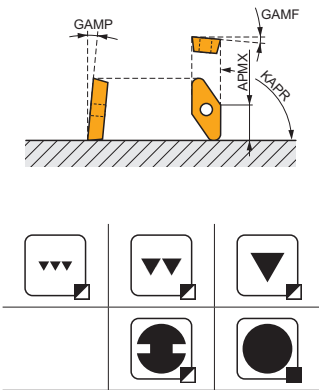

h_m	0.03 - 0.5					
h_m	0.03 - 0.55					

Produkt	DC	OAL	DCON MS	DCCB	LU	LF	DHUB	TDZ	KWW	KWD	GAMF	GAMP	max.		kg	C0560 C0562 C0563		
	(mm)	(mm)	(mm)	(mm)	(mm)	(mm)	(mm)	(mm)	(mm)	(mm)	(°)	(°)						
32A2R045A25-SVC22C	32	120	25	-	45	-	-	-	-	-	4	3	-	10400	✓	0.46	GI141 C0560	
40A3R045A32-SVC22C	40	150	32	-	45	-	-	-	-	-	8	3	-	9300	✓	0.91	GI141 C0560	
32A2R048M16-SVC22C	32	71	17	-	-	48	29	M16	-	-	11	3	2	-	✓	0.17	GI141 C0560	
40A3R048M16-SVC22C	40	71	17	-	-	48	29	M16	-	-	13	3	3	-	✓	0.24	GI141 C0560	
50A03R-S90VC22C	50	-	22	18	-	56	40	-	10	6.3	4	3	3	-	8400	✓	0.42	GI141 C0563
63A04R-S90VC22C	63	-	22	18	-	56	50	-	10	6.3	6	3	4	-	7400	✓	0.68	GI141 C0563
80A05R-S90VC22C	80	-	27	20	-	56	63	-	12	7	8	3	5	-	6600	✓	1.12	GI141 C0562

GI141	VCGT 220530F-FA
-------	-----------------

C0560	US 4511-T20	5.0	M 4.5	11	-	-	Flag T20
C0562	US 4511-T20	5.0	M 4.5	11	SDR T20-T	-	-
C0563	US 4511-T20	5.0	M 4.5	11	SDR T20-T	HS 1030C	-

VCGT 22-FA



	IC	D1	L	S
	(mm)	(mm)	(mm)	(mm)
2205	12.700	5.20	22.00	5.50

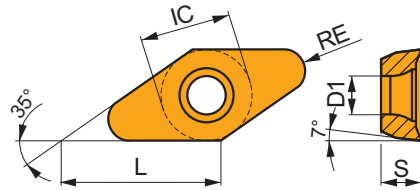

Eignung und Startwerte für Schnittgeschwindigkeit (vc), Vorschub (f) und Schnitttiefe (ap). Weitere Informationen finden Sie in unserer Zerspanungsrechner-App.

Produkt	RE (mm)	P			M			K			N			S			H		
		vc (m/min)	f (mm/tooth)	ap (mm)	vc (m/min)	f (mm/tooth)	ap (mm)	vc (m/min)	f (mm/tooth)	ap (mm)	vc (m/min)	f (mm/tooth)	ap (mm)	vc (m/min)	f (mm/tooth)	ap (mm)	vc (m/min)	f (mm/tooth)	ap (mm)

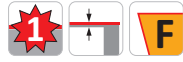
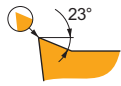

FA geometrie mit hoch positiven Design für die mittlere Bearbeitung bis zum Schruppen

VCGT 220515F-FA:HF7	● 1.5	–	–	–	–	–	–	–	–	–	■ 255	0.24	0.4	–	–	–	–	–	–
VCGT 220520F-FA:HF7	● 2.0	–	–	–	–	–	–	–	–	–	■ 255	0.30	0.5	–	–	–	–	–	–
VCGT 220530F-FA:HF7	● 3.0	–	–	–	–	–	–	–	–	–	■ 210	0.48	1.0	–	–	–	–	–	–



a_e / DC	5%	10%	15%	20%	25%	30%	40%	50%	60%	70%	75%	80%	90%	100%
	1.48	1.35	1.27	1.22	1.19	1.16	1.11	1.08	1.05	1.03	1.00	1.00	1.00	1.00
	2.20	1.60	1.35	1.20	1.10	0.95	0.85	0.75	0.85	0.95	1.00	1.00	1.00	1.00
	0.64	0.64	0.64	0.64	0.64	0.65	0.65	0.67	0.68	0.71	0.72	0.74	0.79	1.00

VCGT 22-FA			
	1.5	2.0	3.0
	-	-	-

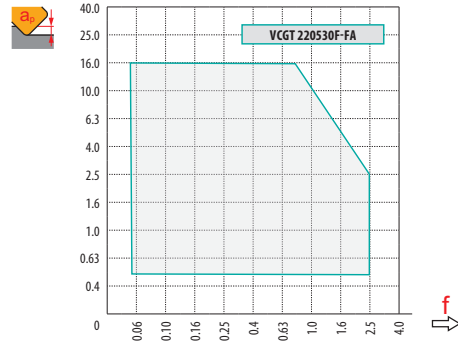

a_e	0.5	3.0	12.0
f	0.86	0.31	0.05

DC	RPMX	APMX/II
32	8.0	12.0/87
40	8.0	12.0/87
50	6.0	10.4/100
63	4.2	7.2/100
80	3.1	5.3/100

DC	DMIN	DMAX	DMIN	DMAX
32	42.0	64.0	4.2	12.0
40	58.0	80.0	7.7	12.0
50	78.0	100.0	9.0	12.0
63	104.0	126.0	9.3	12.0
80	138.0	160.0	9.7	12.0

a_e	9
f	

DC	μm	3	5	10	15	20	30	40	50	60	80	100
32		0.620	0.800	1.131	1.386	1.600	1.960	2.263	2.530	2.771	3.200	3.578
40		0.693	0.894	1.265	1.549	1.789	2.191	2.530	2.828	3.098	3.578	4.000
50		0.775	1.000	1.414	1.732	2.000	2.449	2.828	3.162	3.464	4.000	4.472
63		0.869	1.122	1.587	1.944	2.245	2.750	3.175	3.550	3.888	4.490	5.020
80		0.980	1.265	1.789	2.191	2.530	3.098	3.578	4.000	4.382	5.060	5.657
RE	μm	3	5	10	15	20	30	40	50	60	80	100
3.0		0.268	0.346	0.490	0.600	0.693	0.849	0.980	1.095	1.200	1.386	1.549

SCN05C

P **K** **H**

PRAMET

S



Fräser für Anwendungen im Werkzeug- und Formenbau mit Innenkühlung

Fräser für ein breites Anwendungsspektrum im Schlichtbereich für den Werkzeug- und Formenbau mit APMX von 0.5 mm. Hochpräzise geschliffene doppelseitige CNHX 05-Wendeschneidplatten mit 4 Schneidkanten sorgen für hohe Genauigkeit und Wirtschaftlichkeit. Erhältlich in zylindrischer und modularer Ausführung. Körper für längere Standzeiten oberflächenbehandelt.

KAPR	90° (93°)
APMX	0.5 (1.0 mm)

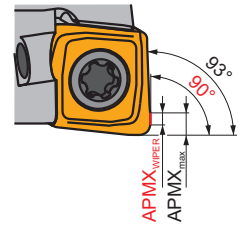
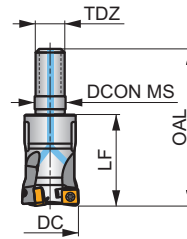
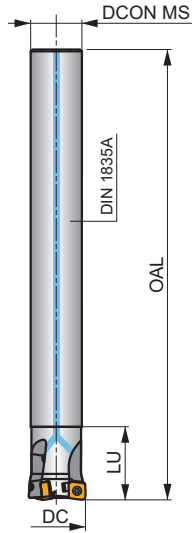
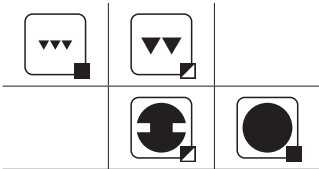
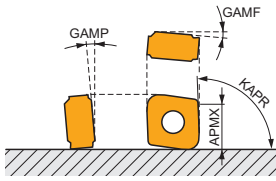

h_m 0.02 - 0.07



Produkt	DC (mm)	OAL (mm)	DCON MS (mm)	LU (mm)	LF (mm)	TDZ	GAMF (°)	GAMP (°)					kg		
12A2R020A10-SCN05C-C	12	100	10	20	-	-	-15	-8	2	-	48700	✓	0.08	GI330	C0601
16A3R020A14-SCN05C-C	16	130	14	20	-	-	-13.5	-7.8	3	-	42200	✓	0.16	GI330	C0601
20A5R020A18-SCN05C-C	20	160	18	20	-	-	-12.7	-7.5	5	✓	37700	✓	0.31	GI330	C0601
12A2R020M06-SCN05C-C	12	35	6.5	-	20	M6	-15	-8	2	-	-	✓	0.04	GI330	C0601
16A3R025M08-SCN05C-C	16	43	8.5	-	25	M8	-13.5	-7.8	3	-	-	✓	0.05	GI330	C0601
20A5R030M10-SCN05C-C	20	49	10.5	-	30	M10	-12.7	-7.5	5	✓	-	✓	0.08	GI330	C0601

	GI330		CNHX0502..
--	-------	--	------------

	C0601		US 62005-T06P		0.9		M 2		4.9		Flag T06P
--	-------	--	---------------	--	-----	--	-----	--	-----	--	-----------

CNHX 05



	IC	D1	S
	(mm)	(mm)	(mm)
0502	4.800	2.10	2.40

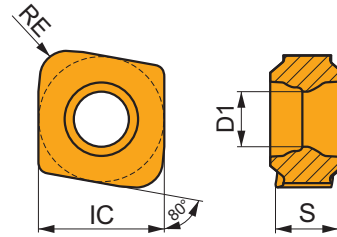

Eignung und Startwerte für Schnittgeschwindigkeit (vc), Vorschub (f) und Schnitttiefe (ap). Weitere Informationen finden Sie in unserer Zerspanungsrechner-App.

Produkt	RE (mm)	P			M			K			N			S			H		
		vc (m/min)	f (mm/tooth)	ap (mm)	vc (m/min)	f (mm/tooth)	ap (mm)	vc (m/min)	f (mm/tooth)	ap (mm)	vc (m/min)	f (mm/tooth)	ap (mm)	vc (m/min)	f (mm/tooth)	ap (mm)	vc (m/min)	f (mm/tooth)	ap (mm)

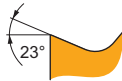
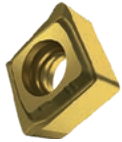

WM Wiper-geometrie zum Vorschlichten bis Schlichten.

CNHX 050205ER-WM:M4310	●	0.5	350	0.10	0.5	–	–	–	335	0.10	0.5	–	–	–	–	–	–	–	70	0.10	0.5
CNHX 050205ER-WM:M8330	⊕	0.5	310	0.10	0.5	–	–	–	290	0.10	0.5	–	–	–	–	–	–	–	60	0.10	0.5
CNHX 050210ER-WM:M4310	⊕	1.0	440	0.10	0.5	–	–	–	420	0.10	0.5	–	–	–	–	–	–	–	85	0.10	0.5
CNHX 050210ER-WM:M8330	⊕	1.0	390	0.10	0.5	–	–	–	370	0.10	0.5	–	–	–	–	–	–	–	75	0.10	0.5



a_e / DC	5 %	10 %	15 %	20 %	25 %	30 %	40 %	50 %	60 %	70 %	75 %	80 %	90 %	100 %
$X.V$	1.48	1.35	1.27	1.22	1.19	1.16	1.11	1.08	1.05	1.03	1.00	1.00	1.00	1.00



a_e / DC	0.5 %	1.0 %	2.0 %	3.0 %	4.0 %	5.0 %
$X.V$	2.04	1.85	1.68	1.59	1.53	1.48



CNHX 05-WM

RE	0.5	1.0
BS	0.50	0.50

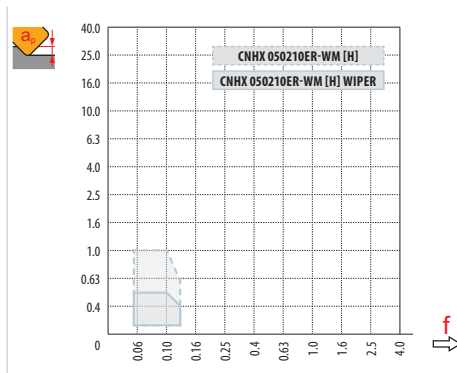
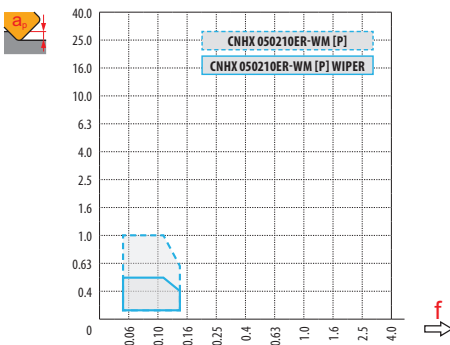

DC	max
12	0.4
16	0.4
20	0.5



DC	RPMX	APMX/1
12	2.4	1/25
16	1.5	1/40
20	1.1	1/54

SWN04C

P **K** **H**

PRAMET

S



Fräser für Anwendungen im Werkzeug- und Formenbau mit Innenkühlung

Fräser für ein breites Anwendungsspektrum im Schlichtbereich für den Werkzeug- und Formenbau mit APMX von 0.5 mm. Hochpräzise geschliffene WNHX 04-Wendeschneidplatten mit 6 Schneidkanten sorgen für hohe Genauigkeit und Wirtschaftlichkeit. Erhältlich in zylindrischer und modularer Ausführung. Körper für längere Standzeiten oberflächenbehandelt.

KAPR	90° (93°)
APMX	0.5 (2.0 mm)

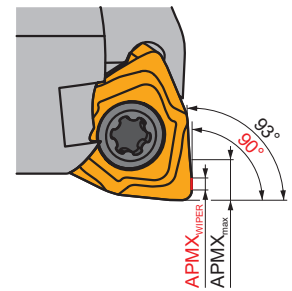
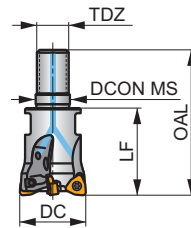
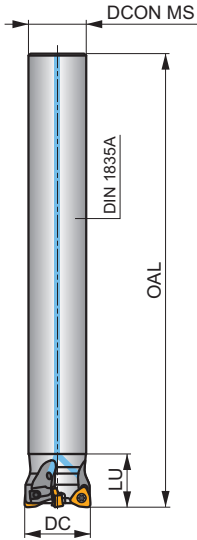
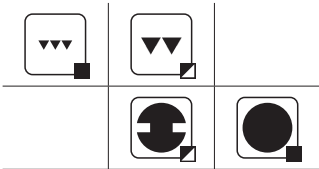
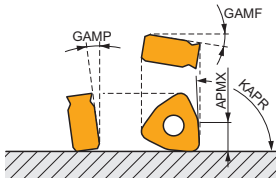

h_m 0.02 - 0.07



Produkt	DC	OAL	DCON MS	LU	LF	TDZ	GAMF	GAMP	Flute Design		max.	Hand	kg	Material	
	(mm)	(mm)	(mm)	(mm)	(mm)		(°)	(°)							
16A2R020A14-SWN04C-C	16	140	14	20	-	-	-13.5	-8	2	-	33200	✓	0.14	GI331	C0602
20A3R020A18-SWN04C-C	20	160	18	20	-	-	-12	-8	3	-	19700	✓	0.27	GI331	C0602
25A4R020A22-SWN04C-C	25	180	22	20	-	-	-11.5	-8	4	✓	26600	✓	0.45	GI331	C0602
32A6R020A25-SWN04C-C	32	200	25	20	-	-	-11.2	-8	6	✓	23500	✓	0.69	GI331	C0602
16A2R025M08-SWN04C-C	16	43	8.5	-	25	M08	-13.5	-8	2	-	33200	✓	0.05	GI331	C0602
20A3R030M10-SWN04C-C	20	49	10.5	-	30	M10	-12	-8	3	-	-	✓	0.07	GI331	C0602
25A4R033M12-SWN04C-C	25	55	12.5	-	33	M12	-11.5	-8	4	✓	-	✓	0.10	GI331	C0602
32A6R040M16-SWN04C-C	32	63	17	-	40	M16	-11.2	-8	6	✓	-	✓	0.21	GI331	C0602
35A6R043M16-SWN04C-C	35	66	17	-	43	M16	-11.1	-8	6	✓	-	✓	0.22	GI331	C0602

GI331	WNHX0403..
-------	------------

C0602	US 42507-T07P	1.2 Nm	M 2.5	7	Flag T07P
-------	---------------	--------	-------	---	-----------

WNHX 04



	IC	D1	S
	(mm)	(mm)	(mm)
0403	6.200	2.60	3.38

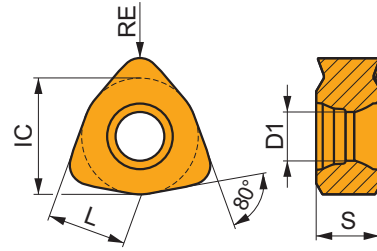

Eignung und Startwerte für Schnittgeschwindigkeit (vc), Vorschub (f) und Schnitttiefe (ap). Weitere Informationen finden Sie in unserer Zerspanungsrechner-App.

Produkt	RE (mm)	P			M			K			N			S			H		
		vc	f	ap	vc	f	ap	vc	f	ap	vc	f	ap	vc	f	ap	vc	f	ap
		(m/min)	(mm/tooth)	(mm)	(m/min)	(mm/tooth)	(mm)	(m/min)	(mm/tooth)	(mm)	(m/min)	(mm/tooth)	(mm)	(m/min)	(mm/tooth)	(mm)	(m/min)	(mm/tooth)	(mm)

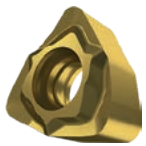

WM Wiper-geometrie zum Vorschlichten bis Schlichten.

WNHX 040305ER-WM:M4310	●	0.5	✓	290	0.15	1.0	–	–	–	■	275	0.15	1.0	–	–	–	–	–	–	■	55	0.10	0.7
WNHX 040305ER-WM:M8330	⊕	0.5	■	260	0.15	1.0	–	–	–	■	245	0.15	1.0	–	–	–	–	–	–	■	50	0.10	0.7
WNHX 040310ER-WM:M4310	⊕	1.0	✓	370	0.15	1.0	–	–	–	■	350	0.15	1.0	–	–	–	–	–	–	■	70	0.10	0.7
WNHX 040310ER-WM:M8330	⊕	1.0	■	330	0.15	1.0	–	–	–	■	310	0.15	1.0	–	–	–	–	–	–	■	65	0.10	0.7
WNHX 040315ER-WM:M4310	⊕	1.5	✓	390	0.15	1.0	–	–	–	■	370	0.15	1.0	–	–	–	–	–	–	■	75	0.10	0.7
WNHX 040315ER-WM:M8330	⊕	1.5	■	345	0.15	1.0	–	–	–	■	325	0.15	1.0	–	–	–	–	–	–	■	65	0.10	0.7



a_e / DC	5 %	10 %	15 %	20 %	25 %	30 %	40 %	50 %	60 %	70 %	75 %	80 %	90 %	100 %
$x.v$	1.48	1.35	1.27	1.22	1.19	1.16	1.11	1.08	1.05	1.03	1.00	1.00	1.00	1.00



a_e / DC	0.5 %	1.0 %	2.0 %	3.0 %	4.0 %	5.0 %
$x.v$	2.04	1.85	1.68	1.59	1.53	1.48

	WNHX 04-WM		
RE	0.5	1.0	1.5
BS	0.50	0.50	0.50

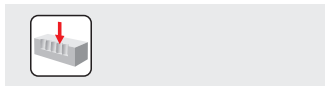
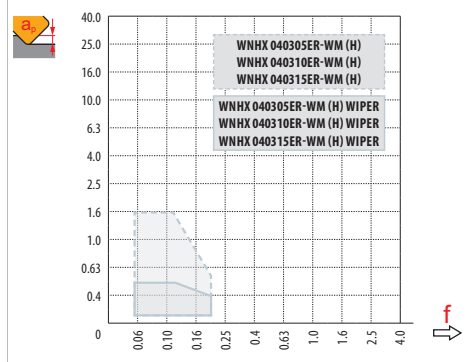
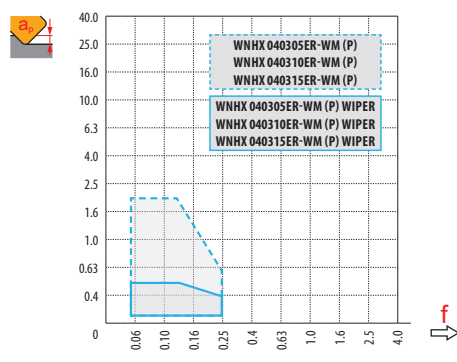

DC	max
16	
20	0.4
25	0.5
32	0.5
35	0.5

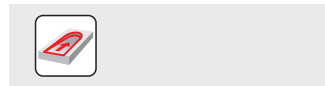















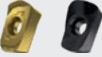

DC	RPMX	APMX/I
16		
20	0.7	1.1/100
25	0.5	0.75/100
32	0.3	0.4/100
35	0.3	0.4/100



FRÄSEN MIT HOHEM VORSCHUB

WENDEPLATTENFRÄSER – AUSWAHLHILFE

PLANFRÄSEN

	SBN10		SSN11				
	20°		18°				
	APMX (mm)	1.0	APMX (mm)	1.7			
	DCX (mm)	16 – 66	DCX (mm)	32 – 125			
Zylindrischer Schaft		DCX = 16 – 35 (mm)		DCX = 32, 35 (mm)			
Weldon							
Modular		DCX = 16 – 40 (mm)		DCX = 32 – 40 (mm)			
Aufsteckfräser		DCX = 40 – 66 (mm)		DCX = 40 – 125 (mm)			
Seite	📖 252		📖 258				
ISO	P M K S H		P M K S H				
Schneidplattenform							
Wendeschneidplatten	BNGX 10T3 ANHX 10T3		SNGX 1104				
Anzahl der Schneiden	4/2		8				
Planfräsen		■	■				
Schraubenlinien- interpolation		■	▣				
Flaches Eckfräsen		■	■				
Tauchfräsen		■	■				
Progressives Tauchfräsen		■	▣				
Rampen		■	▣				
Fräsen geformter Flächen (Kopierfräsen)		■	■				
Flaches Nutfräsen		▣	▣				

SBN10



PRAMET



Hochvorschubfräser für BN.. 10 Wendeschneidplatten mit Innenkühlung

Hochvorschubfräser für kleinere Durchmesser mit doppelseitigen BNGX 10-Wendeschneidplatten mit vier Schneidkanten und einem APMX von 1 mm. Innenkühlung. Geeignet für eine Vielzahl von Anwendungen. Erhältlich mit zylindrischen, modularen Schaft und als Aufsteckfräser. Körper für längere Standzeiten oberflächenbehandelt.

KAPR	20° (29°)
APMX	1.0 mm

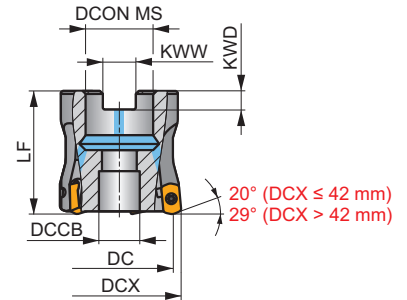
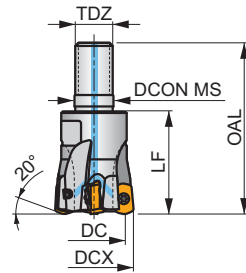
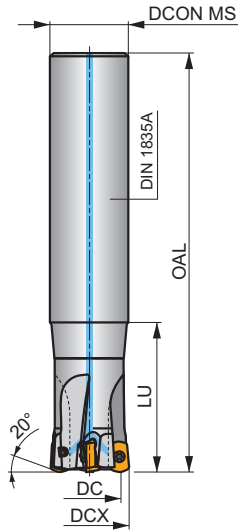
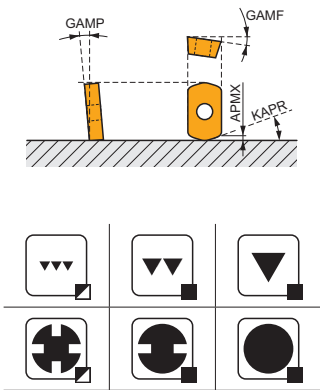

	0.17 - 0.41
	0.17 - 0.41



Produkt	DCX	DC	OAL	DCON MS	DCCB	LU	LF	TDZ	KWW	KWD	KAPR	GAMP	GAMP	max.	kg	G1329	C0310	
																		(mm)
16E2R030A16-SBN10-C	16	9.4	100	16	-	30	-	-	-	-	20	-12	-10	2	✓	31100	✓	0.13
16E2R050A16-SBN10-C	16	9.4	150	16	-	50	-	-	-	-	20	-12	-10	2	-	31100	✓	0.18
16E2R030A14-SBN10-C	16	9.4	150	14	-	30	-	-	-	-	20	-12	-10	2	-	31100	✓	0.18
18E2R030A16-SBN10-C	18	11.4	150	16	-	30	-	-	-	-	20	-11	-10	2	-	29200	✓	0.23
20E3R040A20-SBN10-C	20	13.4	130	20	-	40	-	-	-	-	20	-10	-10	3	-	27700	✓	0.25
20E3R080A20-SBN10-C	20	13.4	160	20	-	80	-	-	-	-	20	-10	-10	3	-	27700	✓	0.29
20E3R040A18-SBN10-C	20	13.4	180	18	-	40	-	-	-	-	20	-10	-10	3	-	27700	✓	0.29
20E4R040A20-SBN10-C	20	13.4	130	20	-	40	-	-	-	-	20	-10	-10	4	-	27700	✓	0.28
25E4R050A25-SBN10-C	25	18.4	140	25	-	50	-	-	-	-	20	-9	-10	4	✓	24800	✓	0.42
25E4R100A25-SBN10-C	25	18.4	180	25	-	100	-	-	-	-	20	-9	-10	4	✓	24800	✓	0.51
25E4R050A22-SBN10-C	25	18.4	220	22	-	50	-	-	-	-	20	-9	-10	4	✓	24800	✓	0.58
25E5R050A25-SBN10-C	25	18.4	140	25	-	50	-	-	-	-	20	-9	-10	5	-	24800	✓	0.42
32E5R070A32-SBN10-C	32	25.4	150	32	-	70	-	-	-	-	20	-8	-10	5	✓	21900	✓	0.73
32E6R070A32-SBN10-C	32	25.4	150	32	-	70	-	-	-	-	20	-8	-10	6	✓	21900	✓	0.76
32E5R120A32-SBN10-C	32	25.4	200	32	-	120	-	-	-	-	20	-8	-10	5	✓	21900	✓	0.96
35E5R050A32-SBN10-C	35	28.4	200	32	-	50	-	-	-	-	20	-7.5	-10	5	✓	21000	✓	1.08
35E6R050A32-SBN10-C	35	28.4	200	32	-	50	-	-	-	-	20	-7.5	-10	6	✓	21000	✓	1.08
16E2R025M08-SBN10-C	16	9.4	43	8.5	-	-	25	M8	-	-	20	-12	-10	2	-	31100	✓	0.05
18E2R025M08-SBN10-C	18	11.4	43	8.5	-	-	25	M8	-	-	20	-11	-10	2	-	29200	✓	0.05
20E3R030M10-SBN10-C	20	13.4	49	10.5	-	-	30	M10	-	-	20	-10	-10	3	-	27700	✓	0.07
20E4R030M10-SBN10-C	20	13.4	49	10.5	-	-	30	M10	-	-	20	-10	-10	4	-	27700	✓	0.06
25E4R033M12-SBN10-C	25	18.4	55	12.5	-	-	33	M12	-	-	20	-9	-10	4	✓	24800	✓	0.08
25E5R033M12-SBN10-C	25	18.4	55	12.5	-	-	33	M12	-	-	20	-9	-10	5	-	24800	✓	0.10
28E5R035M12-SBN10-C	28	21.4	57	12.5	-	-	35	M12	-	-	20	-8.5	-10	5	✓	23400	✓	0.12
32E5R040M16-SBN10-C	32	25.4	63	17	-	-	40	M16	-	-	20	-8	-10	5	✓	21900	✓	0.21
32E6R040M16-SBN10-C	32	25.4	63	17	-	-	40	M16	-	-	20	-8	-10	6	✓	21900	✓	0.21
35E6R043M16-SBN10-C	35	28.4	66	17	-	-	43	M16	-	-	20	-7.5	-10	6	✓	21000	✓	0.23

Produkt	DCX	DC	OAL	D CON MS	DCB	LU	LF	TDZ	KWW	KWD	KAPR	GAMF	GAMP							
	(mm)	(mm)	(mm)	(mm)	(mm)	(mm)	(mm)	(mm)	(mm)	(mm)	(°)	(°)	(°)							
40E6R043M16-SBN10-C	40	33.4	66	17	-	-	43	M16	-	-	20	-7	-10	6	✓	19600	✓	0.27	GI329	C0310
40E7R043M16-SBN10-C	40	33.4	66	17	-	-	43	M16	-	-	20	-7	-10	7	✓	19600	✓	0.26	GI329	C0310
40A05R-SMOBN10-C	40	33.4	-	16	14.1	-	40	-	8.4	5.6	20	-7	-10	5	✓	19600	✓	0.23	GI329	C0312
40A07R-SMOBN10-C	40	33.4	-	16	14.1	-	40	-	8.4	5.6	20	-7	-10	7	✓	19600	✓	0.27	GI329	C0312
42A05R-SMOBN10-C	42	35.4	-	16	14.1	-	40	-	8.4	5.6	20	-7	-10	5	✓	19100	✓	0.23	GI329	C0312
42A07R-SMOBN10-C	42	35.4	-	16	14.1	-	40	-	8.4	5.6	20	-7	-10	7	✓	19100	✓	0.36	GI329	C0312
50A07R-SMOBN10-C	50	45	-	22	18.1	-	40	-	10.4	6.3	29	-6	-7	7	✓	17500	✓	0.46	GI343	C0311
50A08R-SMOBN10-C	50	45	-	22	18.1	-	40	-	10.4	6.3	29	-6	-7	8	✓	17500	✓	0.34	GI343	C0311
52A07R-SMOBN10-C	52	47	-	22	18.1	-	40	-	10.4	6.3	29	-6	-7	7	✓	17200	✓	0.49	GI343	C0311
52A08R-SMOBN10-C	52	47	-	22	18.1	-	40	-	10.4	6.3	29	-6	-7	8	✓	17200	✓	0.37	GI343	C0311
66A08R-SMOBN10-C	66	61	-	27	22.1	-	50	-	12.4	7	29	-6	-7	8	✓	15200	✓	0.89	GI343	C0313

GI329		BNGX 10T3...	ANHX 10T3..
GI343		BNGX 10T3...	-

C0310	US 42507-T07P	1.2	M 2.5	7	Flag T07P	-	-	-	-
C0313	US 42507-T07P	1.2	M 2.5	7	-	D-T07P/T09P	FG-15	HS 1230C	-
C0312	US 42507-T07P	1.2	M 2.5	7	-	D-T07P/T09P	FG-15	HS 0830C	-
C0311	US 42507-T07P	1.2	M 2.5	7	-	D-T07P/T09P	FG-15	HS 1030C	-

BNGX 10



	W1	D1	L	S
	(mm)	(mm)	(mm)	(mm)
10T3	5.800	2.76	9.92	3.90

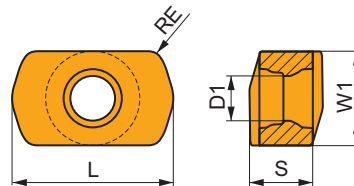

Eignung und Startwerte für Schnittgeschwindigkeit (vc), Vorschub (f) und Schnitttiefe (ap). Weitere Informationen finden Sie in unserer Zerspanungsrechner-App.

Produkt	RE (mm)	P			M			K			N			S			H		
		vc	f	ap	vc	f	ap	vc	f	ap	vc	f	ap	vc	f	ap	vc	f	ap
	(mm)	(m/min)	(mm/tooth)	(mm)	(m/min)	(mm/tooth)	(mm)	(m/min)	(mm/tooth)	(mm)	(m/min)	(mm/tooth)	(mm)	(m/min)	(mm/tooth)	(mm)	(m/min)	(mm/tooth)	(mm)

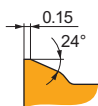

M geometrie mit sehr positiven Design für die Bearbeitung mit hohen Vorschub.

BNGX 10T308SR-M:8215	0.8	240	0.65	0.7	-	-	-	225	0.65	0.7	-	-	-	-	-	-	45	0.36	0.5
BNGX 10T308SR-M:M6330	0.8	210	0.65	0.7	-	-	-	-	-	-	-	-	-	-	-	-	-	-	-
BNGX 10T308SR-M:M8310	0.8	250	0.65	0.7	-	-	-	235	0.65	0.7	-	-	-	-	-	-	50	0.36	0.5
BNGX 10T308SR-M:M8330	0.8	240	0.65	0.7	-	-	-	225	0.65	0.7	-	-	-	-	-	-	45	0.36	0.5
BNGX 10T308SR-M:M8340	0.8	225	0.65	0.7	-	-	-	210	0.65	0.7	-	-	-	-	-	-	-	-	-
BNGX 10T308SR-M:M8345	0.8	180	0.65	0.7	-	-	-	-	-	-	-	-	-	-	-	-	-	-	-
BNGX 10T308SR-M:M9325	0.8	275	0.65	0.7	-	-	-	260	0.65	0.7	-	-	-	-	-	-	55	0.36	0.5

Eignung und Startwerte für Schnittgeschwindigkeit (vc), Vorschub (f) und Schnitttiefe (ap). Weitere Informationen finden Sie in unserer Zerspanungsrechner-App.

Produkt	RE (mm)	P			M			K			N			S			H		
		vc (m/min)	f (mm/tooth)	ap (mm)	vc (m/min)	f (mm/tooth)	ap (mm)	vc (m/min)	f (mm/tooth)	ap (mm)	vc (m/min)	f (mm/tooth)	ap (mm)	vc (m/min)	f (mm/tooth)	ap (mm)	vc (m/min)	f (mm/tooth)	ap (mm)

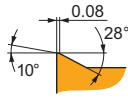
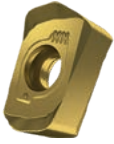

MM geometrie mit sehr positiven Design für die Bearbeitung mit hohem Vorschub.

BNGX 10T308SR-MM:M6330	0.8	215	0.65	0.6	150	0.59	0.6	-	-	-	-	-	60	0.46	0.5	-	-	-
BNGX 10T308SR-MM:M8310	0.8	255	0.65	0.6	130	0.59	0.6	-	-	-	-	-	-	-	-	-	-	-
BNGX 10T308SR-MM:M8330	0.8	245	0.65	0.6	145	0.59	0.6	-	-	-	-	-	60	0.46	0.5	-	-	-
BNGX 10T308SR-MM:M8340	0.8	230	0.65	0.6	135	0.59	0.6	-	-	-	-	-	55	0.46	0.5	-	-	-
BNGX 10T308SR-MM:M8345	0.8	180	0.65	0.6	105	0.59	0.6	-	-	-	-	-	45	0.46	0.5	-	-	-
BNGX 10T308SR-MM:M9325	0.8	280	0.65	0.6	-	-	-	-	-	-	-	-	-	-	-	-	-	-
BNGX 10T308SR-MM:M9340	0.8	250	0.65	0.6	150	0.59	0.6	-	-	-	-	-	60	0.46	0.5	-	-	-

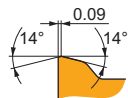

HM geometrie mit starken Design zur Bearbeitung mit hohem Vorschub.

BNGX 10T308SR-HM:8215	0.8	-	-	-	-	-	-	240	0.65	0.4	-	-	-	-	-	50	0.65	0.4
BNGX 10T308SR-HM:M8310	0.8	-	-	-	-	-	-	250	0.65	0.4	-	-	-	-	-	50	0.65	0.4
BNGX 10T308SR-HM:M8330	0.8	-	-	-	-	-	-	240	0.65	0.4	-	-	-	-	-	50	0.65	0.4

ANHX 10



	W1 (mm)	D1 (mm)	L (mm)	S (mm)
10T3	5.800	2.76	9.72	4.70

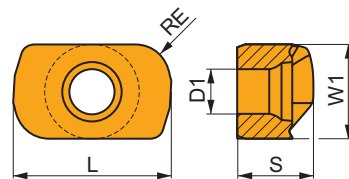

Eignung und Startwerte für Schnittgeschwindigkeit (vc), Vorschub (f) und Schnitttiefe (ap). Weitere Informationen finden Sie in unserer Zerspanungsrechner-App.

Produkt	RE (mm)	P			M			K			N			S			H		
		vc (m/min)	f (mm/tooth)	ap (mm)	vc (m/min)	f (mm/tooth)	ap (mm)	vc (m/min)	f (mm/tooth)	ap (mm)	vc (m/min)	f (mm/tooth)	ap (mm)	vc (m/min)	f (mm/tooth)	ap (mm)	vc (m/min)	f (mm/tooth)	ap (mm)

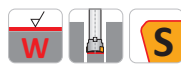
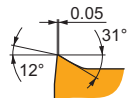
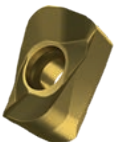

F geometrie mit positiven Design zum Schlichten bis Vorschlichten.

ANHX 10T320SR-F:M8310	2.0	380	0.10	2.5	190	0.09	2.5	-	-	-	-	-	-	-	-	-	-	-
ANHX 10T320SR-F:M8330	2.0	340	0.10	2.5	200	0.09	2.5	-	-	-	-	-	-	-	-	-	-	-



a_e / DCX	5 %	10 %	15 %	20 %	25 %	30 %	40 %	50 %	60 %	70 %	75 %	80 %	90 %	100 %
	1.48	1.35	1.27	1.22	1.19	1.16	1.11	1.08	1.05	1.03	1.00	1.00	1.00	1.00
	2.20	1.60	1.35	1.20	1.10	0.95	0.85	0.75	0.85	0.95	1.00	1.00	1.00	1.00
	0.64	0.64	0.64	0.64	0.64	0.65	0.65	0.67	0.68	0.71	0.72	0.74	0.79	1.00

	BNGX 10-M	BNGX 10-MM	BNGX 10-HM		ANHX 10-F
	0.8	0.8	0.8		2.0
	—	—	—		0.92

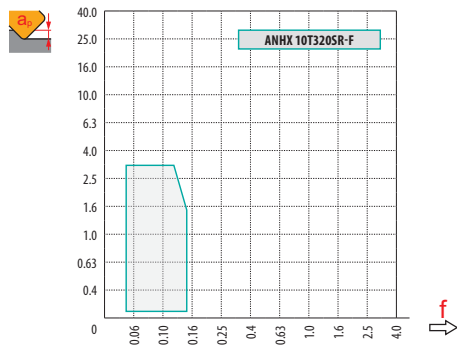
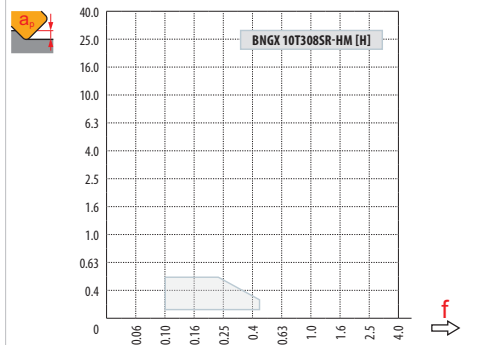
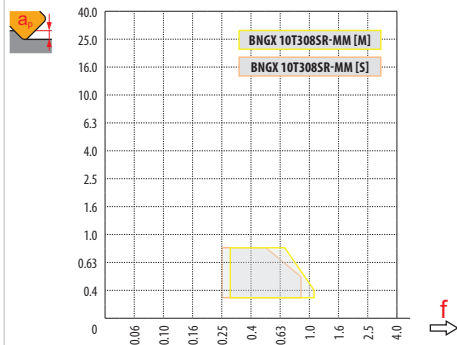
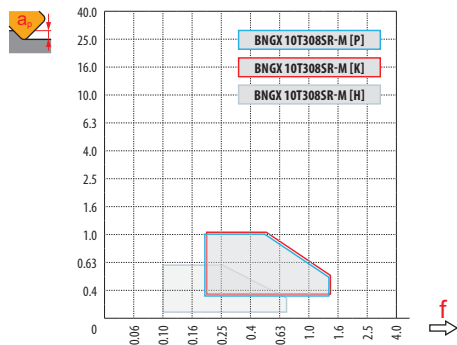

BNGX 10 (HFC)

		0.00	0.30	0.40	0.50	0.60	0.70	0.80	0.90	1.00
16		9.40	12.85	13.36	13.80	14.20	14.56	14.88	15.19	15.47
18		11.40	14.85	15.36	15.80	16.20	16.56	16.88	17.19	17.47
20		13.40	16.85	17.36	17.80	18.20	18.56	18.88	19.19	19.47
25		18.40	21.85	22.36	22.80	23.20	23.56	23.88	24.19	24.47
32		25.40	28.85	29.36	29.80	30.20	30.56	30.88	31.19	31.47
35		28.40	31.85	32.36	32.80	33.20	33.56	33.88	34.19	34.47
40		33.40	36.85	37.36	37.80	38.20	38.56	38.88	39.19	39.47
42		35.40	38.85	39.36	39.80	40.20	40.56	40.88	41.19	41.47
50		43.98	46.09	46.45	46.82	47.18	47.54	47.90	48.26	48.56
52		45.98	48.09	48.45	48.82	49.18	49.54	49.90	50.26	50.56
66		59.98	62.09	62.45	62.82	63.18	63.54	63.90	64.26	64.56
		0.00	0.30	0.40	0.50	0.60	0.70	0.80	0.90	1.00
		–	1.30	1.10	0.90	0.80	0.72	0.68	0.65	0.50

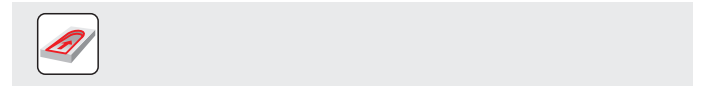
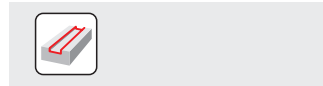
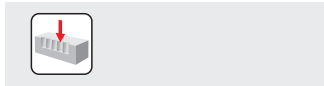

BNGX 10

		f_{max}
16	3.5	0.12
18	3.5	0.12
20	4.0	0.15
25	4.0	0.15
32	4.0	0.17
35	4.0	0.17
40	4.0	0.17
42	4.0	0.17
50	4.5	0.30
52	4.5	0.30
66	4.5	0.30

BNGX 10 (HFC)

	0.3	0.6	1.0
	1.10	0.60	0.30

	BNGX 10 (HFC)		ANHX 10	
	RPMX	APMX/I	RPMX	APMX/I
16	3.8	1/17	1.6°	2.65/100
18	3.8	1/17	1.3°	2.15/100
20	3.8	1/17	1.1°	1.80/100
25	2.6	1/24	0.8°	1.25/100
32	1.8	1/33	0.5°	0.75/100
35	1.6	1/37	0.5°	0.75/100
40	1.3	1/46	0.4°	0.55/100
42	1.3	1/46	0.4°	0.55/100
50	0.4	0.55/100	–	–
52	0.4	0.55/100	–	–
66	0.3	0.4/100	–	–

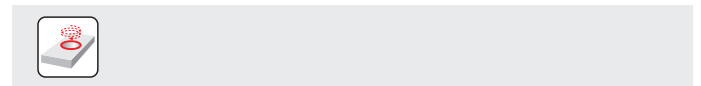
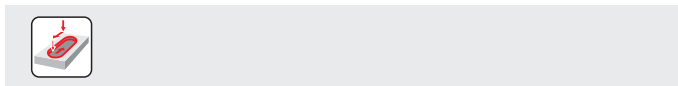

BNGX 10 (HFC)

		f_{max}
16	0.4	0.15
18	0.7	0.15
20	0.7	0.15
25	0.7	0.15
32	0.7	0.2
35	0.7	0.2
40	0.7	0.2
42	0.7	0.2
50	0.3	0.2
52	0.3	0.2
66	0.3	0.2

BNGX 10 (HFC)

	DMIN	DMAX		
16	22.4	31.8	0.5	0.5
18	25.4	35.8	0.5	0.5
20	29.4	39.8	0.5	0.5
25	39.4	49.8	0.5	0.5
32	53.4	63.8	0.5	0.5
35	59.4	69.8	0.5	0.5
40	69.4	79.8	0.5	0.5
42	73.4	83.8	0.5	0.5
50	89.6	99.6	0.5	0.5
52	93.6	103.6	0.5	0.5
66	121.6	131.6	0.5	0.5



	μm	3	5	10	15	20	30	40	50	60	80	100
16		0.438	0.566	0.800	0.980	1.131	1.386	1.600	1.789	1.960	2.263	2.530
18		0.465	0.600	0.849	1.039	1.200	1.470	1.697	1.897	2.078	2.400	2.683
20		0.490	0.632	0.894	1.095	1.265	1.549	1.789	2.000	2.191	2.530	2.828
25		0.548	0.707	1.000	1.225	1.414	1.732	2.000	2.236	2.449	2.828	3.162
32		0.620	0.800	1.131	1.386	1.600	1.960	2.263	2.530	2.771	3.200	3.578
35		0.648	0.837	1.183	1.449	1.673	2.049	2.366	2.646	2.898	3.347	3.742
40		0.693	0.894	1.265	1.549	1.789	2.191	2.530	2.828	3.098	3.578	4.000
42		0.710	0.917	1.296	1.587	1.833	2.245	2.592	2.898	3.175	3.666	4.099

ANHX 10

	μm	3	5	10	15	20	30	40	50	60	80	100
2.0		0.219	0.283	0.400	0.490	0.566	0.693	0.800	0.894	0.980	1.131	1.265

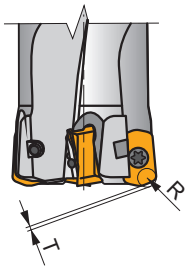

	R	T
BNGX 10T308	1.60	0.44

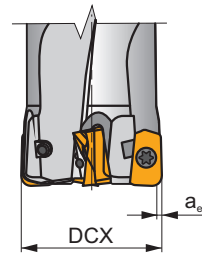

	max a _e /DCX
ANHX 10T320	0.05

SSN11

P M K S H

PRAMET

S



Hochvorschubfräser für SN.. 11 Wendeschneidplatten mit Innenkühlung

Hochvorschubfräser für größere Durchmesser mit doppelseitigen Wendeschneidplatten vom Typ SNGX 11 mit acht Schneidkanten und 1.7 mm APMX. Innenkühlung. Geeignet für eine Vielzahl von Anwendungen. Erhältlich mit zylindrischen, modularen Schaft, sowie als Aufsteckfräser. Für längere Standzeiten ist der Körper oberflächenbehandelt.

KAPR	18°
APMX	1.7 mm

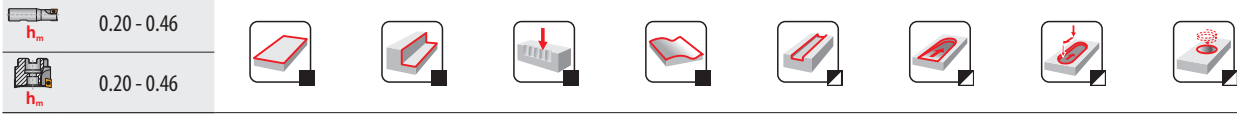
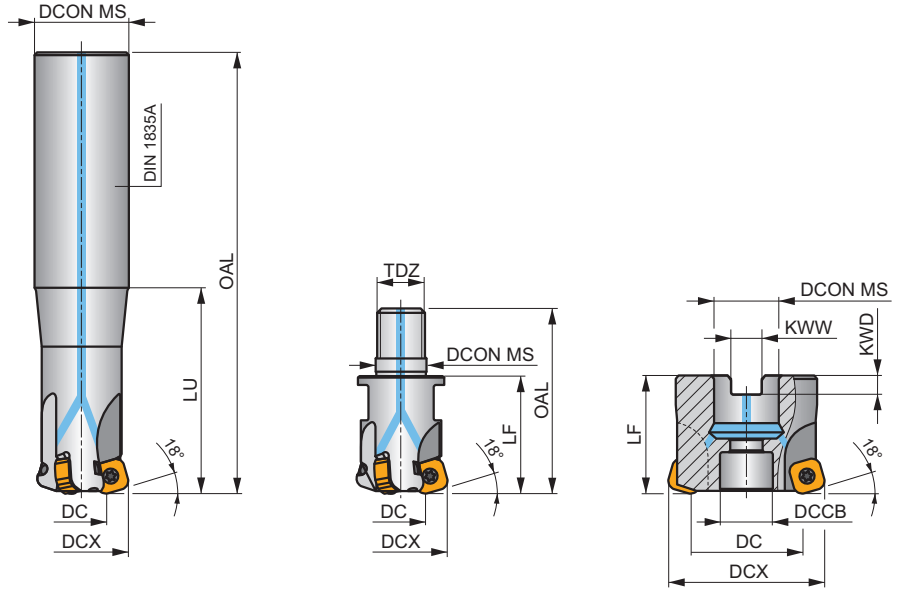
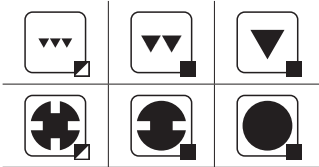
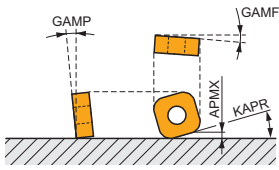

Produkt	DCX	DC	OAL	DCON MS	DCCB	LU	LF	TDZ	KWW	KWD	GAMF	GAMP	max.		kg	GI339	C0314	C0316	C0318	C0320	C0322	C0324	AC001	AC002	AC003
	(mm)	(mm)	(mm)	(mm)	(mm)	(mm)	(mm)	(mm)	(mm)	(mm)	(°)	(°)	max.	max.											
32E3R070A32-SSN11-C	32	18.3	150	32	-	70	-	-	-	-	-11.5	-10	3	-	17500	✓	0.69	GI339	C0314	-	-	-	-	-	-
32E3R120A32-SSN11-C	32	18.3	200	32	-	120	-	-	-	-	-11.5	-10	3	-	17500	✓	0.89	GI339	C0314	-	-	-	-	-	-
35E3R050A32-SSN11-C	35	21.2	200	32	-	50	-	-	-	-	-11	-10	3	-	16800	✓	1.08	GI339	C0314	-	-	-	-	-	-
32E3R040M16-SSN11-C	32	18.3	63	17	-	40	M16	-	-	-	-11.5	-10	3	-	17500	✓	0.19	GI339	C0314	-	-	-	-	-	-
35E3R040M16-SSN11-C	35	21.2	63	17	-	40	M16	-	-	-	-11	-10	3	-	16800	✓	0.19	GI339	C0314	-	-	-	-	-	-
40E4R043M16-SSN11-C	40	26.2	66	17	-	43	M16	-	-	-	-10.5	-10	4	✓	15700	✓	0.26	GI339	C0314	-	-	-	-	-	-
40A04R-SMOSN11-C	40	26.2	-	16	12.4	-	40	-	8.4	5.6	-10.5	-10	4	✓	15700	✓	0.19	GI339	C0316	-	-	-	-	-	-
42A04R-SMOSN11-C	42	28.2	-	16	14.1	-	40	-	8.4	5.6	-10.5	-10	4	✓	15300	✓	0.21	GI339	C0318	-	-	-	-	-	-
50A05R-SMOSN11-C	50	36.1	-	22	18.1	-	40	-	10.4	6.3	-10	-10	5	✓	14000	✓	0.31	GI339	C0320	-	-	-	-	-	-
50A06R-SMOSN11-C	50	36.1	-	22	18.1	-	40	-	10.4	6.3	-10	-10	6	✓	14000	✓	0.43	GI339	C0320	-	-	-	-	-	-
52A05R-SMOSN11-C	52	38.1	-	22	18.1	-	40	-	10.4	6.3	-10	-10	5	✓	13800	✓	0.47	GI339	C0320	-	-	-	-	-	-
52A06R-SMOSN11-C	52	38.1	-	22	18.1	-	40	-	10.4	6.3	-10	-10	6	✓	13800	✓	0.46	GI339	C0320	-	-	-	-	-	-
63A06R-SMOSN11-C	63	49.1	-	22	18.1	-	40	-	10.4	6.3	-10	-10	6	✓	12500	✓	0.46	GI339	C0320	-	-	-	-	-	-
63A08R-SMOSN11-C	63	49.1	-	22	18.1	-	40	-	10.4	6.3	-10	-10	8	✓	12500	✓	0.60	GI339	C0320	-	-	-	-	-	-
66A06R-SMOSN11-C	66	52.1	-	27	18.1	-	50	-	12.4	7	-10	-10	6	✓	12200	✓	0.88	GI339	C0322	-	-	-	-	-	-
66A08R-SMOSN11-C	66	52.1	-	27	18.1	-	50	-	12.4	7	-10	-10	8	✓	12200	✓	0.88	GI339	C0322	-	-	-	-	-	-
80A07R-SMOSN11-C	80	66.1	-	27	38.1	-	50	-	12.4	7	-10	-10	7	✓	11100	✓	0.95	GI339	C0324	AC001	-	-	-	-	-
80A09R-SMOSN11-C	80	66.1	-	27	38.1	-	50	-	12.4	7	-10	-10	9	✓	11100	✓	1.03	GI339	C0324	AC001	-	-	-	-	-
100A08R-SMOSN11-C	100	86.1	-	32	45.1	-	50	-	14.4	8	-10	-10	8	✓	9900	✓	1.83	GI339	C0324	AC002	-	-	-	-	-
115A08R-SMOSN11-C	115	101.1	-	32	45.1	-	50	-	14.4	8	-10	-10	8	✓	9200	✓	2.30	GI339	C0324	AC002	-	-	-	-	-
125A08R-SMOSN11-C	125	111.1	-	40	56.1	-	63	-	16.4	9	-10	-10	8	✓	8900	✓	3.34	GI339	C0324	AC003	-	-	-	-	-

C0314	US 44012-T15P	3.5	M 4	12	–	–	–	Flag T15P	–
C0316	US 44012-T15P	3.5	M 4	12	D-T08P/T15P	FG-15	–	–	HCS 0840C
C0318	US 44012-T15P	3.5	M 4	12	D-T08P/T15P	FG-15	–	–	HS 90835
C0320	US 44012-T15P	3.5	M 4	12	D-T08P/T15P	FG-15	–	–	HS 1030C
C0322	US 44012-T15P	3.5	M 4	12	D-T08P/T15P	FG-15	–	–	HS 1230C
C0324	US 44012-T15P	3.5	M 4	12	D-T08P/T15P	FG-15	–	–	–

AC001		KS 1230	K.FMH27
AC002		KS 1635	K.FMH32
AC003		KS 2040	K.FMH40

SNGX 11



	IC	D1	S
	(mm)	(mm)	(mm)
1104	10.600	4.56	4.76

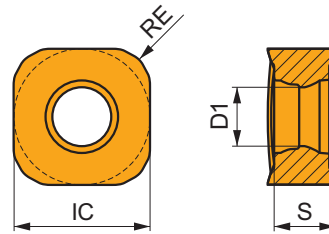

Eignung und Startwerte für Schnittgeschwindigkeit (vc), Vorschub (f) und Schnitttiefe (ap). Weitere Informationen finden Sie in unserer Zerspanungsrechner-App.

Produkt	RE (mm)	P			M			K			N			S			H		
		vc (m/min)	f (mm/tooth)	ap (mm)	vc (m/min)	f (mm/tooth)	ap (mm)	vc (m/min)	f (mm/tooth)	ap (mm)	vc (m/min)	f (mm/tooth)	ap (mm)	vc (m/min)	f (mm/tooth)	ap (mm)	vc (m/min)	f (mm/tooth)	ap (mm)

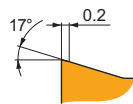

M geometrie mit positiver Ausführung für die Hochvorschub-Bearbeitung.

SNGX 110416SR-M:8215	✳ 1.6	260	0.60	1.0	–	–	–	245	0.60	1.0	–	–	–	–	–	–	–	–
SNGX 110416SR-M:M8310	✳ 1.6	275	0.60	1.0	–	–	–	260	0.60	1.0	–	–	–	–	–	–	–	–
SNGX 110416SR-M:M8330	✳ 1.6	260	0.60	1.0	–	–	–	245	0.60	1.0	–	–	–	–	–	–	–	–
SNGX 110416SR-M:M8340	✳ 1.6	245	0.60	1.0	–	–	–	230	0.60	1.0	–	–	–	–	–	–	–	–
SNGX 110416SR-M:M9325	✳ 1.6	305	0.60	1.0	–	–	–	285	0.60	1.0	–	–	–	–	–	–	–	–
SNGX 110416SR-M:M9340	✳ 1.6	270	0.60	1.0	–	–	–	–	–	–	–	–	–	–	–	–	–	–

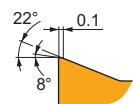

MM geometrie mit positiver Ausführung für die Hochvorschub-Bearbeitung.

SNGX 110416SR-MM:M6330	✳ 1.6	175	0.60	1.0	125	0.54	1.0	–	–	–	–	–	–	50	0.42	0.8	–	–	–
SNGX 110416SR-MM:M8340	✳ 1.6	190	0.60	1.0	110	0.54	1.0	–	–	–	–	–	–	45	0.42	0.8	–	–	–
SNGX 110416SR-MM:M8345	✳ 1.6	150	0.60	1.0	90	0.54	1.0	–	–	–	–	–	–	35	0.42	0.8	–	–	–
SNGX 110416SR-MM:M9340	✳ 1.6	210	0.60	1.0	125	0.54	1.0	–	–	–	–	–	–	50	0.42	0.8	–	–	–

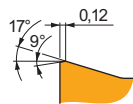

HM geometrie mit robuster Ausführung für die Hochvorschub-Bearbeitung.

SNGX 110416SR-HM:8215	✳ 1.6	230	1.00	1.0	–	–	–	215	1.00	1.0	–	–	–	–	–	–	45	0.70	0.7
SNGX 110416SR-HM:M8310	✳ 1.6	240	1.00	1.0	–	–	–	225	1.00	1.0	–	–	–	–	–	–	45	0.70	0.7

Eignung und Startwerte für Schnittgeschwindigkeit (vc), Vorschub (f) und Schnitttiefe (ap). Weitere Informationen finden Sie in unserer Zerspanungsrechner-App.

Produkt	RE (mm)	P			M			K			N			S			H		
		vc (m/min)	f (mm/tooth)	ap (mm)	vc (m/min)	f (mm/tooth)	ap (mm)	vc (m/min)	f (mm/tooth)	ap (mm)	vc (m/min)	f (mm/tooth)	ap (mm)	vc (m/min)	f (mm/tooth)	ap (mm)	vc (m/min)	f (mm/tooth)	ap (mm)

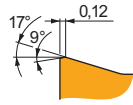
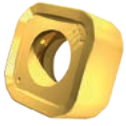

HM Geometrie mit robuster Ausführung für die Hochvorschub-Bearbeitung.

SNGX 110416SR-HM:M8330	1.6	235	1.00	1.0	-	-	-	220	1.00	1.0	-	-	-	-	-	-	45	0.70	0.7
SNGX 110416SR-HM:M9325	1.6	260	1.00	1.0	-	-	-	245	1.00	1.0	-	-	-	-	-	-	50	0.70	0.7



a_e / DCX	5 %	10 %	15 %	20 %	25 %	30 %	40 %	50 %	60 %	70 %	75 %	80 %	90 %	100 %
	1.48	1.35	1.27	1.22	1.19	1.16	1.11	1.08	1.05	1.03	1.00	1.00	1.00	1.00
	2.20	1.60	1.35	1.20	1.10	0.95	0.85	0.75	0.85	0.95	1.00	1.00	1.00	1.00
	0.64	0.64	0.64	0.64	0.64	0.65	0.65	0.67	0.68	0.71	0.72	0.74	0.79	1.00

	SNGX 11 - M	SNGX 11 - MM	SNGX 11 - HM
	1.6	1.6	1.6
	-	-	-

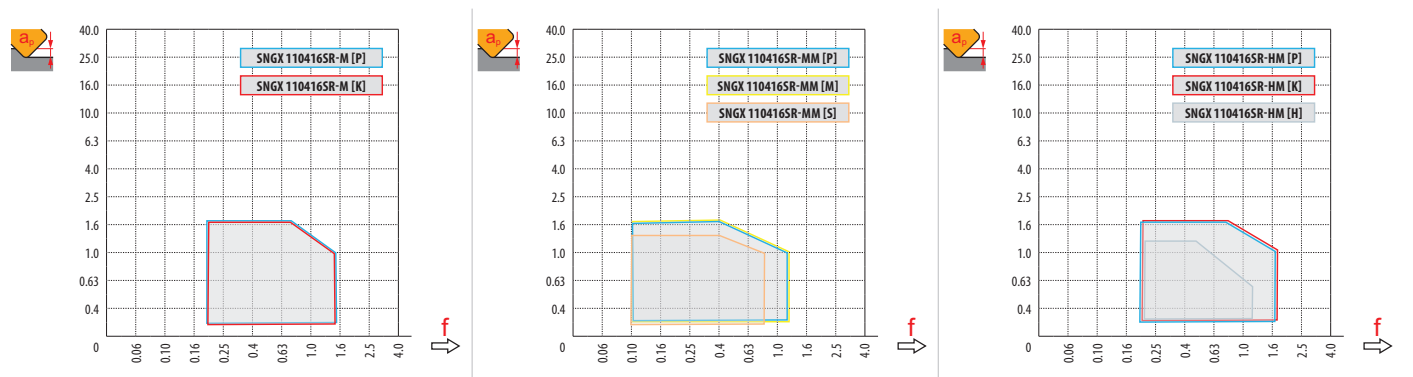

HFC														
		0.00	0.20	0.40	0.60	0.80	1.00	1.10	1.20	1.30	1.40	1.50	1.60	1.70
32		18.30	19.53	20.76	21.99	23.22	24.46	25.07	25.69	26.30	26.92	27.53	28.15	28.76
35		21.20	22.43	23.66	24.89	26.12	27.36	27.97	28.59	29.20	29.82	30.43	31.05	31.66
40		26.20	27.43	28.66	29.89	31.12	32.36	32.97	33.59	34.20	34.82	35.43	36.05	36.66
42		28.20	29.43	30.66	31.89	33.12	34.36	34.97	35.59	36.20	36.82	37.43	38.05	38.66
50		36.10	37.33	38.56	39.79	41.02	42.26	42.87	43.49	44.10	44.72	45.33	45.95	46.56
52		38.10	39.33	40.56	41.79	43.02	44.26	44.87	45.49	46.10	46.72	47.33	47.95	48.56
63		49.10	50.33	51.56	52.79	54.02	55.26	55.87	56.49	57.10	57.72	58.33	58.95	59.56
66		52.10	53.33	54.56	55.79	57.02	58.26	58.87	59.49	60.10	60.72	61.33	61.95	62.56
80		66.10	67.33	68.56	69.79	71.02	72.26	72.87	73.49	74.10	74.72	75.33	75.95	76.56
100		86.10	87.33	88.56	89.79	91.02	92.26	92.87	93.49	94.10	94.72	95.33	95.95	96.56
115		101.10	102.33	103.56	104.79	106.02	107.26	107.87	108.49	109.10	109.72	110.33	110.95	111.56
125		111.10	112.33	113.56	114.79	116.02	117.26	117.87	118.49	119.10	119.72	120.33	120.95	121.56
		-	0.20	0.40	0.60	0.80	1.00	1.10	1.20	1.30	1.40	1.50	1.60	1.70
		-	1.37	0.98	0.81	0.71	0.64	0.62	0.59	0.58	0.56	0.54	0.53	0.52

SNGX

		f_{max}
32	5.0	0.25
35	5.0	0.25
40	5.2	0.30
42	5.2	0.30
50	5.3	0.30
52	5.3	0.30
63	5.4	0.30
66	5.4	0.30
80	5.5	0.35
100	5.5	0.35
115	5.5	0.35
125	5.5	0.35

SNGX (HFC)

	RPMX	APMX/II
32	0.8	1.4/100
35	0.8	1.4/100
40	0.7	1.2/100
42	0.7	1.2/100
50	0.5	0.9/100
52	0.5	0.9/100
63	0.4	0.7/100
66	0.4	0.7/100
80	0.3	0.5/100
100	0.2	0.3/100
115	0.2	0.3/100
125	0.2	0.3/100

SNGX (HFC)

		f_{max}
32	0.2	0.3
35	0.2	0.3
40	0.2	0.3
42	0.2	0.3
50	0.3	0.4
52	0.3	0.4
63	0.3	0.4
66	0.3	0.4
80	0.3	0.4
100	0.3	0.4
115	0.3	0.4
125	0.3	0.4

	μm	3	5	10	15	20	30	40	50	60	80	100
32		0.620	0.800	1.131	1.386	1.600	1.960	2.263	2.530	2.771	3.200	3.578
35		0.648	0.837	1.183	1.449	1.673	2.049	2.366	2.646	2.898	3.347	3.742
40		0.693	0.894	1.265	1.549	1.789	2.191	2.530	2.828	3.098	3.578	4.000
42		0.710	0.917	1.296	1.587	1.833	2.245	2.592	2.898	3.175	3.666	4.099
50		0.775	1.000	1.414	1.732	2.000	2.449	2.828	3.162	3.464	4.000	4.472
52		0.790	1.020	1.442	1.766	2.040	2.498	2.884	3.225	3.533	4.079	4.561
63		0.869	1.122	1.587	1.944	2.245	2.750	3.175	3.550	3.888	4.490	5.020
66		0.890	1.149	1.625	1.990	2.298	2.814	3.250	3.633	3.980	4.596	5.138
80		0.980	1.265	1.789	2.191	2.530	3.098	3.578	4.000	4.382	5.060	5.657
100		1.095	1.414	2.000	2.449	2.828	3.464	4.000	4.472	4.899	5.657	6.325
115		1.175	1.517	2.145	2.627	3.033	3.715	4.290	4.796	5.254	6.066	6.782
125		1.225	1.581	2.236	2.739	3.162	3.873	4.472	5.000	5.477	6.325	7.071

	SNGX			
	0.2	0.5	1.0	1.7
	1.20	1.00	0.50	0.25



SNGX (HFC)



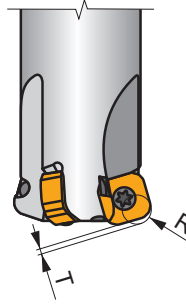





















	D _{MIN}	D _{MAX}		
32	48.0	63.8	0.7	1.4
35	54.0	69.8	0.8	1.5
40	64.0	79.8	0.9	1.5
42	68.0	83.8	1.0	1.6
50	84.0	99.8	0.9	1.4
52	88.0	103.8	1.0	1.4
63	109.0	125.8	1.0	1.4
66	115.0	131.8	1.1	1.4
80	143.0	159.8	1.0	1.3
100	183.0	199.8	0.9	1.1
115	213.0	229.8	1.1	1.3
125	233.0	249.8	1.2	1.4



SNGX	R	T
SNGX 110416	4.6	0.92

WENDEPLATTENFRÄSER – AUSWAHLHILFE

PLANFRÄSEN

	SSO12		SPD09		SZD07		SZD09		SZD12								
	12°		19°		-		-		-								
	APMX (mm)	1.9	APMX (mm)	2.0	APMX (mm)	1.0	APMX (mm)	1.0	APMX (mm)	1.6							
	DCX (mm)	35 – 125	DCX (mm)	32 – 140	DCX (mm)	16 – 25	DCX (mm)	25 – 63	DCX (mm)	32 – 80							
Zylindrischer Schaft		DC = 35, 40 (mm)		DCX = 32, 40 (mm)		DCX = 16 – 25 (mm)											
Weldon		DC = 35, 40 (mm)						DCX = 25, 32 (mm)									
Modular								DCX = 25, 32 (mm)		DCX = 32, 40 (mm)							
Aufsteckfräser		DC = 42 – 125 (mm)		DCX = 42 – 140 (mm)				DCX = 40 – 63 (mm)		DCX = 50 – 80 (mm)							
Seite	📖 266		📖 270		📖 276		📖 280		📖 284								
ISO	P	M	K	N	S	H	P	M	K	S	H	P	K	H	P	K	H
Schneidplattenform																	
Wendeschneidplatten	SOHT 1205		PD.. 0905		ZDCW 0703		ZDCW 09T3		ZDEW 1204								
Anzahl der Schneiden	4		5		4		4		4								
Planfräsen 	■		■		■		■		■								
Schraubenlinien- interpolation 	■		■		▣		▣		▣								
Flaches Eckfräsen 	■		■		▣		▣		▣								
Tauchfräsen 	■		■		▣		▣		▣								
Progressives Tauchfräsen 	■		■		▣		▣		▣								
Rampen 	■		■														
Fräsen geformter Flächen (Kopierfräsen) 			▣		▣		▣		▣								
Flaches Nutfräsen 	■		▣		▣		▣		▣								

SS012

P M K S H

PRAMET

S

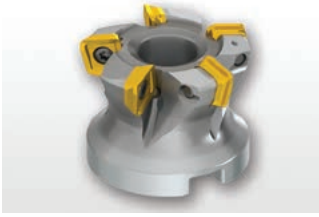

VER S012 12° Hochvorschubfräsen mit innerer Kühlmittelzufuhr

Äußerst vielseitiger 12° Hochvorschubfräser mit einseitigen 50.. 12-Wendeplatten mit APMX von 1.9 mm. Geeignet für eine breite Palette von Anwendungen in den meisten Werkstoffen. Erhältlich in zylindrischer, modularer und Dornausführung mit unterschiedlicher Zahnteilung. Die Kühlmittelkanäle und der Körper sind für eine längere Lebensdauer des Werkzeugs behandelt.

KAPR	12°
APMX	1.9 mm

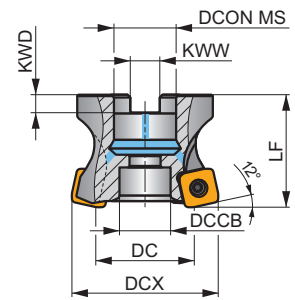
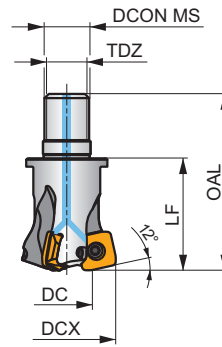
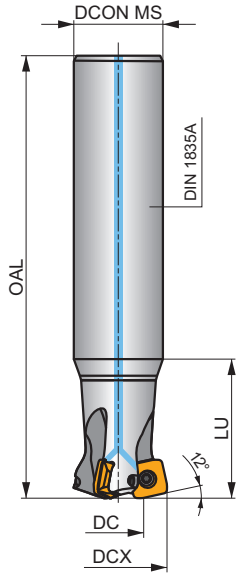
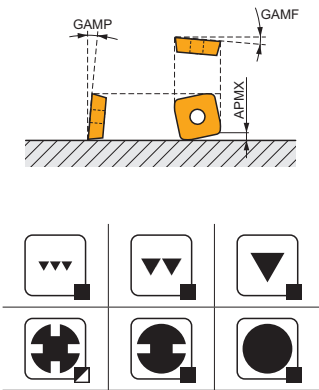

	0.09-0.93
	0.09-0.93



Produkt	DCX	DC	OAL	DCON MS	DCCB	LU	LF	TDZ	KWW	KWD	GAMF	GAMP						
																		(mm)
35E3R050A32-SS012-C	35	17.3	200	32	-	50	-	-	-	-	-5	5	3	-	15700	✓	1.07	GI350 SQ501 -
35E3R120A32-SS012-C	35	17.3	200	32	-	120	-	-	-	-	-5	5	3	-	15700	✓	0.95	GI350 SQ501 -
40E4R120A32-SS012-C	40	22.3	200	32	-	120	-	-	-	-	-5	5	4	-	14700	✓	1.00	GI350 SQ501 -
35E3R040M16-SS012-C	35	17.3	63	17	-	-	40	M16	-	-	-5	5	3	-	15700	✓	0.15	GI350 SQ501 -
40E4R043M16-SS012-C	40	22.3	66	17	-	-	43	M16	-	-	-5	5	4	-	14700	✓	0.18	GI350 SQ501 -
42A04R-SM0S012-C	42	24.3	-	16	12.4	-	40	-	8.4	5.6	-5	5	4	-	14300	✓	0.16	GI350 SQ502 -
50A05R-SM0S012-C	50	32.3	-	22	18.1	-	40	-	10.4	6.3	-5	5	5	✓	13100	✓	0.23	GI350 SQ503 -
52A05R-SM0S012-C	52	34.3	-	22	18.1	-	40	-	10.4	6.3	-5	5	5	✓	12800	✓	0.35	GI350 SQ503 -
63A06R-SM0S012-C	63	45.3	-	27	22.1	-	50	-	12.4	7	-5	5	6	✓	11700	✓	0.48	GI350 SQ504 -
66A06R-SM0S012-C	66	48.3	-	27	22.1	-	50	-	12.4	7	-5	5	6	✓	11400	✓	0.51	GI350 SQ504 -
80A07R-SM0S012-C	80	62.3	-	27	22.1	-	50	-	12.4	7	-5	5	7	✓	10400	✓	0.76	GI350 SQ504 -
100A08R-SM0S012-C	100	82.3	-	32	45.1	-	50	-	14.4	8	-5	5	8	✓	9300	✓	1.32	GI350 SQ505 AC002
125A10R-SM0S012-C	125	107.3	-	40	56.1	-	63	-	16.4	9	-5	5	10	✓	8300	✓	2.46	GI350 SQ505 AC003

	SOHT 1205..
--	-------------

SQ501	US 4011-T15P	3.5	M 4	10.6	FLAG T15P	-	-
SQ502	US 4011-T15P	3.5	M 4	10.6	-	SDR T15P-T	HCS 0840C
SQ503	US 4011-T15P	3.5	M 4	10.6	-	SDR T15P-T	HS 1030C
SQ504	US 4011-T15P	3.5	M 4	10.6	-	SDR T15P-T	HS 1230C
SQ505	US 4011-T15P	3.5	M 4	10.6	-	SDR T15P-T	-

AC002	KS 1635	K.FMH32
AC003	KS 2040	K.FMH40

SOHT 12



	IC	D1	S
	(mm)	(mm)	(mm)
1205	12.700	4.50	5.15

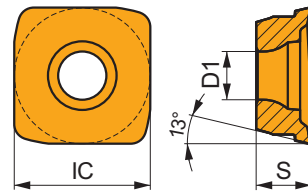

Eignung und Startwerte für Schnittgeschwindigkeit (vc), Vorschub (f) und Schnitttiefe (ap). Weitere Informationen finden Sie in unserer Zerspanungsrechner-App.

Produkt	RE (mm)	P			M			K			N			S			H		
		vc (m/min)	f (mm/tooth)	ap (mm)	vc (m/min)	f (mm/tooth)	ap (mm)	vc (m/min)	f (mm/tooth)	ap (mm)	vc (m/min)	f (mm/tooth)	ap (mm)	vc (m/min)	f (mm/tooth)	ap (mm)	vc (m/min)	f (mm/tooth)	ap (mm)



M geometrie ist vielseitig für eine breite Palette von Arbeitsbedingungen. Entwickelt mit positivem Spanwinkel, mittlerer Fase und Schneidkantenverrundung für reibungsloses HFC-Fräsen. Erste Wahl für Stähle, Gusseisen und gehärtete Stähle.

SOHT 120514SR-M:8215	✱ 1.4	215	1.00	1.0	125	0.90	1.0	200	1.00	1.0	–	–	–	50	0.70	0.8	40	0.68	0.8
SOHT 120514SR-M:M8310	✱ 1.4	225	1.00	1.0	110	0.90	1.0	210	1.00	1.0	–	–	–	–	–	–	45	0.68	0.8
SOHT 120514SR-M:M8330	✱ 1.4	220	1.00	1.0	130	0.90	1.0	205	1.00	1.0	–	–	–	55	0.70	0.8	40	0.68	0.8
SOHT 120514SR-M:M8340	✱ 1.4	205	1.00	1.0	120	0.90	1.0	190	1.00	1.0	–	–	–	50	0.70	0.8	–	–	–
SOHT 120514SR-M:M9325	✱ 1.4	245	1.00	1.0	–	–	–	230	1.00	1.0	–	–	–	–	–	–	45	0.68	0.8
SOHT 120514SR-M:M9340	✱ 1.4	215	1.00	1.0	125	0.90	1.0	–	–	–	–	–	–	50	0.70	0.8	–	–	–



MM geometrie ist scharfe und eignet sich für Anwendungen mit großer Auskrägung oder dünnwandigen Werkstücken. Entwickelt mit positivem Spanwinkel, schmaler Fase und Verrundung der Schneidkante für reibungsloses HFC-Fräsen. Erste Wahl für rostfreie Stähle und Superlegierungen.

SOHT 120514SR-MM:M6330	✱ 1.4	190	1.00	1.0	135	0.90	1.0	–	–	–	–	–	–	55	0.70	0.8	–	–	–
SOHT 120514SR-MM:M8340	✱ 1.4	205	1.00	1.0	120	0.90	1.0	–	–	–	–	–	–	50	0.70	0.8	–	–	–
SOHT 120514SR-MM:M8345	✱ 1.4	165	1.00	1.0	95	0.90	1.0	–	–	–	–	–	–	40	0.70	0.8	–	–	–
SOHT 120514SR-MM:M9325	✱ 1.4	245	1.00	1.0	–	–	–	–	–	–	–	–	–	–	–	–	–	–	–
SOHT 120514SR-MM:M9340	✱ 1.4	215	1.00	1.0	125	0.90	1.0	–	–	–	–	–	–	50	0.70	0.8	–	–	–



a_e / DCX	5%	10%	15%	20%	25%	30%	40%	50%	60%	70%	75%	80%	90%	100%
	1.48	1.35	1.27	1.22	1.19	1.16	1.11	1.08	1.05	1.03	1.00	1.00	1.00	1.00
	2.20	1.60	1.35	1.20	1.10	0.95	0.85	0.75	0.85	0.95	1.00	1.00	1.00	1.00
	0.64	0.64	0.64	0.64	0.64	0.65	0.65	0.67	0.68	0.71	0.72	0.74	0.79	1.00

	SOHT 12-M	SOHT 12-MM
	1.4	1.4
	2.00	2.00

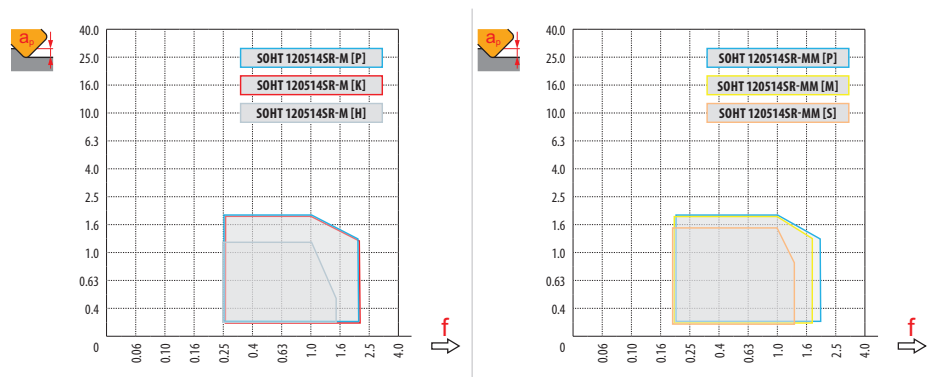

HFC														
DCX	a_e	0.00	0.20	0.40	0.60	0.80	1.00	1.20	1.40	1.50	1.60	1.70	1.80	1.90
35		17.3	19.2	21.1	22.9	24.8	26.7	28.6	30.5	31.4	32.4	33.1	33.5	33.9
40		22.3	24.2	26.1	27.9	29.8	31.7	33.6	35.5	36.4	37.4	38.1	38.5	38.9
42		24.3	26.2	28.1	29.9	31.8	33.7	35.6	37.5	38.4	39.4	40.1	40.5	40.9
50		32.3	34.2	36.1	37.9	39.8	41.7	43.6	45.5	46.4	47.4	48.1	48.5	48.9
52		34.3	36.2	38.1	39.9	41.8	43.7	45.6	47.5	48.4	49.4	50.1	50.5	50.9
63		45.3	47.2	49.1	50.9	52.8	54.7	56.6	58.5	59.4	60.4	61.1	61.5	61.9
66		48.3	50.2	52.1	53.9	55.8	57.7	59.6	61.5	62.4	63.4	64.1	64.5	64.9
80		62.3	64.2	66.1	67.9	69.8	71.7	73.6	75.5	76.4	77.4	78.1	78.5	78.9
100		82.3	84.2	86.1	87.9	89.8	91.7	93.6	95.5	96.4	97.4	98.1	98.5	98.9
125		107.3	109.2	111.1	112.9	114.8	116.7	118.6	120.5	121.4	122.4	123.1	123.5	123.9
	a_e	0.00	0.20	0.40	0.60	0.80	1.00	1.20	1.40	1.50	1.60	1.70	1.80	1.90
		-	2.20	2.00	1.80	1.60	1.40	1.20	1.10	1.00	0.90	0.80	0.70	0.60

DCX	$d_{e\max}$	f_{\max}
35	10.0	0.10
40	10.0	0.10
42	10.0	0.12
50	10.0	0.12
52	10.0	0.12
63	10.0	0.15
66	10.0	0.15
80	10.0	0.20
100	10.0	0.20
125	10.0	0.20

DCX	RPMX	APMX/I
35	9.6	1.9/11
40	6.9	1.9/16
42	6.1	1.9/18
50	4.3	1.9/25
52	4.0	1.9/27
63	2.6	1.9/41
66	2.5	1.9/44
80	1.9	1.9/59
100	1.4	1.9/79
125	1.0	1.9/105

DCX	a	f_{\max}
35	1.6	0.17
40	1.6	0.17
42	1.6	0.15
50	1.6	0.10
52	1.6	0.10
63	1.6	0.05
66	1.6	0.05
80	1.6	0.05
100	1.6	0.05
125	1.6	0.05

DCX	μm	3	5	10	15	20	30	40	50	60	80	100
35		0.648	0.837	1.183	1.449	1.673	2.049	2.366	2.646	2.898	3.347	3.742
40		0.693	0.894	1.265	1.549	1.789	2.191	2.530	2.828	3.098	3.578	4.000
42		0.710	0.917	1.296	1.587	1.833	2.245	2.592	2.898	3.175	3.666	4.099
50		0.775	1.000	1.414	1.732	2.000	2.449	2.828	3.162	3.464	4.000	4.472
52		0.790	1.020	1.442	1.766	2.040	2.498	2.884	3.225	3.533	4.079	4.561
63		0.869	1.122	1.587	1.944	2.245	2.750	3.175	3.550	3.888	4.490	5.020
66		0.890	1.149	1.625	1.990	2.298	2.814	3.250	3.633	3.980	4.596	5.138
80		0.980	1.265	1.789	2.191	2.530	3.098	3.578	4.000	4.382	5.060	5.657
100		1.095	1.414	2.000	2.449	2.828	3.464	4.000	4.472	4.899	5.657	6.325
125		1.225	1.581	2.236	2.739	3.162	3.873	4.472	5.000	5.477	6.325	7.071

a	0.2	0.6	1.0	1.5	1.9
f	2.0	1.6	1.2	0.8	0.5

DCX	D _{MIN}	D _{MAX}	S _{MAX} D _{MIN}	S _{MAX} D _{MAX}
35	46.0	69.8	1.9	1.9
40	56.0	79.8	1.9	1.9
42	60.0	83.8	1.9	1.9
50	76.0	99.8	1.9	1.9
52	80.0	103.8	1.9	1.9
63	102.0	125.8	1.9	1.9
66	108.0	131.8	1.9	1.9
80	136.0	159.8	1.9	1.9
100	176.0	199.8	1.9	1.9
125	226.0	249.8	1.9	1.9

i

SOHT	R	T
SOHT 120514	3.37	1.21

SPD09

P M K S H

PRAMET

S



PENTA HF Hochvorschubfräser mit Innenkühlung

Produktiver Hochvorschubfräser mit einseitigem positivem PD.. 09-Wendeschneidplatten mit 5 Schneidkanten und einem APMX von 2 mm. Innenkühlung. Geeignet für eine Vielzahl von Anwendungen. Erhältlich als Zylinderschaft und Aufsteckfräser. Körper für längere Standzeiten oberflächenbehandelt.

PENTA HF

KAPR	19°
APMX	2.0 mm

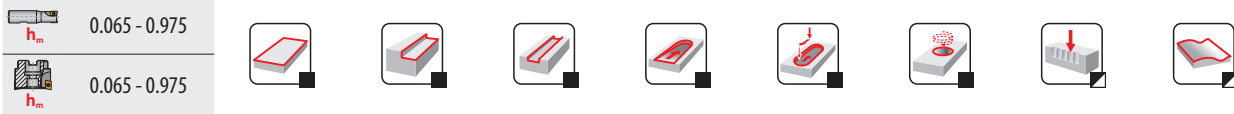
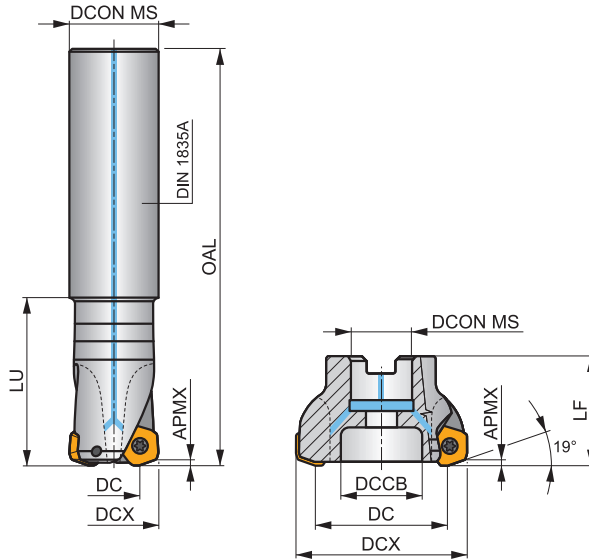
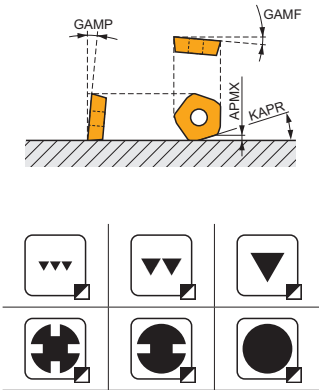

Produkt	DCX	DC	OAL	DCON MS	DCCB	LU	LF	GAMP	GAMP				kg		
	(mm)	(mm)	(mm)	(mm)	(mm)	(mm)	(mm)	(°)	(°)						
32E2R060A32-SPD09-C	32	18.4	250	32	-	60	-	-24	10	2	-	13100	✓	1.34	GI245 C0340 -
40E3R060A32-SPD09-C	40	25.5	250	32	-	60	-	-11	10	3	-	11700	✓	1.43	GI245 C0340 -
42A03R-S19PD09-C	42	27.5	-	16	12	-	40	-8	10	3	-	11500	✓	0.18	GI245 C0342 -
50A04R-S19PD09-C	50	35.3	-	22	18	-	40	-3	10	4	-	10500	✓	0.23	GI245 C0343 -
50A05R-S19PD09-C	50	35.3	-	22	18	-	40	-3	10	5	-	10500	✓	0.33	GI245 C0343 -
52A04R-S19PD09-C	52	37.3	-	22	18	-	40	-3	10	4	-	10300	✓	0.25	GI245 C0343 -
63A05R-S19PD09-C	63	48.2	-	22	18	-	40	-1	10	5	-	9400	✓	0.44	GI245 C0343 -
63A06R-S19PD09-C	63	48.2	-	22	18	-	40	-1	10	6	-	9300	✓	0.45	GI245 C0343 -
66A06R-S19PD09-C	66	51.2	-	22	18	-	40	-1	10	6	-	9200	✓	0.35	GI245 C0343 -
66A06R-S19PD09-CF	66	51.2	-	27	22	-	50	-1	10	6	-	9100	✓	0.67	GI245 C0344 -
80A05R-S19PD09-C	80	65.3	-	27	37	-	50	-1	10	5	-	8300	✓	0.84	GI245 C0341 AC001
80A06R-S19PD09-C	80	65.3	-	27	37	-	50	-1	10	6	-	8300	✓	0.86	GI245 C0341 AC001
100A06R-S19PD09-C	100	58.3	-	32	45	-	50	-1	10	6	-	7400	✓	1.46	GI245 C0341 AC002
100A08R-S19PD09-C	100	85.3	-	32	45	-	50	-1	10	8	-	7400	✓	1.40	GI245 C0341 AC002
125A08R-S19PD09-C	125	110.3	-	40	36	-	63	-1	10	8	-	6600	✓	3.10	GI245 C0349 -
125A10R-S19PD09-C	125	110.3	-	40	36	-	63	-1	10	10	-	6600	✓	3.11	GI245 C0349 -
140A08R-S19PD09-C	140	125.3	-	40	36	-	63	-1	10	8	-	6200	✓	3.57	GI245 C0349 -

GI245	PD.X 0905ZE..	PDKT 0905..	PDMW 0905..

C0340	US 45011-T20P	5.0	M 5	11	-	Flag T20P
C0341	US 45011-T20P	5.0	M 5	11	SDR T20P-T	-

C0342	US 45011-T20P	5.0	M 5	11	SDR T20P-T	HS 90835	-
C0343	US 45011-T20P	5.0	M 5	11	SDR T20P-T	HS 1030C	-
C0344	US 45011-T20P	5.0	M 5	11	SDR T20P-T	HS 1230C	-
C0349	US 45011-T20P	5.0	M 5	11	SDR T20P-T	HSD 2040	-

AC001	KS 1230	K.FMH27
AC002	KS 1635	K.FMH32

PDMX 09



	BS	IC	D1	L	S
	(mm)	(mm)	(mm)	(mm)	(mm)
0905	2.00	13.500	5.50	9.00	5.47

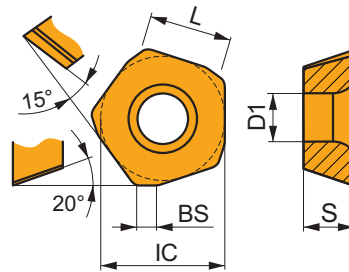

Eignung und Startwerte für Schnittgeschwindigkeit (vc), Vorschub (f) und Schnitttiefe (ap). Weitere Informationen finden Sie in unserer Zerspanungsrechner-App.

Produkt	RE (mm)	P			M			K			N			S			H		
		vc (m/min)	f (mm/tooth)	ap (mm)	vc (m/min)	f (mm/tooth)	ap (mm)	vc (m/min)	f (mm/tooth)	ap (mm)	vc (m/min)	f (mm/tooth)	ap (mm)	vc (m/min)	f (mm/tooth)	ap (mm)	vc (m/min)	f (mm/tooth)	ap (mm)

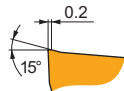

M geometrie mit positiven Design zur mittleren Bearbeitung mit hohen Vorschub.

PDMX 0905ZEER-M:8215	☺	-	■	215	1.00	1.2	■	125	0.90	1.2	■	200	1.00	1.2	-	-	-	-	-	-	-	-	-	-	-	-	-	-	-	-	-	-	-	
PDMX 0905ZEER-M:M8330	☺	-	■	220	1.00	1.2	■	130	0.90	1.2	■	205	1.00	1.2	-	-	-	-	-	-	-	-	-	-	-	-	-	-	-	-	-	-	-	
PDMX 0905ZEER-M:M8345	☺	-	■	165	1.00	1.2	■	95	0.90	1.2	-	-	-	-	-	-	-	-	-	-	-	-	-	-	-	-	-	-	-	-	-	-	-	
PDMX 0905ZEER-M:M9340	☺	-	■	215	1.00	1.2	■	125	0.90	1.2	-	-	-	-	-	-	-	-	-	-	-	-	-	-	-	-	-	-	-	-	-	-	-	-

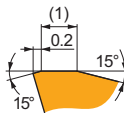

R geometrie mit starker Ausführung für die Bearbeitung mit hohen Vorschub.

PDMX 0905ZESR-R:8215	☺	-	■	215	1.00	1.3	-	-	-	■	200	1.00	1.3	-	-	-	-	-	-	-	-	-	-	■	40	0.70	0.9	-	-	-	-	-	
PDMX 0905ZESR-R:M8330	☺	-	■	215	1.00	1.3	-	-	-	■	200	1.00	1.3	-	-	-	-	-	-	-	-	-	-	■	40	0.70	0.9	-	-	-	-	-	
PDMX 0905ZESR-R:M8345	☺	-	■	165	1.00	1.3	-	-	-	-	-	-	-	-	-	-	-	-	-	-	-	-	-	-	-	-	-	-	-	-	-	-	-
PDMX 0905ZESR-R:M9325	☺	-	■	245	1.00	1.3	-	-	-	■	230	1.00	1.3	-	-	-	-	-	-	-	-	-	-	■	45	0.70	0.9	-	-	-	-	-	

PDKT 09



	IC (mm)	D1 (mm)	L (mm)	S (mm)
0905	13.500	5.50	9.00	5.47

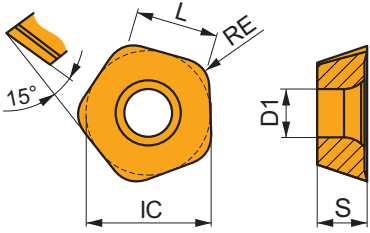

Eignung und Startwerte für Schnittgeschwindigkeit (vc), Vorschub (f) und Schnitttiefe (ap). Weitere Informationen finden Sie in unserer Zerspanungsrechner-App.

Produkt	RE (mm)	P			M			K			N			S			H		
		vc (m/min)	f (mm/tooth)	ap (mm)	vc (m/min)	f (mm/tooth)	ap (mm)	vc (m/min)	f (mm/tooth)	ap (mm)	vc (m/min)	f (mm/tooth)	ap (mm)	vc (m/min)	f (mm/tooth)	ap (mm)	vc (m/min)	f (mm/tooth)	ap (mm)

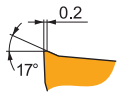

FM geometrie mit sehr positiven Design zur leichten bis zur mittleren Bearbeitung mit hohen Vorschub.

PDKT 090530ER-FM:8215	3.0	240	1.00	1.2	140	0.90	1.2	225	1.00	1.2	60	0.70	1.0			
PDKT 090530ER-FM:M6330	3.0	210	1.00	1.2	150	0.90	1.2				60	0.70	1.0			
PDKT 090530ER-FM:M8310	3.0	250	1.00	1.2	125	0.90	1.2	235	1.00	1.2						
PDKT 090530ER-FM:M8330	3.0	245	1.00	1.2	145	0.90	1.2	230	1.00	1.2	60	0.70	1.0			
PDKT 090530ER-FM:M8345	3.0	180	1.00	1.2	105	0.90	1.2				45	0.70	1.0			
PDKT 090530ER-FM:M9325	3.0	275	1.00	1.2				260	1.00	1.2						

PDKX 09



	BS (mm)	IC (mm)	D1 (mm)	L (mm)	S (mm)
0905	2.00	13.500	5.50	9.00	5.47

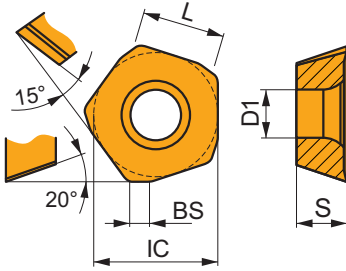

Eignung und Startwerte für Schnittgeschwindigkeit (vc), Vorschub (f) und Schnitttiefe (ap). Weitere Informationen finden Sie in unserer Zerspanungsrechner-App.

Produkt	RE (mm)	P			M			K			N			S			H		
		vc (m/min)	f (mm/tooth)	ap (mm)	vc (m/min)	f (mm/tooth)	ap (mm)	vc (m/min)	f (mm/tooth)	ap (mm)	vc (m/min)	f (mm/tooth)	ap (mm)	vc (m/min)	f (mm/tooth)	ap (mm)	vc (m/min)	f (mm/tooth)	ap (mm)

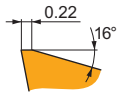

FM geometrie mit sehr positiven Design zur mittleren Bearbeitung mit hohen Vorschub.

PDKX 0905ZEER-FM:M6330		195	1.00	1.2	135	0.90	1.2				55	0.70	1.0			
PDKX 0905ZEER-FM:M8345		165	1.00	1.2	95	0.90	1.2				40	0.70	1.0			
PDKX 0905ZEER-FM:M9340		215	1.00	1.2	125	0.90	1.2				50	0.70	1.0			

PDMW 09



	IC	D1	L	S
	(mm)	(mm)	(mm)	(mm)
0905	13.500	5.50	9.00	5.47

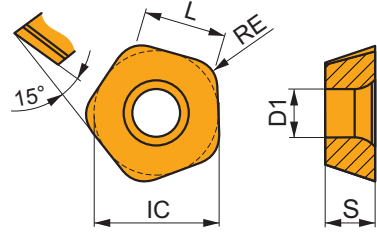

Eignung und Startwerte für Schnittgeschwindigkeit (vc), Vorschub (f) und Schnitttiefe (ap). Weitere Informationen finden Sie in unserer Zerspanungsrechner-App.

Produkt	RE (mm)	P			M			K			N			S			H		
		vc	f	ap	vc	f	ap	vc	f	ap	vc	f	ap	vc	f	ap	vc	f	ap
		(m/min)	(mm/tooth)	(mm)	(m/min)	(mm/tooth)	(mm)	(m/min)	(mm/tooth)	(mm)	(m/min)	(mm/tooth)	(mm)	(m/min)	(mm/tooth)	(mm)	(m/min)	(mm/tooth)	(mm)

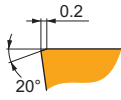

SR ohne Spanwinkel zur Hochvorschubbearbeitung.

PDMW 090530SR:M8310	✳	3.0	✓	245	1.00	1.4	–	–	–	■	230	1.00	1.4	–	–	–	–	–	–	■	45	0.70	1.0
PDMW 090530SR:M8345	✳	3.0	✓	180	1.00	1.4	–	–	–	–	–	–	–	–	–	–	–	–	–	–	–	–	–
PDMW 090530SR:M9325	✳	3.0	✓	270	1.00	1.4	–	–	–	■	255	1.00	1.4	–	–	–	–	–	–	✓	50	0.70	1.0



a_e / DCX	5 %	10 %	15 %	20 %	25 %	30 %	40 %	50 %	60 %	70 %	75 %	80 %	90 %	100 %
	1.48	1.35	1.27	1.22	1.19	1.16	1.11	1.08	1.05	1.03	1.00	1.00	1.00	1.00
	2.20	1.60	1.35	1.20	1.10	0.95	0.85	0.75	0.85	0.95	1.00	1.00	1.00	1.00
	0.64	0.64	0.64	0.64	0.64	0.65	0.65	0.67	0.68	0.71	0.72	0.74	0.79	1.00

	PDKX 09-FM	PDMX 09-M	PDMX 09-R	PDKT 09-FM	PDMW 09
	-	-	-	3.0	3.0
	2.00	2.00	2.00	-	-

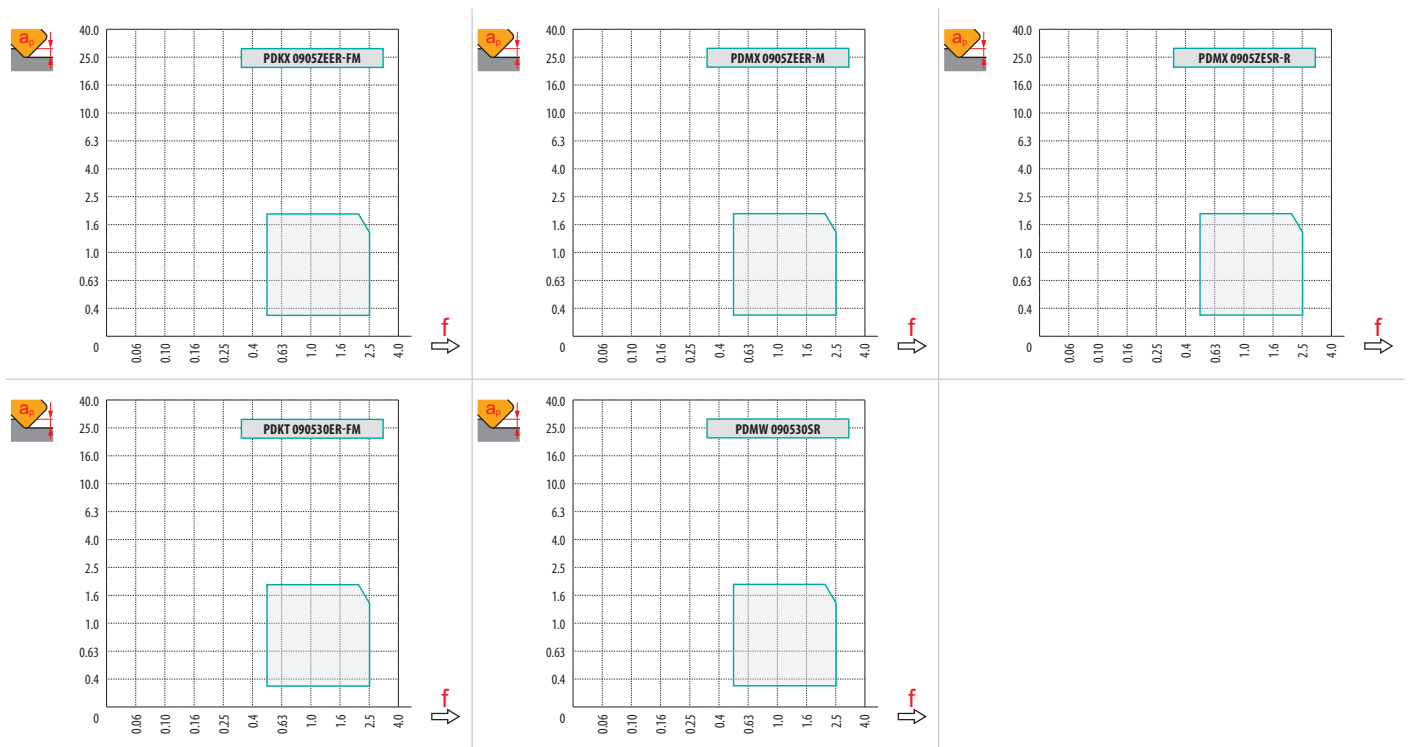

		0.00	0.30	0.40	0.50	0.60	0.70	0.80	0.90	1.00	1.25	1.50	2.00
32		18.4	20.1	20.7	21.3	21.9	22.5	23.0	23.6	24.2	25.7	27.1	30.0
40		25.5	27.2	27.8	28.4	29.0	29.6	30.1	30.7	31.3	32.8	34.2	37.1
42		27.5	29.2	29.8	30.4	31.0	31.6	32.1	32.7	33.3	34.8	36.2	39.1
50		35.3	37.0	37.6	38.2	38.8	39.4	39.9	40.5	41.1	42.6	44.0	46.9
52		37.3	39.0	39.6	40.2	40.8	41.4	41.9	42.5	43.1	44.6	46.0	48.9
63		48.2	49.9	50.5	51.1	51.7	52.3	52.8	53.4	54.0	55.5	56.9	59.8
66		51.2	52.9	53.5	54.1	54.7	55.3	55.8	56.4	57.0	58.5	59.9	62.8
80		65.3	67.0	67.6	68.2	68.8	69.4	69.9	70.5	71.1	72.6	74.0	76.9
100		85.3	87.0	87.6	88.2	88.8	89.4	89.9	90.5	91.1	92.6	94.0	96.9
125		110.3	112.3	112.9	113.5	114.1	114.6	115.2	115.8	116.4	117.9	119.3	122.2
140	125.3	127.3	127.9	128.5	129.1	129.7	130.2	130.8	131.4	132.9	134.3	137.2	
		0.00	0.30	0.40	0.50	0.60	0.70	0.80	0.90	1.00	1.25	1.50	2.00
		-	3.00	3.00	2.90	2.80	2.70	2.60	2.50	2.40	2.25	1.50	1.50



Befolgen Sie die Anweisungen für das Planfräsen. Beim Fräsen nahe der senkrechten Fläche verringern Sie den Vorschub pro Zahn (f_z) auf 50 %, um Vibrationen und Beschädigungen der Schneide zu vermeiden.



DCX	max f_z	f_{max}
32	5.0	0.20
40	5.0	0.20
42	5.0	0.20
50	6.0	0.20
52	6.0	0.20
63	7.0	0.25
66	7.0	0.25
80	8.0	0.30
100	8.0	0.30



DCX	RPMX	APMX/1
40	8.0	1.80/16
42	8.0	2.00/16
50	8.0	2.00/16
52	8.0	2.00/16
63	7.0	2.00/18
66	6.0	2.00/21
80	5.0	2.00/24
100	3.0	2.00/40



HFC			
a_p	0.5	1.0	2.0
f_z	3.0	2.3	1.5



DCX	DMIN	DMAX	SMAX DMIN	SMAX DMAX
40	63.7	80.0	2.00	2.00
42	67.5	84.0	2.00	2.00
50	83.3	100.0	2.00	2.00
52	87.3	104.0	2.00	2.00
63	109.2	126.0	2.00	2.00
66	115.2	132.0	2.00	2.00
80	143.3	160.0	2.00	2.00
100	183.3	200.0	2.00	2.00



DCX	a_p	f_{max}
32	1.8	0.20
40	1.8	0.20
42	2.0	0.20
50	2.0	0.20
52	2.0	0.20
63	2.0	0.25
66	2.0	0.25
80	2.0	0.30
100	2.0	0.30



DCX	μm	3	5	10	15	20	30	40	50	60	80	100
32		0.620	0.800	1.131	1.386	1.600	1.960	2.263	2.530	2.771	3.200	3.578
40		0.693	0.894	1.265	1.549	1.789	2.191	2.530	2.828	3.098	3.578	4.000
42		0.710	0.917	1.296	1.587	1.833	2.245	2.592	2.898	3.175	3.666	4.099
50		0.775	1.000	1.414	1.732	2.000	2.449	2.828	3.162	3.464	4.000	4.472
52		0.790	1.020	1.442	1.766	2.040	2.498	2.884	3.225	3.533	4.079	4.561
63		0.869	1.122	1.587	1.944	2.245	2.750	3.175	3.550	3.888	4.490	5.020
66		0.890	1.149	1.625	1.990	2.298	2.814	3.250	3.633	3.980	4.596	5.138
80		0.980	1.265	1.789	2.191	2.530	3.098	3.578	4.000	4.382	5.060	5.657

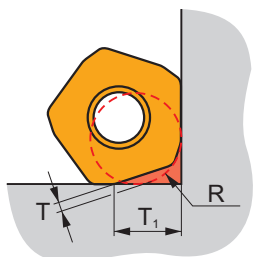

DCX	R	T	T ₁
32	4.5	1.1	6.8
40 - 140	4.5	1.1	7.3

SZD07

P **K** **H**

PRAMET

S



ZD07 Hochvorschubfräser mit Innenkühlung

Produktiver Hochvorschubfräser mit einseitigem ZD..07-Wendeschneidplatten mit 4 Schneidkanten und einer APMX von 1 mm. Innenkühlung. Geeignet für eine Vielzahl von Anwendungen. Erhältlich als Zylinder- und modularer Schaft. Körper für längere Standzeiten oberflächenbehandelt.

FEED ZD

APMX	1.0 mm
------	--------

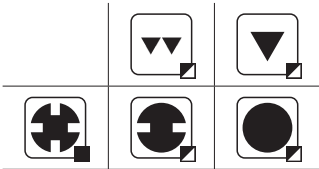
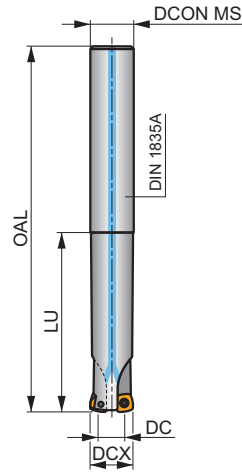
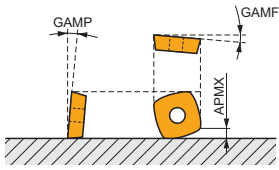

h_m 0.175 - 0.44



Produkt	DCX	DC	OAL	DCON MS	LU	LF	GAMF	GAMP										
	(mm)	(mm)	(mm)	(mm)	(mm)	(mm)	(°)	(°)										
16E2R030A16-SZD07	16	6	100	16	30	-	-5	8	2	-	47400	✓	0.13	GI201	C0350			
16E2R065A16-SZD07	16	6	145	16	65	-	-5	8	2	-	47400	✓	0.22	GI201	C0350			
20E3R040A20-SZD07	20	10	120	20	40	-	-5	8	3	-	42400	✓	0.25	GI201	C0350			
20E3R080A20-SZD07	20	10	165	20	80	-	-5	8	3	-	42400	✓	0.33	GI201	C0350			
25E3R050A25-SZD07	25	15	140	25	50	-	-5	8	3	-	37900	✓	0.47	GI201	C0350			
25E3R100A25-SZD07	25	15	190	25	100	-	-5	8	3	-	37900	✓	0.60	GI201	C0350			

GI201																		ZDCW 0703..

C0350	US 2205-T07P	0.9	Nm	M 2.2	5													Flag T07P

ZDCW 07



	IC	D1	S
	(mm)	(mm)	(mm)
0703	6.800	2.60	3.18

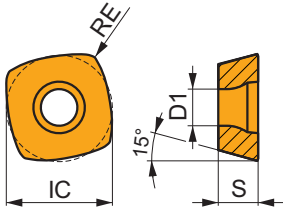

Eignung und Startwerte für Schnittgeschwindigkeit (vc), Vorschub (f) und Schnitttiefe (ap). Weitere Informationen finden Sie in unserer Zerspanungsrechner-App.

Produkt	RE (mm)	P			M			K			N			S			H		
		vc	f	ap	vc	f	ap	vc	f	ap	vc	f	ap	vc	f	ap	vc	f	ap
		(m/min)	(mm/tooth)	(mm)	(m/min)	(mm/tooth)	(mm)	(m/min)	(mm/tooth)	(mm)	(m/min)	(mm/tooth)	(mm)	(m/min)	(mm/tooth)	(mm)	(m/min)	(mm/tooth)	(mm)

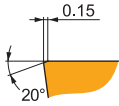
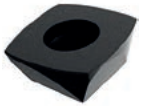

ZDCW besondere geometrie für die Bearbeitung mit hohem Vorschub.

ZDCW 070304:M8310	0.4	420	0.60	0.4	—	—	—	395	0.60	0.4	—	—	—	—	—	—	80	0.42	0.3
ZDCW 070304:M8325	0.4	325	0.60	0.4	—	—	—	—	—	—	—	—	—	—	—	—	—	—	—
ZDCW 070304:M8345	0.4	305	0.60	0.4	—	—	—	—	—	—	—	—	—	—	—	—	—	—	—



a_e / DCX	5 %	10 %	15 %	20 %	25 %	30 %	40 %	50 %	60 %	70 %	75 %	80 %	90 %	100 %
	1.48	1.35	1.27	1.22	1.19	1.16	1.11	1.08	1.05	1.03	1.00	1.00	1.00	1.00
	2.20	1.60	1.35	1.20	1.10	0.95	0.85	0.75	0.85	0.95	1.00	1.00	1.00	1.00
	0.64	0.64	0.64	0.64	0.64	0.65	0.65	0.67	0.68	0.71	0.72	0.74	0.79	1.00

	ZDCW 07
	0.4
	-

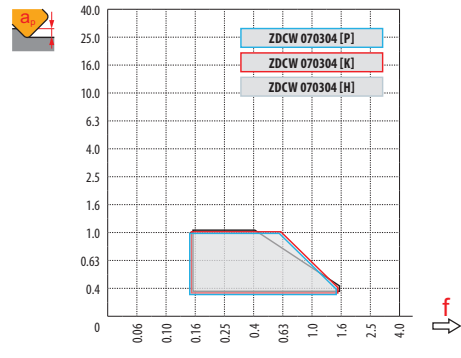

		0.00	0.30	0.40	0.50	0.60	0.70	0.80	0.90	1.00
16		6.0	12.0	12.9	13.7	14.4	15.1	15.7	16.2	16.8
20		10.0	16.0	16.9	17.7	18.4	19.1	19.7	20.2	20.8
25		15.0	21.0	21.9	22.7	23.4	24.1	24.7	25.2	25.8
		0.00	0.30	0.40	0.50	0.60	0.70	0.80	0.90	1.00
		-	1.50	1.50	1.13	1.00	0.88	0.75	0.61	0.60

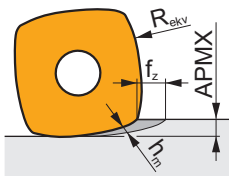

$$f_z = h_m \times \sqrt{\frac{2R_{ekv}}{APMX}} \quad (\text{mm/Zahn})$$



Befolgen Sie die Anweisungen für das Planfräsen. Beim Fräsen nahe der senkrechten Fläche verringern Sie den Vorschub pro Zahn (f_z) auf 50 %, um Vibrationen und Beschädigungen der Schneide zu vermeiden.

	f_{max}	f_{max}
16	5.6	0.12
20	5.6	0.15
25	5.6	0.17

HFC			
	0.3	0.6	1.0
	1.50	0.80	0.40

	RPMX	APMX/I
16	7.8	1.0/9
20	9.7	1.0/7
25	4.9	1.0/13

	RPMX	APMX/I
16	0.5	0.75/100
20	0.3	0.40/100
25	0.2	0.20/100



	DMIN	DMAX		
16	21.0	32.0	0.10	0.40
20	29.0	40.0	0.10	0.30
25	39.0	50.0	0.15	0.25



		f_{max}
16	0.05	0.12
20	0.05	0.15
25	0.05	0.17



	μm	3	5	10	15	20	30	40	50	60	80	100
16		0.438	0.566	0.800	0.980	1.131	1.386	1.600	1.789	1.960	2.263	2.530
20		0.490	0.632	0.894	1.095	1.265	1.549	1.789	2.000	2.191	2.530	2.828
25		0.548	0.707	1.000	1.225	1.414	1.732	2.000	2.236	2.449	2.828	3.162

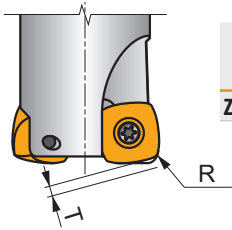

	R	T
ZDCW 070304	1.70	0.60

SZD09

P **K** **H**

PRAMET

S



ZD09 Hochvorschubfräser mit Innenkühlung

Produktiver Hochvorschubfräser mit einseitigem ZD. 09-Wendeschneidplatten mit 4 Schneidkanten und einer APMX von 1 mm. Innenkühlung. Geeignet für eine Vielzahl von Anwendungen. Erhältlich als Zylinderschaft, modularer Schaft und Aufsteckfräser. Körper für längere Standzeiten oberflächenbehandelt.

FEED ZD

APMX	1.0 mm
------	--------

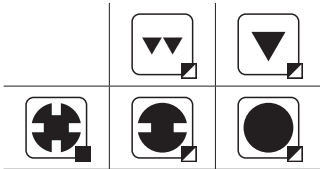
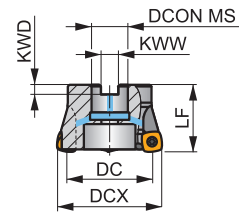
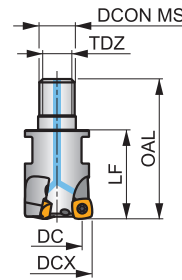
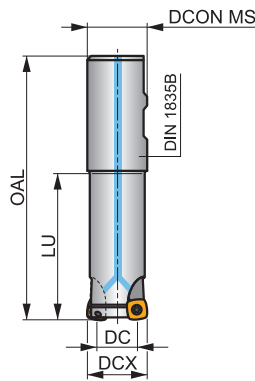
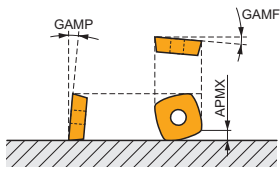

	0.31 - 0.618
	0.31 - 0.618



Produkt	DCX	DC	OAL	DCON MS	LU	LF	TDZ	KWW	KWD	GAMF	GAMP							
	(mm)	(mm)	(mm)	(mm)	(mm)	(mm)		(mm)	(mm)	(°)	(°)							
25E2R080B25-SZD09-C	25	11.6	140	25	80	-	-	-	-	-6	10	2	-	22800	✓	0.46	G1191	SQ400
25E2R140B25-SZD09-C	25	11.6	200	25	140	-	-	-	-	-6	10	2	-	22800	✓	0.63	G1191	SQ400
32E2R080B32-SZD09-C	32	18.7	140	32	80	-	-	-	-	-6	10	2	-	20100	✓	0.76	G1191	SQ400
25E3R032M12-SZD09-C	25	11.6	54	12.5	-	32	M12	-	-	-6	10	3	-	-	✓	0.11	G1191	SQ400
32E3R040M16-SZD09-C	32	18.7	63	17	-	40	M16	-	-	-6	10	3	-	-	✓	0.21	G1191	SQ400
40A04R-SMOZD09-C	40	26.7	-	16	-	40	-	8.4	5.6	-6	10	4	✓	18000	✓	0.34	G1191	SQ402
50A05R-SMOZD09-C	50	36.7	-	22	-	40	-	10.4	6.4	-6	10	5	✓	16000	✓	0.41	G1191	SQ403
63A06R-SMOZD09-C	63	49.7	-	22	-	40	-	10.4	6.4	-6	10	6	✓	14300	✓	0.60	G1191	SQ403

	G1191		ZDCW 09T3..
--	-------	--	-------------

SQ400	US 3006-T09P	2.0	M 3	6	-	-	Flag T09P	-
SQ402	US 3006-T09P	2.0	M 3	6	D-T07P/T09P	FG-15	-	HS 0830C
SQ403	US 3006-T09P	2.0	M 3	6	D-T07P/T09P	FG-15	-	HS 1030C

ZDCW 09



	IC	D1	S
	(mm)	(mm)	(mm)
09T3	9.525	3.40	3.97

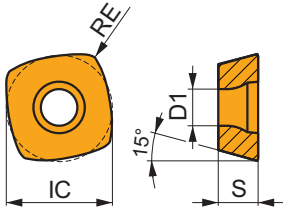

Eignung und Startwerte für Schnittgeschwindigkeit (vc), Vorschub (f) und Schnitttiefe (ap). Weitere Informationen finden Sie in unserer Zerspanungsrechner-App.

Produkt	RE (mm)	P			M			K			N			S			H		
		vc	f	ap	vc	f	ap	vc	f	ap	vc	f	ap	vc	f	ap	vc	f	ap
		(m/min)	(mm/tooth)	(mm)	(m/min)	(mm/tooth)	(mm)	(m/min)	(mm/tooth)	(mm)	(m/min)	(mm/tooth)	(mm)	(m/min)	(mm/tooth)	(mm)	(m/min)	(mm/tooth)	(mm)

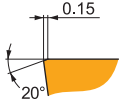
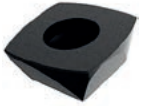

ZDCW besondere geometrie für die Bearbeitung mit hohem Vorschub.

ZDCW 09T304:M8310	0.4	320	1.00	0.6	—	—	—	300	1.00	0.6	—	—	—	—	—	—	60	0.70	0.4
ZDCW 09T304:M8325	0.4	250	1.00	0.6	—	—	—	—	—	—	—	—	—	—	—	—	—	—	—
ZDCW 09T304:M8345	0.4	235	1.00	0.6	—	—	—	—	—	—	—	—	—	—	—	—	—	—	—



a_e DCX	5 %	10 %	15 %	20 %	25 %	30 %	40 %	50 %	60 %	70 %	75 %	80 %	90 %	100 %
	1.48	1.35	1.27	1.22	1.19	1.16	1.11	1.08	1.05	1.03	1.00	1.00	1.00	1.00
	2.20	1.60	1.35	1.20	1.10	0.95	0.85	0.75	0.85	0.95	1.00	1.00	1.00	1.00
	0.64	0.64	0.64	0.64	0.64	0.65	0.65	0.67	0.68	0.71	0.72	0.74	0.79	1.00

	ZDCW 09
	0.4
	-

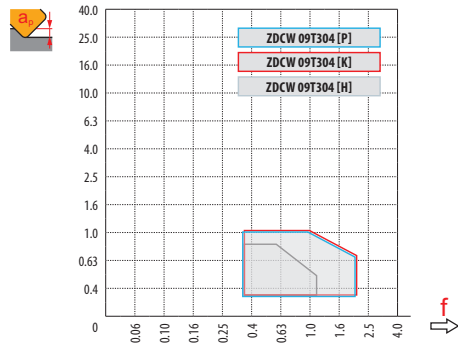

		0.00	0.30	0.40	0.50	0.60	0.70	0.80	0.90	1.00
25		11.6	17.4	18.2	19.0	19.7	20.3	20.9	21.5	22.0
32		18.7	24.5	25.3	26.1	26.8	27.4	28.0	28.6	29.1
40		27.7	33.5	34.3	35.1	35.8	36.4	37.0	37.6	38.1
50		36.7	42.3	43.1	43.8	44.5	45.1	45.7	46.2	46.7
63		49.7	55.3	56.1	56.8	57.5	58.1	58.7	59.2	59.7
		0.00	0.30	0.40	0.50	0.60	0.70	0.80	0.90	1.00
		-	2.00	2.00	2.00	1.75	1.50	1.25	1.13	1.00

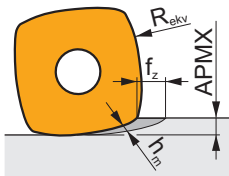

$$f_z = h_m \times \sqrt{\frac{2R_{ekv}}{APMX}} \quad (\text{mm/Zahn})$$



Befolgen Sie die Anweisungen für das Planfräsen. Beim Fräsen nahe der senkrechten Fläche verringern Sie den Vorschub pro Zahn (f_z) auf 50 %, um Vibrationen und Beschädigungen der Schneide zu vermeiden.

		f_{max}
25	7.7	0.15
32	7.7	0.17
40	7.7	0.20

	HFC		
	0.3	0.6	1.0
	2.00	1.50	1.00

	HFC		HFC	
	RPMX	APMX/I	RPMX	APMX/I
25	12.0	1.0/6	0.9	1.00/65
32	7.5	1.0/11	0.5	0.75/100
40	3.6	1.0/17	0.4	0.55/100



DCX	DMIN	DMAX	SMAX DMIN	SMAX DMAX
25	35.0	50.0	0.45	1.00
32	49.0	64.0	0.45	0.85
40	65.0	80.0	0.50	0.85



DCX	a_p	f_{max}
25	0.15	0.15
32	0.15	0.17
40	0.15	0.20



DCX	μm	3	5	10	15	20	30	40	50	60	80	100	
25		0.548	0.707	1.000	1.225	1.414	1.732	2.000	2.236	2.449	2.828	3.162	
32		0.620	0.800	1.131	1.386	1.600	1.960	2.263	2.530	2.771	3.200	3.578	
40		0.693	0.894	1.265	1.549	1.789	2.191	2.530	2.828	3.098	3.578	4.000	
50													
63													

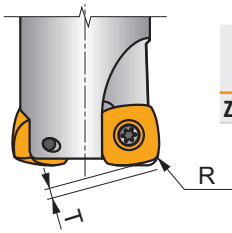

	R	T
ZDCW 09T304	2.27	0.52

SZD12

P **K** **H**

PRAMET

S



ZD12 Hochvorschubfräser mit Innenkühlung

Hochproduktiver Fräser mit hohem Vorschub und einseitigem ZD .. 12-Wendeschneidplatten mit 4 Schneidkanten und einem APMX von 1.6 mm. Innenkühlung. Geeignet für eine Vielzahl von Anwendungen. Erhältlich mit zylindrischen, modularen Schaft und als Aufsteckfräser. Körper für längere Standzeiten oberflächenbehandelt.

FEED ZD

APMX	1.6 mm
------	--------

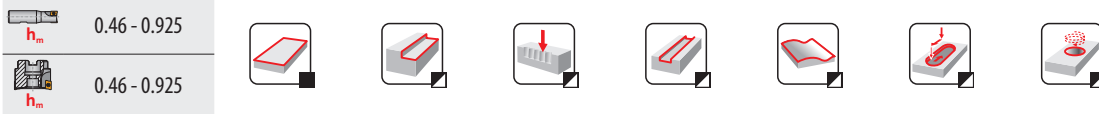
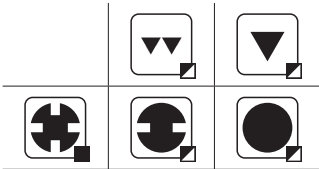
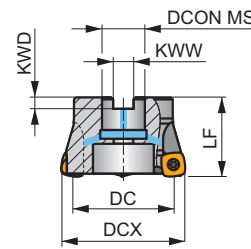
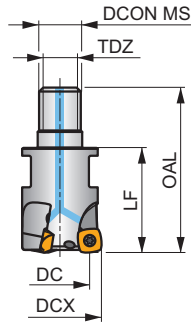
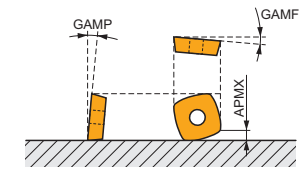

Produkt	DCX	DC	OAL	DCON MS	LU	LF	TDZ	KWW	KWD	GAMF	GAMP								
	(mm)	(mm)	(mm)	(mm)	(mm)	(mm)	(mm)	(mm)	(mm)	(°)	(°)				kg				
32E3R040M16-SZD12-C	32	14.5	63	17	-	40	M16	-	-	-6	10	3	-	-	✓	0.19	GI192	SQ220	-
40E4R040M16-SZD12-C	40	22.5	63	17	-	40	M16	-	-	-6	10	4	-	-	✓	0.22	GI192	SQ220	-
50A04R-SMOZD12-C	50	32.5	-	22	-	40	-	10.4	6.4	-6	10	4	✓	14000	✓	0.38	GI192	SQ033	-
63A05R-SMOZD12-C	63	45.5	-	22	-	40	-	10.4	6.4	-6	10	5	✓	12500	✓	0.57	GI192	SQ033	-
80A05R-SMOZD12-C	80	62.5	-	27	-	50	-	12	7	-6	10	5	✓	11100	✓	1.07	GI192	C0371	AC001

GI192	ZDEW 1204..

C0371	US 4011-T15P	3.5	M 4	10.6	D-T08P/T15P	FG-15	-	-
SQ033	US 4011-T15P	3.5	M 4	10.6	D-T08P/T15P	FG-15	-	HS 1030C
SQ220	US 4011-T15P	3.5	M 4	10.6	-	-	Flag T15P	-

AC001	KS 1230	K.FMH27

ZDEW 12



	IC	D1	S
	(mm)	(mm)	(mm)
1204	12.700	4.40	4.76

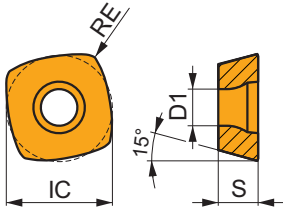

Eignung und Startwerte für Schnittgeschwindigkeit (vc), Vorschub (f) und Schnitttiefe (ap). Weitere Informationen finden Sie in unserer Zerspanungsrechner-App.

Produkt	RE (mm)	P			M			K			N			S			H		
		vc (m/min)	f (mm/tooth)	ap (mm)	vc (m/min)	f (mm/tooth)	ap (mm)	vc (m/min)	f (mm/tooth)	ap (mm)	vc (m/min)	f (mm/tooth)	ap (mm)	vc (m/min)	f (mm/tooth)	ap (mm)	vc (m/min)	f (mm/tooth)	ap (mm)

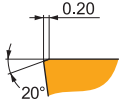
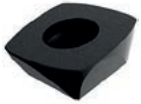

ZDEW besondere geometrie für die Bearbeitung mit hohem Vorschub.

ZDEW 120408:M8310	0.8	270	1.00	1.0	—	—	—	255	1.00	1.0	—	—	—	—	—	—	50	0.70	0.7
ZDEW 120408:M8325	0.8	205	1.00	1.0	—	—	—	—	—	—	—	—	—	—	—	—	—	—	—
ZDEW 120408:M8345	0.8	195	1.00	1.0	—	—	—	—	—	—	—	—	—	—	—	—	—	—	—



a_e DCX	5 %	10 %	15 %	20 %	25 %	30 %	40 %	50 %	60 %	70 %	75 %	80 %	90 %	100 %
	1.48	1.35	1.27	1.22	1.19	1.16	1.11	1.08	1.05	1.03	1.00	1.00	1.00	1.00
	2.20	1.60	1.35	1.20	1.10	0.95	0.85	0.75	0.85	0.95	1.00	1.00	1.00	1.00
	0.64	0.64	0.64	0.64	0.64	0.65	0.65	0.67	0.68	0.71	0.72	0.74	0.79	1.00

	ZDEW 12
	0.8
	-

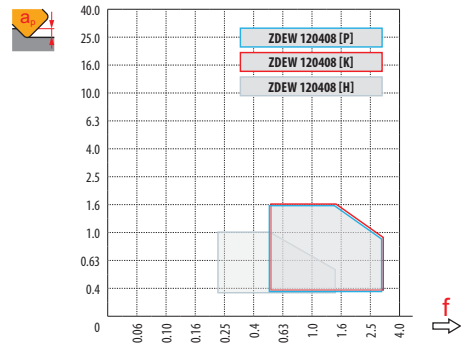

		0.00	0.50	0.60	0.70	0.80	0.90	1.00	1.10	1.20	1.30	1.40	1.50	1.60
32		14.5	22.7	23.5	24.2	24.8	25.4	26.0	26.5	27.0	27.5	28.0	28.5	28.9
40		22.5	30.7	31.5	32.2	32.8	33.4	34.0	34.5	35.0	35.5	36.0	36.5	36.9
50		32.5	40.7	41.5	42.2	42.8	43.4	44.0	44.5	45.0	45.5	46.0	46.5	46.9
63		45.5	53.7	54.5	55.2	55.8	56.4	57.0	57.5	58.0	58.5	59.0	59.5	59.9
80		62.5	70.7	71.5	72.2	72.8	73.4	74.0	74.5	75.0	75.5	76.0	76.5	76.9
		0.00	0.50	0.60	0.70	0.80	0.90	1.00	1.10	1.20	1.30	1.40	1.50	1.60
		-	3.00	3.00	3.00	3.00	3.00	3.00	2.50	2.25	2.00	1.80	1.65	1.50

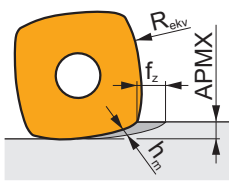

$$f_z = h_m \times \sqrt{\frac{2R_{ekv}}{APMX}} \quad (\text{mm/Zahn})$$



Befolgen Sie die Anweisungen für das Planfräsen. Beim Fräsen nahe der senkrechten Fläche verringern Sie den Vorschub pro Zahn (f_z) auf 50 %, um Vibrationen und Beschädigungen der Schneide zu vermeiden.

	f_{max}	f_{max}
32	10.0	0.15
40	10.0	0.17
50	10.0	0.20
63	10.0	0.20
80	10.0	0.25

	HFC		
	0.5	1.0	1.6
	3.00	2.00	1.50

	RPMX	APMX/l	RPMX	APMX/l
32	10	1.6/11	1.2	1.60/78
40	5.5	1.6/18	0.7	1.10/100
50	3.3	1.6/29	0.5	0.75/100
63	2.2	1.6/43	0.3	0.40/100
80	1.5	1.6/63	0.2	0.20/100



DCX	D _{MIN}	D _{MAX}	S _{MAX} D _{MIN}	S _{MAX} D _{MAX}
32	44.0	64.0	0.75	1.60
40	60.0	80.0	0.75	1.50
50	80.0	100.0	0.80	1.35
63	106.0	126.0	0.70	1.00
80	140.0	160.0	0.65	0.85



DCX	a _p	f _{max}
32	0.25	0.15
40	0.25	0.17
50	0.25	0.20
63	0.25	0.20
80	0.25	0.25



DCX	μm	3	5	10	15	20	30	40	50	60	80	100
32		0.620	0.800	1.131	1.386	1.600	1.960	2.263	2.530	2.771	3.200	3.578
40		0.693	0.894	1.265	1.549	1.789	2.191	2.530	2.828	3.098	3.578	4.000
50		0.775	1.000	1.414	1.732	2.000	2.449	2.828	3.162	3.464	4.000	4.472
63		0.869	1.122	1.587	1.944	2.245	2.750	3.175	3.550	3.888	4.490	5.020
80		0.980	1.265	1.789	2.191	2.530	3.098	3.578	4.000	4.382	5.060	5.657

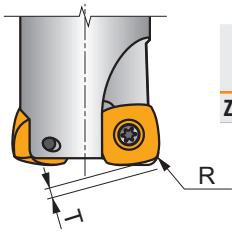



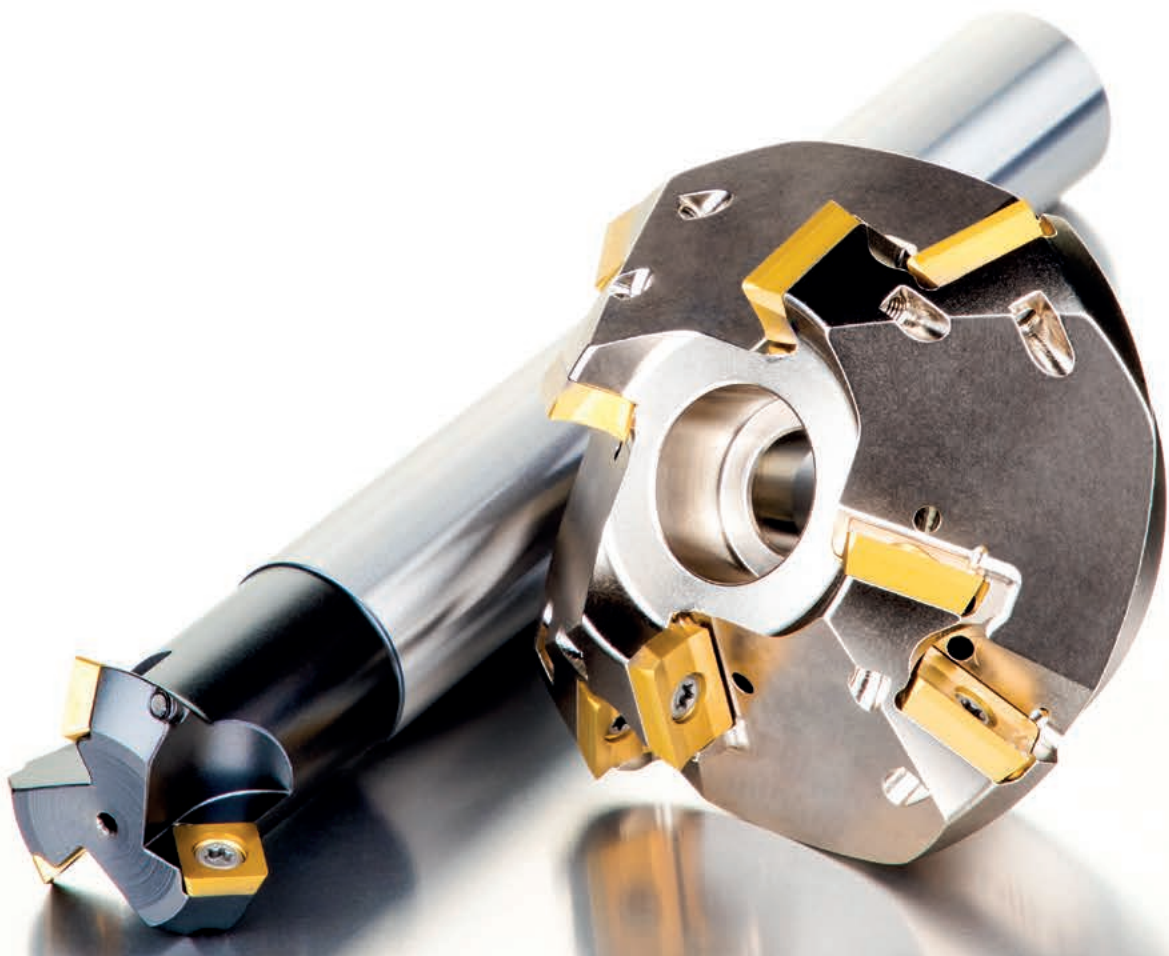











	R	T
ZDEW 120408	3.52	0.64



ANFASEN

WENDEPLATTENFRÄSER – AUSWAHLHILFE

PLANFRÄSEN

	SSD09	N-SSO09	STC	2516	2636	J(T)-SXP16															
	45°		45°		10°–80°		15°–75°														
	APMX (mm)	4.5	APMX (mm)	4.5	APMX (mm)	8.0	APMX (mm)	8.5	APMX (mm)	8.5	APMX (mm)	7.0–28.0									
	DC (mm)	10–25	DC (mm)	8–25	DC (mm)	20	DC (mm)	11–19	DC (mm)	5–23	DC (mm)	35–45									
Zylindrischer Schaft	 DC = 16, 25 (mm)																				
Weldon	 DC = 10 – 25 (mm)																				
Modular	 DC = 16, 25 (mm)																				
Aufsteckfräser																					
Seite	292		295		298		301		304		307										
ISO	P	M	K	S	H	P	M	K	S	P	M	K	N	P	M	K	N	P	M	K	N
Schneidplattenform																					
Wendeschneidplatten	SDE. 0903		SOMT 09T3		TCTX 16 STC		TCMT 16T3		TCMT 16T3		XPHT 1604										
Anzahl der Schneiden	4		4		3		3		3		2										
Fasenfräsen 	■		■		■		■		■		■										

SSD09

P M K S H

PRAMET

S



45° Fasenfräser für quadratische SD.. 09 Wendeschneidplatten

Ein 45° Fasenfräser mit einseitigen SD.. 09 Wendeschneidplatten und APMX von 4.5 mm. Geeignet für das Fasen auf der Ober- und Unterseite. Erhältlich mit zylindrischem Schaft, Weldon- oder Morsekegelschaft. Für längere Standzeiten ist der Körper oberflächenbehandelt.

KAPR	45°
APMX	4.5 mm

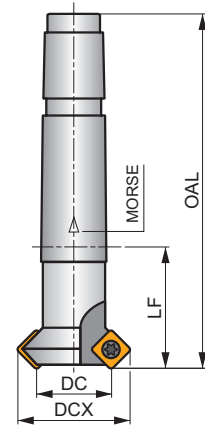
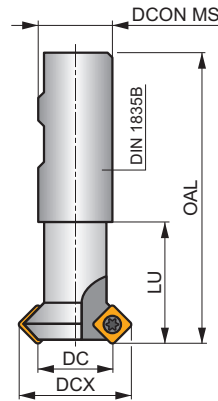
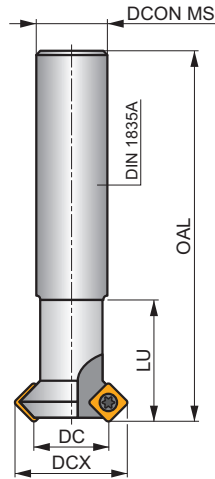
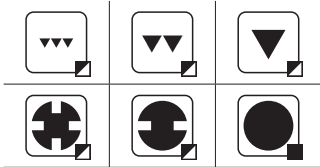
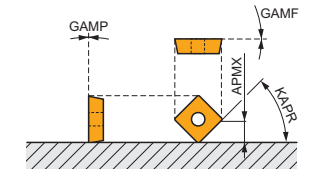

h_m 0.095 - 0.15



Produkt	DC (mm)	DCX (mm)	OAL (mm)	DCON MS (mm)	LU (mm)	LF (mm)	CZC MS	GAMF (°)	GAMP (°)			max. 		kg		
16N2R027A16-SSD09	16	28	200	16	27	-	-	0	0	2	-	32200	-	0.34	GI129	C0070
25N3R042A25-SSD09	25	37	200	25	42	-	-	0	0	3	-	25800	-	0.77	GI129	CH011
10N1R027B16-SSD09-A	10	22	75	16	27	-	-	0	0	1	-	40700	-	0.13	GI129	C0070
16N2R027B16-SSD09-A	16	28	75	16	27	-	-	0	0	2	-	32200	-	0.14	GI129	C0070
25N3R042B25-SSD09-A	25	37	98	25	42	-	-	0	0	3	-	25800	-	0.37	GI129	CH011
16N2R030E02-SSD09-A	16	28	94	-	-	30	2	0	0	2	-	32200	-	0.14	GI129	C0070
25N3R043E03-SSD09-A	25	37	124	-	-	43	3	0	0	3	-	25800	-	0.38	GI129	CH011

GI129	SDEW 0903..	SDEX 0903..

C0070	US 3507-T15	3.0	M 3.5	7	Flag T15
CH011	US 3509-T15	3.0	M 3.5	9	Flag T15

SDEW 09



	IC (mm)	D1 (mm)	S (mm)
0903	9.525	4.40	3.18

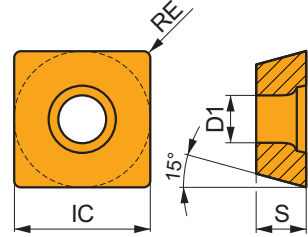

Eignung und Startwerte für Schnittgeschwindigkeit (vc), Vorschub (f) und Schnitttiefe (ap). Weitere Informationen finden Sie in unserer Zerspanungsrechner-App.

Produkt	RE (mm)	P			M			K			N			S			H		
		vc (m/min)	f (mm/tooth)	ap (mm)	vc (m/min)	f (mm/tooth)	ap (mm)	vc (m/min)	f (mm/tooth)	ap (mm)	vc (m/min)	f (mm/tooth)	ap (mm)	vc (m/min)	f (mm/tooth)	ap (mm)	vc (m/min)	f (mm/tooth)	ap (mm)



EN geometrie ohne Spanwinkel zum 45° Fasenfräsen.

SDEW 090308EN:M8330	0.8	235	0.10	4.5	–	–	–	220	0.10	4.5	–	–	–	–	–	–	45	0.09	0.7
SDEW 090308EN:M8340	0.8	210	0.10	4.5	–	–	–	195	0.10	4.5	–	–	–	–	–	–	–	–	–

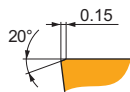

SN geometrie ohne Spanwinkel zum 45° Fasenfräsen.

SDEW 090308SN:M8330	0.8	215	0.15	4.5	–	–	–	200	0.15	4.5	–	–	–	–	–	–	40	0.11	0.7
SDEW 090308SN:M8340	0.8	195	0.15	4.5	–	–	–	185	0.15	4.5	–	–	–	–	–	–	–	–	–

SDEX 09



	IC (mm)	D1 (mm)	S (mm)
0903	9.525	4.40	3.18

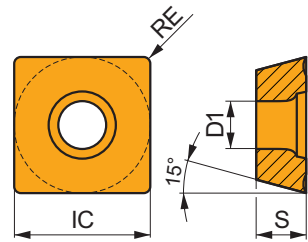

Eignung und Startwerte für Schnittgeschwindigkeit (vc), Vorschub (f) und Schnitttiefe (ap). Weitere Informationen finden Sie in unserer Zerspanungsrechner-App.

Produkt	RE (mm)	P			M			K			N			S			H		
		vc (m/min)	f (mm/tooth)	ap (mm)	vc (m/min)	f (mm/tooth)	ap (mm)	vc (m/min)	f (mm/tooth)	ap (mm)	vc (m/min)	f (mm/tooth)	ap (mm)	vc (m/min)	f (mm/tooth)	ap (mm)	vc (m/min)	f (mm/tooth)	ap (mm)

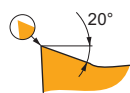

74 geometrie mit positiven Design zum 45° Fasenfräsen.

SDEX 090308FN-74:M8330	0.8	305	0.12	4.5	180	0.11	4.5	285	0.12	4.5	–	–	–	75	0.11	3.6	–	–	–
-------------------------------	-----	-----	------	-----	-----	------	-----	-----	------	-----	---	---	---	----	------	-----	---	---	---



	SDEW 09 EN	SDEW 09 SN	SDEX 09-74
	0.8	0.8	0.8
	-	-	-

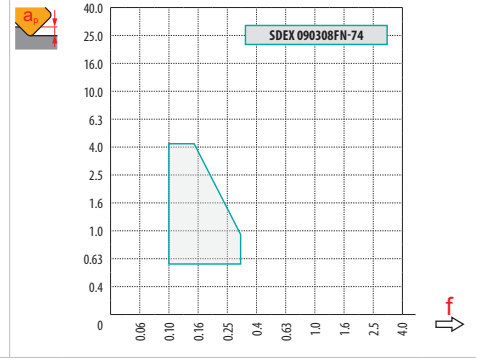
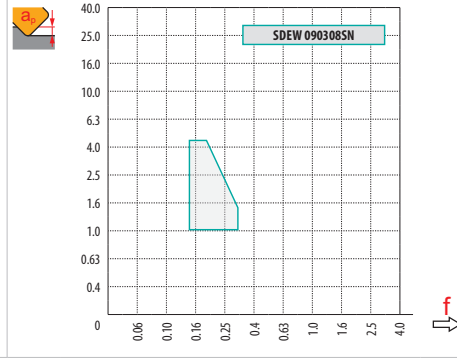
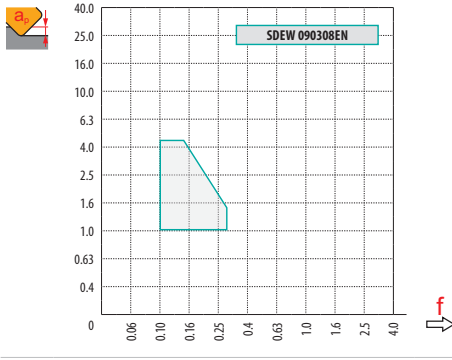

DC	DCX	X.V	f _{min}	f _{max}
10	22	1.09	0.20	0.30
16	28	1.17	0.25	0.34
25	37	1.24	0.32	0.39



a _b / DC	0.10	0.15	0.20	0.25	0.30	0.35	0.40	0.50 – 1.00																
45°	0.42	0.54	0.67	0.35	0.44	0.55	0.30	0.38	0.47	0.27	0.34	0.42	0.25	0.31	0.39	0.23	0.29	0.36	0.21	0.27	0.34	0.19	0.24	0.30
X.V	1.35		1.27		1.22		1.19		1.16		1.13		1.11		1.00									

N-SS009

P **M** **K** **S**

PRAMET

S



45° Fasenfräser für quadratische SOMT 09 Wendeschneidplatten mit Innenkühlung

Ein 45° Fasenfräser mit einseitigen SOMT 09 Wendeschneidplatten und APMX von 4.5 mm und Innenkühlung. Geeignet für das Fasen auf der Ober- und Unterseite. Erhältlich mit Weldonschaft. Für längere Standzeiten ist der Körper oberflächenbehandelt.

KAPR	45°
APMX	4.5 mm

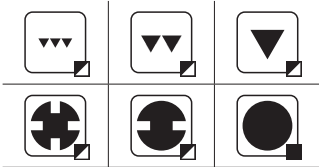
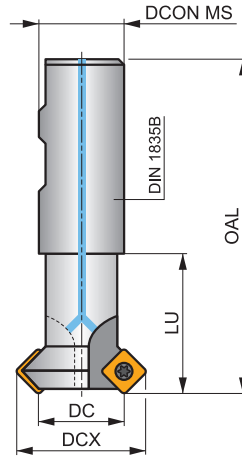
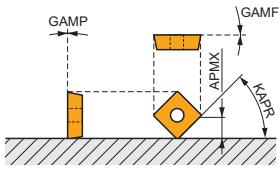

h_m 0.095 - 0.18



Produkt	DC	DCX	OAL	DCON MS	LU	GAMF	GAMP			max.		kg		
	(mm)	(mm)	(mm)	(mm)	(mm)	(°)	(°)							
16N2R027B16-SS009-C	16	28.8	110	16	27	0	0	2	-	26600	✓	0.23	G1146	SQ500
25N3R042B25-SS009-C	25	37.8	125	25	42	0	0	3	-	21300	✓	0.49	G1146	SQ500
8N1R027B16-SS009-C	8	20.5	90	16	27	0	0	1	-	37700	✓	0.16	G1146	SQ500

G1146	SOMT 09T3..

SQ500	US 3006-T09P	2.0	M3	6	Flag T09P

SOMT 09



	IC	D1	L	S
	(mm)	(mm)	(mm)	(mm)
09T3	9.550	3.50	9.55	3.97

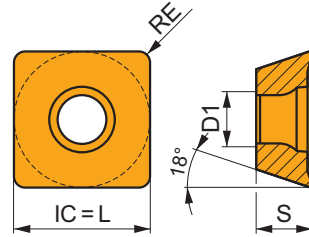

Eignung und Startwerte für Schnittgeschwindigkeit (vc), Vorschub (f) und Schnitttiefe (ap). Dies gilt für einen Einstellwinkel von 90°. Weitere Berechnungen finden Sie in unserer App.

Produkt	RE (mm)	P			M			K			N			S			H		
		vc (m/min)	f (mm/tooth)	ap (mm)	vc (m/min)	f (mm/tooth)	ap (mm)	vc (m/min)	f (mm/tooth)	ap (mm)	vc (m/min)	f (mm/tooth)	ap (mm)	vc (m/min)	f (mm/tooth)	ap (mm)	vc (m/min)	f (mm/tooth)	ap (mm)

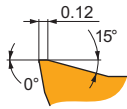
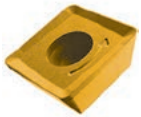

M geometrie mit positiven Design zur mittleren Bearbeitung.

SOMT 09T308-M:8215	0.8	275	0.14	2.5	165	0.13	2.5	260	0.14	2.5	-	-	-	65	0.13	2.0	-	-	-
SOMT 09T308-M:M5315	0.8	390	0.14	2.5	-	-	-	370	0.14	2.5	-	-	-	-	-	-	-	-	-
SOMT 09T308-M:M8330	0.8	270	0.14	2.5	160	0.13	2.5	255	0.14	2.5	-	-	-	65	0.13	2.0	-	-	-
SOMT 09T308-M:M8340	0.8	250	0.14	2.5	150	0.13	2.5	235	0.14	2.5	-	-	-	60	0.13	2.0	-	-	-
SOMT 09T308-M:M9315	0.8	380	0.14	2.5	-	-	-	360	0.14	2.5	-	-	-	-	-	-	-	-	-

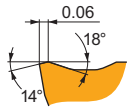
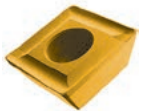

MI geometrie mit stabilen positiven Design zur mittleren Bearbeitung.

SOMT 09T304-MI:8215	0.4	230	0.14	2.5	135	0.13	2.5	215	0.14	2.5	-	-	-	55	0.10	2.0	-	-	-
SOMT 09T304-MI:M8310	0.4	255	0.14	2.5	130	0.13	2.5	240	0.14	2.5	-	-	-	-	-	-	-	-	-
SOMT 09T304-MI:M8330	0.4	230	0.14	2.5	135	0.13	2.5	215	0.14	2.5	-	-	-	55	0.10	2.0	-	-	-
SOMT 09T304-MI:M8340	0.4	210	0.14	2.5	125	0.13	2.5	195	0.14	2.5	-	-	-	50	0.10	2.0	-	-	-
SOMT 09T304-MI:M9315	0.4	320	0.14	2.5	-	-	-	300	0.14	2.5	-	-	-	-	-	-	-	-	-
SOMT 09T304-MI:M9340	0.4	265	0.14	2.5	155	0.13	2.5	-	-	-	-	-	-	65	0.10	2.0	-	-	-

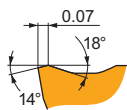
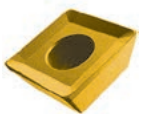

P geometrie mit sehr positiven Design zur mittleren Bearbeitung.

SOMT 09T304-P:M8330	0.4	250	0.14	2.5	150	0.13	2.5	235	0.14	2.5	-	-	-	60	0.10	2.0	-	-	-
SOMT 09T304-P:M8340	0.4	230	0.14	2.5	135	0.13	2.5	215	0.14	2.5	-	-	-	55	0.10	2.0	-	-	-
SOMT 09T304-P:M9325	0.4	320	0.14	2.5	-	-	-	300	0.14	2.5	-	-	-	-	-	-	-	-	-



	SOMT 09-M	SOMT 09-MI	SOMT 09-P
	0.8	0.4	0.4
	-	-	-

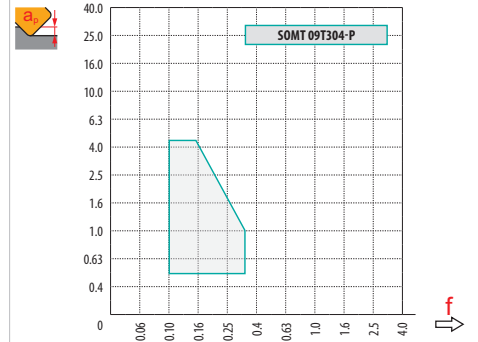
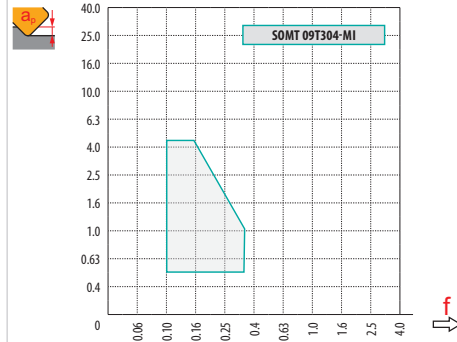
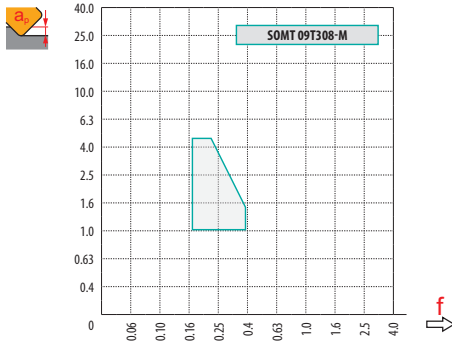

DC	DCX	X.V	f _{min}	f _{max}
8	20.5	1.06	0.18	0.29
16	28.8	1.17	0.25	0.34
25	37.8	1.24	0.32	0.39



a _e / DC	0.10		0.15		0.20		0.25		0.30		0.35		0.40		0.50 – 1.00									
	f																							
45°	0.42	0.63	0.80	0.35	0.51	0.66	0.30	0.44	0.57	0.27	0.40	0.51	0.25	0.36	0.46	0.23	0.33	0.43	0.21	0.31	0.40	0.19	0.28	0.36
X.V	1.35		1.27		1.22		1.19		1.16		1.13		1.11		1.00									

STC



PRAMET



45° Fasenfräser und Gravierfräser für TC.T 16 Wendeschneidplatten mit Innenkühlung

Ein 45° Fasenfräser und Gravierfräser mit einseitigen TC.T 16 Wendeschneidplatten mit APMX von 8,5 mm und Innenkühlung. Geeignet für das Fasen auf der Oberseite. Erhältlich mit Weldonschaft. Für längere Standzeiten ist der Körper oberflächenbehandelt.

KAPR	45°
------	-----

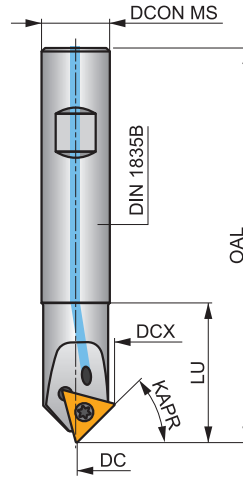
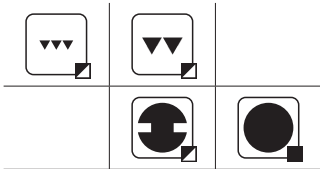
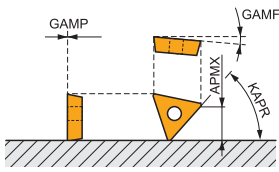

Produkt	DCX (mm)	DC (mm)	OAL (mm)	DCON MS (mm)	LU (mm)					
20N1R040B20-STC-000887	22.8	1.1	114	20	40	1	✓	0.26	GI223	SQ222

	GI223		TC.T 16 STC
--	-------	--	-------------

SQ222	US 2002-T15P	3.0	4	8.5	Flag T15P

TCXT 16 STC



	IC	D1	L	S
	(mm)	(mm)	(mm)	(mm)
16	9.525	4.60	16.50	3.97

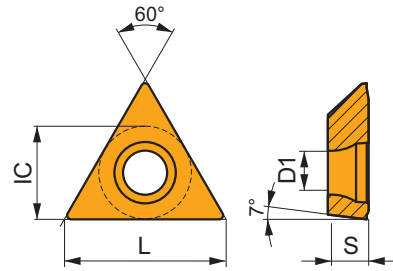

Produkt	Intermittent/ Continuous cut	RE (mm)	P			M			K			N			S			H		
			vc (m/min)	f (mm/tooth)	ap (mm)	vc (m/min)	f (mm/tooth)	ap (mm)	vc (m/min)	f (mm/tooth)	ap (mm)	vc (m/min)	f (mm/tooth)	ap (mm)	vc (m/min)	f (mm/tooth)	ap (mm)	vc (m/min)	f (mm/tooth)	ap (mm)

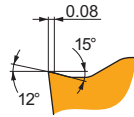
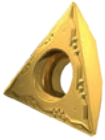

328 Spanbrecher ist positiv und die erste Wahl für die Schlichtbearbeitung von Stählen. Er hat einen leicht positiven Spanwinkel ohne Fase. Er ist auch für Gusseisen geeignet.

TCMT 16-001328:M8330	–	0.4	■	150	0.13	8.5	■	90	0.12	8.5	■	140	0.13	8.5	■	–	–	–	■	–	–	–	■	–	–	–
-----------------------------	---	-----	---	-----	------	-----	---	----	------	-----	---	-----	------	-----	---	---	---	---	---	---	---	---	---	---	---	---

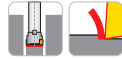

344 Spanbrecher ist scharf und die erste Wahl für die Allround-Bearbeitung von Nichteisenmetallen. Er zeichnet sich durch einen sehr positiven Spanwinkel ohne Fase aus. Er ist auch bedingt für Superlegierungen geeignet.

TCGT 16-001344:HF7	–	0.4	■	–	–	–	■	–	–	–	■	225	0.10	8.5	■	–	–	–	■	–	–	–	■	–	–	–
---------------------------	---	-----	---	---	---	---	---	---	---	---	---	-----	------	-----	---	---	---	---	---	---	---	---	---	---	---	---



	TCGT 16-001344	TCMT 16-001328
	0.4	0.4
	-	-

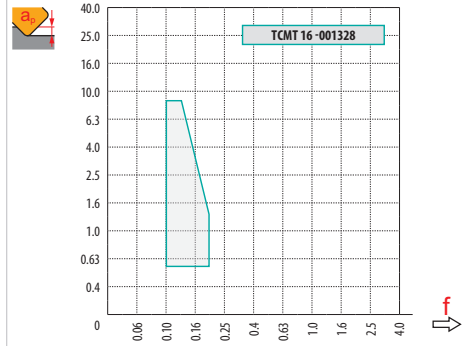
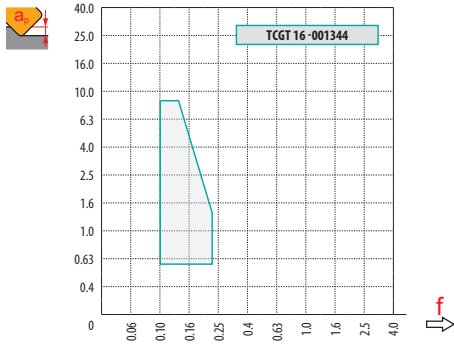

1.1	22.8	1.1	0.1	.018

2516

P M K N

PRAMET

S



45° Fasenfräser für TCMT 16 Wendeschneidplatten mit Innenkühlung

Ein 45° Fasenfräser mit einseitigen TCMT 16 Wendeschneidplatten mit APMX von 8.5 mm und Innenkühlung. Geeignet für das Fasen auf der Oberseite. Erhältlich mit Weldonschaft. Für längere Standzeiten ist der Körper oberflächenbehandelt.

KAPR	45°
APMX	8.5 mm

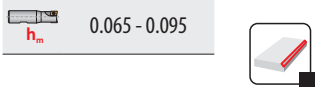
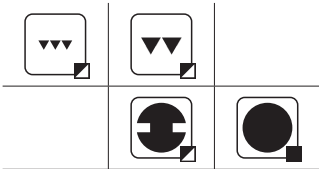
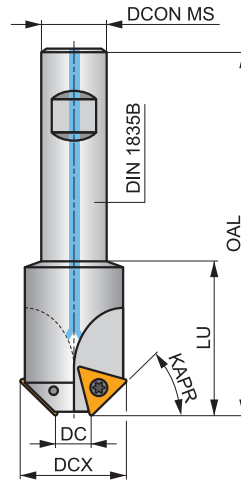
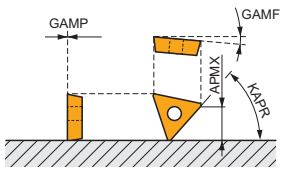

Produkt	DCX (mm)	DC (mm)	OAL (mm)	DCON MS (mm)	LU (mm)							
2516-45-11	31	11	100	16	30	2	-	18100	✓	0.20	G155	SQ220
2516-45-19	39	19	100	20	30	2	-	16200	✓	0.31	G155	SQ220

G155	TCMT 16T308E-FM:T8..

SQ220	US 4011-T15P	3.5	M 4	10.6	Flag T15P

TCMT



	IC	D1	L	S
	(mm)	(mm)	(mm)	(mm)
16T3	9.525	4.40	16.50	3.97

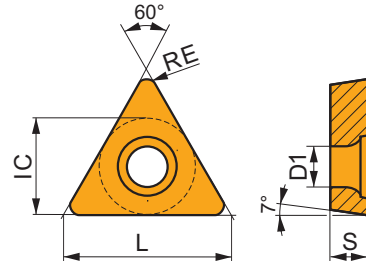

Eignung und Startwerte für Schnittgeschwindigkeit (vc), Vorschub (f) und Schnitttiefe (ap). Weitere Informationen finden Sie in unserer Zerspanungsrechner-App.

Produkt	RE (mm)	P			M			K			N			S			H		
		vc (m/min)	f (mm/rev)	ap (mm)	vc (m/min)	f (mm/rev)	ap (mm)	vc (m/min)	f (mm/rev)	ap (mm)	vc (m/min)	f (mm/rev)	ap (mm)	vc (m/min)	f (mm/rev)	ap (mm)	vc (m/min)	f (mm/rev)	ap (mm)

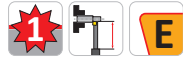
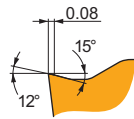

FM spanbrecher ist vielseitig und die erste Wahl für die Fertigbearbeitung von Stahl. Er zeichnet sich durch einen positiven Spanwinkel und eine positive, schmale Fase aus. Er ist auch für rostfreie Stähle und bedingt für Gusseisen und Nichteisenlegierungen geeignet.

TCMT 16T308E-FM:T8315	● 0.8	✓ 170	0.17	1.7	■ 100	0.15	1.7	✗ 160	0.17	1.7	✓ 510	0.20	1.7	—	—	—	—	—	—
TCMT 16T308E-FM:T8415	● 0.8	■ 210	0.17	1.7	■ 110	0.15	1.7	✗ 190	0.17	1.7	✓ 525	0.20	1.7	—	—	—	—	—	—
TCMT 16T308E-FM:T8430	● 0.8	■ 185	0.17	1.7	■ 100	0.15	1.7	✗ 150	0.17	1.7	✓ 510	0.20	1.7	—	—	—	—	—	—



	TCMT 16-FM
	0.8
	-

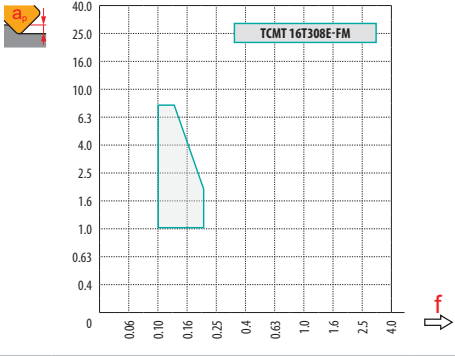

			f_{min}	f_{max}
11.0	31.0	1.02	0.10	0.18
19.0	39.0	1.10	0.14	0.20

2636



PRAMET



Einstellbarer Fasenfräser für TCMT 16 Wendeschneidplatten

Einstellbarer Fasenfräser mit TCMT 16 Wendeschneidplatten und APMX von 8.5 mm. Einstellbarer Bereich von 10° bis 80°. Erhältlich mit Weldonschaft. Für längere Standzeiten ist der Körper oberflächenbehandelt.

KAPR	10° – 80°
APMX	8.5 mm

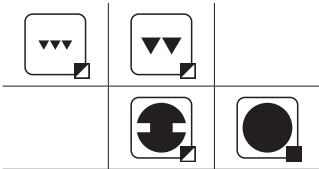
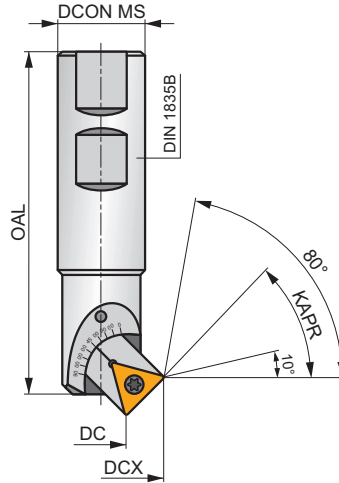
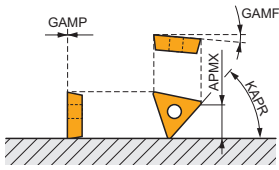

h_m 0.03 – 0.08



Produkt	DCN (mm)	DCX (mm)	OAL (mm)	DCON MS (mm)	KAPR (°)	GAMF (°)	GAMP (°)							
2636-05-25	5.0	31.0			10									
	5.5	31.0			15									
	7.0	29.5			30									
	11.0	29.5	100	25	45	-8	0	1	-	18100	-	0.35	GI294	CH040
	16.0	28.5			60									
	21.0	26.5			75									
	23.0	26.0			80									

GI294	TCMT 16T304E-FM:T8...	TCMT 16T308E-FM:T8...

CH040	USI 0614	CA 2669	US 4011-T15P	3.5	M 4	10.6	Flag T15

TCMT



	IC (mm)	D1 (mm)	L (mm)	S (mm)
16T3	9.525	4.40	16.50	3.97

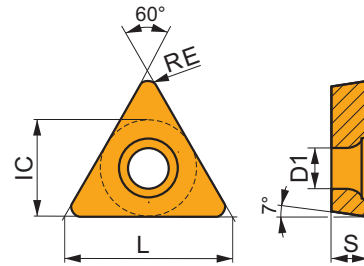

Eignung und Startwerte für Schnittgeschwindigkeit (vc), Vorschub (f) und Schnitttiefe (ap). Weitere Informationen finden Sie in unserer Zerspanungsrechner-App.

Produkt	RE (mm)	P			M			K			N			S			H		
		vc (m/min)	f (mm/rev)	ap (mm)	vc (m/min)	f (mm/rev)	ap (mm)	vc (m/min)	f (mm/rev)	ap (mm)	vc (m/min)	f (mm/rev)	ap (mm)	vc (m/min)	f (mm/rev)	ap (mm)	vc (m/min)	f (mm/rev)	ap (mm)

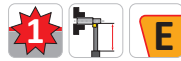
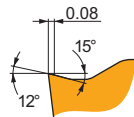

FM spanbrecher ist vielseitig und die erste Wahl für die Fertigbearbeitung von Stahl. Er zeichnet sich durch einen positiven Spanwinkel und eine positive, schmale Fase aus. Er ist auch für rostfreie Stähle und bedingt für Gusseisen und Nichteisenlegierungen geeignet.

TCMT 16T304E-FM:T8315	● 0.4	✓ 155	0.12	1.7	■ 90	0.11	1.7	✗ 145	0.12	1.7	✓ 465	0.14	1.7	–	–	–	–	–	–
TCMT 16T304E-FM:T8415	● 0.4	✓ 190	0.12	1.7	■ 100	0.11	1.7	✗ 170	0.12	1.7	✓ 480	0.14	1.7	–	–	–	–	–	–
TCMT 16T304E-FM:T8430	● 0.4	✓ 180	0.12	1.7	■ 95	0.11	1.7	✗ 145	0.12	1.7	✓ 495	0.14	1.7	–	–	–	–	–	–
TCMT 16T308E-FM:T8315	● 0.8	✓ 170	0.17	1.7	■ 100	0.15	1.7	✗ 160	0.17	1.7	✓ 510	0.20	1.7	–	–	–	–	–	–
TCMT 16T308E-FM:T8415	● 0.8	✓ 210	0.17	1.7	■ 110	0.15	1.7	✗ 190	0.17	1.7	✓ 525	0.20	1.7	–	–	–	–	–	–
TCMT 16T308E-FM:T8430	● 0.8	✓ 185	0.17	1.7	■ 100	0.15	1.7	✗ 150	0.17	1.7	✓ 510	0.20	1.7	–	–	–	–	–	–



TCMT 16-FM		
	0.8	0.4
	-	-

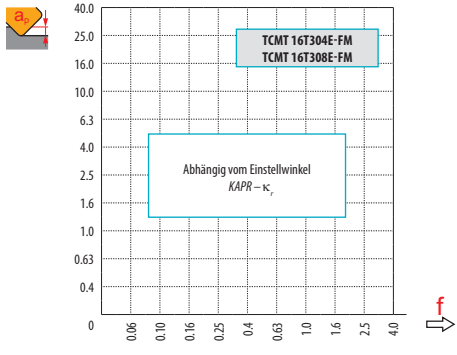

10°	2.6	5.0	31.0	1.38	0.24	0.59
15°	3.9	5.5	31.0	1.30	0.17	0.40
30°	7.6	7.0	29.5	1.18	0.10	0.20
45°	10.7	11.0	29.5	1.13	0.09	0.14
60°	13.2	16.0	28.5	1.09	0.09	0.11
75°	14.7	21.0	26.5	1.06	0.09	0.10
80°	15.0	23.0	26.0	1.06	0.09	0.10



a_e / DC	0.10	0.15	0.20	0.25	0.30	0.35	0.40	0.50 - 1.00																
10°	0.55	0.91	1.46	0.45	0.74	1.19	0.39	0.64	1.03	0.35	0.58	0.92	0.32	0.53	0.84	0.29	0.49	0.78	0.27	0.46	0.73	0.24	0.41	0.65
15°	0.37	0.61	0.98	0.30	0.50	0.80	0.26	0.43	0.69	0.23	0.39	0.62	0.21	0.35	0.56	0.20	0.33	0.52	0.18	0.31	0.49	0.16	0.27	0.44
30°	0.19	0.32	0.51	0.15	0.26	0.41	0.13	0.22	0.36	0.12	0.20	0.32	0.11	0.18	0.29	0.10	0.17	0.27	0.09	0.16	0.25	0.08	0.14	0.23
45°	0.13	0.22	0.36	0.11	0.18	0.29	0.09	0.16	0.25	0.08	0.14	0.23	0.08	0.13	0.21	0.07	0.12	0.19	0.07	0.11	0.18	0.06	0.10	0.16
60°	0.11	0.18	0.29	0.09	0.15	0.24	0.08	0.13	0.21	0.07	0.12	0.18	0.06	0.11	0.17	0.06	0.10	0.16	0.05	0.09	0.15	0.05	0.08	0.13
75°	0.10	0.16	0.26	0.08	0.13	0.21	0.07	0.12	0.19	0.06	0.10	0.17	0.06	0.09	0.15	0.05	0.09	0.14	0.05	0.08	0.13	0.04	0.07	0.12
80°	0.10	0.16	0.26	0.08	0.13	0.21	0.07	0.11	0.18	0.06	0.10	0.16	0.06	0.09	0.15	0.05	0.09	0.14	0.05	0.08	0.13	0.04	0.07	0.11
	1.35		1.27		1.22		1.19		1.16		1.13		1.11		1.00									

J(T)-SXP16



PRAMET



Walzenstirfräser zum Fasenfräsen mit XPHT 16 Wendeschneidplatten und Innenkühlung

Fasenfräser mit einseitigen XPHT 16-Wendeschneidplatten mit APMX von 7 bis 28 mm. Innenkühlung. Geeignet fürs Fasen. Als Aufsteckfräser erhältlich im Bereich von 15°, 25°, 30°, 35°, 40°, 45°, 50°, 55°, 60° und 75° Fasenwinkel. Körper für längere Standzeiten oberflächenbehandelt.

KAPR	15° - 75°
APMX	7.0 - 28.0 mm

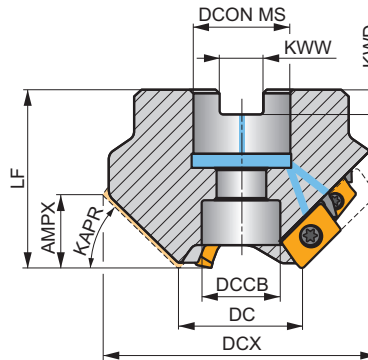
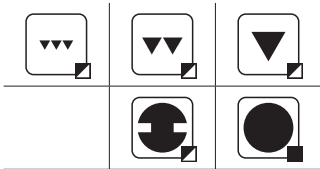
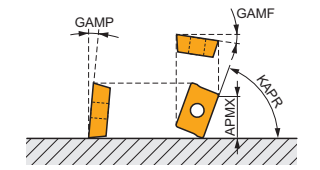

h_{min} 0.05 - 0.11



Produkt	DC	DCX	LF	DCON MS	DCCB	KAPR	KWW	KWD	APMX	GAMF	GAMP	NOF							
	(mm)	(mm)	(mm)	(mm)	(mm)	(°)	(mm)	(mm)	(mm)	(°)	(°)								
35T03R-S15XP1607-C	35	90.6	50	27	22	15	12.4	7	7.00	-6	-1	3	6	-	15200	✓	1.32	GI208	CH050
35T03R-S25XP1612-C	35	87.3	50	27	22	25	12.4	7	12.00	-6	0	3	6	-	15200	✓	1.15	GI208	CH050
35T03R-S30XP1614-C	35	85.1	50	27	22	30	12.4	7	14.00	-6	0	3	6	-	15200	✓	1.11	GI208	CH050
35T03R-S35XP1616-C	35	82.4	50	27	22	35	12.4	7	16.00	-6	0	3	6	-	15200	✓	1.04	GI208	CH050
35T03R-S40XP1618-C	35	79.4	50	27	22	40	12.4	7	18.00	-6	1	3	6	-	15200	✓	0.96	GI208	CH050
35T03R-S45XP1620-C	35	76.1	50	27	22	45	12.4	7	20.00	-6	2	3	6	-	15200	✓	0.90	GI208	CH050
35T03R-S50XP1622-C	35	72.4	50	27	22	50	12.4	7	22.00	-6	2	3	6	-	15200	✓	0.83	GI208	CH050
35T03R-S55XP1623-C	35	68.4	50	27	22	55	12.4	7	23.00	-6	2	3	6	-	15200	✓	0.72	GI208	CH050
35T03R-S60XP1625-C	35	64.2	50	27	22	60	12.4	7	25.00	-5	4	3	6	-	15200	✓	0.63	GI208	CH050
45T03R-S75XP1628-C	45	60.1	50	27	22	75	12.4	7	28.00	-5	5	3	6	-	13400	✓	0.64	GI208	CH050
45T04R-S25XP1612-C	45	97.3	50	27	22	25	12.4	7	12.00	-6	0	4	8	✓	13400	✓	1.24	GI208	CH050
45T04R-S30XP1614-C	45	95.1	50	27	22	30	12.4	7	14.00	-6	0	4	8	✓	13400	✓	1.21	GI208	CH050
45T04R-S35XP1616-C	45	92.4	50	27	22	35	12.4	7	16.00	-6	2	4	8	✓	13400	✓	1.30	GI208	CH050
45T04R-S40XP1618-C	45	89.5	50	27	22	40	12.4	7	18.00	-6	2	4	8	✓	13400	✓	1.08	GI208	CH050
45T04R-S45XP1620-C	45	86.1	50	27	22	45	12.4	7	20.00	-6	2	4	8	✓	13400	✓	1.03	GI208	CH050
45T04R-S50XP1622-C	45	82.4	50	27	22	50	12.4	7	22.00	-6	2	4	8	✓	13400	✓	0.96	GI208	CH050
45T04R-S55XP1623-C	45	78.4	50	27	22	55	12.4	7	23.00	-6	2	4	8	✓	13400	✓	0.88	GI208	CH050
45T04R-S60XP1625-C	45	74.2	50	27	22	60	12.4	7	25.00	-5	4	4	8	✓	13400	✓	0.78	GI208	CH050

GI208	XPHT 1604..
-------	-------------

CH050	US 3509-T15	3.0	M 3.5	9	D-T07/T15	FG-15	HS 1230C
-------	-------------	-----	-------	---	-----------	-------	----------

XPHT 16-FA



	W1	D1	L	S
	(mm)	(mm)	(mm)	(mm)
1604	9.525	4.40	15.88	4.76

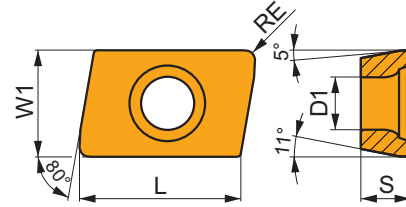

Produkt	RE (mm)	P			M			K			N			S			H		
		vc	f	ap	vc	f	ap	vc	f	ap	vc	f	ap	vc	f	ap	vc	f	ap
		(m/min)	(mm/tooth)	(mm)	(m/min)	(mm/tooth)	(mm)	(m/min)	(mm/tooth)	(mm)	(m/min)	(mm/tooth)	(mm)	(m/min)	(mm/tooth)	(mm)	(m/min)	(mm/tooth)	(mm)

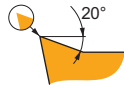

FA geometrie mit hoch positiven Design zum Fasenfräsen.

XPHT 160408F-FA:HF7	● 0.8	-	-	-	-	-	-	-	-	■ 255	0.12	15.0	-	-	-	-	-	-	-
----------------------------	-------	---	---	---	---	---	---	---	---	-------	------	------	---	---	---	---	---	---	---

XPHT 16



	W1	D1	L	S
	(mm)	(mm)	(mm)	(mm)
1604	9.525	4.40	15.88	4.76

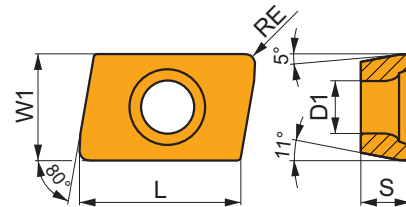

Eignung und Startwerte für Schnittgeschwindigkeit (vc), Vorschub (f) und Schnitttiefe (ap). Weitere Informationen finden Sie in unserer Zerspanungsrechner-App.

Produkt	RE (mm)	P			M			K			N			S			H		
		vc	f	ap	vc	f	ap	vc	f	ap	vc	f	ap	vc	f	ap	vc	f	ap
		(m/min)	(mm/tooth)	(mm)	(m/min)	(mm/tooth)	(mm)	(m/min)	(mm/tooth)	(mm)	(m/min)	(mm/tooth)	(mm)	(m/min)	(mm/tooth)	(mm)	(m/min)	(mm/tooth)	(mm)

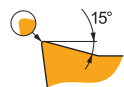

E positive geometrie zum Fasenfräsen.

XPHT 160412E:8215	● 1.2	■ 225	0.10	15.0	■ 135	0.09	15.0	■ 210	0.10	15.0	-	-	-	-	-	-	-	-
XPHT 160412E:M6330	● 1.2	■ 190	0.10	15.0	■ 135	0.09	15.0	-	-	-	-	-	-	-	-	-	-	-
XPHT 160412E:M8330	● 1.2	■ 220	0.10	15.0	■ 130	0.09	15.0	■ 205	0.10	15.0	-	-	-	-	-	-	-	-
XPHT 160412E:M8340	● 1.2	■ 195	0.10	15.0	■ 115	0.09	15.0	■ 185	0.10	15.0	-	-	-	-	-	-	-	-

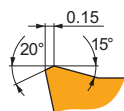

S geometrie mit sehr positiven Design zum Fasenfräsen.

XPHT 160412S:8215	● 1.2	■ 210	0.12	15.0	■ 125	0.11	15.0	■ 195	0.12	15.0	-	-	-	-	-	-	-	-
XPHT 160412S:M8330	● 1.2	■ 210	0.12	15.0	■ 125	0.11	15.0	■ 195	0.12	15.0	-	-	-	-	-	-	-	-
XPHT 160412S:M8340	● 1.2	■ 190	0.12	15.0	■ 110	0.11	15.0	■ 180	0.12	15.0	-	-	-	-	-	-	-	-

Eignung und Startwerte für Schnittgeschwindigkeit (vc), Vorschub (f) und Schnitttiefe (ap). Weitere Informationen finden Sie in unserer Zerspanungsrechner-App.

Produkt	RE (mm)	P			M			K			N			S			H		
		vc (m/min)	f (mm/tooth)	ap (mm)	vc (m/min)	f (mm/tooth)	ap (mm)	vc (m/min)	f (mm/tooth)	ap (mm)	vc (m/min)	f (mm/tooth)	ap (mm)	vc (m/min)	f (mm/tooth)	ap (mm)	vc (m/min)	f (mm/tooth)	ap (mm)

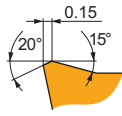

S-Geometrie mit sehr positiven Design zum Fasenfräsen.

XPHT 160412S:M9325	1.2	270	0.12	15.0	–	–	–	255	0.12	15.0	–	–	–	–	–	–	–	–
XPHT 160412S:M9340	1.2	245	0.12	15.0	145	0.11	15.0	–	–	–	–	–	–	–	–	–	–	–



	XPHT 16 E	XPHT 16 S	XPHT 16-FA
	1.2	1.2	0.8
	-	-	-

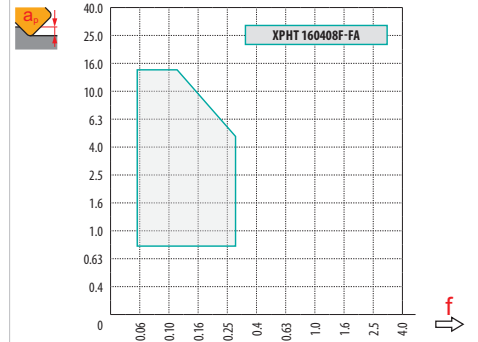
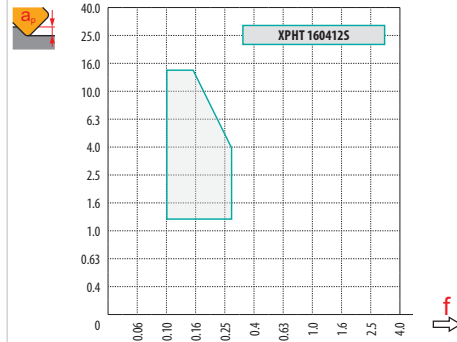
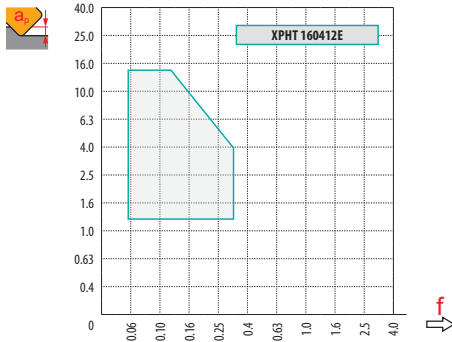

a_p / DC	0.10	0.15	0.20	0.25	0.30	0.35	0.40	0.50 - 1.00																		
	f																									
15°	0.61	0.98	1.34	0.50	0.80	1.10	0.43	0.69	0.95	0.39	0.62	0.85	0.35	0.56	0.78	0.33	0.52	0.72	0.31	0.49	0.67	0.27	0.44	0.60		
25°	0.37	0.60	0.82	0.31	0.49	0.67	0.26	0.42	0.58	0.24	0.38	0.52	0.22	0.35	0.48	0.20	0.32	0.44	0.19	0.30	0.41	0.17	0.27	0.37	0.37	
30°	0.32	0.51	0.70	0.26	0.41	0.57	0.22	0.36	0.49	0.20	0.32	0.44	0.18	0.29	0.40	0.17	0.27	0.37	0.16	0.25	0.35	0.14	0.23	0.31	0.31	
35°	0.28	0.44	0.61	0.23	0.36	0.50	0.19	0.31	0.43	0.17	0.28	0.38	0.16	0.25	0.35	0.15	0.24	0.32	0.14	0.22	0.30	0.12	0.20	0.27	0.27	
40°	0.25	0.39	0.54	0.20	0.32	0.44	0.17	0.28	0.38	0.16	0.25	0.34	0.14	0.23	0.31	0.13	0.21	0.29	0.12	0.20	0.27	0.11	0.18	0.24	0.24	
45°	0.22	0.36	0.49	0.18	0.29	0.40	0.16	0.25	0.35	0.14	0.23	0.31	0.13	0.21	0.28	0.12	0.19	0.26	0.11	0.18	0.25	0.10	0.16	0.22	0.22	
50°	0.21	0.33	0.45	0.17	0.27	0.37	0.15	0.23	0.32	0.13	0.21	0.29	0.12	0.19	0.26	0.11	0.18	0.24	0.10	0.17	0.23	0.09	0.15	0.20	0.20	
55°	0.19	0.31	0.42	0.16	0.25	0.35	0.14	0.22	0.30	0.12	0.20	0.27	0.11	0.18	0.25	0.10	0.17	0.23	0.10	0.15	0.21	0.09	0.14	0.19	0.19	
60°	0.18	0.29	0.40	0.15	0.24	0.33	0.13	0.21	0.28	0.12	0.18	0.25	0.11	0.17	0.23	0.10	0.16	0.21	0.09	0.15	0.20	0.08	0.13	0.18	0.18	
75°	0.16	0.26	0.36	0.13	0.21	0.29	0.12	0.19	0.25	0.10	0.17	0.23	0.09	0.15	0.21	0.09	0.14	0.19	0.08	0.13	0.18	0.07	0.12	0.16	0.16	
	1.35		1.27		1.22		1.19		1.16		1.13		1.11		1.00											



	a_p	DC	DCX	X.V	f_{min}	f_{max}
15°	7	35.0	90.6	1.16	0.43	0.70
25°	12	35.0	87.3	1.16	0.20	0.32
30°	14	35.0	85.1	1.17	0.16	0.25
35°	16	35.0	82.4	1.17	0.13	0.20
40°	18	35.0	79.4	1.17	0.11	0.16
45°	20	35.0	76.0	1.18	0.09	0.14
50°	22	35.0	72.4	1.18	0.08	0.12
55°	23	35.0	68.4	1.20	0.08	0.11
60°	25	35.0	64.1	1.20	0.07	0.09
25°	12	45.0	97.3	1.18	0.23	0.34
30°	14	45.0	95.0	1.18	0.18	0.26
35°	16	45.0	92.4	1.19	0.15	0.21
40°	18	45.0	89.5	1.19	0.12	0.17
45°	20	45.0	86.0	1.20	0.11	0.15
50°	22	45.0	82.4	1.21	0.09	0.13

	a_p	DC	DCX	X.V	f_{min}	f_{max}
55°	23	45.0	78.4	1.22	0.09	0.11
60°	25	45.0	74.1	1.23	0.08	0.10
75°	28	45.0	60.1	1.31	0.07	0.08



















Fräser mit Einstellwinkel 15° können als HFC verwendet werden. Verwenden Sie Vorschübe aus der Fasen-Tabelle.



NUTFRÄSEN

WENDEPLATTENFRÄSER – AUSWAHLHILFE

PLANFRÄSEN

	S90SN	S90CN(XN)	F-SCC			
	90°		90°		90°	
	APMX (mm) 4.0 – 14.0	APMX (mm) 14.0 – 30.5	APMX (mm) 11.0 – 18.0			
	DC (mm) 63 – 200	DC (mm) 125 – 315	DC (mm) 25 – 40			
Zylindrischer Schaft	 DC = 80 – 200 (mm)	 DC = 125 – 315 (mm)				
Weldon	 DC = 63 – 160 (mm)	 DC = 125 – 200 (mm)				
Modular						
Aufsteckfräser						
Seite	 314	 320	 325			
ISO	P M K	P M K	P M K			
Schneidplattenform						
Wendeschneidplatten	SNHQ 11 SNHQ 12	CNHQ 1005 XNHQ 1205 XNHQ 1606	CCMX			
Anzahl der Schneiden	4	2	2			
Tiefes Nutfräsen 	■	■				
Tiefes Eckfräsen 	▣	▣				
Planfräsen 	▣	▣				
Rückwärtiges Planfräsen 	▣	▣	■			
T-Nutfräsen 			■			
Flaches Eckfräsen 			▣			
Flaches Nutfräsen 			▣			

S90SN



PRAMET



Scheibenfräser

90° disc mill utilising SNHQ inserts. Suitable for slot, shoulder, rear side and face milling. Available in arbor or stub arbor style. Body treated for longer tool life.

KAPR	90°
CW	4.0 – 14.0 mm

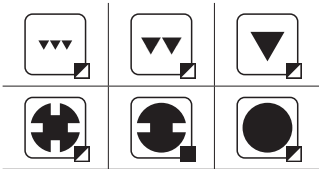
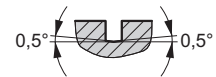
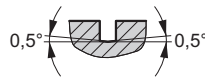
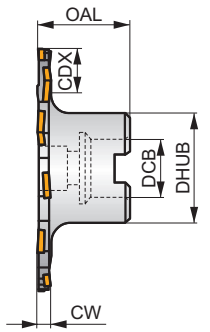
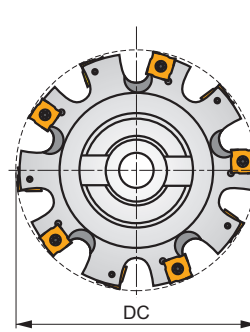
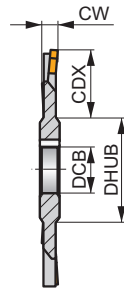
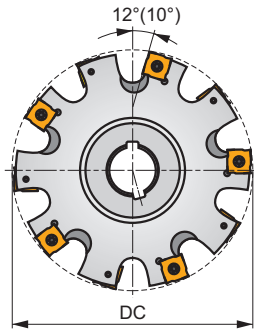
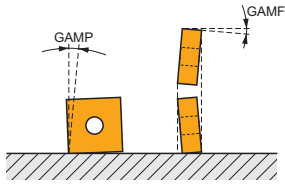

	0.07 – 0.09
	0.07 – 0.09



Produkt	DC	OAL	DCB	DHUB	CDX	CW	λ	GAMF	GAMP								
	(mm)	(mm)	(mm)	(mm)	(mm)	(mm)	(°)	(°)	(°)								
80F8N-S90SN11N4	80	-	27	42	16	4.00	-	2.5	-0.5	8	-	12300	-	0.21	G1151	DI011	-
80F8N-S90SN11N5	80	-	27	42	16	5.00	-	2.5	-0.5	8	-	12300	-	0.22	G1152	DI019	-
80F8N-S90SN12N6	80	-	27	42	16	6.00	-	2.5	-0.5	8	-	8400	-	0.25	G1153	DI012	-
80F8N-S90SN12N8	80	-	27	42	16	8.00	-	2.5	-0.5	8	-	8400	-	0.25	G1157	DI013	-
100G10N-S90SN12N6	100	-	32	48	24	6.00	-	2.5	-0.5	10	-	7500	-	0.43	G1153	DI012	-
100G10N-S90SN12N8	100	-	32	48	24	8.00	-	2.5	-0.5	10	-	7500	-	0.42	G1157	DI013	-
100G10N-S90SN12N10	100	-	32	48	24	10.00	-	2.5	-0.5	10	-	7500	-	0.46	G1154	DI014	-
100G10N-S90SN12N12	100	-	32	48	24	12.00	-	2.5	-0.5	10	-	7500	-	0.66	G1158	DI015	-
125H12N-S90SN12N6	125	-	40	58	31	6.00	-	2.5	-0.5	12	-	6700	-	0.62	G1153	DI012	-
125H12N-S90SN12N8	125	-	40	58	31	8.00	-	2.5	-0.5	12	-	6700	-	0.73	G1157	DI013	-
125H12N-S90SN12N10	125	-	40	58	31	10.00	-	2.5	-0.5	12	-	6700	-	0.66	G1154	DI014	-
125H12N-S90SN12N12	125	-	40	58	31	12.00	-	2.5	-0.5	12	-	6700	-	0.76	G1158	DI015	-
160H16N-S90SN12N6	160	-	40	58	43	6.00	-	2.5	-0.5	16	-	5900	-	0.86	G1153	DI012	-
160H16N-S90SN12N8	160	-	40	58	43	8.00	-	2.5	-0.5	16	-	5900	-	1.10	G1157	DI013	-
160H16N-S90SN12N10	160	-	40	58	43	10.00	-	2.5	-0.5	16	-	5900	-	1.14	G1154	DI014	-
160H16N-S90SN12N12	160	-	40	58	43	12.00	-	2.5	-0.5	16	-	5900	-	1.30	G1158	DI015	-
160H15N-S90SN12N14	160	-	40	58	43	14.00	-	2.5	-0.5	15	-	5900	-	1.40	G1158	DI015	-
200J18N-S90SN12N6	200	-	50	72	62	6.00	-	2.5	-0.5	18	-	5300	-	1.40	G1153	DI012	-
200J18N-S90SN12N8	200	-	50	72	62	8.00	-	2.5	-0.5	18	-	5300	-	1.78	G1157	DI013	-
200J18N-S90SN12N10	200	-	50	72	62	10.00	-	2.5	-0.5	18	-	5300	-	1.89	G1154	DI014	-
200J18N-S90SN12N12	200	-	50	72	62	12.00	-	2.5	-0.5	18	-	5300	-	2.23	G1158	DI015	-
200J18N-S90SN12N14	200	-	50	72	62	14.00	-	2.5	-0.5	18	-	5300	-	2.67	G1158	DI015	-
63A03R-S90SN11N4	63	40	16	34	10.5	4.00	3	2.5	-0.5	6	-	13900	-	0.37	G1151	DI021	-
63A03R-S90SN11N5	63	40	16	34	10.5	5.00	3	2.5	-0.5	6	-	13900	-	0.36	G1152	DI021	-
63A03R-S90SN12N6	63	40	16	34	10.5	6.00	3	2.5	-0.5	6	-	9500	-	0.37	G1153	DI022	-
80A04R-S90SN11N5	80	40	22	40	17.5	5.00	4	2.5	-0.5	8	-	12300	-	0.48	G1152	DI023	-
80A04R-S90SN12N6	80	40	22	40	17.5	6.00	4	2.5	-0.5	8	-	8400	-	0.50	G1153	DI024	-

Produkt	DC	OAL	DCB	DHUB	CDX	CW		GAMF	GAMP									
	(mm)	(mm)	(mm)	(mm)	(mm)	(mm)	(mm)	(°)	(°)									
100A05R-S90SN12N6	100	50	27	48	23.5	6.00	5	2.5	-0.5	10	-	7500	-	0.86	G1153	DI025	-	-
125B06R-S90SN12N6	125	50	40	56	24	6.00	6	2.5	-0.5	12	-	6700	-	1.20	G1153	DI012	AC003	-
160B08R-S90SN12N10	160	50	40	70	41	10.00	8	2.5	-0.5	16	-	5900	-	1.83	G1154	DI014	-	-

G1151	SNHQ 1102..
G1152	SNHQ 1103..
G1153	SNHQ 1203..
G1154	SNHQ 1205..
G1157	SNHQ 1204..
G1158	SNHQ 1207

DI011	US 3504-T09P	3.0	M 3.5	4	D-T07P/T09P	FG-15	-
DI012	US 70	5.0	M 4	5	D-T07/T15	FG-15	-
DI013	US 71	5.0	M 4	7	D-T07/T15	FG-15	-
DI014	US 72	5.0	M 4	9	D-T07/T15	FG-15	-
DI015	US 73	5.0	M 4	11	D-T07/T15	FG-15	-
DI019	US 3505-T09P	3.0	M 3.5	5	D-T07P/T09P	FG-15	HS 0830
DI021	US 3504-T09P	3.0	M 3.5	4	D-T07P/T09P	FG-15	HS 0830
DI022	US 70	5.0	M 4	5	D-T07/T15	FG-15	HS 0830
DI023	US 3505-T09P	3.0	M 3.5	5	D-T07P/T09P	FG-15	HS 1030
DI024	US 70	5.0	M 4	5	D-T07/T15	FG-15	HS 1030
DI025	US 70	5.0	M 4	5	D-T07/T15	FG-15	HS 1230

AC003	KS 2040	K.FMH40

SNHQ AZ



	IC (mm)	D1 (mm)	W1 (mm)
1102	11.000	4.30	2.300
1103	11.000	4.30	2.700
1203	12.700	5.00	3.200
1204	12.700	5.00	4.500
1205	12.700	5.00	5.400
1207	12.700	5.00	7.000
12T3	12.700	5.00	3.400

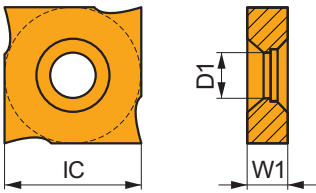

Eignung und Startwerte für Schnittgeschwindigkeit (vc), Vorschub (f) und Schnitttiefe (ap). Weitere Informationen finden Sie in unserer Zerspanungsrechner-App.

Produkt	RE (mm)	P			M			K			N			S			H		
		vc (m/min)	f (mm/tooth)	ap (mm)	vc (m/min)	f (mm/tooth)	ap (mm)	vc (m/min)	f (mm/tooth)	ap (mm)	vc (m/min)	f (mm/tooth)	ap (mm)	vc (m/min)	f (mm/tooth)	ap (mm)	vc (m/min)	f (mm/tooth)	ap (mm)

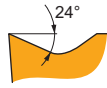

EN geometrie in besonderer Ausführung zum Nutfräsen.

SNHQ 1203AZEN:8215	☹	-	415	0.10	☑	245	0.10	☹	390	0.10	-	-	-	-	-	-	-	-	-
SNHQ 1203AZEN:M8340	☹	-	370	0.10	☑	220	0.10	☑	350	0.10	-	-	-	-	-	-	-	-	-
SNHQ 1204AZEN:8215	☹	-	405	0.10	☑	240	0.10	☹	380	0.10	-	-	-	-	-	-	-	-	-
SNHQ 1204AZEN:M8340	☹	-	355	0.10	☑	210	0.10	☑	335	0.10	-	-	-	-	-	-	-	-	-
SNHQ 1205AZEN:8215	☹	-	390	0.10	☑	230	0.10	☹	370	0.10	-	-	-	-	-	-	-	-	-
SNHQ 1205AZEN:M8340	☹	-	345	0.10	☑	205	0.10	☑	325	0.10	-	-	-	-	-	-	-	-	-
SNHQ 1207AZEN:8215	☹	-	380	0.10	☑	225	0.10	☹	360	0.10	-	-	-	-	-	-	-	-	-
SNHQ 1207AZEN:M8340	☹	-	335	0.10	☑	200	0.10	☑	315	0.10	-	-	-	-	-	-	-	-	-

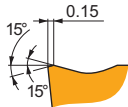

TN geometrie in besonderer Ausführung zum Nutfräsen.

SNHQ 1102AZTN:M8330	☹	-	365	0.20	☑	215	0.18	☹	345	0.20	-	-	-	-	-	-	-	-	-
SNHQ 1102AZTN:M8340	☹	-	335	0.20	☑	200	0.18	☑	315	0.20	-	-	-	-	-	-	-	-	-
SNHQ 1103AZTN:M8330	☹	-	345	0.20	☑	205	0.18	☹	325	0.20	-	-	-	-	-	-	-	-	-
SNHQ 1103AZTN:M8340	☹	-	315	0.20	☑	185	0.18	☑	295	0.20	-	-	-	-	-	-	-	-	-

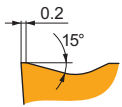

TN geometrie in besonderer Ausführung zum Nutfräsen.

SNHQ 1203AZTN:M8330	☹	-	345	0.20	☑	205	0.18	☹	325	0.20	-	-	-	-	-	-	-	-	-
SNHQ 1203AZTN:M8340	☹	-	315	0.20	☑	185	0.18	☑	295	0.20	-	-	-	-	-	-	-	-	-
SNHQ 1204AZTN:M8330	☹	-	335	0.20	☑	200	0.20	☹	315	0.20	-	-	-	-	-	-	-	-	-
SNHQ 1204AZTN:M8340	☹	-	300	0.20	☑	180	0.20	☑	285	0.20	-	-	-	-	-	-	-	-	-
SNHQ 1205AZTN:M8330	☹	-	330	0.20	☑	195	0.20	☹	310	0.20	-	-	-	-	-	-	-	-	-
SNHQ 1205AZTN:M8340	☹	-	295	0.20	☑	175	0.20	☑	280	0.20	-	-	-	-	-	-	-	-	-
SNHQ 1207AZTN:M8330	☹	-	320	0.20	☑	190	0.20	☹	300	0.20	-	-	-	-	-	-	-	-	-
SNHQ 1207AZTN:M8340	☹	-	290	0.20	☑	170	0.20	☑	275	0.20	-	-	-	-	-	-	-	-	-
SNHQ 12T3AZTN:M8340	☹	-	300	0.20	☑	180	0.18	☑	285	0.20	-	-	-	-	-	-	-	-	-

SNHQ TRL



	IC (mm)	D1 (mm)	L (mm)	W1 (mm)
1203	12.700	5.00	12.70	3.200
1204	12.700	5.00	12.70	4.500
1205	12.700	5.00	12.70	5.400
1207	12.700	5.00	12.70	7.000

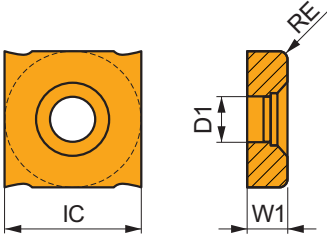

Eignung und Startwerte für Schnittgeschwindigkeit (vc), Vorschub (f) und Schnitttiefe (ap). Weitere Informationen finden Sie in unserer Zerspanungsrechner-App.

Produkt	RE (mm)	P			M			K			N			S			H		
		vc (m/min)	f (mm/tooth)	ap (mm)	vc (m/min)	f (mm/tooth)	ap (mm)	vc (m/min)	f (mm/tooth)	ap (mm)	vc (m/min)	f (mm/tooth)	ap (mm)	vc (m/min)	f (mm/tooth)	ap (mm)	vc (m/min)	f (mm/tooth)	ap (mm)

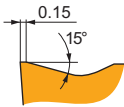
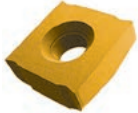

TRL geometrie in besonderer Ausführung zum Nutfräsen.

SNHQ 120305TRL:M8340	0.5	230	0.20	135	0.18	215	0.20	-	-	-	-	-	-	-	-	-	-	-
SNHQ 120310TRL:M8340	1.0	285	0.20	170	0.18	270	0.20	-	-	-	-	-	-	-	-	-	-	-
SNHQ 120315TRL:M8340	1.5	300	0.20	180	0.18	285	0.20	-	-	-	-	-	-	-	-	-	-	-
SNHQ 120405TRL:M8340	0.5	220	0.20	130	0.20	205	0.20	-	-	-	-	-	-	-	-	-	-	-
SNHQ 120415TRL:M8340	1.5	290	0.20	170	0.20	275	0.20	-	-	-	-	-	-	-	-	-	-	-
SNHQ 120505TRL:M8340	0.5	215	0.20	125	0.20	200	0.20	-	-	-	-	-	-	-	-	-	-	-
SNHQ 120515TRL:M8340	1.5	280	0.20	165	0.20	265	0.20	-	-	-	-	-	-	-	-	-	-	-
SNHQ 120705TRL:M8340	0.5	210	0.20	125	0.20	195	0.20	-	-	-	-	-	-	-	-	-	-	-
SNHQ 120710TRL:M8340	1.0	265	0.20	155	0.20	250	0.20	-	-	-	-	-	-	-	-	-	-	-



a_e / DC	0.05	0.10	0.15	0.20	0.25	0.30	0.40	0.50	0.60	0.70	0.75	0.80	0.90	1.00
	1.48	1.35	1.27	1.22	1.19	1.16	1.11	1.08	1.05	1.03	1.00	1.00	1.00	1.00



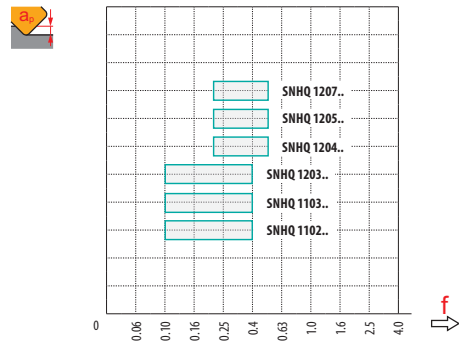









	SNHQ AZEN	SNHQ AZTN	SNHQ 12TRL
	-	-	0.5 – 1.5
	-	-	-











	80	4	16	16
	100	5	24	24
	125	6	31	31
	160	5	43	43
	200	9	62	62
	63	3	10.5	63
	80	4	17.5	80
	100	5	23.5	100
	125	6	24	125
	160	8	41	160



	a_e	5		10		15		20		25	
		f_{min}	f_{max}	f_{min}	f_{max}	f_{min}	f_{max}	f_{min}	f_{max}	f_{min}	f_{max}
	80	0.28	0.36	0.20	0.26	0.17	0.21	-	-	-	-
	100	0.32	0.41	0.23	0.29	0.19	0.24	0.16	0.21	-	-
	125	0.35	0.45	0.25	0.32	0.21	0.27	0.18	0.23	0.16	0.21
	160	0.40	0.51	0.28	0.36	0.23	0.30	0.20	0.26	0.18	0.23
	200	0.44	0.57	0.32	0.41	0.26	0.33	0.23	0.29	0.20	0.26
	63	0.25	0.32	0.18	0.23	0.15	0.19	0.13	0.17	0.12	0.15
	80	0.28	0.36	0.20	0.26	0.17	0.21	0.15	0.19	0.13	0.17
	100	0.32	0.41	0.23	0.29	0.19	0.24	0.16	0.21	0.15	0.19
	125	0.35	0.45	0.25	0.32	0.21	0.27	0.18	0.23	0.16	0.21
	160	0.40	0.51	0.28	0.36	0.23	0.30	0.20	0.26	0.18	0.23

	a_e	32		40		50		63		80	
		f_{min}	f_{max}	f_{min}	f_{max}	f_{min}	f_{max}	f_{min}	f_{max}	f_{min}	f_{max}
	DC										
	80	-	-	-	-	-	-	-	-	-	-
	100	-	-	-	-	-	-	-	-	-	-
	125	-	-	-	-	-	-	-	-	-	-
	160	0.16	0.21	0.15	0.19	-	-	-	-	-	-
	63	0.11	0.14	0.10	0.13	0.10	0.12	0.10	0.11	-	-
	80	0.12	0.15	0.11	0.14	0.10	0.13	0.10	0.12	0.10	0.11
	100	0.13	0.17	0.12	0.15	0.11	0.14	0.10	0.13	0.10	0.12
	125	0.15	0.19	0.13	0.17	0.12	0.15	0.11	0.14	0.10	0.13
	160	0.16	0.21	0.15	0.19	0.13	0.17	0.12	0.16	0.11	0.14

	a_e	100		125		160	
		f_{min}	f_{max}	f_{min}	f_{max}	f_{min}	f_{max}
	DC						
	80	-	-	-	-	-	-
	100	-	-	-	-	-	-
	125	-	-	-	-	-	-
	160	-	-	-	-	-	-
	63	-	-	-	-	-	-
	80	-	-	-	-	-	-
	100	0.10	0.11	-	-	-	-
	125	0.10	0.12	0.10	0.11	-	-
	160	0.10	0.13	0.10	0.12	0.10	0.11

S90CN(XN)



PRAMET



Scheibenfräser mit einstellbarer Breite





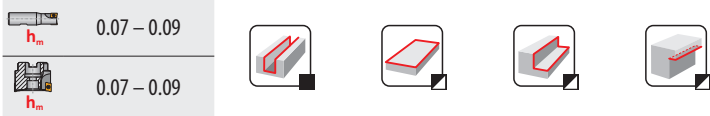
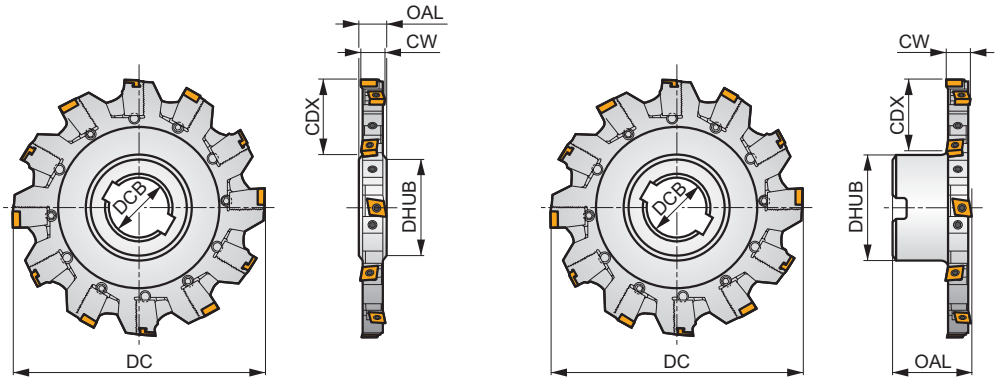
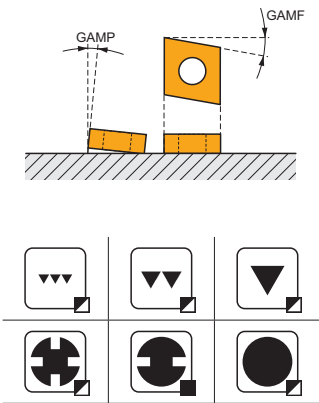









90° disc mill utilising CNHQ and XNHQ inserts. Suitable for slot, shoulder, rear side and face milling. Available in arbor or stub arbor style. Body treated for longer tool life.



KAPR	90°
CW	14.0 – 30.5 mm



Produkt	DC (mm)	OAL (mm)	DCB (mm)	DHUB (mm)	CDX (mm)	CW (mm)	GAMF (°)	GAMP (°)	z	ISO 6462 DIN 8030	max.	kg	GI195	DI051	DI052	DI056	DI053	DI057	DI060	DI054	DI058	DI061	DI055	DI059	DI062	DI071	AC003	DI072	DI074	DI075	DI073			
125H04N-S90CN10N18	125	18	40	56	34	14.0 – 18.5	-10	4	4	8	-	7800	1.19	GI195	DI051	-	-	-	-	-	-	-	-	-	-	-	-	-	-	-	-	-		
160H06N-S90CN10N18	160	18	40	56	50	14.0 – 18.5	-8	4	6	12	-	6900	1.80	GI195	DI052	-	-	-	-	-	-	-	-	-	-	-	-	-	-	-	-	-	-	
160H05N-S90XN12N24	160	24	40	56	50	19.0 – 24.3	-8	5	5	10	-	5200	2.50	GI196	DI056	-	-	-	-	-	-	-	-	-	-	-	-	-	-	-	-	-	-	
200J07N-S90CN10N18	200	18	50	71	60	14.0 – 18.5	-8	4	7	14	-	6100	2.85	GI195	DI053	-	-	-	-	-	-	-	-	-	-	-	-	-	-	-	-	-	-	
200J06N-S90XN12N24	200	24	50	71	60	19.0 – 24.3	-8	5	6	12	-	4700	3.60	GI196	DI057	-	-	-	-	-	-	-	-	-	-	-	-	-	-	-	-	-	-	
200J06N-S90XN16N30	200	30	50	71	60	24.5 – 30.5	-9	5	6	12	-	4000	6.00	GI197	DI060	-	-	-	-	-	-	-	-	-	-	-	-	-	-	-	-	-	-	
250J09N-S90CN10N18	250	18	50	71	85	14.0 – 18.5	-8	4	9	18	-	5500	5.30	GI195	DI054	-	-	-	-	-	-	-	-	-	-	-	-	-	-	-	-	-	-	
250J08N-S90XN12N24	250	24	50	71	85	19.0 – 24.3	-8	5	8	16	-	4200	7.50	GI196	DI058	-	-	-	-	-	-	-	-	-	-	-	-	-	-	-	-	-	-	
250J08N-S90XN16N30	250	30	50	71	85	24.5 – 30.5	-8	5	8	16	-	3600	8.00	GI197	DI061	-	-	-	-	-	-	-	-	-	-	-	-	-	-	-	-	-	-	
315J12N-S90CN10N18	315	18	50	71	110	14.0 – 18.5	-8	4	12	24	-	4900	7.80	GI195	DI055	-	-	-	-	-	-	-	-	-	-	-	-	-	-	-	-	-	-	
315J10N-S90XN12N24	315	24	50	71	110	19.0 – 24.3	-8	5	10	20	-	3700	10.70	GI196	DI059	-	-	-	-	-	-	-	-	-	-	-	-	-	-	-	-	-	-	
315K10N-S90XN16N30	315	30	60	85	110	24.5 – 30.5	-8	5	10	20	-	3200	13.00	GI197	DI062	-	-	-	-	-	-	-	-	-	-	-	-	-	-	-	-	-	-	
125B04R-S90CN10N18	125	50	40	70	25	14.0 – 18.5	-10	4	4	8	-	7800	1.65	GI195	DI071	AC003	-	-	-	-	-	-	-	-	-	-	-	-	-	-	-	-	-	
160B06R-S90CN10N18	160	50	40	70	44	14.0 – 18.5	-8	5	6	12	-	6900	2.55	GI195	DI072	-	-	-	-	-	-	-	-	-	-	-	-	-	-	-	-	-	-	-
160B05R-S90XN12N24	160	50	40	70	44	19.0 – 24.3	-8	5	5	10	-	5200	2.50	GI196	DI074	-	-	-	-	-	-	-	-	-	-	-	-	-	-	-	-	-	-	
200C06R-S90XN12N24	200	50	40	90	52	19.0 – 24.3	-8	5	6	12	-	6100	4.70	GI196	DI075	-	-	-	-	-	-	-	-	-	-	-	-	-	-	-	-	-	-	
200C07R-S90CN10N18	200	50	40	90	52	14.0 – 18.5	-8	4	7	14	-	6100	4.05	GI195	DI073	-	-	-	-	-	-	-	-	-	-	-	-	-	-	-	-	-	-	

GI195	CNHQ 1005..
GI196	XNHQ 1205..
GI197	XNHQ 1606..

														
DI051	125H04N-S-14-08	KL-1418-CN10	KR-1418-CN10	KS 613F	DS 6018F	SDR T20	SS 6005-T09P	SDR T09	US 4011-T15P	3.5	M 4	10.6	SDR T15P	-
DI052	160H06N-S-14-12	KL-1418-CN10	KR-1418-CN10	KS 613F	DS 6018F	SDR T20	SS 6005-T09P	SDR T09	US 4011-T15P	3.5	M 4	10.6	SDR T15P	-
DI053	200J07N-S-14-14	KL-1418-CN10	KR-1418-CN10	KS 613F	DS 6018F	SDR T20	SS 6005-T09P	SDR T09	US 4011-T15P	3.5	M 4	10.6	SDR T15P	-
DI054	250J09N-S-14-18	KL-1418-CN10	KR-1418-CN10	KS 613F	DS 6018F	SDR T20	SS 6005-T09P	SDR T09	US 4011-T15P	3.5	M 4	10.6	SDR T15P	-
DI055	315J12N-S-14-24	KL-1418-CN10	KR-1418-CN10	KS 613F	DS 6018F	SDR T20	SS 6005-T09P	SDR T09	US 4011-T15P	3.5	M 4	10.6	SDR T15P	-
DI056	160H05N-S-19-10	KL-1924-XN12	KR-1924-XN12	KS 617M	DS 6500	-	SS 6005-T09P	SDR T09	US 4011-T15P	3.5	M 4	10.6	SDR T15P	HXX 4
DI057	200J06N-S-19-12	KL-1924-XN12	KR-1924-XN12	KS 617M	DS 6500	-	SS 6005-T09P	SDR T09	US 4011-T15P	3.5	M 4	10.6	SDR T15P	HXX 4
DI058	250J08N-S-19-16	KL-1924-XN12	KR-1924-XN12	KS 617M	DS 6500	-	SS 6005-T09P	SDR T09	US 4011-T15P	3.5	M 4	10.6	SDR T15P	HXX 4
DI059	315J10N-S-19-20	KL-1924-XN12	KR-1924-XN12	KS 617M	DS 6500	-	SS 6005-T09P	SDR T09	US 4011-T15P	3.5	M 4	10.6	SDR T15P	HXX 4
DI060	200J06N-S-25-12	KL-2530-XN16	KR-2530-XN16	KS 623M	DS 6500	-	SS 6005-T09P	SDR T09	US 4011-T15P	3.5	M 4	10.6	SDR T15P	HXX 4
DI061	250J08N-S-25-16	KL-2530-XN16	KR-2530-XN16	KS 623M	DS 6500	-	SS 6005-T09P	SDR T09	US 4011-T15P	3.5	M 4	10.6	SDR T15P	HXX 4
DI062	315K10N-S-25-20	KL-2530-XN16	KR-2530-XN16	KS 623M	DS 6500	-	SS 6005-T09P	SDR T09	US 4011-T15P	3.5	M 4	10.6	SDR T15P	HXX 4
DI071	125B04R-S-14-08	KL-1418-CN10	KR-1418-CN10	KS 613F	DS 6018F	SDR T20	SS 6005-T09P	SDR T09	US 4011-T15P	3.5	M 4	10.6	SDR T15P	-
DI072	160B06R-S-14-12	KL-1418-CN10	KR-1418-CN10	KS 613F	DS 6018F	SDR T20	SS 6005-T09P	SDR T09	US 4011-T15P	3.5	M 4	10.6	SDR T15P	-
DI073	200C07R-S-14-14	KL-1418-CN10	KR-1418-CN10	KS 613F	DS 6018F	SDR T20	SS 6005-T09P	SDR T09	US 4011-T15P	3.5	M 4	10.6	SDR T15P	-
DI074	160B05R-S-19-10	KL-1924-XN12	KR-1924-XN12	KS 617M	DS 6500	-	SS 6005-T09P	SDR T09	US 4011-T15P	3.5	M 4	10.6	SDR T15P	HXX 4
DI075	200C06R-S-19-12	KL-1924-XN12	KR-1924-XN12	KS 617M	DS 6500	-	SS 6005-T09P	SDR T09	US 4011-T15P	3.5	M 4	10.6	SDR T15P	HXX 4

		
AC003	KS 2040	K.FMH40

CNHQ



	BCH	IC	D1	L	W1
	(mm)	(mm)	(mm)	(mm)	(mm)
1005	0.50	10.000	4.70	10.00	5.400

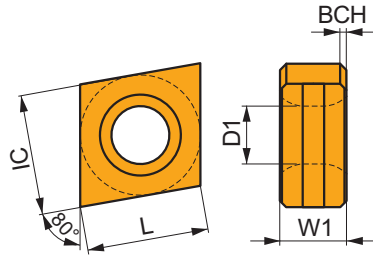

Eignung und Startwerte für Schnittgeschwindigkeit (vc), Vorschub (f) und Schnitttiefe (ap). Weitere Informationen finden Sie in unserer Zerspanungsrechner-App.

Produkt	RE	P			M			K			N			S			H		
		vc	f	ap	vc	f	ap	vc	f	ap	vc	f	ap	vc	f	ap	vc	f	ap
	(mm)	(m/min)	(mm/tooth)	(mm)	(m/min)	(mm/tooth)	(mm)	(m/min)	(mm/tooth)	(mm)	(m/min)	(mm/tooth)	(mm)	(m/min)	(mm/tooth)	(mm)	(m/min)	(mm/tooth)	(mm)

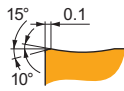
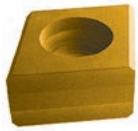

TN besondere Ausführung zum Nutfräsen mit leichten bis schweren Schnittbedingungen.

CNHQ 1005AZTN:M8330	☺	–	■	310	0.15	–	▣	185	0.14	–	■	290	0.15	–	–	–	–	–	–	–	–	–
CNHQ 1005AZTN:M8340	☺	–	■	280	0.15	–	▣	165	0.14	–	■	265	0.15	–	–	–	–	–	–	–	–	–

XNHQ



	BCH	IC	D1	L	W1
	(mm)	(mm)	(mm)	(mm)	(mm)
1205	0.50	10.000	4.70	12.70	5.400
1606	0.50	12.000	5.90	16.00	6.400

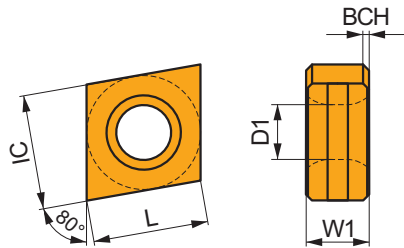

Eignung und Startwerte für Schnittgeschwindigkeit (vc), Vorschub (f) und Schnitttiefe (ap). Weitere Informationen finden Sie in unserer Zerspanungsrechner-App.

Produkt	RE	P			M			K			N			S			H		
		vc	f	ap	vc	f	ap	vc	f	ap	vc	f	ap	vc	f	ap	vc	f	ap
	(mm)	(m/min)	(mm/tooth)	(mm)	(m/min)	(mm/tooth)	(mm)	(m/min)	(mm/tooth)	(mm)	(m/min)	(mm/tooth)	(mm)	(m/min)	(mm/tooth)	(mm)	(m/min)	(mm/tooth)	(mm)

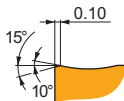

TN besondere Ausführung zum Nutfräsen.

XNHQ 1205AZTN:M8330	☺	–	■	310	0.15	–	▣	185	0.14	–	■	290	0.15	–	–	–	–	–	–	–	–	–
XNHQ 1205AZTN:M8340	☺	–	■	275	0.15	–	▣	165	0.14	–	■	260	0.15	–	–	–	–	–	–	–	–	–
XNHQ 1606AZTN:M8330	☺	–	■	300	0.15	–	▣	180	0.14	–	■	285	0.15	–	–	–	–	–	–	–	–	–
XNHQ 1606AZTN:M8340	☺	–	■	270	0.15	–	▣	160	0.14	–	■	255	0.15	–	–	–	–	–	–	–	–	–



a_e / DC	0.05	0.10	0.15	0.20	0.25	0.30	0.40	0.50	0.60	0.70	0.75	0.80	0.90	1.00
	1.48	1.35	1.27	1.22	1.19	1.16	1.11	1.08	1.05	1.03	1.00	1.00	1.00	1.00



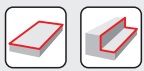
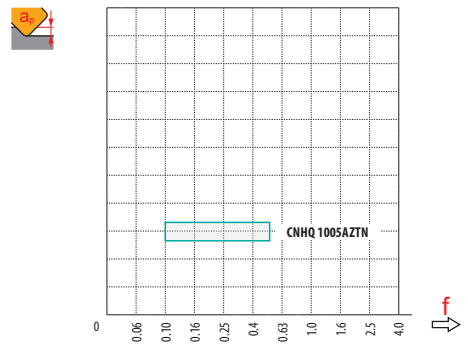









	XNHQ 10
	-
	-













	125	4	34
	160	6	50
	200	7	60
	250	9	85
	315	12	110
	125	4	25
	160	6	44
	200	7	52

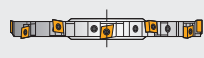

	a_e	5		10		15		20		25	
		f_{min}	f_{max}	f_{min}	f_{max}	f_{min}	f_{max}	f_{min}	f_{max}	f_{min}	f_{max}
	125	0.35	0.45	0.25	0.32	0.21	0.27	0.18	0.23	0.16	0.21
	160	0.40	0.51	0.28	0.36	0.23	0.30	0.20	0.26	0.18	0.23
	200	0.44	0.57	0.32	0.41	0.26	0.33	0.23	0.29	0.20	0.26
	250	0.50	0.64	0.35	0.45	0.29	0.37	0.25	0.32	0.23	0.29
	315	0.56	0.72	0.39	0.51	0.32	0.42	0.28	0.36	0.25	0.32
	125	0.35	0.45	0.25	0.32	0.21	0.27	0.18	0.23	0.16	0.21
	160	0.40	0.51	0.28	0.36	0.23	0.30	0.20	0.26	0.18	0.23
	200	0.44	0.57	0.32	0.41	0.26	0.33	0.23	0.29	0.20	0.26

	a _e	32		40		50		63		80	
		f_{min} 	f_{max} 	f_{min} 	f_{max} 	f_{min} 	f_{max} 	f_{min} 	f_{max} 	f_{min} 	f_{max} 
	125	0.15	0.19	–	–	–	–	–	–	–	–
	160	0.16	0.21	0.15	0.19	–	–	–	–	–	–
	200	0.18	0.23	0.16	0.21	0.15	0.19	–	–	–	–
	250	0.20	0.26	0.18	0.23	0.16	0.21	0.15	0.19	0.13	0.17
	315	0.22	0.29	0.20	0.26	0.18	0.23	0.16	0.21	0.15	0.19
	125	0.15	0.19	0.13	0.17	0.12	0.15	0.11	0.14	0.10	0.13
	160	0.16	0.21	0.15	0.19	0.13	0.17	0.12	0.16	0.11	0.14
	200	0.18	0.23	0.16	0.21	0.15	0.19	0.13	0.17	0.12	0.15

	a _e	100		125		160		200	
		f_{min} 	f_{max} 	f_{min} 	f_{max} 	f_{min} 	f_{max} 	f_{min} 	f_{max} 
	125	–	–	–	–	–	–	–	–
	160	–	–	–	–	–	–	–	–
	200	–	–	–	–	–	–	–	–
	250	–	–	–	–	–	–	–	–
	315	0.13	0.17	–	–	–	–	–	–
	125	0.10	0.12	0.10	0.11	–	–	–	–
	160	0.10	0.13	0.10	0.12	0.10	0.11	–	–
	200	0.11	0.14	0.10	0.13	0.10	0.12	0.10	0.11

F-SCC

P M K

PRAMET

S



T-Nutenfräser für CCMX Wendeschneidplatten mit Innenkühlung

T-Nut-Fräser mit einseitigen CCMX-Wendeschneidplatten. Innenkühlung. Geeignet zum Fräsen mit T-Nuten, Rückseiten, flache Schultern und flachen Nuten. Erhältlich als Weldonschaft. Körper für längere Standzeiten oberflächenbehandelt.

KAPR	90°
APMX	11.0 – 18.0 mm

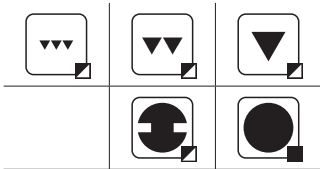
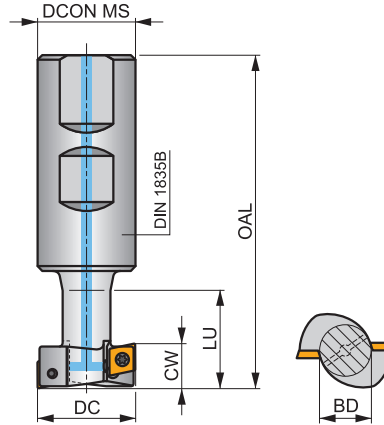
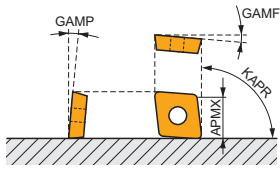

h_m 0.05 – 0.08



Produkt	DC	BD	OAL	DCON MS	LU	CW	$\frac{x}{1}$								
	(mm)	(mm)	(mm)	(mm)	(mm)	(mm)									
25F1R030B25-SCC06-C	25	12	86	25	25	11.00	1	2	-	28100	✓	0.26	G148	SQ213	
32F1R038B32-SCC08-C	32	16	98	32	33	14.00	1	2	-	19100	✓	0.50	G149	SQ212	
40F2R046B32-SCC09-C	40	20	105	32	41	18.00	2	4	-	14900	✓	0.56	G150	SQ212	

G148	CCMX 060304
G149	CCMX 08T308
G150	CCMX 09T308

SQ212	US 3007-T09P	2.0	M 3	7.3	Flag T09P
SQ213	US 2506-T07P	1.2	M 2.5	6.3	Flag T07P

CCMX

PRAMET

	IC (mm)	D1 (mm)	L (mm)	S (mm)
0603	6.350	2.80	6.40	3.50
08T3	8.030	3.50	8.10	4.40
09T3	9.525	3.50	9.70	3.97

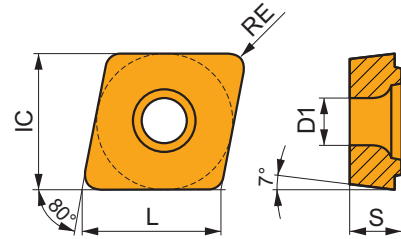

Eignung und Startwerte für Schnittgeschwindigkeit (v_c), Vorschub (f) und Schnitttiefe (a_p). Weitere Informationen finden Sie in unserer Zerspanungsrechner-App.

Produkt	● RE (mm)	P			M			K			N			S			H		
		v_c (m/min)	f (mm/tooth)	a_p (mm)	v_c (m/min)	f (mm/tooth)	a_p (mm)	v_c (m/min)	f (mm/tooth)	a_p (mm)	v_c (m/min)	f (mm/tooth)	a_p (mm)	v_c (m/min)	f (mm/tooth)	a_p (mm)	v_c (m/min)	f (mm/tooth)	a_p (mm)

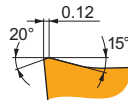

TS1 besondere Ausführung zum T-Nutfräsen mit leichten bis mittleren Schnittbedingungen.

CCMX 060304S-TS1:M8330	● 0.4	■ 240	■ 0.10	–	■ 140	■ 0.09	–	■ 225	■ 0.10	–	–	–	–	–	–	–	–	–
CCMX 060304S-TS1:M8340	● 0.4	■ 215	■ 0.10	–	■ 125	■ 0.09	–	■ 200	■ 0.10	–	–	–	–	–	–	–	–	–
CCMX 08T308S-TS1:M8330	● 0.8	■ 275	■ 0.10	–	■ 165	■ 0.10	–	■ 260	■ 0.10	–	–	–	–	–	–	–	–	–
CCMX 09T308S-TS1:M8330	● 0.8	■ 270	■ 0.10	–	■ 160	■ 0.10	–	■ 255	■ 0.10	–	–	–	–	–	–	–	–	–
CCMX 09T308S-TS1:M8340	● 0.8	■ 240	■ 0.10	–	■ 140	■ 0.10	–	■ 225	■ 0.10	–	–	–	–	–	–	–	–	–



	CCMX 06-TS1	CCMX 08-TS1	CCMX 09-TS1
	0.4	0.8	0.8
	-	-	-

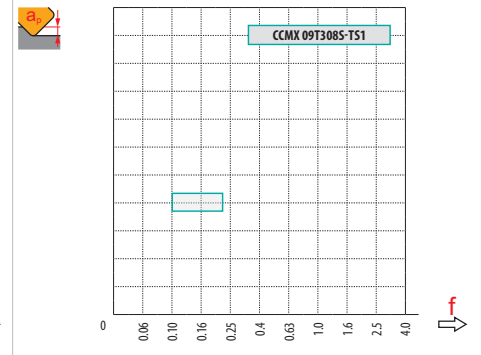
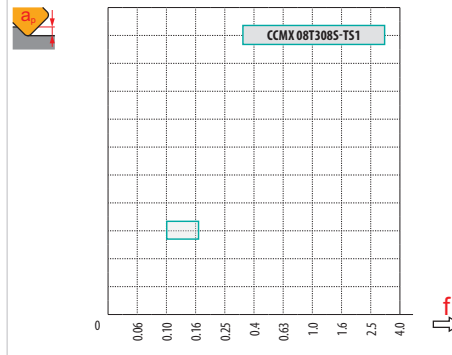
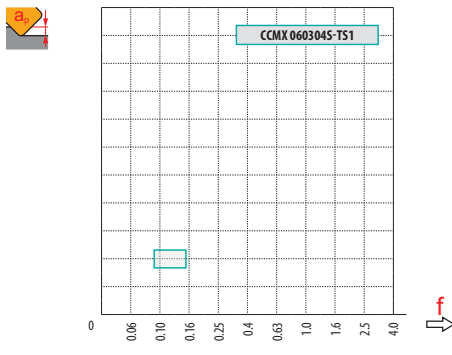

a_e / DC	5 %	10 %	15 %	20 %	25 %	30 %	40 %	50 %	60 %	70 %	75 %	80 %	90 %	100 %
	1.48	1.35	1.27	1.22	1.19	1.16	1.11	1.08	1.05	1.03	1.00	1.00	1.00	1.00



	$a_e = 1$		$a_e = 2$		$a_e = 3$		$a_e = 4$		$a_e = 5$		$a_e = 8$		$a_e = 10$	
	f_{min}	f_{max}	f_{min}	f_{max}	f_{min}	f_{max}	f_{min}	f_{max}	f_{min}	f_{max}	f_{min}	f_{max}	f_{min}	f_{max}
25	0.25	0.40	0.18	0.29	0.15	0.24	0.13	0.21	0.12	0.19	0.09	0.15	0.09	0.14
32	0.28	0.45	0.20	0.32	0.17	0.27	0.14	0.23	0.13	0.21	0.10	0.17	0.09	0.15
40	0.32	0.51	0.23	0.36	0.18	0.30	0.16	0.26	0.14	0.23	0.12	0.19	0.10	0.17

	$a_e = 12$		$a_e = 16$		$a_e = 20$		$a_e = 25$		$a_e = 32$		$a_e = 40$	
	f_{min}	f_{max}	f_{min}	f_{max}	f_{min}	f_{max}	f_{min}	f_{max}	f_{min}	f_{max}	f_{min}	f_{max}
25	0.08	0.13	0.07	0.12	0.07	0.11	0.08	0.13	-	-	-	-
32	0.09	0.14	0.08	0.13	0.07	0.12	0.07	0.11	0.08	0.13	-	-
40	0.10	0.15	0.09	0.14	0.08	0.13	0.07	0.12	0.07	0.11	0.08	0.13

- Gültig für T-Nut-Fräsen
- Gültig für Schulter- und Hinterfräsen
- Gültig für Schulterfräsen



25	1	11	6.4
32	1	14	8.0
40	2	18	9.7

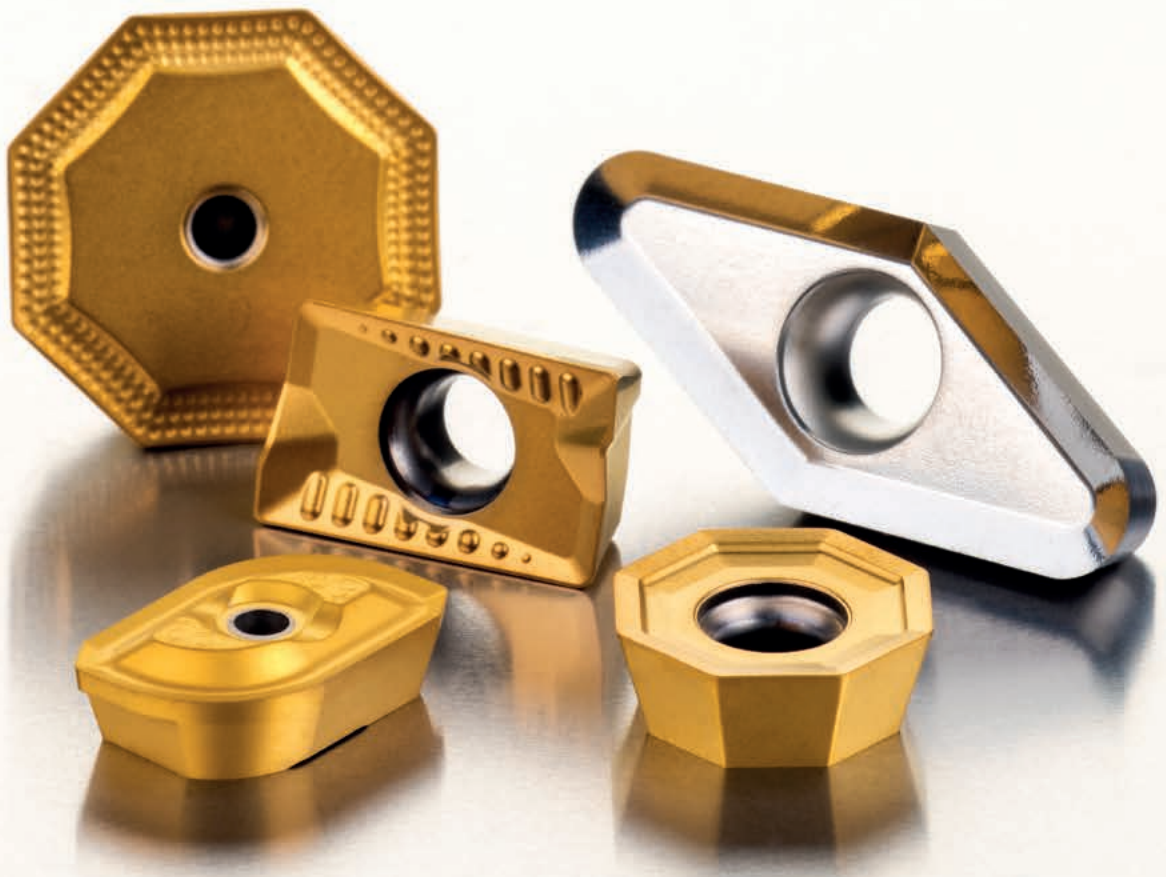

ANDERE FRÄSWENDESCHNEIDPLATTEN

ADKT 15



	W1 (mm)	D1 (mm)	L (mm)	S (mm)
1505	9.525	4.40	15.55	5.60

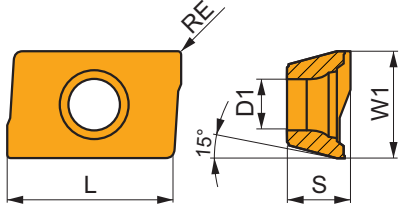

Eignung und Startwerte für Schnittgeschwindigkeit (vc), Vorschub (f) und Schnitttiefe (ap). Weitere Informationen finden Sie in unserer Zerspanungsrechner-App.

Produkt	RE (mm)	P			M			K			N			S			H		
		vc (m/min)	f (mm/tooth)	ap (mm)	vc (m/min)	f (mm/tooth)	ap (mm)	vc (m/min)	f (mm/tooth)	ap (mm)	vc (m/min)	f (mm/tooth)	ap (mm)	vc (m/min)	f (mm/tooth)	ap (mm)	vc (m/min)	f (mm/tooth)	ap (mm)

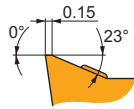

M geometrie mit sehr positiven Design zur mittleren Bearbeitung.

ADKT 1505PDER-M:M8330	0.8	235	0.20	5.0	140	0.18	5.0	220	0.20	5.0	-	-	-	55	0.16	4.0	-	-	-
ADKT 1505PDER-M:M8340	0.8	210	0.20	5.0	125	0.18	5.0	195	0.20	5.0	-	-	-	50	0.16	4.0	-	-	-
ADKT 1505PDER-M:M9325	0.8	290	0.20	5.0	-	-	-	275	0.20	5.0	-	-	-	-	-	-	-	-	-

ADKX 15



	W1 (mm)	L (mm)	S (mm)
15T3	9.525	12.20	3.97

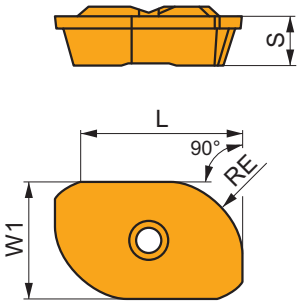

Eignung und Startwerte für Schnittgeschwindigkeit (vc), Vorschub (f) und Schnitttiefe (ap). Weitere Informationen finden Sie in unserer Zerspanungsrechner-App.

Produkt	RE (mm)	P			M			K			N			S			H		
		vc (m/min)	f (mm/tooth)	ap (mm)	vc (m/min)	f (mm/tooth)	ap (mm)	vc (m/min)	f (mm/tooth)	ap (mm)	vc (m/min)	f (mm/tooth)	ap (mm)	vc (m/min)	f (mm/tooth)	ap (mm)	vc (m/min)	f (mm/tooth)	ap (mm)

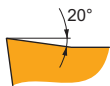

F geometrie mit sehr scharfen und positiven Design zur leichten bis mittleren Bearbeitung.

ADKX 15T308ER-F:M8345	0.8	170	0.10	10.0	100	0.09	10.0	-	-	-	-	-	-	40	0.07	8.0	-	-	-
------------------------------	-----	-----	------	------	-----	------	------	---	---	---	---	---	---	----	------	-----	---	---	---

APMT 16



	W1 (mm)	D1 (mm)	L (mm)	S (mm)
1604	9.600	4.50	17.00	4.76

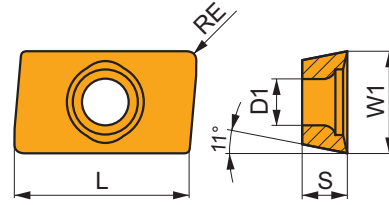

Eignung und Startwerte für Schnittgeschwindigkeit (vc), Vorschub (f) und Schnitttiefe (ap). Weitere Informationen finden Sie in unserer Zerspanungsrechner-App.

Produkt	RE (mm)	P			M			K			N			S			H		
		vc (m/min)	f (mm/tooth)	ap (mm)	vc (m/min)	f (mm/tooth)	ap (mm)	vc (m/min)	f (mm/tooth)	ap (mm)	vc (m/min)	f (mm/tooth)	ap (mm)	vc (m/min)	f (mm/tooth)	ap (mm)	vc (m/min)	f (mm/tooth)	ap (mm)

F positive geometrie zur leichten Bearbeitung.

APMT 1604PDER-F:M8330	☺	–	■	320	0.10	2.0	■	190	0.09	2.0	■	300	0.10	2.0	■	80	0.07	1.6	■	–	–	–
------------------------------	---	---	---	-----	------	-----	---	-----	------	-----	---	-----	------	-----	---	----	------	-----	---	---	---	---

FM geometrie mit positiven Design zur leichten bis mittleren Bearbeitung.

APMT 1604PDER-FM:M8330	☺	–	■	285	0.16	2.0	■	170	0.14	2.0	■	270	0.16	2.0	■	70	0.13	1.6	■	–	–	–
APMT 1604PDER-FM:M8345	☺	–	■	205	0.16	2.0	■	120	0.14	2.0	■	–	–	–	■	50	0.13	1.6	■	–	–	–

ER-R geometrie mit positiven Design zum Schruppen.

APMT 1604PDER-R:M8330	☺	–	■	255	0.16	5.0	■	–	–	–	■	240	0.16	5.0	■	–	–	–	■	–	–	–
------------------------------	---	---	---	-----	------	-----	---	---	---	---	---	-----	------	-----	---	---	---	---	---	---	---	---

SR-R geometrie mit positiven Design zur Schruppbearbeitung.

APMT 1604PDSR-R:M8330	☺	–	■	255	0.18	5.0	■	–	–	–	■	240	0.18	5.0	■	–	–	–	■	–	–	–
------------------------------	---	---	---	-----	------	-----	---	---	---	---	---	-----	------	-----	---	---	---	---	---	---	---	---

CNM



	D1 (mm)	L (mm)	S (mm)
63	5.50	15.00	8.00

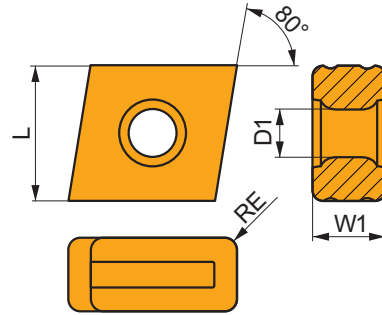

Eignung und Startwerte für Schnittgeschwindigkeit (vc), Vorschub (f) und Schnitttiefe (ap). Weitere Informationen finden Sie in unserer Zerspanungsrechner-App.

Produkt	RE (mm)	P			M			K			N			S			H		
		vc (m/min)	f (mm/tooth)	ap (mm)	vc (m/min)	f (mm/tooth)	ap (mm)	vc (m/min)	f (mm/tooth)	ap (mm)	vc (m/min)	f (mm/tooth)	ap (mm)	vc (m/min)	f (mm/tooth)	ap (mm)	vc (m/min)	f (mm/tooth)	ap (mm)
●	1.2	185	0.30	10.0	—	—	—	175	0.30	10.0	—	—	—	—	—	—	—	—	—
⊕	1.2	220	0.30	10.0	—	—	—	205	0.30	10.0	—	—	—	—	—	—	—	—	—

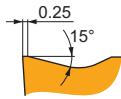
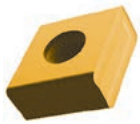

563 universelle geometrie.

CNM 563:M8330	●	1.2	185	0.30	10.0	—	—	—	175	0.30	10.0	—	—	—	—	—	—	—	—
CNM 563:M8340	⊕	1.2	220	0.30	10.0	—	—	—	205	0.30	10.0	—	—	—	—	—	—	—	—

HNEF 09



	IC (mm)	L (mm)	S (mm)
0905	16.200	9.40	5.64

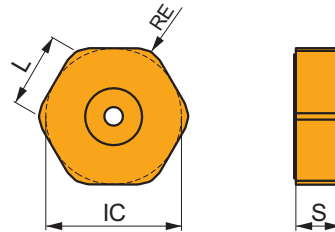

Eignung und Startwerte für Schnittgeschwindigkeit (vc), Vorschub (f) und Schnitttiefe (ap). Weitere Informationen finden Sie in unserer Zerspanungsrechner-App.

Produkt	RE (mm)	P			M			K			N			S			H		
		vc (m/min)	f (mm/tooth)	ap (mm)	vc (m/min)	f (mm/tooth)	ap (mm)	vc (m/min)	f (mm/tooth)	ap (mm)	vc (m/min)	f (mm/tooth)	ap (mm)	vc (m/min)	f (mm/tooth)	ap (mm)	vc (m/min)	f (mm/tooth)	ap (mm)
●	1.6	—	—	—	—	—	—	380	0.15	1.5	—	—	—	—	—	—	—	—	—
⊕	1.6	—	—	—	—	—	—	265	0.30	3.0	—	—	—	—	—	—	—	—	—

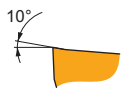

F positive geometrie zur leichten Bearbeitung.

HNEF 090516SN-R:R215	●	1.6	—	—	—	—	—	380	0.15	1.5	—	—	—	—	—	—	—	—	—
HNEF 090516SN-R:M5315	⊕	1.6	—	—	—	—	—	265	0.30	3.0	—	—	—	—	—	—	—	—	—

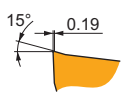
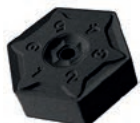

M geometrie mit positiven Design zur leichten bis mittleren Bearbeitung.

HNEF 090508EN-M:M5315	⊕	0.8	—	—	—	—	—	290	0.18	3.0	—	—	—	—	—	—	—	—	—
------------------------------	---	-----	---	---	---	---	---	-----	------	-----	---	---	---	---	---	---	---	---	---

HNMF 09



	IC (mm)	L (mm)	S (mm)
0905	16.200	9.40	5.64

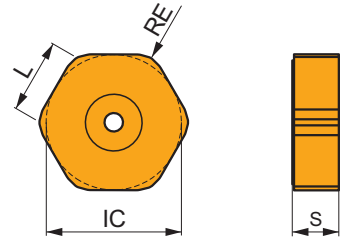

Eignung und Startwerte für Schnittgeschwindigkeit (vc), Vorschub (f) und Schnitttiefe (ap). Weitere Informationen finden Sie in unserer Zerspanungsrechner-App.

Produkt	RE (mm)	P			M			K			N			S			H		
		vc (m/min)	f (mm/tooth)	ap (mm)	vc (m/min)	f (mm/tooth)	ap (mm)	vc (m/min)	f (mm/tooth)	ap (mm)	vc (m/min)	f (mm/tooth)	ap (mm)	vc (m/min)	f (mm/tooth)	ap (mm)	vc (m/min)	f (mm/tooth)	ap (mm)

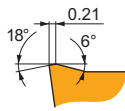

R geometrie mit negativer Ausführung zur leichten und schweren Bearbeitung.

HNMF 090516SN-R:8215	✳ 1.6	-	-	-	-	-	-	210	0.30	3.0	-	-	-	-	-	-	-	-	-
HNMF 090516SN-R:M5315	✳ 1.6	-	-	-	-	-	-	265	0.30	3.0	-	-	-	-	-	-	-	-	-

ODMT 05



	IC (mm)	D1 (mm)	S (mm)
0504	12.700	4.40	4.76

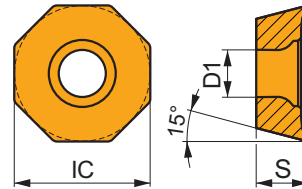

Eignung und Startwerte für Schnittgeschwindigkeit (vc), Vorschub (f) und Schnitttiefe (ap). Weitere Informationen finden Sie in unserer Zerspanungsrechner-App.

Produkt	RE (mm)	P			M			K			N			S			H		
		vc (m/min)	f (mm/tooth)	ap (mm)	vc (m/min)	f (mm/tooth)	ap (mm)	vc (m/min)	f (mm/tooth)	ap (mm)	vc (m/min)	f (mm/tooth)	ap (mm)	vc (m/min)	f (mm/tooth)	ap (mm)	vc (m/min)	f (mm/tooth)	ap (mm)

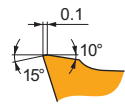

ZZN leicht positive Ausführung zur mittleren Bearbeitung.

ODMT 0504ZZN:M8340	✳ -	195	0.25	1.5	-	-	-	185	0.25	1.5	-	-	-	-	-	-	-	-	-
---------------------------	-----	-----	------	-----	---	---	---	-----	------	-----	---	---	---	---	---	---	---	---	---

OFKR 07



	IC (mm)	D1 (mm)	S (mm)
0704	17.845	2.65	4.56

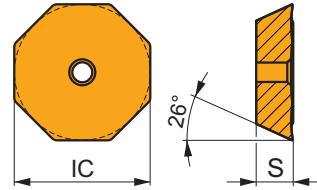

Eignung und Startwerte für Schnittgeschwindigkeit (vc), Vorschub (f) und Schnitttiefe (ap). Weitere Informationen finden Sie in unserer Zerspanungsrechner-App.

Produkt	RE (mm)	P			M			K			N			S			H		
		vc (m/min)	f (mm/tooth)	ap (mm)	vc (m/min)	f (mm/tooth)	ap (mm)	vc (m/min)	f (mm/tooth)	ap (mm)	vc (m/min)	f (mm/tooth)	ap (mm)	vc (m/min)	f (mm/tooth)	ap (mm)	vc (m/min)	f (mm/tooth)	ap (mm)

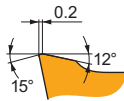
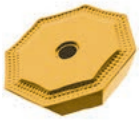

M geometrie mit positiven Design zur leichten bis mittleren Bearbeitung.

OFKR 0704SN-M:M8330	☹	–	■	235	0.25	1.5	■	140	0.23	1.5	■	220	0.25	1.5	■	–	–	–	■	–	–	–
OFKR 0704SN-M:M8340	☹	–	■	215	0.25	1.5	■	125	0.23	1.5	■	200	0.25	1.5	■	–	–	–	■	–	–	–

RDET



	INSD (mm)	D1 (mm)	S (mm)
0802	8.000	3.40	2.38
1003	10.000	4.40	3.18
12T3	12.000	4.40	3.97

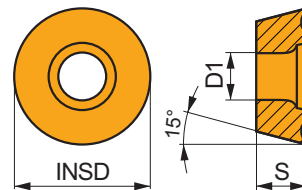

Eignung und Startwerte für Schnittgeschwindigkeit (vc), Vorschub (f) und Schnitttiefe (ap). Weitere Informationen finden Sie in unserer Zerspanungsrechner-App.

Produkt	RE (mm)	P			M			K			N			S			H		
		vc (m/min)	f (mm/tooth)	ap (mm)	vc (m/min)	f (mm/tooth)	ap (mm)	vc (m/min)	f (mm/tooth)	ap (mm)	vc (m/min)	f (mm/tooth)	ap (mm)	vc (m/min)	f (mm/tooth)	ap (mm)	vc (m/min)	f (mm/tooth)	ap (mm)

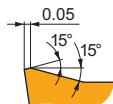

SN positive Ausführung zum Schlichten.

RDET 0802MOSN:M8340	☹	–	■	335	0.15	0.5	■	200	0.14	0.5	■	315	0.15	0.5	■	80	0.12	0.4	■	–	–	–
RDET 1003MOSN:M8340	☹	–	■	310	0.15	1.0	■	185	0.14	1.0	■	290	0.15	1.0	■	75	0.12	0.8	■	–	–	–
RDET 12T3MOSN:M8340	☹	–	■	280	0.20	1.5	■	165	0.18	1.5	■	265	0.20	1.5	■	70	0.14	1.2	■	–	–	–

RDHX 20



	INSD (mm)	D1 (mm)	S (mm)
2006	20.000	5.20	6.35

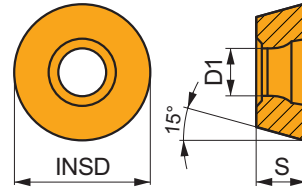

Eignung und Startwerte für Schnittgeschwindigkeit (vc), Vorschub (f) und Schnitttiefe (ap). Weitere Informationen finden Sie in unserer Zerspanungsrechner-App.

Produkt	RE (mm)	P			M			K			N			S			H		
		vc (m/min)	f (mm/tooth)	ap (mm)	vc (m/min)	f (mm/tooth)	ap (mm)	vc (m/min)	f (mm/tooth)	ap (mm)	vc (m/min)	f (mm/tooth)	ap (mm)	vc (m/min)	f (mm/tooth)	ap (mm)	vc (m/min)	f (mm/tooth)	ap (mm)

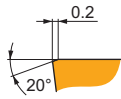

MOT ohne Spanwinkel zur Schlichtbearbeitung.

RDHX 2006MOT:M8310	✳	–	✓	240	0.35	3.0	–	–	–	■	225	0.35	3.0	–	–	–	–	–	–	■	45	0.18	1.3
RDHX 2006MOT:M8325	✳	–	✓	180	0.35	3.0	–	–	–	–	–	–	–	–	–	–	–	–	–	–	–	–	–

RPET 12



	INSD (mm)	D1 (mm)	S (mm)
1204	12.000	4.40	4.76

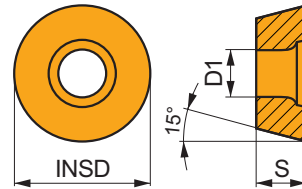

Eignung und Startwerte für Schnittgeschwindigkeit (vc), Vorschub (f) und Schnitttiefe (ap). Weitere Informationen finden Sie in unserer Zerspanungsrechner-App.

Produkt	RE (mm)	P			M			K			N			S			H		
		vc (m/min)	f (mm/tooth)	ap (mm)	vc (m/min)	f (mm/tooth)	ap (mm)	vc (m/min)	f (mm/tooth)	ap (mm)	vc (m/min)	f (mm/tooth)	ap (mm)	vc (m/min)	f (mm/tooth)	ap (mm)	vc (m/min)	f (mm/tooth)	ap (mm)

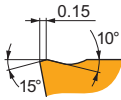

MOSN positive Ausführung zum Schlichten.

RPET 1204MOSN:8215	✳	–	■	325	0.20	1.5	✓	195	0.18	1.5	✓	305	0.20	1.5	–	–	–	✓	80	0.14	1.2	–	–	–
RPET 1204MOSN:M8330	✳	–	■	320	0.20	1.5	✓	190	0.18	1.5	✓	300	0.20	1.5	–	–	–	✓	80	0.14	1.2	–	–	–
RPET 1204MOSN:M8340	✳	–	■	295	0.20	1.5	✓	175	0.18	1.5	✓	280	0.20	1.5	–	–	–	✓	70	0.14	1.2	–	–	–

RPEW 12



	INSD (mm)	D1 (mm)	S (mm)
1204	12.000	4.40	4.76

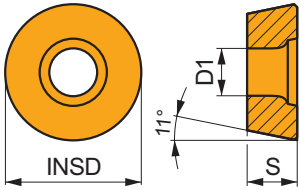

Eignung und Startwerte für Schnittgeschwindigkeit (vc), Vorschub (f) und Schnitttiefe (ap). Weitere Informationen finden Sie in unserer Zerspanungsrechner-App.

Produkt	RE (mm)	P			M			K			N			S			H		
		vc (m/min)	f (mm/tooth)	ap (mm)	vc (m/min)	f (mm/tooth)	ap (mm)	vc (m/min)	f (mm/tooth)	ap (mm)	vc (m/min)	f (mm/tooth)	ap (mm)	vc (m/min)	f (mm/tooth)	ap (mm)	vc (m/min)	f (mm/tooth)	ap (mm)

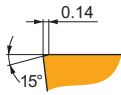

MOSN ohne Spanwinkel zur Schlichtbearbeitung.

RPEW 1204MOSN:M8330	✳	–	285	0.20	1.5	–	–	–	270	0.20	1.5	–	–	–	–	–	–	–	55	0.10	0.8
RPEW 1204MOSN:M8340	✳	–	265	0.20	1.5	–	–	–	250	0.20	1.5	–	–	–	–	–	–	–	–	–	–

RPEX



	INSD (mm)	D1 (mm)	S (mm)
1204	12.000	4.40	4.76

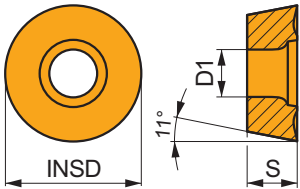

Eignung und Startwerte für Schnittgeschwindigkeit (vc), Vorschub (f) und Schnitttiefe (ap). Weitere Informationen finden Sie in unserer Zerspanungsrechner-App.

Produkt	RE (mm)	P			M			K			N			S			H		
		vc (m/min)	f (mm/tooth)	ap (mm)	vc (m/min)	f (mm/tooth)	ap (mm)	vc (m/min)	f (mm/tooth)	ap (mm)	vc (m/min)	f (mm/tooth)	ap (mm)	vc (m/min)	f (mm/tooth)	ap (mm)	vc (m/min)	f (mm/tooth)	ap (mm)

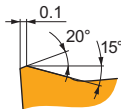

12 positive Ausführung zum Schlichten.

RPEX 1204MOSN-12:M8340	✳	–	215	0.30	1.5	125	0.27	1.5	200	0.30	1.5	–	–	–	50	0.21	1.2	–	–	–
------------------------	---	---	-----	------	-----	-----	------	-----	-----	------	-----	---	---	---	----	------	-----	---	---	---

SEEN



	IC (mm)	M (mm)	S (mm)
1203	12.700	1.6	3.18
1504	15.875	2.0	4.76

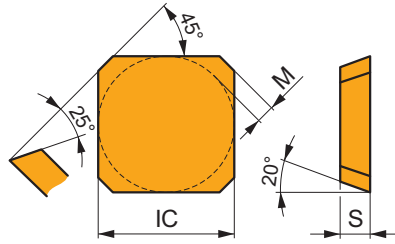

Eignung und Startwerte für Schnittgeschwindigkeit (vc), Vorschub (f) und Schnitttiefe (ap). Weitere Informationen finden Sie in unserer Zerspanungsrechner-App.

Produkt	RE (mm)	P			M			K			N			S			H		
		vc (m/min)	f (mm/tooth)	ap (mm)	vc (m/min)	f (mm/tooth)	ap (mm)	vc (m/min)	f (mm/tooth)	ap (mm)	vc (m/min)	f (mm/tooth)	ap (mm)	vc (m/min)	f (mm/tooth)	ap (mm)	vc (m/min)	f (mm/tooth)	ap (mm)

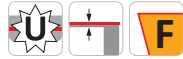
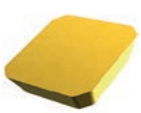

AFFN Schneidkantenpräparation, ohne Spanwinkel zur leichten bis mittleren Bearbeitung.

SEEN 1203AFFN:M8330	☉	–	■	270	0.15	2.0	▣	160	0.14	2.0	▤	255	0.15	2.0	–	–	–	–	–	–
SEEN 1203AFFN:M8340	☉	–	■	245	0.15	2.0	▣	145	0.14	2.0	▤	230	0.15	2.0	–	–	–	–	–	–

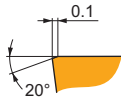

AFSN Schneidkantenpräparation, ohne Spanwinkel zur mittleren bis schweren Bearbeitung.

SEEN 1203AFSN:8215	☉	–	■	255	0.20	2.0	–	–	–	▤	240	0.20	2.0	–	–	–	–	–	▣	50	0.13	1.0
SEEN 1203AFSN:M8330	☉	–	■	255	0.20	2.0	–	–	–	▤	240	0.20	2.0	–	–	–	–	–	▣	50	0.13	1.0
SEEN 1203AFSN:M8340	☉	–	■	230	0.20	2.0	–	–	–	▤	215	0.20	2.0	–	–	–	–	–	–	–	–	–
SEEN 1203AFSN:M9315	☉	–	■	340	0.20	2.0	–	–	–	▤	320	0.20	2.0	–	–	–	–	–	▣	65	0.13	1.0
SEEN 1203AFSN:M9325	☉	–	■	315	0.20	2.0	–	–	–	▤	295	0.20	2.0	–	–	–	–	–	▣	60	0.13	1.0

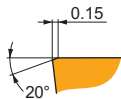

AFSN Schneidkantenpräparation, ohne Spanwinkel zur mittleren bis schweren Bearbeitung.

SEEN 1504AFSN:M8330	☉	–	■	240	0.20	3.0	–	–	–	▤	225	0.20	3.0	–	–	–	–	–	▣	45	0.13	1.3
SEEN 1504AFSN:M8340	☉	–	■	225	0.20	3.0	–	–	–	▤	210	0.20	3.0	–	–	–	–	–	–	–	–	–

SEER



	IC (mm)	M (mm)	S (mm)
1203	12.700	1.6	3.18
1204	12.700	1.6	4.76
1504	15.875	2.0	4.76

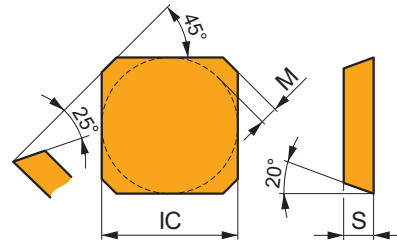

Eignung und Startwerte für Schnittgeschwindigkeit (vc), Vorschub (f) und Schnitttiefe (ap). Weitere Informationen finden Sie in unserer Zerspanungsrechner-App.

Produkt	RE (mm)	P			M			K			N			S			H		
		vc (m/min)	f (mm/tooth)	ap (mm)	vc (m/min)	f (mm/tooth)	ap (mm)	vc (m/min)	f (mm/tooth)	ap (mm)	vc (m/min)	f (mm/tooth)	ap (mm)	vc (m/min)	f (mm/tooth)	ap (mm)	vc (m/min)	f (mm/tooth)	ap (mm)

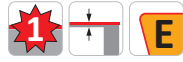
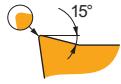

AFEN Schneidkantenpräparation, Spanbrecher geometrie zur mittleren bis schweren Bearbeitung.

SEER 1203AFEN:M8330	☉	-	265	0.24	2.5	155	0.22	2.5	250	0.24	2.5	-	-	-	65	0.22	2.0	-	-	-
SEER 1203AFEN:M8340	☉	-	245	0.24	2.5	145	0.22	2.5	230	0.24	2.5	-	-	-	60	0.22	2.0	-	-	-

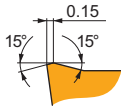

AFSN Schneidkantenpräparation, Spanbrecher geometrie zur mittleren bis schweren Bearbeitung.

SEER 1203AFSN:M8330	☉	-	265	0.25	2.5	155	0.23	2.5	250	0.25	2.5	-	-	-	65	0.20	2.0	-	-	-
SEER 1203AFSN:M8340	☉	-	240	0.25	2.5	140	0.23	2.5	225	0.25	2.5	-	-	-	60	0.20	2.0	-	-	-
SEER 1204AFSN:M8330	☉	-	265	0.25	2.5	155	0.23	2.5	250	0.25	2.5	-	-	-	65	0.20	2.0	-	-	-
SEER 1504AFSN:M8330	☉	-	255	0.25	3.5	150	0.23	3.5	240	0.25	3.5	-	-	-	60	0.20	2.8	-	-	-
SEER 1504AFSN:M8340	☉	-	230	0.25	3.5	135	0.23	3.5	215	0.25	3.5	-	-	-	55	0.20	2.8	-	-	-

SEET 12



	IC (mm)	D1 (mm)	M (mm)	S (mm)
1204	12.700	5.50	1.6	4.76

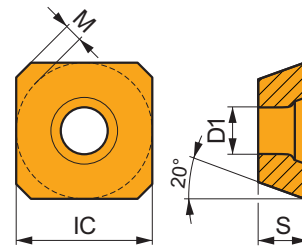

Eignung und Startwerte für Schnittgeschwindigkeit (vc), Vorschub (f) und Schnitttiefe (ap). Weitere Informationen finden Sie in unserer Zerspanungsrechner-App.

Produkt	RE (mm)	P			M			K			N			S			H		
		vc (m/min)	f (mm/tooth)	ap (mm)	vc (m/min)	f (mm/tooth)	ap (mm)	vc (m/min)	f (mm/tooth)	ap (mm)	vc (m/min)	f (mm/tooth)	ap (mm)	vc (m/min)	f (mm/tooth)	ap (mm)	vc (m/min)	f (mm/tooth)	ap (mm)

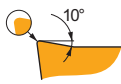

AFEN Schneidkantenpräparation, positive Allzweck-geometrie.

SEET 1204AFEN:M8330	☉	-	265	0.24	2.5	155	0.22	2.5	250	0.24	2.5	-	-	-	65	0.22	2.0	-	-	-
----------------------------	---	---	-----	------	-----	-----	------	-----	-----	------	-----	---	---	---	----	------	-----	---	---	---

Eignung und Startwerte für Schnittgeschwindigkeit (vc), Vorschub (f) und Schnitttiefe (ap). Weitere Informationen finden Sie in unserer Zerspanungsrechner-App.

Produkt	RE (mm)	P			M			K			N			S			H		
		vc (m/min)	f (mm/tooth)	ap (mm)	vc (m/min)	f (mm/tooth)	ap (mm)	vc (m/min)	f (mm/tooth)	ap (mm)	vc (m/min)	f (mm/tooth)	ap (mm)	vc (m/min)	f (mm/tooth)	ap (mm)	vc (m/min)	f (mm/tooth)	ap (mm)

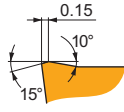
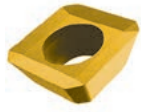

AFSN Schneidkantenpräparation, positive Allzweck-geometrie.

SEET 1204AFSN:8215	☉	–	■	265	0.23	2.5	▣	155	0.21	2.5	■	250	0.23	2.5	–	–	–	▣	65	0.21	2.0	–	–	–
SEET 1204AFSN:M8330	☉	–	■	265	0.24	2.5	▣	155	0.22	2.5	■	250	0.24	2.5	–	–	–	▣	65	0.22	2.0	–	–	–
SEET 1204AFSN:M8340	☉	–	■	240	0.25	2.5	▣	140	0.23	2.5	▣	225	0.25	2.5	–	–	–	▣	60	0.23	2.0	–	–	–
SEET 1204AFSN:M9325	☉	–	■	340	0.20	2.5	–	–	–	–	■	320	0.20	2.5	–	–	–	–	–	–	–	–	–	–

SEET 12-PM



	IC (mm)	D1 (mm)	M (mm)	S (mm)
12T3	13.400	4.20	1.5	3.97

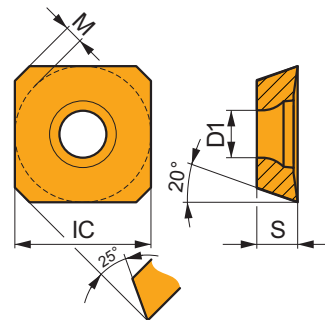

Eignung und Startwerte für Schnittgeschwindigkeit (vc), Vorschub (f) und Schnitttiefe (ap). Weitere Informationen finden Sie in unserer Zerspanungsrechner-App.

Produkt	RE (mm)	P			M			K			N			S			H		
		vc (m/min)	f (mm/tooth)	ap (mm)	vc (m/min)	f (mm/tooth)	ap (mm)	vc (m/min)	f (mm/tooth)	ap (mm)	vc (m/min)	f (mm/tooth)	ap (mm)	vc (m/min)	f (mm/tooth)	ap (mm)	vc (m/min)	f (mm/tooth)	ap (mm)

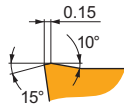
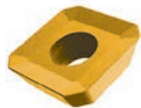

PM geometrie mit positiven Design für jeden Zweck.

SEET 12T3M-PM:M8330	☉	–	■	265	0.25	2.0	▣	155	0.23	2.0	■	250	0.25	2.0	–	–	–	▣	65	0.20	1.6	–	–	–
SEET 12T3M-PM:M8340	☉	–	■	245	0.25	2.0	▣	145	0.23	2.0	▣	230	0.25	2.0	–	–	–	▣	60	0.20	1.6	–	–	–
SEET 12T3M-PM:M9325	☉	–	■	325	0.25	2.0	–	–	–	–	■	305	0.25	2.0	–	–	–	–	–	–	–	–	–	–
SEET 12T3M-PM:M9340	☉	–	■	290	0.25	2.0	▣	170	0.23	2.0	–	–	–	–	–	–	–	▣	70	0.20	1.6	–	–	–

SEET 12-FA



	IC	D1	M	S
	(mm)	(mm)	(mm)	(mm)
1204	12.700	5.50	1.6	4.76

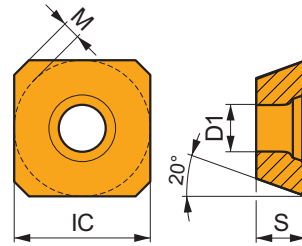

Eignung und Startwerte für Schnittgeschwindigkeit (vc), Vorschub (f) und Schnitttiefe (ap). Weitere Informationen finden Sie in unserer Zerspanungsrechner-App.

Produkt	RE (mm)	P			M			K			N			S			H		
		vc (m/min)	f (mm/tooth)	ap (mm)	vc (m/min)	f (mm/tooth)	ap (mm)	vc (m/min)	f (mm/tooth)	ap (mm)	vc (m/min)	f (mm/tooth)	ap (mm)	vc (m/min)	f (mm/tooth)	ap (mm)	vc (m/min)	f (mm/tooth)	ap (mm)

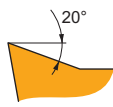
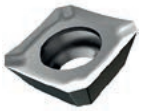

FA geometrie mit hoch positiven Design zur feinen Schlichtbearbeitung bis zur mittleren Bearbeitung.

SEET 1204AFN-FA:HF7	●	-	-	-	-	-	-	-	-	-	■	330	0.18	3.0	-	-	-	-	-
---------------------	---	---	---	---	---	---	---	---	---	---	---	-----	------	-----	---	---	---	---	---

SEEW 12



	IC	D1	M	S
	(mm)	(mm)	(mm)	(mm)
1204	12.700	5.50	1.6	4.76

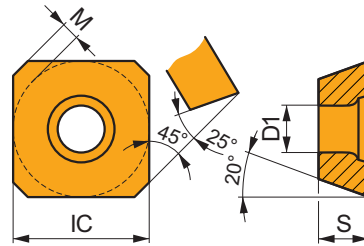

Eignung und Startwerte für Schnittgeschwindigkeit (vc), Vorschub (f) und Schnitttiefe (ap). Weitere Informationen finden Sie in unserer Zerspanungsrechner-App.

Produkt	RE (mm)	P			M			K			N			S			H		
		vc (m/min)	f (mm/tooth)	ap (mm)	vc (m/min)	f (mm/tooth)	ap (mm)	vc (m/min)	f (mm/tooth)	ap (mm)	vc (m/min)	f (mm/tooth)	ap (mm)	vc (m/min)	f (mm/tooth)	ap (mm)	vc (m/min)	f (mm/tooth)	ap (mm)

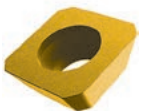

AFEN Schneidkantenpräparation ohne Spanwinkel zur leichten bis mittleren Bearbeitung.

SEEW 1204AFEN:M8330	●	-	■	265	0.15	2.5	-	-	-	■	250	0.15	2.5	-	-	-	-	-	-
SEEW 1204AFEN:M8340	●	-	■	240	0.15	2.5	-	-	-	■	225	0.15	2.5	-	-	-	-	-	-

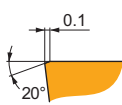
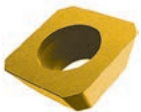

AFSN Schneidkantenpräparation ohne Spanwinkel zur leichten bis mittleren Bearbeitung.

SEEW 1204AFSN:8215	●	-	■	250	0.20	2.5	-	-	-	■	235	0.20	2.5	-	-	-	-	-	■	50	0.13	1.0
SEEW 1204AFSN:M8330	●	-	■	245	0.20	2.5	-	-	-	■	230	0.20	2.5	-	-	-	-	-	■	45	0.13	1.0
SEEW 1204AFSN:M8340	●	-	■	225	0.20	2.5	-	-	-	■	210	0.20	2.5	-	-	-	-	-	-	-	-	-
SEEW 1204AFSN:M9325	●	-	■	305	0.20	2.5	-	-	-	■	285	0.20	2.5	-	-	-	-	-	■	60	0.13	1.0

SNHF



	BS (mm)	IC (mm)	M (mm)	S (mm)
1204	2.00	12.700	0.5	4.76
1504	1.40	15.875	1.1	4.76

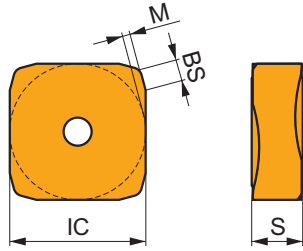

Eignung und Startwerte für Schnittgeschwindigkeit (vc), Vorschub (f) und Schnitttiefe (ap). Weitere Informationen finden Sie in unserer Zerspanungsrechner-App.

Produkt	RE (mm)	P			M			K			N			S			H		
		vc (m/min)	f (mm/tooth)	ap (mm)	vc (m/min)	f (mm/tooth)	ap (mm)	vc (m/min)	f (mm/tooth)	ap (mm)	vc (m/min)	f (mm/tooth)	ap (mm)	vc (m/min)	f (mm/tooth)	ap (mm)	vc (m/min)	f (mm/tooth)	ap (mm)

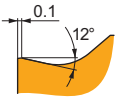

M geometrie mit positiven Design zur leichten bis mittleren Bearbeitung.

SNHF 1204ENSR-M:M8330	☼	–	█	235	0.15	4.0	–	–	–	█	220	0.15	4.0	–	–	–	–	–	–
SNHF 1504ENSR-M:M8340	☼	–	█	220	0.15	6.0	–	–	–	█	205	0.15	6.0	–	–	–	–	–	–

SNHN



	BS (mm)	IC (mm)	M (mm)	S (mm)
1204	1.40	12.700	0.9	4.76
1504	1.40	15.875	1.3	4.76

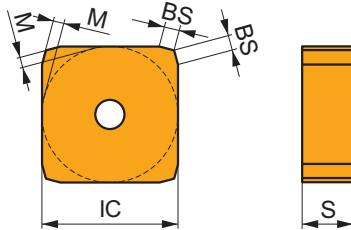

Eignung und Startwerte für Schnittgeschwindigkeit (vc), Vorschub (f) und Schnitttiefe (ap). Weitere Informationen finden Sie in unserer Zerspanungsrechner-App.

Produkt	RE (mm)	P			M			K			N			S			H		
		vc (m/min)	f (mm/tooth)	ap (mm)	vc (m/min)	f (mm/tooth)	ap (mm)	vc (m/min)	f (mm/tooth)	ap (mm)	vc (m/min)	f (mm/tooth)	ap (mm)	vc (m/min)	f (mm/tooth)	ap (mm)	vc (m/min)	f (mm/tooth)	ap (mm)

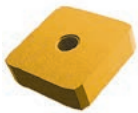

ENEN standard negative Fräsgeometrie zum 75° Planfräsen.

SNHN 1204ENEN:8215	☼	–	█	275	0.15	6.0	–	–	–	█	260	0.15	6.0	–	–	–	–	–	█	55	0.11	1.0
SNHN 1204ENEN:M8330	☼	–	█	270	0.15	6.0	–	–	–	█	255	0.15	6.0	–	–	–	–	–	█	50	0.11	1.0
SNHN 1204ENEN:M8340	☼	–	█	245	0.15	6.0	–	–	–	█	230	0.15	6.0	–	–	–	–	–	–	–	–	–
SNHN 1204ENEN:S26	☼	–	█	110	0.15	6.0	–	–	–	–	–	–	–	–	–	–	–	–	–	–	–	–
SNHN 1504ENEN:8215	☼	–	█	260	0.15	9.0	–	–	–	█	245	0.15	9.0	–	–	–	–	–	█	50	0.11	1.3
SNHN 1504ENEN:M8330	☼	–	█	260	0.15	9.0	–	–	–	█	245	0.15	9.0	–	–	–	–	–	█	50	0.11	1.3
SNHN 1504ENEN:M8340	☼	–	█	235	0.15	9.0	–	–	–	█	220	0.15	9.0	–	–	–	–	–	–	–	–	–
SNHN 1504ENEN:S26	☼	–	█	105	0.15	9.0	–	–	–	–	–	–	–	–	–	–	–	–	–	–	–	–

SNUN



	IC (mm)	S (mm)
1204	12.700	4.76
1504	15.875	4.76

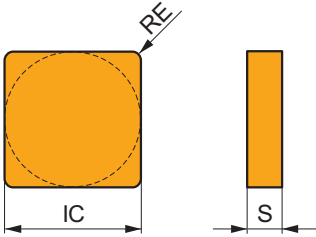

Eignung und Startwerte für Schnittgeschwindigkeit (vc), Vorschub (f) und Schnitttiefe (ap). Weitere Informationen finden Sie in unserer Zerspanungsrechner-App.

Produkt	RE (mm)	P			M			K			N			S			H		
		vc (m/min)	f (mm/tooth)	ap (mm)	vc (m/min)	f (mm/tooth)	ap (mm)	vc (m/min)	f (mm/tooth)	ap (mm)	vc (m/min)	f (mm/tooth)	ap (mm)	vc (m/min)	f (mm/tooth)	ap (mm)	vc (m/min)	f (mm/tooth)	ap (mm)

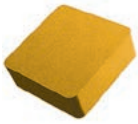

N wendeschneidplatte mit negativer Geometrie zum Fräsen, kann auch zum Drehen verwendet werden.

SNUN 120408:M8330	0.8	260	0.13	4.5	–	–	–	245	0.13	4.5	–	–	–	–	–	–	50	0.10	1.0
SNUN 120412:M8330	1.2	275	0.13	4.5	–	–	–	260	0.13	4.5	–	–	–	–	–	–	55	0.10	1.0
SNUN 150412:M8330	1.2	255	0.15	6.0	–	–	–	240	0.15	6.0	–	–	–	–	–	–	50	0.12	1.3

SOMT 05



	IC (mm)	D1 (mm)	L (mm)	S (mm)
0502	5.570	2.50	5.57	2.63

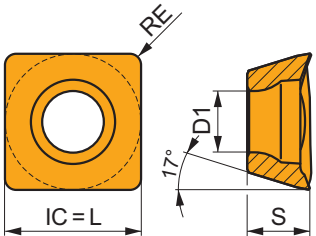

Eignung und Startwerte für Schnittgeschwindigkeit (vc), Vorschub (f) und Schnitttiefe (ap). Weitere Informationen finden Sie in unserer Zerspanungsrechner-App.

Produkt	RE (mm)	P			M			K			N			S			H		
		vc (m/min)	f (mm/tooth)	ap (mm)	vc (m/min)	f (mm/tooth)	ap (mm)	vc (m/min)	f (mm/tooth)	ap (mm)	vc (m/min)	f (mm/tooth)	ap (mm)	vc (m/min)	f (mm/tooth)	ap (mm)	vc (m/min)	f (mm/tooth)	ap (mm)

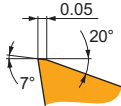

M Geometrie mit positiven Design zur leichten bis mittleren Bearbeitung.

SOMT 050204SR-M:M6330	0.4	255	0.05	2.5	180	0.05	2.5	–	–	–	–	–	–	75	0.04	2.0	–	–	–
SOMT 050204SR-M:M8330	0.4	290	0.05	2.5	170	0.05	2.5	275	0.05	2.5	–	–	–	70	0.04	2.0	–	–	–
SOMT 050208SR-M:M8330	0.8	350	0.05	2.5	210	0.05	2.5	330	0.05	2.5	–	–	–	85	0.04	2.0	–	–	–

SPGN



	IC (mm)	S (mm)
0903	9.525	3.18
1203	12.700	3.18
1504	15.875	4.76

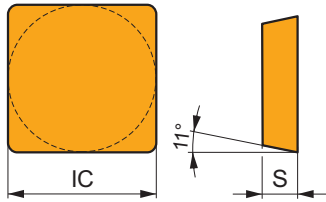

Eignung und Startwerte für Schnittgeschwindigkeit (vc), Vorschub (f) und Schnitttiefe (ap). Weitere Informationen finden Sie in unserer Zerspanungsrechner-App.

Produkt	RE (mm)	P			M			K			N			S			H		
		vc (m/min)	f (mm/tooth)	ap (mm)	vc (m/min)	f (mm/tooth)	ap (mm)	vc (m/min)	f (mm/tooth)	ap (mm)	vc (m/min)	f (mm/tooth)	ap (mm)	vc (m/min)	f (mm/tooth)	ap (mm)	vc (m/min)	f (mm/tooth)	ap (mm)

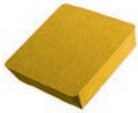

N ohne Spanwinkel, Design zum Fräsen, kann auch zum Drehen verwendet werden.

SPGN 090308:M8340	0.8	225	0.15	2.0	–	–	–	210	0.15	2.0	–	–	–	–	–	–	–	–
SPGN 120308:M8330	0.8	230	0.15	4.0	–	–	–	215	0.15	4.0	–	–	–	–	–	–	–	–
SPGN 150412:M8330	1.2	225	0.20	5.0	–	–	–	210	0.20	5.0	–	–	–	–	–	–	–	–

SPGN 25 DZ



	IC (mm)	M (mm)	S (mm)	BS (mm)
2506	25.000	3.5	6.35	2.40

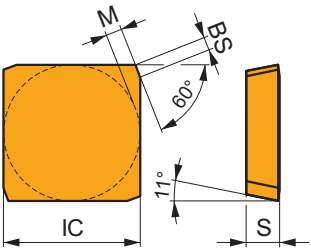

Eignung und Startwerte für Schnittgeschwindigkeit (vc), Vorschub (f) und Schnitttiefe (ap). Weitere Informationen finden Sie in unserer Zerspanungsrechner-App.

Produkt	RE (mm)	P			M			K			N			S			H		
		vc (m/min)	f (mm/tooth)	ap (mm)	vc (m/min)	f (mm/tooth)	ap (mm)	vc (m/min)	f (mm/tooth)	ap (mm)	vc (m/min)	f (mm/tooth)	ap (mm)	vc (m/min)	f (mm/tooth)	ap (mm)	vc (m/min)	f (mm/tooth)	ap (mm)

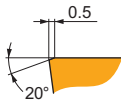
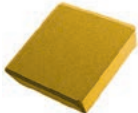

DZ geometrie ohne Spanwinkel zur schweren Bearbeitung.

SPGN 2506DZSR:M8326	–	110	0.50	12.0	–	–	–	100	0.50	12.0	–	–	–	–	–	–	–	–
SPGN 2506DZSR:M8346	–	90	0.50	12.0	–	–	–	–	–	–	–	–	–	–	–	–	–	–

SPKN

	IC (mm)	M (mm)	S (mm)	BS (mm)
1203	12.700	0.9	3.18	1.60
1504	15.875	1.3	4.76	1.70

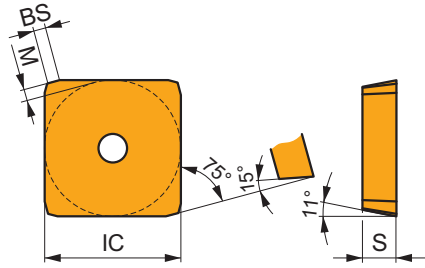

Eignung und Startwerte für Schnittgeschwindigkeit (vc), Vorschub (f) und Schnitttiefe (ap). Weitere Informationen finden Sie in unserer Zerspanungsrechner-App.

Produkt	RE (mm)	P			M			K			N			S			H		
		vc (m/min)	f (mm/tooth)	ap (mm)	vc (m/min)	f (mm/tooth)	ap (mm)	vc (m/min)	f (mm/tooth)	ap (mm)	vc (m/min)	f (mm/tooth)	ap (mm)	vc (m/min)	f (mm/tooth)	ap (mm)	vc (m/min)	f (mm/tooth)	ap (mm)

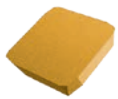

EDER Schneidkantenpräparation ohne Spanwinkel zur leichten bis mittleren Bearbeitung.

SPKN 1203EDER:M8330	☹	–	█	255	0.15	4.0	–	–	–	█	240	0.15	4.0	–	–	–	–	–	–
SPKN 1203EDER:M8340	☹	–	█	230	0.15	4.0	–	–	–	█	215	0.15	4.0	–	–	–	–	–	–
SPKN 1504EDER:M8330	☹	–	█	235	0.20	5.0	–	–	–	█	220	0.20	5.0	–	–	–	–	–	–
SPKN 1504EDER:M8340	☹	–	█	210	0.20	5.0	–	–	–	█	195	0.20	5.0	–	–	–	–	–	–

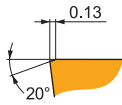
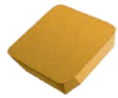

EDSR Schneidkantenpräparation ohne Spanwinkel für die mittlere Bearbeitung.

SPKN 1203EDSL:M8330	☹	–	█	240	0.20	4.0	–	–	–	█	225	0.20	4.0	–	–	–	–	–	█	45	0.13	1.0
SPKN 1203EDSR:M8330	☹	–	█	240	0.20	4.0	–	–	–	█	225	0.20	4.0	–	–	–	–	–	█	45	0.13	1.0
SPKN 1203EDSR:M8340	☹	–	█	215	0.20	4.0	–	–	–	█	200	0.20	4.0	–	–	–	–	–	–	–	–	–
SPKN 1203EDSR:M9325	☹	–	█	290	0.20	4.0	–	–	–	█	275	0.20	4.0	–	–	–	–	–	█	55	0.13	1.0
SPKN 1203EDSR:S26	☹	–	█	95	0.20	4.0	–	–	–	–	–	–	–	–	–	–	–	–	–	–	–	–

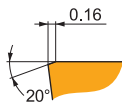
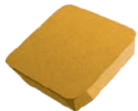

EDS, EDSR (rechtsschneidend)/EDSL (linksschneidend) Schneidkantenpräparation ohne Spanbrecher zur mittleren Bearbeitung.

SPKN 1504EDSR:8215	☹	–	█	220	0.25	5.0	–	–	–	█	205	0.25	5.0	–	–	–	–	–	█	40	0.13	1.3
SPKN 1504EDSR:M8330	☹	–	█	220	0.25	5.0	–	–	–	█	205	0.25	5.0	–	–	–	–	–	█	40	0.13	1.3
SPKN 1504EDSR:M8340	☹	–	█	205	0.25	5.0	–	–	–	█	190	0.25	5.0	–	–	–	–	–	–	–	–	–
SPKN 1504EDSR:M9315	☹	–	█	285	0.25	5.0	–	–	–	█	270	0.25	5.0	–	–	–	–	–	█	55	0.13	1.3
SPKN 1504EDSR:M9325	☹	–	█	270	0.25	5.0	–	–	–	█	255	0.25	5.0	–	–	–	–	–	█	50	0.13	1.3
SPKN 1504EDSR:S26	☹	–	█	90	0.25	5.0	–	–	–	–	–	–	–	–	–	–	–	–	–	–	–	–

SPKR



	IC (mm)	L (mm)	M (mm)	S (mm)
1203	12.700	12.70	0.9	3.18
1504	15.875	15.88	1.2	4.76

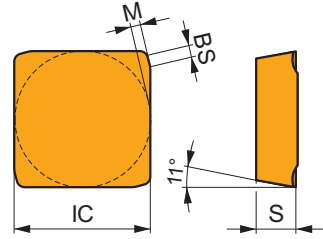

Eignung und Startwerte für Schnittgeschwindigkeit (vc), Vorschub (f) und Schnitttiefe (ap). Weitere Informationen finden Sie in unserer Zerspanungsrechner-App.

Produkt	RE (mm)	P			M			K			N			S			H		
		vc (m/min)	f (mm/tooth)	ap (mm)	vc (m/min)	f (mm/tooth)	ap (mm)	vc (m/min)	f (mm/tooth)	ap (mm)	vc (m/min)	f (mm/tooth)	ap (mm)	vc (m/min)	f (mm/tooth)	ap (mm)	vc (m/min)	f (mm/tooth)	ap (mm)

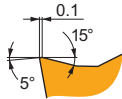
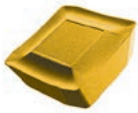

EDSR Schneidkantenpräparation, Spanbrecher geometrie zur mittleren bis schweren Bearbeitung.

SPKR 1203EDSR:M8330	0.4	-	265	0.20	4.0	155	0.18	4.0	250	0.20	4.0	-	-	-	-	-	-	-
SPKR 1203EDSR:M8340	0.8	-	240	0.20	4.0	140	0.18	4.0	225	0.20	4.0	-	-	-	-	-	-	-

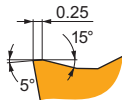

EDSR Schneidkantenpräparation, Spanbrecher geometrie zur mittleren bis schweren Bearbeitung.

SPKR 1504EDSR:M8330	0.4	-	245	0.25	5.0	145	0.25	5.0	230	0.25	5.0	-	-	-	-	-	-	-
SPKR 1504EDSR:M8340	0.8	-	225	0.25	5.0	135	0.25	5.0	210	0.25	5.0	-	-	-	-	-	-	-

SPUN



	IC (mm)	S (mm)
1203	12.700	3.18
1504	15.875	4.76
1904	19.050	4.76
2506	25.400	6.35

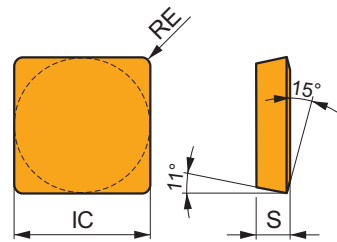

Eignung und Startwerte für Schnittgeschwindigkeit (vc), Vorschub (f) und Schnitttiefe (ap). Weitere Informationen finden Sie in unserer Zerspanungsrechner-App.

Produkt	RE (mm)	P			M			K			N			S			H		
		vc (m/min)	f (mm/tooth)	ap (mm)	vc (m/min)	f (mm/tooth)	ap (mm)	vc (m/min)	f (mm/tooth)	ap (mm)	vc (m/min)	f (mm/tooth)	ap (mm)	vc (m/min)	f (mm/tooth)	ap (mm)	vc (m/min)	f (mm/tooth)	ap (mm)



N ohne Spanwinkel, Design zum Fräsen, kann auch zum Drehen verwendet werden.

SPUN 120304:M8330	0.4	195	0.15	4.0	-	-	-	185	0.15	4.0	-	-	-	-	-	-	-	-
SPUN 120308:M8330	0.8	230	0.15	4.0	-	-	-	215	0.15	4.0	-	-	-	-	-	-	-	-
SPUN 120308:S26	0.8	95	0.15	4.0	-	-	-	-	-	-	-	-	-	-	-	-	-	-
SPUN 120312:M8330	1.2	245	0.15	4.0	-	-	-	230	0.15	4.0	-	-	-	-	-	-	-	-

Eignung und Startwerte für Schnittgeschwindigkeit (vc), Vorschub (f) und Schnitttiefe (ap). Weitere Informationen finden Sie in unserer Zerspanungsrechner-App.

Produkt	RE (mm)	P			M			K			N			S			H		
		vc (m/min)	f (mm/tooth)	ap (mm)	vc (m/min)	f (mm/tooth)	ap (mm)	vc (m/min)	f (mm/tooth)	ap (mm)	vc (m/min)	f (mm/tooth)	ap (mm)	vc (m/min)	f (mm/tooth)	ap (mm)	vc (m/min)	f (mm/tooth)	ap (mm)



N ohne Spanwinkel, Design zum Fräsen, kann auch zum Drehen verwendet werden.

SPUN 150412:M8330	✳	1.2	225	0.20	5.0	–	–	–	210	0.20	5.0	–	–	–	–	–	–	–	–
SPUN 190408:M8330	✳	0.8	210	0.20	6.0	–	–	–	195	0.20	6.0	–	–	–	–	–	–	–	–
SPUN 190412:M8330	✳	1.2	220	0.20	6.0	–	–	–	205	0.20	6.0	–	–	–	–	–	–	–	–

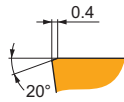

N ohne Spanwinkel, Design zum Fräsen, kann auch zum Drehen verwendet werden.

SPUN 250616S:M8326	✳	1.6	115	0.40	12.0	–	–	–	105	0.40	12.0	–	–	–	–	–	–	–	–
SPUN 250620S:M5326	✳	2.0	145	0.40	12.0	–	–	–	135	0.40	12.0	–	–	–	–	–	–	–	–
SPUN 250620S:M8326	✳	2.0	120	0.40	12.0	–	–	–	110	0.40	12.0	–	–	–	–	–	–	–	–
SPUN 250620S:M8346	✳	2.0	100	0.40	12.0	–	–	–	–	–	–	–	–	–	–	–	–	–	–
SPUN 250620S:S26	✳	2.0	45	0.40	12.0	–	–	–	–	–	–	–	–	–	–	–	–	–	–

TPCN 16



	BS (mm)	IC (mm)	L (mm)	M (mm)	S (mm)
1603	1.20	9.530	16.10	2.5	3.18

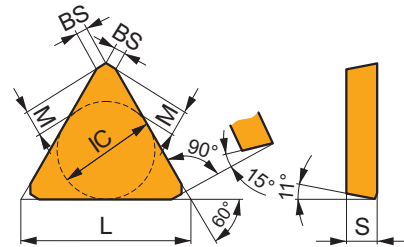

Eignung und Startwerte für Schnittgeschwindigkeit (vc), Vorschub (f) und Schnitttiefe (ap). Weitere Informationen finden Sie in unserer Zerspanungsrechner-App.

Produkt	RE (mm)	P			M			K			N			S			H		
		vc (m/min)	f (mm/tooth)	ap (mm)	vc (m/min)	f (mm/tooth)	ap (mm)	vc (m/min)	f (mm/tooth)	ap (mm)	vc (m/min)	f (mm/tooth)	ap (mm)	vc (m/min)	f (mm/tooth)	ap (mm)	vc (m/min)	f (mm/tooth)	ap (mm)

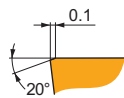
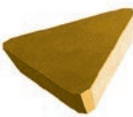

XNCB besondere Ausführung für Scheibenfräser.

TPCN 1603PDSN:M8330	✳	–	195	0.20	–	–	–	–	185	0.20	–	–	–	–	–	–	–	–	–
---------------------	---	---	-----	------	---	---	---	---	-----	------	---	---	---	---	---	---	---	---	---

TPKN



	IC (mm)	L (mm)	M (mm)	S (mm)	BCH (mm)	BS (mm)
1603	9.530	16.50	2.5	3.18	1.20	1.30
2204	12.700	22.00	3.5	4.76	1.20	1.50

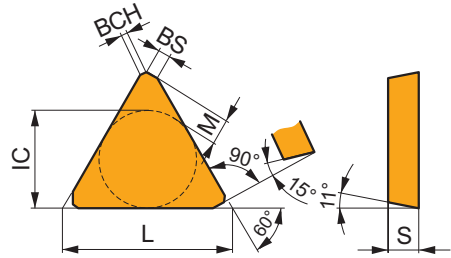

Eignung und Startwerte für Schnittgeschwindigkeit (vc), Vorschub (f) und Schnitttiefe (ap). Weitere Informationen finden Sie in unserer Zerspanungsrechner-App.

Produkt	RE (mm)	P			M			K			N			S			H		
		vc (m/min)	f (mm/tooth)	ap (mm)	vc (m/min)	f (mm/tooth)	ap (mm)	vc (m/min)	f (mm/tooth)	ap (mm)	vc (m/min)	f (mm/tooth)	ap (mm)	vc (m/min)	f (mm/tooth)	ap (mm)	vc (m/min)	f (mm/tooth)	ap (mm)

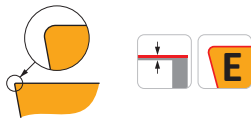
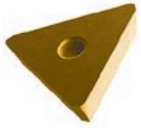

PDER Schneidkantenpräparation, ohne Spanwinkel zur leichten bis mittleren Bearbeitung.

TPKN 1603PDER:M8330	●	–	✓	195	0.15	4.0	–	–	–	✓	185	0.15	4.0	–	–	–	–	–	–	–	–	–	–	–
TPKN 1603PDER:M8340	●	–	✓	175	0.15	4.0	–	–	–	✓	165	0.15	4.0	–	–	–	–	–	–	–	–	–	–	–
TPKN 2204PDER:8215	●	–	✓	190	0.15	5.5	–	–	–	✓	180	0.15	5.5	–	–	–	–	–	–	–	–	–	–	–
TPKN 2204PDER:M8330	●	–	✓	190	0.15	5.5	–	–	–	✓	180	0.15	5.5	–	–	–	–	–	–	–	–	–	–	–
TPKN 2204PDER:M8340	●	–	✓	170	0.15	5.5	–	–	–	✓	160	0.15	5.5	–	–	–	–	–	–	–	–	–	–	–

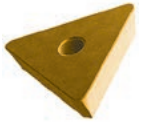

PDSR Schneidkantenpräparation, ohne Spanwinkel zur mittleren Bearbeitung.

TPKN 1603PDSR:M8330	●	–	✓	185	0.20	4.0	–	–	–	✓	175	0.20	4.0	–	–	–	–	–	–	–	–	–	–	–	–	
TPKN 1603PDSR:M8340	●	–	✓	165	0.20	4.0	–	–	–	✓	155	0.20	4.0	–	–	–	–	–	–	–	–	–	–	–	–	
TPKN 1603PDSR:S26	●	–	✓	75	0.20	4.0	–	–	–	–	–	–	–	–	–	–	–	–	–	–	–	–	–	–	–	
TPKN 2204PDSR:M8310	●	–	✓	195	0.20	5.5	–	–	–	✓	185	0.20	5.5	–	–	–	–	–	–	–	–	–	✓	35	0.13	1.0
TPKN 2204PDSR:M8330	●	–	✓	175	0.20	5.5	–	–	–	✓	165	0.20	5.5	–	–	–	–	–	–	–	–	–	✓	35	0.13	1.0
TPKN 2204PDSR:M8340	●	–	✓	160	0.20	5.5	–	–	–	✓	150	0.20	5.5	–	–	–	–	–	–	–	–	–	–	–	–	
TPKN 2204PDSR:M9325	●	–	✓	220	0.20	5.5	–	–	–	✓	205	0.20	5.5	–	–	–	–	–	–	–	–	–	✓	40	0.13	1.0
TPKN 2204PDSR:S26	●	–	✓	75	0.20	5.5	–	–	–	–	–	–	–	–	–	–	–	–	–	–	–	–	–	–	–	

TPKR



	IC	L	M	S	BS
	(mm)	(mm)	(mm)	(mm)	(mm)
1603	9.530	16.50	2.5	3.18	1.40
2204	12.700	22.00	3.5	4.76	1.40

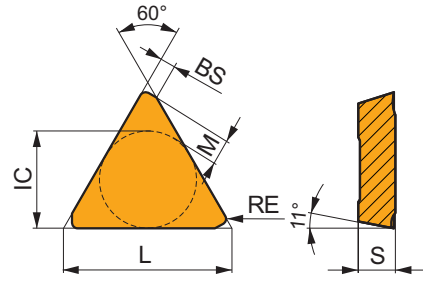

Eignung und Startwerte für Schnittgeschwindigkeit (vc), Vorschub (f) und Schnitttiefe (ap). Weitere Informationen finden Sie in unserer Zerspanungsrechner-App.

Produkt	RE (mm)	P			M			K			N			S			H		
		vc	f	ap	vc	f	ap	vc	f	ap	vc	f	ap	vc	f	ap	vc	f	ap
		(m/min)	(mm/tooth)	(mm)	(m/min)	(mm/tooth)	(mm)	(m/min)	(mm/tooth)	(mm)	(m/min)	(mm/tooth)	(mm)	(m/min)	(mm/tooth)	(mm)	(m/min)	(mm/tooth)	(mm)

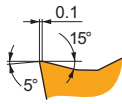

PDSR Schneidkantenpräparation, Spanbrechergeometrie zur mittleren bis schweren Bearbeitung.

TPKR 1603PDSR:M8330	●	–	■	185	0.20	4.0	▣	110	0.18	4.0	■	175	0.20	4.0	–	–	–	–	–	–
TPKR 1603PDSR:M8340	●	–	■	165	0.20	4.0	▣	95	0.18	4.0	■	155	0.20	4.0	–	–	–	–	–	–
TPKR 2204PDSR:M8330	●	–	■	175	0.20	5.5	▣	105	0.18	5.5	■	165	0.20	5.5	–	–	–	–	–	–
TPKR 2204PDSR:M8340	●	–	■	160	0.20	5.5	▣	95	0.18	5.5	■	150	0.20	5.5	–	–	–	–	–	–
TPKR 2204PDSR:M9325	●	–	■	220	0.20	5.5	–	–	–	–	■	205	0.20	5.5	–	–	–	–	–	–

TPUN



	IC	L	S
	(mm)	(mm)	(mm)
1103	6.350	11.00	3.18
1603	9.525	16.50	3.18
2204	12.700	22.00	4.76

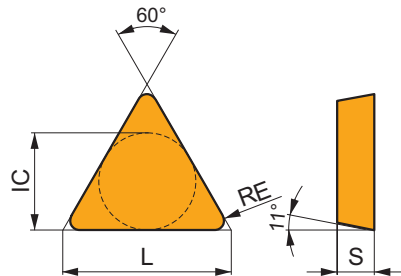

Eignung und Startwerte für Schnittgeschwindigkeit (vc), Vorschub (f) und Schnitttiefe (ap). Weitere Informationen finden Sie in unserer Zerspanungsrechner-App.

Produkt	RE (mm)	P			M			K			N			S			H		
		vc	f	ap	vc	f	ap	vc	f	ap	vc	f	ap	vc	f	ap	vc	f	ap
		(m/min)	(mm/tooth)	(mm)	(m/min)	(mm/tooth)	(mm)	(m/min)	(mm/tooth)	(mm)	(m/min)	(mm/tooth)	(mm)	(m/min)	(mm/tooth)	(mm)	(m/min)	(mm/tooth)	(mm)



N ohne Spanwinkel, Design zum Fräsen, kann auch zum Drehen verwendet werden.

TPUN 110304:M8330	●	0.4	–	–	–	–	–	–	–	–	■	150	0.10	1.2	–	–	–	–	–	–	▣	30	0.10	0.4	
TPUN 160304:8215	●	0.4	▣	155	0.15	4.0	–	–	–	–	■	145	0.15	4.0	–	–	–	–	–	–	–	–	–	–	
TPUN 160304:H10	●	0.4	–	–	–	–	–	–	–	–	■	65	0.15	4.0	–	–	–	–	–	–	–	–	–	–	
TPUN 160304:M8330	●	0.4	▣	155	0.15	4.0	–	–	–	–	■	145	0.15	4.0	–	–	–	–	–	–	–	–	–	–	
TPUN 160304:S26	●	0.4	▣	65	0.15	4.0	–	–	–	–	–	–	–	–	–	–	–	–	–	–	–	–	–	–	
TPUN 160308:8215	●	0.8	▣	185	0.15	4.0	–	–	–	–	■	175	0.15	4.0	–	–	–	–	–	–	–	–	–	–	
TPUN 160308:M8330	●	0.8	–	–	–	–	–	–	–	–	■	155	0.18	1.5	–	–	–	–	–	–	–	▣	30	0.11	0.6
TPUN 160312:M8330	●	1.2	–	–	–	–	–	–	–	–	■	155	0.20	1.5	–	–	–	–	–	–	–	▣	30	0.11	0.8
TPUN 220408:M8330	●	0.8	▣	170	0.20	5.0	–	–	–	–	■	160	0.20	5.0	–	–	–	–	–	–	–	–	–	–	
TPUN 220412:M8330	●	1.2	–	–	–	–	–	–	–	–	■	155	0.20	2.0	–	–	–	–	–	–	–	▣	30	0.11	1.0

XDHW



	IC (mm)	D1 (mm)	L (mm)	S (mm)
0702	6.500	2.95	6.90	2.38
10T3	10.000	3.95	10.60	3.97

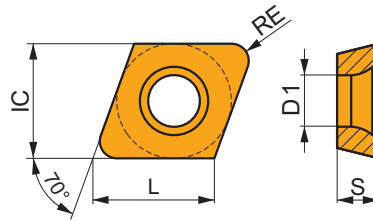

Eignung und Startwerte für Schnittgeschwindigkeit (vc), Vorschub (f) und Schnitttiefe (ap). Weitere Informationen finden Sie in unserer Zerspanungsrechner-App.

Produkt	RE (mm)	P			M			K			N			S			H		
		vc (m/min)	f (mm/tooth)	ap (mm)	vc (m/min)	f (mm/tooth)	ap (mm)	vc (m/min)	f (mm/tooth)	ap (mm)	vc (m/min)	f (mm/tooth)	ap (mm)	vc (m/min)	f (mm/tooth)	ap (mm)	vc (m/min)	f (mm/tooth)	ap (mm)



EN geometrie ohne Spanwinkel zum Nutfräsen.

XDHW 070210EN:M8310	1.0	310	0.10	1.0	–	–	–	290	0.10	1.0	–	–	–	–	–	–	–	–	60	0.05	1.0
----------------------------	-----	-----	------	-----	---	---	---	-----	------	-----	---	---	---	---	---	---	---	---	----	------	-----

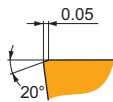

SN geometrie ohne Spanwinkel zum Nutfräsen.

XDHW 070210SN:M8310	1.0	310	0.10	1.0	–	–	–	290	0.10	1.0	–	–	–	–	–	–	–	–	60	0.05	1.0
XDHW 070210SN:M8325	1.0	230	0.10	1.0	–	–	–	–	–	–	–	–	–	–	–	–	–	–	–	–	–
XDHW 10T310SN:M8310	1.0	275	0.15	1.0	–	–	–	260	0.15	1.0	–	–	–	–	–	–	–	–	55	0.08	1.0
XDHW 10T310SN:M8325	1.0	210	0.15	1.0	–	–	–	–	–	–	–	–	–	–	–	–	–	–	–	–	–



ANLEITUNGEN

WENDEPLATTENFRÄSER – SEITENÜBERSICHT

1 SAD11E

P M K N S H **2**

PRAMET **3** **S**



FORCE AD11 Eckfräser mit Innenkühlung

90° Schafffräser und Messerköpfe mit positiven AD.. 11 Wendeschneidplatten mit APMX von 9 mm. Geeignet fürs Plan-, Schulter-, Nut-, Helix-, Trochoiden-, Rampen- und Tauchfräsen. Erhältlich mit zylindrischem, Weldon, Morsekegel-, modularem Schaft und als Aufsteckfräser (mit ungleicher Teilung). Für längere Standzeiten ist der Körper oberflächenbehandelt.

FORCE AD

KAPR **6** 90°
APMX 9.0 mm

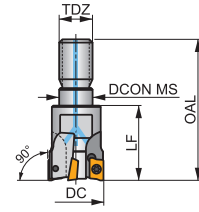
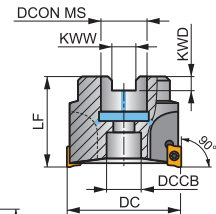
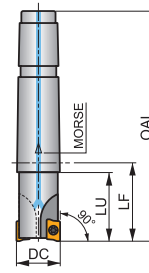
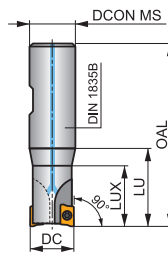
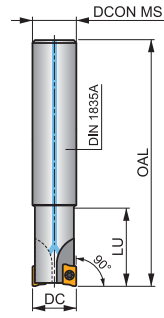
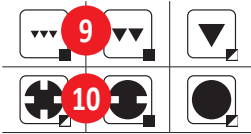
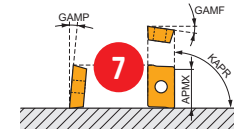

11 h_a 0.06 – 0.13
 h_b 0.08 – 0.16



Produkt	DC	OAL	DCON MS	DCCB	LU	LUX	LF	TDZ	CZC MS	KWW	KWD	GAMF	GAMP	16	18	20	22
	(mm)	(mm)	(mm)	(mm)	(mm)	(mm)	(mm)	(mm)	(mm)	(mm)	(mm)	(°)	(°)	17	19	21	23
16A2R024A14-SAD11E-C	16	160	14	-	24	-	-	-	-	-	-	-12.8	4	2	30100	0.19	G1169 SQ025
16A2R024A16-SAD11E-C	16	135	16	-	24	-	-	-	-	-	-	-12.8	4	2	30100	0.20	G1169 SQ025
16A2R050A16-SAD11E-C	16	135	16	-	50	-	-	-	-	-	-	-12.8	4	2	30100	0.20	G1169 SQ025
18A2R029A20-SAD11E-C	18	150	20	-	29	-	-	-	-	-	-	-12	4.5	2	28400	✓	0.35 G1169 SQ025
20A2R029A20-SAD11E-C	20	150	20	-	29	-	-	-	-	-	-	-11.5	5	2	27000	✓	0.33 G1169 SQ020
20A2R071A20-SAD11E-C	20	150	20	-	70	-	-	-	-	-	-	-11.5	5	2	27000	✓	0.32 G1169 SQ020
20A3R018A20-SAD11E-C	20	200	18	-	29	-	-	-	-	-	-	-11.5	5	3	27000	✓	0.36 G1169 SQ025
20A3R029A20-SAD11E-C	20	150	20	-	29	-	-	-	-	-	-	-11.5	5	3	27000	✓	0.31 G1169 SQ025
22A3R029A20-SAD11E-C	22	200	20	-	29	-	-	-	-	-	-	-11.5	5	3	25600	✓	0.45 G1169 SQ025
25A3R034A25-SAD11E-C	25	170	25	-	34	-	-	-	-	-	-	-10.2	5	3	24100	✓	0.42 G1169 SQ020
25A3R080A25-SAD11E-C	25	170	25	-	80	-	-	-	-	-	-	-10.2	5	3	24100	✓	0.52 G1169 SQ020
25A4R034A25-SAD11E-C	25	170	25	-	34	-	-	-	-	-	-	-10.2	5	4	24100	✓	0.56 G1169 SQ025
25A4R040A25-SAD11E-C	25	250	25	-	40	-	-	-	-	-	-	-10.2	5	4	24100	✓	0.85 G1169 SQ025
30A3R080A32-SAD11E-C	30	200	32	-	80	-	-	-	-	-	-	-9.3	7	3	22000	✓	0.98 G1169 SQ020

G1169	ADMX 11T3..	24	ADEX 11T3..
-------	-------------	----	-------------

SQ020	US 62506-T07P	1.2	M 2.5	6	25	-	-	Flag T07P	-
SQ021	US 62506-T07P	1.2	M 2.5	6	-	D-T07P/T09P	FG-15	-	-
SQ022	US 62506-T07P	1.2	M 2.5	6	-	D-T07P/T09P	FG-15	-	HS 0830C
SQ023	US 62506-T07P	1.2	M 2.5	6	-	D-T07P/T09P	FG-15	-	HS 1030C
SQ025	US 62505-T07P	1.2	M 2.5	5	-	-	-	Flag T07P	-

AC001	KS 1230	26	K.FMH27
AC002	KS 1635	-	K.FMH32
AC003	KS 2040	-	K.FMH40

WENDEPLATTENFRÄSER – SEITENÜBERSICHT

Pos.	Beschreibung	Pos.	Beschreibung
1	Fräserbezeichnung	14	ISO-Code für Fräser
2	Materialgruppenempfehlungen	15	Abmessungen (mm), Winkel ¹⁾ (°) und Aufnahmegröße
3	Spannsystem für Wendeschneidplatte	16	Zähneanzahl
4	Illustration	17	Unregelmäßige Steigung der Zähne
5	Werkzeugbeschreibung	18	Max. Drehzahl des Fräasers
6	Einstellwinkel und max. theoretische Schnitttiefe (mm)	19	Interne Kühlmittelzufuhr
7	Werkzeuggeometrie	20	Gewicht (kg)
8	Schematische Zeichnung des Werkzeugs	21	Gruppe kompatibler Wendeschneidplatten ²⁾
9	Erreichbare Oberflächenqualität	22	Ersatzteilgruppe ²⁾
10	Schnittart/Arbeitsbedingungen	23	Sonderzubehörgruppe ²⁾
11	Maximaler Bereich der durchschnittlichen Spandicke (mm) für Schaftfräser und/oder Aufsteckfräser	24	Kompatible Wendeschneidplatten
12	Produktanwendungen	25	Ersatzteile
13	Schafttyp	26	Sonderzubehör

¹⁾ γ_f = Radialer Spanwinkel (GAMF) der Wendeschneidplattentasche – siehe WENDEPLATTENFRÄSER – TECHNISCHE INFORMATIONEN

γ_p = Axialer Spanwinkel (GAMP) der Wendeschneidplattentasche – siehe WENDEPLATTENFRÄSER – TECHNISCHE INFORMATIONEN

²⁾ Die Symbole für Ersatzteile und Sonderzubehör sind zur besseren Verständlichkeit schematisch dargestellt. Sie sind nicht in der Liste der Symbole enthalten. Schrauben sind teilweise mit Angaben zum Drehmomentwert in Nm, zur Schraubenlänge und zur Gewindegröße versehen.

FRÄSWENDESCHNEIDPLATTEN – SEITENÜBERSICHT

1

ADMX 11

	W1	D1	L	S
	(mm)	(mm)	(mm)	(mm)
11T3	6.530	2.90	11.00	3.97

Eignung und Startwerte für Schnittgeschwindigkeit (vc), Vorschub (f) und Schnitttiefe (ap). Weitere Informationen finden Sie in unserer Zerspanungsrechner-App.

Produkt	RE (mm)	P			M			K			N			S			H		
		vc	f	ap	vc	f	ap	vc	f	ap	vc	f	ap	vc	f	ap	vc	f	ap
ADMX 11T304SR-F:8215	0.4	245	0.10	2.0	145	0.09	2.0	230	0.10	2.0	735	0.12	2.0	60	0.08	1.6	–	–	–
ADMX 11T304SR-F:M8330	0.4	240	0.10	2.0	140	0.09	2.0	225	0.10	2.0	720	0.12	2.0	60	0.08	1.6	–	–	–
ADMX 11T304SR-F:M8340	0.4	220	0.10	2.0	130	0.09	2.0	205	0.10	2.0	–	–	–	55	0.08	1.6	–	–	–
ADMX 11T308SR-F:M9340	0.8	285	0.10	2.0	170	0.09	2.0	–	–	–	–	–	70	0.08	1.6	–	–	–	
ADMX 11T308SR-F:8215	0.8	290	0.10	2.0	170	0.09	2.0	275	0.10	2.0	870	0.12	2.0	70	0.08	1.6	–	–	–
ADMX 11T308SR-F:M8330	0.8	285	0.10	2.0	170	0.09	2.0	270	0.10	2.0	855	0.12	2.0	70	0.08	1.6	–	–	–
ADMX 11T308SR-F:M8340	0.8	260	0.10	2.0	155	0.09	2.0	245	0.10	2.0	–	–	–	65	0.08	1.6	–	–	–
ADMX 11T308SR-F:M9340	0.8	340	0.10	2.0	200	0.09	2.0	–	–	–	–	–	85	0.08	1.6	–	–	–	

F-Geometrie mit sehr scharfen und positiven Design zur leichten Bearbeitung.

Pos.	Beschreibung
1	Bezeichnung der Wendeschneidplatte
2	Tabelle der Wendeschneidplattengrößen (mm)
3	Schematische Zeichnung der Wendeschneidplatte
4	Illustration
5	Profil der Hauptschneidkante
6	Symbole – spezifische Merkmale und Schneidkantentyp

Pos.	Beschreibung
7	ISO-Wendeschneidplattencode:Sorte
8	Arbeitsbedingungen
9	Wendeschneidplattenradien (mm)
10	Geometriebeschreibung
11	Anwendungsbereich der Wendeschneidplatte ¹⁾

¹⁾ Empfehlungen für die Korrektur der Schnittgeschwindigkeit sind am Ende des Kapitels „Fräsen“ im technischen Teil zu finden.

Technische Informationen sind direkt nach den Seiten der Fräser, der kompatiblen Wendeschneidplatten und den Infos zu den Anfangsschnittgeschwindigkeiten aufgeführt. Diese helfen beim korrekten Einsatz der Werkzeuge. Bei Unklarheiten bezüglich der Verwendung oder Interpretation dieser Angaben ist entweder der technische Abschnitt am Ende des Fräser-Kapitels zu Rate zu ziehen oder der zuständige Dormer Pramet-Ansprechpartner zu kontaktieren.

Typische Seite mit dargestellter Fräswendeschneidplatte – einzelne Seitendetails können jeweils abweichen. Die meisten Wendeschneidplatten sind in diesem Katalog direkt nach dem jeweiligen Fräser oder alternativ im separaten Kapitel „Wendeschneidplatten“ zu finden.

SYMBOLÜBERBLICK

Allgemeine Symbole

	Vorrangige Anwendung		Schlichten – sehr gute Oberflächenqualität		Geeignet für stabile Arbeitsbedingungen
	Mögliche Anwendung		Mittlere Bearbeitung – gute Oberflächenqualität		Geeignet für instabile Arbeitsbedingungen
			Schruppen – unbegrenzte Oberflächenrauheit		Geeignet für sehr instabile Arbeitsbedingungen

Fräsanwendungen

	Planfräsen		Tauchfräsen		Fasenfräsen
	Flaches Eckfräsen		Progressives Tauchfräsen		T-Nutfräsen
	Tiefes Eckfräsen		Rampen		Rückwärtiges Planfräsen
	Flaches Nutfräsen		Schraubenlinieninterpolation		Konturfräsen (Kopierfräsen)
	Tiefes Nutfräsen		Schraubenlinieninterpolation in ein vorgebohrtes Loch		

Merkmale

	Erste Wahl		Dünnwandige und schlanke Werkstücke		Schwere Arbeitsbedingungen
	Universell, großer Anwendungsbereich		Langer Überhang		
	Wendeschneidplatte mit Schlepschneiden-Geometrie		Bearbeitung mit hohem Vorschub		

Zustandscode der Schneidkante (CECC)

	Scharfe Kante		Kante mit Facette		Gerundete Kante mit Doppelfacette
	Gerundete Kante		Gerundete Kante mit Facette		

Klemmtypcode (MTP)

	S – Schraubklemmung durch Bohrung		System F		Spanndrehmoment der Schraube (Nm)
	C – Klemmung oben		System SC		

SYMBOLÜBERBLICK

Schaft

DIN 1835A	DIN 1835A – Zylindrischer Schaft	ISO/DIS 7388-1	Spindel DIN 69871-1	ISO 6462 DIN 8030	Aufsteckfräser DIN 8030 – Spiralfräser
DIN 1835B	DIN 1835B – Weldon-Schaft	ISO 297	Spindel DIN 2080-1	ISO 6462 DIN 8030	Aufsteckfräser DIN 8030 – Scheibenfräser
DIN 228A	DIN 228-1 – Morse-Schaft	JIS B 6339	Spindel MAS BT (JIS-B-6339)		
MODULAR	Schraubkupplung	ISO 6462 DIN 8030	Aufsteckfräser DIN 8030		

Technische Angaben

a_e / DC	Verhältnis (%) radiale Schnittbreite zu Schnittdurchmesser	a_p	Schnitttiefe (mm)	Zähnezahl	
a_e / DCX	Verhältnis (%) radiale Schnittbreite zu maximalem Schnittdurchmesser	DC	Fräserdurchmesser (mm)	APMX	Effektive Nutzlänge des Werkzeugs (mm)
X.V	Multiplikationsfaktor für Schnittgeschwindigkeit	DCX	Maximaler Fräserdurchmesser (mm)	Zähnezahl (Spiralfräser)	
x.f	Multiplikationsfaktor für den Vorschub (Bearbeitung in Mittellinie)	DEF	Effektiver Fräserdurchmesser (mm)	ODX	Effektive Werkzeugreichweite (mm)
x.f	Multiplikationsfaktor für den Vorschub (Bearbeitbarkeit nicht in Mittellinie)	e_{max}	Maximale Breite des bearbeiteten Bereichs (mm)	Effektive Zähnezahl	
Spanbrecher	Spanbrecher	max	Schnitttiefe für Tauchfräsen (mm)	Fasenwinkel (°)	
RE	Eckradius der Wendeschneidplatte (mm)	RPMX	Maximaler Winkel für Rampen (°)	Anzahl genutzter Kanten	
BS	Schleppschnneidenlänge (mm)	APMX/I	Max. Schnitttiefe über die Schnittlänge (mm)	Bohrungsdurchmesser (mm)	
f	Vorschub (mm/Zahn)	SMAX DMAX	Maximale Tiefe pro Umdrehung für maximalen Bohrungsdurchmesser (mm)	Rauheit der bearbeiteten Fläche R_a (mm)	
f	Anfangsvorschub (mm/Zahn)	SMAX DMIN	Maximale Tiefe pro Umdrehung für minimalen Bohrungsdurchmesser (mm)	Gewindesteigung	
f_{min}	Minimaler Vorschub (mm/Zahn)	FE	Konturfrässchritt bei Gegenlaufräsen (mm)	Gewindegänge je Zoll	
f_{max}	Maximaler Vorschub (mm/Zahn)	FE	Konturfrässchritt bei Gleich-/Gegenlauf-Querfräsen (mm)	Zeit (min)	

ISO BEZEICHNUNG – AUFSTECKFRÄSER

ISO	1	2	3	4	-	5	6	7	8	9	10	11	12
	63	A	06	R	-		S	90	A	D	16	E	
ANSI	1	2	3	4	-	5	6	7	8	9	10	11	12
	300	F	04	N	-	I	S	90	S	N	12	N	4

1	1	2			3	3	5	6	6	7	7	
Schneiddurchmesser		Fräserart und Art und/oder Größe der Werkzeugaufnahme			Wirksame Anzahl der Zähne		Standard	Befestigungssystem		Einstellwinkel (KAPR)		
							I	(")	C		90°	
		A ISO 6462/A DIN 8030/A			B ISO 6462/B DIN 8030/B		C ISO 6462/C DIN 8030/C		S		75°	
		F DC = 27 mm	DC = 1.000	 		4 4 Schnittrichtung		R	W	F	60°	
		G DC = 32 mm	DC = 1.250								L	45°
		H DC = 40 mm	-								N	MO
		J DC = 50 mm	-									
		K DC = 60 mm	-									
		M DC = 80 mm	-									
		T										

8				8			
Plattenform				Freiwinkel			
H	O	P	R	A	B	C	D
S	T	C	D	E	F	G	N
E	M	V	W	P	O		
L	A	B	K				

9		9	
Freiwinkel			
A	B	C	D
E	F	G	N
P	O		

10												10												
Schneidkantenlänge																								
IC		H	O	P	S	T	C	D	E	M	V	W	R	K										
(mm)	(")																							
3.97	5/32"				03	06		04				06	02											
4.76	3/16"				04	08	04	05	04	04	08	L3												
5.56	7/32"				05	09	05	06	05	05	09	03												
6.35	1/4"	03	02	04	08	11	06	07	08	08	11	04	06											
7.94	5/16"	04	03	05	07	13	08	09	06	07	13	05	07											
9.525	3/8"	05	04	07	09	16	09	11	09	09	16	06	09	19										
12.7	1/2"	07	05	09	12	22	12	15	13	12	22	08	12											
15.875	5/8"	09	06	11	15	27	16	19	16	15	27	10	15											
19.05	3/4"	11	07	13	19	33	19	23	19	19	33	13	19											
25.4	5/16"	14	10	18	25	44	25	31	26	25	44	17	25											
31.75	1 1/4"	18	13	23	31	54	32	38	32	31	54	21	31											

11		11	
Freiwinkel			
N ALP = 0°	C ALP = 7°	P ALP = 11°	
D ALP = 15°	E ALP = 20°	F ALP = 25°	

12		12	
Schneidenlänge (Breite)			
CW (mm) / (")			
CW	1/16"		
0.156	2.5		
0.187	3		
0.250	4		
0.313	5		
0.375	6		

ISO BEZEICHNUNG – SCHAFTFRÄSER

ISO	1	2	3	4	5	6	7	-	8	9	10	11	12	13
	32	A	4	R	042	B	32	-		S	A	D	11	E
ANSI	1	2	3	4	5	6	7	-	8	9	10	11	12	13
	125	A	4	R	150	W	125	-	I	S	A	D	11	E

1	1	2					5		6			7		
Schneid- durchmesser		Fräsertyp und Einstellwinkel					Auskräglänge		Schaftform			Schaftgröße		
		A	E	J	N	H	K	(mm)		A	C	DIN 1835A	6–40 mm	.250"–1.250"
								(")		B	W	ISO 3338-2, DIN 1835B	6–50 mm	.375"–2.000"
		3			4				E	-	ISO 296, DIN 228-1	1–6	-	
		Wirksame Anzahl der Zähne			Schnitt- richtung				G	-	ISO 297, DIN 208-1	40–50 mm	-	
					R	L	N		H	-	ISO/DIS 7388-1, DIN 69871-1	30–50 mm	-	
									N	-	ISO 12 164-1, DIN 69893	25–100 mm	-	
									-	R8	R8	-	1.250"	
									X	-	MAS BT	30–50	-	
									XC	-	CAPTO	3–10	-	
									-	CA	ANSI B5.50	-	40 / 50	

10				11		12													
Plattenform				Freiwinkel		Schneidkantenlänge													
H	O	P	R	A	B	IC	H	O	P	S	T	C	D	E	M	V	W	R	K
						(mm)													
				3°	5°	(")													
S	T	C	D	C	D	3.97				03	06		04				06	02	
						5/32"							1.2"						
				7°	15°	4.76				04	08	04	05	04	04	08	L3		
E	M	V	W	E	F	5.56				05	09	05	06	05	05	09	03		
						7/32"							1.8"						
				20°	25°	6.35	03	02	04	08	11	06	07	08	08	11	04	06	
L	A	B	K	G	N	7.94	04	03	05	07	13	08	09	06	07	13	05	07	
						5/16"							2.5"						
				30°	0°	9.525	05	04	07	09	16	09	11	09	09	16	06	09	19
P				P	O	3/8"							3"						
				11°	Spezial	12.7	07	05	09	12	22	12	15	13	12	22	08	12	
						15.875	09	06	11	15	27	16	19	16	15	27	10	15	
						19.05							4"						
						25.4	11	07	13	19	33	19	23	19	19	33	13	19	
						31.75	14	10	18	25	44	25	31	26	25	44	17	25	
						1 1/4"	18	13	23	31	54	32	38	32	31	54	21	31	
													5"						
													6"						
													8"						
													10"						

8		9		13	
Standard		Befestigungssystem		Freiwinkel	
I	(")	C		W	
		S		F	
N	ALP = 0°	C	ALP = 7°	P	ALP = 11°
D	ALP = 15°	E	ALP = 20°	F	ALP = 25°

ISO BEZEICHNUNGSSYSTEM – WENDESCHNEIDPLATTEN ZUM FRÄSEN

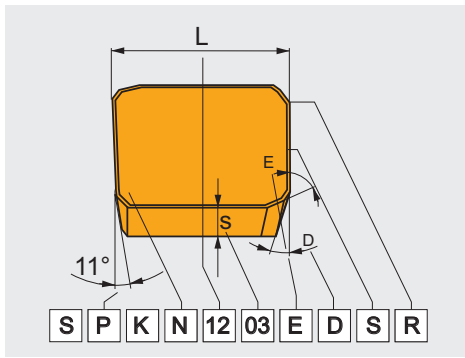

ISO	1	2	3	4
	S	P	G	N
	S	P	K	N
ANSI	1	2	3	4
	S	P	G	
	S	P	K	N

1				1			
Plattenform							
H	O	P	R				
S	T	C	D				
E	M	V	W				
L	A	B	K				

2		2	
Freiwinkel			
A		B	
C		D	
E		F	
G		N	
P		O	Spezial

4		4	
Spanflächen und Befestigung			
N			
R			
F			
A			
M			
G			
W	40–60°		
T			
Q			
U			
B	70–90°		
H			
C			
J			
X		Spezial	

3 3 Toleranzen

	(mm)			(")		
	M(±)	S(±)	IC(±)	M(±)	S(±)	IC(±)
A	0.005	0.025	0.025	0.0002"	0.001"	0.0010"
F	0.005	0.025	0.013	0.0002"	0.001"	0.0005"
C	0.013	0.025	0.025	0.0005"	0.001"	0.0010"
H	0.013	0.025	0.013	0.0005"	0.001"	0.0005"
E	0.025	0.025	0.025	0.0010"	0.001"	0.0010"
G	0.025	0.130	0.025	0.0010"	0.005"	0.0010"
J	0.005	0.025	0.05–0.13	0.0002"	0.001"	0.002"–0.005"
K	0.013	0.025	0.05–0.13	0.0005"	0.001"	0.002"–0.005"
L	0.025	0.025	0.05–0.13	0.0010"	0.001"	0.002"–0.005"
M	0.08–0.18	0.130	0.05–0.13	0.003"–0.007"	0.005"	0.002"–0.005"
N	0.08–0.18	0.025	0.05–0.13	0.003"–0.007"	0.001"	0.002"–0.005"
U	0.05–0.38	0.130	0.05–0.13	0.005"–0.015"	0.005"	0.003"–0.010"

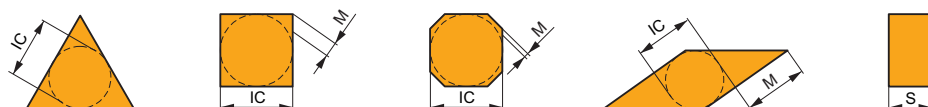

ISO BEZEICHNUNGSSYSTEM – WENDESCHNEIDPLATTEN ZUM FRÄSEN

5		6		7		8		9		10	
12	12	03	03	08	ED	S	R	-	-	-	-
5a		6a		7a		8		9			
4	4	2	2	2	ED	S	R	-	-	-	-

5													5												
Schneidkantenlänge																									
I.C.		H	O	P	S	T	C	D	E	M	V	W	R	K											
(mm)	(")																								
3.97	5/32"				03	06		04			06	02													
4.76	3/16"				04	08	04	05	04	04	08	L3													
5.56	7/32"				05	09	05	06	05	05	09	03													
6.35	1/4"	03	02	04	08	11	06	07	08	08	11	04	06												
7.94	5/16"	04	03	05	07	13	08	09	06	07	13	05	07												
9.525	3/8"	05	04	07	09	16	09	11	09	09	16	06	09	19											
12.7	1/2"	07	05	09	12	22	12	15	13	12	22	08	12												
15.875	5/8"	09	06	11	15	27	16	19	16	15	27	10	15												
19.05	3/4"	11	07	13	19	33	19	23	19	19	33	13	19												
25.4	5/16"	14	10	18	25	44	25	31	26	25	44	17	25												
31.75	1 1/4"	18	13	23	31	54	32	38	32	31	54	21	31												
								10"																	

6		7		
Dicke		Anstellwinkel	Freiwinkel	
Symbol	S		KAPR	ALP
	(mm)	(")		
01	1.59	1/16"	A 45°	A 3°
T1	1.98	5/64"	D 60°	B 5°
02	2.38	3/32"	E 75°	C 7°
03	3.18	1/8"	F 85°	D 15°
T3	3.97	5/32"	P 90°	E 20°
04	4.76	3/16"	Z Spezial	F 25°
05	5.56	7/32"		G 30°
06	6.35	1/4"		N 0°
07	7.94	5/16"		P 11°
09	9.52	3/8"		Z Spezial

ANSI								
5a		6a		7a				
Innenkreis		Dicke		Eckenradius				
Symbol	I.C.		Symbol	S		Symbol	RE	
	(mm)	(")		(mm)	(")		(mm)	(")
1	3.175	1/8"	1	1.588	1/16"	0	0	0"
1.2	3.969	5/32"	1.2	1.984	5/64"	0.2	0.099	1/256"
1.5	4.763	3/16"	1.5	2.381	3/32"	0.5	0.198	1/128"
1.8	5.556	7/32"	2	3.175	1/8"	1	0.397	1/64"
2	6.350	1/4"	2.5	3.969	5/32"	2	0.794	1/32"
2.5	7.938	5/16"	3	4.763	3/16"	3	1.191	3/64"
3	9.525	3/8"	3.5	5.556	7/32"	4	1.588	1/16"
4	12.700	1/2"	4	6.350	1/4"	5	1.984	5/64"
5	15.875	5/8"	5	7.938	5/16"	6	2.381	3/32"
6	19.050	3/4"	6	9.525	3/8"	7	2.778	7/64"
7	22.225	7/8"	7	11.113	7/16"	8	3.175	1/8"
8	25.400	1"	8	12.700	1/2"	10	3.969	5/32"
10	31.750	5/4"	9	14.288	9/16"	12	4.763	3/16"
12	38.100	6/4"	10	15.875	5/8"	14	5.556	7/32"
						16	6.350	1/4"

8		8	
Schneidkantenausführung			
	Scharfe Kante		Gerundete Kante
	Kante mit Schneidfase		Gerundete Kante mit Schneidfase
	Kante mit Doppelschneidfase		Gerundete Kante mit Doppelschneidfase

9		9	
Vorschubrichtung			
R		N	
L			

10		10	
Spanbrecherbezeichnung			

ZERSPANUNGSWERKZEUGPARAMETER GEMÄSS ISO 13399

Alle Zerspanungswerkzeuge sind durch eine Reihe von Parametern gemäß der Norm ISO 13399 definiert. Diese Liste enthält alle in diesem Katalog verwendeten Parameter sowie deren Definitionen.

ISO 13399 ist eine internationale Norm für Zerspanungswerkzeuge. Sie definiert Abmessungen und Parameter in einem neutralen Format unabhängig von einem bestimmten System oder einer Firmennomenklatur. Wenn Zerspanungswerkzeuge nach einer internationalen Norm klar definiert sind, können alle Arten von Software die elektronischen Daten schneller verarbeiten, was die Qualität der Kommunikation verbessert und zu einem reibungslosen Informationsaustausch beiträgt. Durch die Unterstützung einer gemeinsamen Sprache in den Beschreibungen unserer Zerspanungswerkzeuge wird die Kommunikation zwischen Systemen erleichtert. Dies spart viel Zeit und erleichtert die Erfassung von hochwertigen Daten über unsere 40.000 Mono- und Wendepplattenwerkzeuge. Durch den Einsatz eines ISO 13399-konformen Systems entfällt die Notwendigkeit, Daten manuell zu interpretieren und in das eigene System einzugeben.

NUR BEISPIELE!

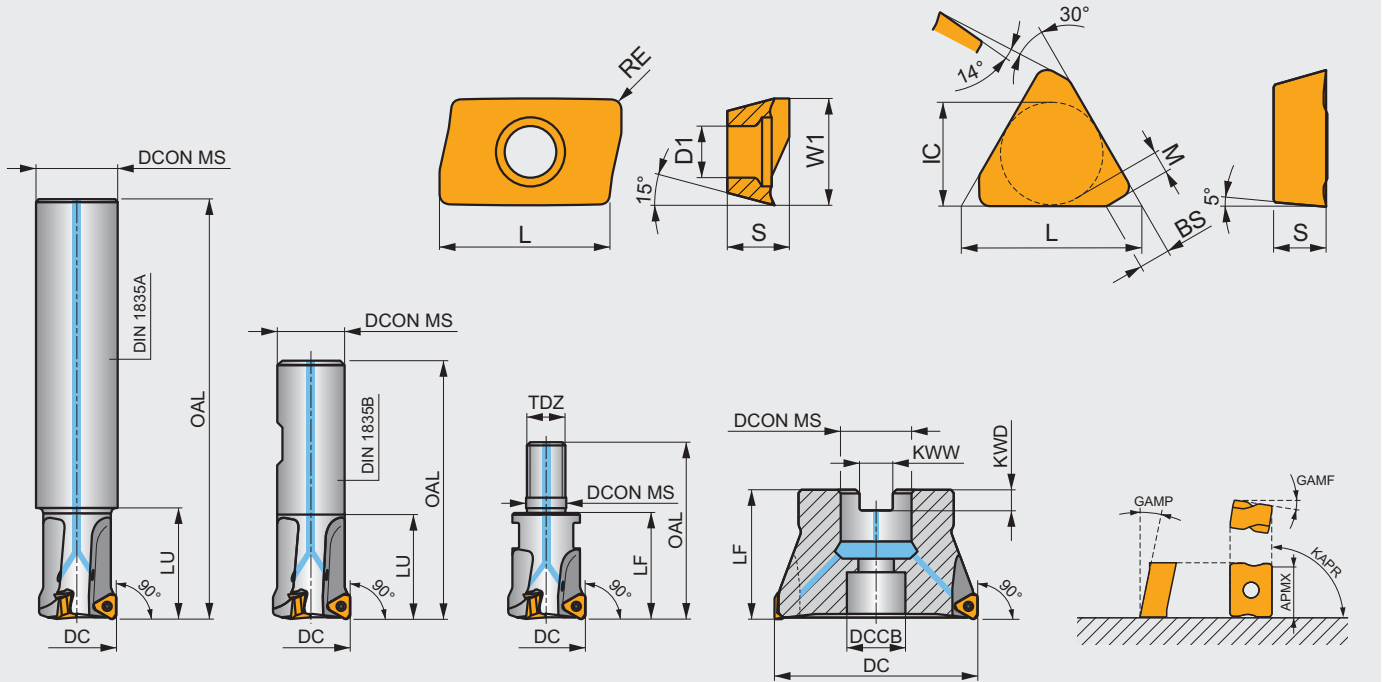

ISO 13399	Beschreibung
APMX	Max. Schnitttiefe
BD	Körperdurchmesser
BDX	Max. Körperdurchmesser
BCH	Eckenfasenlänge
BS	Schleppschneidenlänge
CBDP	Aufnahmebohrungstiefe
CDI	Schnittdurchmesser der Schneidplatte
CDX	Max. Schnitttiefe
CW	Stechbreite
CZC MS	Aufnahmegröße (Code) maschinenseitig
D1	Durchmesser Befestigungsbohrung
DAH4	Durchmesser Zugangsbohrung
DAH5	Durchmesser Zugangsbohrung
DAH6	Durchmesser Zugangsbohrung
DBC1	Lochkreisdurchmesser 1
DBC2	Lochkreisdurchmesser 2
DBC4	Lochkreisdurchmesser
DBC5	Lochkreisdurchmesser
DBC6	Lochkreisdurchmesser

ISO 13399	Beschreibung
DC	Schnittdurchmesser
DCB	Durchmesser Anschlussbohrung
DCCB	Stirnsenker Durchmesser Anschlussbohrung
DCN	Min. Schnittdurchmesser
DCON MS	Aufnahmedurchmesser
DCX	Max. Schnittdurchmesser
DHUB	Nabendurchmesser
DN	Halsdurchmesser
GAMF	Radialer Spanwinkel
GAMP	Axialer Spanwinkel
CHW	Eckenfasenbreite
IC	Einbeschriebener Kreis
INSD	Schneidplattendurchmesser
INSL	Schneidplattenlänge
KAPR	Winkel Werkzeugschneidkante
KWD	Keilnuttiefe
KWW	Keilnutbreite
L	Schneidkantenlänge
LB	Grundkörperlänge
LE	Effektive Schneidkantenlänge

ISO 13399	Beschreibung
LF	Funktionslänge
LH	Kopflänge
LU	Nutzlänge
LUX	Max. Nutzlänge
M	Größe M
NOF	Anzahl der Nuten
OAL	Gesamtlänge
P	Teilung
PRFA	Profilwinkel
PRFRAD(2)	Profilradius
RE	Radius
S	Schneidplattendicke
S1	Schneidplattendicke, gesamt
TDZ	Gewindenummer
TP	Gewindesteigung
TPI	Gewindgänge je Zoll
W1	Schneidplattenbreite
ZNP	Anzahl peripherer Kanten im Werkzeug

FRÄSORTEN – ÜBERBLICK

Gruppe	Hartmetall mit MTCVD	Hartmetall mit PVD	Unbeschichtet
P01			
P05		M8310	
P10	M9315	8215	
P15	M9325		
P20		M8330	
P25		M8340	
P30		M8345	
P35			
P40			
P45			
P50			

Gruppe	Hartmetall mit MTCVD	Hartmetall mit PVD	Unbeschichtet
M01			
M05			
M10			
M15			
M20		M6330	
M25		M8340	
M30	M9340	M8345	
M35			
M40			
M45			
M50			

Gruppe	Hartmetall mit MTCVD	Hartmetall mit PVD	Unbeschichtet
K01		M4303	
K05		M8310	
K10		M4310	
K15	M5315	8215	
K20		M8330	
K25			
K30			
K35			
K40			
K45			
K50			

Gruppe	Hartmetall mit MTCVD	Hartmetall mit PVD	Unbeschichtet
N01			
N05			
N10		M0315	
N15		8215	
N20			HF7
N25			
N30			
N35			
N40			
N45			
N50			

Gruppe	Hartmetall mit MTCVD	Hartmetall mit PVD	Unbeschichtet
S01			
S05			
S10			
S15	M9340		
S20		M6330	
S25		M8340	
S30		M8345	
S35			
S40			
S45			
S50			

Gruppe	Hartmetall mit MTCVD	Hartmetall mit PVD	Unbeschichtet
H01		M4303	
H05		2003	
H10	M5315	M4310	
H15		M8310	
H20		8215	
H25			
H30			
H35			
H40			
H45			
H50			

FRÄSORTEN – ÜBERBLICK

Identifizierung HM-Sorte	Anwendungsbereich	Anwendung	Vorschub	Schnittgeschwindigkeit	Beständigkeit gegenüber ungünstigen Arbeitsbedingungen	Beschichtung	Beschreibung des Schneidmaterialen		
							Farbe	Substrat	Nutzen von Kühlmittel
M8345	P30 – P50	■	▴	▴	▴+	PVD	H	-	Dieses Material hat eine außergewöhnliche Betriebssicherheit und ist für den Einsatz in schwierigen und zähen Materialien unter rauen Bedingungen konzipiert.
	M30 – M40	■	▴	▴	▴+				
M6330	P20 – P35	■	▴	▴	▴	PVD	H	+/-	Fräsmaterial mit außergewöhnlicher Betriebssicherheit. Besonders geeignet für die Bearbeitung schwer zerspanbarer Materialien. Leistungsstark in Anwendungen, in denen raue Bedingungen und schwierige Schnitte vorherrschen.
	M20 – M35	■	▴	▴	▴				
	S20 – S30	■	▴	▴	▴				
M4303	P01 – P10	▣	▴	▴	▴	PVD	ultra submicron H	-	Der Werkstoff mit der höchsten Verschleißfestigkeit bei der Bearbeitung von Formen und Gesenken. Bietet außergewöhnliche Leistung bei hohen Schnittgeschwindigkeiten und niedrigen Vorschüben unter stabilen Schnittbedingungen. Geeignet für Schlichtbearbeitungen in schwierigen Werkstückmaterialien.
	K01 – K10	■	▴	▴	▴				
	N01 – N10	▣	▴	▴	▴				
	H01 – H10	■	▴	▴	▴				
M4310	P05 – P15	▣	▴	▴	▴	PVD	ultra submicron H	-	Ein vielseitiger Werkstoff für den Einsatz in der Formen – und Gesenkbearbeitung. Geeignet für Schlicht – und Halbschrupparbeiten. Diese Sorte kombiniert hohe Verschleißfestigkeit mit außergewöhnlicher Betriebssicherheit.
	M05 – M15	▣	▴	▴	▴				
	K05 – K15	■	▴	▴	▴				
	S05 – S10	■	▴	▴	▴				
	H05 – H15	■	▴	▴	▴				
2003	P01 – P10	▣	▴	▴	▴	PVD	ultra submicron H	-	Fräsmaterial mit hervorragender Verschleißfestigkeit. Bestens geeignet für die Bearbeitung von harten und hochfesten Werkstoffen unter stabilen Schnittbedingungen und mittleren/ hohen Schnittgeschwindigkeiten. Geeignet zum Schneiden anderer Werkstoffe der Werkstückgruppe außer Nichteisenmetallen.
	M01 – M10	▣	▴	▴	▴				
	K01 – K10	■	▴	▴	▴				
	S05 – S10	■	▴	▴	▴				
M0315	N05 – N25	■	▴	▴	▴	PVD	submicron H	-	Submikron-Werkstoff zum Fräsen von Nichteisenmetallen und deren Legierungen mit einem ausgewogenen Verhältnis von Verschleißfestigkeit und Zähigkeit. Es hat eine einzigartige Beschichtung mit hervorragenden Reibungseigenschaften.
M8326	P20 – P40	■	▴	▴	▴	PVD	H	-	Spezialmaterial für schwere Anwendungen. Das Haupteinsatzgebiet dieses Materials ist die Bearbeitung aller Stahlsorten (auch Edelstahl) im "weichen Zustand". Es kann auch für die Bearbeitung von weicherem Gusseisen verwendet werden. Geeignet für die Bearbeitung von M15 – M30 bei mittleren Drehzahlen unter durchschnittlichen Schnittbedingungen.
	M15 – M30	▣	▴	▴	▴				
M8346	P30 – P50	■	▴	▴	▴+	PVD	H	-	Sonderwerkstoff für die Schwerzerspanung. Dieses Material hat eine außergewöhnliche Betriebssicherheit und ist für schweres Schneiden in schwierigen und zähen Materialien unter widrigen Bedingungen ausgelegt.
	M30 – M40	■	▴	▴	▴+				
S26	P15 – P30	■	▴	▴	▴	-	S	++	Unbeschichtetes Fräsmaterial mit hervorragender Beständigkeit gegen Schneidflächenerosion. Ausschließlich für die Bearbeitung von unlegierten und legierten Stählen bei niedrigen Schnittgeschwindigkeiten konzipiert.
S45	P30 – P45	■	▴	▴	▴+	-	S	++	Unbeschichtetes, zähes Material, geeignet für Bearbeitungen, bei denen niedrige Schnittgeschwindigkeiten und ungünstige Schnittbedingungen vorherrschen.
HF7	M10 – M20	▣	▴	▴	▴	-	submicron H	++	Ein unbeschichtetes Material, das hauptsächlich für die Bearbeitung von Nichteisenmetallen vorgesehen ist. Es kann auch für die Bearbeitung anderer Materialien (außer Stahl) verwendet werden. Dieses Material kann beim Drehen, Fräsen und sogar beim Bohren verwendet werden.
	K10 – K25	■	▴	▴	▴				
	N10 – N25	■	▴	▴	▴				

FRÄSORTEN – ÜBERBLICK

Identifizierung HM-Sorte	Anwendungsbereich	Anwendung	Vorschub	Schnittgeschwindigkeit	Beständigkeit gegenüber ungünstigen Arbeitsbedingungen	Beschichtung	Farbe	Substrat	Nutzen von Kühlmittel	Beschreibung des Schneidmaterialien
M9315	P05 – P25	■				MT-CVD	■	H	---	Ein Fräsmaterial mit hoher Abriebfestigkeit auch bei hoher Wärmebelastung, Haupteinsatzgebiet sind höhere Schnittgeschwindigkeiten bei mittlerer oder kleiner Schnitttiefe.
	K10 – K30	■	▄	▄	▄					
	H10 – H20	▣								
M9325	P10 – P30	■				MT-CVD	■	H	---	Dieses Fräsmaterial hat ein ideales Gleichgewicht zwischen Verschleißfestigkeit und Zähigkeit, es ist hauptsächlich für Schruppbearbeitungen ausgelegt. Der Vorteil ist eine ausgezeichnete Verschleißfestigkeit auch bei relativ hohen Schnittgeschwindigkeiten mit hervorragender Zuverlässigkeit. Dieser Werkstoff ist eher für Anwendungen mit höheren Geschwindigkeiten und niedrigeren Vorschüben geeignet.
	K10 – K30	■	▄	▄	▄					
	H15 – H20	▣								
M9340	P35 – P50	■				MT-CVD	■	H	---	Sehr zäh, dessen Hauptvorteil eine hohe Schneidkantenfestigkeit und Beständigkeit gegen widrige Schnittbedingungen ist. Obwohl dieses Material eine MT-CVD M30 – M40-Beschichtung hat, ist es möglich, die Emulsionskühlung für die Anwendung zu nutzen, besonders unter optimalen Schnittbedingungen.
	M30 – M40	■	▄	▄	▄					
	S15 – S20	■								
M5315	P05 – P20	▣				MT-CVD	■	H	---	Eines der abriebfestesten Fräsmaterialien, das unter stabilen Bedingungen eingesetzt werden sollte. Sein Hauptvorteil ist die extrem hohe Beständigkeit gegen thermische Beanspruchung und abrasiven Verschleiß K05 – K25. Er wird hauptsächlich für die Bearbeitung harter und sehr harter Werkstoffe, insbesondere Gusseisen, eingesetzt.
	K05 – K25	■	▄	▄	▄					
	H05 – H20	■								
M8310	P01 – P10	■				PVD	■	ultra submicron H	-	Speziell für das Kopierfräsen entwickeltes Material, das sich durch hohe Abriebfestigkeit auszeichnet. Sie eignet sich für die Bearbeitung bei höheren Schnittgeschwindigkeiten unter stabilen Schnittbedingungen und für die Bearbeitung nahezu aller Werkstoffgruppen (insbesondere härterer und härterer Werkstoffe).
	M01 – M10	▣	▄	▄	▄					
	K01 – K10	■	▄	▄	▄					
	H05 – H15	▣								
8215	P10 – P20	■				PVD	■	submicron H	+/-	Einer der vielseitigsten Werkstoffe zum Fräsen, sowohl in Bezug auf das Werkstückspektrum als auch auf die Anwendungsmöglichkeiten. Er zeichnet sich durch hohe Verschleißfestigkeit und Betriebssicherheit aus. Zu seinen weiteren Vorteilen gehört die hervorragende Beständigkeit gegen Temperaturschockrisse. Dank seiner einzigartigen Eigenschaften ist dieses Material zweifelsohne eine der Säulen des Fräseprogramms.
	M10 – M20	▣	▄	▄	▄					
	K10 – K25	■	▄	▄	▄					
	N10 – N25	■								
	S10 – S15	▣								
M8325	P20 – P40	■				PVD	■	S	-	Das Haupteinsatzgebiet dieser Matrix ist die Bearbeitung von allen Stahlsorten (auch Edelstahl) im "weichen Zustand". Es kann auch für die Bearbeitung von weicherem Gusseisen verwendet werden. Geeignet für die Bearbeitung von M15 – M30 bei mittleren Drehzahlen unter durchschnittlichen Schnittbedingungen.
	M15 – M30	▣	▄	▄	▄					
M8330	P20 – P40	■				PVD	■	submicron H	+/-	Dieses Material ist vielseitig und kann für die Bearbeitung einer Vielzahl von Materialien verwendet werden. Sein vorrangiges Einsatzgebiet liegt jedoch bei Stählen und duktilem Gusseisen. Sie wird für das Fräsen bei mittleren Drehzahlen unter instabilen Schnittbedingungen empfohlen.
	M20 – M35	■	▄	▄	▄					
	K20 – K40	■	▄	▄	▄					
	N15 – N30	▣								
	S15 – S25	▣								
M8340	P25 – P50	■				PVD	■	submicron H	+/-	Eine der zähesten Sorten für die Bearbeitung mit niedrigeren Schnittgeschwindigkeiten und ungünstigen Schnittbedingungen. Diese Sorte ist ideal für alle Bearbeitungen, bei denen die Hauptanforderung an eine zähe Schneidkante gestellt wird.
	M20 – M40	■	▄	▄	▄					
	K20 – K40	▣	▄	▄	▄					
	S20 – S30	■								

FRÄSORTEN – ÜBERBLICK

Kennzeichnung der Sorten

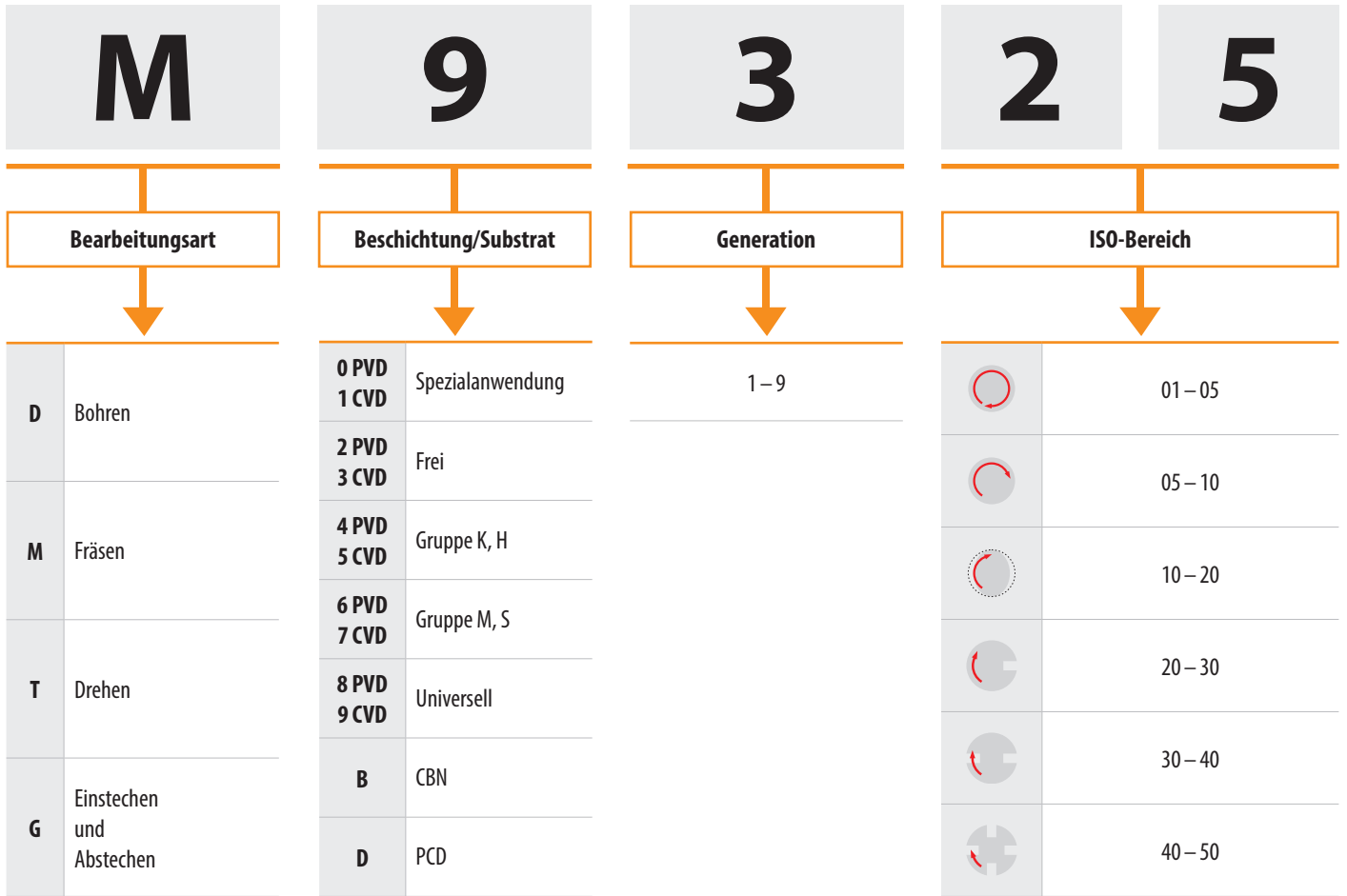

Substrat

H	Substrat auf WC-Co-Basis
submicron H	WC-Co basiertes Substrat feinkörnig (< 1 µm)
ultra submicron H	WC-Co basiertes Substrat sehr feinkörnig (<0.5 µm)
S	Substrat mit kubischen Carbiden

Beschichtung

MT-CVD	Mitteltemperatur-chemische Gasabscheidung (Chemical Vapour Deposition)
PVD	Niedertemperatur-physikalische Gasabscheidung (Physical Vapour Deposition)
-	Unbeschichtetes Hartmetall

Wirkung der Kühlung

---	Sehr negative Auswirkung auf die Werkzeugstandzeit – Kühlung wird nicht empfohlen
-	Geringfügig negative Auswirkung auf die Werkzeugstandzeit
+ / -	Die Wirkung der Kühlung kann sowohl positiv als auch negativ sein – die spezifischen Arbeitsbedingungen sind der entscheidende Faktor
++	Positiver Einfluss auf die Standzeit – Kühlung wird empfohlen

Grad des Einflusses



DEFINITION DER GRUNDBEGRIFFE

Teile einer Wendeschneidplatte

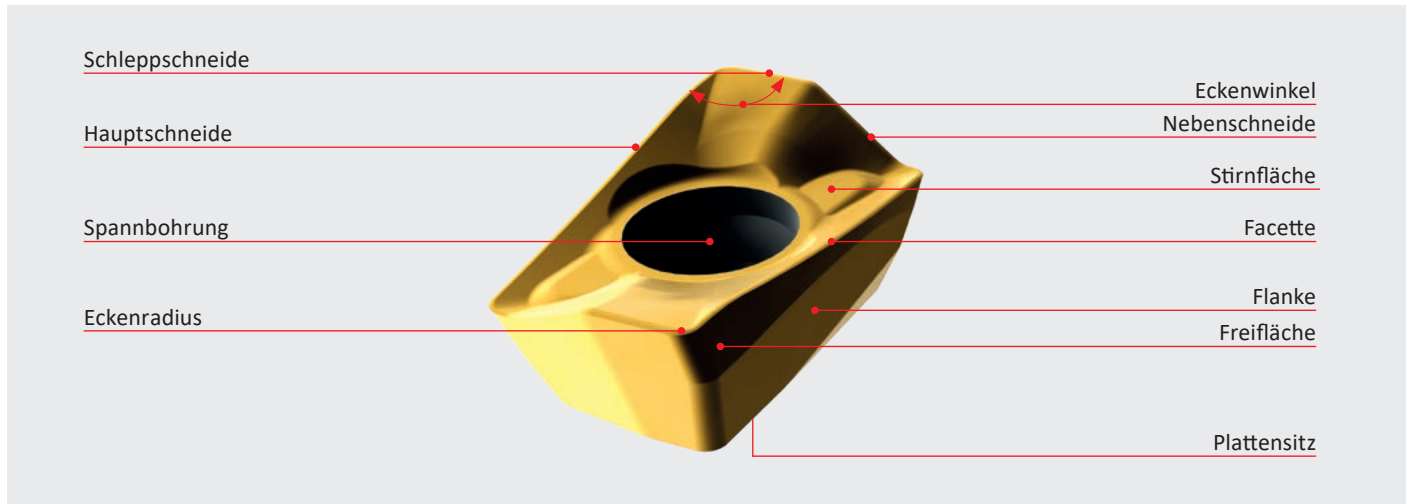

Geometrie des Fräswerkzeugs

Konstruktionswinkel bestimmen die grundsätzliche Ausrichtung der Sitzposition, in der die Wendeschneidplatte eingespannt wird, und sind daher wichtig für den Aufbau des Fräserkörpers. Es gibt zwei Winkel: axialer Spanwinkel $GAMP - \gamma_p$ (rückwärtiger Spanwinkel) und radialer Spanwinkel $GAMF - \gamma_f$ (seitlicher Spanwinkel) – siehe Abbildung unten.

Wirkwinkel sind der Einstellwinkel der Hauptschneide $KAPR - \kappa_r$, der orthogonale Spanwinkel $GAMO - \gamma_o$ und der Spanwinkel der Schneidkante $LAMS - \lambda_s$.

- Der **orthogonale Spanwinkel** $GAMO - \gamma_o$ beeinflusst nicht nur das Ausmaß der plastischen Verformung des geschnittenen Spans, sondern auch die Schnittkraft und die Temperatur. Je größer der Spanwinkel $GAMO - \gamma_o$ ist, desto geringer ist die Schnittkraft und der Leistungsbedarf des Spindelmotors (und umgekehrt).

- Der **Einstellwinkel** $KAPR - \kappa_r$ bestimmt die Dicke des Spans bei einem bestimmten Zahnvorschub f_z und einer bestimmten Axialtiefe des Schnitts a_p . Er beeinflusst daher die Schnittkräfte, insbesondere die Beanspruchung, den Verschleiß und die Werkzeugstandzeit. Die Verringerung des Einstellwinkels $KAPR - \kappa_r$ bei konstantem Vorschub f_z bewirkt eine Abnahme der Spandicke h .
- Der **Spanwinkel der Schneidkante** $LAMS - \lambda_s$ bestimmt zusammen mit dem Einstellwinkel $KAPR - \kappa_r$ und dem Spanwinkel $GAMO - \gamma_o$ den ersten Kontaktpunkt zwischen Kante und Werkstück. Deshalb beeinflusst er die Beständigkeit der Kante gegen Ausbruch bei unterbrochenem Schnitt. Gleichzeitig beeinflusst er die Richtung des Spantransports.

Mithilfe der Wirkwinkel des Werkzeugs kann der Plattensitz anhand der folgenden Formeln oder Diagramme bestimmt werden.

Wirk- und Konstruktionswinkel des Fräswerkzeugs

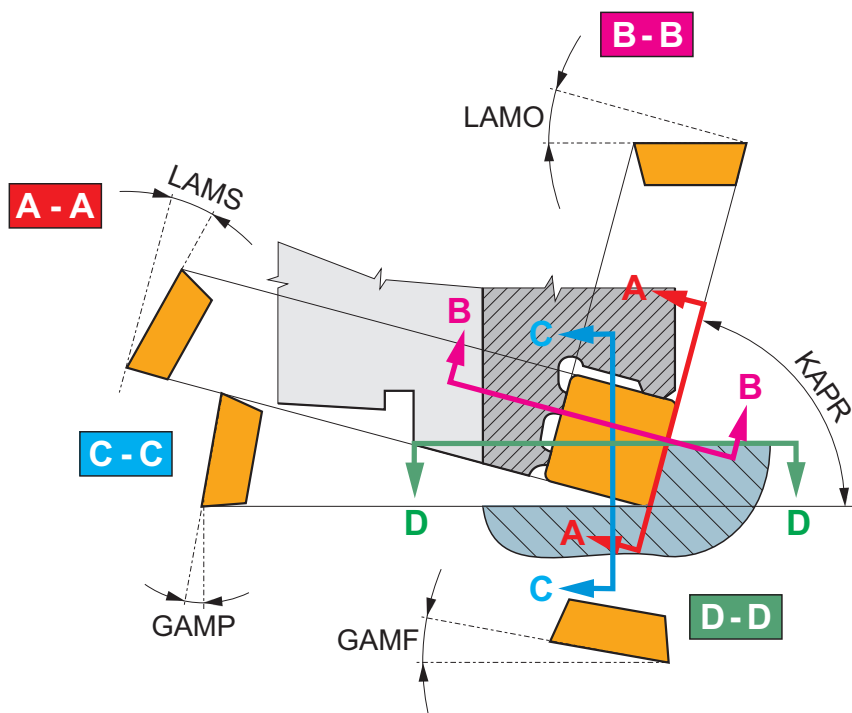

WERKZEUGAUSWAHL

Fräser-Geometrie

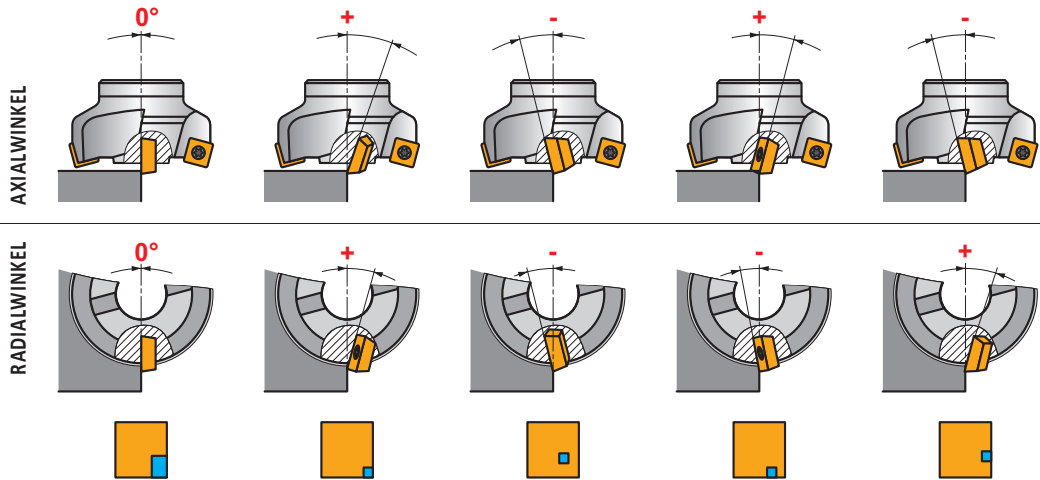

Bei der Auswahl eines Werkzeugs müssen viele Kriterien berücksichtigt werden. Eine der Hauptanforderungen ist, dass der Punkt des ersten Kontakts zwischen Schneidkeil und Werkstück weiter von der Spitze und der Schneidkante entfernt liegt. Dies ist jedoch abhängig von der Grundgeometrie des Schneidkeils, d. h. von den Winkeln $GAMO - \gamma_r$, $LAMS - \lambda_s$ und $KAPR - \kappa_r$, sowie von der Lage des Fräasers und der Eintrittskante des Werkstücks zueinander. Die folgende Abbildung zeigt einzelne Fräsergeometrien (bzw. die Kombinationen von Radial- und Axialwinkeln) bei einigen der ungünstigsten Eingriffsbedingungen (d. h. wenn die Achse des Fräasers mit der Kante des Werkstücks in einer Linie liegt). Unter der Abbildung ist aufgeführt, in welchem Bereich die Wendschneidplatte den ersten Kontakt mit dem Werkstück hat. Die Abbildung zeigt, dass bei solchen ungünstigen Eingriffsbedingungen Werkzeuge mit negativ-negativer Geometrie

am besten abschneiden, während Werkzeuge mit positiv-positiver Geometrie am problematischsten sind. Ein weiteres Kriterium ist die Spanabnahme. Negativ-negative Werkzeuge drücken den Span gegen die Arbeitsfläche (zum Werkstück hin), während positiv-positive Werkzeuge den Span von der Arbeitsfläche, d. h. vom Werkstück weg leiten. Ein optimaler Kompromiss ist also, negative und positive Winkel zu kombinieren.

Eintrittswinkel

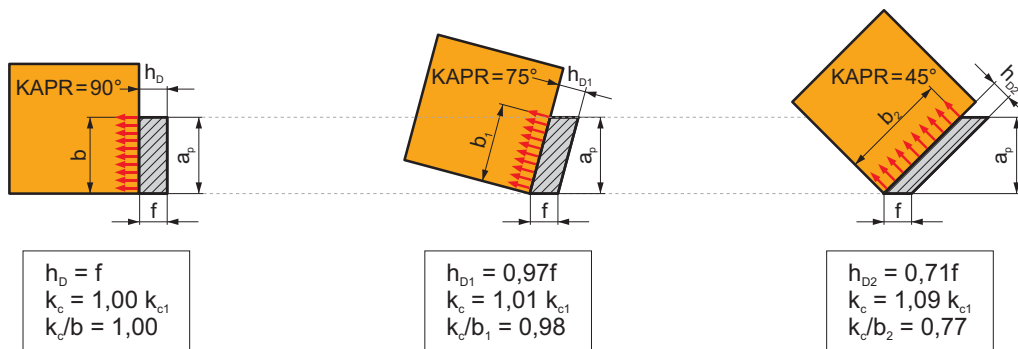

Bei der Wahl des Eintrittswinkels für das Planfräsen sollten u. a. die Leistung und Stabilität der Maschine (Größe und Art des Werkzeughalters), ihre dynamischen Fähigkeiten und die maximale Abtragtiefe berücksichtigt werden. Wenn beispielsweise eine Hochleistungsmaschine (50 – 100 kW) mit einem ISO 50-Werkzeughalter zur Verfügung steht und mit großer Tiefe gefräst wird, sollte ein Fräser mit einem Eintrittswinkel zwischen 90° und 58° die erste Wahl sein. Wenn dagegen eine Maschine mit geringer Leistung (bis 10 kW) mit einem ISO 40-Werkzeughalter (HSK 63) zur Verfügung steht und eine Schnitttiefe von 2 bis 3 mm erwartet wird, sollte ein Werkzeug mit einem Eintrittswinkel von 45° bis 10° (d. h. HFC) oder mit runden Wendschneidplatten gewählt werden. Ein idealer Kompromiss wäre also, ein Werkzeug mit einem Eintrittswinkel von 45° zu wählen, das auch höhere Schnitttiefen bewältigen kann und im

Vergleich zu einem Werkzeug mit einem Eintrittswinkel von 90° in der gleichen Tiefe mit bis zu 30% höherem Vorschub und bei annähernd gleicher Belastung schneiden kann. Dabei muss berücksichtigt werden, dass der Span umso dünner und der Eingriffsbereich des Schneidkeils umso länger wird, je kleiner der Eintrittswinkel ist, was im Hinblick auf die Wärmeableitung und die Kraftverteilung über die Kante der Wendschneidplatte von Belang ist. Außerdem ist die Richtungsänderung der resultierenden Schnittkräfte zu berücksichtigen, die man sich vereinfacht als senkrecht zur Kante vorstellen kann. (Eine Verringerung des Eintrittswinkels erhöht die passive Komponente der in die Spindel führenden Schnittkraft und verringert die aktive radiale Komponente der Schnittkraft).

WERKZEUGAUSWAHL

Die folgende Abbildung zeigt das Sortiment der Pramet-Fräser in Bezug auf Eintrittswinkel und Grundgeometrie des Fräskörpers (d. h. des axialen und radialen Spanwinkels). Es muss jedoch berücksichtigt werden, dass die Geometrie der Wendschneidplatte wie in der folgenden Abbildung dargestellt die resultierende Geometrie des Werkzeugs verändern kann.

	Negativ – Negativ	Negativ – Positiv	Positiv – Positiv
93°	SWN04C SCN05C		
90°	STN10 STN16 SLN12 SLN16 SLN12X J(T)-SLSN	SAD07D SAD11E SAD16E SAP10D SAP16D SS009 SSD12 FTB27X F-SCC S90SN S90CN(XN) J(T)-SAD11E J(T)-SAD16E J(T)-SSAP J(T)-CSD12X	SAP10D SVC22C
57° – 60°	SPN13	FSB22X	
45°	SHN06C SHN09C SSD09 N-SS009 2516	SSF13F SOD05 SOD06D SSE09 SSN12Z	
43°	SON06C		SOE06Z
12° – 20°	SBN10 SSN11	SPD09 SS012	
I	SRC10 SRC12 SRC16 SRC20 SRD10 SRD12 L2-SZP K3-CXP K2-PPH K2-SLC K2-SRC	SRD05 SRD07 SRD10 SRD12 SRD16 SZD07 SZD09 SZD12 2636 J(T)-SXP16	

WERKZEUGAUSWAHL

Resultierende Geometrie (Fräser + Wendeschneidplatte)

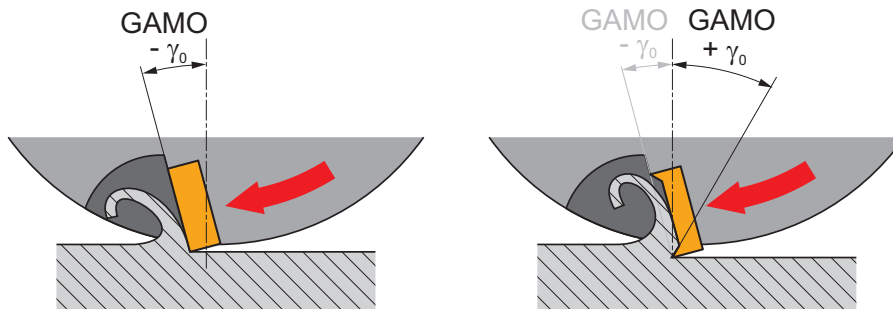





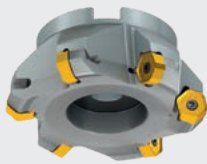

In der folgenden Tabelle sind die drei grundlegenden Fräsergeometrien und die ungefähre Priorität ihrer Verwendung in Bezug auf die Art des zu bearbeitenden Materials aufgeführt. Ausführlichere Informationen zu den einzelnen Werkzeugfamilien mit Berücksichtigung der Wendeschneidplattengeometrien sind im Katalogteil zu finden.

Bedingungen		Auswahl der Fräsergeometrie je nach Anwendung		
		Negativ – Negativ	Negativ – Positiv	Positiv – Positiv
Strukturelle Parameter des Körpers	GAMP (A.R.)	-	+	+
	GAMF (R.R.)	-	-	+
	GAMO	-	+	+
Zu bearbeitendes Material	Kohlenstoffstahl, legierter Stahl (< 300 HB)	■	■	■
	Edelstahl (< 300 HB)		■	■
	Edelstahl (> 300 HB)		■	■
	Gusseisen, sphärolithisches Gusseisen	■	■	■
	Al-Legierungen		■	■
	Kupfer und Kupferlegierungen		■	■
	Titan und Kupferlegierungen		■	■
Gehärteter Stahl (40 – 55 HRC)	■	■		

Zähneanzahl des Fräasers

Die Zähneanzahl des Fräasers ist auch im Verhältnis zur Breite der gefrästen Fläche wichtig, da sie die Kraft – (und Schall-)Eigenschaften des Schnitts bestimmt (siehe folgende Abbildung).

			
Vorschub pro Minute	+	++	+++
Zähe Werkstoffe	+++	++	+
Leistungsanforderung	+	++	+++
Resultierende Rauheit	+++	++	+
			

WERKZEUGAUSWAHL

Verzahnung

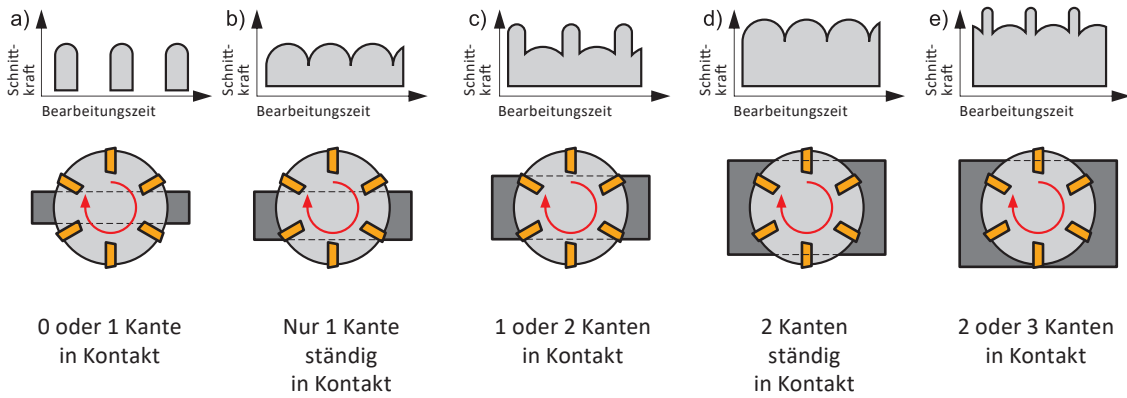

Darüber hinaus bieten einige Werkzeugfamilien die Möglichkeit, zwischen gleicher und ungleicher Teilung zu wählen. Die Verwendung eines Werkzeugs mit ungleicher Teilung verhindert harmonische Schwingungen und trägt damit zur Verbesserung der Stabilität und zur Verringerung der Vibrationsgefahr bei. Das bedeutet, dass die

ungleiche Teilung gewählt werden sollte, wenn ein Vibrationsrisiko zu erwarten ist, d. h. vor allem beim Arbeiten mit größerem Überhang oder bei der Bearbeitung mit hoher radialer Schnitttiefe und unter nicht ganz stabilen Bedingungen.



WAHL DER WENDESCHNEIDPLATTE

Bei der Wahl einer Wendeschneidplatte muss auch deren Mikrogeometrie beachtet werden, die durch Symbole direkt im Katalogteil angezeigt wird. Nachfolgend sind die Arten von Schneidkanten unserer Wendeschneidplatten aufgelistet.

Überblick über Schneidkanten-Ausführungen

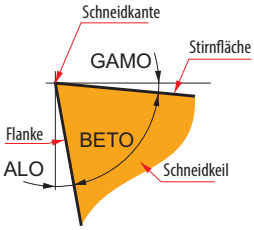
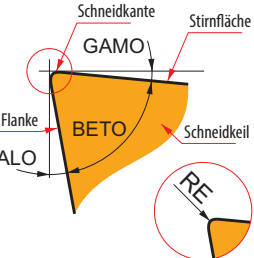
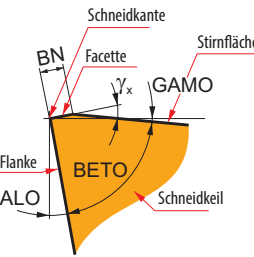
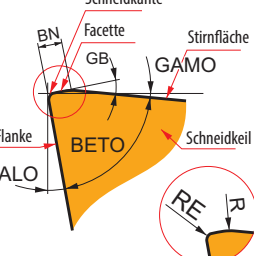
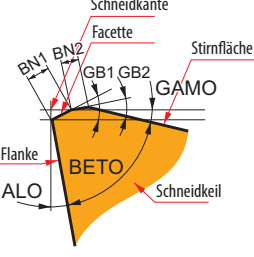
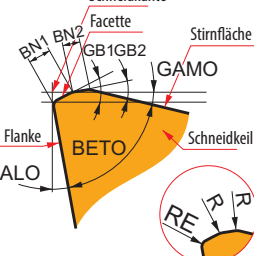
F		<p>Scharfe Schneidkanten – empfohlen für Wendeschneidplatten, die für den Einsatz bei Fräsen für Al-Legierungen vorgesehen sind. Scharfe Schneidkeile führen zu einer minimalen Verformung der Schnittschicht, zu einer geringeren Aufbauschneidenbildung an der Kante und zu einem geringeren Schnittkraftbedarf. Allerdings ist die Festigkeit des Schneidkeils im Vergleich zu anderen Typen geringer.</p>
E		<p>Abgerundete Schneidkanten – eine leichte Abrundung des Keils, wodurch Mikrofehlstellen seiner Oberfläche beseitigt werden sollen. Die Verrundung des Keils mit einem bestimmten sehr kleinen Radius (RE) verbessert die Widerstandsfähigkeit der Schneidkante gegen mechanische Beschädigung, d. h. spröden Bruch oder sog. Mikroausbrüche. Diese Modifikation wird derzeit bei allen Wendeschneidplatten ohne Facette (früher F-Modifikation) verwendet, die zum Fräsen fast aller Materialarten eingesetzt werden.</p>
T		<p>Facettierte Schneidkanten – eine Facette mit der Breite x und dem Winkel γ_x vergrößert den Winkel γ_n des Schneidkeils direkt an der Schneidkante und erhöht damit auch deren Festigkeit, d. h. ihre Widerstandsfähigkeit gegen mechanische Belastung, spröden Bruch oder Rissbildung. Wird derzeit nur noch selten verwendet; wurde durch die S-Modifikation ersetzt.</p>
S		<p>Abgerundete Kanten mit Facette – im Vergleich zur T-Modifikation wurde die Wendeschneidplatte einer Verrundung unterzogen, die zu einer Abrundung der Schneidkante und einer Verdickung durch eine Facette führt. Diese Modifikation erhöht die Widerstandsfähigkeit des Keils gegen mechanische Beschädigungen.</p>
K		<p>Kanten mit Doppelfacette – Doppelfacette mit den Breiten x_1, x_2 und dem Winkel γ_{x1}, γ_{x2} erhöht weiter die Festigkeit der Kante, d. h. ihre Beständigkeit gegen mechanische Beanspruchung, spröden Bruch oder Rissbildung. Selten für Fräseinsätze verwendet, nur für schwierigste Schnitte.</p>
P		<p>Abgerundete Kanten mit Doppelfacette – im Vergleich zur K-Modifikation wurde die Wendeschneidplatte einer Verrundung unterzogen, die zu einer Abrundung der Schneidkante und einer Verdickung durch eine Doppelfacette führt. Diese Modifikation verleiht dem Keil höchste Beständigkeit gegen mechanische Beschädigungen.</p>

KORREKTURFAKTOREN

Korrekturfaktoren für bestimmte Fräserarten und Bearbeitungsarten C_{VcO}

Planfräser mit $KAPR$ von 45° bis 60° und negativen Wendeschneidplatten (SON06C, SHN06C, SHN09C)	1.15	1.00	0.85
Planfräser mit $KAPR$ von 45° und positiven Wendeschneidplatten (SSD13F, SSE09, SSN12Z, FSB22X, SOD05, SOD06D, SOE06Z)	1.15	1.00	0.85
Eckfräser mit $KAPR$ von 90° (SAD07/10/16, STN10/16, SLN12/16, SAP10/16, SS009, SSD12)	1.10	1.00	0.90
Kopierplanfräser (SRC10 – SRC20, SRD05 – SRD16, ...)	1.10	1.00	0.90
Kopierschaftfräser (K2-PPH, K2-SLC, K2-SRC, K3-CXP...)	1.10	1.00	0.90
Scheibenfräser (S90CN(XN), S90SN...)	1.10	1.00	0.90
Eckfräser mit verlängerter Spannart J(T)-CSD12X, J(T)-SAD11E, J(T)-SAD16E...)	1.25	1.00	0.80
Planfräser für schweres Fräsen (FSB22X, SPN13..)	1.30	1.00	0.85
Eckfräser für schweres Fräsen (FTB27X..)	1.25	1.00	0.85

Korrekturfaktoren für die erforderliche Standzeit C_{VcT}

	Minuten	15	20	30	45	60	90	120
Allgemeine Bearbeitung (Feinschichten bis Schruppen)		1.23	1.13	1.00	0.89	0.81	0.72	–
Hochleistungsbearbeitung (schweres Schruppen)		–	–	1.23	1.13	1.00	0.89	0.81

Weitere Korrekturfaktoren C_{VcA}

Bearbeitungsumgebung	C_{VcA}
Zustand des Werkstückmaterials (harte Randschicht durch Schmieden oder Gießen)	0.70
Instabile Bearbeitungsbedingungen	0.85
Gängige Bearbeitungsbedingungen	1.00
Stabile Bearbeitungsbedingungen	1.20

Korrekturfaktoren für Schnittgeschwindigkeit bei Plan – und Eckfräsen mit $< 100\%$ radialem Eingriff C_{VcRCT}

a_e / DC	5 %	10 %	15 %	20 %	25 %	30 %	40 %	50 %	60 %	70 %	75 %	80 %	90 %	100 %
	1.48	1.35	1.27	1.22	1.19	1.16	1.11	1.08	1.05	1.03	1.00	1.00	1.00	1.00

Korrekturfaktoren zur Kompensation der Spanverjüngung bei Plan – und Eckfräsen mit $< 100\%$ radialem Eingriff C_{fzRCT}

a_e / DC	5 %	10 %	15 %	20 %	25 %	30 %	40 %	50 %	60 %	70 %	75 %	80 %	90 %	100 %
	2.20	1.60	1.35	1.20	1.10	0.95	0.85	0.75	0.85	0.95	1.00	1.00	1.00	1.00
	0.64	0.64	0.64	0.64	0.64	0.65	0.65	0.67	0.68	0.71	0.72	0.74	0.79	1.00

Resultierende korrigierte Schnittgeschwindigkeit v_{cc}

$$v_{cc} = v_c \times k_{VG} \times C_{VcO} \times C_{VcT} \times C_{VcA} \times C_{VcRCT} \times C_{fzRCT}$$

k_{VG} – Koeffizient des verwendeten Werkstoffs

v_c – Anfangsgeschwindigkeit von Katalogseite

FORMELN

Wert	Einheit	Formel
Drehzahl	(U/min)	$n = \frac{v_c \times 1000}{DC \times \pi}$
Schnittgeschwindigkeit	(m/min)	$v_c = \frac{\pi \times DC \times n}{1000}$
Vorschub pro Umdrehung	(mm/U)	$f_{rev} = \frac{f_{min}}{n} = f_z \times z$
Vorschubgeschwindigkeit	(mm/min)	$f_{min} = v_f = f_{rev} \times n = f_z \times z \times n$
Vorschub pro Zahn	(mm/Zahn)	$f_z = \frac{f_{rev}}{z} = \frac{f_{min}}{n \times z}$
Spanquerschnitt	(mm ²)	$A = f_z \times a_p$
Spandicke (für WSP mit gerader Schneidkante)	(mm)	$h = f_z \times \sin KAPR$
Spandicke (für WSP mit runder Schneidkante)	(mm)	$h = f_z \times \sqrt{\frac{a_p}{INSD}}$
Zeitspanvolumen	(cm ³ /min)	$Q = \frac{a_p \times a_e \times f_{min}}{1000}$
Leistungsbedarf	(kW)	$P_c = \frac{a_p \times a_e \times f_{min}}{60 \times 10^6 \times \eta} \times k_c \times k_y$
Ungefähre Leistungsaufnahme	(kW)	$P_c = \frac{a_p \times a_e \times f_{min}}{x}$

Hinweis:

	Wert	Einheit
n	Drehzahl	(U/min)
DC	Durchmesser (von Werkzeug oder Werkstück)	(mm)
v_c	Schnittgeschwindigkeit	(m/min)
f_{rev}	Vorschub pro Umdrehung	(mm/U)
A	Spanquerschnitt	(mm ²)
a_p	Axiale Schnitttiefe (Schnitttiefe)	(mm)
a_e	Radiale Schnitttiefe (Schnittbreite)	(mm)
KAPR	Einstellwinkel der Hauptschneide	(°)
f_{min}	Vorschubgeschwindigkeit	(mm/min)
f_z	Vorschub pro Zahn	(mm/Zahn)
z	Anzahl der Zähne	(-)
INSD	Durchmesser von WSP	(mm)

	Wert	Einheit
h	Spandicke	(mm)
Q	Zeitspanvolumen	(cm ³ /min)
P_c	Leistungsbedarf	(kW)
k_c	Spezifische Hauptschnittkraft mm ²	(MPa)
k_y	Faktor der den Winkeleinfluss γ ₀ einschließt	(°)
η	Wirkungsgrad der Frasmachine gewöhnlich η = 0.75	(-)
x	Koeffizient, der den Einfluss des zu bearb. Materials einschließt	(-)

Material	Stahl	Guss	Al
Koeffizient x	24 000	30 000	120 000

EMPFOHLENES DREHMOMENT DER KLEMMSCHRAUBEN

Spannschraube	Anzugsmoment	Gewinde	Länge
	(Nm)		
US 20	0.9	M 2	3
US 2205-T07P	0.9	M 2.2	5
US 25	1.2	M 2.5	5
US 2505-T08P	1.2	M 2.5	5
US 2506-T07P	1.2	M 2.5	6
US 3006-T09P	2	M 3	6
US 3007-T09P	2	M 3	7
US 3504-T09P	3	M 3.5	4
US 3507-T15	3	M 3.5	7
US 3509-T15	3	M 3.5	9
US 3511-T15	3	M 3.5	11
US 3512-T15P	3	M 3.5	12
US 4008-T15P	3.5	M 4	8
US 4011-T15P	3.5	M 4	11
US 4511-T20	5	M 4.5	11
US 5012-T15P	5	M 5	12
US 70	5	M 4	5
US 71	5	M 4	7
US 72	5	M 4	9
US 73	5	M 4	11
CS 3007-T08P	1.2	M 3	7
CS 4008-T15P	3	M 4	8
CS 42506-T07P	1	M 2.5	6
CS 43008-T08P	1.2	M 3	8
CS 43509-T10P	2	M 3.5	9
CS 44013-T15P	3	M 4	13
CS 45016-T20P	5	M 5	16
CS 46020-T25P	7.5	M 6	20
CS 48025-T40P	15	M 8	25
CS 5009-T20P	5	M 5	9
CS 5013-T20P	5	M 5	13
CS 5015-T20P	5	M 5	15
CS 6020-T20P	7.5	M 6	20
CS 8025-T30P	15	M 8	25
US 2505-T07P	1.2	M 2.5	5
US 2506-T07P	1.2	M 2.5	6
US 3007-T09P	2	M 3	7
US 3505-T09P	3	M 3.5	5
US 4011A-T15P	3.5	M 4	11
US 4011-T15P	3.5	M 4	11
US 44010-T15P	3.5	M 4	10
US 44012-T15P	3.5	M 4	12
US 45011-T20P	5	M 5	11
US 45012-T20P	5	M 5	12
US 5011-T20P	5	M 5	11
US 5018-T20P	5	M 5	18
US 52506-T07P	0.8	M 2.5	6
US 54511-T15P	5	M 4.5	11
US 62003A-T06P	0.6	M 2	3
US 62004A-T06P	0.6	M 2	4
US 62004-T06P	0.6	M 2	4
US 62505-T07P	1.2	M 2.5	5
US 62506-T07P	1.2	M 2.5	6
US 62506-T08P	1.2	M 2.5	6
US 62508-T08P	1.2	M 2.5	7
US 63009-T09P	1.2	M 3	9
US 63509-T15P	3	M 3.5	10
US 63510-T10P	2	M 3.5	9
US 63511D-T15P	3	M 3.5	11

Spannschraube	Anzugsmoment	Gewinde	Länge
	(Nm)		
US 63513-T15P	3	M 3.5	12
US 64014-T15P	3.5	M 4	14
US 65013-T20	5	M 5	13
US 65014-T20P	5	M 5	14
US 65017-T20P	5	M 5	17
US 66015-T25P	7.5	M 6	15
US 68020-T30P	15	M 8	20
US 68026-T30P	15	M 8	26
US 74016-T15P	3.5	M 4	16

Drehmoment-Schraubendreher

Drehmomentgriff 	Drehmoment (Nm)	Spannschraubengewinde
MR-0.8-2.0 Vario	0.5 – 2.0	M 2 – M 3
MR-1.0-5.0 Vario	0.8 – 5.0	M 2.5 – M 5
MR-0.9 fix	0.9	M 2
MR-2.0 fix	2.0	M 3
MR-3.0 fix	3.0	M 3.5
MR-3.5 fix	3.5	M 4
MR-5.0 fix	5.0	M 5

Austauschbare Schäfte

Austauschbare Schäfte 
D-T6
D-T6P
D-T7
D-T7P
D-T8
D-T8P
D-T9
D-T9P
D-T15
D-T15P
D-T20
D-T20P

Schmierung von Schrauben

Im Hinblick auf die Wärmebeanspruchung der Spannschrauben wird empfohlen, diese mit einer hochwertigen Schmierpaste MOLYKOTE 1000 zu schmieren.

TECHNISCHE INFORMATIONEN ZUR WSP- BOX

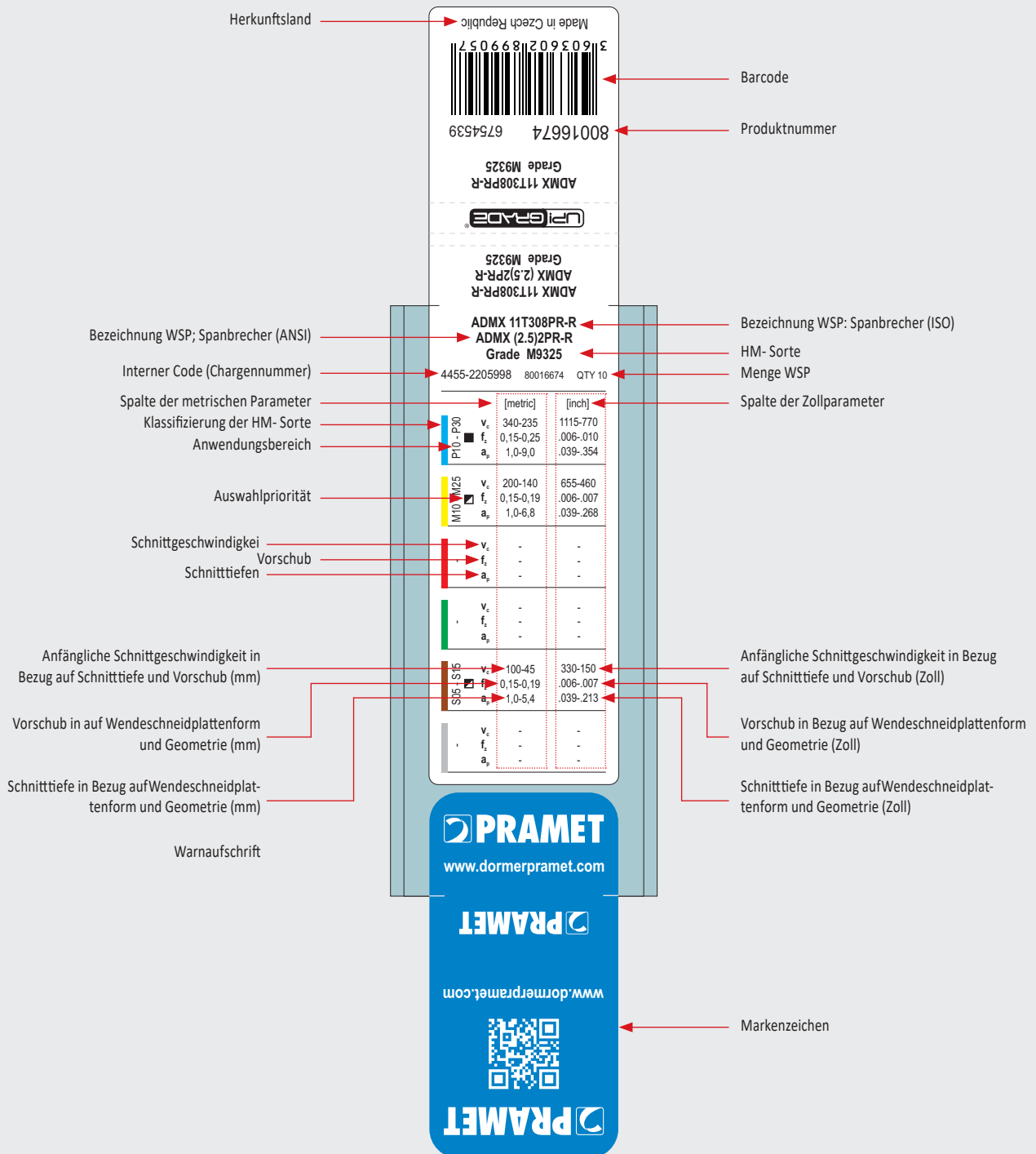

WMG (WERKSTOFF-MATERIALGRUPPEN)

ISO Gruppe	WMG (Werkstoff-Materialgruppen)		Härte (HB oder HRC)	Zugfestigkeit (MPa)	Korrekturfaktoren kvG		
P	P1	P1.1	Geschwefelt	< 240 HB	≤ 830	1.33	
		P1.2	Stahl (Automatenstahl)	Geschwefelt und phosphoriert	< 180 HB	≤ 620	1.49
		P1.3	(Kohlenstoffstähle mit erhöhter Bearbeitbarkeit)	Geschwefelt / phosphoriert und verbleit	< 180 HB	≤ 620	1.53
	P2	P2.1	Kohlenstoffstahl (Stähle, die hauptsächlich aus Eisen und Kohlenstoff bestehen)	Enthält <0.25%C	< 180 HB	≤ 620	1.14
		P2.2		Enthält <0.55%C	< 240 HB	≤ 830	1.00
		P2.3		Enthält >0.55%C	< 300 HB	≤ 1030	0.89
	P3	P3.1	Legierter Stahl (Kohlenstoffstähle mit einem Legierungsgehalt ≤ 10%)	Gegliiht	< 180 HB	≤ 620	0.92
		P3.2		Gehärtet und angelassen	180 – 260 HB	> 620 ≤ 900	0.74
		P3.3			260 – 360 HB	> 900 ≤ 1240	0.63
	P4	P4.1	Werkzeugstahl (Speziallegierter Stahl für Werkzeuge, Matrizen und Formen)	Gegliiht	< 26 HRC	≤ 900	0.55
		P4.2		Gehärtet und angelassen	26 – 39 HRC	> 900 ≤ 1240	0.47
		P4.3			39 – 45 HRC	> 1240 ≤ 1450	0.38
M	M1	M1.1	Ferritischer Edelstahl (nicht härtbare Chromlegierungen)	< 160 HB	≤ 520	1.22	
		M1.2		160 – 220 HB	> 520 ≤ 700	1.03	
	M2	M2.1	Martensitischer Edelstahl (härtbare Chromlegierungen)	Gegliiht	< 200 HB	≤ 670	1.08
		M2.2		Vergütet	200 – 280 HB	> 670 ≤ 950	0.89
		M2.3		Ausscheidungsgehärtet	280 – 380 HB	> 950 ≤ 1300	0.75
	M3	M3.1	Austenitischer Edelstahl (Chrom-Nickel- und Chrom-Nickel-Mangan-Legierungen)	< 200 HB	≤ 750	1.00	
		M3.2		200 – 260 HB	> 750 ≤ 870	0.86	
		M3.3		260 – 300 HB	> 870 ≤ 1040	0.77	
	M4	M4.1	Austenitisch-ferritischer (DUPELX) oder superaustenitischer Edelstahl	< 300 HB	≤ 990	0.75	
		M4.2	Ausscheidungsgehärteter austenitischer Edelstahl	300 – 380 HB	≤ 1320	0.64	
	K	K1	K1.1	Ferritisch oder ferritisch-perlitisch (Eisen-Kohlenstoff-Gussteile mit einer Lamellengraphit-Mikrostruktur)	< 180 HB	≤ 190	1.35
			K1.2		Ferritisch-perlitisch oder perlitisch	180 – 240 HB	> 190 ≤ 310
K1.3			Perlitisch		240 – 280 HB	> 310 ≤ 390	0.75
K2		K2.1	Temperguss (ASTM A602) (Eisen-Kohlenstoff-Gussteile mit graphitfreier Mikrostruktur)	Ferritisch	< 160 HB	≤ 400	1.39
		K2.2		Ferritisch oder perlitisch	160 – 200 HB	> 400 ≤ 550	1.13
		K2.3		Perlitisch	200 – 240 HB	> 550 ≤ 660	0.90
K3		K3.1	Duktiles Gusseisen (ASTM A536) (Eisen-Kohlenstoff-Gussteile mit einer Kugelgraphit-Mikrostruktur)	Ferritisch	< 180 HB	≤ 560	1.23
		K3.2		Ferritisch oder perlitisch	180 – 220 HB	> 560 ≤ 680	0.94
		K3.3		Perlitisch	220 – 260 HB	> 680 ≤ 800	0.76
K4		K4.1	Austenitisches Grauguss (ASTM A436) (Gussteile aus Eisen-Kohlenstoff-Legierungen mit einer austenitischen Lamellengraphit-Mikrostruktur)	< 180 HB	≤ 190	1.14	
		K4.2	Austenitisches duktiler Gusseisen (ASTM A439 oder ASTM A571) (Gussteile aus Eisen-Kohlenstoff-Legierungen mit austenitischer Kugelgraphit-Mikrostruktur)	< 240 HB	≤ 740	0.86	
		K4.3	Austemperiertes duktiler Gusseisen (ASTM A897) (Gussteile aus Eisen-Kohlenstoff-Legierungen mit einer Ausferrit-Mikrostruktur)	< 280 HB	> 840 ≤ 980	0.63	
	K4.4	280 – 320 HB		> 980 ≤ 1130	0.54		
	K4.5	320 – 360 HB		> 1130 ≤ 1280	0.45		
K5	K5.1	GJV aus verdichtetem Graphiteisen (ASTM A842) (Eisen-Kohlenstoff-Gussteile mit vermulärer Graphitstruktur)	Ferritisch	< 180 HB	≤ 400	1.29	
	K5.2		Ferritisch oder perlitisch	180 – 220 HB	> 400 ≤ 450	0.97	
	K5.3		Perlitisch	220 – 260 HB	> 450 ≤ 500	0.75	
N	N1	N1.1	Kommerziell reine Aluminiumknetlegierung	< 60 HB	≤ 240	1.33	
		N1.2		Naturhart	60 – 100 HB	> 240 ≤ 400	1.00
		N1.3		Aushärtbar	100 – 150 HB	> 400 ≤ 590	0.67
	N2	N2.1	Aluminiumgusslegierungen	< 75 HB	≤ 240	0.67	
		N2.2		75 – 90 HB	> 240 ≤ 270	0.60	
		N2.3		90 – 140 HB	> 270 ≤ 440	0.43	
	N3	N3.1	Kupferlegierungen mit hervorragenden Bearbeitungseigenschaften Kurzspanige Kupferlegierungen mit guten bis mäßigen Bearbeitungseigenschaften	–	–	0.70	
		N3.2		–	–	0.41	
		N3.3		Elektrolytisches Kupfer und langspanige Kupferlegierungen mit mäßigen bis schlechten Bearbeitungseigenschaften	–	–	0.21
	N4	N4.1	Thermoplastische Polymere Duroplaste Verstärkte Polymere oder Verbundwerkstoffe	–	–	0.70	
		N4.2		–	–	0.27	
		N4.3		–	–	0.29	
N5	N5.1	Graphit	–	–	1.00		
S	S1	S1.1	Titan oder Titanlegierungen	< 200 HB	≤ 660	1.94	
		S1.2		200 – 280 HB	> 660 ≤ 950	1.72	
		S1.3		280 – 360 HB	> 950 ≤ 1200	1.44	
	S2	S2.1	Eisenbasierte Hochtemperaturlegierungen	< 200 HB	≤ 690	1.33	
		S2.2		200 – 280 HB	> 690 ≤ 970	1.17	
	S3	S3.1	Nickelbasierte Hochtemperaturlegierungen	< 280 HB	≤ 940	1.00	
		S3.2		280 – 360 HB	> 940 ≤ 1200	0.83	
	S4	S4.1	Kobaltbasierte Hochtemperaturlegierungen	< 240 HB	≤ 800	0.78	
S4.2		240 – 320 HB		> 800 ≤ 1070	0.67		
H	H1	H1.1	Hartguss	< 440 HB	–	1.52	
		H1.2		< 55 HRC	–	0.90	
	H2	H2.1	Gehärtetes Gusseisen	> 55 HRC	–	0.77	
		H2.2		< 51 HRC	–	1.00	
	H3	H3.1	Gehärteter Stahl < 55 HRC	51 – 55 HRC	–	0.82	
		H3.2		< 55 HRC	–	0.64	
H4	H4.1	Gehärteter Stahl > 55 HRC	> 59 HRC	–	0.54		
	H4.2		> 59 HRC	–	0.54		

UMWANDLUNGSTABELLE FÜR HÄRTEWERTE

Festigkeit (MPa)	Härte			
	BRINELL	VICKERS	ROCKWELL	ROCKWELL
R_m	HB	HV	HRB	HRC
285	86	90	1190	–
320	95	100	56.2	–
350	105	110	62.3	–
385	114	120	66.7	–
415	124	130	71.2	–
450	133	140	75.0	–
480	143	150	78.7	–
510	152	160	81.7	–
545	162	170	85.8	–
575	171	180	87.1	–
610	181	190	89.5	–
640	190	200	91.5	–
675	199	210	93.5	–
705	209	220	95	–
740	219	230	96.7	–
770	228	240	98.1	–
800	238	250	99.5	–
820	242	255	–	23.1
850	252	265	–	24.8
880	261	275	–	26.4
900	266	280	–	27.1
930	276	290	–	28.5
950	280	295	–	29.2
995	295	310	–	31.0
1030	304	320	–	32.2
1060	314	330	–	33.3
1095	323	340	–	34.4
1125	333	350	–	35.5
1155	342	360	–	36.6

Festigkeit (MPa)	Härte			
	BRINELL	VICKERS	ROCKWELL	ROCKWELL
R_m	HB	HV	HRB	HRC
1190	352	370	–	37.7
1220	361	380	–	38.8
1255	371	390	–	39.8
1290	380	400	–	40.8
1320	390	410	–	41.8
1350	399	420	–	42.7
1385	409	430	–	43.6
1420	418	440	–	44.5
1455	428	450	–	45.3
1485	437	460	–	46.1
1520	447	470	–	46.9
1555	456	480	–	47.7
1595	466	490	–	48.4
1630	475	500	–	49.1
1665	485	510	–	49.8
1700	494	520	–	50.5
1740	504	530	–	51.1
1775	513	540	–	51.7
1810	523	550	–	52.3
1845	532	560	–	53.0
1880	542	570	–	53.6
1920	551	580	–	54.1
1955	561	590	–	54.7
1995	570	600	–	55.2
2030	580	610	–	55.7
2070	589	620	–	56.3
2105	599	630	–	56.8
2145	608	640	–	57.3
2180	618	650	–	57.8

SIMPLY RELIABLE

Der Fachmann erkennt die Qualität der Arbeit bereits bei der Betrachtung der Späne. Deshalb haben wir eine klare, schnörkellose Spanform als Logo gewählt. Dieser Span steht stellvertretend für die Spanformen, welche bei der Bearbeitung mit Einsatz unserer Produkte entstehen. Er spricht für sich und die hohe Zuverlässigkeit unserer Produkte. **Simply Reliable.**

DORMER PRAMET

www.dormerpramet.com



**IHRE LOKALE
UNTERSTÜTZUNG
FÜR DEN VERTRIEB!**



DP-CAT-INDEXMILL-2024-DE

FOLLOW US...



ONLINE



SEGMENTS



LIBRARY APP.



CALCULATOR APP.

