

DORMER PRAMET

GATBEWERKING

2021 – 2022



 **DORMER**

 **PRAMET**



GATBEWERKING - ALGEMENE INHOUD

6		WMG & ISO 13399
12	BOREN	INSTRUCTIES
15		VOLHARDMETAAL BOREN
66		HSS BOREN
176		TECHNISCHE INFORMATIE
186		SNIJOLIE
190		RUIMERS EN VERZINKBOREN
264	WISSELPLAATBOREN	INSTRUCTIES
271		HYDRA BOREN
297		TECHNISCHE INFORMATIE
307		WISSELPLAATBOREN
327		TECHNISCHE INFORMATIE
350	KOTTERSYSTEMEN	INSTRUCTIES
359		KOTTERKOPPEN
376		KOTTER ACCESSOIRES
381		WISSELPLATEN
404		OPNAMES
418		KOTTERSETS
429		TECHNISCHE INFORMATIE



PRODUCTFAMILIE		PRODUCTFAMILIE		PRODUCTFAMILIE		PRODUCTFAMILIE	
A		A243	120	B180	216	H	
A002	96	A244	121	B301	211	H851	287
A002S	98	A266	158	B334	208	H8512	294
A022	82	A295	172	B335	209	H853	289
A080	169	A296	173	B400	200	H855	291
A087	166	A345	146	B411	204	H858	293
A088	165	A350	144	B441	203	H860	295
A089	167	A400	150	B442	205	H861	296
A094	166	A402	151	B481	201	M	
A095	165	A405	152	B901	210	M150	173
A099	168	A412	153	B903	212	M151	174
A100	99	A413	154	B952	213	M152	174
A101	103	A510	111	B953	215	M200-1	187
A108	104	A520	88	B954	225	M200-2	187
A110	122	A530	140	B955	226	M200-3	188
A117	86	A553	113	B956	227	R	
A119	77	A620	84	B957	228	R100	34
A120	80	A720	91	G		R120	32
A122	78	A723	76	G106	238	R122	27
A123	79	A730	141	G107	242	R123	28
A124	90	A777	108	G125	249	R125	29
A125	128	A900	114	G129	234	R200	26
A130	134	A901	116	G132	244	R453	52
A147	106	A920	92	G135	230	R454	48
A160	110	A921	94	G136	236	R457	44
A166	143	A940	124	G137	232	R458	40
A170	118	A941	126	G138	245	R459	56
A188	172	A951	148	G142	240	R463	62
A190	170	A952	149	G149	235	R467	59
A191	171	A976	130	G154	233	R510	38
A199	169	A977	132	G171	247	R520	36
A200	155	A978	133	G236	250	R6011	30
A201	160	B		G314	248	R7131	31
A205	156	B100	206	G335	231	R950	281
A206	157	B101	222	G338	246	R960	283
A210	159	B121	224	G400	229	R970	285
A225	161	B122	214	G506	239		
A237	162	B157	220	G560	237		
A238	163	B161	221	G570	241		
A242	164	B170	218	G600	243		



PRODUCTFAMILIE		PRODUCTFAMILIE		PRODUCTFAMILIE		PRODUCTFAMILIE	
Z		BS 54 KIT TC 8-210	427	EXT-BS	415	M	
2080-BS	411	BT-BS	408	F		MB-H	373
69871-BS	406	C		F75	367	MOR-BS	413
802D	313	CART-BS-SPC	378	F75-BB	369	R	
803D	315	CART-BS-STD	379	F75-C	368	RED-BS	416
804D	318	CHAM-BS	380	F90	370	W	
805D	320	D		F90-BB	372	WEL-BS	414
B		D75	361	F90-C	371		
BS 54 KIT RC 8-043	420	D75-BB	363	H			
BS 54 KIT RC 8-100	421	D75-C	362	HSK-BS	410		
BS 54 KIT RC 8-170	422	D90	364	I			
BS 54 KIT RC 8-210	423	D90-BB	366	ISO BARS	374		
BS 54 KIT TC 8-043	424	D90-C	365	ISO BARS A042	375		
BS 54 KIT TC 8-100	425	E		L			
BS 54 KIT TC 8-170	426	EP	322	LA-BS	417		

PRODUCTFAMILIE		PRODUCTFAMILIE	
C		S	
CCGT	388	SCET	323
CCGW CBN	390	T	
CCMT	390	TCGT	401
CCMW	393	TCMT	402
CNGA CBN	394	TCMW	403
CNGG	395	W	
CNMA	395	WCMT-ID	325
CNMG	396	WCMX	326
D		X	
DCMT	398	XPET	324
DCMW	399		
DCMW PCD	399		
E			
EPGX	400		
EPMT	400		



DORMER PRAMET



BESPAREN

Met onze bewerkingscalculator kunt u de besparingen berekenen op basis van verschillende producten en toepassingen. Een handige tool in broekzakformaat, die ervoor zorgt dat u geld bespaart! **Simply Reliable.**

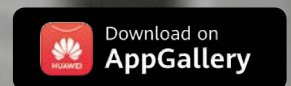
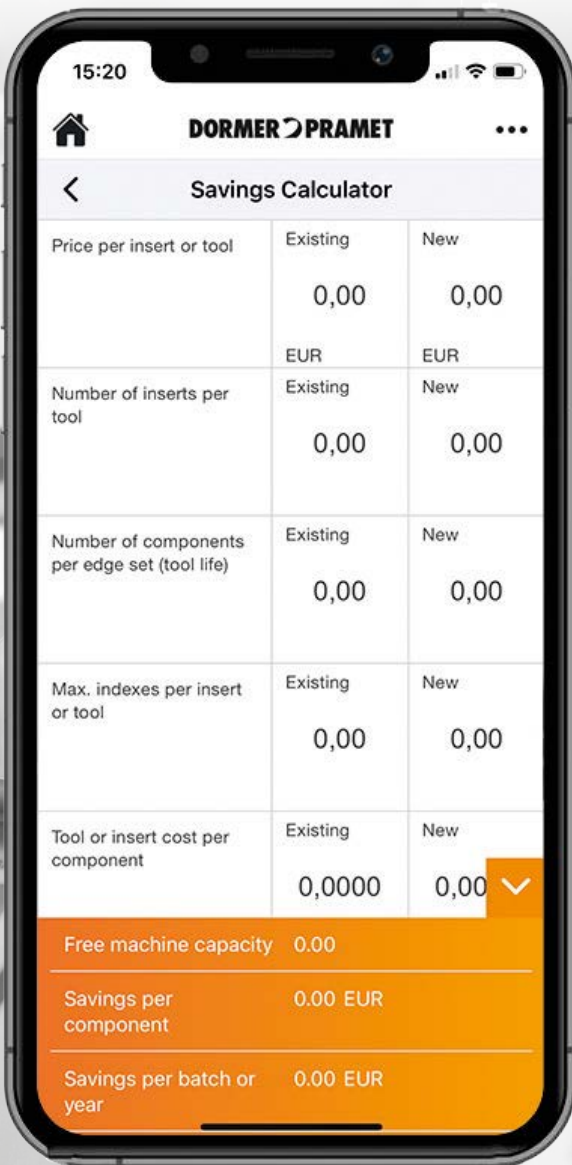



GATBEWERKING - ALGEMENE INHOUD

6		WMG & ISO 13399
12	BOREN	INSTRUCTIES
15		VOLHARDMETAAL BOREN
66		HSS BOREN
176		TECHNISCHE INFORMATIE
186		SNIJOLIE
190		RUIMERS EN VERZINKBOREN
264	WISSELPLAATBOREN	INSTRUCTIES
271		HYDRA BOREN
297		TECHNISCHE INFORMATIE
307		WISSELPLAATBOREN
327		TECHNISCHE INFORMATIE
350	KOTTERSYSTEMEN	INSTRUCTIES
359		KOTTERKOPPEN
376		KOTTER ACCESSOIRES
381		WISSELPLATEN
404		OPNAMES
418		KOTTERSETS
429		TECHNISCHE INFORMATIE



WERKSTUKMATERIAALGROEPEN (WMG)

ISO Voor het selecteren van een basismateriaal en geometrie voor een breed scala aan werkstukmaterialen

Algemene definitie
d.w.z. staal, roestvast staal...

P **M** **K** **N** **S** **H**

Subgroep Om te navigeren en een gereedschap te selecteren op basis van geschiktheid voor een specifiek assortiment werkstukmaterialen

Definitie op basis van structuur/samenstelling
d.w.z. gewoon koolstofstaal, gelegeerd staal...

P **M** **K** **N** **S** **H**

P1

P2

P3

P4

WMG Het selecteren en bieden van snijcondities binnen een bandbreedte van $\pm 10\%$

Definitie op basis van hardheid/treksterkte
d.w.z. $160 < 220 \text{ HB}$, $620 < 900 \text{ n/mm}^2 \dots$

P

P1 **P1.1** **P1.2** **P1.3**

P2 **P2.1** **P2.2** **P2.3**

P3 **P3.1** **P3.2** **P3.3**

P4 **P4.1** **P4.2** **P4.3**

INFORMATIE OVER WERKSTUKMATERIAALCLASSIFICATIE VAN DORMER PRAMET

Werkstukmateriaalgroepen ("WMG") zijn bedoeld om een eenvoudige en betrouwbare keuze van het juiste snijgereedschap en startwaarden voor de verspaningscondities in bepaalde toepassingen te kunnen maken.

Dormer Pramet deelt werkstukmaterialen in zes verschillend gekleurde groepen in;

- **Blauw:** Staal en gietstaal (groep P)
- **Geel:** Roestvast staal (groep M)
- **Rood:** Gietijzer (groep K)
- **Groen:** Non-ferro metalen (groep N)
- **Bruin:** Hittebestendige legeringen (groep S)
- **Grijs:** Geharde materialen (groep H)

Al deze materialen zijn afzonderlijk onderverdeeld in subgroepen op basis van structuur en/of samenstelling. Staal en gietstaal uit groep P zijn bijvoorbeeld onderverdeeld in vier subgroepen, te weten;

- P1 – **Automatenstaal**
- P2 – **Koolstofstaal/ongelegeerd staal**
- P3 – **Gelegeerd staal**
- P4 – **Gereedschapstaal**

Een uiteindelijke verdeling omvat materiaaleigenschappen, zoals hardheid en treksterkte. Dit is bedoeld om onze klanten volledig advies te geven over het gereedschap, inclusief startwaarden voor snij snelheid en voeding.

De tabel op de volgende pagina bevat een beschrijving van elke werkstukmateriaalgroep en voorbeelden van veelgebruikte benamingen.



WMG (WERKSTUK MATERIAAL GROEP)

ISO group	WMG (Werkstuk Materiaal Groep)	Hardheid (HB of HRC)	Treksterkte (MPa)		
P	P1.1	Zwavelhoudend	< 240 HB	≤ 830	
	P1.2	Automatenstaal	Zwavel- en fosforhoudend	< 180 HB	≤ 620
	P1.3	(Koolstofstaal met verhoogde bewerkbaarheid)	Zwavel-, fosfor-, en loodhoudend	< 180 HB	≤ 620
	P2.1	Koolstofstaal (staalsoorten die hoofdzakelijk bestaan uit ijzer en koolstof)	Gehalte <0.25%C	< 180 HB	≤ 620
	P2.2		Gehalte <0.55%C	< 240 HB	≤ 830
	P2.3		Gehalte >0.55%C	< 300 HB	≤ 1030
	P3.1	Gelegeerd staal (koolstofstaal met een legeringsgehalte ≤ 10%)	Gegloeid	< 180 HB	≤ 620
	P3.2		Gehard en getemperd	180 – 260 HB	> 620 ≤ 900
	P3.3			260 – 360 HB	> 900 ≤ 1240
	P4.1	Gereedschapstaal (speciaal gelegeerd staal voor gereedschappen, matrijzen en mallen)	Gegloeid	< 26 HRC	≤ 900
P4.2	Gehard en getemperd		26 – 39 HRC	> 900 ≤ 1240	
P4.3			39 – 45 HRC	> 1240 ≤ 1450	
M	M1.1	Ferritisch roestvast staal (chromhoudende niet hardbare legering)	< 160 HB	≤ 520	
	M1.2		160 – 220 HB	> 520 ≤ 700	
	M2.1	Martensitisch roestvast staal (chromhoudende hardbare legeringen)	Gegloeid	< 200 HB	≤ 670
	M2.2		Afgeschrikt en getemperd	200 – 280 HB	> 670 ≤ 950
	M2.3			Precipitatie gehard	280 – 380 HB
	M3.1	Austenitisch roestvast staal (chromhoudende en nikkel chroom magnesium legeringen)	< 200 HB	≤ 750	
	M3.2		200 – 260 HB	> 750 ≤ 870	
	M3.3		260 – 300 HB	> 870 ≤ 1040	
	M4.1	Austenitisch ferritisch (DUPLEX) of super austenitisch roestvast staal	< 300 HB	≤ 990	
	M4.2		Precipitatie hardend austenitisch roestvast staal	300 – 380 HB	≤ 1320
K	K1.1	Grijs gietijzer (GG) (ijzer koolstof gietstukken met een lamellaire grafiet microstructuur)	Ferritisch of ferritisch perlitisch	< 180 HB	≤ 190
	K1.2		Ferritisch perlitisch of perlitisch	180 – 240 HB	> 190 ≤ 310
	K1.3		Perlitisch	240 – 280 HB	> 310 ≤ 390
	K2.1	Smeedbaar gietijzer (GTS-GTW) (ijzer-koolstof gietstukken met grafietvrije microstructuur)	Ferritisch	< 160 HB	≤ 400
	K2.2		Ferritisch of perlitisch	160 – 200 HB	> 400 ≤ 550
	K2.3		Perlitisch	200 – 240 HB	> 550 ≤ 660
	K3.1	Taai gietijzer (GGG) (ijzer-koolstof gietstukken met een nodulaire grafiet microstructuur)	Ferritisch	< 180 HB	≤ 560
	K3.2		Ferritisch of perlitisch	180 – 220 HB	> 560 ≤ 680
	K3.3		Perlitisch	220 – 260 HB	> 680 ≤ 800
	K4.1	Austenitisch gietijzer (GGL) (ijzer koolstof gietstukken met een austenitische lamellaire grafiet microstructuur)	< 180 HB	≤ 190	
	K4.2		Austenitisch taai gietijzer (ijzer-koolstof gelegeerde gietstukken met een austenitisch nodulaire grafiet microstructuur)	< 240 HB	≤ 740
	K4.3	Austempered nodulair gietijzer (ijzer koolstof gelegeerde gietstukken met een ausferritische microstructuur)	< 280 HB	> 840 ≤ 980	
	K4.4		280 – 320 HB	> 980 ≤ 1130	
	K4.5		320 – 360 HB	> 1130 ≤ 1280	
	K5.1	Verdicht gietijzer (GI) (ijzer koolstof gietstukken met een vermiculaire grafiet microstructuur)	Ferritisch	< 180 HB	≤ 400
K5.2	Ferritisch perlitisch		180 – 220 HB	> 400 ≤ 450	
K5.3	Perlitisch		220 – 260 HB	> 450 ≤ 500	
N	N1.1	Zuiver Aluminium	< 60 HB	≤ 240	
	N1.2		Gesmeed Aluminium legeringen	60 – 100 HB	> 240 ≤ 400
	N1.3			Doorgehard getemperd	100 – 150 HB
	N2.1	Gietaluminium legeringen	< 75 HB	≤ 240	
	N2.2		75 – 90 HB	> 240 ≤ 270	
	N2.3		90 – 140 HB	> 270 ≤ 440	
	N3.1	Automaten messing en koperlegeringen met uitstekende verspaningseigenschappen	–	–	
	N3.2	Kortspanig messing en koperlegeringen met goede tot middelmatige verspaningseigenschappen	–	–	
	N3.3	Electrolitisch koper en langspanige koperlegeringen met middelmatige tot slechte verspaningseigenschappen	–	–	
	N4.1	Thermoplastische kunststoffen	–	–	
	N4.2	Thermohardende kunststoffen	–	–	
	N4.3	Versterkte kunststoffen of composieten	–	–	
	N5.1	Grafiet	–	–	
	S	S1.1	Titanium of titanium legeringen	< 200 HB	≤ 660
		S1.2		200 – 280 HB	> 660 ≤ 950
S1.3		280 – 360 HB		> 950 ≤ 1200	
S2.1		Fe-houdende warmvaste legeringen	< 200 HB	≤ 690	
S2.2			200 – 280 HB	> 690 ≤ 970	
S3.1		Ni-houdende warmvaste legeringen	< 280 HB	≤ 940	
S3.2			280 – 360 HB	> 940 ≤ 1200	
S4.1		Co-houdende warmvaste legeringen	< 240 HB	≤ 800	
S4.2	240 – 320 HB		> 800 ≤ 1070		
H	H1.1	Afgeschrikt gietijzer	< 440 HB	–	
	H2.1	Gehard gietijzer	< 55 HRC	–	
	H2.2		> 55 HRC	–	
	H3.1	Gehard staal < 55 HRC	< 51 HRC	–	
	H3.2		51 – 55 HRC	–	
	H4.1	Gehard staal > 55 HRC	55 – 59 HRC	–	
H4.2	> 59 HRC		–		



SNIJGEREEDSCHAP PARAMETERS VOLGENS ISO 13399

Alle snijgereedschappen worden gedefinieerd door een aantal parameters volgens de ISO 13399 standaard

ISO 13399 is een internationale norm voor snijgereedschapinformatie. Het biedt afmetingen en parameters in een neutraal formaat dat onafhankelijk is van een bepaald systeem of bedrijfsnomenclatuur. Wanneer snijgereedschappen duidelijk zijn gedefinieerd volgens een wereldwijde norm, kunnen alle soorten software de elektronische gegevens sneller verwerken, waardoor de kwaliteit van de communicatie wordt verbeterd en de uitwisseling van informatie soepeler verloopt.

Door het ondersteunen van een gemeenschappelijke taal in onze snijgereedschapbeschrijvingen zal dit de systeemcommunicatie ondersteunen. Het zal u aanzienlijk veel tijd besparen, waardoor u gemakkelijker gegevens van hoge kwaliteit kunt verzamelen in onze 40.000 gereedschappen. Door gebruik te maken van een systeem dat voldoet aan ISO 13399, is het niet nodig om gegevens handmatig te interpreteren en in uw systeem in te voeren.

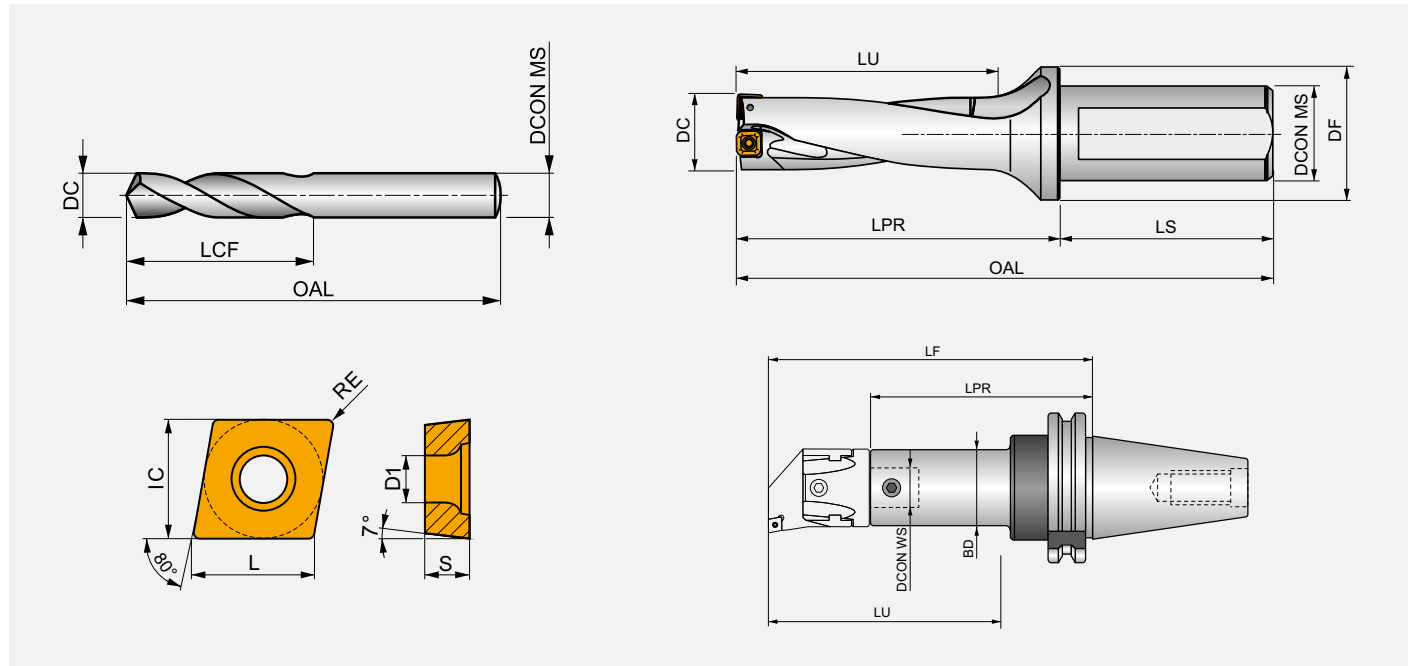

ISO 13399	Omschrijving
BD	Body diameter
BDX	Maximale body diameter
CZC MS	Code aansluitgrootte machinezijde
D1	Diameter bevestigingsgat
DC	Snijdiameter
DCN	Minimale snijdiameter
DCON MS	Schachtdiameter
DCON WS	Aansluitdiameter
DCX	Maximale snijdiameter
DHUB	Borstdiameter
FLGT	Flensdikte
IC	Diameter ingeschreven cirkel
L	Snijkantlengte
LB	Lengte van de body
LF	Functionele lengte
LPR	Uitsteeklengte
LU	Bruikbare lengte
OAL	Totale lengte
RE	Hoekradius
S	Wisselplaatdikte
WF	Functionele breedte
APMX	Maximale snediediepte
D1	Diameter bevestigingsgat
DC_1	Snijdiameter bij de eerste snede
DC_2	Snijdiameter bij de tweede snede

ISO 13399	Omschrijving
DF	Flensdiameter
DH	Schroefkopdiameter
GPD	Diameter geleidepen
GPL	Lengte geleidepen
H	Schachthoogte
HSD	Sleutelmaat / bit
IC	Diameter ingeschreven cirkel
LCF	Spiraallengte
LCOL	Huls lengte
LDC	Aansnijdingslengte
LH	Snijkoplengte
LS	Schachtlengte
LSC	Klemlengte
NOF	Aantal spaangroeven
PLGL	Insteeklengte
RCSK	Radius afschuining
RE	Hoekradius
SDI	Diameters getrapte boor
SDL	Lengte van de trap per diameter
SDL_1	Lengte van de eerste trapdiameter
SDL_2	Lengte van de tweede trapdiameter
TDZ	Nominale draaddiameter
THLGTH	Schroefdraadlengte
WSC	Klembreedte



DORMER PRAMET



UW EIGEN BIBLIOTHEEK

Kijkt u altijd weer naar dezelfde onderdelen van onze publicaties? Met onze bibliotheek-app kunt u belangrijke pagina's opslaan, zodat u ze steeds weer kunt raadplegen, wanneer u maar wilt. **Simply Reliable. Simply Reliable.**

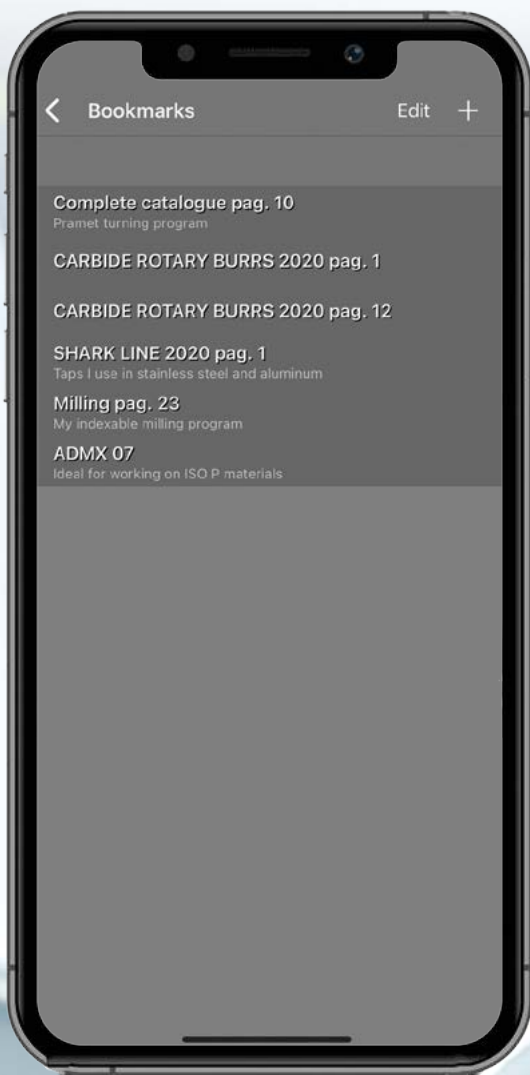



VOLHARDMETAAL BOREN
HSS BOREN





GATBEWERKING - ALGEMENE INHOUD

6		WMG & ISO 13399
12	BOREN	INSTRUCTIES
15		VOLHARDMETAAL BOREN
66		HSS BOREN
176		TECHNISCHE INFORMATIE
186		SNIJOLIE
190		
264	WISSELPLAATBOREN	INSTRUCTIES
271		HYDRA BOREN
295		TECHNISCHE INFORMATIE
307		WISSELPLAATBOREN
327		TECHNISCHE INFORMATIE
350	KOTTERSYSTEMEN	INSTRUCTIES
359		KOTTERKOPPEN
376		KOTTER ACCESSOIRES
381		WISSELPLATEN
404		OPNAMES
418		KOTTERSETS
429		TECHNISCHE INFORMATIE

1 R100



VHM korte spiraalboor, DIN338

Verhoogde slijtvastheid voor hogere productiviteit en langere standtijd van het gereedschap. Een 4-vlakspunt van 120° helpt bij de zelfcentrerend en vermindert de snijkrachten. Kan worden gebruikt in alle stabiele en CNC-machinetoepassingen. Voor het boren in slijtvaste en abrasieve materialen.

2

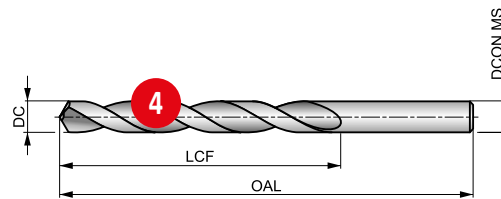

HM	DIN 338	4xD
120°	Bright	
20-35°	R	DC h7

5

De tabel geeft de geschiktheid aan voor de materiaalgroep en de startwaarden voor de snijnsnelheid (m/min) en de letter verwijst naar de toe te passen voeding (fn), zie vanaf pagina 65.

P1.1	P1.2	P1.3	P2.1	P2.2	P2.3	P3.1	P3.2	P3.3	P4.1	P4.2	P4.3	K1.1	K1.2
99 S	111 S	115 S	85 S	75 S	66 S	66 S	53 S	45 S	40 S	34 S	27 S	75 T	56 T
K1.3	K2.1	K2.2	K2.3	K3.1	K3.2	K3.3	K4.1	K4.2	K4.3	K4.4	K4.5	K5.1	K5.2
42 T	68 T	55 T	44 T	60 T	46 T	37	55 T	42 T	31 T	26 T	22 T	63 T	47 T
K5.3	N1.1	N1.2	N1.3	N2.1	N2.2	N2.3	N3.1	N3.2	N4.1	N4.2	H1.1	H2.1	H2.2
37 T	200 V	150 V	100 V	172 V	155 V	112 V	423 V	250 V	60 X	100 V	56 S	33 S	36 S
H3.1	H3.2												
37 S	30 S												

6

Product	DC [mm]	DC [inch]	LCF [mm]	OAL [mm]	DCON MS [mm]
R1001.0	1.00	0.0394	12.0	34.0	1.00
R1001.1	1.10	0.0433	14.0	36.0	1.10
R1001.2	1.20	0.0472	16.0	38.0	1.20
R1001.3	1.30	0.0512	16.0	38.0	1.30
R1001.4	1.40	0.0551	18.0	40.0	1.40
R1001.5	1.50	0.0591	18.0	40.0	1.50
R1001.6	1.60	0.0630	20.0	43.0	1.60
R1001.7	1.70	0.0669	20.0	43.0	1.70
R1001.8	1.80	0.0709	22.0	46.0	1.80
R1001.9	1.90	0.0748	22.0	46.0	1.90
R1002.0	2.00	0.0787	24.0	49.0	2.00

7

8

Product	DC [mm]	DC [inch]	LCF [mm]	OAL [mm]	DCON MS [mm]
R1003.6	3.60	0.1417	39.0	70.0	3.60
R1003.7	3.70	0.1457	39.0	70.0	3.70
R1003.8	3.80	0.1496	43.0	75.0	3.80
R1003.9	3.90	0.1535	43.0	75.0	3.90
R1004.0	4.00	0.1575	43.0	75.0	4.00
R1004.1	4.10	0.1614	43.0	75.0	4.10
R1004.2	4.20	0.1654	43.0	75.0	4.20
R1004.3	4.30	0.1693	47.0	80.0	4.30
R1004.4	4.40	0.1732	47.0	80.0	4.40
R1004.5	4.50	0.1772	47.0	80.0	4.50
R1004.6	4.60	0.1811	47.0	80.0	4.60

Pos.	Omschrijving
1	Productfamiliecode
2	Productomschrijving
3	Afbeelding
4	Schematische afbeelding

Pos.	Omschrijving
5	Productkenmerken
6	Aanbevelingen materiaalgroep incl. snijnsnelheid en voeding
7	Productcode
8	Productafmetingen



VOLHARDMETAAL BOREN & HSS BOREN – UITLEG PICTOGRAMMEN

ALGEMENE PICTOGRAMMEN

■ Eerste keus gebruik

▣ Beperkte inzetbaarheid





TOPHOEK

 Centerboor met 60° verzinkhoek	 Centerboor met radius	 Centerboor met 90° verzinkhoek
 Tophoek 118°	 Tophoek centreerboor 90°/120°	 Tophoek centreerboor 150°
 Tophoek 120°	 Puntlas boorpunt 180°	 Tophoek centreerboor 90°
 Tophoek 122°	 Trapboor (voor schroeven) 180° verzinking	 Tophoek centreerboor 120°
 Tophoek 130°	 Trapboor (voor schroeven) 90° verzinking	
 Tophoek 135°	 Tophoek 140°	

PRODUCTIENORM (BSG)

 BS 328 – Norm voor boren en ruimers	 DIN 1899 – Norm voor micro boren	 DIN 8037 – Norm voor HM gesoldeerde boren
 DIN 1869 / 1 – Norm voor extra lange boren	 DIN 333A – Norm voor centreerboren	 DIN 8374 – Norm voor meerfasentrapboren
 DIN 1869 / 2 – Norm voor extra lange boren	 DIN 333R – Norm voor verzinkboren met cilindrische schacht	 DIN 8376 – Norm voor meerfasentrapboren
 DIN 1869 / 3 – Norm voor extra lange boren	 DIN 338 – Norm voor boren met cilindrische schacht	 DIN 8377 – Norm voor meerfasentrapboren
 DIN 1870 (1) – Norm voor extra lange boren met morseconus	 DIN 340 – Norm voor lange boren	 DIN/ANSI norm
 DIN 1870 (2) – Norm voor extra lange boren met morseconus	 DIN 341 – Norm voor lange MC-boren	 DORMER norm
 DIN 1897 – Norm voor extra korte boren	 DIN 345 – Norm voor MC-boren	 NAS907 – Norm voor lucht- en ruimtevaart boren

COATING

 Aluminium Chrom Nitride (gepolijst)	 Bronskleurige Oxide behandeling	 Titanium Aluminium Nitride (gepolijst)
 Blank (ongecoat)	 Combinatie blank en stoomontlaten	 Titanium Aluminium Nitride Coating
 Blank en TiN-Tip coating	 Stoomontlaten	 Titanium Nitride Coating



VOLHARDMETAAL BOREN & HSS BOREN – UITLEG PICTOGRAMMEN

KOELMIDDELDORVOER (CSP)



Met koelkanalen

SNIJRICHTING



Links



Rechts

HAALBARE PASSING (TCDC)

DC
h8

h8 – Tolerantie van het geboorde gat

DC
h7

h7 – Tolerantie van het geboorde gat

DC
m7

m7 – Tolerantie van het geboorde gat

DC
h6

h6 – Tolerantie van het geboorde gat

BASISMATERIAAL (BMC)

HM

Hardmetaal

HSS
HM

Snelstaal met hardmetalen snijkant

HSS

Snelstaal

HSS-E

Cobalt gelegeerd snelstaal

SCHACHT



Cilindrische schacht / Rechte schacht



Cilindrische schacht met lip



Morseconus schacht



Cilindrische schacht met spanvlak



Cilindrische eenheidsschacht



Gereduceerde cilindrische schacht

SPAANGROEFVORM



Sterk gespiraliseerd



Standaard spiraalhoek



Kernuitdunning over de gehele lengte



Flauw gespiraliseerd



Sterk gespiraliseerd

VA

Speciaal uitgedunde ziel

BOORDIEPTE ZONDER LOSSEN (ULDR)

1.25×D

1.25×D (factor x diameter)

2.5×D

2.5×D (factor x diameter)

5×D

5×D (factor x diameter)

1.5×D

1.5×D (factor x diameter)

20×D

20×D (factor x diameter)

6×D

6×D (factor x diameter)

10×D

10×D (factor x diameter)

25×D

25×D (factor x diameter)

8×D

8×D (factor x diameter)

15×D

15×D (factor x diameter)

3×D

3×D (factor x diameter)

1×D

1×D (factor x diameter)

4×D

4×D (factor x diameter)



VOLHARDMETAAL BOREN



VEELZIJDIGE PRODUCTIEBOREN VOOR EEN BREED SCALA AAN MATERIALEN

FORCE X hardmetalen boren zijn ontwikkeld voor hoogwaardige verspaningstoepassingen in een grote verscheidenheid aan materialen. Zoals koolstof en gelegeerde staalsoorten tot 1500 MPa en gietijzer. FORCE X boren presteren ook goed in roestvast staal en aluminium waardoor ze een ideale eerste keuze zijn voor toeleveranciers in de verspaningsindustrie.

KENMERKEN & VOORDELEN

- CTW  - Unieke spaangroefconstructie met een continu verdunde kern en afgeronde hiel.
- Gewijzigde 4 vlaks Split Point met grote secundaire dwarssnijkantshoek.
- Hoogwaardig microkorrelig hardmetaalsoort met TiAlN coating.
- 3xD en 5xD, met of zonder koelkanalen.
- 8xD met koelkanalen.

IN VERGELIJKING MET CONVENTIONELE BOREN ZIJN DE FORCE X:

- Uitzonderlijk economisch - gemakkelijker en veelvoudige herslijp mogelijkheid waardoor de totale standtijd aanzienlijk wordt verhoogd.
- Continue hoge kwaliteit en prestaties - met uitstekende positioneernauwkeurigheid en spaanafvoer, die bijdragen aan een uitstekende gatkwaliteit qua maatvoering en afwerking.
- Productiever - met hoge boorsnelheden en langere standtijd van het gereedschap.



RANGE DETAILS

3xD



R457
met koelkanalen

R458
zonder koelkanalen

- 3.00 – 20.00 mm
- 1/8 – 3/4 inch, N30 – N1, A – Z

5xD



R453
met koelkanalen

R454
zonder koelkanalen

- 3.00 – 20.00 mm
- 1/8 – 3/4 inch, N30 – N1, A – Z

8xD



R459
met koelkanalen

- 3.00 – 16.00 mm
- 1/8 – 5/8 inch



BEWERKINGSVOORBEELDEN

			Automatenstaal	Gelegeerd staal	Gietijzer
Werkstukmateriaal			1.0718 (11SMnPb30)	1.6582 (34CrNiMo6)	0.6025 (GG-25)
Hardheid		HB	180	325	215
Treksterkte		MPa	620	1120	260
Diameter		mm	8 (R4578.0)	8 (R4598.0)	8 (R4538.0)
Gatdiepte		mm	3×D (24)	8×D (64)	5×D (40)
Snij snelheid	v_c	m/min	207	73	77
Voeding	f	mm/omw	0.26	0.14	0.26
Koeling			Emulsie 8% inwendige koeling	Emulsie 8% inwendige koeling	Emulsie 8% inwendige koeling



FORCE M

VHM BOREN VOOR HOGE PRESTATIES

BOREN VOOR HOGE PRODUCTIVITEIT IN ROESTVAST STAAL

FORCE M hardmetalen boren zijn ontworpen om de hoogste prestaties en procesbetrouwbaarheid bij het boren te bieden in roestvast staal en hittebestendige superlegeringen. FORCE M boren zijn ideaal voor toepassingen waar het noodzakelijk is om een groot aantal gaten te boren met een hoge en constante nauwkeurigheid.

KENMERKEN & VOORDELEN

- CTW  - Unieke spaangroefconstructie met een continu verdunde kern en afgeronde hiel.
- S vormige 4-vlaks Split Point met een nauwkeurig geslepen en sterke snijkant.
- 3xD en 5xD met koelkanalen.
- 8xD met koelkanalen is op aanvraag leverbaar.

VERGELEKEN MET GANGBARE VHM BOREN BIEDT DE FORCE M:

- Betrouwbare prestaties bij een soepel boorproces waardoor materiaalverharding voorkomen wordt.
- Geoptimaliseerde productiviteit - met uitstekende spaanvorming en afvoer waardoor een betere krachtenverdeling hogere voedingssnelheden mogelijk maakt.
- Exceptionele standtijd - door sterkere snijhoek en snijkanten om plastische deformatie tegen te gaan.



RANGE DETAILS

3xD



R467

met koelkanalen

- 3.00 – 16.00 mm
- 1/8 – 5/8 inch

5xD



R463

met koelkanalen

- 3.00 – 16.00 mm
- 1/8 – 5/8 inch

8xD



R469

met koelkanalen

- Op aanvraag leverbaar
- 3.00 – 16.00 mm
 - 1/8 – 5/8 inch



BEWERKINGSVOORBEELDEN

			Ferritisch RVS	Austenitisch RVS	Hooggelegerd RVS
Werkstukmateriaal			1.4104 (AISI 430F)	1.4401 (AISI 316)	1.4501 (Super DUPLEX)
Hardheid		HB	220	200	240
Treksterkte		MPa	700	750	770
Diameter		mm	8 (R4678.0)	8 (S-R4698.0)	8 (R4638.0)
Gatdiepte		mm	3xD (24)	8xD (64)	5xD (40)
Snij snelheid	v_c	m/min	99	74	57
Voeding	f	mm/omw	0.16	0.14	0.12
Koeling			Emulsie 8% inwendige koeling	Emulsie 8% inwendige koeling	Emulsie 8% inwendige koeling



FORCE N

VHM BOREN VOOR HOGE PRESTATIES

HOGE VOEDINGSSNELHEDEN IN ALUMINIUM

FORCE N hardmetalen boren worden aanbevolen voor hogesnelheidsboren in smeed- en gegoten aluminiumlegeringen. De spaangroeven en snijgeometrie zijn speciaal ontworpen om de spaan in kleine, hanteerbare spanen te breken om de spaanafvoer te verbeteren.

FORCE N boren bieden uitstekende prestaties en een lange standtijd voor middelgrote en grote productiebedrijven.

KENMERKEN & VOORDELEN

- Speciale webverduunning met een grotere spiraalhoek dan gebruikelijk.
- Unieke geometrie met convexe snijkanten en een 4-vlaks zelfcenterende punt.
- Hoogwaardig microkorrelig hardmetaalsoort met gepolijste afwerking.
- Alle Force N boren zijn op aanvraag leverbaar.

IN VERGELIJKING MET GEBRUIKELIJKE BOREN BIEDT FORCE N:

- Uitstekende prestaties - bij hoge boorsnelheden en lange standtijd.
- Economische oplossing - die voor alle toepassingen kan worden gebruikt in aluminiumsoorten, van zacht tot abrasief.
- Geoptimaliseerd proces - ontworpen om de boordruk te verlagen en het verbeteren van de kwaliteit van de gaten en het verminderen van de uitgangsbraam die optreedt bij het boren van zachte materialen.

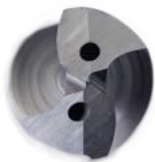

RANGE DETAILS

5xD



R445

met koelkanalen

Op aanvraag leverbaar

- 3.00 – 16.00 mm
- 1/8 – 5/8 inch

8xD



R448

met koelkanalen

Op aanvraag leverbaar

- 3.00 – 16.00 mm
- 1/8 – 5/8 inch

Tot

12xD

Langere lengtes zijn op aanvraag leverbaar



BEWERKINGSVOORBEELD

			Kneedaluminium	Gietaluminium
Werkstukmateriaal			AW 2024-O (3.1355)	A242.0
Hardheid		HB	50	75
Treksterkte		MPa	200	220
Diameter		mm	8 mm (R4458.0)	8 mm (S-R4488.0)
Gatdiepte		mm	5xD (40)	8xD (64)
Snij snelheid	v_c	m/min	357	374
Voeding	f	mm/omw	0.80	0.33
Koeling			Emulsie 8% inwendige koeling	Emulsie 8% inwendige koeling

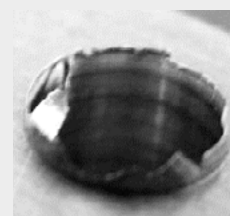

Uitgangsbraam met gebruikelijke boor

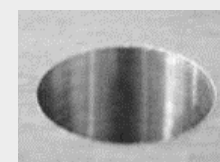

Uitgangsbraam met FORCE N boor



DORMER PRAMET

VOLG ONS



SHARE



LIKE



COMMENT



TAG



RE-TWEET







VOLHARDMETAAL BOREN – NAVIGATOR BASISMATERIAAL

Basismateriaal

Hardmetaal		<p>Een gesinterd poedermetallurgisch substraat, bestaande uit een metalen volhardmetalen composiet met bindmiddelmetaal. Het meest centrale ruwe materiaal is wolfram carbide (WC). Wolfram carbide draagt bij aan de hardheid van het materiaal. Tantaal carbide (TaC), titaan carbide (TiC) en niobium carbide (NbC) vullen WC aan en passen de eigenschap aan de gewenste eigenschappen aan. Deze drie materialen worden kubische carbides genoemd. Kobalt (Co) fungeert als een bindmiddel en houdt het materiaal bij elkaar.</p> <p>Carbidematerialen worden vaak gekenmerkt door hoge compressiesterkte, hoge hardheid en daardoor hoge slijtvastheid, maar ook door beperkte buigsterkte en taaiheid. Carbide wordt gebruikt in tappen, ruimers, frezen, boren en draadfrezen.</p>
-------------------	---	---

Oppervlak

Blank (ongecoat)		<p>Blanke uitvoering (niet-gecoat oppervlak) verbetert de spaanafvoer bij zachte of non-ferro materialen en behoudt scherpe snijkanten in slijtvaste materialen.</p>
Titanium Nitride coating (TiN)		<p>Titaniumnitride is een goudkleurige keramische coating die wordt toegepast door fysieke dampafzetting (PVD). Hoge hardheid in combinatie met lage wrijvingseigenschappen zorgt voor aanzienlijk langere standtijd of betere snijprestaties van gereedschappen die niet zijn gecoat. TiN coatings worden voornamelijk gebruikt voor boren en tappen.</p>
Titanium Aluminium Nitride coating (TiAlN)		<p>Titaanaluminiumnitride is een multilaags keramische coating die wordt aangebracht door PVD-coatingtechnologie en wordt gekenmerkt door hoge taaiheid en oxidatiestabiliteit. Deze eigenschappen maken het ideaal voor hogere snelheden en voedingen, terwijl de standtijd van het gereedschap wordt verbeterd. TiAlN wordt gebruikt bij boor-, tap- en freestoeppassingen en is geschikt voor gebruik bij bewerkingen zonder koelmiddel. TiAlN-Top coating is dezelfde als TiAlN, maar met een post-coatingproces dat uitgevoerd wordt om onzuiverheden te vereffenen en daardoor de spaanafvoer te verbeteren en de kans op aanhechting aan de snijkanten te verlagen.</p>



Basismateriaal (BMC)	HM	HM	HM	HM	HM	HM	HM	HM	HM	HM	HM	HM	HM
Productienorm (BSG)	DIN 333A	DORMER	DORMER	DORMER	DORMER	DORMER	DIN 6539	DIN 338	DIN 6539	DIN 338	DIN 6537K	DIN 6537K	DIN 6537L
Boordiepte zonder lossen (ULDR)	1xD	1xD	1xD	1xD	1xD	3xD	2.5xD	4xD	2.5xD	4xD	3xD	3xD	5xD
Tophoek	60°	120°	90°	150°	90°	90°	120°	120°	130°	130°	140°	140°	140°
Coating	Bright	Bright	Bright	TIAIN	TIAIN	TIAIN	Bright	Bright	TIN	TIN	TIAIN	TIAIN	TIAIN
Schacht					DIN 6535HA	DIN 6535HA					DIN 6535HA	DIN 6535HA	DIN 6535HA
Spiraalvorm		λ 20-35°	λ 20-35°	λ 20-35°	λ 20-35°	λ 20-35°	λ 20-35°	λ 20-35°	λ 20-35°	λ 20-35°	CTW	CTW	CTW
Snijrichting	R	R	R	R	R	R	R	R	R	R	R	R	R
Koeling (CSP)													
Productfamiliecode	R200	R122	R123	R125	R6011	R7131	R120	R100	R520	R510	R458	R457	R454
	1.00 - 5.00	5.00 - 20.00	5.00 - 20.00	6.00 - 16.00	6.00 - 16.00	3.30 - 10.40	1.00 - 12.00	1.00 - 14.00	3.00 - 16.50	3.00 - 14.25	3.00 - 20.00	3.00 - 20.00	3.00 - 20.00
	26	27	28	29	30	31	32	34	36	38	40	44	48
P	P1	■	■	■	■	■	■	■	■	■	■	■	■
	P2	■	■	■	■	■	■	■	■	■	■	■	■
	P3	■	■	■	■	■	■	■	■	■	■	■	■
	P4	■	■	■	■	■	■	■	■	■	■	■	■
M	M1		■	■	■	■			■	■	■	■	■
	M2		■	■	■	■			■	■	■	■	■
	M3		■	■	■	■				■	■	■	■
	M4										■	■	■
K	K1	■	■	■	■	■	■	■	■	■	■	■	■
	K2	■	■	■	■	■	■	■	■	■	■	■	■
	K3	■	■	■	■	■	■	■	■	■	■	■	■
	K4	■	■	■	■	■	■	■	■	■	■	■	■
	K5	■	■	■	■	■	■	■	■	■	■	■	■
N	N1	■	■	■	■	■	■	■	■	■	■	■	■
	N2	■	■	■	■	■	■	■	■	■	■	■	■
	N3	■	■	■	■	■	■	■	■	■	■	■	■
	N4		■	■	■	■		■		■		■	■
	N5												
S	S1		■	■	■	■	■	■	■	■	■	■	■
	S2		■	■	■	■	■	■					
	S3		■	■	■	■	■	■					
	S4		■	■	■	■	■	■					
H	H1		■	■	■	■	■	■	■	■	■	■	■
	H2		■	■	■	■	■	■	■	■	■	■	■
	H3		■	■	■	■	■	■	■	■	■	■	■
	H4												

■ Geschikt ■ Beperkt geschikt

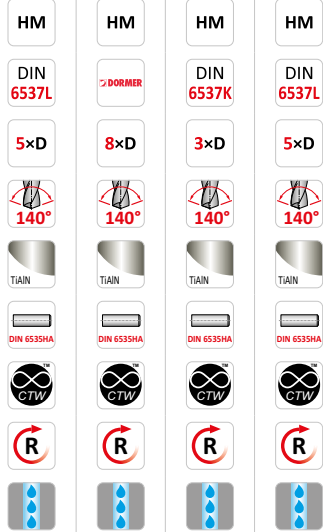

R453 R459 R467 R463

3.00 - 20.00 3.00 - 16.00 3.00 - 16.00 3.00 - 16.00

52 56 59 62

P1	■	■		
P2	■	■		
P3	■	■		
P4	■	■		
M1	▣	▣	■	■
M2	▣	▣	■	■
M3	▣	▣	■	■
M4	▣	▣	■	■
K1	■	■		
K2	■	■		
K3	■	■		
K4	■	■		
K5	■	■		
N1	■	▣		
N2	■	■		
N3	■	▣		
N4				
N5				
S1	■		■	■
S2			▣	▣
S3			▣	▣
S4			▣	▣
H1	■			
H2	▣			
H3	▣			
H4				



R200



VHM centerboor 118° tophoek en 60° centreerhoek

Centerboor voor het maken van een nauwkeurig gat in het uiteinde van een as, zodat deze vervolgens stabiel kan worden opgespannen om bewerkt te worden. Geschikt voor het bewerken van een aantal materialen en heeft twee booruiteinden voor een hogere productiviteit per gereedschap. Met 118° tophoek en 60° verzinking. Geschikt voor alle CNC machines.

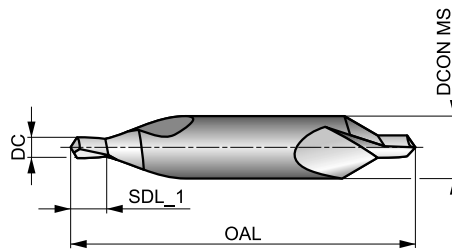

HM	DIN 333A	1xD
60°	Bright	
R		

De tabel geeft de geschiktheid aan voor de materiaalgroep en de startwaarden voor de snijsnelheid (m/min) en de letter verwijst naar de toe te passen voeding (fn), zie vanaf pagina 65.

P1.1 ■ 60 H	P1.2 ■ 67 H	P1.3 ■ 69 H	P2.1 ■ 51 H	P2.2 ■ 45 F	P2.3 ■ 40 D	P3.1 ■ 44 E	P3.2 ■ 36 E	P3.3 ■ 30 D	P4.1 ■ 26 E	P4.2 ■ 22 D	P4.3 ■ 18 C	K1.1 ■ 40 H	K1.2 ■ 30 E
K1.3 ■ 22 E	K2.1 ■ 37 D	K2.2 ■ 30 D	K2.3 ■ 24 D	K3.1 ■ 33 D	K3.2 ■ 25 D	K3.3 ■ 20 D	K4.1 ■ 30 D	K4.2 ■ 23 D	K4.3 ■ 17 D	K4.4 ■ 14 D	K4.5 ■ 12 D	K5.1 ■ 34 D	K5.2 ■ 26 D
K5.3 ■ 20 D	N1.1 ■ 120 I	N1.2 ■ 90 I	N1.3 ■ 60 H	N2.1 ■ 154 G	N2.2 ■ 138 G	N2.3 ■ 100 G	N3.1 ■ 169 G	N3.2 ■ 100 H	N3.3 ■ 50 F				

Product	DC	DC	SDL_1	OAL	DCON MS
	(mm)	(inch)			
R2001.0X3.15	1.00	0.0394	1.7 - 1.3	31.0	3.15
R2001.25X3.15	1.25	0.0492	2.0 - 1.6	31.0	3.15
R2001.6X4.0	1.60	0.0630	2.6 - 2.0	35.0	4.00
R2002.0X5.0	2.00	0.0787	3.1 - 2.5	40.0	5.00
R2002.5X6.3	2.50	0.0984	3.8 - 3.1	45.0	6.30
R2003.15X8.0	3.15	0.1240	4.6 - 3.9	50.0	8.00
R2004.0X10.0	4.00	0.1575	5.9 - 5.0	55.0	10.00
R2005.0X12.5	5.00	0.1969	7.2 - 6.3	63.0	12.50



R122



VHM NC centreerboor 120°

De precisie geslepen boorpunt voor een nauwkeurige positionering van het te boren gat. Een tophoek van 120° helpt bij de zelfcentrerend en vermindert de snijkrachten bij het boren in diverse materialen.

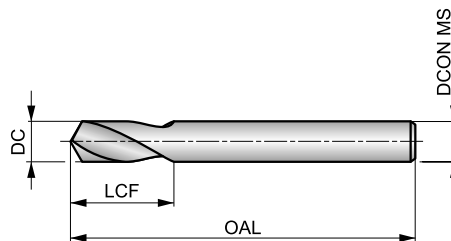

HM	DORMER	1xD
120°	Bright	
λ 20-35°	R	DC h6

De tabel geeft de geschiktheid aan voor de materiaalgroep en de startwaarden voor de snijnsnelheid (m/min) en de letter verwijst naar de toe te passen voeding (fn), zie vanaf pagina 65.

P1.1 ■ 99 S	P1.2 ■ 111 S	P1.3 ■ 115 S	P2.1 ■ 85 S	P2.2 ■ 75 S	P2.3 ■ 66 S	P3.1 ■ 66 S	P3.2 ■ 53 S	P3.3 ■ 45 S	P4.1 ■ 40 S	P4.2 ■ 34 S	P4.3 ■ 27 S	M1.1 ■ 73 S	M1.2 ■ 61 S
M2.1 ■ 65 S	M2.2 ■ 53 S	M3.1 ■ 52 S	M3.2 ■ 45 S	K1.1 ■ 75 T	K1.2 ■ 56 T	K1.3 ■ 42 T	K2.1 ■ 68 T	K2.2 ■ 55 T	K2.3 ■ 44 T	K3.1 ■ 60 T	K3.2 ■ 46 T	K3.3 ■ 37 T	K4.1 ■ 55 T
K4.2 ■ 42 T	K4.3 ■ 31 T	K4.4 ■ 26 T	K4.5 ■ 22 T	K5.1 ■ 63 T	K5.2 ■ 47 T	K5.3 ■ 37 T	N1.1 ■ 200 V	N1.2 ■ 150 V	N1.3 ■ 100 V	N2.1 ■ 172 V	N2.2 ■ 155 V	N2.3 ■ 112 V	N3.1 ■ 423 V
N3.2 ■ 250 V	N3.3 ■ 125 V	N4.1 ■ 60 X	N4.2 ■ 100 V	S1.1 ■ 45 T	S1.2 ■ 35 T	S1.3 ■ 25 S	S2.1 ■ 40 S	S2.2 ■ 28 S	S3.1 ■ 30 S	S3.2 ■ 20 S	S4.1 ■ 23 S	S4.2 ■ 16 S	H1.1 ■ 56 S
H2.1 ■ 33 S	H2.2 ■ 36 S	H3.1 ■ 37 S	H3.2 ■ 30 S										

Product	DC	DC	LCF	OAL	DCON MS
	(mm)	(inch)	(mm)	(mm)	(mm)
R1225.0	5.00	0.1969	16.0	62.0	5.00
R1226.0	6.00	0.2362	17.0	66.0	6.00
R1228.0	8.00	0.3150	22.0	79.0	8.00
R12210.0	10.00	0.3937	26.0	89.0	10.00
R12212.0	12.00	0.4724	30.0	102.0	12.00
R12216.0	16.00	0.6299	34.0	115.0	16.00
R12220.0	20.00	0.7874	40.0	131.0	20.00



R123



VHM NC centreerboor 90°

De precisie geslepen boorpunt voor een nauwkeurige positionering van het te boren gat. Een tophoek van 90° helpt bij de zelfcentrerend en vermindert de snijkrachten bij het boren in diverse materialen.

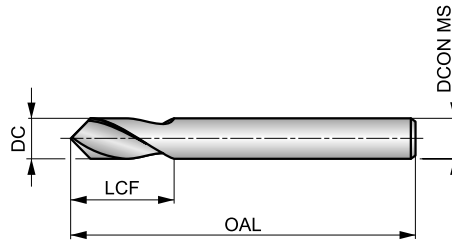

HM	DORMER	1xD
90°	Bright	
λ 20-35°	R	DC h6

De tabel geeft de geschiktheid aan voor de materiaalgroep en de startwaarden voor de snijsnelheid (m/min) en de letter verwijst naar de toe te passen voeding (fn), zie vanaf pagina 65.

P1.1 ■ 99 S	P1.2 ■ 111 S	P1.3 ■ 115 S	P2.1 ■ 85 S	P2.2 ■ 75 S	P2.3 ■ 66 S	P3.1 ■ 66 S	P3.2 ■ 53 S	P3.3 ■ 45 S	P4.1 ■ 40 S	P4.2 ■ 34 S	P4.3 ■ 27 S	M1.1 ■ 73 S	M1.2 ■ 61 S
M2.1 ■ 65 S	M2.2 ■ 53 S	M3.1 ■ 52 S	M3.2 ■ 45 S	K1.1 ■ 75 T	K1.2 ■ 56 T	K1.3 ■ 42 T	K2.1 ■ 68 T	K2.2 ■ 55 T	K2.3 ■ 44 T	K3.1 ■ 60 T	K3.2 ■ 46 T	K3.3 ■ 37 T	K4.1 ■ 55 T
K4.2 ■ 42 T	K4.3 ■ 31 T	K4.4 ■ 26 T	K4.5 ■ 22 T	K5.1 ■ 63 T	K5.2 ■ 47 T	K5.3 ■ 37 T	N1.1 ■ 200 V	N1.2 ■ 150 V	N1.3 ■ 100 V	N2.1 ■ 172 V	N2.2 ■ 155 V	N2.3 ■ 112 V	N3.1 ■ 423 V
N3.2 ■ 250 V	N3.3 ■ 125 V	N4.1 ■ 60 X	N4.2 ■ 100 V	S1.1 ■ 45 T	S1.2 ■ 35 T	S1.3 ■ 25 S	S2.1 ■ 40 S	S2.2 ■ 28 S	S3.1 ■ 30 S	S3.2 ■ 20 S	S4.1 ■ 23 S	S4.2 ■ 16 S	H1.1 ■ 56 S
H2.1 ■ 33 S	H2.2 ■ 36 S	H3.1 ■ 37 S	H3.2 ■ 30 S										

Product	DC	DC	LCF	OAL	DCON MS
	(mm)	(inch)	(mm)	(mm)	(mm)
R1235.0	5.00	0.1969	16.0	62.0	5.00
R1236.0	6.00	0.2362	17.0	66.0	6.00
R1238.0	8.00	0.3150	22.0	79.0	8.00
R12310.0	10.00	0.3937	26.0	89.0	10.00
R12312.0	12.00	0.4724	30.0	102.0	12.00
R12316.0	16.00	0.6299	34.0	115.0	16.00
R12320.0	20.00	0.7874	40.0	131.0	20.00

NEW**R125****DORMER****VHM NC centreerboor 150°, TiALN gecoat**

De precisie geslepen boorpunt voor een nauwkeurige positionering van het te boren gat. Een tophoek van 150° helpt bij de zelfcentrerend en vermindert de snijkrachten bij het boren in diverse materialen. TiAlN coating verbetert de prestaties en verlengt de standtijd.

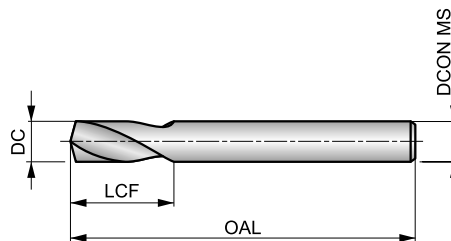

HM	DORMER	1×D
150°	TiAlN	
λ 20-35°	R	DC h6

De tabel geeft de geschiktheid aan voor de materiaalgroep en de startwaarden voor de snijsnelheid (m/min) en de letter verwijst naar de toe te passen voeding (fn), zie vanaf pagina 65.

P1.1 ■ 119 S	P1.2 ■ 134 S	P1.3 ■ 138 S	P2.1 ■ 102 S	P2.2 ■ 90 S	P2.3 ■ 80 S	P3.1 ■ 81 S	P3.2 ■ 65 S	P3.3 ■ 55 S	P4.1 ■ 48 S	P4.2 ■ 41 S	P4.3 ■ 34 S	M1.1 ■ 82 S	M1.2 ■ 70 S
M2.1 ■ 73 S	M2.2 ■ 60 S	M3.1 ■ 58 S	M3.2 ■ 50 S	K1.1 ■ 80 T	K1.2 ■ 59 T	K1.3 ■ 44 T	K2.1 ■ 86 T	K2.2 ■ 70 T	K2.3 ■ 56 T	K3.1 ■ 76 T	K3.2 ■ 58 T	K3.3 ■ 47 T	K4.1 ■ 71 T
K4.2 ■ 53 T	K4.3 ■ 39 T	K4.4 ■ 33 T	K4.5 ■ 28 T	K5.1 ■ 80 T	K5.2 ■ 60 T	K5.3 ■ 46 T	N1.1 ■ 200 V	N1.2 ■ 150 V	N1.3 ■ 100 V	N2.1 ■ 172 V	N2.2 ■ 155 V	N2.3 ■ 112 V	N3.1 ■ 423 V
N3.2 ■ 250 V	N3.3 ■ 125 V	N4.1 ■ 60 X	N4.2 ■ 100 V	S1.1 ■ 55 T	S1.2 ■ 45 T	S1.3 ■ 35 S	S2.1 ■ 53 S	S2.2 ■ 42 S	S3.1 ■ 40 S	S3.2 ■ 30 S	S4.1 ■ 31 S	S4.2 ■ 24 S	H1.1 ■ 56 S
H2.1 ■ 33 S	H2.2 ■ 36 S	H3.1 ■ 37 S	H3.2 ■ 30 S										

DCON MS passing h6.

Product	DC (mm)	LCF (mm)	OAL (mm)	DCON MS (mm)
R1255.0	5.00	16.0	62.0	5.00
R1256.0	6.00	17.0	66.0	6.00
R1258.0	8.00	22.0	79.0	8.00
R12510.0	10.00	26.0	89.0	10.00
R12512.0	12.00	30.0	102.0	12.00
R12516.0	16.00	34.0	115.0	16.00



R6011



VHM NC centreerboor, 90°, TiAlN gecoat

De precisie geslepen punt biedt een nauwkeurige positionering voor het te boren gat. Een punt van 90° helpt bij de zelfcentrerend en vermindert de snijkrachten bij het boren in het materiaal. TiAlN coating verbetert de prestaties en verlengt de standtijd. Geschikt voor vele materialen.

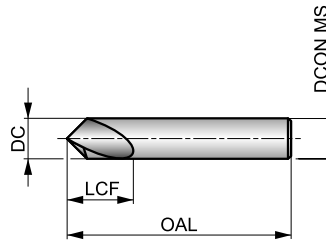

HM	DORMER	1xD
90°	TiAlN	DIN 6535HA
λ 20-35°	R	DC h6

De tabel geeft de geschiktheid aan voor de materiaalgroep en de startwaarden voor de snijsnelheid (m/min) en de letter verwijst naar de toe te passen voeding (fn), zie vanaf pagina 65.

P1.1 ■ 119 S	P1.2 ■ 134 S	P1.3 ■ 138 S	P2.1 ■ 102 S	P2.2 ■ 90 S	P2.3 ■ 80 S	P3.1 ■ 81 S	P3.2 ■ 65 S	P3.3 ■ 55 S	P4.1 ■ 48 S	P4.2 ■ 41 S	P4.3 ■ 34 S	M1.1 ■ 82 S	M1.2 ■ 70 S
M2.1 ■ 73 S	M2.2 ■ 60 S	M3.1 ■ 58 S	M3.2 ■ 50 S	K1.1 ■ 80 T	K1.2 ■ 59 T	K1.3 ■ 44 T	K2.1 ■ 86 T	K2.2 ■ 70 T	K2.3 ■ 56 T	K3.1 ■ 76 T	K3.2 ■ 58 T	K3.3 ■ 47 T	K4.1 ■ 71 T
K4.2 ■ 53 T	K4.3 ■ 39 T	K4.4 ■ 33 T	K4.5 ■ 28 T	K5.1 ■ 80 T	K5.2 ■ 60 T	K5.3 ■ 46 T	N1.1 ■ 200 V	N1.2 ■ 150 V	N1.3 ■ 100 V	N2.1 ■ 172 V	N2.2 ■ 155 V	N2.3 ■ 112 V	N3.1 ■ 423 V
N3.2 ■ 250 V	N3.3 ■ 125 V	N4.1 ■ 60 X	N4.2 ■ 100 V	S1.1 ■ 55 T	S1.2 ■ 45 T	S1.3 ■ 35 S	S2.1 ■ 53 S	S2.2 ■ 42 S	S3.1 ■ 40 S	S3.2 ■ 30 S	S4.1 ■ 31 S	S4.2 ■ 24 S	H1.1 ■ 56 S
H2.1 ■ 33 S	H2.2 ■ 36 S	H3.1 ■ 37 S	H3.2 ■ 30 S										

DCON MS passing h6.

Product	DC	DC	LCF	OAL	DCON MS
	(mm)	(inch)	(mm)	(mm)	(mm)
R60116.0	6.00	0.2362	16.0	50.0	6.00
R601110.0	10.00	0.3937	25.0	70.0	10.00
R601116.0	16.00	0.6299	26.0	90.0	16.00



R7131



VHM trapboor, koelkanalen, TiAlN gecoat

Veelzijdige productieboor voor het boren en afschuiven in één bewerking. Vermindert de cyclustijd en de voorraad gereedschappen. Een tophoek van 140° en een verzinkhoek van 90°. TiAlN coating verbetert de prestaties en verlengt de standtijd. Koelkanalen voor betere spaanafvoer. Geschikt voor het boren van vele materialen.

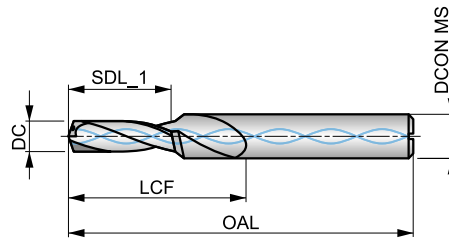

HM	DORMER	3xD
90°	TiAlN	DIN 6535HA
λ 20-35°	R	
DC m7		

De tabel geeft de geschiktheid aan voor de materiaalgroep en de startwaarden voor de snijsnelheid (m/min) en de letter verwijst naar de toe te passen voeding (fn), zie vanaf pagina 65.

P1.1 ■ 139 W	P1.2 ■ 156 W	P1.3 ■ 161 W	P2.1 ■ 119 W	P2.2 ■ 105 W	P2.3 ■ 93 V	P3.1 ■ 96 V	P3.2 ■ 77 V	P3.3 ■ 65 V	P4.1 ■ 57 V	P4.2 ■ 48 V	M1.1 ■ 62 V	M1.2 ■ 52 V	M2.1 ■ 55 V
M2.2 ■ 45 V	M3.1 ■ 47 V	M3.2 ■ 40 V	M3.3 ■ 36 U	M4.1 ■ 35 U	K1.1 ■ 90 W	K1.2 ■ 67 W	K1.3 ■ 50 W	K2.1 ■ 92 V	K2.2 ■ 75 V	K2.3 ■ 60 V	K3.1 ■ 82 V	K3.2 ■ 62 V	K3.3 ■ 50 V
K4.1 ■ 76 V	K4.2 ■ 57 V	K4.3 ■ 42 V	K4.4 ■ 36 V	K4.5 ■ 30 V	K5.1 ■ 86 V	K5.2 ■ 64 V	K5.3 ■ 50 V	N1.1 ■ 250 W	N1.2 ■ 188 W	N1.3 ■ 125 W	N2.1 ■ 308 V	N2.2 ■ 277 V	N2.3 ■ 200 V
N3.1 ■ 373 W	N3.2 ■ 220 W	N3.3 ■ 110 W											

DCON MS passing h6.

Product	DC (mm)	DC (inch)	SDL_1 (mm)	LCF (mm)	OAL (mm)	DCON MS (mm)	TDZ
R71313.3	3.30	0.1299	11.40	20.0	66.0	6.00	M4
R71314.2	4.20	0.1654	13.60	24.0	66.0	6.00	M5
R71315.0	5.00	0.1969	16.50	28.0	79.0	8.00	M6
R71316.8	6.80	0.2677	21.00	34.0	89.0	10.00	M8
R71318.5	8.50	0.3346	25.50	47.0	102.0	12.00	M10
R713110.2	10.20	0.4016	30.00	55.0	107.0	14.00	M12
R713110.4	10.40	0.4094	30.00	55.0	107.0	14.00	M12



R120



VHM extra korte spiraalboor, DIN6539

Verhoogde slijtvastheid voor hogere productiviteit en langere standtijd van het gereedschap. Een 4-vlakspunt van 120° helpt bij de zelfcentering en vermindert de snijkrachten. Kan worden gebruikt in alle stabiele en CNC-machinetoepassingen. Voor het boren in slijtvaste en abrasieve materialen.

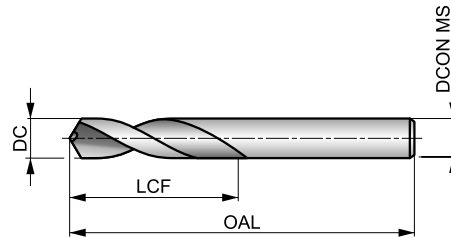

HM	DIN 6539	2.5xD
120°	Bright	
λ 20-35°	R	DC h7

De tabel geeft de geschiktheid aan voor de materiaalgroep en de startwaarden voor de snijnsnelheid (m/min) en de letter verwijst naar de toe te passen voeding (fn), zie vanaf pagina 65.

P1.1 99 S	P1.2 111 S	P1.3 115 S	P2.1 85 S	P2.2 75 S	P2.3 66 S	P3.1 66 S	P3.2 53 S	P3.3 45 S	P4.1 40 S	P4.2 34 S	P4.3 27 S	K1.1 75 U	K1.2 56 U
K1.3 42 U	K2.1 68 U	K2.2 55 U	K2.3 44 U	K3.1 60 U	K3.2 46 U	K3.3 37 U	K4.1 55 U	K4.2 42 U	K4.3 31 U	K4.4 26 U	K4.5 22 U	K5.1 63 U	K5.2 47 U
K5.3 37 U	N1.1 200 W	N1.2 150 W	N1.3 100 W	N2.1 172 W	N2.2 155 W	N2.3 112 W	N3.1 466 W	N3.2 275 W	N3.3 138 W	N4.1 60 U	N4.2 100 U	S1.1 45 T	S1.2 35 T
S1.3 25 T	S2.1 40 T	S2.2 28 T	S3.1 30 T	S3.2 20 T	S4.1 23 T	S4.2 16 T	H1.1 56 S	H2.1 33 S	H2.2 36 S	H3.1 37 S	H3.2 30 S		

Product	DC	DC	LCF	OAL	DCON MS
	(mm)	(inch)			
R1201.0	1.00	0.0394	6.0	26.0	1.00
R1201.1	1.10	0.0433	7.0	28.0	1.10
R1201.2	1.20	0.0472	8.0	30.0	1.20
R1201.3	1.30	0.0512	8.0	30.0	1.30
R1201.4	1.40	0.0551	9.0	32.0	1.40
R1201.5	1.50	0.0591	9.0	32.0	1.50
R1201.6	1.60	0.0630	10.0	34.0	1.60
R1201.7	1.70	0.0669	10.0	34.0	1.70
R1201.8	1.80	0.0709	11.0	36.0	1.80
R1201.9	1.90	0.0748	11.0	36.0	1.90
R1202.0	2.00	0.0787	12.0	38.0	2.00
R1202.1	2.10	0.0827	12.0	38.0	2.10
R1202.2	2.20	0.0866	13.0	40.0	2.20
R1202.3	2.30	0.0906	13.0	40.0	2.30
R1202.4	2.40	0.0945	14.0	43.0	2.40
R1202.5	2.50	0.0984	14.0	43.0	2.50
R1202.6	2.60	0.1024	14.0	43.0	2.60
R1202.7	2.70	0.1063	16.0	46.0	2.70
R1202.8	2.80	0.1102	16.0	46.0	2.80
R1202.9	2.90	0.1142	16.0	46.0	2.90
R1203.0	3.00	0.1181	16.0	46.0	3.00
R1203.1	3.10	0.1220	18.0	49.0	3.10
R1203.2	3.20	0.1260	18.0	49.0	3.20
R1203.3	3.30	0.1299	18.0	49.0	3.30
R1203.4	3.40	0.1339	20.0	52.0	3.40
R1203.5	3.50	0.1378	20.0	52.0	3.50

Product	DC	DC	LCF	OAL	DCON MS
	(mm)	(inch)			
R1203.6	3.60	0.1417	20.0	52.0	3.60
R1203.7	3.70	0.1457	20.0	52.0	3.70
R1203.8	3.80	0.1496	22.0	55.0	3.80
R1203.9	3.90	0.1535	22.0	55.0	3.90
R1204.0	4.00	0.1575	22.0	55.0	4.00
R1204.1	4.10	0.1614	22.0	55.0	4.10
R1204.2	4.20	0.1654	22.0	55.0	4.20
R1204.3	4.30	0.1693	24.0	58.0	4.30
R1204.4	4.40	0.1732	24.0	58.0	4.40
R1204.5	4.50	0.1772	24.0	58.0	4.50
R1204.6	4.60	0.1811	24.0	58.0	4.60
R1204.7	4.70	0.1850	24.0	58.0	4.70
R1204.8	4.80	0.1890	26.0	62.0	4.80
R1204.9	4.90	0.1929	26.0	62.0	4.90
R1205.0	5.00	0.1969	26.0	62.0	5.00
R1205.1	5.10	0.2008	26.0	62.0	5.10
R1205.2	5.20	0.2047	26.0	62.0	5.20
R1205.3	5.30	0.2087	26.0	62.0	5.30
R1205.4	5.40	0.2126	28.0	66.0	5.40
R1205.5	5.50	0.2165	28.0	66.0	5.50
R1205.6	5.60	0.2205	28.0	66.0	5.60
R1205.7	5.70	0.2244	28.0	66.0	5.70
R1205.8	5.80	0.2283	28.0	66.0	5.80
R1205.9	5.90	0.2323	28.0	66.0	5.90
R1206.0	6.00	0.2362	28.0	66.0	6.00
R1206.1	6.10	0.2402	31.0	70.0	6.10



Product	DC	DC	LCF	OAL	DCON MS
	(mm)	(inch)	(mm)	(mm)	(mm)
R1206.2	6.20	0.2441	31.0	70.0	6.20
R1206.3	6.30	0.2480	31.0	70.0	6.30
R1206.4	6.40	0.2520	31.0	70.0	6.40
R1206.5	6.50	0.2559	31.0	70.0	6.50
R1206.6	6.60	0.2598	31.0	70.0	6.60
R1206.7	6.70	0.2638	31.0	70.0	6.70
R1206.8	6.80	0.2677	34.0	74.0	6.80
R1206.9	6.90	0.2717	34.0	74.0	6.90
R1207.0	7.00	0.2756	34.0	74.0	7.00
R1207.1	7.10	0.2795	34.0	74.0	7.10
R1207.2	7.20	0.2835	34.0	74.0	7.20
R1207.3	7.30	0.2874	34.0	74.0	7.30
R1207.4	7.40	0.2913	34.0	74.0	7.40
R1207.5	7.50	0.2953	34.0	74.0	7.50
R1207.6	7.60	0.2992	37.0	79.0	7.60
R1207.7	7.70	0.3031	37.0	79.0	7.70
R1207.8	7.80	0.3071	37.0	79.0	7.80
R1207.9	7.90	0.3110	37.0	79.0	7.90
R1208.0	8.00	0.3150	37.0	79.0	8.00
R1208.1	8.10	0.3189	37.0	79.0	8.10
R1208.2	8.20	0.3228	37.0	79.0	8.20
R1208.3	8.30	0.3268	37.0	79.0	8.30

Product	DC	DC	LCF	OAL	DCON MS
	(mm)	(inch)	(mm)	(mm)	(mm)
R1208.4	8.40	0.3307	37.0	79.0	8.40
R1208.5	8.50	0.3346	37.0	79.0	8.50
R1208.6	8.60	0.3386	40.0	84.0	8.60
R1208.7	8.70	0.3425	40.0	84.0	8.70
R1208.8	8.80	0.3465	40.0	84.0	8.80
R1208.9	8.90	0.3504	40.0	84.0	8.90
R1209.0	9.00	0.3543	40.0	84.0	9.00
R1209.1	9.10	0.3583	40.0	84.0	9.10
R1209.2	9.20	0.3622	40.0	84.0	9.20
R1209.3	9.30	0.3661	40.0	84.0	9.30
R1209.4	9.40	0.3701	40.0	84.0	9.40
R1209.5	9.50	0.3740	40.0	84.0	9.50
R1209.6	9.60	0.3780	43.0	89.0	9.60
R1209.7	9.70	0.3819	43.0	89.0	9.70
R1209.8	9.80	0.3858	43.0	89.0	9.80
R1209.9	9.90	0.3898	43.0	89.0	9.90
R12010.0	10.00	0.3937	43.0	89.0	10.00
R12010.2	10.20	0.4016	43.0	89.0	10.20
R12010.5	10.50	0.4134	43.0	89.0	10.50
R12011.0	11.00	0.4331	47.0	95.0	11.00
R12011.5	11.50	0.4528	47.0	95.0	11.50
R12012.0	12.00	0.4724	51.0	102.0	12.00



R100



VHM korte spiraalboor, DIN338

Verhoogde slijtvastheid voor hogere productiviteit en langere standtijd van het gereedschap. Een 4-vlakspunt van 120° helpt bij de zelfcentering en vermindert de snijkrachten. Kan worden gebruikt in alle stabiele en CNC-machinetoepassingen. Voor het boren in slijtvaste en abrasieve materialen.

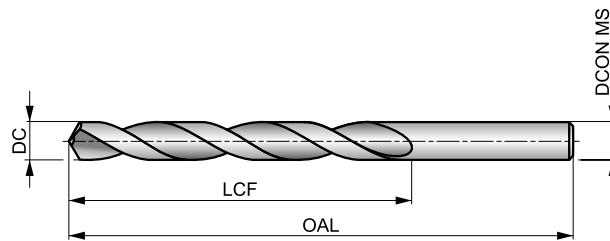

HM	DIN 338	4xD
120°	Bright	
λ 20-35°	R	DC h7

De tabel geeft de geschiktheid aan voor de materiaalgroep en de startwaarden voor de snijnsnelheid (m/min) en de letter verwijst naar de toe te passen voeding (fn), zie vanaf pagina 65.

P1.1 □99 S	P1.2 □111 S	P1.3 □115 S	P2.1 □85 S	P2.2 □75 S	P2.3 □66 S	P3.1 □66 S	P3.2 □53 S	P3.3 □45 S	P4.1 □40 S	P4.2 □34 S	P4.3 □27 S	K1.1 □75 T	K1.2 □56 T
K1.3 □42 T	K2.1 □68 T	K2.2 □55 T	K2.3 □44 T	K3.1 □60 T	K3.2 □46 T	K3.3 □37 T	K4.1 □55 T	K4.2 □42 T	K4.3 □31 T	K4.4 □26 T	K4.5 □22 T	K5.1 □63 T	K5.2 □47 T
K5.3 □37 T	N1.1 □200 V	N1.2 □150 V	N1.3 □100 V	N2.1 □172 V	N2.2 □155 V	N2.3 □112 V	N3.1 ■423 V	N3.2 ■250 V	N4.1 ■60 X	N4.2 ■100 V	H1.1 □56 S	H2.1 □33 S	H2.2 □36 S
H3.1 □37 S	H3.2 □30 S												

Product	DC (mm)	DC (inch)	LCF (mm)	OAL (mm)	DC ON MS (mm)
R1001.0	1.00	0.0394	12.0	34.0	1.00
R1001.1	1.10	0.0433	14.0	36.0	1.10
R1001.2	1.20	0.0472	16.0	38.0	1.20
R1001.3	1.30	0.0512	16.0	38.0	1.30
R1001.4	1.40	0.0551	18.0	40.0	1.40
R1001.5	1.50	0.0591	18.0	40.0	1.50
R1001.6	1.60	0.0630	20.0	43.0	1.60
R1001.7	1.70	0.0669	20.0	43.0	1.70
R1001.8	1.80	0.0709	22.0	46.0	1.80
R1001.9	1.90	0.0748	22.0	46.0	1.90
R1002.0	2.00	0.0787	24.0	49.0	2.00
R1002.1	2.10	0.0827	24.0	49.0	2.10
R1002.2	2.20	0.0866	27.0	53.0	2.20
R1002.3	2.30	0.0906	27.0	53.0	2.30
R1002.4	2.40	0.0945	30.0	57.0	2.40
R1002.5	2.50	0.0984	30.0	57.0	2.50
R1002.6	2.60	0.1024	30.0	57.0	2.60
R1002.7	2.70	0.1063	33.0	61.0	2.70
R1002.8	2.80	0.1102	33.0	61.0	2.80
R1002.9	2.90	0.1142	33.0	61.0	2.90
R1003.0	3.00	0.1181	33.0	61.0	3.00
R1003.1	3.10	0.1220	36.0	65.0	3.10
R1003.2	3.20	0.1260	36.0	65.0	3.20
R1003.3	3.30	0.1299	36.0	65.0	3.30
R1003.4	3.40	0.1339	39.0	70.0	3.40
R1003.5	3.50	0.1378	39.0	70.0	3.50

Product	DC (mm)	DC (inch)	LCF (mm)	OAL (mm)	DC ON MS (mm)
R1003.6	3.60	0.1417	39.0	70.0	3.60
R1003.7	3.70	0.1457	39.0	70.0	3.70
R1003.8	3.80	0.1496	43.0	75.0	3.80
R1003.9	3.90	0.1535	43.0	75.0	3.90
R1004.0	4.00	0.1575	43.0	75.0	4.00
R1004.1	4.10	0.1614	43.0	75.0	4.10
R1004.2	4.20	0.1654	43.0	75.0	4.20
R1004.3	4.30	0.1693	47.0	80.0	4.30
R1004.4	4.40	0.1732	47.0	80.0	4.40
R1004.5	4.50	0.1772	47.0	80.0	4.50
R1004.6	4.60	0.1811	47.0	80.0	4.60
R1004.7	4.70	0.1850	47.0	80.0	4.70
R1004.8	4.80	0.1890	52.0	86.0	4.80
R1004.9	4.90	0.1929	52.0	86.0	4.90
R1005.0	5.00	0.1969	52.0	86.0	5.00
R1005.1	5.10	0.2008	52.0	86.0	5.10
R1005.2	5.20	0.2047	52.0	86.0	5.20
R1005.3	5.30	0.2087	52.0	86.0	5.30
R1005.4	5.40	0.2126	57.0	93.0	5.40
R1005.5	5.50	0.2165	57.0	93.0	5.50
R1005.6	5.60	0.2205	57.0	93.0	5.60
R1005.7	5.70	0.2244	57.0	93.0	5.70
R1005.8	5.80	0.2283	57.0	93.0	5.80
R1005.9	5.90	0.2323	57.0	93.0	5.90
R1006.0	6.00	0.2362	57.0	93.0	6.00
R1006.1	6.10	0.2402	63.0	101.0	6.10



Product	DC	DC	LCF	OAL	DCON MS
	(mm)	(inch)	(mm)	(mm)	(mm)
R1006.2	6.20	0.2441	63.0	101.0	6.20
R1006.3	6.30	0.2480	63.0	101.0	6.30
R1006.4	6.40	0.2520	63.0	101.0	6.40
R1006.5	6.50	0.2559	63.0	101.0	6.50
R1006.6	6.60	0.2598	63.0	101.0	6.60
R1006.7	6.70	0.2638	63.0	101.0	6.70
R1006.8	6.80	0.2677	69.0	109.0	6.80
R1006.9	6.90	0.2717	69.0	109.0	6.90
R1007.0	7.00	0.2756	69.0	109.0	7.00
R1007.1	7.10	0.2795	69.0	109.0	7.10
R1007.2	7.20	0.2835	69.0	109.0	7.20
R1007.3	7.30	0.2874	69.0	109.0	7.30
R1007.4	7.40	0.2913	69.0	109.0	7.40
R1007.5	7.50	0.2953	69.0	109.0	7.50
R1007.6	7.60	0.2992	75.0	117.0	7.60
R1007.7	7.70	0.3031	75.0	117.0	7.70
R1007.8	7.80	0.3071	75.0	117.0	7.80
R1007.9	7.90	0.3110	75.0	117.0	7.90
R1008.0	8.00	0.3150	75.0	117.0	8.00
R1008.1	8.10	0.3189	75.0	117.0	8.10
R1008.2	8.20	0.3228	75.0	117.0	8.20
R1008.3	8.30	0.3268	75.0	117.0	8.30
R1008.4	8.40	0.3307	75.0	117.0	8.40

Product	DC	DC	LCF	OAL	DCON MS
	(mm)	(inch)	(mm)	(mm)	(mm)
R1008.5	8.50	0.3346	75.0	117.0	8.50
R1008.6	8.60	0.3386	81.0	125.0	8.60
R1008.7	8.70	0.3425	81.0	125.0	8.70
R1008.8	8.80	0.3465	81.0	125.0	8.80
R1008.9	8.90	0.3504	81.0	125.0	8.90
R1009.0	9.00	0.3543	81.0	125.0	9.00
R1009.1	9.10	0.3583	81.0	125.0	9.10
R1009.2	9.20	0.3622	81.0	125.0	9.20
R1009.3	9.30	0.3661	81.0	125.0	9.30
R1009.4	9.40	0.3701	81.0	125.0	9.40
R1009.5	9.50	0.3740	81.0	125.0	9.50
R1009.6	9.60	0.3780	87.0	133.0	9.60
R1009.7	9.70	0.3819	87.0	133.0	9.70
R1009.8	9.80	0.3858	87.0	133.0	9.80
R1009.9	9.90	0.3898	87.0	133.0	9.90
R10010.0	10.00	0.3937	87.0	133.0	10.00
R10010.2	10.20	0.4016	87.0	133.0	10.20
R10010.5	10.50	0.4134	87.0	133.0	10.50
R10011.0	11.00	0.4331	94.0	142.0	11.00
R10011.5	11.50	0.4528	94.0	142.0	11.50
R10012.0	12.00	0.4724	101.0	151.0	12.00
R10013.0	13.00	0.5118	101.0	151.0	13.00
R10014.0	14.00	0.5512	108.0	160.0	14.00



R520



CDX VHM extra korte productieboor, DIN6539, TiN gecoat

Hoogproductieve boor, voor gaten van hoge kwaliteit en nauwkeurigheid bij hoge verspaningscondities (H8 gattolerantie). De puntgeometrie van 130° helpt bij de zelfcentering en vermindert de snijkrachten. TiN coating verbetert de prestaties en verlengt de standtijd. Geschikt voor alle CNC machines en vele materialen.



CDX

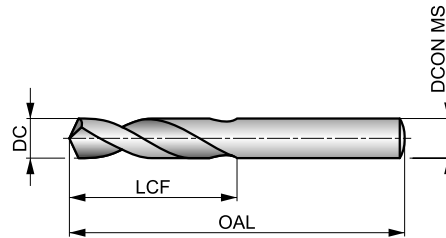

HM	DIN 6539	2.5×D
130°	TiN	
λ 20-35°	R	DC h7

De tabel geeft de geschiktheid aan voor de materiaalgroep en de startwaarden voor de snijsnelheid (m/min) en de letter verwijst naar de toe te passen voeding (fn), zie vanaf pagina 65.

P1.1 ■ 119 X	P1.2 ■ 134 X	P1.3 ■ 138 X	P2.1 ■ 102 X	P2.2 ■ 90 X	P2.3 ■ 80 X	P3.1 ■ 81 X	P3.2 ■ 65 X	P3.3 ■ 55 X	P4.1 ■ 48 X	P4.2 ■ 41 X	P4.3 ■ 34 W	M1.1 ■ 69 W	M1.2 ■ 58 W
M2.1 ■ 61 W	M2.2 ■ 50 W	K1.1 ■ 90 Y	K1.2 ■ 67 Y	K1.3 ■ 50 Y	K2.1 ■ 80 X	K2.2 ■ 65 X	K2.3 ■ 52 X	K3.1 ■ 71 X	K3.2 ■ 54 X	K3.3 ■ 44 X	K4.1 ■ 66 X	K4.2 ■ 49 X	K4.3 ■ 36 X
K4.4 ■ 31 X	K4.5 ■ 26 X	K5.1 ■ 74 X	K5.2 ■ 56 X	K5.3 ■ 43 X	N1.1 ■ 225 Z	N1.2 ■ 169 Z	N1.3 ■ 113 Z	N2.1 ■ 231 Y	N2.2 ■ 208 Y	N2.3 ■ 150 Y	N4.1 ■ 75 Z	N4.2 ■ 115 V	S1.1 ■ 60 W
S1.2 ■ 45 V	S1.3 ■ 35 U	H1.1 ■ 65 U	H2.1 ■ 38 U	H2.2 ■ 36 T	H3.1 ■ 43 U	H3.2 ■ 35 U							

DCON MS passing h7.

Product	DC (inch)	DC (mm)	DC (inch)	LCF (mm)	OAL (mm)	DCON MS (mm)
R5203.0	–	3.00	0.1181	16.0	46.0	3.00
R5203.1	–	3.10	0.1220	18.0	49.0	3.10
R5201/8	1/8	3.18	0.1252	18.0	49.0	3.18
R5203.2	–	3.20	0.1260	18.0	49.0	3.20
R5203.3	–	3.30	0.1299	18.0	49.0	3.30
R5203.4	–	3.40	0.1339	20.0	52.0	3.40
R5203.5	–	3.50	0.1378	20.0	52.0	3.50
R5203.6	–	3.60	0.1417	20.0	52.0	3.60
R5203.7	–	3.70	0.1457	20.0	52.0	3.70
R5203.8	–	3.80	0.1496	22.0	55.0	3.80
R5203.9	–	3.90	0.1535	22.0	55.0	3.90
R5204.0	–	4.00	0.1575	22.0	55.0	4.00
R5204.1	–	4.10	0.1614	22.0	55.0	4.10
R5204.2	–	4.20	0.1654	22.0	55.0	4.20
R5204.3	–	4.30	0.1693	24.0	58.0	4.30
R5204.4	–	4.40	0.1732	24.0	58.0	4.40
R5204.5	–	4.50	0.1772	24.0	58.0	4.50
R5204.6	–	4.60	0.1811	24.0	58.0	4.60
R5204.7	–	4.70	0.1850	24.0	58.0	4.70
R5204.8	–	4.80	0.1890	26.0	62.0	4.80
R5204.9	–	4.90	0.1929	26.0	62.0	4.90
R5205.0	–	5.00	0.1969	26.0	62.0	5.00
R5205.1	–	5.10	0.2008	26.0	62.0	5.10
R5205.2	–	5.20	0.2047	26.0	62.0	5.20
R5205.3	–	5.30	0.2087	26.0	62.0	5.30

Product	DC (inch)	DC (mm)	DC (inch)	LCF (mm)	OAL (mm)	DCON MS (mm)
R5205.4	–	5.40	0.2126	28.0	66.0	5.40
R5205.5	–	5.50	0.2165	28.0	66.0	5.50
R5205.6	–	5.60	0.2205	28.0	66.0	5.60
R5205.7	–	5.70	0.2244	28.0	66.0	5.70
R5205.8	–	5.80	0.2283	28.0	66.0	5.80
R5205.9	–	5.90	0.2323	28.0	66.0	5.90
R5206.0	–	6.00	0.2362	28.0	66.0	6.00
R5206.1	–	6.10	0.2402	31.0	70.0	6.10
R5206.2	–	6.20	0.2441	31.0	70.0	6.20
R5206.3	–	6.30	0.2480	31.0	70.0	6.30
R5201/4	1/4	6.35	0.2500	31.0	70.0	6.35
R5206.4	–	6.40	0.2520	31.0	70.0	6.40
R5206.5	–	6.50	0.2559	31.0	70.0	6.50
R5206.6	–	6.60	0.2598	31.0	70.0	6.60
R5206.7	–	6.70	0.2638	31.0	70.0	6.70
R5206.8	–	6.80	0.2677	34.0	74.0	6.80
R5206.9	–	6.90	0.2717	34.0	74.0	6.90
R5207.0	–	7.00	0.2756	34.0	74.0	7.00
R5207.1	–	7.10	0.2795	34.0	74.0	7.10
R5207.2	–	7.20	0.2835	34.0	74.0	7.20
R5207.3	–	7.30	0.2874	34.0	74.0	7.30
R5207.4	–	7.40	0.2913	34.0	74.0	7.40
R5207.5	–	7.50	0.2953	34.0	74.0	7.50
R5207.6	–	7.60	0.2992	37.0	79.0	7.60
R5207.7	–	7.70	0.3031	37.0	79.0	7.70



Product	DC	DC	DC	LCF	OAL	DCON MS
	(inch)	(mm)	(inch)	(mm)	(mm)	(mm)
R5207.8	–	7.80	0.3071	37.0	79.0	7.80
R5207.9	–	7.90	0.3110	37.0	79.0	7.90
R5205/16	5/16	7.94	0.3126	37.0	79.0	7.94
R5208.0	–	8.00	0.3150	37.0	79.0	8.00
R5208.1	–	8.10	0.3189	37.0	79.0	8.10
R5208.2	–	8.20	0.3228	37.0	79.0	8.20
R5208.3	–	8.30	0.3268	37.0	79.0	8.30
R5208.4	–	8.40	0.3307	37.0	79.0	8.40
R5208.5	–	8.50	0.3346	37.0	79.0	8.50
R5208.6	–	8.60	0.3386	40.0	84.0	8.60
R5208.7	–	8.70	0.3425	40.0	84.0	8.70
R5208.8	–	8.80	0.3465	40.0	84.0	8.80
R5208.9	–	8.90	0.3504	40.0	84.0	8.90
R5209.0	–	9.00	0.3543	40.0	84.0	9.00
R5209.1	–	9.10	0.3583	40.0	84.0	9.10
R5209.2	–	9.20	0.3622	40.0	84.0	9.20
R5209.3	–	9.30	0.3661	40.0	84.0	9.30
R5209.4	–	9.40	0.3701	40.0	84.0	9.40
R5209.5	–	9.50	0.3740	40.0	84.0	9.50
R5203/8	3/8	9.52	0.3748	43.0	89.0	9.52
R5209.6	–	9.60	0.3780	43.0	89.0	9.60
R5209.7	–	9.70	0.3819	43.0	89.0	9.70
R5209.8	–	9.80	0.3858	43.0	89.0	9.80
R5209.9	–	9.90	0.3898	43.0	89.0	9.90

Product	DC	DC	DC	LCF	OAL	DCON MS
	(inch)	(mm)	(inch)	(mm)	(mm)	(mm)
R52010.0	–	10.00	0.3937	43.0	89.0	10.00
R52010.1	–	10.10	0.3976	43.0	89.0	10.10
R52010.2	–	10.20	0.4016	43.0	89.0	10.20
R52010.3	–	10.30	0.4055	43.0	89.0	10.30
R52010.4	–	10.40	0.4094	43.0	89.0	10.40
R52010.5	–	10.50	0.4134	43.0	89.0	10.50
R52011.0	–	11.00	0.4331	47.0	95.0	11.00
R5207/16	7/16	11.11	0.4374	47.0	95.0	11.11
R52011.2	–	11.20	0.4409	47.0	95.0	11.20
R52011.5	–	11.50	0.4528	47.0	95.0	11.50
R52012.0	–	12.00	0.4724	51.0	102.0	12.00
R52012.5	–	12.50	0.4921	51.0	102.0	12.50
R5201/2	1/2	12.70	0.5000	51.0	102.0	12.70
R52013.0	–	13.00	0.5118	51.0	102.0	13.00
R52013.5	–	13.50	0.5315	54.0	107.0	13.50
R52014.0	–	14.00	0.5512	54.0	107.0	14.00
R52014.2	–	14.20	0.5591	56.0	111.0	14.20
R52014.25	–	14.25	0.5610	56.0	111.0	14.25
R52014.5	–	14.50	0.5709	56.0	111.0	14.50
R52015.0	–	15.00	0.5906	56.0	111.0	15.00
R52015.1	–	15.10	0.5945	58.0	115.0	15.10
R5205/8	5/8	15.88	0.6252	58.0	115.0	15.88
R52016.0	–	16.00	0.6299	58.0	115.0	16.00
R52016.5	–	16.50	0.6496	60.0	119.0	16.50



R510



CDX VHM korte productieboor, DIN338, TiN gecoat

Hoogproductieve boor, voor gaten van hoge kwaliteit en nauwkeurigheid bij hoge verspaningscondities (H8 gattolerantie). De puntgeometrie van 130° helpt bij de zelfcentering en vermindert de snijkrachten. TiN coating verbetert de prestaties en verlengt de standtijd. Geschikt voor alle CNC machines en vele materialen.



CDX

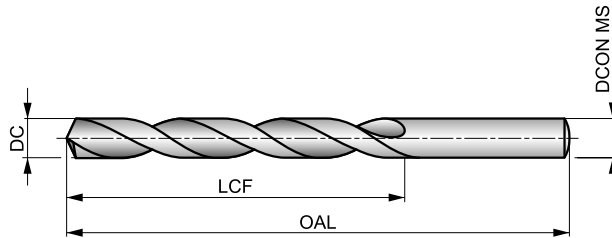

HM	DIN 338	4xD
130°	TiN	
λ 20-35°	R	DC h7

De tabel geeft de geschiktheid aan voor de materiaalgroep en de startwaarden voor de snijsnelheid (m/min) en de letter verwijst naar de toe te passen voeding (fn), zie vanaf pagina 65.

P1.1 ■ 119 W	P1.2 ■ 134 W	P1.3 ■ 138 W	P2.1 ■ 102 W	P2.2 ■ 90 W	P2.3 ■ 80 V	P3.1 ■ 81 W	P3.2 ■ 65 W	P3.3 ■ 55 V	P4.1 ■ 48 W	P4.2 ■ 41 V	P4.3 ■ 34 V	M1.1 ■ 69 V	M1.2 ■ 58 V
M2.1 ■ 61 V	M2.2 ■ 50 V	K1.1 ■ 90 X	K1.2 ■ 67 X	K1.3 ■ 50 X	K2.1 ■ 80 W	K2.2 ■ 65 W	K2.3 ■ 52 W	K3.1 ■ 71 W	K3.2 ■ 54 W	K3.3 ■ 44 W	K4.1 ■ 66 W	K4.2 ■ 49 W	K4.3 ■ 36 W
K4.4 ■ 31 W	K4.5 ■ 26 W	K5.1 ■ 74 W	K5.2 ■ 56 W	K5.3 ■ 43 W	N1.1 ■ 225 Y	N1.2 ■ 169 Y	N1.3 ■ 113 Y	N2.1 ■ 231 X	N2.2 ■ 208 X	N2.3 ■ 150 X	N4.1 ■ 75 X	N4.2 ■ 115 V	S1.1 ■ 45 V
H1.1 ■ 65 T	H2.1 ■ 38 T	H2.2 ■ 36 S	H3.1 ■ 43 T	H3.2 ■ 35 T									

DCON MS passing h7.

Product	DC (inch)	DC (mm)	DC (inch)	LCF (mm)	OAL (mm)	DCON MS (mm)
R5103.0	–	3.00	0.1181	33.0	61.0	3.00
R5101/8	1/8	3.18	0.1252	36.0	65.0	3.18
R5103.2	–	3.20	0.1260	36.0	65.0	3.20
R5103.3	–	3.30	0.1299	36.0	65.0	3.30
R5103.4	–	3.40	0.1339	39.0	70.0	3.40
R5103.5	–	3.50	0.1378	39.0	70.0	3.50
R5103.7	–	3.70	0.1457	39.0	70.0	3.70
R5103.9	–	3.90	0.1535	43.0	75.0	3.90
R5104.0	–	4.00	0.1575	43.0	75.0	4.00
R5104.1	–	4.10	0.1614	43.0	75.0	4.10
R5104.2	–	4.20	0.1654	43.0	75.0	4.20
R5104.3	–	4.30	0.1693	47.0	80.0	4.30
R5104.5	–	4.50	0.1772	47.0	80.0	4.50
R5104.6	–	4.60	0.1811	47.0	80.0	4.60
R5104.7	–	4.70	0.1850	47.0	80.0	4.70
R5103/16	3/16	4.76	0.1874	52.0	86.0	4.76
R5104.9	–	4.90	0.1929	52.0	86.0	4.90
R5105.0	–	5.00	0.1969	52.0	86.0	5.00
R5105.1	–	5.10	0.2008	52.0	86.0	5.10
R5105.5	–	5.50	0.2165	57.0	93.0	5.50
R5105.6	–	5.60	0.2205	57.0	93.0	5.60
R5105.7	–	5.70	0.2244	57.0	93.0	5.70
R5106.0	–	6.00	0.2362	57.0	93.0	6.00
R5101/4	1/4	6.35	0.2500	63.0	101.0	6.35
R5106.5	–	6.50	0.2559	63.0	101.0	6.50

Product	DC (inch)	DC (mm)	DC (inch)	LCF (mm)	OAL (mm)	DCON MS (mm)
R5106.6	–	6.60	0.2598	63.0	101.0	6.60
R5106.8	–	6.80	0.2677	69.0	109.0	6.80
R5106.9	–	6.90	0.2717	69.0	109.0	6.90
R5107.0	–	7.00	0.2756	69.0	109.0	7.00
R5107.3	–	7.30	0.2874	69.0	109.0	7.30
R5107.4	–	7.40	0.2913	69.0	109.0	7.40
R5107.5	–	7.50	0.2953	69.0	109.0	7.50
R5107.8	–	7.80	0.3071	75.0	117.0	7.80
R5107.9	–	7.90	0.3110	75.0	117.0	7.90
R5105/16	5/16	7.94	0.3126	75.0	117.0	7.94
R5108.0	–	8.00	0.3150	75.0	117.0	8.00
R5108.5	–	8.50	0.3346	75.0	117.0	8.50
R5108.7	–	8.70	0.3425	81.0	125.0	8.70
R5108.8	–	8.80	0.3465	81.0	125.0	8.80
R5109.0	–	9.00	0.3543	81.0	125.0	9.00
R5109.2	–	9.20	0.3622	81.0	125.0	9.20
R5109.3	–	9.30	0.3661	81.0	125.0	9.30
R5109.4	–	9.40	0.3701	81.0	125.0	9.40
R5109.5	–	9.50	0.3740	81.0	125.0	9.50
R5103/8	3/8	9.52	0.3748	87.0	133.0	9.52
R5109.9	–	9.90	0.3898	87.0	133.0	9.90
R51010.0	–	10.00	0.3937	87.0	133.0	10.00
R51010.2	–	10.20	0.4016	87.0	133.0	10.20
R51010.3	–	10.30	0.4055	87.0	133.0	10.30
R51010.4	–	10.40	0.4094	87.0	133.0	10.40



Product	DC	DC	DC	LCF	OAL	D CON MS
	(inch)	(mm)	(inch)	(mm)	(mm)	(mm)
R51010.5	–	10.50	0.4134	87.0	133.0	10.50
R51010.8	–	10.80	0.4252	94.0	142.0	10.80
R51011.0	–	11.00	0.4331	94.0	142.0	11.00
R5107/16	7/16	11.11	0.4374	94.0	142.0	11.11
R51011.2	–	11.20	0.4409	94.0	142.0	11.20
R51011.5	–	11.50	0.4528	94.0	142.0	11.50

Product	DC	DC	DC	LCF	OAL	D CON MS
	(inch)	(mm)	(inch)	(mm)	(mm)	(mm)
R51012.0	–	12.00	0.4724	101.0	151.0	12.00
R5101/2	1/2	12.70	0.5000	101.0	151.0	12.70
R51013.0	–	13.00	0.5118	101.0	151.0	13.00
R51014.0	–	14.00	0.5512	108.0	160.0	14.00
R51014.25	–	14.25	0.5610	114.0	169.0	14.25



R458



FORCE X VHM productieboor, 3xD, TiAlN gecoat

Hoogproductieve boor, voor gaten van hoge kwaliteit en nauwkeurigheid bij hoge verspaningscondities (H9 gattolerantie). Zelfcentrerende 140°, 4-vlaks split point en CTW spaangroefontwerp voor hoge voedingsnelheden. TiAlN coating verhoogt de oppervlaktehardheid en verbetert de standtijd van het gereedschap. Met gladde (HA) eenheidschacht voor de hoogste rondlooptrouwbaarheid.

FORCE X

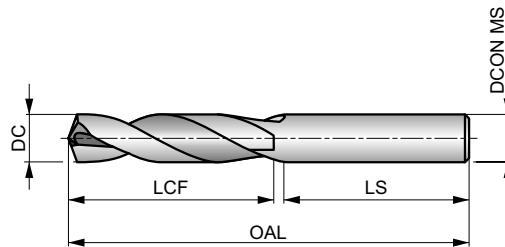

HM	DIN 6537K	3xD
140°	TiAlN	DIN 6535HA
CTW	DC m7	

De tabel geeft de geschiktheid aan voor de materiaalgroep en de startwaarden voor de snijsnelheid (m/min) en de letter verwijst naar de toe te passen voeding (fn), zie vanaf pagina 65.

P1.1 ■ 143 W	P1.2 ■ 160 W	P1.3 ■ 166 W	P2.1 ■ 122 W	P2.2 ■ 108 W	P2.3 ■ 95 V	P3.1 ■ 106 V	P3.2 ■ 86 V	P3.3 ■ 72 V	P4.1 ■ 63 V	P4.2 ■ 54 V	P4.3 ■ 44 U	M1.1 ■ 60 U	M1.2 ■ 51 U
M2.1 ■ 54 U	M2.2 ■ 44 U	M2.3 ■ 37 T	M3.1 ■ 33 T	M3.2 ■ 28 T	M3.3 ■ 26 T	M4.1 ■ 24 T	M4.2 ■ 21 T	K1.1 ■ 88 W	K1.2 ■ 65 W	K1.3 ■ 49 W	K2.1 ■ 78 V	K2.2 ■ 64 V	K2.3 ■ 51 V
K3.1 ■ 70 V	K3.2 ■ 54 V	K3.3 ■ 43 V	K4.1 ■ 65 V	K4.2 ■ 49 V	K4.3 ■ 36 V	K4.4 ■ 30 V	K4.5 ■ 26 V	K5.1 ■ 73 V	K5.2 ■ 55 V	K5.3 ■ 42 V	N1.1 ■ 200 W	N1.2 ■ 150 W	N1.3 ■ 100 W
N2.1 ■ 246 V	N2.2 ■ 222 V	N2.3 ■ 160 V	N3.1 ■ 298 V	N3.2 ■ 176 V	N3.3 ■ 88 V	S1.1 ■ 44 U	S1.2 ■ 36 U	S1.3 ■ 32 T	H1.1 ■ 45 U	H2.1 ■ 26 U	H2.2 ■ 24 U	H3.1 ■ 30 U	H3.2 ■ 24 U

DCON MS passing h6.

Product	DC (inch)	DC (mm)	DC (inch)	LCF (mm)	OAL (mm)	LS (mm)	DCON MS (mm)
R4583.0	–	3.00	0.1181	20.0	62.0	36.0	6.00
R4583.1	–	3.10	0.1220	20.0	62.0	36.0	6.00
R4581/8	1/8	3.18	0.1250	20.0	62.0	36.0	6.00
R4583.2	–	3.20	0.1260	20.0	62.0	36.0	6.00
R458N30	N30	3.26	0.1283	20.0	62.0	36.0	6.00
R4583.3	–	3.30	0.1299	20.0	62.0	36.0	6.00
R4583.4	–	3.40	0.1339	20.0	62.0	36.0	6.00
R458N29	N29	3.45	0.1360	20.0	62.0	36.0	6.00
R4583.5	–	3.50	0.1378	20.0	62.0	36.0	6.00
R458N28	N28	3.57	0.1406	20.0	62.0	36.0	6.00
R4589/64	9/64	3.57	0.1406	20.0	62.0	36.0	6.00
R4583.6	–	3.60	0.1417	20.0	62.0	36.0	6.00
R458N27	N27	3.66	0.1441	20.0	62.0	36.0	6.00
R4583.7	–	3.70	0.1457	20.0	62.0	36.0	6.00
R4583.73	–	3.73	0.1469	24.0	66.0	36.0	6.00
R458N26	N26	3.73	0.1469	24.0	66.0	36.0	6.00
R458N25	N25	3.80	0.1496	24.0	66.0	36.0	6.00
R4583.8	–	3.80	0.1496	24.0	66.0	36.0	6.00
R458N24	N24	3.86	0.1520	24.0	66.0	36.0	6.00
R4583.9	–	3.90	0.1535	24.0	66.0	36.0	6.00
R458N23	N23	3.91	0.1539	24.0	66.0	36.0	6.00
R4585/32	5/32	3.97	0.1563	24.0	66.0	36.0	6.00
R458N22	N22	3.99	0.1571	24.0	66.0	36.0	6.00
R4584.0	–	4.00	0.1575	24.0	66.0	36.0	6.00
R458N21	N21	4.04	0.1591	24.0	66.0	36.0	6.00



Product	DC	DC	DC	LCF	OAL	LS	DCON MS
	(inch)	(mm)	(inch)	(mm)	(mm)	(mm)	(mm)
R458N20	N20	4.09	0.1610	24.0	66.0	36.0	6.00
R4584.1	–	4.10	0.1614	24.0	66.0	36.0	6.00
R4584.2	–	4.20	0.1654	24.0	66.0	36.0	6.00
R458N19	N19	4.22	0.1661	24.0	66.0	36.0	6.00
R4584.3	–	4.30	0.1693	24.0	66.0	36.0	6.00
R458N18	N18	4.31	0.1697	24.0	66.0	36.0	6.00
R45811/64	11/64	4.37	0.1719	24.0	66.0	36.0	6.00
R458N17	N17	4.39	0.1728	24.0	66.0	36.0	6.00
R4584.4	–	4.40	0.1732	24.0	66.0	36.0	6.00
R4584.5	–	4.50	0.1772	24.0	66.0	36.0	6.00
R458N16	N16	4.50	0.1772	24.0	66.0	36.0	6.00
R458N15	N15	4.57	0.1799	24.0	66.0	36.0	6.00
R4584.6	–	4.60	0.1811	24.0	66.0	36.0	6.00
R458N14	N14	4.62	0.1819	24.0	66.0	36.0	6.00
R458N13	N13	4.70	0.1850	24.0	66.0	36.0	6.00
R4584.7	–	4.70	0.1850	24.0	66.0	36.0	6.00
R4583/16	3/16	4.76	0.1875	28.0	66.0	36.0	6.00
R4584.8	–	4.80	0.1890	28.0	66.0	36.0	6.00
R458N12	N12	4.80	0.1890	28.0	66.0	36.0	6.00
R458N11	N11	4.85	0.1909	28.0	66.0	36.0	6.00
R4584.9	–	4.90	0.1929	28.0	66.0	36.0	6.00
R458N10	N10	4.92	0.1937	28.0	66.0	36.0	6.00
R458N9	N9	4.98	0.1961	28.0	66.0	36.0	6.00
R4585.0	–	5.00	0.1969	28.0	66.0	36.0	6.00
R458N8	N8	5.06	0.1992	28.0	66.0	36.0	6.00
R4585.1	–	5.10	0.2008	28.0	66.0	36.0	6.00
R458N7	N7	5.11	0.2010	28.0	66.0	36.0	6.00
R45813/64	13/64	5.16	0.2031	28.0	66.0	36.0	6.00
R458N6	N6	5.18	0.2039	28.0	66.0	36.0	6.00
R4585.2	–	5.20	0.2047	28.0	66.0	36.0	6.00
R458N5	N5	5.22	0.2055	28.0	66.0	36.0	6.00
R4585.3	–	5.30	0.2087	28.0	66.0	36.0	6.00
R458N4	N4	5.31	0.2091	28.0	66.0	36.0	6.00
R4585.4	–	5.40	0.2126	28.0	66.0	36.0	6.00
R458N3	N3	5.41	0.2130	28.0	66.0	36.0	6.00
R4585.5	–	5.50	0.2165	28.0	66.0	36.0	6.00
R4587/32	7/32	5.56	0.2188	28.0	66.0	36.0	6.00
R4585.6	–	5.60	0.2205	28.0	66.0	36.0	6.00
R458N2	N2	5.61	0.2209	28.0	66.0	36.0	6.00
R4585.7	–	5.70	0.2244	28.0	66.0	36.0	6.00
R458N1	N1	5.79	0.2280	28.0	66.0	36.0	6.00
R4585.8	–	5.80	0.2283	28.0	66.0	36.0	6.00
R4585.9	–	5.90	0.2323	28.0	66.0	36.0	6.00
R458A	A	5.94	0.2339	28.0	66.0	36.0	6.00
R45815/64	15/64	5.95	0.2344	28.0	66.0	36.0	6.00
R4586.0	–	6.00	0.2362	28.0	66.0	36.0	6.00
R458B	B	6.05	0.2380	34.0	79.0	36.0	8.00
R4586.1	–	6.10	0.2402	34.0	79.0	36.0	8.00
R458C	C	6.15	0.2421	34.0	79.0	36.0	8.00
R4586.2	–	6.20	0.2441	34.0	79.0	36.0	8.00
R458D	D	6.25	0.2461	34.0	79.0	36.0	8.00
R4586.3	–	6.30	0.2480	34.0	79.0	36.0	8.00
R4581/4	1/4	6.35	0.2500	34.0	79.0	36.0	8.00
R458E	E	6.35	0.2500	34.0	79.0	36.0	8.00
R4586.4	–	6.40	0.2520	34.0	79.0	36.0	8.00
R4586.5	–	6.50	0.2559	34.0	79.0	36.0	8.00
R458F	F	6.53	0.2571	34.0	79.0	36.0	8.00
R4586.6	–	6.60	0.2598	34.0	79.0	36.0	8.00
R458G	G	6.63	0.2610	34.0	79.0	36.0	8.00
R4586.7	–	6.70	0.2638	34.0	79.0	36.0	8.00
R45817/64	17/64	6.75	0.2656	34.0	79.0	36.0	8.00
R458H	H	6.76	0.2661	34.0	79.0	36.0	8.00
R4586.8	–	6.80	0.2677	34.0	79.0	36.0	8.00
R4586.9	–	6.90	0.2717	34.0	79.0	36.0	8.00
R458I	I	6.91	0.2720	34.0	79.0	36.0	8.00



Product	DC	DC	DC	LCF	OAL	LS	DCON MS
	(inch)	(mm)	(inch)	(mm)	(mm)	(mm)	(mm)
R4587.0	—	7.00	0.2756	34.0	79.0	36.0	8.00
R458J	J	7.04	0.2772	34.0	79.0	36.0	8.00
R4587.1	—	7.10	0.2795	41.0	79.0	36.0	8.00
R458K	K	7.14	0.2811	41.0	79.0	36.0	8.00
R4589/32	9/32	7.14	0.2813	41.0	79.0	36.0	8.00
R4587.2	—	7.20	0.2835	41.0	79.0	36.0	8.00
R4587.3	—	7.30	0.2874	41.0	79.0	36.0	8.00
R458L	L	7.37	0.2902	41.0	79.0	36.0	8.00
R4587.4	—	7.40	0.2913	41.0	79.0	36.0	8.00
R458M	M	7.49	0.2949	41.0	79.0	36.0	8.00
R4587.5	—	7.50	0.2953	41.0	79.0	36.0	8.00
R45819/64	19/64	7.54	0.2969	41.0	79.0	36.0	8.00
R4587.6	—	7.60	0.2992	41.0	79.0	36.0	8.00
R458N	N	7.67	0.3020	41.0	79.0	36.0	8.00
R4587.7	—	7.70	0.3031	41.0	79.0	36.0	8.00
R4587.8	—	7.80	0.3071	41.0	79.0	36.0	8.00
R4587.9	—	7.90	0.3110	41.0	79.0	36.0	8.00
R4585/16	5/16	7.94	0.3125	41.0	79.0	36.0	8.00
R4588.0	—	8.00	0.3150	41.0	79.0	36.0	8.00
R458O	O	8.03	0.3161	47.0	89.0	40.0	10.00
R4588.1	—	8.10	0.3189	47.0	89.0	40.0	10.00
R4588.2	—	8.20	0.3228	47.0	89.0	40.0	10.00
R458P	P	8.20	0.3228	47.0	89.0	40.0	10.00
R4588.3	—	8.30	0.3268	47.0	89.0	40.0	10.00
R45821/64	21/64	8.33	0.3281	47.0	89.0	40.0	10.00
R4588.4	—	8.40	0.3307	47.0	89.0	40.0	10.00
R458Q	Q	8.43	0.3319	47.0	89.0	40.0	10.00
R4588.5	—	8.50	0.3346	47.0	89.0	40.0	10.00
R4588.6	—	8.60	0.3386	47.0	89.0	40.0	10.00
R458R	R	8.61	0.3390	47.0	89.0	40.0	10.00
R4588.7	—	8.70	0.3425	47.0	89.0	40.0	10.00
R45811/32	11/32	8.73	0.3438	47.0	89.0	40.0	10.00
R4588.8	—	8.80	0.3465	47.0	89.0	40.0	10.00
R458S	S	8.84	0.3480	47.0	89.0	40.0	10.00
R4588.9	—	8.90	0.3504	47.0	89.0	40.0	10.00
R4589.0	—	9.00	0.3543	47.0	89.0	40.0	10.00
R458T	T	9.09	0.3579	47.0	89.0	40.0	10.00
R4589.1	—	9.10	0.3583	47.0	89.0	40.0	10.00
R45823/64	23/64	9.13	0.3594	47.0	89.0	40.0	10.00
R4589.2	—	9.20	0.3622	47.0	89.0	40.0	10.00
R4589.3	—	9.30	0.3661	47.0	89.0	40.0	10.00
R458U	U	9.35	0.3681	47.0	89.0	40.0	10.00
R4589.4	—	9.40	0.3701	47.0	89.0	40.0	10.00
R4589.5	—	9.50	0.3740	47.0	89.0	40.0	10.00
R4583/8	3/8	9.53	0.3750	47.0	89.0	40.0	10.00
R458V	V	9.58	0.3772	47.0	89.0	40.0	10.00
R4589.6	—	9.60	0.3780	47.0	89.0	40.0	10.00
R4589.7	—	9.70	0.3819	47.0	89.0	40.0	10.00
R4589.8	—	9.80	0.3858	47.0	89.0	40.0	10.00
R458W	W	9.80	0.3858	47.0	89.0	40.0	10.00
R4589.9	—	9.90	0.3898	47.0	89.0	40.0	10.00
R45825/64	25/64	9.92	0.3906	47.0	89.0	40.0	10.00
R45810.0	—	10.00	0.3937	47.0	89.0	40.0	10.00
R458X	X	10.08	0.3969	55.0	102.0	45.0	12.00
R45810.1	—	10.10	0.3976	55.0	102.0	45.0	12.00
R45810.2	—	10.20	0.4016	55.0	102.0	45.0	12.00
R458Y	Y	10.26	0.4039	55.0	102.0	45.0	12.00
R45810.3	—	10.30	0.4055	55.0	102.0	45.0	12.00
R45813/32	13/32	10.32	0.4063	55.0	102.0	45.0	12.00
R45810.4	—	10.40	0.4094	55.0	102.0	45.0	12.00
R458Z	Z	10.49	0.4130	55.0	102.0	45.0	12.00
R45810.5	—	10.50	0.4134	55.0	102.0	45.0	12.00
R45810.6	—	10.60	0.4173	55.0	102.0	45.0	12.00
R45810.7	—	10.70	0.4213	55.0	102.0	45.0	12.00
R45827/64	27/64	10.72	0.4219	55.0	102.0	45.0	12.00



Product	DC	DC	DC	LCF	OAL	LS	DCON MS
	(inch)	(mm)	(inch)	(mm)	(mm)	(mm)	(mm)
R45810.8	–	10.80	0.4252	55.0	102.0	45.0	12.00
R45810.9	–	10.90	0.4291	55.0	102.0	45.0	12.00
R45811.0	–	11.00	0.4331	55.0	102.0	45.0	12.00
R45811.1	–	11.10	0.4370	55.0	102.0	45.0	12.00
R4587/16	7/16	11.11	0.4375	55.0	102.0	45.0	12.00
R45811.2	–	11.20	0.4409	55.0	102.0	45.0	12.00
R45811.3	–	11.30	0.4449	55.0	102.0	45.0	12.00
R45811.4	–	11.40	0.4488	55.0	102.0	45.0	12.00
R45811.5	–	11.50	0.4528	55.0	102.0	45.0	12.00
R45829/64	29/64	11.51	0.4531	55.0	102.0	45.0	12.00
R45811.6	–	11.60	0.4567	55.0	102.0	45.0	12.00
R45811.7	–	11.70	0.4606	55.0	102.0	45.0	12.00
R45811.8	–	11.80	0.4646	55.0	102.0	45.0	12.00
R45811.9	–	11.90	0.4685	55.0	102.0	45.0	12.00
R45815/32	15/32	11.91	0.4688	55.0	102.0	45.0	12.00
R45812.0	–	12.00	0.4724	55.0	102.0	45.0	12.00
R45812.1	–	12.10	0.4764	60.0	107.0	45.0	14.00
R45812.2	–	12.20	0.4803	60.0	107.0	45.0	14.00
R45831/64	31/64	12.30	0.4844	60.0	107.0	45.0	14.00
R45812.5	–	12.50	0.4921	60.0	107.0	45.0	14.00
R45812.7	–	12.70	0.5000	60.0	107.0	45.0	14.00
R4581/2	1/2	12.70	0.5000	60.0	107.0	45.0	14.00
R45812.8	–	12.80	0.5039	60.0	107.0	45.0	14.00
R45813.0	–	13.00	0.5118	60.0	107.0	45.0	14.00
R45833/64	33/64	13.10	0.5156	60.0	107.0	45.0	14.00
R45813.3	–	13.30	0.5236	60.0	107.0	45.0	14.00
R45817/32	17/32	13.49	0.5313	60.0	107.0	45.0	14.00
R45813.5	–	13.50	0.5315	60.0	107.0	45.0	14.00
R45813.8	–	13.80	0.5433	60.0	107.0	45.0	14.00
R45835/64	35/64	13.89	0.5469	60.0	107.0	45.0	14.00
R45814.0	–	14.00	0.5512	60.0	107.0	45.0	14.00
R45814.25	–	14.25	0.5610	65.0	115.0	48.0	16.00
R4589/16	9/16	14.29	0.5625	65.0	115.0	48.0	16.00
R45814.5	–	14.50	0.5709	65.0	115.0	48.0	16.00
R45837/64	37/64	14.68	0.5781	65.0	115.0	48.0	16.00
R45814.8	–	14.80	0.5827	65.0	115.0	48.0	16.00
R45815.0	–	15.00	0.5906	65.0	115.0	48.0	16.00
R45819/32	19/32	15.08	0.5938	65.0	115.0	48.0	16.00
R45815.1	–	15.10	0.5945	65.0	115.0	48.0	16.00
R45815.3	–	15.30	0.6024	65.0	115.0	48.0	16.00
R45839/64	39/64	15.48	0.6094	65.0	115.0	48.0	16.00
R45815.5	–	15.50	0.6102	65.0	115.0	48.0	16.00
R45815.8	–	15.80	0.6220	65.0	115.0	48.0	16.00
R4585/8	5/8	15.88	0.6250	65.0	115.0	48.0	16.00
R45816.0	–	16.00	0.6299	65.0	115.0	48.0	16.00
R45841/64	41/64	16.27	0.6406	73.0	123.0	48.0	18.00
R45816.5	–	16.50	0.6496	73.0	123.0	48.0	18.00
R45821/32	21/32	16.67	0.6563	73.0	123.0	48.0	18.00
R45817.0	–	17.00	0.6693	73.0	123.0	48.0	18.00
R45843/64	43/64	17.07	0.6720	73.0	123.0	48.0	18.00
R45811/16	11/16	17.46	0.6874	73.0	123.0	48.0	18.00
R45817.5	–	17.50	0.6890	73.0	123.0	48.0	18.00
R45817.8	–	17.80	0.7008	73.0	123.0	48.0	18.00
R45845/64	45/64	17.86	0.7031	73.0	123.0	48.0	18.00
R45818.0	–	18.00	0.7087	73.0	123.0	48.0	18.00
R45823/32	23/32	18.26	0.7189	79.0	131.0	50.0	20.00
R45818.5	–	18.50	0.7283	79.0	131.0	50.0	20.00
R45847/64	47/64	18.65	0.7343	79.0	131.0	50.0	20.00
R45819.0	–	19.00	0.7480	79.0	131.0	50.0	20.00
R4583/4	–	19.05	0.7500	79.0	131.0	50.0	20.00
R45819.5	–	19.50	0.7677	79.0	131.0	50.0	20.00
R45819.8	–	19.80	0.7795	79.0	131.0	50.0	20.00
R45820.0	–	20.00	0.7874	79.0	131.0	50.0	20.00



R457



FORCE X VHM productieboor, 3xD, koelkanalen, TiAlN gecoat

Hoogproductieve boor, voor gaten van hoge kwaliteit en nauwkeurigheid bij hoge verspaningscondities (H9 gattolerantie). Zelfcenterende 140°, 4-vlaks split point en CTW spaangroefontwerp voor hoge voedingssnelheden. Koelkanalen voor betere spaanafvoer. TiAlN coating verhoogt de oppervlaktehardheid en verbetert de standtijd van het gereedschap. Met gladde (HA) eenheidschacht voor de hoogste rondloopnauwkeurigheid.

FORCE X

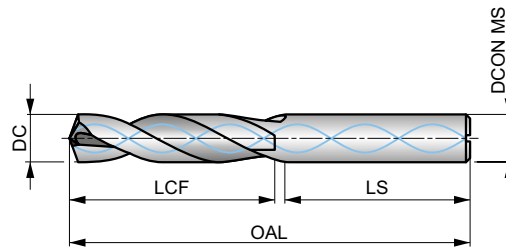

HM	DIN 6537K	3xD
140°	TiAlN	DIN 6535HA
CTW	DC m7	

De tabel geeft de geschiktheid aan voor de materiaalgroep en de startwaarden voor de snijsnelheid (m/min) en de letter verwijst naar de toe te passen voeding (fn), zie vanaf pagina 65.

P1.1 ■ 179 W	P1.2 ■ 200 W	P1.3 ■ 207 W	P2.1 ■ 153 W	P2.2 ■ 135 W	P2.3 ■ 119 V	P3.1 ■ 133 V	P3.2 ■ 107 V	P3.3 ■ 90 V	P4.1 ■ 79 V	P4.2 ■ 67 V	P4.3 ■ 55 U	M1.1 ■ 75 V	M1.2 ■ 64 V
M2.1 ■ 67 V	M2.2 ■ 55 V	M2.3 ■ 46 U	M3.1 ■ 41 V	M3.2 ■ 35 V	M3.3 ■ 32 V	M4.1 ■ 30 U	M4.2 ■ 26 U	K1.1 ■ 110 W	K1.2 ■ 81 W	K1.3 ■ 61 W	K2.1 ■ 98 V	K2.2 ■ 80 V	K2.3 ■ 64 V
K3.1 ■ 87 V	K3.2 ■ 67 V	K3.3 ■ 54 V	K4.1 ■ 81 V	K4.2 ■ 61 V	K4.3 ■ 45 V	K4.4 ■ 38 V	K4.5 ■ 32 V	K5.1 ■ 91 V	K5.2 ■ 69 V	K5.3 ■ 53 V	N1.1 ■ 250 W	N1.2 ■ 188 W	N1.3 ■ 125 W
N2.1 ■ 308 V	N2.2 ■ 277 V	N2.3 ■ 200 V	N3.1 ■ 373 W	N3.2 ■ 220 W	N3.3 ■ 110 W	S1.1 ■ 55 V	S1.2 ■ 45 V	S1.3 ■ 40 U	H1.1 ■ 56 U	H2.1 ■ 33 U	H2.2 ■ 30 U	H3.1 ■ 37 U	H3.2 ■ 30 U

DCON MS passing h6.

Product	DC (inch)	DC (mm)	DC (inch)	LCF (mm)	OAL (mm)	LS (mm)	DCON MS (mm)
R4573.0	–	3.00	0.1181	20.0	62.0	36.0	6.00
R4573.1	–	3.10	0.1220	20.0	62.0	36.0	6.00
R4571/8	1/8	3.18	0.1250	20.0	62.0	36.0	6.00
R4573.2	–	3.20	0.1260	20.0	62.0	36.0	6.00
R457N30	N30	3.26	0.1283	20.0	62.0	36.0	6.00
R4573.3	–	3.30	0.1299	20.0	62.0	36.0	6.00
R4573.4	–	3.40	0.1339	20.0	62.0	36.0	6.00
R457N29	N29	3.45	0.1360	20.0	62.0	36.0	6.00
R4573.5	–	3.50	0.1378	20.0	62.0	36.0	6.00
R457N28	N28	3.57	0.1406	20.0	62.0	36.0	6.00
R4579/64	9/64	3.57	0.1406	20.0	62.0	36.0	6.00
R4573.6	–	3.60	0.1417	20.0	62.0	36.0	6.00
R457N27	N27	3.66	0.1441	20.0	62.0	36.0	6.00
R4573.7	–	3.70	0.1457	20.0	62.0	36.0	6.00
R457N26	N26	3.73	0.1469	24.0	66.0	36.0	6.00
R457N25	N25	3.80	0.1496	24.0	66.0	36.0	6.00
R4573.8	–	3.80	0.1496	24.0	66.0	36.0	6.00
R457N24	N24	3.86	0.1520	24.0	66.0	36.0	6.00
R4573.9	–	3.90	0.1535	24.0	66.0	36.0	6.00
R457N23	N23	3.91	0.1539	24.0	66.0	36.0	6.00
R4575/32	5/32	3.97	0.1563	24.0	66.0	36.0	6.00
R457N22	N22	3.99	0.1571	24.0	66.0	36.0	6.00
R4574.0	–	4.00	0.1575	24.0	66.0	36.0	6.00
R457N21	N21	4.04	0.1591	24.0	66.0	36.0	6.00
R4574.05	–	4.05	0.1594	24.0	66.0	36.0	6.00



Product	DC	DC	DC	LCF	OAL	LS	DCON MS
	(inch)	(mm)	(inch)	(mm)	(mm)	(mm)	(mm)
R457N20	N20	4.09	0.1610	24.0	66.0	36.0	6.00
R4574.1	–	4.10	0.1614	24.0	66.0	36.0	6.00
R4574.2	–	4.20	0.1654	24.0	66.0	36.0	6.00
R457N19	N19	4.22	0.1661	24.0	66.0	36.0	6.00
R4574.3	–	4.30	0.1693	24.0	66.0	36.0	6.00
R457N18	N18	4.31	0.1697	24.0	66.0	36.0	6.00
R45711/64	11/64	4.37	0.1719	24.0	66.0	36.0	6.00
R457N17	N17	4.39	0.1728	24.0	66.0	36.0	6.00
R4574.4	–	4.40	0.1732	24.0	66.0	36.0	6.00
R4574.5	–	4.50	0.1772	24.0	66.0	36.0	6.00
R457N16	N16	4.50	0.1772	24.0	66.0	36.0	6.00
R457N15	N15	4.57	0.1799	24.0	66.0	36.0	6.00
R4574.6	–	4.60	0.1811	24.0	66.0	36.0	6.00
R457N14	N14	4.62	0.1819	24.0	66.0	36.0	6.00
R457N13	N13	4.70	0.1850	24.0	66.0	36.0	6.00
R4574.7	–	4.70	0.1850	24.0	66.0	36.0	6.00
R4573/16	3/16	4.76	0.1875	28.0	66.0	36.0	6.00
R4574.8	–	4.80	0.1890	28.0	66.0	36.0	6.00
R457N12	N12	4.80	0.1890	28.0	66.0	36.0	6.00
R457N11	N11	4.85	0.1909	28.0	66.0	36.0	6.00
R4574.9	–	4.90	0.1929	28.0	66.0	36.0	6.00
R457N10	N10	4.92	0.1937	28.0	66.0	36.0	6.00
R457N9	N9	4.98	0.1961	28.0	66.0	36.0	6.00
R4575.0	–	5.00	0.1969	28.0	66.0	36.0	6.00
R4575.05	–	5.05	0.1988	28.0	66.0	36.0	6.00
R457N8	N8	5.06	0.1992	28.0	66.0	36.0	6.00
R4575.1	–	5.10	0.2008	28.0	66.0	36.0	6.00
R457N7	N7	5.11	0.2010	28.0	66.0	36.0	6.00
R45713/64	13/64	5.16	0.2031	28.0	66.0	36.0	6.00
R457N6	N6	5.18	0.2039	28.0	66.0	36.0	6.00
R4575.2	–	5.20	0.2047	28.0	66.0	36.0	6.00
R457N5	N5	5.22	0.2055	28.0	66.0	36.0	6.00
R4575.3	–	5.30	0.2087	28.0	66.0	36.0	6.00
R457N4	N4	5.31	0.2091	28.0	66.0	36.0	6.00
R4575.4	–	5.40	0.2126	28.0	66.0	36.0	6.00
R457N3	N3	5.41	0.2130	28.0	66.0	36.0	6.00
R4575.5	–	5.50	0.2165	28.0	66.0	36.0	6.00
R4577/32	7/32	5.56	0.2188	28.0	66.0	36.0	6.00
R4575.6	–	5.60	0.2205	28.0	66.0	36.0	6.00
R457N2	N2	5.61	0.2209	28.0	66.0	36.0	6.00
R4575.7	–	5.70	0.2244	28.0	66.0	36.0	6.00
R457N1	N1	5.79	0.2280	28.0	66.0	36.0	6.00
R4575.8	–	5.80	0.2283	28.0	66.0	36.0	6.00
R4575.9	–	5.90	0.2323	28.0	66.0	36.0	6.00
R457A	A	5.94	0.2339	28.0	66.0	36.0	6.00
R45715/64	15/64	5.95	0.2344	28.0	66.0	36.0	6.00
R4576.0	–	6.00	0.2362	28.0	66.0	36.0	6.00
R457B	B	6.05	0.2380	34.0	79.0	36.0	8.00
R4576.05	–	6.05	0.2382	34.0	79.0	36.0	8.00
R4576.1	–	6.10	0.2402	34.0	79.0	36.0	8.00
R457C	C	6.15	0.2421	34.0	79.0	36.0	8.00
R4576.2	–	6.20	0.2441	34.0	79.0	36.0	8.00
R457D	D	6.25	0.2461	34.0	79.0	36.0	8.00
R4576.3	–	6.30	0.2480	34.0	79.0	36.0	8.00
R4571/4	1/4	6.35	0.2500	34.0	79.0	36.0	8.00
R457E	E	6.35	0.2500	34.0	79.0	36.0	8.00
R4576.4	–	6.40	0.2520	34.0	79.0	36.0	8.00
R4576.5	–	6.50	0.2559	34.0	79.0	36.0	8.00
R457F	F	6.53	0.2571	34.0	79.0	36.0	8.00
R4576.6	–	6.60	0.2598	34.0	79.0	36.0	8.00
R457G	G	6.63	0.2610	34.0	79.0	36.0	8.00
R4576.7	–	6.70	0.2638	34.0	79.0	36.0	8.00
R45717/64	17/64	6.75	0.2656	34.0	79.0	36.0	8.00
R457H	H	6.76	0.2661	34.0	79.0	36.0	8.00
R4576.8	–	6.80	0.2677	34.0	79.0	36.0	8.00



Product	DC	DC	DC	LCF	OAL	LS	DCON MS
	(inch)	(mm)	(inch)	(mm)	(mm)	(mm)	(mm)
R4576.9	—	6.90	0.2717	34.0	79.0	36.0	8.00
R457I	I	6.91	0.2720	34.0	79.0	36.0	8.00
R4577.0	—	7.00	0.2756	34.0	79.0	36.0	8.00
R457J	J	7.04	0.2772	41.0	79.0	36.0	8.00
R4577.1	—	7.10	0.2795	41.0	79.0	36.0	8.00
R457K	K	7.14	0.2811	41.0	79.0	36.0	8.00
R4579/32	9/32	7.14	0.2813	41.0	79.0	36.0	8.00
R4577.2	—	7.20	0.2835	41.0	79.0	36.0	8.00
R4577.3	—	7.30	0.2874	41.0	79.0	36.0	8.00
R457L	L	7.37	0.2902	41.0	79.0	36.0	8.00
R4577.4	—	7.40	0.2913	41.0	79.0	36.0	8.00
R457M	M	7.49	0.2949	41.0	79.0	36.0	8.00
R4577.5	—	7.50	0.2953	41.0	79.0	36.0	8.00
R45719/64	19/64	7.54	0.2969	41.0	79.0	36.0	8.00
R4577.6	—	7.60	0.2992	41.0	79.0	36.0	8.00
R457N	N	7.67	0.3020	41.0	79.0	36.0	8.00
R4577.7	—	7.70	0.3031	41.0	79.0	36.0	8.00
R4577.8	—	7.80	0.3071	41.0	79.0	36.0	8.00
R4577.9	—	7.90	0.3110	41.0	79.0	36.0	8.00
R4575/16	5/16	7.94	0.3125	41.0	79.0	36.0	8.00
R4578.0	—	8.00	0.3150	41.0	79.0	36.0	8.00
R457O	O	8.03	0.3161	47.0	89.0	40.0	10.00
R4578.05	—	8.05	0.3169	47.0	89.0	40.0	10.00
R4578.1	—	8.10	0.3189	47.0	89.0	40.0	10.00
R4578.2	—	8.20	0.3228	47.0	89.0	40.0	10.00
R457P	P	8.20	0.3228	47.0	89.0	40.0	10.00
R4578.3	—	8.30	0.3268	47.0	89.0	40.0	10.00
R45721/64	21/64	8.33	0.3281	47.0	89.0	40.0	10.00
R4578.4	—	8.40	0.3307	47.0	89.0	40.0	10.00
R457Q	Q	8.43	0.3319	47.0	89.0	40.0	10.00
R4578.5	—	8.50	0.3346	47.0	89.0	40.0	10.00
R4578.6	—	8.60	0.3386	47.0	89.0	40.0	10.00
R457R	R	8.61	0.3390	47.0	89.0	40.0	10.00
R4578.7	—	8.70	0.3425	47.0	89.0	40.0	10.00
R45711/32	11/32	8.73	0.3438	47.0	89.0	40.0	10.00
R4578.8	—	8.80	0.3465	47.0	89.0	40.0	10.00
R457S	S	8.84	0.3480	47.0	89.0	40.0	10.00
R4578.9	—	8.90	0.3504	47.0	89.0	40.0	10.00
R4579.0	—	9.00	0.3543	47.0	89.0	40.0	10.00
R457T	T	9.09	0.3579	47.0	89.0	40.0	10.00
R4579.1	—	9.10	0.3583	47.0	89.0	40.0	10.00
R45723/64	23/64	9.13	0.3594	47.0	89.0	40.0	10.00
R4579.2	—	9.20	0.3622	47.0	89.0	40.0	10.00
R4579.3	—	9.30	0.3661	47.0	89.0	40.0	10.00
R457U	U	9.35	0.3681	47.0	89.0	40.0	10.00
R4579.4	—	9.40	0.3701	47.0	89.0	40.0	10.00
R4579.5	—	9.50	0.3740	47.0	89.0	40.0	10.00
R4573/8	3/8	9.53	0.3750	47.0	89.0	40.0	10.00
R457V	V	9.58	0.3772	47.0	89.0	40.0	10.00
R4579.6	—	9.60	0.3780	47.0	89.0	40.0	10.00
R4579.7	—	9.70	0.3819	47.0	89.0	40.0	10.00
R4579.8	—	9.80	0.3858	47.0	89.0	40.0	10.00
R457W	W	9.80	0.3858	47.0	89.0	40.0	10.00
R4579.9	—	9.90	0.3898	47.0	89.0	40.0	10.00
R45725/64	25/64	9.92	0.3906	47.0	89.0	40.0	10.00
R45710.0	—	10.00	0.3937	47.0	89.0	40.0	10.00
R45710.05	—	10.05	0.3957	55.0	102.0	45.0	12.00
R457X	X	10.08	0.3969	55.0	102.0	45.0	12.00
R45710.1	—	10.10	0.3976	55.0	102.0	45.0	12.00
R45710.2	—	10.20	0.4016	55.0	102.0	45.0	12.00
R457Y	Y	10.26	0.4039	55.0	102.0	45.0	12.00
R45710.3	—	10.30	0.4055	55.0	102.0	45.0	12.00
R45713/32	13/32	10.32	0.4063	55.0	102.0	45.0	12.00
R45710.4	—	10.40	0.4094	55.0	102.0	45.0	12.00
R457Z	Z	10.49	0.4130	55.0	102.0	45.0	12.00



Product	DC	DC	DC	LCF	OAL	LS	DCON MS
	(inch)	(mm)	(inch)	(mm)	(mm)	(mm)	(mm)
R45710.5	–	10.50	0.4134	55.0	102.0	45.0	12.00
R45710.6	–	10.60	0.4173	55.0	102.0	45.0	12.00
R45727/64	27/64	10.72	0.4219	55.0	102.0	45.0	12.00
R45710.8	–	10.80	0.4252	55.0	102.0	45.0	12.00
R45711.0	–	11.00	0.4331	55.0	102.0	45.0	12.00
R4577/16	7/16	11.11	0.4375	55.0	102.0	45.0	12.00
R45711.2	–	11.20	0.4409	55.0	102.0	45.0	12.00
R45711.3	–	11.30	0.4449	55.0	102.0	45.0	12.00
R45711.4	–	11.40	0.4488	55.0	102.0	45.0	12.00
R45711.5	–	11.50	0.4528	55.0	102.0	45.0	12.00
R45729/64	29/64	11.51	0.4531	55.0	102.0	45.0	12.00
R45711.6	–	11.60	0.4567	55.0	102.0	45.0	12.00
R45711.8	–	11.80	0.4646	55.0	102.0	45.0	12.00
R45715/32	15/32	11.91	0.4688	55.0	102.0	45.0	12.00
R45712.0	–	12.00	0.4724	55.0	102.0	45.0	12.00
R45712.05	–	12.05	0.4744	60.0	107.0	45.0	14.00
R45712.1	–	12.10	0.4764	60.0	107.0	45.0	14.00
R45712.2	–	12.20	0.4803	60.0	107.0	45.0	14.00
R45731/64	31/64	12.30	0.4844	60.0	107.0	45.0	14.00
R45712.5	–	12.50	0.4921	60.0	107.0	45.0	14.00
R45712.7	–	12.70	0.5000	60.0	107.0	45.0	14.00
R4571/2	1/2	12.70	0.5000	60.0	107.0	45.0	14.00
R45712.8	–	12.80	0.5039	60.0	107.0	45.0	14.00
R45713.0	–	13.00	0.5118	60.0	107.0	45.0	14.00
R45733/64	33/64	13.10	0.5156	60.0	107.0	45.0	14.00
R45713.3	–	13.30	0.5236	60.0	107.0	45.0	14.00
R45717/32	17/32	13.49	0.5313	60.0	107.0	45.0	14.00
R45713.5	–	13.50	0.5315	60.0	107.0	45.0	14.00
R45713.8	–	13.80	0.5433	60.0	107.0	45.0	14.00
R45735/64	35/64	13.89	0.5469	60.0	107.0	45.0	14.00
R45714.0	–	14.00	0.5512	60.0	107.0	45.0	14.00
R45714.25	–	14.25	0.5610	65.0	115.0	48.0	16.00
R4579/16	9/16	14.29	0.5625	65.0	115.0	48.0	16.00
R45714.5	–	14.50	0.5709	65.0	115.0	48.0	16.00
R45737/64	37/64	14.68	0.5781	65.0	115.0	48.0	16.00
R45714.8	–	14.80	0.5827	65.0	115.0	48.0	16.00
R45715.0	–	15.00	0.5906	65.0	115.0	48.0	16.00
R45719/32	19/32	15.08	0.5938	65.0	115.0	48.0	16.00
R45715.1	–	15.10	0.5945	65.0	115.0	48.0	16.00
R45715.3	–	15.30	0.6024	65.0	115.0	48.0	16.00
R45739/64	39/64	15.48	0.6094	65.0	115.0	48.0	16.00
R45715.5	–	15.50	0.6102	65.0	115.0	48.0	16.00
R45715.8	–	15.80	0.6220	65.0	115.0	48.0	16.00
R4575/8	5/8	15.88	0.6250	65.0	115.0	48.0	16.00
R45716.0	–	16.00	0.6299	65.0	115.0	48.0	16.00
R45741/64	41/64	16.27	0.6406	73.0	123.0	48.0	18.00
R45716.5	–	16.50	0.6496	73.0	123.0	48.0	18.00
R45721/32	21/32	16.67	0.6563	73.0	123.0	48.0	18.00
R45717.0	–	17.00	0.6693	73.0	123.0	48.0	18.00
R45743/64	43/64	17.07	0.6720	73.0	123.0	48.0	18.00
R45711/16	11/16	17.46	0.6874	73.0	123.0	48.0	18.00
R45717.5	–	17.50	0.6890	73.0	123.0	48.0	18.00
R45745/64	45/64	17.86	0.7031	73.0	123.0	48.0	18.00
R45718.0	–	18.00	0.7087	73.0	123.0	48.0	18.00
R45723/32	23/32	18.26	0.7189	79.0	131.0	50.0	20.00
R45718.5	–	18.50	0.7283	79.0	131.0	50.0	20.00
R45747/64	47/64	18.65	0.7343	79.0	131.0	50.0	20.00
R45718.8	–	18.80	0.7402	79.0	131.0	50.0	20.00
R45719.0	–	19.00	0.7480	79.0	131.0	50.0	20.00
R4573/4	3/4	19.05	0.7500	79.0	131.0	50.0	20.00
R45719.5	–	19.50	0.7677	79.0	131.0	50.0	20.00
R45719.8	–	19.80	0.7795	79.0	131.0	50.0	20.00
R45720.0	–	20.00	0.7874	79.0	131.0	50.0	20.00



R454



FORCE X VHM productieboor, 5xD, TiAlN gecoat

Hoogproductieve boor, in staat om gaten van hoge kwaliteit en nauwkeurigheid te maken bij hoge verspaningscondities (H9 gattolerantie). Zelfcenterende 140°, 4-vlaks split point en CTW spaangroefontwerp voor hoge voedingsnelheden. TiAlN coating verhoogt de hardheid van het oppervlak en verbetert de standtijd van het gereedschap.

FORCE X

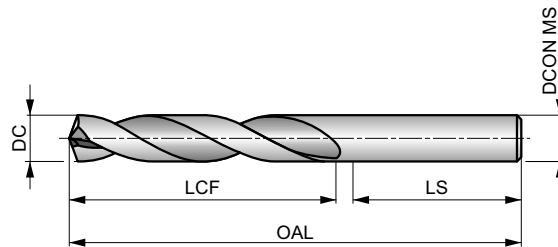

HM	DIN 6537L	5xD
140°	TiAlN	DIN 6535HA
CTW	DC m7	

De tabel geeft de geschiktheid aan voor de materiaalgroep en de startwaarden voor de snijsnelheid (m/min) en de letter verwijst naar de toe te passen voeding (fn), zie vanaf pagina 65.

P1.1 ■ 134 V	P1.2 ■ 150 V	P1.3 ■ 155 V	P2.1 ■ 115 V	P2.2 ■ 101 V	P2.3 ■ 89 V	P3.1 ■ 100 V	P3.2 ■ 80 V	P3.3 ■ 68 V	P4.1 ■ 59 V	P4.2 ■ 50 V	P4.3 ■ 41 U	M1.1 ■ 56 U	M1.2 ■ 48 U
M2.1 ■ 50 U	M2.2 ■ 41 U	M2.3 ■ 35 T	M3.1 ■ 31 T	M3.2 ■ 26 T	M3.3 ■ 24 T	M4.1 ■ 23 T	M4.2 ■ 20 T	K1.1 ■ 83 W	K1.2 ■ 61 W	K1.3 ■ 46 W	K2.1 ■ 74 V	K2.2 ■ 60 V	K2.3 ■ 48 V
K3.1 ■ 65 V	K3.2 ■ 50 V	K3.3 ■ 41 V	K4.1 ■ 61 V	K4.2 ■ 46 V	K4.3 ■ 34 V	K4.4 ■ 29 V	K4.5 ■ 24 V	K5.1 ■ 68 V	K5.2 ■ 52 V	K5.3 ■ 40 V	N1.1 ■ 188 W	N1.2 ■ 141 W	N1.3 ■ 94 W
N2.1 ■ 231 V	N2.2 ■ 208 V	N2.3 ■ 150 V	N3.1 ■ 280 V	N3.2 ■ 165 V	N3.3 ■ 83 V	S1.1 ■ 41 U	S1.2 ■ 34 U	S1.3 ■ 30 T	H1.1 ■ 42 U	H2.1 ■ 25 U	H2.2 ■ 23 U	H3.1 ■ 28 U	H3.2 ■ 23 U

DCON MS passing h6.

Product	DC (inch)	DC (mm)	DC (inch)	LCF (mm)	OAL (mm)	LS (mm)	DCON MS (mm)
R4543.0	–	3.00	0.1181	28.0	66.0	36.0	6.00
R4543.1	–	3.10	0.1220	28.0	66.0	36.0	6.00
R4541/8	1/8	3.18	0.1250	28.0	66.0	36.0	6.00
R4543.2	–	3.20	0.1260	28.0	66.0	36.0	6.00
R454N30	N30	3.26	0.1283	28.0	66.0	36.0	6.00
R4543.3	–	3.30	0.1299	28.0	66.0	36.0	6.00
R4543.4	–	3.40	0.1339	28.0	66.0	36.0	6.00
R454N29	N29	3.45	0.1360	28.0	66.0	36.0	6.00
R4543.5	–	3.50	0.1378	28.0	66.0	36.0	6.00
R454N28	N28	3.57	0.1406	28.0	66.0	36.0	6.00
R4549/64	9/64	3.57	0.1406	28.0	66.0	36.0	6.00
R4543.6	–	3.60	0.1417	28.0	66.0	36.0	6.00
R454N27	N27	3.66	0.1441	28.0	66.0	36.0	6.00
R4543.7	–	3.70	0.1457	28.0	66.0	36.0	6.00
R454N26	N26	3.73	0.1469	36.0	74.0	36.0	6.00
R454N25	N25	3.80	0.1496	36.0	74.0	36.0	6.00
R4543.8	–	3.80	0.1496	36.0	74.0	36.0	6.00
R454N24	N24	3.86	0.1520	36.0	74.0	36.0	6.00
R4543.9	–	3.90	0.1535	36.0	74.0	36.0	6.00
R454N23	N23	3.91	0.1539	36.0	74.0	36.0	6.00
R4545/32	5/32	3.97	0.1563	36.0	74.0	36.0	6.00
R454N22	N22	3.99	0.1571	36.0	74.0	36.0	6.00
R4544.0	–	4.00	0.1575	36.0	74.0	36.0	6.00
R454N21	N21	4.04	0.1591	36.0	74.0	36.0	6.00
R454N20	N20	4.09	0.1610	36.0	74.0	36.0	6.00



Product	DC	DC	DC	LCF	OAL	LS	DCON MS
	(inch)	(mm)	(inch)	(mm)	(mm)	(mm)	(mm)
R4544.1	–	4.10	0.1614	36.0	74.0	36.0	6.00
R4544.2	–	4.20	0.1654	36.0	74.0	36.0	6.00
R454N19	N19	4.22	0.1661	36.0	74.0	36.0	6.00
R4544.3	–	4.30	0.1693	36.0	74.0	36.0	6.00
R454N18	N18	4.31	0.1697	36.0	74.0	36.0	6.00
R45411/64	11/64	4.37	0.1719	36.0	74.0	36.0	6.00
R454N17	N17	4.39	0.1728	36.0	74.0	36.0	6.00
R4544.4	–	4.40	0.1732	36.0	74.0	36.0	6.00
R4544.5	–	4.50	0.1772	36.0	74.0	36.0	6.00
R454N16	N16	4.50	0.1772	36.0	74.0	36.0	6.00
R454N15	N15	4.57	0.1799	36.0	74.0	36.0	6.00
R4544.6	–	4.60	0.1811	36.0	74.0	36.0	6.00
R454N14	N14	4.62	0.1819	36.0	74.0	36.0	6.00
R454N13	N13	4.70	0.1850	36.0	74.0	36.0	6.00
R4544.7	–	4.70	0.1850	36.0	74.0	36.0	6.00
R4543/16	3/16	4.76	0.1875	44.0	82.0	36.0	6.00
R454N12	N12	4.80	0.1890	44.0	82.0	36.0	6.00
R4544.8	–	4.80	0.1890	44.0	82.0	36.0	6.00
R454N11	N11	4.85	0.1909	44.0	82.0	36.0	6.00
R4544.9	–	4.90	0.1929	44.0	82.0	36.0	6.00
R454N10	N10	4.92	0.1937	44.0	82.0	36.0	6.00
R454N9	N9	4.98	0.1961	44.0	82.0	36.0	6.00
R4545.0	–	5.00	0.1969	44.0	82.0	36.0	6.00
R454N8	N8	5.06	0.1992	44.0	82.0	36.0	6.00
R4545.1	–	5.10	0.2008	44.0	82.0	36.0	6.00
R454N7	N7	5.11	0.2010	44.0	82.0	36.0	6.00
R45413/64	13/64	5.16	0.2031	44.0	82.0	36.0	6.00
R454N6	N6	5.18	0.2039	44.0	82.0	36.0	6.00
R4545.2	–	5.20	0.2047	44.0	82.0	36.0	6.00
R454N5	N5	5.22	0.2055	44.0	82.0	36.0	6.00
R454N4	N4	5.31	0.2091	44.0	82.0	36.0	6.00
R454N3	N3	5.41	0.2130	44.0	82.0	36.0	6.00
R4545.5	–	5.50	0.2165	44.0	82.0	36.0	6.00
R4547/32	7/32	5.56	0.2188	44.0	82.0	36.0	6.00
R4545.6	–	5.60	0.2205	44.0	82.0	36.0	6.00
R454N2	N2	5.61	0.2209	44.0	82.0	36.0	6.00
R4545.7	–	5.70	0.2244	44.0	82.0	36.0	6.00
R454N1	N1	5.79	0.2280	44.0	82.0	36.0	6.00
R4545.8	–	5.80	0.2283	44.0	82.0	36.0	6.00
R454A	A	5.94	0.2339	44.0	82.0	36.0	6.00
R45415/64	15/64	5.95	0.2344	44.0	82.0	36.0	6.00
R4546.0	–	6.00	0.2362	44.0	82.0	36.0	6.00
R454B	B	6.05	0.2380	53.0	91.0	36.0	8.00
R4546.1	–	6.10	0.2402	53.0	91.0	36.0	8.00
R454C	C	6.15	0.2421	53.0	91.0	36.0	8.00
R4546.2	–	6.20	0.2441	53.0	91.0	36.0	8.00
R454D	D	6.25	0.2461	53.0	91.0	36.0	8.00
R4546.3	–	6.30	0.2480	53.0	91.0	36.0	8.00
R4541/4	1/4	6.35	0.2500	53.0	91.0	36.0	8.00
R454E	E	6.35	0.2500	53.0	91.0	36.0	8.00
R4546.4	–	6.40	0.2520	53.0	91.0	36.0	8.00
R4546.5	–	6.50	0.2559	53.0	91.0	36.0	8.00
R454F	F	6.53	0.2571	53.0	91.0	36.0	8.00
R4546.6	–	6.60	0.2598	53.0	91.0	36.0	8.00
R454G	G	6.63	0.2610	53.0	91.0	36.0	8.00
R4546.7	–	6.70	0.2638	53.0	91.0	36.0	8.00
R45417/64	17/64	6.75	0.2656	53.0	91.0	36.0	8.00
R454H	H	6.76	0.2661	53.0	91.0	36.0	8.00
R4546.8	–	6.80	0.2677	53.0	91.0	36.0	8.00
R4546.9	–	6.90	0.2717	53.0	91.0	36.0	8.00
R454I	I	6.91	0.2720	53.0	91.0	36.0	8.00
R4547.0	–	7.00	0.2756	53.0	91.0	36.0	8.00



Product	DC	DC	DC	LCF	OAL	LS	DCON MS
	(inch)	(mm)	(inch)	(mm)	(mm)	(mm)	(mm)
R454J	J	7.04	0.2772	53.0	91.0	36.0	8.00
R4547.1	—	7.10	0.2795	53.0	91.0	36.0	8.00
R454K	K	7.14	0.2811	53.0	91.0	36.0	8.00
R4549/32	9/32	7.14	0.2813	53.0	91.0	36.0	8.00
R4547.3	—	7.30	0.2874	53.0	91.0	36.0	8.00
R454L	L	7.37	0.2902	53.0	91.0	36.0	8.00
R4547.4	—	7.40	0.2913	53.0	91.0	36.0	8.00
R454M	M	7.49	0.2949	53.0	91.0	36.0	8.00
R4547.5	—	7.50	0.2953	53.0	91.0	36.0	8.00
R45419/64	19/64	7.54	0.2969	53.0	91.0	36.0	8.00
R4547.6	—	7.60	0.2992	53.0	91.0	36.0	8.00
R454N	N	7.67	0.3020	53.0	91.0	36.0	8.00
R4547.7	—	7.70	0.3031	53.0	91.0	36.0	8.00
R4547.8	—	7.80	0.3071	53.0	91.0	36.0	8.00
R4547.9	—	7.90	0.3110	53.0	91.0	36.0	8.00
R4545/16	5/16	7.94	0.3125	53.0	91.0	36.0	8.00
R4548.0	—	8.00	0.3150	53.0	91.0	36.0	8.00
R454O	O	8.03	0.3161	61.0	103.0	40.0	10.00
R4548.1	—	8.10	0.3189	61.0	103.0	40.0	10.00
R4548.2	—	8.20	0.3228	61.0	103.0	40.0	10.00
R454P	P	8.20	0.3228	61.0	103.0	40.0	10.00
R45421/64	21/64	8.33	0.3281	61.0	103.0	40.0	10.00
R4548.4	—	8.40	0.3307	61.0	103.0	40.0	10.00
R454Q	Q	8.43	0.3319	61.0	103.0	40.0	10.00
R4548.5	—	8.50	0.3346	61.0	103.0	40.0	10.00
R4548.6	—	8.60	0.3386	61.0	103.0	40.0	10.00
R454R	R	8.61	0.3390	61.0	103.0	40.0	10.00
R4548.7	—	8.70	0.3425	61.0	103.0	40.0	10.00
R45411/32	11/32	8.73	0.3438	61.0	103.0	40.0	10.00
R4548.8	—	8.80	0.3465	61.0	103.0	40.0	10.00
R454S	S	8.84	0.3480	61.0	103.0	40.0	10.00
R4548.9	—	8.90	0.3504	61.0	103.0	40.0	10.00
R4549.0	—	9.00	0.3543	61.0	103.0	40.0	10.00
R454T	T	9.09	0.3579	61.0	103.0	40.0	10.00
R4549.1	—	9.10	0.3583	61.0	103.0	40.0	10.00
R45423/64	23/64	9.13	0.3594	61.0	103.0	40.0	10.00
R4549.3	—	9.30	0.3661	61.0	103.0	40.0	10.00
R454U	U	9.35	0.3681	61.0	103.0	40.0	10.00
R4549.4	—	9.40	0.3701	61.0	103.0	40.0	10.00
R4549.5	—	9.50	0.3740	61.0	103.0	40.0	10.00
R4543/8	3/8	9.53	0.3750	61.0	103.0	40.0	10.00
R454V	V	9.58	0.3772	61.0	103.0	40.0	10.00
R4549.6	—	9.60	0.3780	61.0	103.0	40.0	10.00
R4549.7	—	9.70	0.3819	61.0	103.0	40.0	10.00
R4549.8	—	9.80	0.3858	61.0	103.0	40.0	10.00
R4549.9	—	9.90	0.3898	61.0	103.0	40.0	10.00
R454W	W	9.80	0.3858	61.0	103.0	40.0	10.00
R45425/64	25/64	9.92	0.3906	61.0	103.0	40.0	10.00
R45410.0	—	10.00	0.3937	61.0	103.0	40.0	10.00
R454X	X	10.08	0.3969	70.0	118.0	45.0	12.00
R45410.1	—	10.10	0.3976	70.0	118.0	45.0	12.00
R45410.2	—	10.20	0.4016	70.0	118.0	45.0	12.00
R454Y	Y	10.26	0.4039	70.0	118.0	45.0	12.00
R45410.3	—	10.30	0.4055	70.0	118.0	45.0	12.00
R45413/32	13/32	10.32	0.4063	70.0	118.0	45.0	12.00
R45410.4	—	10.40	0.4094	70.0	118.0	45.0	12.00
R454Z	Z	10.49	0.4130	70.0	118.0	45.0	12.00
R45410.5	—	10.50	0.4134	70.0	118.0	45.0	12.00
R45410.6	—	10.60	0.4173	70.0	118.0	45.0	12.00
R45427/64	27/64	10.72	0.4219	70.0	118.0	45.0	12.00
R45411.0	—	11.00	0.4331	70.0	118.0	45.0	12.00
R4547/16	7/16	11.11	0.4375	70.0	118.0	45.0	12.00



Product	DC	DC	DC	LCF	OAL	LS	DCON MS
	(inch)	(mm)	(inch)	(mm)	(mm)	(mm)	(mm)
R45411.2	–	11.20	0.4409	70.0	118.0	45.0	12.00
R45411.4	–	11.40	0.4488	70.0	118.0	45.0	12.00
R45411.5	–	11.50	0.4528	70.0	118.0	45.0	12.00
R45429/64	29/64	11.51	0.4531	70.0	118.0	45.0	12.00
R45411.6	–	11.60	0.4567	70.0	118.0	45.0	12.00
R45411.8	–	11.80	0.4646	70.0	118.0	45.0	12.00
R45415/32	15/32	11.91	0.4688	70.0	118.0	45.0	12.00
R45412.0	–	12.00	0.4724	70.0	118.0	45.0	12.00
R45412.1	–	12.10	0.4764	76.0	124.0	45.0	14.00
R45412.2	–	12.20	0.4803	76.0	124.0	45.0	14.00
R45431/64	31/64	12.30	0.4844	76.0	124.0	45.0	14.00
R45412.5	–	12.50	0.4921	76.0	124.0	45.0	14.00
R45412.7	–	12.70	0.5000	76.0	124.0	45.0	14.00
R4541/2	1/2	12.70	0.5000	76.0	124.0	45.0	14.00
R45412.8	–	12.80	0.5039	76.0	124.0	45.0	14.00
R45413.0	–	13.00	0.5118	76.0	124.0	45.0	14.00
R45433/64	33/64	13.10	0.5156	76.0	124.0	45.0	14.00
R45417/32	17/32	13.49	0.5313	76.0	124.0	45.0	14.00
R45413.5	–	13.50	0.5315	76.0	124.0	45.0	14.00
R45413.8	–	13.80	0.5433	76.0	124.0	45.0	14.00
R45435/64	35/64	13.89	0.5469	76.0	124.0	45.0	14.00
R45414.0	–	14.00	0.5512	76.0	124.0	45.0	14.00
R45414.25	–	14.25	0.5610	82.0	133.0	48.0	16.00
R4549/16	9/16	14.29	0.5625	82.0	133.0	48.0	16.00
R45414.5	–	14.50	0.5709	82.0	133.0	48.0	16.00
R45437/64	37/64	14.68	0.5781	82.0	133.0	48.0	16.00
R45414.8	–	14.80	0.5827	82.0	133.0	48.0	16.00
R45415.0	–	15.00	0.5906	82.0	133.0	48.0	16.00
R45419/32	19/32	15.08	0.5938	82.0	133.0	48.0	16.00
R45415.1	–	15.10	0.5945	82.0	133.0	48.0	16.00
R45439/64	39/64	15.48	0.6094	82.0	133.0	48.0	16.00
R45415.5	–	15.50	0.6102	82.0	133.0	48.0	16.00
R45415.8	–	15.80	0.6220	82.0	133.0	48.0	16.00
R4545/8	5/8	15.88	0.6250	82.0	133.0	48.0	16.00
R45416.0	–	16.00	0.6299	82.0	133.0	48.0	16.00
R45441/64	41/64	16.27	0.6406	91.0	143.0	48.0	18.00
R45416.5	–	16.50	0.6496	91.0	143.0	48.0	18.00
R45421/32	21/32	16.67	0.6563	91.0	143.0	48.0	18.00
R45417.0	–	17.00	0.6693	91.0	143.0	48.0	18.00
R45443/64	43/64	17.07	0.6720	91.0	143.0	48.0	18.00
R45411/16	11/16	17.46	0.6874	91.0	143.0	48.0	18.00
R45417.5	–	17.50	0.6890	91.0	143.0	48.0	18.00
R45417.8	–	17.80	0.7008	91.0	143.0	48.0	18.00
R45445/64	45/64	17.86	0.7031	91.0	143.0	48.0	18.00
R45418.0	–	18.00	0.7087	91.0	143.0	48.0	18.00
R45423/32	23/32	18.26	0.7189	99.0	153.0	50.0	20.00
R45418.5	–	18.50	0.7283	99.0	153.0	50.0	20.00
R45447/64	47/64	18.65	0.7343	99.0	153.0	50.0	20.00
R45419.0	–	19.00	0.7480	99.0	153.0	50.0	20.00
R4543/4	3/4	19.05	0.7500	99.0	153.0	50.0	20.00
R45419.5	–	19.50	0.7677	99.0	153.0	50.0	20.00
R45419.8	–	19.80	0.7795	99.0	153.0	50.0	20.00
R45420.0	–	20.00	0.7874	99.0	153.0	50.0	20.00



R453



FORCE X VHM productieboor, 5xD, koelkanalen, TiAlN gecoat

Hoogproductieve boor, voor gaten van hoge kwaliteit en nauwkeurigheid bij hoge verspaningscondities (H9 gattolerantie). Zelfcenterende 140°, 4-vlaks split point en CTW spaangroefontwerp voor hoge voedingsnelheden. Koelkanalen voor betere spaanafvoer. TiAlN coating verhoogt de oppervlaktehardheid en verbetert de standtijd van het gereedschap. Met gladde (HA) eenheidschacht voor de hoogste rondloopnauwkeurigheid.

FORCE X

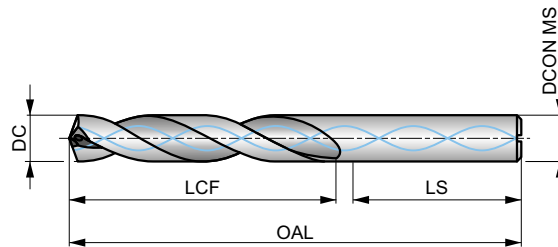

HM	DIN 6537L	5xD
140°	TiAlN	DIN 6535HA
CTW	DC m7	

De tabel geeft de geschiktheid aan voor de materiaalgroep en de startwaarden voor de snijsnelheid (m/min) en de letter verwijst naar de toe te passen voeding (fn), zie vanaf pagina 65.

P1.1 ■ 170 V	P1.2 ■ 190 V	P1.3 ■ 197 V	P2.1 ■ 145 V	P2.2 ■ 128 V	P2.3 ■ 113 V	P3.1 ■ 126 V	P3.2 ■ 102 V	P3.3 ■ 86 V	P4.1 ■ 75 V	P4.2 ■ 64 V	P4.3 ■ 52 U	M1.1 ■ 71 V	M1.2 ■ 61 V
M2.1 ■ 64 V	M2.2 ■ 52 V	M2.3 ■ 44 U	M3.1 ■ 39 V	M3.2 ■ 33 V	M3.3 ■ 30 V	M4.1 ■ 29 U	M4.2 ■ 25 U	K1.1 ■ 105 W	K1.2 ■ 77 W	K1.3 ■ 58 W	K2.1 ■ 93 V	K2.2 ■ 76 V	K2.3 ■ 61 V
K3.1 ■ 83 V	K3.2 ■ 64 V	K3.3 ■ 51 V	K4.1 ■ 77 V	K4.2 ■ 58 V	K4.3 ■ 43 V	K4.4 ■ 36 V	K4.5 ■ 30 V	K5.1 ■ 86 V	K5.2 ■ 66 V	K5.3 ■ 50 V	N1.1 ■ 238 W	N1.2 ■ 179 W	N1.3 ■ 119 W
N2.1 ■ 293 V	N2.2 ■ 263 V	N2.3 ■ 190 V	N3.1 ■ 354 W	N3.2 ■ 209 W	N3.3 ■ 105 W	S1.1 ■ 52 V	S1.2 ■ 43 V	S1.3 ■ 38 U	H1.1 ■ 53 U	H2.1 ■ 31 U	H2.2 ■ 29 U	H3.1 ■ 35 U	H3.2 ■ 29 U

DCON MS passing h6.

Product	DC (inch)	DC (mm)	DC (inch)	LCF (mm)	OAL (mm)	LS (mm)	DCON MS (mm)
R4533.0	–	3.00	0.1181	28.0	66.0	36.0	6.00
R4533.1	–	3.10	0.1220	28.0	66.0	36.0	6.00
R4531/8	1/8	3.18	0.1250	28.0	66.0	36.0	6.00
R4533.2	–	3.20	0.1260	28.0	66.0	36.0	6.00
R453N30	N30	3.26	0.1283	28.0	66.0	36.0	6.00
R4533.3	–	3.30	0.1299	28.0	66.0	36.0	6.00
R4533.4	–	3.40	0.1339	28.0	66.0	36.0	6.00
R453N29	N29	3.45	0.1360	28.0	66.0	36.0	6.00
R4533.5	–	3.50	0.1378	28.0	66.0	36.0	6.00
R453N28	N28	3.57	0.1406	28.0	66.0	36.0	6.00
R4539/64	9/64	3.57	0.1406	28.0	66.0	36.0	6.00
R4533.6	–	3.60	0.1417	28.0	66.0	36.0	6.00
R453N27	N27	3.66	0.1441	28.0	66.0	36.0	6.00
R4533.7	–	3.70	0.1457	28.0	66.0	36.0	6.00
R453N26	N26	3.73	0.1469	36.0	74.0	36.0	6.00
R453N25	N25	3.80	0.1496	36.0	74.0	36.0	6.00
R4533.8	–	3.80	0.1496	36.0	74.0	36.0	6.00
R453N24	N24	3.86	0.1520	36.0	74.0	36.0	6.00
R4533.9	–	3.90	0.1535	36.0	74.0	36.0	6.00
R453N23	N23	3.91	0.1539	36.0	74.0	36.0	6.00
R4535/32	5/32	3.97	0.1563	36.0	74.0	36.0	6.00
R453N22	N22	3.99	0.1571	36.0	74.0	36.0	6.00
R4534.0	–	4.00	0.1575	36.0	74.0	36.0	6.00
R453N21	N21	4.04	0.1591	36.0	74.0	36.0	6.00
R4534.05	–	4.05	0.1594	36.0	74.0	36.0	6.00



Product	DC	DC	DC	LCF	OAL	LS	DCON MS
	(inch)	(mm)	(inch)	(mm)	(mm)	(mm)	(mm)
R453N20	N20	4.09	0.1610	36.0	74.0	36.0	6.00
R4534.1	–	4.10	0.1614	36.0	74.0	36.0	6.00
R4534.2	–	4.20	0.1654	36.0	74.0	36.0	6.00
R453N19	N19	4.22	0.1661	36.0	74.0	36.0	6.00
R4534.3	–	4.30	0.1693	36.0	74.0	36.0	6.00
R453N18	N18	4.31	0.1697	36.0	74.0	36.0	6.00
R45311/64	11/64	4.37	0.1719	36.0	74.0	36.0	6.00
R453N17	N17	4.39	0.1728	36.0	74.0	36.0	6.00
R4534.4	–	4.40	0.1732	36.0	74.0	36.0	6.00
R4534.5	–	4.50	0.1772	36.0	74.0	36.0	6.00
R453N16	N16	4.50	0.1772	36.0	74.0	36.0	6.00
R453N15	N15	4.57	0.1799	36.0	74.0	36.0	6.00
R4534.6	–	4.60	0.1811	36.0	74.0	36.0	6.00
R453N14	N14	4.62	0.1819	36.0	74.0	36.0	6.00
R453N13	N13	4.70	0.1850	36.0	74.0	36.0	6.00
R4534.7	–	4.70	0.1850	36.0	74.0	36.0	6.00
R4533/16	3/16	4.76	0.1875	44.0	82.0	36.0	6.00
R4534.8	–	4.80	0.1890	44.0	82.0	36.0	6.00
R453N12	N12	4.80	0.1890	44.0	82.0	36.0	6.00
R453N11	N11	4.85	0.1909	44.0	82.0	36.0	6.00
R4534.9	–	4.90	0.1929	44.0	82.0	36.0	6.00
R453N10	N10	4.92	0.1937	44.0	82.0	36.0	6.00
R453N9	N9	4.98	0.1961	44.0	82.0	36.0	6.00
R4535.0	–	5.00	0.1969	44.0	82.0	36.0	6.00
R4535.05	–	5.05	0.1988	44.0	82.0	36.0	6.00
R453N8	N8	5.06	0.1992	44.0	82.0	36.0	6.00
R4535.1	–	5.10	0.2008	44.0	82.0	36.0	6.00
R453N7	N7	5.11	0.2010	44.0	82.0	36.0	6.00
R45313/64	13/64	5.16	0.2031	44.0	82.0	36.0	6.00
R453N6	N6	5.18	0.2039	44.0	82.0	36.0	6.00
R4535.2	–	5.20	0.2047	44.0	82.0	36.0	6.00
R453N5	N5	5.22	0.2055	44.0	82.0	36.0	6.00
R4535.3	–	5.30	0.2087	44.0	82.0	36.0	6.00
R453N4	N4	5.31	0.2091	44.0	82.0	36.0	6.00
R4535.4	–	5.40	0.2126	44.0	82.0	36.0	6.00
R453N3	N3	5.41	0.2130	44.0	82.0	36.0	6.00
R4535.5	–	5.50	0.2165	44.0	82.0	36.0	6.00
R4537/32	7/32	5.56	0.2188	44.0	82.0	36.0	6.00
R4535.6	–	5.60	0.2205	44.0	82.0	36.0	6.00
R453N2	N2	5.61	0.2209	44.0	82.0	36.0	6.00
R4535.7	–	5.70	0.2244	44.0	82.0	36.0	6.00
R453N1	N1	5.79	0.2280	44.0	82.0	36.0	6.00
R4535.8	–	5.80	0.2283	44.0	82.0	36.0	6.00
R4535.9	–	5.90	0.2323	44.0	82.0	36.0	6.00
R453A	A	5.94	0.2339	44.0	82.0	36.0	6.00
R45315/64	15/64	5.95	0.2344	44.0	82.0	36.0	6.00
R4536.0	–	6.00	0.2362	44.0	82.0	36.0	6.00
R453B	B	6.05	0.2380	53.0	91.0	36.0	8.00
R4536.05	–	6.05	0.2382	53.0	91.0	36.0	8.00
R4536.1	–	6.10	0.2402	53.0	91.0	36.0	8.00
R453C	C	6.15	0.2421	53.0	91.0	36.0	8.00
R4536.2	–	6.20	0.2441	53.0	91.0	36.0	8.00
R453D	D	6.25	0.2461	53.0	91.0	36.0	8.00
R4536.3	–	6.30	0.2480	53.0	91.0	36.0	8.00
R4531/4	1/4	6.35	0.2500	53.0	91.0	36.0	8.00
R453E	E	6.35	0.2500	53.0	91.0	36.0	8.00
R4536.4	–	6.40	0.2520	53.0	91.0	36.0	8.00
R4536.5	–	6.50	0.2559	53.0	91.0	36.0	8.00
R453F	F	6.53	0.2571	53.0	91.0	36.0	8.00
R4536.6	–	6.60	0.2598	53.0	91.0	36.0	8.00
R453G	G	6.63	0.2610	53.0	91.0	36.0	8.00
R4536.7	–	6.70	0.2638	53.0	91.0	36.0	8.00
R45317/64	17/64	6.75	0.2656	53.0	91.0	36.0	8.00
R453H	H	6.76	0.2661	53.0	91.0	36.0	8.00
R4536.8	–	6.80	0.2677	53.0	91.0	36.0	8.00



Product	DC	DC	DC	LCF	OAL	LS	DCON MS
	(inch)	(mm)	(inch)	(mm)	(mm)	(mm)	(mm)
R4536.9	—	6.90	0.2717	53.0	91.0	36.0	8.00
R453I	I	6.91	0.2720	53.0	91.0	36.0	8.00
R4537.0	—	7.00	0.2756	53.0	91.0	36.0	8.00
R453J	J	7.04	0.2772	53.0	91.0	36.0	8.00
R4537.1	—	7.10	0.2795	53.0	91.0	36.0	8.00
R453K	K	7.14	0.2811	53.0	91.0	36.0	8.00
R4539/32	9/32	7.14	0.2813	53.0	91.0	36.0	8.00
R4537.2	—	7.20	0.2835	53.0	91.0	36.0	8.00
R4537.3	—	7.30	0.2874	53.0	91.0	36.0	8.00
R453L	L	7.37	0.2902	53.0	91.0	36.0	8.00
R4537.4	—	7.40	0.2913	53.0	91.0	36.0	8.00
R453M	M	7.49	0.2949	53.0	91.0	36.0	8.00
R4537.5	—	7.50	0.2953	53.0	91.0	36.0	8.00
R45319/64	19/64	7.54	0.2969	53.0	91.0	36.0	8.00
R4537.6	—	7.60	0.2992	53.0	91.0	36.0	8.00
R453N	N	7.67	0.3020	53.0	91.0	36.0	8.00
R4537.7	—	7.70	0.3031	53.0	91.0	36.0	8.00
R4537.8	—	7.80	0.3071	53.0	91.0	36.0	8.00
R4537.9	—	7.90	0.3110	53.0	91.0	36.0	8.00
R4535/16	5/16	7.94	0.3125	53.0	91.0	36.0	8.00
R4538.0	—	8.00	0.3150	53.0	91.0	36.0	8.00
R453O	O	8.03	0.3161	61.0	103.0	40.0	10.00
R4538.05	—	8.05	0.3169	61.0	103.0	40.0	10.00
R4538.1	—	8.10	0.3189	61.0	103.0	40.0	10.00
R4538.2	—	8.20	0.3228	61.0	103.0	40.0	10.00
R453P	P	8.20	0.3228	61.0	103.0	40.0	10.00
R4538.3	—	8.30	0.3268	61.0	103.0	40.0	10.00
R45321/64	21/64	8.33	0.3281	61.0	103.0	40.0	10.00
R4538.4	—	8.40	0.3307	61.0	103.0	40.0	10.00
R453Q	Q	8.43	0.3319	61.0	103.0	40.0	10.00
R4538.5	—	8.50	0.3346	61.0	103.0	40.0	10.00
R4538.6	—	8.60	0.3386	61.0	103.0	40.0	10.00
R453R	R	8.61	0.3390	61.0	103.0	40.0	10.00
R4538.7	—	8.70	0.3425	61.0	103.0	40.0	10.00
R45311/32	11/32	8.73	0.3438	61.0	103.0	40.0	10.00
R4538.8	—	8.80	0.3465	61.0	103.0	40.0	10.00
R453S	S	8.84	0.3480	61.0	103.0	40.0	10.00
R4538.9	—	8.90	0.3504	61.0	103.0	40.0	10.00
R4539.0	—	9.00	0.3543	61.0	103.0	40.0	10.00
R453T	T	9.09	0.3579	61.0	103.0	40.0	10.00
R4539.1	—	9.10	0.3583	61.0	103.0	40.0	10.00
R45323/64	23/64	9.13	0.3594	61.0	103.0	40.0	10.00
R4539.2	—	9.20	0.3622	61.0	103.0	40.0	10.00
R4539.3	—	9.30	0.3661	61.0	103.0	40.0	10.00
R453U	U	9.35	0.3681	61.0	103.0	40.0	10.00
R4539.4	—	9.40	0.3701	61.0	103.0	40.0	10.00
R4539.5	—	9.50	0.3740	61.0	103.0	40.0	10.00
R4533/8	3/8	9.53	0.3750	61.0	103.0	40.0	10.00
R453V	V	9.58	0.3772	61.0	103.0	40.0	10.00
R4539.6	—	9.60	0.3780	61.0	103.0	40.0	10.00
R4539.7	—	9.70	0.3819	61.0	103.0	40.0	10.00
R4539.8	—	9.80	0.3858	61.0	103.0	40.0	10.00
R453W	W	9.80	0.3858	61.0	103.0	40.0	10.00
R4539.9	—	9.90	0.3898	61.0	103.0	40.0	10.00
R45325/64	25/64	9.92	0.3906	61.0	103.0	40.0	10.00
R45310.0	—	10.00	0.3937	61.0	103.0	40.0	10.00
R45310.05	—	10.05	0.3957	70.0	118.0	45.0	12.00
R453X	X	10.08	0.3969	70.0	118.0	45.0	12.00
R45310.1	—	10.10	0.3976	70.0	118.0	45.0	12.00
R45310.2	—	10.20	0.4016	70.0	118.0	45.0	12.00
R453Y	Y	10.26	0.4039	70.0	118.0	45.0	12.00
R45310.3	—	10.30	0.4055	70.0	118.0	45.0	12.00
R45313/32	13/32	10.32	0.4063	70.0	118.0	45.0	12.00
R45310.4	—	10.40	0.4094	70.0	118.0	45.0	12.00
R453Z	Z	10.49	0.4130	70.0	118.0	45.0	12.00



Product	DC	DC	DC	LCF	OAL	LS	DCON MS
	(inch)	(mm)	(inch)	(mm)	(mm)	(mm)	(mm)
R45310.5	–	10.50	0.4134	70.0	118.0	45.0	12.00
R45310.6	–	10.60	0.4173	70.0	118.0	45.0	12.00
R45327/64	27/64	10.72	0.4219	70.0	118.0	45.0	12.00
R45310.8	–	10.80	0.4252	70.0	118.0	45.0	12.00
R45311.0	–	11.00	0.4331	70.0	118.0	45.0	12.00
R4537/16	7/16	11.11	0.4375	70.0	118.0	45.0	12.00
R45311.2	–	11.20	0.4409	70.0	118.0	45.0	12.00
R45311.3	–	11.30	0.4449	70.0	118.0	45.0	12.00
R45311.4	–	11.40	0.4488	70.0	118.0	45.0	12.00
R45311.5	–	11.50	0.4528	70.0	118.0	45.0	12.00
R45329/64	29/64	11.51	0.4531	70.0	118.0	45.0	12.00
R45311.6	–	11.60	0.4567	70.0	118.0	45.0	12.00
R45311.8	–	11.80	0.4646	70.0	118.0	45.0	12.00
R45315/32	15/32	11.91	0.4688	70.0	118.0	45.0	12.00
R45312.0	–	12.00	0.4724	70.0	118.0	45.0	12.00
R45312.05	–	12.05	0.4744	76.0	124.0	45.0	14.00
R45312.2	–	12.20	0.4803	76.0	124.0	45.0	14.00
R45331/64	31/64	12.30	0.4844	76.0	124.0	45.0	14.00
R45312.5	–	12.50	0.4921	76.0	124.0	45.0	14.00
R45312.7	–	12.70	0.5000	76.0	124.0	45.0	14.00
R4531/2	1/2	12.70	0.5000	76.0	124.0	45.0	14.00
R45312.8	–	12.80	0.5039	76.0	124.0	45.0	14.00
R45313.0	–	13.00	0.5118	76.0	124.0	45.0	14.00
R45333/64	33/64	13.10	0.5156	76.0	124.0	45.0	14.00
R45313.3	–	13.30	0.5236	76.0	124.0	45.0	14.00
R45317/32	17/32	13.49	0.5313	76.0	124.0	45.0	14.00
R45313.5	–	13.50	0.5315	76.0	124.0	45.0	14.00
R45313.8	–	13.80	0.5433	76.0	124.0	45.0	14.00
R45335/64	35/64	13.89	0.5469	76.0	124.0	45.0	14.00
R45314.0	–	14.00	0.5512	76.0	124.0	45.0	14.00
R45314.25	–	14.25	0.5610	82.0	133.0	48.0	16.00
R4539/16	9/16	14.29	0.5625	82.0	133.0	48.0	16.00
R45314.5	–	14.50	0.5709	82.0	133.0	48.0	16.00
R45337/64	37/64	14.68	0.5781	82.0	133.0	48.0	16.00
R45314.8	–	14.80	0.5827	82.0	133.0	48.0	16.00
R45315.0	–	15.00	0.5906	82.0	133.0	48.0	16.00
R45319/32	19/32	15.08	0.5938	82.0	133.0	48.0	16.00
R45315.1	–	15.10	0.5945	82.0	133.0	48.0	16.00
R45315.3	–	15.30	0.6024	82.0	133.0	48.0	16.00
R45339/64	39/64	15.48	0.6094	82.0	133.0	48.0	16.00
R45315.5	–	15.50	0.6102	82.0	133.0	48.0	16.00
R45315.8	–	15.80	0.6220	82.0	133.0	48.0	16.00
R4535/8	5/8	15.88	0.6250	82.0	133.0	48.0	16.00
R45316.0	–	16.00	0.6299	82.0	133.0	48.0	16.00
R45341/64	41/64	16.27	0.6406	91.0	143.0	48.0	18.00
R45316.5	–	16.50	0.6496	91.0	143.0	48.0	18.00
R45321/32	21/32	16.67	0.6563	91.0	143.0	48.0	18.00
R45317.0	–	17.00	0.6693	91.0	143.0	48.0	18.00
R45343/64	43/64	17.07	0.6720	91.0	143.0	48.0	18.00
R45311/16	11/16	17.46	0.6874	91.0	143.0	48.0	18.00
R45317.5	–	17.50	0.6890	91.0	143.0	48.0	18.00
R45317.8	–	17.80	0.7008	91.0	143.0	48.0	18.00
R45345/64	45/64	17.86	0.7031	91.0	143.0	48.0	18.00
R45318.0	–	18.00	0.7087	91.0	143.0	48.0	18.00
R45323/32	23/32	18.26	0.7189	99.0	143.0	48.0	20.00
R45318.5	–	18.50	0.7283	99.0	153.0	50.0	20.00
R45347/64	47/64	18.65	0.7343	99.0	153.0	50.0	20.00
R45319.0	–	19.00	0.7480	99.0	153.0	50.0	20.00
R4533/4	3/4	19.05	0.7500	99.0	153.0	50.0	20.00
R45319.5	–	19.50	0.7677	99.0	153.0	50.0	20.00
R45319.8	–	19.80	0.7795	99.0	153.0	50.0	20.00
R45320.0	–	20.00	0.7874	99.0	153.0	50.0	20.00



R459



FORCE X VHM productieboor, 8xD, koelkanalen, TiAlN gecoat

Hoogproductieve boor, voor gaten van hoge kwaliteit en nauwkeurigheid bij hoge verspaningscondities (H9 gattolerantie). Zelfcenterende 140°, 4-vlaks split point en CTW spaangroefontwerp voor hoge voedingsnelheden. Koelkanalen voor betere spaanafvoer. TiAlN coating verhoogt de oppervlaktehardheid en verbetert de standtijd van het gereedschap. Met gladde (HA) eenheidschacht voor de hoogste rondloopnauwkeurigheid.

FORCE X

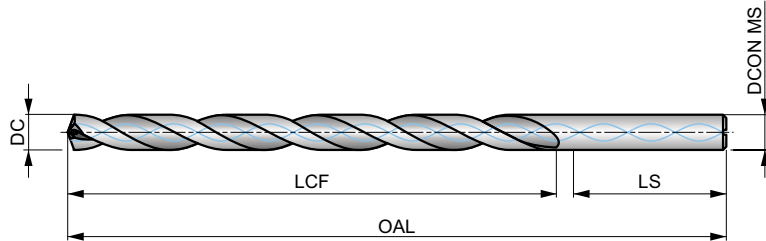

HM	DORMER	8xD
140°	TiAlN	DIN 6535HA
CTW	DC m7	

De tabel geeft de geschiktheid aan voor de materiaalgroep en de startwaarden voor de snijsnelheid (m/min) en de letter verwijst naar de toe te passen voeding (fn), zie vanaf pagina 65.

P1.1 ■ 143 V	P1.2 ■ 160 V	P1.3 ■ 166 V	P2.1 ■ 122 V	P2.2 ■ 108 U	P2.3 ■ 95 U	P3.1 ■ 106 U	P3.2 ■ 86 U	P3.3 ■ 72 U	P4.1 ■ 63 U	P4.2 ■ 54 U	P4.3 ■ 44 T	M1.1 ■ 60 V	M1.2 ■ 51 V
M2.1 ■ 154 V	M2.2 ■ 44 V	M2.3 ■ 37 U	M3.1 ■ 33 V	M3.2 ■ 28 V	M3.3 ■ 26 V	M4.1 ■ 24 U	M4.2 ■ 21 U	K1.1 ■ 88 W	K1.2 ■ 65 W	K1.3 ■ 49 W	K2.1 ■ 78 V	K2.2 ■ 64 V	K2.3 ■ 51 V
K3.1 ■ 70 V	K3.2 ■ 54 V	K3.3 ■ 43 V	K4.1 ■ 65 V	K4.2 ■ 49 V	K4.3 ■ 36 V	K4.4 ■ 30 V	K4.5 ■ 26 V	K5.1 ■ 73 V	K5.2 ■ 55 V	K5.3 ■ 42 V	N1.1 ■ 200 W	N1.2 ■ 150 W	N1.3 ■ 100 W
N2.1 ■ 246 V	N2.2 ■ 222 V	N2.3 ■ 160 V	N3.1 ■ 298 V	N3.2 ■ 176 V	N3.3 ■ 188 V								

DCON MS passing h6.

Product	DC (inch)	DC (mm)	DC (inch)	LCF (mm)	OAL (mm)	LS (mm)	DCON MS (mm)
R4593.0	–	3.00	0.1181	37.0	79.0	36.0	6.00
R4593.1	–	3.10	0.1220	37.0	79.0	36.0	6.00
R4591/8	1/8	3.18	0.1250	37.0	79.0	36.0	6.00
R4593.2	–	3.20	0.1260	37.0	79.0	36.0	6.00
R4593.3	–	3.30	0.1299	37.0	79.0	36.0	6.00
R4593.4	–	3.40	0.1339	37.0	79.0	36.0	6.00
R4593.5	–	3.50	0.1378	37.0	79.0	36.0	6.00
R4599/64	9/64	3.57	0.1406	37.0	79.0	36.0	6.00
R4593.6	–	3.60	0.1417	37.0	79.0	36.0	6.00
R4593.7	–	3.70	0.1457	37.0	79.0	36.0	6.00
R4593.8	–	3.80	0.1496	48.0	90.0	36.0	6.00
R4593.9	–	3.90	0.1535	48.0	90.0	36.0	6.00
R4595/32	5/32	3.97	0.1563	48.0	90.0	36.0	6.00
R4594.0	–	4.00	0.1575	48.0	90.0	36.0	6.00
R4594.1	–	4.10	0.1614	48.0	90.0	36.0	6.00
R4594.2	–	4.20	0.1654	48.0	90.0	36.0	6.00
R4594.3	–	4.30	0.1693	48.0	90.0	36.0	6.00
R45911/64	11/64	4.37	0.1719	48.0	90.0	36.0	6.00
R4594.4	–	4.40	0.1732	48.0	90.0	36.0	6.00
R4594.5	–	4.50	0.1772	48.0	90.0	36.0	6.00
R4594.6	–	4.60	0.1811	48.0	90.0	36.0	6.00
R4594.7	–	4.70	0.1850	62.0	104.0	36.0	6.00
R4593/16	3/16	4.76	0.1875	62.0	104.0	36.0	6.00
R4594.8	–	4.80	0.1890	62.0	104.0	36.0	6.00
R4594.9	–	4.90	0.1929	62.0	104.0	36.0	6.00



Product	DC	DC	DC	LCF	OAL	LS	DCON MS
	(inch)	(mm)	(inch)	(mm)	(mm)	(mm)	(mm)
R4595.0	–	5.00	0.1969	62.0	104.0	36.0	6.00
R4595.1	–	5.10	0.2008	62.0	104.0	36.0	6.00
R45913/64	13/64	5.16	0.2031	62.0	104.0	36.0	6.00
R4595.2	–	5.20	0.2047	62.0	104.0	36.0	6.00
R4595.3	–	5.30	0.2087	62.0	104.0	36.0	6.00
R4595.4	–	5.40	0.2126	62.0	104.0	36.0	6.00
R4595.5	–	5.50	0.2165	62.0	104.0	36.0	6.00
R4597/32	7/32	5.56	0.2188	62.0	104.0	36.0	6.00
R4595.6	–	5.60	0.2205	62.0	104.0	36.0	6.00
R4595.7	–	5.70	0.2244	62.0	104.0	36.0	6.00
R4595.8	–	5.80	0.2283	62.0	104.0	36.0	6.00
R4595.9	–	5.90	0.2323	62.0	104.0	36.0	6.00
R45915/64	15/64	5.95	0.2344	62.0	104.0	36.0	6.00
R4596.0	–	6.00	0.2362	62.0	104.0	36.0	6.00
R4596.1	–	6.10	0.2402	84.0	126.0	36.0	8.00
R4596.2	–	6.20	0.2441	84.0	126.0	36.0	8.00
R4596.3	–	6.30	0.2480	84.0	126.0	36.0	8.00
R4591/4	1/4	6.35	0.2500	84.0	126.0	36.0	8.00
R4596.4	–	6.40	0.2520	84.0	126.0	36.0	8.00
R4596.5	–	6.50	0.2559	84.0	126.0	36.0	8.00
R4596.6	–	6.60	0.2598	84.0	126.0	36.0	8.00
R4596.7	–	6.70	0.2638	84.0	126.0	36.0	8.00
R45917/64	17/64	6.75	0.2656	84.0	126.0	36.0	8.00
R4596.8	–	6.80	0.2677	84.0	126.0	36.0	8.00
R4596.9	–	6.90	0.2717	84.0	126.0	36.0	8.00
R4597.0	–	7.00	0.2756	84.0	126.0	36.0	8.00
R4597.1	–	7.10	0.2795	84.0	126.0	36.0	8.00
R4599/32	9/32	7.14	0.2813	84.0	126.0	36.0	8.00
R4597.2	–	7.20	0.2835	84.0	126.0	36.0	8.00
R4597.3	–	7.30	0.2874	84.0	126.0	36.0	8.00
R4597.4	–	7.40	0.2913	84.0	126.0	36.0	8.00
R4597.5	–	7.50	0.2953	84.0	126.0	36.0	8.00
R45919/64	19/64	7.54	0.2969	84.0	126.0	36.0	8.00
R4597.6	–	7.60	0.2992	84.0	126.0	36.0	8.00
R4597.7	–	7.70	0.3031	84.0	126.0	36.0	8.00
R4597.8	–	7.80	0.3071	84.0	126.0	36.0	8.00
R4597.9	–	7.90	0.3110	84.0	126.0	36.0	8.00
R4595/16	5/16	7.94	0.3125	84.0	126.0	36.0	8.00
R4598.0	–	8.00	0.3150	84.0	126.0	36.0	8.00
R4598.1	–	8.10	0.3189	106.0	152.0	40.0	10.00
R4598.2	–	8.20	0.3228	106.0	152.0	40.0	10.00
R4598.3	–	8.30	0.3268	106.0	152.0	40.0	10.00
R45921/64	21/64	8.33	0.3281	106.0	152.0	40.0	10.00
R4598.4	–	8.40	0.3307	106.0	152.0	40.0	10.00
R4598.5	–	8.50	0.3346	106.0	152.0	40.0	10.00
R4598.6	–	8.60	0.3386	106.0	152.0	40.0	10.00
R4598.7	–	8.70	0.3425	106.0	152.0	40.0	10.00
R45911/32	11/32	8.73	0.3438	106.0	152.0	40.0	10.00
R4598.8	–	8.80	0.3465	106.0	152.0	40.0	10.00
R4598.9	–	8.90	0.3504	106.0	152.0	40.0	10.00
R4599.0	–	9.00	0.3543	106.0	152.0	40.0	10.00
R4599.1	–	9.10	0.3583	106.0	152.0	40.0	10.00
R45923/64	23/64	9.13	0.3594	106.0	152.0	40.0	10.00
R4599.2	–	9.20	0.3622	106.0	152.0	40.0	10.00
R4599.3	–	9.30	0.3661	106.0	152.0	40.0	10.00
R4599.4	–	9.40	0.3701	106.0	152.0	40.0	10.00
R4599.5	–	9.50	0.3740	106.0	152.0	40.0	10.00
R4593/8	3/8	9.53	0.3750	106.0	152.0	40.0	10.00
R4599.6	–	9.60	0.3780	106.0	152.0	40.0	10.00
R4599.7	–	9.70	0.3819	106.0	152.0	40.0	10.00
R4599.8	–	9.80	0.3858	106.0	152.0	40.0	10.00
R4599.9	–	9.90	0.3898	106.0	152.0	40.0	10.00



Product	DC	DC	DC	LCF	OAL	LS	DCON MS
	(inch)	(mm)	(inch)	(mm)	(mm)	(mm)	(mm)
R45925/64	25/64	9.92	0.3906	106.0	152.0	40.0	10.00
R45910.0	–	10.00	0.3937	106.0	152.0	40.0	10.00
R45910.2	–	10.20	0.4016	128.0	180.0	45.0	12.00
R45910.3	–	10.30	0.4055	128.0	180.0	45.0	12.00
R45913/32	13/32	10.32	0.4063	128.0	180.0	45.0	12.00
R45910.4	–	10.40	0.4094	128.0	180.0	45.0	12.00
R45910.5	–	10.50	0.4134	128.0	180.0	45.0	12.00
R45927/64	27/64	10.72	0.4219	128.0	180.0	45.0	12.00
R45910.8	–	10.80	0.4252	128.0	180.0	45.0	12.00
R45911.0	–	11.00	0.4331	128.0	180.0	45.0	12.00
R4597/16	7/16	11.11	0.4375	128.0	180.0	45.0	12.00
R45911.2	–	11.20	0.4409	128.0	180.0	45.0	12.00
R45911.3	–	11.30	0.4449	128.0	180.0	45.0	12.00
R45911.5	–	11.50	0.4528	128.0	180.0	45.0	12.00
R45929/64	29/64	11.51	0.4531	128.0	180.0	45.0	12.00
R45911.8	–	11.80	0.4646	128.0	180.0	45.0	12.00
R45915/32	15/32	11.91	0.4688	128.0	180.0	45.0	12.00
R45912.0	–	12.00	0.4724	128.0	180.0	45.0	12.00
R45912.2	–	12.20	0.4803	151.0	202.0	48.0	14.00
R45931/64	31/64	12.30	0.4844	151.0	202.0	48.0	14.00
R45912.5	–	12.50	0.4921	151.0	202.0	48.0	14.00
R4591/2	1/2	12.70	0.5000	151.0	202.0	48.0	14.00
R45912.8	–	12.80	0.5039	151.0	202.0	48.0	14.00
R45913.0	–	13.00	0.5118	151.0	202.0	48.0	14.00
R45933/64	33/64	13.10	0.5156	151.0	202.0	48.0	14.00
R45917/32	17/32	13.49	0.5313	151.0	202.0	48.0	14.00
R45913.5	–	13.50	0.5315	151.0	202.0	48.0	14.00
R45935/64	35/64	13.89	0.5469	151.0	202.0	48.0	14.00
R45914.0	–	14.00	0.5512	151.0	202.0	48.0	14.00
R45914.25	–	14.25	0.5610	172.0	227.0	48.0	16.00
R4599/16	9/16	14.29	0.5625	172.0	227.0	48.0	16.00
R45914.5	–	14.50	0.5709	172.0	227.0	48.0	16.00
R45937/64	37/64	14.68	0.5781	172.0	227.0	48.0	16.00
R45915.0	–	15.00	0.5906	172.0	227.0	48.0	16.00
R45919/32	19/32	15.08	0.5938	172.0	227.0	48.0	16.00
R45915.1	–	15.10	0.5945	172.0	227.0	48.0	16.00
R45939/64	39/64	15.48	0.6094	172.0	227.0	48.0	16.00
R45915.5	–	15.50	0.6102	172.0	227.0	48.0	16.00
R4595/8	5/8	15.88	0.6250	172.0	227.0	48.0	16.00
R45916.0	–	16.00	0.6299	172.0	227.0	48.0	16.00



R467

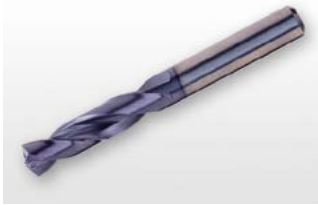

FORCE M VHM productieboor, 3xD, koelkanalen, TiAlN gecoat

Hoogproductieve boor, voor gaten van hoge kwaliteit en nauwkeurigheid bij hoge verspaningscondities (H9 gattolerantie) in roestvast of hittebestendig staal. Zelfcenterende 140°, 4-vlaks split point en CTW spaangroefontwerp voor hoge voedingsnelheden. Koelkanalen voor betere spaanafvoer. TiAlN coating verhoogt de oppervlaktehardheid en verbetert de standtijd van het gereedschap. Met gladde (HA) eenheidschacht voor de hoogste rondlooptrouwbaarheid.

FORCE M

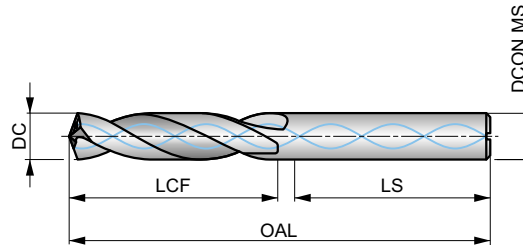

HM	DIN 6537K	3xD
140°	TiAlN	DIN 6535HA
CTW	DC m7	

De tabel geeft de geschiktheid aan voor de materiaalgroep en de startwaarden voor de snijsnelheid (m/min) en de letter verwijst naar de toe te passen voeding (fn), zie vanaf pagina 65.

M1.1 ■ 117 G	M1.2 ■ 99 G	M2.1 ■ 104 G	M2.2 ■ 85 G	M2.3 ■ 71 E	M3.1 ■ 87 G	M3.2 ■ 75 G	M3.3 ■ 68 F	M4.1 ■ 60 F	M4.2 ■ 52 E	S1.1 ■ 55 V	S1.2 ■ 45 V	S1.3 ■ 40 U	S2.1 ■ 60 U
S2.2 ■ 56 U	S3.1 ■ 45 U	S3.2 ■ 40 U	S4.1 ■ 35 U	S4.2 ■ 32 U									

DCON MS passing h6.

Product	DC	DC	DC	LCF	OAL	LS	DCON MS
	(inch)	(mm)	(inch)	(mm)	(mm)	(mm)	
R4673.0	–	3.00	0.1181	20.0	62.0	36.0	6.00
R4673.1	–	3.10	0.1220	20.0	62.0	36.0	6.00
R4671/8	1/8	3.18	0.1250	20.0	62.0	36.0	6.00
R4673.2	–	3.20	0.1260	20.0	62.0	36.0	6.00
R4673.3	–	3.30	0.1299	20.0	62.0	36.0	6.00
R4673.4	–	3.40	0.1339	20.0	62.0	36.0	6.00
R467N29	N29	3.45	0.1360	20.0	62.0	36.0	6.00
R4673.5	–	3.50	0.1378	20.0	62.0	36.0	6.00
R4679/64	9/64	3.57	0.1406	20.0	62.0	36.0	6.00
R4673.6	–	3.60	0.1417	20.0	62.0	36.0	6.00
R4673.7	–	3.70	0.1457	20.0	62.0	36.0	6.00
R4673.8	–	3.80	0.1496	24.0	66.0	36.0	6.00
R4673.9	–	3.90	0.1535	24.0	66.0	36.0	6.00
R4675/32	5/32	3.97	0.1563	24.0	66.0	36.0	6.00
R4674.0	–	4.00	0.1575	24.0	66.0	36.0	6.00
R4674.05	–	4.05	0.1594	24.0	66.0	36.0	6.00
R4674.1	–	4.10	0.1614	24.0	66.0	36.0	6.00
R4674.2	–	4.20	0.1654	24.0	66.0	36.0	6.00
R4674.3	–	4.30	0.1693	24.0	66.0	36.0	6.00
R46711/64	11/64	4.37	0.1719	24.0	66.0	36.0	6.00
R4674.4	–	4.40	0.1732	24.0	66.0	36.0	6.00
R4674.5	–	4.50	0.1772	24.0	66.0	36.0	6.00
R4674.6	–	4.60	0.1811	24.0	66.0	36.0	6.00
R4674.7	–	4.70	0.1850	24.0	66.0	36.0	6.00
R4673/16	3/16	4.76	0.1875	28.0	66.0	36.0	6.00
R4674.8	–	4.80	0.1890	28.0	66.0	36.0	6.00
R4674.9	–	4.90	0.1929	28.0	66.0	36.0	6.00
R4675.0	–	5.00	0.1969	28.0	66.0	36.0	6.00
R4675.05	–	5.05	0.1988	28.0	66.0	36.0	6.00



Product	DC	DC	DC	LCF	OAL	LS	DCON MS
	(inch)	(mm)	(inch)	(mm)	(mm)	(mm)	(mm)
R4675.1	—	5.10	0.2008	28.0	66.0	36.0	6.00
R467N7	N7	5.11	0.2010	28.0	66.0	36.0	6.00
R46713/64	13/64	5.16	0.2031	28.0	66.0	36.0	6.00
R4675.2	—	5.20	0.2047	28.0	66.0	36.0	6.00
R467N5	N5	5.22	0.2055	28.0	66.0	36.0	6.00
R4675.3	—	5.30	0.2087	28.0	66.0	36.0	6.00
R4675.4	—	5.40	0.2126	28.0	66.0	36.0	6.00
R4675.5	—	5.50	0.2165	28.0	66.0	36.0	6.00
R4677/32	7/32	5.56	0.2188	28.0	66.0	36.0	6.00
R4675.6	—	5.60	0.2205	28.0	66.0	36.0	6.00
R4675.7	—	5.70	0.2244	28.0	66.0	36.0	6.00
R4675.8	—	5.80	0.2283	28.0	66.0	36.0	6.00
R4675.9	—	5.90	0.2323	28.0	66.0	36.0	6.00
R46715/64	15/64	5.95	0.2344	28.0	66.0	36.0	6.00
R4676.0	—	6.00	0.2362	28.0	66.0	36.0	6.00
R4676.05	—	6.05	0.2382	34.0	79.0	36.0	8.00
R4676.1	—	6.10	0.2402	34.0	79.0	36.0	8.00
R4676.2	—	6.20	0.2441	34.0	79.0	36.0	8.00
R4676.3	—	6.30	0.2480	34.0	79.0	36.0	8.00
R4671/4	1/4	6.35	0.2500	34.0	79.0	36.0	8.00
R4676.4	—	6.40	0.2520	34.0	79.0	36.0	8.00
R4676.5	—	6.50	0.2559	34.0	79.0	36.0	8.00
R4676.6	—	6.60	0.2598	34.0	79.0	36.0	8.00
R4676.7	—	6.70	0.2638	34.0	79.0	36.0	8.00
R46717/64	17/64	6.75	0.2656	34.0	79.0	36.0	8.00
R4676.8	—	6.80	0.2677	34.0	79.0	36.0	8.00
R4676.9	—	6.90	0.2717	34.0	79.0	36.0	8.00
R4677.0	—	7.00	0.2756	34.0	79.0	36.0	8.00
R4677.1	—	7.10	0.2795	41.0	79.0	36.0	8.00
R4679/32	9/32	7.14	0.2813	41.0	79.0	36.0	8.00
R4677.2	—	7.20	0.2835	41.0	79.0	36.0	8.00
R4677.3	—	7.30	0.2874	41.0	79.0	36.0	8.00
R4677.4	—	7.40	0.2913	41.0	79.0	36.0	8.00
R4677.5	—	7.50	0.2953	41.0	79.0	36.0	8.00
R46719/64	19/64	7.54	0.2969	41.0	79.0	36.0	8.00
R4677.6	—	7.60	0.2992	41.0	79.0	36.0	8.00
R4677.7	—	7.70	0.3031	41.0	79.0	36.0	8.00
R4677.8	—	7.80	0.3071	41.0	79.0	36.0	8.00
R4677.9	—	7.90	0.3110	41.0	79.0	36.0	8.00
R4675/16	5/16	7.94	0.3125	41.0	79.0	36.0	8.00
R4678.0	—	8.00	0.3150	41.0	79.0	36.0	8.00
R4678.05	—	8.05	0.3169	47.0	89.0	40.0	10.00
R4678.1	—	8.10	0.3189	47.0	89.0	40.0	10.00
R4678.2	—	8.20	0.3228	47.0	89.0	40.0	10.00
R4678.3	—	8.30	0.3268	47.0	89.0	40.0	10.00
R46721/64	21/64	8.33	0.3281	47.0	89.0	40.0	10.00
R4678.4	—	8.40	0.3307	47.0	89.0	40.0	10.00
R4678.5	—	8.50	0.3346	47.0	89.0	40.0	10.00
R4678.6	—	8.60	0.3386	47.0	89.0	40.0	10.00
R4678.7	—	8.70	0.3425	47.0	89.0	40.0	10.00
R46711/32	11/32	8.73	0.3438	47.0	89.0	40.0	10.00
R4678.8	—	8.80	0.3465	47.0	89.0	40.0	10.00
R4678.9	—	8.90	0.3504	47.0	89.0	40.0	10.00
R4679.0	—	9.00	0.3543	47.0	89.0	40.0	10.00
R4679.1	—	9.10	0.3583	47.0	89.0	40.0	10.00
R46723/64	23/64	9.13	0.3594	47.0	89.0	40.0	10.00
R4679.2	—	9.20	0.3622	47.0	89.0	40.0	10.00
R4679.3	—	9.30	0.3661	47.0	89.0	40.0	10.00
R4679.4	—	9.40	0.3701	47.0	89.0	40.0	10.00
R4679.5	—	9.50	0.3740	47.0	89.0	40.0	10.00
R4673/8	3/8	9.53	0.3750	47.0	89.0	40.0	10.00
R4679.6	—	9.60	0.3780	47.0	89.0	40.0	10.00



Product	DC	DC	DC	LCF	OAL	LS	DCON MS
	(inch)	(mm)	(inch)	(mm)	(mm)	(mm)	(mm)
R4679.7	–	9.70	0.3819	47.0	89.0	40.0	10.00
R4679.8	–	9.80	0.3858	47.0	89.0	40.0	10.00
R4679.9	–	9.90	0.3898	47.0	89.0	40.0	10.00
R46725/64	25/64	9.92	0.3906	47.0	89.0	40.0	10.00
R46710.0	–	10.00	0.3937	47.0	89.0	40.0	10.00
R46710.05	–	10.05	0.3957	55.0	102.0	45.0	12.00
R46710.1	–	10.10	0.3976	55.0	102.0	45.0	12.00
R46710.2	–	10.20	0.4016	55.0	102.0	45.0	12.00
R46710.3	–	10.30	0.4055	55.0	102.0	45.0	12.00
R46713/32	13/32	10.32	0.4063	55.0	102.0	45.0	12.00
R46710.4	–	10.40	0.4094	55.0	102.0	45.0	12.00
R46710.5	–	10.50	0.4134	55.0	102.0	45.0	12.00
R46710.6	–	10.60	0.4173	55.0	102.0	45.0	12.00
R46727/64	27/64	10.72	0.4219	55.0	102.0	45.0	12.00
R46710.8	–	10.80	0.4252	55.0	102.0	45.0	12.00
R46710.9	–	10.90	0.4291	55.0	102.0	45.0	12.00
R46711.0	–	11.00	0.4331	55.0	102.0	45.0	12.00
R4677/16	7/16	11.11	0.4375	55.0	102.0	45.0	12.00
R46711.2	–	11.20	0.4409	55.0	102.0	45.0	12.00
R46711.3	–	11.30	0.4449	55.0	102.0	45.0	12.00
R46711.4	–	11.40	0.4488	55.0	102.0	45.0	12.00
R46711.5	–	11.50	0.4528	55.0	102.0	45.0	12.00
R46729/64	29/64	11.51	0.4531	55.0	102.0	45.0	12.00
R46711.6	–	11.60	0.4567	55.0	102.0	45.0	12.00
R46711.8	–	11.80	0.4646	55.0	102.0	45.0	12.00
R46715/32	15/32	11.91	0.4688	55.0	102.0	45.0	12.00
R46712.0	–	12.00	0.4724	55.0	102.0	45.0	12.00
R46712.05	–	12.05	0.4744	60.0	107.0	45.0	14.00
R46712.1	–	12.10	0.4764	60.0	107.0	45.0	14.00
R46712.2	–	12.20	0.4803	60.0	107.0	45.0	14.00
R46731/64	31/64	12.30	0.4844	60.0	107.0	45.0	14.00
R46712.5	–	12.50	0.4921	60.0	107.0	45.0	14.00
R46712.7	–	12.70	0.5000	60.0	107.0	45.0	14.00
R4671/2	1/2	12.70	0.5000	60.0	107.0	45.0	14.00
R46712.8	–	12.80	0.5039	60.0	107.0	45.0	14.00
R46713.0	–	13.00	0.5118	60.0	107.0	45.0	14.00
R46733/64	33/64	13.10	0.5156	60.0	107.0	45.0	14.00
R46713.3	–	13.30	0.5236	60.0	107.0	45.0	14.00
R46717/32	17/32	13.49	0.5313	60.0	107.0	45.0	14.00
R46713.5	–	13.50	0.5315	60.0	107.0	45.0	14.00
R46713.8	–	13.80	0.5433	60.0	107.0	45.0	14.00
R46735/64	35/64	13.89	0.5469	60.0	107.0	45.0	14.00
R46714.0	–	14.00	0.5512	60.0	107.0	45.0	14.00
R46714.25	–	14.25	0.5610	65.0	115.0	48.0	16.00
R4679/16	9/16	14.29	0.5625	65.0	115.0	48.0	16.00
R46714.5	–	14.50	0.5709	65.0	115.0	48.0	16.00
R46737/64	37/64	14.68	0.5781	65.0	115.0	48.0	16.00
R46714.8	–	14.80	0.5827	65.0	115.0	48.0	16.00
R46715.0	–	15.00	0.5906	65.0	115.0	48.0	16.00
R46719/32	19/32	15.08	0.5938	65.0	115.0	48.0	16.00
R46715.1	–	15.10	0.5945	65.0	115.0	48.0	16.00
R46715.3	–	15.30	0.6024	65.0	115.0	48.0	16.00
R46739/64	39/64	15.48	0.6094	65.0	115.0	48.0	16.00
R46715.5	–	15.50	0.6102	65.0	115.0	48.0	16.00
R46715.8	–	15.80	0.6220	65.0	115.0	48.0	16.00
R4675/8	5/8	15.88	0.6250	65.0	115.0	48.0	16.00
R46716.0	–	16.00	0.6299	65.0	115.0	48.0	16.00



R463



FORCE M VHM productieboor, 5xD, koelkanalen, TiAlN gecoat

Hoogproductieve boor, voor gaten van hoge kwaliteit en nauwkeurigheid bij hoge verspaningscondities (H9 gattolerantie) in roestvast of hittebestendig staal. Zelfcenterende 140°, 4-vlaks split point en CTW spaangroefontwerp voor hoge voedingsnelheden. Koelkanalen voor betere spaanafvoer. TiAlN coating verhoogt de oppervlaktehardheid en verbetert de standtijd van het gereedschap. Met gladde (HA) eenheidschacht voor de hoogste rondlooptrouwbaarheid.

FORCE M

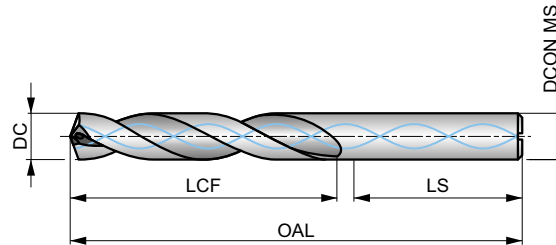

HM	DIN 6537L	5xD
140°	TiAlN	DIN 6535HA
CTW	DC m7	

De tabel geeft de geschiktheid aan voor de materiaalgroep en de startwaarden voor de snijsnelheid (m/min) en de letter verwijst naar de toe te passen voeding (fn), zie vanaf pagina 65.

M1.1 ■ 111 G	M1.2 ■ 94 G	M2.1 ■ 99 G	M2.2 ■ 81 G	M2.3 ■ 67 E	M3.1 ■ 83 G	M3.2 ■ 71 G	M3.3 ■ 65 F	M4.1 ■ 57 F	M4.2 ■ 49 E	S1.1 ■ 52 V	S1.2 ■ 43 V	S1.3 ■ 38 U	S2.1 ■ 57 U
S2.2 ■ 53 U	S3.1 ■ 43 U	S3.2 ■ 38 U	S4.1 ■ 33 U	S4.2 ■ 30 U									

DCON MS passing h6.

Product	DC (inch)	DC (mm)	DC (inch)	LCF (mm)	OAL (mm)	LS (mm)	DCON MS (mm)
R4633.0	–	3.00	0.1181	28.0	66.0	36.0	6.00
R4633.1	–	3.10	0.1220	28.0	66.0	36.0	6.00
R4631/8	1/8	3.18	0.1250	28.0	66.0	36.0	6.00
R4633.2	–	3.20	0.1260	28.0	66.0	36.0	6.00
R4633.3	–	3.30	0.1299	28.0	66.0	36.0	6.00
R4633.4	–	3.40	0.1339	28.0	66.0	36.0	6.00
R463N29	N29	3.45	0.1360	28.0	66.0	36.0	6.00
R4633.5	–	3.50	0.1378	28.0	66.0	36.0	6.00
R4639/64	9/64	3.57	0.1406	28.0	66.0	36.0	6.00
R4633.6	–	3.60	0.1417	28.0	66.0	36.0	6.00
R4633.7	–	3.70	0.1457	28.0	66.0	36.0	6.00
R4633.8	–	3.80	0.1496	36.0	74.0	36.0	6.00
R4633.9	–	3.90	0.1535	36.0	74.0	36.0	6.00
R4635/32	5/32	3.97	0.1563	36.0	74.0	36.0	6.00
R4634.0	–	4.00	0.1575	36.0	74.0	36.0	6.00
R4634.05	–	4.05	0.1594	36.0	74.0	36.0	6.00
R4634.1	–	4.10	0.1614	36.0	74.0	36.0	6.00
R4634.2	–	4.20	0.1654	36.0	74.0	36.0	6.00
R4634.3	–	4.30	0.1693	36.0	74.0	36.0	6.00
R46311/64	11/64	4.37	0.1719	36.0	74.0	36.0	6.00
R4634.4	–	4.40	0.1732	36.0	74.0	36.0	6.00
R4634.5	–	4.50	0.1772	36.0	74.0	36.0	6.00
R4634.6	–	4.60	0.1811	36.0	74.0	36.0	6.00
R4634.7	–	4.70	0.1850	36.0	74.0	36.0	6.00
R4633/16	3/16	4.76	0.1875	44.0	82.0	36.0	6.00
R4634.8	–	4.80	0.1890	44.0	82.0	36.0	6.00
R4634.9	–	4.90	0.1929	44.0	82.0	36.0	6.00
R4635.0	–	5.00	0.1969	44.0	82.0	36.0	6.00
R4635.05	–	5.05	0.1988	44.0	82.0	36.0	6.00



Product	DC	DC	DC	LCF	OAL	LS	DCON MS
	(inch)	(mm)	(inch)	(mm)	(mm)	(mm)	(mm)
R4635.1	–	5.10	0.2008	44.0	82.0	36.0	6.00
R463N7	N7	5.11	0.2010	44.0	82.0	36.0	6.00
R46313/64	13/64	5.16	0.2031	44.0	82.0	36.0	6.00
R4635.2	–	5.20	0.2047	44.0	82.0	36.0	6.00
R463N5	N5	5.22	0.2055	44.0	82.0	36.0	6.00
R4635.3	–	5.30	0.2087	44.0	82.0	36.0	6.00
R4635.4	–	5.40	0.2126	44.0	82.0	36.0	6.00
R4635.5	–	5.50	0.2165	44.0	82.0	36.0	6.00
R4637/32	7/32	5.56	0.2188	44.0	82.0	36.0	6.00
R4635.6	–	5.60	0.2205	44.0	82.0	36.0	6.00
R4635.7	–	5.70	0.2244	44.0	82.0	36.0	6.00
R4635.8	–	5.80	0.2283	44.0	82.0	36.0	6.00
R4635.9	–	5.90	0.2323	44.0	82.0	36.0	6.00
R46315/64	15/64	5.95	0.2344	44.0	82.0	36.0	6.00
R4636.0	–	6.00	0.2362	44.0	82.0	36.0	6.00
R4636.05	–	6.05	0.2382	53.0	91.0	36.0	8.00
R4636.1	–	6.10	0.2402	53.0	91.0	36.0	8.00
R4636.2	–	6.20	0.2441	53.0	91.0	36.0	8.00
R4636.3	–	6.30	0.2480	53.0	91.0	36.0	8.00
R4631/4	1/4	6.35	0.2500	53.0	91.0	36.0	8.00
R4636.4	–	6.40	0.2520	53.0	91.0	36.0	8.00
R4636.5	–	6.50	0.2559	53.0	91.0	36.0	8.00
R4636.6	–	6.60	0.2598	53.0	91.0	36.0	8.00
R4636.7	–	6.70	0.2638	53.0	91.0	36.0	8.00
R46317/64	17/64	6.75	0.2656	53.0	91.0	36.0	8.00
R4636.8	–	6.80	0.2677	53.0	91.0	36.0	8.00
R4636.9	–	6.90	0.2717	53.0	91.0	36.0	8.00
R4637.0	–	7.00	0.2756	53.0	91.0	36.0	8.00
R4637.1	–	7.10	0.2795	53.0	91.0	36.0	8.00
R4639/32	9/32	7.14	0.2813	53.0	91.0	36.0	8.00
R4637.2	–	7.20	0.2835	53.0	91.0	36.0	8.00
R4637.3	–	7.30	0.2874	53.0	91.0	36.0	8.00
R4637.4	–	7.40	0.2913	53.0	91.0	36.0	8.00
R4637.5	–	7.50	0.2953	53.0	91.0	36.0	8.00
R46319/64	19/64	7.54	0.2969	53.0	91.0	36.0	8.00
R4637.6	–	7.60	0.2992	53.0	91.0	36.0	8.00
R4637.7	–	7.70	0.3031	53.0	91.0	36.0	8.00
R4637.8	–	7.80	0.3071	53.0	91.0	36.0	8.00
R4637.9	–	7.90	0.3110	53.0	91.0	36.0	8.00
R4635/16	5/16	7.94	0.3125	53.0	91.0	36.0	8.00
R4638.0	–	8.00	0.3150	53.0	91.0	36.0	8.00
R4638.05	–	8.05	0.3169	61.0	103.0	40.0	10.00
R4638.1	–	8.10	0.3189	61.0	103.0	40.0	10.00
R4638.2	–	8.20	0.3228	61.0	103.0	40.0	10.00
R4638.3	–	8.30	0.3268	61.0	103.0	40.0	10.00
R46321/64	21/64	8.33	0.3281	61.0	103.0	40.0	10.00
R4638.4	–	8.40	0.3307	61.0	103.0	40.0	10.00
R4638.5	–	8.50	0.3346	61.0	103.0	40.0	10.00
R4638.6	–	8.60	0.3386	61.0	103.0	40.0	10.00
R4638.7	–	8.70	0.3425	61.0	103.0	40.0	10.00
R46311/32	11/32	8.73	0.3438	61.0	103.0	40.0	10.00
R4638.8	–	8.80	0.3465	61.0	103.0	40.0	10.00
R4638.9	–	8.90	0.3504	61.0	103.0	40.0	10.00
R4639.0	–	9.00	0.3543	61.0	103.0	40.0	10.00
R4639.1	–	9.10	0.3583	61.0	103.0	40.0	10.00
R46323/64	23/64	9.13	0.3594	61.0	103.0	40.0	10.00
R4639.2	–	9.20	0.3622	61.0	103.0	40.0	10.00
R4639.3	–	9.30	0.3661	61.0	103.0	40.0	10.00
R4639.4	–	9.40	0.3701	61.0	103.0	40.0	10.00
R4639.5	–	9.50	0.3740	61.0	103.0	40.0	10.00
R4633/8	3/8	9.53	0.3750	61.0	103.0	40.0	10.00
R4639.6	–	9.60	0.3780	61.0	103.0	40.0	10.00



Product	DC	DC	DC	LCF	OAL	LS	DCON MS
	(inch)	(mm)	(inch)	(mm)	(mm)	(mm)	(mm)
R4639.7	–	9.70	0.3819	61.0	103.0	40.0	10.00
R4639.8	–	9.80	0.3858	61.0	103.0	40.0	10.00
R4639.9	–	9.90	0.3898	61.0	103.0	40.0	10.00
R46325/64	25/64	9.92	0.3906	61.0	103.0	40.0	10.00
R46310.0	–	10.00	0.3937	61.0	103.0	40.0	10.00
R46310.05	–	10.05	0.3957	70.0	118.0	45.0	12.00
R46310.1	–	10.10	0.3976	70.0	118.0	45.0	12.00
R46310.2	–	10.20	0.4016	70.0	118.0	45.0	12.00
R46310.3	–	10.30	0.4055	70.0	118.0	45.0	12.00
R46313/32	13/32	10.32	0.4063	70.0	118.0	45.0	12.00
R46310.4	–	10.40	0.4094	70.0	118.0	45.0	12.00
R46310.5	–	10.50	0.4134	70.0	118.0	45.0	12.00
R46310.6	–	10.60	0.4173	70.0	118.0	45.0	12.00
R46327/64	27/64	10.72	0.4219	70.0	118.0	45.0	12.00
R46310.8	–	10.80	0.4252	70.0	118.0	45.0	12.00
R46310.9	–	10.90	0.4291	70.0	118.0	45.0	12.00
R46311.0	–	11.00	0.4331	70.0	118.0	45.0	12.00
R4637/16	7/16	11.11	0.4375	70.0	118.0	45.0	12.00
R46311.2	–	11.20	0.4409	70.0	118.0	45.0	12.00
R46311.3	–	11.30	0.4449	70.0	118.0	45.0	12.00
R46311.4	–	11.40	0.4488	70.0	118.0	45.0	12.00
R46311.5	–	11.50	0.4528	70.0	118.0	45.0	12.00
R46329/64	29/64	11.51	0.4531	70.0	118.0	45.0	12.00
R46311.6	–	11.60	0.4567	70.0	118.0	45.0	12.00
R46311.8	–	11.80	0.4646	70.0	118.0	45.0	12.00
R46315/32	15/32	11.91	0.4688	70.0	118.0	45.0	12.00
R46312.0	–	12.00	0.4724	70.0	118.0	45.0	12.00
R46312.05	–	12.05	0.4744	76.0	124.0	45.0	14.00
R46312.2	–	12.20	0.4803	76.0	124.0	45.0	14.00
R46331/64	31/64	12.30	0.4844	76.0	124.0	45.0	14.00
R46312.5	–	12.50	0.4921	76.0	124.0	45.0	14.00
R46312.7	–	12.70	0.5000	76.0	124.0	45.0	14.00
R4631/2	1/2	12.70	0.5000	76.0	124.0	45.0	14.00
R46312.8	–	12.80	0.5039	76.0	124.0	45.0	14.00
R46313.0	–	13.00	0.5118	76.0	124.0	45.0	14.00
R46333/64	33/64	13.10	0.5156	76.0	124.0	45.0	14.00
R46313.3	–	13.30	0.5236	76.0	124.0	45.0	14.00
R46317/32	17/32	13.49	0.5313	76.0	124.0	45.0	14.00
R46313.5	–	13.50	0.5315	76.0	124.0	45.0	14.00
R46313.8	–	13.80	0.5433	76.0	124.0	45.0	14.00
R46335/64	35/64	13.89	0.5469	76.0	124.0	45.0	14.00
R46314.0	–	14.00	0.5512	76.0	124.0	45.0	14.00
R46314.25	–	14.25	0.5610	82.0	133.0	48.0	16.00
R4639/16	9/16	14.29	0.5625	82.0	133.0	48.0	16.00
R46314.5	–	14.50	0.5709	82.0	133.0	48.0	16.00
R46337/64	37/64	14.68	0.5781	82.0	133.0	48.0	16.00
R46314.8	–	14.80	0.5827	82.0	133.0	48.0	16.00
R46315.0	–	15.00	0.5906	82.0	133.0	48.0	16.00
R46319/32	19/32	15.08	0.5938	82.0	133.0	48.0	16.00
R46315.1	–	15.10	0.5945	82.0	133.0	48.0	16.00
R46315.3	–	15.30	0.6024	82.0	133.0	48.0	16.00
R46339/64	39/64	15.48	0.6094	82.0	133.0	48.0	16.00
R46315.5	–	15.50	0.6102	82.0	133.0	48.0	16.00
R46315.8	–	15.80	0.6220	82.0	133.0	48.0	16.00
R4635/8	5/8	15.88	0.6250	82.0	133.0	48.0	16.00
R46316.0	–	16.00	0.6299	82.0	133.0	48.0	16.00



VOEDINGSTABEL BOREN

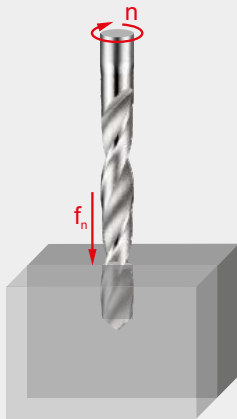

Voeding per omwenteling (f_n in mm/omw)
Afhankelijk van de werkomstandigheden
kan het nodig zijn om deze
aan te passen met $\pm 25\%$.

Hoe gebruik je deze tabel om de voeding per omwenteling (f_n) te bepalen:

1. Zoek uw Alpha Code op de productpagina (voorbeeld: 46J_nJ'' is de Alpha Code).
2. Zoek de dichtstbijzijnde diameter voor uw boorbewerking in de bovenste rij van de tabel.
3. Zoek uw Alpha Code in de linker kolom van de tabel.
4. Het snijpunt (cel) van de diameter en Alpha Code is de voeding per omwenteling (f_n).

		ø DC (mm)																		
		0.15	0.50	1.00	2.00	3.00	4.00	5.00	6.00	8.00	10.00	12.00	15.00	16.00	20.00	25.00	30.00	40.00	50.00	100.00
Voedingssnelheden	A	0.003	0.006	0.012	0.023	0.029	0.032	0.036	0.042	0.054	0.062	0.069	0.082	0.086	0.110	0.125	0.135	0.155	0.175	0.263
	B	0.004	0.007	0.014	0.028	0.037	0.041	0.046	0.053	0.067	0.080	0.090	0.103	0.108	0.135	0.153	0.165	0.188	0.208	0.312
	C	0.004	0.008	0.015	0.032	0.044	0.050	0.056	0.064	0.080	0.098	0.110	0.125	0.130	0.160	0.180	0.195	0.220	0.240	0.360
	D	0.004	0.008	0.016	0.038	0.053	0.060	0.068	0.078	0.098	0.119	0.130	0.149	0.155	0.188	0.210	0.228	0.253	0.275	0.413
	E	0.004	0.009	0.017	0.043	0.062	0.071	0.080	0.092	0.115	0.140	0.150	0.173	0.180	0.215	0.240	0.260	0.285	0.310	0.465
	F	0.005	0.009	0.018	0.050	0.073	0.084	0.095	0.109	0.138	0.165	0.178	0.202	0.210	0.248	0.275	0.295	0.320	0.343	0.515
	G	0.005	0.010	0.019	0.056	0.084	0.096	0.109	0.126	0.160	0.190	0.205	0.231	0.240	0.280	0.310	0.330	0.355	0.375	0.563
	H	0.005	0.010	0.020	0.066	0.102	0.116	0.130	0.150	0.190	0.228	0.243	0.271	0.280	0.320	0.355	0.375	0.398	0.418	0.627
	I	0.005	0.011	0.021	0.076	0.119	0.134	0.150	0.173	0.220	0.265	0.280	0.310	0.320	0.360	0.400	0.420	0.440	0.460	0.690
	J	0.006	0.012	0.024	0.084	0.135	0.152	0.170	0.197	0.250	0.298	0.315	0.349	0.360	0.405	0.445	0.465	0.485	0.503	0.755
	K	0.007	0.013	0.026	0.092	0.150	0.170	0.190	0.220	0.280	0.330	0.350	0.388	0.400	0.450	0.490	0.510	0.530	0.545	0.818
	L	0.007	0.014	0.028	0.101	0.165	0.186	0.208	0.240	0.305	0.360	0.385	0.419	0.430	0.485	0.525	0.545	0.568	0.588	0.882
	M	0.008	0.015	0.030	0.110	0.180	0.202	0.225	0.260	0.330	0.390	0.420	0.450	0.460	0.520	0.560	0.580	0.605	0.630	0.945
	N	0.008	0.016	0.032	0.119	0.195	0.218	0.242	0.280	0.355	0.420	0.455	0.481	0.490	0.555	0.595	0.615	0.642	0.672	1.008
	S	0.002	0.004	0.008	0.014	0.020	0.025	0.030	0.037	0.050	0.080	0.100	0.123	0.130	0.150	0.170	0.190	0.220	0.240	–
	T	0.004	0.008	0.015	0.028	0.040	0.050	0.060	0.070	0.090	0.110	0.130	0.160	0.170	0.190	0.210	0.230	0.260	0.275	–
	U	0.007	0.013	0.026	0.048	0.070	0.080	0.090	0.107	0.140	0.170	0.200	0.223	0.230	0.240	0.270	0.300	0.360	0.375	–
	V	0.010	0.019	0.038	0.069	0.100	0.115	0.130	0.153	0.200	0.250	0.280	0.310	0.320	0.340	0.400	0.440	0.510	0.530	–
	W	0.012	0.025	0.049	0.089	0.130	0.150	0.170	0.200	0.260	0.330	0.380	0.418	0.430	0.450	0.470	0.490	0.520	0.540	–
	X	0.014	0.028	0.056	0.103	0.150	0.180	0.210	0.250	0.330	0.420	0.480	0.533	0.550	0.580	–	–	–	–	–
Y	0.017	0.034	0.068	0.124	0.180	0.220	0.260	0.317	0.430	0.550	0.700	0.700	0.700	0.740	–	–	–	–	–	
Z	0.024	0.047	0.094	0.172	0.250	0.325	0.400	0.533	0.800	1.000	1.100	1.175	1.200	1.200	–	–	–	–	–	



HSS BOREN



HSS BOREN – NAVIGATOR BASISMATERIAAL





Gereedschapsmaterialen

Snelstaal		Een medium gelegerd snelstaal dat goede bewerkbaarheid en goede prestaties heeft. HSS wordt gekenmerkt door hardheid, taaiheid en slijtvastheid, waardoor het aantrekkelijk is voor vele toepassingen, bijvoorbeeld bij boren en tappen.
Kobalt snelstaal		Dit snelstaal bevat kobalt voor verhoogde warmtehardheid. Hierdoor biedt het een goede combinatie van taaiheid en hardheid. Het heeft een goede bewerkbaarheid en goede slijtvastheid, waardoor het ideaal is voor het produceren van boren, tappen, ruimers en frezen.





Basismateriaal

Snelstaal met hardmetaal		Op een snelstalen boorlichaam wordt een hardmetaal snijkant gesoldeerd om een combinatie te verkrijgen van een harde snijkant op een relatief taai boor.
---------------------------------	---	--

Oppervlakte behandelingen

Blank (niet gecoat)		Blanke uitvoering (niet-gecoat oppervlak) verbetert de spaanafvoer bij zachte of non-ferro materialen en behoudt scherpe snijkanten in slijtvaste materialen.
Combinatie blank en stoomontlaten		Combinatie van blank en stoomontlaten kan effectief zijn omdat het blauwe oxide en meer poreuze oppervlak fungeert om de snijvloeistof vast te houden terwijl het blanke oppervlak de afvoer van spanen verbetert. Deze combinatie wordt bereikt door het blanke oppervlak na het stoomontlaten te slijpen.
Stoomontlaten		Stoomontlaten zorgt voor een sterk hechtend blauw oxideoppervlak dat de snijvloeistof vasthoudt en aanlassen van spanen aan de snijkant voorkomt, waardoor de vorming van een opbouwsnijkant wordt tegengegaan. Stoomontlaten kan worden toegepast op blanke gereedschappen en is het meest effectief op boren en tappen.
Bronskleurige Oxide behandeling		Bronskleurige oxide behandeling creëert een gladde dunne bronzen oxidelaag op het oppervlak van het gereedschap. Deze voorkomt het aanlassen van spanen en verbetert de spaanafvoer. Deze bronskleurige oxidelaag kan op ieder ongecoat gereedschap aangebracht worden, ook in combinatie met een stoomontlaten oppervlak bij een aantal gereedschappen.

Oppervlakte coatingen

Blank en TiN (Tin-Tip Coating)		Titaniumnitride is een goudkleurige keramische coating die wordt toegepast door fysieke dampafzetting (PVD). Hoge hardheid in combinatie met lage wrijvings eigenschappen zorgt voor aanzienlijk langere standtijd of betere snijprestaties van gereedschappen die niet zijn gecoat.
Titanium Nitride (TiN)		Titaniumnitride is een goudkleurige keramische coating die wordt toegepast door fysieke dampafzetting (PVD). Hoge hardheid in combinatie met lage wrijvings eigenschappen zorgt voor aanzienlijk langere standtijd of betere snijprestaties van gereedschappen die niet zijn gecoat. TiN coatings worden voornamelijk gebruikt voor boren en tappen.
Titanium Aluminium Nitride coatingen (TiAlN, TiAlN-Top & X-CEED)		Titanium Aluminium Nitride is een meerlaagse keramische coating, aangebracht door middel van PVD coating technologie, die een hoge taaiheid en oxidatieweerstand vertoont. Deze eigenschappen maken het ideaal voor hogere snelheden en voedingen, terwijl de levensduur van het gereedschap wordt verlengd. TiAlN wordt gebruikt in boren, tappen en frezen en kan geschikt zijn voor gebruik bij het bewerken zonder koelmiddel. TiAlN-Top coating is hetzelfde als TiAlN, maar met een post-coating proces om onvolkomenheden glad te polijsten, de spaanafvoer te verbeteren en opbouw van de snijkant te verminderen.
Alcrona coating (Alcrona-Top)		De Alcrona (AlCrN) familie van coatings zijn aluminiumchromnitride coatings die meestal worden gebruikt voor frezen. De twee unieke eigenschappen van deze coatings zijn hoge hardheid bij hoge temperatuur- en oxidatieweerstand. Bij gebruik op gereedschappen voor bewerkings toepassingen met zware mechanische en thermische belastingen, vertalen deze eigenschappen zich in een superieure slijtvastheid. Meerdere lagen of speciale versies van van deze coatings zijn beschikbaar en afgestemd op diverse gereedschappen en toepassingen.



Basismateriaal (BMC)	HSS-E	HSS	HSS	HSS	HSS	HSS	HSS-E	HSS-E	HSS	HSS HM	HSS-E	HSS-E	HSS-E
Productienorm (BSG)	DORMER	DIN 1897	DIN 1897	DIN 1897	DIN 1897	DIN ANSI	DIN 1897	DIN 1897	DIN 1897	DIN 8037	DIN 1899	DIN ANSI	DIN ANSI
Boordiepte zonder lossen (ULDR)	1xD	1.25xD	1xD	1.5xD	2.5xD	2.5xD	2.5xD	2.5xD	2.5xD	2.5xD	2.5xD	3xD	3xD
Tophoek	180°	120°	90°/120°	120°	135°	135°	130°	135°	130°	118°	118°	130°	130°
Coating	Bronze	ST	Bright	ST	ST	TiN-Tip	Bronze	Bronze	TiN	Bright ST	Bright	Bright	Alcrona Top
Schacht													
Spiraalvorm	λ20-35°	λ20-35°	λ20-35°	λ20-35°	λ20-35°	λ20-35°	λ20-35°	λ20-35°	λ32-40°	λ10-20°	λ20-35°	λ>35°	λ>35°
Snijrichting	R	R	R	R	R	R	R	R	R	R	R	R	R
Koeling (CSP)													
Productfamiliecode	A723	A119	A122	A123	A120	A022	A620	A117	A520	A124	A720	A920	A921
	6.00 - 8.00	3.30 - 5.10	6.00 - 20.00	3/32 - 1/4	0.50 - 25.00	0.50 - 16.00	2.50 - 13.00	1.00 - 13.00	3.00 - 13.00	3.00 - 16.00	0.15 - 1.40	1.00 - 20.00	2.50 - 16.00
	76	77	78	79	80	82	84	86	88	90	91	92	94
P	P1	■	■	■	■	■	■	■	■	■	■	■	■
	P2	■	■	■	■	■	■	■	■	■	■	■	■
	P3	■	■	■	■	■	■	■	■	■	■	■	■
	P4	■	■	■	■	■	■	■	■	■	■	■	■
M	M1		■	■	■	■	■	■	■	■	■	■	■
	M2		■	■	■	■	■	■	■	■	■	■	■
	M3		■	■	■	■	■	■	■	■	■	■	■
	M4		■	■	■	■	■	■	■	■	■	■	■
K	K1			■	■	■	■	■	■	■	■	■	■
	K2			■	■	■	■	■	■	■	■	■	■
	K3			■	■	■	■	■	■	■	■	■	■
	K4			■	■	■	■	■	■	■	■	■	■
	K5			■	■	■	■	■	■	■	■	■	■
N	N1		■	■	■	■	■	■	■	■	■	■	■
	N2		■	■	■	■	■	■	■	■	■	■	■
	N3		■	■	■	■	■	■	■	■	■	■	■
	N4		■	■	■	■	■	■	■	■	■	■	■
	N5												
S	S1		■	■	■	■	■	■	■	■	■	■	■
	S2		■	■	■	■	■	■	■	■	■	■	■
	S3		■	■	■	■	■	■	■	■	■	■	■
	S4		■	■	■	■	■	■	■	■	■	■	■
H	H1												
	H2												
	H3												
	H4												

■ Geschikt ■ Beperkt geschikt



	HSS	HSS	HSS	HSS	HSS	HSS-E	HSS-E	HSS HM	HSS	HSS-E	HSS-E	HSS-E	HSS	HSS	HSS	
	DIN 338	DIN 338	DIN 338	DIN 338	DIN 338	DIN 338	DIN 338	DIN 338	DIN 338	DIN 338	DIN 338	DIN ANSI	DIN ANSI	DIN ANSI	DIN ANSI	DIN ANSI
	4xD	4xD	4xD	4xD	4xD	4xD	4xD	4xD	4xD	4xD	5xD	6xD	6xD	6xD	4xD	4xD
	118°	118°	118°	118°	135°	130°	135°	118°	130°	130°	130°	130°	130°	118°	135°	118°
	TiN-Tip	TiN-Tip	ST	ST	ST	Bright	Bronze	Bright ST	TiN	TiAlN Top	Bright	Alcrona Top	ST	Bright	Bright	
	λ>20-35°	λ>20-35°	λ>20-35°	λ>20-35°	λ>35°	VA	λ>20-35°	λ>20-35°	λ>32-40°	λ>35°	λ>35°	λ>35°	λ>20-35°	λ>20-35°	λ>20-35°	
	R	R	R	L	R	R	R	R	R	R	R	R	R	R	R	R
	A002	A002S	A100	A101	A108	A147	A777	A160	A510	A553	A900	A901	A170	A243	A244	
	1.00 - 16.00	2.00 - 13.00	0.20 - 20.00	1.00 - 12.00	1.00 - 16.00	0.30 - 15.0	0.30 - 16.00	4.00 - 16.00	3.00 - 14.00	5.00 - 20.00	1.00 - 20.00	1.50 - 16.00	13.00 - 1.1/2	3/32 - 1/4	1/8 - 1/4	
	96	98	99	103	104	106	108	110	111	113	114	116	118	120	121	
P1	■	■	■	■	■	■	■	■	■	■	■	■	■	■	■	■
P2	■	■	■	■	■	■	■	■	■	■	■	■	■	■	■	■
P3	■	■	■	■	■	■	■	■	■	■	■	■	■	■	■	■
P4	■	■	■	■	■	■	■	■	■	■	■	■	■	■	■	■
M1	■	■	■	■	■	■	■	■	■	■	■	■	■	■	■	■
M2	■	■	■	■	■	■	■	■	■	■	■	■	■	■	■	■
M3	■	■	■	■	■	■	■	■	■	■	■	■	■	■	■	■
M4	■	■	■	■	■	■	■	■	■	■	■	■	■	■	■	■
K1	■	■	■	■	■	■	■	■	■	■	■	■	■	■	■	■
K2	■	■	■	■	■	■	■	■	■	■	■	■	■	■	■	■
K3	■	■	■	■	■	■	■	■	■	■	■	■	■	■	■	■
K4	■	■	■	■	■	■	■	■	■	■	■	■	■	■	■	■
K5	■	■	■	■	■	■	■	■	■	■	■	■	■	■	■	■
N1	■	■	■	■	■	■	■	■	■	■	■	■	■	■	■	■
N2	■	■	■	■	■	■	■	■	■	■	■	■	■	■	■	■
N3	■	■	■	■	■	■	■	■	■	■	■	■	■	■	■	■
N4	■	■	■	■	■	■	■	■	■	■	■	■	■	■	■	■
N5	■	■	■	■	■	■	■	■	■	■	■	■	■	■	■	■
S1	■	■	■	■	■	■	■	■	■	■	■	■	■	■	■	■
S2	■	■	■	■	■	■	■	■	■	■	■	■	■	■	■	■
S3	■	■	■	■	■	■	■	■	■	■	■	■	■	■	■	■
S4	■	■	■	■	■	■	■	■	■	■	■	■	■	■	■	■
H1																
H2																
H3																
H4																



Basismateriaal (BMC)	HSS	HSS-E	HSS-E	HSS	HSS-E	HSS-E	HSS-E	HSS	HSS	HSS-E	HSS HM	HSS	HSS
Productienorm (BSG)	DIN 340	DIN ANSI	DIN ANSI	BS 328	DIN 1869-1	DIN 1869-2	DIN 1869-3	DIN 345	DIN 345	DIN 345	DIN 345	DIN 341	DIN 1870(1)
Boordiepte zonder lossen (ULDR)	6xD	10xD	10xD	10xD	15xD	20xD	25xD	4xD	4xD	4xD	4xD	6xD	10xD
Tophoek	118°	130°	130°	118°	130°	130°	130°	118°	118°	118°	118°	118°	118°
Coating	ST	Bright	Alcrona Top	ST	Bright	Bright	Bright	ST	TiN	Bronze	Bright ST	ST	ST
Schacht													
Spiraalvorm	λ>20-35°	λ>35°	λ>35°	λ>20-35°	λ>35°	λ>35°	λ>35°	λ>20-35°	λ>20-35°	λ>20-35°	λ>20-35°	λ>20-35°	λ>20-35°
Snijrichting	R	R	R	R	R	R	R	R	R	R	R	R	R
Koeling (CSP)													
Productfamiliecode	A110	A940	A941	A125	A976	A977	A978	A130	A530	A730	A166	A350	A345
	0.50 - 1"	1.00 - 20.00	1.00 - 16.00	1.40 - 1"	1.50 - 14.00	1.50 - 14.00	3.00 - 10.00	3.00 - 50.80	8.50 - 40.00	10.00 - 32.00	10.00 - 33.00	5.00 - 50.00	8.00 - 50.00
	122	124	126	128	130	132	133	134	140	141	143	144	146
P	P1	■	■	■	■	■	■	■	■	■	■	■	■
	P2	■	■	■	■	■	■	■	■	■	■	■	■
	P3	■	■	■	■	■	■	■	■	■	■	■	■
	P4	■	■	■	■	■	■	■	■	■	■	■	■
M	M1	■	■	■	■	■	■	■	■	■	■	■	■
	M2	■	■	■	■	■	■	■	■	■	■	■	■
	M3	■	■	■	■	■	■	■	■	■	■	■	■
	M4	■	■	■	■	■	■	■	■	■	■	■	■
K	K1	■	■	■	■	■	■	■	■	■	■	■	■
	K2	■	■	■	■	■	■	■	■	■	■	■	■
	K3	■	■	■	■	■	■	■	■	■	■	■	■
	K4	■	■	■	■	■	■	■	■	■	■	■	■
	K5	■	■	■	■	■	■	■	■	■	■	■	■
N	N1	■	■	■	■	■	■	■	■	■	■	■	■
	N2	■	■	■	■	■	■	■	■	■	■	■	■
	N3	■	■	■	■	■	■	■	■	■	■	■	■
	N4	■	■	■	■	■	■	■	■	■	■	■	■
	N5	■	■	■	■	■	■	■	■	■	■	■	■
S	S1	■	■	■	■	■	■	■	■	■	■	■	■
	S2	■	■	■	■	■	■	■	■	■	■	■	■
	S3	■	■	■	■	■	■	■	■	■	■	■	■
	S4	■	■	■	■	■	■	■	■	■	■	■	■
H	H1												
	H2												
	H3												
	H4												

■ Geschikt ■ Beperkt geschikt



	HSS	HSS	HSS	HSS	HSS	HSS	HSS	HSS	HSS	HSS-E	HSS-E	HSS	HSS	HSS	HSS-E
	DIN 1870(1)	DIN 1870(2)	DIN 8374	DIN 8376	DIN 8377	DORNER	DORNER	DIN 333A	DIN 333A	DIN 333A	DIN 333A	DIN 333R	DORNER	BS 328	DIN 333A
	15xD	20xD	4xD	4xD	4xD	2.5xD	2.5xD	1xD	1xD	1xD	1xD	1xD	1xD	1xD	1xD
	A951	A952	A400	A402	A405	A412	A413	A200	A205	A206	A266	A210	A201	A225	A237
	10.00 - 30.00	8.00 - 40.00	M3 - M10	M3 - M10	M6 - M18	M3 - M10	M3 - M10	0.50 - 12.50	1.00 - 5.00	1.00 - 5.00	1.00 - 5.00	0.50 - 10.00	0.63 - 6.00	3/64 - 5/16	1.60 - 10.00
	148	149	150	151	152	153	154	155	156	157	158	159	160	161	162
P1	■	■	■	■	■	■	■	■	■	■	■	■	■	■	■
P2	■	■	■	■	■	■	■	■	■	■	■	■	■	■	■
P3	■	■	■	■	■	■	■	■	■	■	■	■	■	■	■
P4	■	■	■	■	■	■	■	■	■	■	■	■	■	■	■
M1	■	■	■	■	■	■	■	■	■	■	■	■	■	■	■
M2	■	■	■	■	■	■	■	■	■	■	■	■	■	■	■
M3	■	■	■	■	■	■	■	■	■	■	■	■	■	■	■
M4	■	■	■	■	■	■	■	■	■	■	■	■	■	■	■
K1	■	■	■	■	■	■	■	■	■	■	■	■	■	■	■
K2	■	■	■	■	■	■	■	■	■	■	■	■	■	■	■
K3	■	■	■	■	■	■	■	■	■	■	■	■	■	■	■
K4	■	■	■	■	■	■	■	■	■	■	■	■	■	■	■
K5	■	■	■	■	■	■	■	■	■	■	■	■	■	■	■
N1	■	■	■	■	■	■	■	■	■	■	■	■	■	■	■
N2	■	■	■	■	■	■	■	■	■	■	■	■	■	■	■
N3	■	■	■	■	■	■	■	■	■	■	■	■	■	■	■
N4	■	■	■	■	■	■	■	■	■	■	■	■	■	■	■
N5															
S1	■	■	■	■	■	■	■	■	■	■	■	■	■	■	■
S2	■	■	■	■	■	■	■	■	■	■	■	■	■	■	■
S3	■	■	■	■	■	■	■	■	■	■	■	■	■	■	■
S4	■	■	■	■	■	■	■	■	■	■	■	■	■	■	■
H1															
H2															
H3															
H4															



	HSS-E		HSS	HSS	HSS	HSS	HSS
	DIN 333R	DORMER	DIN ANSI	DIN 338	DIN 338	DIN 338	DIN 338
	1xD	1xD	2.5xD	4xD	4xD	4xD	4xD
Basismateriaal (BMC)	HSS-E		HSS	HSS	HSS	HSS	HSS
Productienorm (BSG)	DIN 333R	DORMER	DIN ANSI	DIN 338	DIN 338	DIN 338	DIN 338
Boordiepte zonder lossen (ULDR)	1xD	1xD	2.5xD	4xD	4xD	4xD	4xD
Tophoek	R	60°	135°	118°	118°	118°	118°
Coating	Bright	Bright	TiN-Tip	TiN-Tip	TiN-Tip	TiN-Tip	TiN-Tip
Schacht	H						
Spiraalvorm			λ 20-35°	λ 20-35°	λ 20-35°	λ 20-35°	λ 20-35°
Snijrichting	R	R	R	R	R	R	R
Koeling (CSP)							
Productfamiliecode	A238	A242	A088	A095	A087	A094	A089
	1.60 - 8.00	1.00 - 5.00	Set	Set	Set	Set	Set
	163	164	165	165	166	166	167
P	P1	■	■				
	P2	■	■				
	P3	■	■				
	P4	▣	▣				
M	M1	▣	▣				
	M2	▣	▣				
	M3	▣	▣				
	M4	▣	▣				
K	K1	■	■				
	K2	▣	▣				
	K3	▣	▣				
	K4	▣	▣				
	K5	▣	▣				
N	N1	▣	▣				
	N2	▣	▣				
	N3	▣	▣				
	N4	▣	▣				
	N5						
S	S1	▣	▣				
	S2	▣	▣				
	S3	▣	▣				
	S4	▣	▣				
H	H1						
	H2						
	H3						
	H4						

■ Geschikt ▣ Beperkt geschikt



- HSS
- DIN 338
- 4xD
- 118°
- TiN-Tip
-
- 20-35°
- R

- HSS
- DIN 338
- 4xD
- 118°
- TiN-Tip
-
- 20-35°
- R

- HSS
- DIN 338
- 4xD
- 118°
- ST
-
- 20-35°
- R

- HSS
- DIN 338
- 4xD
- 118°
- ST
-
- 20-35°
- R



	A099	A099	A199	A080	A190
--	-------------	-------------	-------------	-------------	-------------

	Set	Drillboy	Set	Set	Set
--	-----	----------	-----	-----	-----

	📖 168	📖 168	📖 169	📖 169	📖 170
--	-------	-------	-------	-------	-------

P1					
P2					
P3					
P4					
M1					
M2					
M3					
M4					
K1					
K2					
K3					
K4					
K5					
N1					
N2					
N3					
N4					
N5					
S1					
S2					
S3					
S4					
H1					
H2					
H3					
H4					



		HSS	HSS	HSS	HSS-E		
Basismateriaal (BMC)		HSS	HSS	HSS	HSS-E		
Productienorm (BSG)		DIN 338	DIN 338	DIN 338	DIN 338		
Boordiepte zonder lossen (ULDR)		4xD	4xD	4xD	4xD		
Tophoek		118°	118°	135°	135°	60°	
Coating		ST	ST	ST	Bronze		
Schacht							
Spiraalvorm		λ 20-35°	λ 20-35°	λ >35°	λ 20-35°		
Snijrichting		R	R	R	R		
Koeling (CSP)							
Productfamiliecode		A191	A191	A188	A295	A296	M150 M151
		Set	Set	Set	Set	Set	
		171	171	172	172	173	173 174
P	P1						
	P2						
	P3						
	P4						
M	M1						
	M2						
	M3						
	M4						
K	K1						
	K2						
	K3						
	K4						
	K5						
N	N1						
	N2						
	N3						
	N4						
	N5						
S	S1						
	S2						
	S3						
	S4						
H	H1						
	H2						
	H3						
	H4						



M152

📖 174

- P1
- P2
- P3
- P4
- M1
- M2
- M3
- M4
- K1
- K2
- K3
- K4
- K5
- N1
- N2
- N3
- N4
- N5
- S1
- S2
- S3
- S4
- H1
- H2
- H3
- H4



A723



HSS-E (5% Co) puntlasboor, bronskleurig

Boor met speciaal ontworpen snijkant en voorste punt voor het verwijderen of uitboren van puntlassen, gewoonlijk voor het verwijderen plaatwerkdelen in een autoreparatiewerkplaats. De korte spiraallengte geeft meer stabiliteit en maakt de boor minder kwetsbaar bij gebruik in een handboormachine. De bronzen afwerking is een dunne oxide-laag en een indicatie voor kobalt.

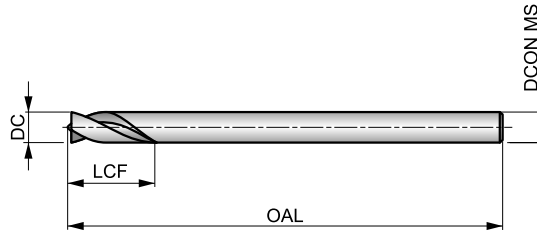

HSS-E		1xD
	DC h8	

De tabel geeft de geschiktheid aan voor de materiaalgroep en de startwaarden voor de snijnelheid (m/min) en de letter verwijst naar de toe te passen voeding (fn), zie vanaf pagina 175.

P1.1 ■ 33 D	P1.2 ■ 37 D	P1.3 ■ 38 D	P2.1 ■ 28 D	P2.2 ■ 25 C	P3.1 ■ 20 C	P3.2 ■ 20 C	P4.1 ■ 20 C
-----------------------	-----------------------	-----------------------	-----------------------	-----------------------	-----------------------	-----------------------	-----------------------

Product	DC	DC	LCF	OAL	DCON MS
	(mm)	(inch)			
A7236.0X66	6.00	0.2362	18.0	66.0	6.00
A7236.0X93	6.00	0.2362	18.0	93.0	6.00
A7238.0X79	8.00	0.3150	24.0	79.0	8.00
A7238.0X117	8.00	0.3150	24.0	117.0	8.00



A119



HSS plaatwerkboor, dubbel zijdig, stoomontlaten

Een korte boor met aan beide zijden een boorpunt, ontworpen voor het boren van gaten in plaatstaal. Het is mogelijk om beide uiteinden te gebruiken, waardoor het gereedschap twee keer zo lang meegaat. Met 120° tophoek om zelfcentrerend te bevorderen. Geschikt voor het boren in vele materialen. De stoomontlaten afwerking houdt snijvloestof vast en voorkomt het aanlassen van spanen.

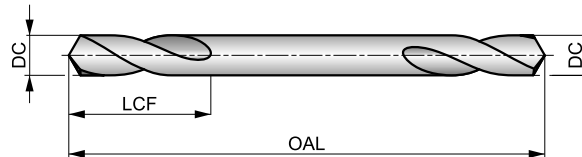

HSS	DIN 1897	1.25xD
120°	ST	
20-35°	R	DC h8

De tabel geeft de geschiktheid aan voor de materiaalgroep en de startwaarden voor de snijnsnelheid (m/min) en de letter verwijst naar de toe te passen voeding (fn), zie vanaf pagina 175.

P1.1 ■ 31 C	P1.2 ■ 34 C	P1.3 ■ 35 C	P2.1 ■ 26 C	P2.2 ■ 23 C	P2.3 ■ 20 C	P3.1 ■ 12 C	P3.2 ■ 9 C	P3.3 ■ 8 C	P4.1 ■ 7 C	P4.2 ■ 6 C	P4.3 ■ 5 A	M1.1 ■ 21 A	M1.2 ■ 17 A
M2.1 ■ 18 A	M2.2 ■ 15 A	M3.1 ■ 8 C	M3.2 ■ 7 C	M3.3 ■ 6 C	M4.1 ■ 10 A	N1.1 ■ 33 C	N1.2 ■ 25 C	N1.3 ■ 17 C	N2.1 ■ 46 C	N2.2 ■ 42 C	N2.3 ■ 30 C	N3.1 ■ 56 C	N3.2 ■ 33 C
N3.3 ■ 17 A	N4.1 ■ 30 I	N4.2 ■ 35 C	S1.1 ■ 27 A	S1.2 ■ 12 A	S1.3 ■ 7 A	S2.1 ■ 5 C	S2.2 ■ 4 C	S3.1 ■ 4 C	S3.2 ■ 3 C	S4.1 ■ 3 C	S4.2 ■ 2 C		

Plaatboor.

Product	DC	DC	LCF	OAL	DCON MS
	(mm)	(inch)	(mm)	(mm)	(mm)
A1193.3	3.30	0.1299	11.0	49.0	3.30
A1193.6	3.60	0.1417	12.0	52.0	3.60
A1194.1	4.10	0.1614	14.0	55.0	4.10
A1194.2	4.20	0.1654	14.0	55.0	4.20
A1194.9	4.90	0.1929	17.0	62.0	4.90
A1195.1	5.10	0.2008	17.0	62.0	5.10



A122



HSS NC centreerboor

Wordt gebruikt om een centrering te maken in het te boren materiaal, zodat de positionering verbeterd wordt. Leverbaar met een tophoek van 90° of 120°. Keuze is afhankelijk van de tophoek van de boor die gebruikt gaat worden om het uiteindelijke gat te boren. Geschikt voor het boren in vele materialen. Kan tevens het te boren gat tijdens het centeren voorzien van een aanschuining.

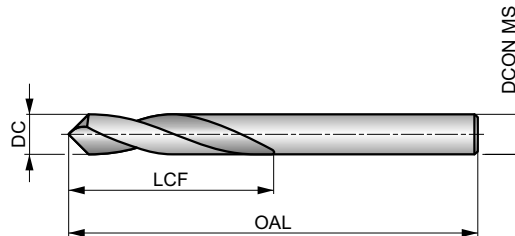

HSS	DIN 1897	1xD
90°/120°	Bright	
λ 20-35°	R	DC h8

De tabel geeft de geschiktheid aan voor de materiaalgroep en de startwaarden voor de snijsnelheid (m/min) en de letter verwijst naar de toe te passen voeding (fn), zie vanaf pagina 175.

P1.1 ■ 36 E	P1.2 ■ 40 E	P1.3 ■ 41 E	P2.1 ■ 31 E	P2.2 ■ 27 C	P2.3 ■ 24 C	P3.1 ■ 21 C	P3.2 ■ 17 C	P3.3 ■ 14 C	P4.1 ■ 12 C	P4.2 ■ 10 C	P4.3 ■ 9 B	M1.1 ■ 22 C	M1.2 ■ 19 C
M2.1 ■ 20 C	M2.2 ■ 16 C	M3.1 ■ 10 D	M3.2 ■ 9 D	M3.3 ■ 8 D	M4.1 ■ 10 B	K1.1 ■ 32 E	K1.2 ■ 24 C	K1.3 ■ 18 C	K2.1 ■ 25 C	K2.2 ■ 20 C	K2.3 ■ 16 B	K3.1 ■ 22 C	K3.2 ■ 17 C
K3.3 ■ 13 B	K4.1 ■ 20 C	K4.2 ■ 15 C	K4.3 ■ 11 B	K4.4 ■ 10 B	K4.5 ■ 8 B	K5.1 ■ 23 C	K5.2 ■ 17 C	K5.3 ■ 13 B	N1.1 ■ 33 E	N1.2 ■ 25 E	N1.3 ■ 17 E	N2.1 ■ 46 D	N2.2 ■ 42 D
N2.3 ■ 30 D	N3.1 ■ 56 D	N3.2 ■ 33 E	N3.3 ■ 17 D	N4.1 ■ 30 F	N4.2 ■ 35 E	N4.3 ■ 17 D	S1.1 ■ 27 C	S1.2 ■ 12 B	S1.3 ■ 7 A	S2.1 ■ 11 C	S2.2 ■ 6 A	S3.1 ■ 8 C	S3.2 ■ 4 A
S4.1 ■ 6 C	S4.2 ■ 3 A												

Product	DC	DC	LCF	OAL	DCON MS
	(mm)	(inch)			
A1226.0X90	6.00	0.2362	30.0	66.0	6.00
A1226.0X120	6.00	0.2362	30.0	66.0	6.00
A1228.0X90	8.00	0.3150	33.0	79.0	8.00
A1228.0X120	8.00	0.3150	33.0	79.0	8.00
A12210.0X90	10.00	0.3937	35.0	89.0	10.00
A12210.0X120	10.00	0.3937	35.0	89.0	10.00
A12212.0X90	12.00	0.4724	40.0	102.0	12.00
A12212.0X120	12.00	0.4724	40.0	102.0	12.00
A12216.0X90	16.00	0.6299	40.0	115.0	16.00
A12216.0X120	16.00	0.6299	40.0	115.0	16.00
A12220.0X90	20.00	0.7874	55.0	131.0	20.00
A12220.0X120	20.00	0.7874	55.0	131.0	20.00



A123



HSS plaatwerkboor, stoomontlaten

Speciaal ontworpen voor het boren van dunne materialen en plaatstaal. Een tophoek van 120° en een stoomontlaten afwerking waardoor de spanen niet aan de snijkant blijven kleven, wat een betere afwerking van het gat en een nauwkeurige gatdiameter oplevert. Geschikt voor het boren in vele materialen.

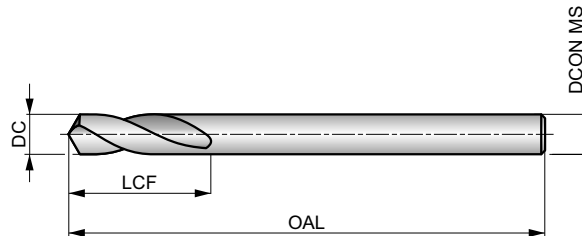

HSS	DIN 1897	1.5×D
120°	ST	
λ 20-35°	R	DC h8

De tabel geeft de geschiktheid aan voor de materiaalgroep en de startwaarden voor de snijsnelheid (m/min) en de letter verwijst naar de toe te passen voeding (fn), zie vanaf pagina 175.

P1.1 ■ 36 E	P1.2 ■ 40 E	P1.3 ■ 41 E	P2.1 ■ 31 E	P2.2 ■ 27 C	P2.3 ■ 24 C	P3.1 ■ 21 C	P3.2 ■ 17 C	P3.3 ■ 14 C	P4.1 ■ 12 C	P4.2 ■ 10 C	P4.3 ■ 9 B	M1.1 ■ 22 C	M1.2 ■ 19 C
M2.1 ■ 20 C	M2.2 ■ 16 C	M3.1 ■ 10 D	M3.2 ■ 9 D	M3.3 ■ 8 D	M4.1 ■ 10 B	N1.1 ■ 33 E	N1.2 ■ 25 E	N1.3 ■ 17 E	N2.1 ■ 46 D	N2.2 ■ 42 D	N2.3 ■ 30 D	N3.1 ■ 56 D	N3.2 ■ 33 E
N3.3 ■ 17 D	N4.1 ■ 30 F	N4.2 ■ 35 E	N4.3 ■ 17 D	S1.1 ■ 27 C	S1.2 ■ 12 B	S1.3 ■ 7 A	S2.1 ■ 11 C	S2.2 ■ 6 A	S3.1 ■ 8 C	S3.2 ■ 4 A	S4.1 ■ 6 C	S4.2 ■ 3 A	

Plaatboor.

Product	DC	DC	DC	LCF	OAL	DCON MS
	(inch)	(mm)	(inch)			
A1233/32S	3/32	2.38	0.0937	14.0	43.0	2.38
A1232.5S	–	2.50	0.0984	14.0	43.0	2.50
A1233.0S	–	3.00	0.1181	16.0	46.0	3.00
A1231/8S	1/8	3.18	0.1252	18.0	49.0	3.18
A1233.2S	–	3.20	0.1260	18.0	49.0	3.20
A1233.3S	–	3.30	0.1299	18.0	49.0	3.30
A1233.5S	–	3.50	0.1378	18.0	52.0	3.50
A1233.7S	–	3.70	0.1457	18.0	52.0	3.70
A1235/32S	5/32	3.97	0.1563	18.0	55.0	3.97
A1234.0S	–	4.00	0.1575	18.0	55.0	4.00
A1234.1S	–	4.10	0.1614	18.0	55.0	4.10
A1234.2S	–	4.20	0.1654	18.0	55.0	4.20
A1234.5S	–	4.50	0.1772	18.0	58.0	4.50
A1233/16S	3/16	4.76	0.1875	18.0	62.0	4.76
A1234.8S	–	4.80	0.1890	18.0	62.0	4.80
A1234.9S	–	4.90	0.1929	18.0	62.0	4.90
A1235.0S	–	5.00	0.1969	18.0	62.0	5.00
A1235.5S	–	5.50	0.2165	18.0	66.0	5.50
A1237/32S	7/32	5.56	0.2188	18.0	66.0	5.56
A1236.0S	–	6.00	0.2362	18.0	66.0	6.00
A1231/4S	1/4	6.35	0.2500	19.0	70.0	6.35



A120



HSS extra korte spiraalboor, DIN1897, stoomontlaten

Veelzijdige extra korte plaatwerkboor. De 135° split point vermindert de krachten bij het boren en voorkomt dat de boor over het oppervlak van het materiaal verloopt. De stoomontlaten afwerking houdt snijvloeistof vast en voorkomt het aanlassen van spanen. Geschikt voor hand- en stationaire boormachines.

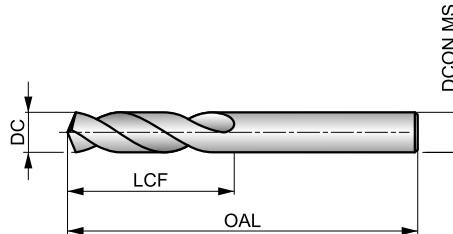

HSS	DIN 1897	2.5×D
135°	ST	
λ 20-35°	R	DC h8

De tabel geeft de geschiktheid aan voor de materiaalgroep en de startwaarden voor de snijnsnelheid (m/min) en de letter verwijst naar de toe te passen voeding (fn), zie vanaf pagina 175.

P1.1 ■ 36 J	P1.2 ■ 40 J	P1.3 ■ 41 J	P2.1 ■ 31 J	P2.2 ■ 27 G	P2.3 ■ 24 F	P3.1 ■ 21 G	P3.2 ■ 17 G	P3.3 ■ 14 F	P4.1 ■ 12 G	P4.2 ■ 10 F	P4.3 ■ 9 E	M1.1 ■ 22 F	M1.2 ■ 19 F
M2.1 ■ 20 F	M2.2 ■ 16 F	M3.1 ■ 10 H	M3.2 ■ 9 H	M3.3 ■ 8 H	M4.1 ■ 10 D	K1.1 ■ 32 J	K1.2 ■ 24 G	K1.3 ■ 18 G	K2.1 ■ 25 F	K2.2 ■ 20 F	K2.3 ■ 16 F	K3.1 ■ 22 F	K3.2 ■ 17 F
K3.3 ■ 13 F	K4.1 ■ 20 F	K4.2 ■ 15 F	K4.3 ■ 11 F	K4.4 ■ 10 F	K4.5 ■ 8 F	K5.1 ■ 23 F	K5.2 ■ 17 F	K5.3 ■ 13 F	N1.1 ■ 33 K	N1.2 ■ 25 K	N1.3 ■ 17 J	N2.1 ■ 46 I	N2.2 ■ 42 I
N2.3 ■ 30 I	N3.1 ■ 64 I	N3.2 ■ 38 J	N3.3 ■ 19 H	N4.1 ■ 30 K	N4.2 ■ 35 I	N4.3 ■ 17 G	S1.1 ■ 27 G	S1.2 ■ 16 E	S1.3 ■ 8 C	S2.1 ■ 11 F	S2.2 ■ 6 B	S3.1 ■ 8 F	S3.2 ■ 4 B
S4.1 ■ 6 F	S4.2 ■ 3 B												

DC <= 1mm blank; 2.9mm => DC >= 13.0mm 118° tophoek.

Product	DC (inch)	DC (mm)	DC (inch)	LCF (mm)	OAL (mm)	DCON MS (mm)
A120.5	-	0.50	0.0197	3.0	20.0	0.50
A120.6	-	0.60	0.0236	3.5	21.0	0.60
A120.7	-	0.70	0.0276	4.5	23.0	0.70
A1201/32	1/32	0.79	0.0313	5.0	24.0	0.79
A120.8	-	0.80	0.0315	5.0	24.0	0.80
A120.9	-	0.90	0.0354	5.5	25.0	0.90
A1201.0	-	1.00	0.0394	6.0	26.0	1.00
A1201.1	-	1.10	0.0433	7.0	28.0	1.10
A1203/64	3/64	1.19	0.0469	8.0	30.0	1.19
A1201.2	-	1.20	0.0472	8.0	30.0	1.20
A1201.3	-	1.30	0.0512	8.0	30.0	1.30
A1201.4	-	1.40	0.0551	9.0	32.0	1.40
A1201.5	-	1.50	0.0591	9.0	32.0	1.50
A1201/16	1/16	1.59	0.0625	10.0	34.0	1.59
A1201.6	-	1.60	0.0630	10.0	34.0	1.60
A1201.7	-	1.70	0.0669	10.0	34.0	1.70
A1201.8	-	1.80	0.0709	11.0	36.0	1.80
A1201.9	-	1.90	0.0748	11.0	36.0	1.90
A1205/64	5/64	1.98	0.0781	12.0	38.0	1.98
A1202.0	-	2.00	0.0787	12.0	38.0	2.00
A1202.1	-	2.10	0.0827	12.0	38.0	2.10
A1202.2	-	2.20	0.0866	13.0	40.0	2.20
A1202.25	-	2.25	0.0886	13.0	40.0	2.25

Product	DC (inch)	DC (mm)	DC (inch)	LCF (mm)	OAL (mm)	DCON MS (mm)
A1202.3	-	2.30	0.0906	13.0	40.0	2.30
A1203/32	3/32	2.38	0.0938	14.0	43.0	2.38
A1202.4	-	2.40	0.0945	14.0	43.0	2.40
A1202.5	-	2.50	0.0984	14.0	43.0	2.50
A1202.6	-	2.60	0.1024	14.0	43.0	2.60
A1202.65	-	2.65	0.1043	14.0	43.0	2.65
A1202.7	-	2.70	0.1063	16.0	46.0	2.70
A1207/64	7/64	2.78	0.1094	16.0	46.0	2.78
A1202.8	-	2.80	0.1102	16.0	46.0	2.80
A1202.9	-	2.90	0.1142	16.0	46.0	2.90
A1203.0	-	3.00	0.1181	16.0	46.0	3.00
A1203.1	-	3.10	0.1220	18.0	49.0	3.10
A1201/8	1/8	3.18	0.1252	18.0	49.0	3.18
A1203.2	-	3.20	0.1260	18.0	49.0	3.20
A1203.25	-	3.25	0.1280	18.0	49.0	3.25
A1203.3	-	3.30	0.1299	18.0	49.0	3.30
A1203.4	-	3.40	0.1339	20.0	52.0	3.40
A1203.5	-	3.50	0.1378	20.0	52.0	3.50
A1209/64	9/64	3.57	0.1406	20.0	52.0	3.57
A1203.6	-	3.60	0.1417	20.0	52.0	3.60
A1203.7	-	3.70	0.1457	20.0	52.0	3.70
A1203.8	-	3.80	0.1496	22.0	55.0	3.80
A1203.9	-	3.90	0.1535	22.0	55.0	3.90



Product	DC	DC	DC	LCF	OAL	D CON MS
	(inch)	(mm)	(inch)	(mm)	(mm)	(mm)
A1205/32	5/32	3.97	0.1563	22.0	55.0	3.97
A1204.0	–	4.00	0.1575	22.0	55.0	4.00
A1204.1	–	4.10	0.1614	22.0	55.0	4.10
A1204.2	–	4.20	0.1654	22.0	55.0	4.20
A1204.3	–	4.30	0.1693	24.0	58.0	4.30
A12011/64	11/64	4.37	0.1719	24.0	58.0	4.37
A1204.4	–	4.40	0.1732	24.0	58.0	4.40
A1204.5	–	4.50	0.1772	24.0	58.0	4.50
A1204.6	–	4.60	0.1811	24.0	58.0	4.60
A1204.7	–	4.70	0.1850	24.0	58.0	4.70
A1203/16	3/16	4.76	0.1875	26.0	62.0	4.76
A1204.8	–	4.80	0.1890	26.0	62.0	4.80
A1204.9	–	4.90	0.1929	26.0	62.0	4.90
A1205.0	–	5.00	0.1969	26.0	62.0	5.00
A1205.1	–	5.10	0.2008	26.0	62.0	5.10
A12013/64	13/64	5.16	0.2031	26.0	62.0	5.16
A1205.2	–	5.20	0.2047	26.0	62.0	5.20
A1205.3	–	5.30	0.2087	26.0	62.0	5.30
A1205.4	–	5.40	0.2126	28.0	66.0	5.40
A1205.5	–	5.50	0.2165	28.0	66.0	5.50
A1207/32	7/32	5.56	0.2188	28.0	66.0	5.56
A1205.6	–	5.60	0.2205	28.0	66.0	5.60
A1205.7	–	5.70	0.2244	28.0	66.0	5.70
A1205.8	–	5.80	0.2283	28.0	66.0	5.80
A1205.9	–	5.90	0.2323	28.0	66.0	5.90
A12015/64	15/64	5.95	0.2344	28.0	66.0	5.95
A1206.0	–	6.00	0.2362	28.0	66.0	6.00
A1206.1	–	6.10	0.2402	31.0	70.0	6.10
A1206.2	–	6.20	0.2441	31.0	70.0	6.20
A1206.3	–	6.30	0.2480	31.0	70.0	6.30
A1201/4	1/4	6.35	0.2500	31.0	70.0	6.35
A1206.4	–	6.40	0.2520	31.0	70.0	6.40
A1206.5	–	6.50	0.2559	31.0	70.0	6.50
A1206.6	–	6.60	0.2598	31.0	70.0	6.60
A1206.7	–	6.70	0.2638	31.0	70.0	6.70
A1206.8	–	6.80	0.2677	34.0	74.0	6.80
A1206.9	–	6.90	0.2717	34.0	74.0	6.90
A1207.0	–	7.00	0.2756	34.0	74.0	7.00
A1207.1	–	7.10	0.2795	34.0	74.0	7.10
A1209/32	9/32	7.14	0.2813	34.0	74.0	7.14
A1207.2	–	7.20	0.2835	34.0	74.0	7.20
A1207.3	–	7.30	0.2874	34.0	74.0	7.30
A1207.4	–	7.40	0.2913	34.0	74.0	7.40
A1207.5	–	7.50	0.2953	34.0	74.0	7.50
A1207.6	–	7.60	0.2992	37.0	79.0	7.60
A1207.7	–	7.70	0.3031	37.0	79.0	7.70
A1207.8	–	7.80	0.3071	37.0	79.0	7.80
A1207.9	–	7.90	0.3110	37.0	79.0	7.90
A1205/16	5/16	7.94	0.3125	37.0	79.0	7.94
A1208.0	–	8.00	0.3150	37.0	79.0	8.00
A1208.1	–	8.10	0.3189	37.0	79.0	8.10
A1208.2	–	8.20	0.3228	37.0	79.0	8.20
A1208.3	–	8.30	0.3268	37.0	79.0	8.30
A1208.4	–	8.40	0.3307	37.0	79.0	8.40
A1208.5	–	8.50	0.3346	37.0	79.0	8.50
A1208.6	–	8.60	0.3386	40.0	84.0	8.60
A1208.7	–	8.70	0.3425	40.0	84.0	8.70
A12011/32	11/32	8.73	0.3438	40.0	84.0	8.73
A1208.8	–	8.80	0.3465	40.0	84.0	8.80
A1208.9	–	8.90	0.3504	40.0	84.0	8.90
A1209.0	–	9.00	0.3543	40.0	84.0	9.00
A1209.1	–	9.10	0.3583	40.0	84.0	9.10
A1209.2	–	9.20	0.3622	40.0	84.0	9.20
A1209.3	–	9.30	0.3661	40.0	84.0	9.30
A1209.4	–	9.40	0.3701	40.0	84.0	9.40

Product	DC	DC	DC	LCF	OAL	D CON MS
	(inch)	(mm)	(inch)	(mm)	(mm)	(mm)
A1209.5	–	9.50	0.3740	40.0	84.0	9.50
A1203/8	3/8	9.52	0.3750	43.0	89.0	9.52
A1209.6	–	9.60	0.3780	43.0	89.0	9.60
A1209.7	–	9.70	0.3819	43.0	89.0	9.70
A1209.8	–	9.80	0.3858	43.0	89.0	9.80
A1209.9	–	9.90	0.3898	43.0	89.0	9.90
A12010.0	–	10.00	0.3937	43.0	89.0	10.00
A12010.1	–	10.10	0.3976	43.0	89.0	10.10
A12010.2	–	10.20	0.4016	43.0	89.0	10.20
A12010.3	–	10.30	0.4055	43.0	89.0	10.30
A12013/32	13/32	10.32	0.4063	43.0	89.0	10.32
A12010.4	–	10.40	0.4094	43.0	89.0	10.40
A12010.5	–	10.50	0.4134	43.0	89.0	10.50
A12010.6	–	10.60	0.4173	43.0	89.0	10.60
A12010.7	–	10.70	0.4213	47.0	95.0	10.70
A12010.8	–	10.80	0.4252	47.0	95.0	10.80
A12010.9	–	10.90	0.4291	47.0	95.0	10.90
A12011.0	–	11.00	0.4331	47.0	95.0	11.00
A12011.1	–	11.10	0.4370	47.0	95.0	11.10
A1207/16	7/16	11.11	0.4375	47.0	95.0	11.11
A12011.2	–	11.20	0.4409	47.0	95.0	11.20
A12011.3	–	11.30	0.4449	47.0	95.0	11.30
A12011.5	–	11.50	0.4528	47.0	95.0	11.50
A12011.6	–	11.60	0.4567	47.0	95.0	11.60
A12011.7	–	11.70	0.4606	47.0	95.0	11.70
A12011.8	–	11.80	0.4646	47.0	95.0	11.80
A12011.9	–	11.90	0.4685	51.0	102.0	11.90
A12012.0	–	12.00	0.4724	51.0	102.0	12.00
A12012.1	–	12.10	0.4764	51.0	102.0	12.10
A12012.2	–	12.20	0.4803	51.0	102.0	12.20
A12012.5	–	12.50	0.4921	51.0	102.0	12.50
A1201/2	1/2	12.70	0.5000	51.0	102.0	12.70
A12013.0	–	13.00	0.5118	51.0	102.0	13.00
A12013.5	–	13.50	0.5315	54.0	107.0	13.50
A12014.0	–	14.00	0.5512	54.0	107.0	14.00
A1209/16	9/16	14.29	0.5625	56.0	111.0	14.29
A12014.5	–	14.50	0.5709	56.0	111.0	14.50
A12015.0	–	15.00	0.5906	56.0	111.0	15.00
A12015.5	–	15.50	0.6102	58.0	115.0	15.50
A1205/8	5/8	15.88	0.6250	58.0	115.0	15.88
A12016.0	–	16.00	0.6299	58.0	115.0	16.00
A12016.5	–	16.50	0.6496	60.0	119.0	16.50
A12017.0	–	17.00	0.6693	60.0	119.0	17.00
A12011/16	11/16	17.46	0.6875	62.0	123.0	17.46
A12017.5	–	17.50	0.6890	62.0	123.0	17.50
A12018.0	–	18.00	0.7087	62.0	123.0	18.00
A12018.5	–	18.50	0.7283	64.0	127.0	18.50
A12019.0	–	19.00	0.7480	64.0	127.0	19.00
A1203/4	3/4	19.05	0.7500	66.0	131.0	19.05
A12019.5	–	19.50	0.7677	66.0	131.0	19.50
A12020.0	–	20.00	0.7874	66.0	131.0	20.00
A12020.5	–	20.50	0.8071	68.0	136.0	20.50
A12013/16	13/16	20.64	0.8125	68.0	136.0	20.64
A12021.0	–	21.00	0.8268	68.0	136.0	21.00
A12022.0	–	22.00	0.8661	70.0	141.0	22.00
A1207/8	7/8	22.22	0.8750	70.0	141.0	22.22
A12023.0	–	23.00	0.9055	72.0	146.0	23.00
A12015/16	15/16	23.81	0.9375	75.0	151.0	23.81
A12024.0	–	24.00	0.9449	75.0	151.0	24.00
A12025.0	–	25.00	0.9843	75.0	151.0	25.00



A022



HSS extra korte spiraalboor, DIN1897, TiN-Tip gecoat

Veelzijdige spiraalboor voor gebruik in hand en stationaire machines. Voor het boren in vele materialen. Met 135° tophoek en split point wordt hogere nauwkeurigheid en een betere oppervlaktekwaliteit bereikt. TiN-Tip coating verbetert de prestaties en verlengt de standtijd. Ook zeer geschikt voor het boren in dun materiaal zoals plaatmateriaal.

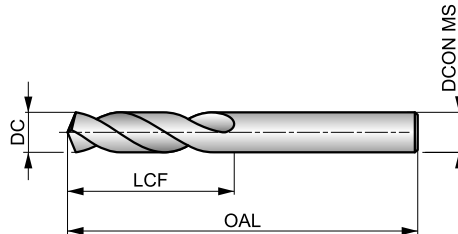

HSS	DIN ANSI	2.5×D
135°	TiN-Tip	
λ 20-35°	R	DC h8

De tabel geeft de geschiktheid aan voor de materiaalgroep en de startwaarden voor de snijsnelheid (m/min) en de letter verwijst naar de toe te passen voeding (fn), zie vanaf pagina 175.

P1.1 ■ 33 K	P1.2 ■ 37 K	P1.3 ■ 38 K	P2.1 ■ 28 K	P2.2 ■ 25 I	P2.3 ■ 22 G	P3.1 ■ 24 H	P3.2 ■ 19 H	P3.3 ■ 16 G	P4.1 ■ 14 H	P4.2 ■ 12 G	P4.3 ▣ 10 E	M1.1 ■ 21 G	M1.2 ■ 17 G
M2.1 ■ 18 G	M2.2 ■ 15 G	M3.1 ▣ 9 I	M3.2 ▣ 8 I	M3.3 ▣ 7 I	M4.1 ▣ 9 E	K1.1 ■ 32 K	K1.2 ■ 24 I	K1.3 ■ 18 I	K2.1 ■ 25 G	K2.2 ■ 20 G	K2.3 ▣ 16 G	K3.1 ■ 22 G	K3.2 ■ 17 G
K3.3 ▣ 13 G	K4.1 ■ 20 G	K4.2 ■ 15 G	K4.3 ▣ 11 G	K4.4 ▣ 10 G	K4.5 ▣ 8 G	K5.1 ■ 23 G	K5.2 ■ 17 G	K5.3 ▣ 13 G	N1.1 ■ 40 F	N1.2 ■ 30 F	N1.3 ■ 20 K	N2.1 ■ 49 J	N2.2 ■ 44 J
N2.3 ■ 32 J	N3.1 ▣ 64 I	N3.2 ▣ 38 K	N3.3 ▣ 19 H	N4.1 ▣ 30 K	N4.2 ▣ 35 I	N4.3 ▣ 17 G	S1.1 ■ 25 I	S1.2 ▣ 14 F	S1.3 ▣ 8 C	S2.1 ▣ 11 F	S2.2 ▣ 6 B	S3.1 ▣ 8 F	S3.2 ▣ 4 B
S4.1 ▣ 6 F	S4.2 ▣ 3 B												

DC < 2mm blank; DC >= 2mm TiN-Tip gecoat en met Split Point.
Deze producten zijn ook in een set verkrijgbaar. Zie A088.

Product	DC (inch)	DC (mm)	DC (inch)	LCF (mm)	OAL (mm)	DCON MS (mm)
A022.5	—	0.50	0.0197	3.0	20.0	0.50
A022.6	—	0.60	0.0236	3.5	21.0	0.60
A022.7	—	0.70	0.0276	4.5	23.0	0.70
A0221/32	1/32	0.79	0.0313	13.0	35.0	0.79
A022.8	—	0.80	0.0315	5.0	24.0	0.80
A022.9	—	0.90	0.0354	5.5	25.0	0.90
A0221.0	—	1.00	0.0394	6.0	26.0	1.00
A0221.1	—	1.10	0.0433	7.0	28.0	1.10
A0223/64	3/64	1.19	0.0469	13.0	35.0	1.19
A0221.2	—	1.20	0.0472	8.0	30.0	1.20
A0221.3	—	1.30	0.0512	8.0	30.0	1.30
A0221.4	—	1.40	0.0551	9.0	32.0	1.40
A0221.5	—	1.50	0.0591	9.0	32.0	1.50
A0221/16	1/16	1.59	0.0625	16.0	41.0	1.59
A0221.6	—	1.60	0.0630	10.0	34.0	1.60
A0221.7	—	1.70	0.0669	10.0	34.0	1.70
A0221.8	—	1.80	0.0709	11.0	36.0	1.80
A0221.9	—	1.90	0.0748	11.0	36.0	1.90
A0225/64	5/64	1.98	0.0781	17.0	43.0	1.98
A0222.0	—	2.00	0.0787	12.0	38.0	2.00
A0222.1	—	2.10	0.0827	12.0	38.0	2.10
A0222.2	—	2.20	0.0866	13.0	40.0	2.20

Product	DC (inch)	DC (mm)	DC (inch)	LCF (mm)	OAL (mm)	DCON MS (mm)
A0222.25	—	2.25	0.0886	13.0	40.0	2.25
A0222.3	—	2.30	0.0906	13.0	40.0	2.30
A0223/32	3/32	2.38	0.0938	20.0	45.0	2.38
A0222.4	—	2.40	0.0945	14.0	43.0	2.40
A0222.5	—	2.50	0.0984	14.0	43.0	2.50
A0222.6	—	2.60	0.1024	14.0	43.0	2.60
A0222.65	—	2.65	0.1043	14.0	43.0	2.65
A0222.7	—	2.70	0.1063	16.0	46.0	2.70
A0227/64	7/64	2.78	0.1094	22.0	47.0	2.78
A0222.8	—	2.80	0.1102	16.0	46.0	2.80
A0222.9	—	2.90	0.1142	16.0	46.0	2.90
A0223.0	—	3.00	0.1181	16.0	46.0	3.00
A0223.1	—	3.10	0.1220	18.0	49.0	3.10
A0221/8	1/8	3.18	0.1250	23.0	49.0	3.18
A0223.2	—	3.20	0.1260	18.0	49.0	3.20
A0223.25	—	3.25	0.1280	18.0	49.0	3.25
A0223.3	—	3.30	0.1299	18.0	49.0	3.30
A0223.4	—	3.40	0.1339	20.0	52.0	3.40
A0223.5	—	3.50	0.1378	20.0	52.0	3.50
A0229/64	9/64	3.57	0.1406	25.0	50.0	3.57
A0223.6	—	3.60	0.1417	20.0	52.0	3.60
A0223.7	—	3.70	0.1457	20.0	52.0	3.70



Product	DC	DC	DC	LCF	OAL	D CON MS
	(inch)	(mm)	(inch)	(mm)	(mm)	(mm)
A0223.8	–	3.80	0.1496	22.0	55.0	3.80
A0223.9	–	3.90	0.1535	22.0	55.0	3.90
A0225/32	5/32	3.97	0.1563	26.0	53.0	3.97
A0224.0	–	4.00	0.1575	22.0	55.0	4.00
A0224.1	–	4.10	0.1614	22.0	55.0	4.10
A0224.2	–	4.20	0.1654	22.0	55.0	4.20
A0224.3	–	4.30	0.1693	24.0	58.0	4.30
A02211/64	11/64	4.37	0.1719	28.0	55.0	4.37
A0224.4	–	4.40	0.1732	24.0	58.0	4.40
A0224.5	–	4.50	0.1772	24.0	58.0	4.50
A0224.6	–	4.60	0.1811	24.0	58.0	4.60
A0224.7	–	4.70	0.1850	24.0	58.0	4.70
A0223/16	3/16	4.76	0.1875	30.0	57.0	4.76
A0224.8	–	4.80	0.1890	26.0	62.0	4.80
A0224.9	–	4.90	0.1929	26.0	62.0	4.90
A0225.0	–	5.00	0.1969	26.0	62.0	5.00
A0225.1	–	5.10	0.2008	26.0	62.0	5.10
A02213/64	13/64	5.16	0.2031	31.0	58.0	5.16
A0225.2	–	5.20	0.2047	26.0	62.0	5.20
A0225.3	–	5.30	0.2087	26.0	62.0	5.30
A0225.4	–	5.40	0.2126	28.0	66.0	5.40
A0225.5	–	5.50	0.2165	28.0	66.0	5.50
A0227/32	7/32	5.56	0.2188	33.0	61.0	5.56
A0225.6	–	5.60	0.2205	28.0	66.0	5.60
A0225.7	–	5.70	0.2244	28.0	66.0	5.70
A0225.8	–	5.80	0.2283	28.0	66.0	5.80
A0225.9	–	5.90	0.2323	28.0	66.0	5.90
A02215/64	15/64	5.95	0.2344	34.0	63.0	5.95
A0226.0	–	6.00	0.2362	28.0	66.0	6.00
A0226.1	–	6.10	0.2402	31.0	70.0	6.10
A0226.2	–	6.20	0.2441	31.0	70.0	6.20
A0226.3	–	6.30	0.2480	31.0	70.0	6.30
A0221/4	1/4	6.35	0.2500	36.0	65.0	6.35
A0226.4	–	6.40	0.2520	31.0	70.0	6.40
A0226.5	–	6.50	0.2559	31.0	70.0	6.50
A0226.6	–	6.60	0.2598	31.0	70.0	6.60
A0226.7	–	6.70	0.2638	31.0	70.0	6.70
A0226.8	–	6.80	0.2677	34.0	74.0	6.80
A0226.9	–	6.90	0.2717	34.0	74.0	6.90
A0227.0	–	7.00	0.2756	34.0	74.0	7.00
A0227.1	–	7.10	0.2795	34.0	74.0	7.10
A0229/32	9/32	7.14	0.2813	40.0	70.0	7.14
A0227.2	–	7.20	0.2835	34.0	74.0	7.20
A0227.3	–	7.30	0.2874	34.0	74.0	7.30
A0227.4	–	7.40	0.2913	34.0	74.0	7.40
A0227.5	–	7.50	0.2953	34.0	74.0	7.50
A0227.6	–	7.60	0.2992	37.0	79.0	7.60
A0227.7	–	7.70	0.3031	37.0	79.0	7.70
A0227.8	–	7.80	0.3071	37.0	79.0	7.80
A0227.9	–	7.90	0.3110	37.0	79.0	7.90
A0225/16	5/16	7.94	0.3125	43.0	73.0	7.94
A0228.0	–	8.00	0.3150	37.0	79.0	8.00
A0228.1	–	8.10	0.3189	37.0	79.0	8.10
A0228.2	–	8.20	0.3228	37.0	79.0	8.20

Product	DC	DC	DC	LCF	OAL	D CON MS
	(inch)	(mm)	(inch)	(mm)	(mm)	(mm)
A0228.3	–	8.30	0.3268	37.0	79.0	8.30
A0228.4	–	8.40	0.3307	37.0	79.0	8.40
A0228.5	–	8.50	0.3346	37.0	79.0	8.50
A0228.6	–	8.60	0.3386	40.0	84.0	8.60
A0228.7	–	8.70	0.3425	40.0	84.0	8.70
A02211/32	11/32	8.73	0.3438	45.0	78.0	8.73
A0228.8	–	8.80	0.3465	40.0	84.0	8.80
A0228.9	–	8.90	0.3504	40.0	84.0	8.90
A0229.0	–	9.00	0.3543	40.0	84.0	9.00
A0229.1	–	9.10	0.3583	40.0	84.0	9.10
A0229.2	–	9.20	0.3622	40.0	84.0	9.20
A0229.3	–	9.30	0.3661	40.0	84.0	9.30
A0229.4	–	9.40	0.3701	40.0	84.0	9.40
A0229.5	–	9.50	0.3740	40.0	84.0	9.50
A0223/8	3/8	9.52	0.3750	48.0	81.0	9.52
A0229.6	–	9.60	0.3780	43.0	89.0	9.60
A0229.7	–	9.70	0.3819	43.0	89.0	9.70
A0229.8	–	9.80	0.3858	43.0	89.0	9.80
A0229.9	–	9.90	0.3898	43.0	89.0	9.90
A02210.0	–	10.00	0.3937	43.0	89.0	10.00
A02210.1	–	10.10	0.3976	43.0	89.0	10.10
A02210.2	–	10.20	0.4016	43.0	89.0	10.20
A02210.3	–	10.30	0.4055	43.0	89.0	10.30
A02213/32	13/32	10.32	0.4063	51.0	86.0	10.32
A02210.4	–	10.40	0.4094	43.0	89.0	10.40
A02210.5	–	10.50	0.4134	43.0	89.0	10.50
A02210.6	–	10.60	0.4173	43.0	89.0	10.60
A02210.7	–	10.70	0.4213	47.0	95.0	10.70
A02210.8	–	10.80	0.4252	47.0	95.0	10.80
A02210.9	–	10.90	0.4291	47.0	95.0	10.90
A02211.0	–	11.00	0.4331	47.0	95.0	11.00
A02211.1	–	11.10	0.4370	47.0	95.0	11.10
A0227/16	7/16	11.11	0.4375	54.0	89.0	11.11
A02211.2	–	11.20	0.4409	47.0	95.0	11.20
A02211.3	–	11.30	0.4449	47.0	95.0	11.30
A02211.5	–	11.50	0.4528	47.0	95.0	11.50
A02211.6	–	11.60	0.4567	47.0	95.0	11.60
A02211.7	–	11.70	0.4606	47.0	95.0	11.70
A02211.8	–	11.80	0.4646	47.0	95.0	11.80
A02211.9	–	11.90	0.4685	51.0	102.0	11.90
A02212.0	–	12.00	0.4724	51.0	102.0	12.00
A02212.1	–	12.10	0.4764	51.0	102.0	12.10
A02212.2	–	12.20	0.4803	51.0	102.0	12.20
A02212.5	–	12.50	0.4921	51.0	102.0	12.50
A0221/2	1/2	12.70	0.5000	60.0	98.0	12.70
A02213.0	–	13.00	0.5118	51.0	102.0	13.00
A02213.5	–	13.50	0.5315	54.0	107.0	13.50
A02214.0	–	14.00	0.5512	54.0	107.0	14.00
A0229/16	9/16	14.29	0.5625	67.0	105.0	14.29
A02214.5	–	14.50	0.5709	56.0	111.0	14.50
A02215.0	–	15.00	0.5906	56.0	111.0	15.00
A02215.5	–	15.50	0.6102	58.0	115.0	15.50
A0225/8	5/8	15.88	0.6250	73.0	111.0	15.88
A02216.0	–	16.00	0.6299	58.0	115.0	16.00



A620



HSS-E (5% Co) extra korte boor, bronskleurig

Boor met een tophoek van 130°, wat de zelfcentrerend bevordert en de snijkrachten vermindert. De bronzen afwerking is een dunne oxide-laag en het is een indicatie voor kobalt. Geschikt voor het boren in vele materialen. Niet geschikt voor handboormachines.

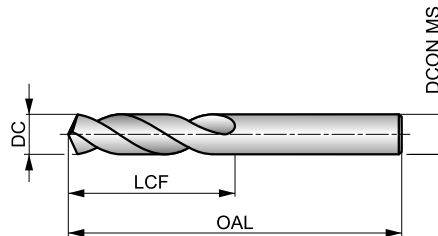

HSS-E	DIN 1897	2.5×D
130°	Bronze	
λ 20-35°	R	DC h8

De tabel geeft de geschiktheid aan voor de materiaalgroep en de startwaarden voor de snijsnelheid (m/min) en de letter verwijst naar de toe te passen voeding (fn), zie vanaf pagina 175.

P1.1 ■ 40 H	P1.2 ■ 45 H	P1.3 ■ 46 H	P2.1 ■ 34 H	P2.2 ■ 30 G	P2.3 ■ 27 F	P3.1 ■ 27 G	P3.2 ■ 21 G	P3.3 ■ 18 F	P4.1 ■ 16 G	P4.2 ■ 13 F	P4.3 ■ 11 E	M1.1 ■ 30 F	M1.2 ■ 26 F
M2.1 ■ 27 F	M2.2 ■ 22 F	M3.1 ■ 13 H	M3.2 ■ 11 H	M3.3 ■ 10 H	M4.1 ■ 15 D	K1.1 ■ 34 K	K1.2 ■ 25 F	K1.3 ■ 19 F	K2.1 ■ 27 F	K2.2 ■ 22 F	K2.3 ■ 18 F	K3.1 ■ 24 F	K3.2 ■ 18 F
K3.3 ■ 15 F	K4.1 ■ 22 F	K4.2 ■ 17 F	K4.3 ■ 12 F	K4.4 ■ 11 F	K4.5 ■ 9 F	K5.1 ■ 25 F	K5.2 ■ 19 F	K5.3 ■ 15 F	N1.1 ■ 40 K	N1.2 ■ 30 K	N1.3 ■ 20 J	N2.1 ■ 49 I	N2.2 ■ 44 I
N2.3 ■ 32 I	N3.1 ■ 68 J	N3.2 ■ 40 K	N3.3 ■ 20 I	N4.1 ■ 40 L	N4.2 ■ 32 K	N4.3 ■ 18 I	S1.1 ■ 30 G	S1.2 ■ 18 F	S1.3 ■ 10 C	S2.1 ■ 12 F	S2.2 ■ 8 C	S3.1 ■ 9 F	S3.2 ■ 6 C
S4.1 ■ 7 F	S4.2 ■ 5 C												

Product	DC	DC	LCF	OAL	DCON MS
	(mm)	(inch)			
A6202.5	2.50	0.0984	14.0	43.0	2.50
A6202.6	2.60	0.1024	14.0	43.0	2.60
A6202.7	2.70	0.1063	16.0	46.0	2.70
A6202.8	2.80	0.1102	16.0	46.0	2.80
A6202.9	2.90	0.1142	16.0	46.0	2.90
A6203.0	3.00	0.1181	16.0	46.0	3.00
A6203.1	3.10	0.1220	18.0	49.0	3.10
A6203.2	3.20	0.1260	18.0	49.0	3.20
A6203.3	3.30	0.1299	18.0	49.0	3.30
A6203.4	3.40	0.1339	20.0	52.0	3.40
A6203.5	3.50	0.1378	20.0	52.0	3.50
A6203.6	3.60	0.1417	20.0	52.0	3.60
A6203.7	3.70	0.1457	20.0	52.0	3.70
A6203.8	3.80	0.1496	22.0	55.0	3.80
A6203.9	3.90	0.1535	22.0	55.0	3.90
A6204.0	4.00	0.1575	22.0	55.0	4.00
A6204.1	4.10	0.1614	22.0	55.0	4.10
A6204.2	4.20	0.1654	22.0	55.0	4.20
A6204.3	4.30	0.1693	24.0	58.0	4.30
A6204.4	4.40	0.1732	24.0	58.0	4.40
A6204.5	4.50	0.1772	24.0	58.0	4.50
A6204.6	4.60	0.1811	24.0	58.0	4.60
A6204.7	4.70	0.1850	24.0	58.0	4.70
A6204.8	4.80	0.1890	26.0	62.0	4.80

Product	DC	DC	LCF	OAL	DCON MS
	(mm)	(inch)			
A6204.9	4.90	0.1929	26.0	62.0	4.90
A6205.0	5.00	0.1969	26.0	62.0	5.00
A6205.1	5.10	0.2008	26.0	62.0	5.10
A6205.2	5.20	0.2047	26.0	62.0	5.20
A6205.3	5.30	0.2087	26.0	62.0	5.30
A6205.4	5.40	0.2126	28.0	66.0	5.40
A6205.5	5.50	0.2165	28.0	66.0	5.50
A6205.6	5.60	0.2205	28.0	66.0	5.60
A6205.7	5.70	0.2244	28.0	66.0	5.70
A6205.8	5.80	0.2283	28.0	66.0	5.80
A6205.9	5.90	0.2323	28.0	66.0	5.90
A6206.0	6.00	0.2362	28.0	66.0	6.00
A6206.1	6.10	0.2402	31.0	70.0	6.10
A6206.2	6.20	0.2441	31.0	70.0	6.20
A6206.3	6.30	0.2480	31.0	70.0	6.30
A6206.4	6.40	0.2520	31.0	70.0	6.40
A6206.5	6.50	0.2559	31.0	70.0	6.50
A6206.6	6.60	0.2598	31.0	70.0	6.60
A6206.7	6.70	0.2638	31.0	70.0	6.70
A6206.8	6.80	0.2677	34.0	74.0	6.80
A6206.9	6.90	0.2717	34.0	74.0	6.90
A6207.0	7.00	0.2756	34.0	74.0	7.00
A6207.1	7.10	0.2795	34.0	74.0	7.10
A6207.2	7.20	0.2835	34.0	74.0	7.20



Product	DC	DC	LCF	OAL	DCON MS
	(mm)	(inch)	(mm)	(mm)	(mm)
A6207.3	7.30	0.2874	34.0	74.0	7.30
A6207.4	7.40	0.2913	34.0	74.0	7.40
A6207.5	7.50	0.2953	34.0	74.0	7.50
A6207.6	7.60	0.2992	37.0	79.0	7.60
A6207.7	7.70	0.3031	37.0	79.0	7.70
A6207.8	7.80	0.3071	37.0	79.0	7.80
A6207.9	7.90	0.3110	37.0	79.0	7.90
A6208.0	8.00	0.3150	37.0	79.0	8.00
A6208.1	8.10	0.3189	37.0	79.0	8.10
A6208.2	8.20	0.3228	37.0	79.0	8.20
A6208.3	8.30	0.3268	37.0	79.0	8.30
A6208.4	8.40	0.3307	37.0	79.0	8.40
A6208.5	8.50	0.3346	37.0	79.0	8.50
A6208.6	8.60	0.3386	40.0	84.0	8.60
A6208.7	8.70	0.3425	40.0	84.0	8.70
A6208.8	8.80	0.3465	40.0	84.0	8.80
A6208.9	8.90	0.3504	40.0	84.0	8.90
A6209.0	9.00	0.3543	40.0	84.0	9.00
A6209.1	9.10	0.3583	40.0	84.0	9.10
A6209.2	9.20	0.3622	40.0	84.0	9.20

Product	DC	DC	LCF	OAL	DCON MS
	(mm)	(inch)	(mm)	(mm)	(mm)
A6209.3	9.30	0.3661	40.0	84.0	9.30
A6209.4	9.40	0.3701	40.0	84.0	9.40
A6209.5	9.50	0.3740	40.0	84.0	9.50
A6209.6	9.60	0.3780	43.0	89.0	9.60
A6209.7	9.70	0.3819	43.0	89.0	9.70
A6209.8	9.80	0.3858	43.0	89.0	9.80
A6209.9	9.90	0.3898	43.0	89.0	9.90
A62010.0	10.00	0.3937	43.0	89.0	10.00
A62010.2	10.20	0.4016	43.0	89.0	10.20
A62010.3	10.30	0.4055	43.0	89.0	10.30
A62010.4	10.40	0.4094	43.0	89.0	10.40
A62010.5	10.50	0.4134	43.0	89.0	10.50
A62010.8	10.80	0.4252	47.0	95.0	10.80
A62011.0	11.00	0.4331	47.0	95.0	11.00
A62011.5	11.50	0.4528	47.0	95.0	11.50
A62012.0	12.00	0.4724	51.0	102.0	12.00
A62012.2	12.20	0.4803	51.0	102.0	12.20
A62012.5	12.50	0.4921	51.0	102.0	12.50
A62012.8	12.80	0.5039	51.0	102.0	12.80
A62013.0	13.00	0.5118	51.0	102.0	13.00



A117



HSS-E (8% Co), extra korte spiraalboor, DIN1897, bronskleurig

Stabiele boor aanbevolen voor moeilijk te bewerken materialen en zware omstandigheden. Een 135° splitpoint (vanaf Ø3mm) vergemakelijkt het zelfcentreren en vermindert tevens de snijkrachten. Produceert een nauwkeurig gat en een hoge kwaliteitsafwerking. De bronzen afwerking is een dunne oxide-laag en het is een indicatie voor kobalt. Onder Ø3mm 5% Co.

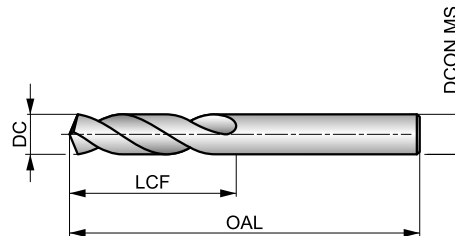

HSS-E	DIN 1897	2.5×D
135°	Bronze	
λ 20-35°	R	DC h8

De tabel geeft de geschiktheid aan voor de materiaalgroep en de startwaarden voor de snijsnelheid (m/min) en de letter verwijst naar de toe te passen voeding (fn), zie vanaf pagina 175.

P1.1 ■ 40 H	P1.2 ■ 45 H	P1.3 ■ 46 H	P2.1 ■ 34 H	P2.2 ■ 30 G	P2.3 ■ 27 F	P3.1 ■ 27 G	P3.2 ■ 21 G	P3.3 ■ 18 F	P4.1 ■ 16 G	P4.2 ■ 13 F	P4.3 ■ 11 E	M1.1 ■ 30 F	M1.2 ■ 26 F
M2.1 ■ 27 F	M2.2 ■ 22 F	M3.1 ■ 13 H	M3.2 ■ 11 H	M3.3 ■ 10 H	M4.1 ■ 15 D	K1.1 ■ 34 K	K1.2 ■ 25 F	K1.3 ■ 19 F	K2.1 ■ 27 F	K2.2 ■ 22 F	K2.3 ■ 18 F	K3.1 ■ 24 F	K3.2 ■ 18 F
K3.3 ■ 15 F	K4.1 ■ 22 F	K4.2 ■ 17 F	K4.3 ■ 12 F	K4.4 ■ 11 F	K4.5 ■ 9 F	K5.1 ■ 25 F	K5.2 ■ 19 F	K5.3 ■ 15 F	N1.1 ■ 35 K	N1.2 ■ 26 K	N1.3 ■ 18 J	N2.1 ■ 48 I	N2.2 ■ 43 I
N2.3 ■ 31 I	N3.1 ■ 68 J	N3.2 ■ 40 K	N3.3 ■ 20 I	N4.1 ■ 35 M	N4.2 ■ 28 K	N4.3 ■ 17 I	S1.1 ■ 30 G	S1.2 ■ 18 F	S1.3 ■ 10 C	S2.1 ■ 12 F	S2.2 ■ 8 C	S3.1 ■ 9 F	S3.2 ■ 6 C
S4.1 ■ 7 F	S4.2 ■ 5 C												

DC <= 1.5mm 118° tophoek; DC < 3.00mm 5% cobalt.

Product	DC (inch)	DC (mm)	DC (inch)	LCF (mm)	OAL (mm)	DCON MS (mm)
A1171.0	-	1.00	0.0394	6.0	26.0	1.00
A1171.1	-	1.10	0.0433	7.0	28.0	1.10
A1171.2	-	1.20	0.0472	8.0	30.0	1.20
A1171.3	-	1.30	0.0512	8.0	30.0	1.30
A1171.4	-	1.40	0.0551	9.0	32.0	1.40
A1171.5	-	1.50	0.0591	9.0	32.0	1.50
A1171.6	-	1.60	0.0630	10.0	34.0	1.60
A1171.7	-	1.70	0.0669	10.0	34.0	1.70
A1171.8	-	1.80	0.0709	11.0	36.0	1.80
A1171.9	-	1.90	0.0748	11.0	36.0	1.90
A1172.0	-	2.00	0.0787	12.0	38.0	2.00
A1172.1	-	2.10	0.0827	12.0	38.0	2.10
A1172.2	-	2.20	0.0866	13.0	40.0	2.20
A1172.3	-	2.30	0.0906	13.0	40.0	2.30
A1172.4	-	2.40	0.0945	14.0	43.0	2.40
A1172.5	-	2.50	0.0984	14.0	43.0	2.50
A1172.6	-	2.60	0.1024	14.0	43.0	2.60
A1172.7	-	2.70	0.1063	16.0	46.0	2.70
A1172.8	-	2.80	0.1102	16.0	46.0	2.80
A1172.9	-	2.90	0.1142	16.0	46.0	2.90
A1173.0	-	3.00	0.1181	16.0	46.0	3.00
A1173.1	-	3.10	0.1220	18.0	49.0	3.10
A1171/8	1/8	3.18	0.1250	18.0	49.0	3.18

Product	DC (inch)	DC (mm)	DC (inch)	LCF (mm)	OAL (mm)	DCON MS (mm)
A1173.2	-	3.20	0.1260	18.0	49.0	3.20
A1173.3	-	3.30	0.1299	18.0	49.0	3.30
A1173.4	-	3.40	0.1339	20.0	52.0	3.40
A1173.5	-	3.50	0.1378	20.0	52.0	3.50
A1173.6	-	3.60	0.1417	20.0	52.0	3.60
A1173.7	-	3.70	0.1457	20.0	52.0	3.70
A1173.8	-	3.80	0.1496	22.0	55.0	3.80
A1173.9	-	3.90	0.1535	22.0	55.0	3.90
A1175/32	5/32	3.97	0.1563	22.0	55.0	3.97
A1174.0	-	4.00	0.1575	22.0	55.0	4.00
A1174.1	-	4.10	0.1614	22.0	55.0	4.10
A1174.2	-	4.20	0.1654	22.0	55.0	4.20
A1174.3	-	4.30	0.1693	24.0	58.0	4.30
A1174.4	-	4.40	0.1732	24.0	58.0	4.40
A1174.5	-	4.50	0.1772	24.0	58.0	4.50
A1174.6	-	4.60	0.1811	24.0	58.0	4.60
A1174.7	-	4.70	0.1850	24.0	58.0	4.70
A1173/16	3/16	4.76	0.1875	26.0	62.0	4.76
A1174.8	-	4.80	0.1890	26.0	62.0	4.80
A1174.9	-	4.90	0.1929	26.0	62.0	4.90
A1175.0	-	5.00	0.1969	26.0	62.0	5.00
A1175.1	-	5.10	0.2008	26.0	62.0	5.10
A1175.2	-	5.20	0.2047	26.0	62.0	5.20



Product	DC	DC	DC	LCF	OAL	DCON MS
	(inch)	(mm)	(inch)	(mm)	(mm)	(mm)
A1175.3	–	5.30	0.2087	26.0	62.0	5.30
A1175.4	–	5.40	0.2126	28.0	66.0	5.40
A1175.5	–	5.50	0.2165	28.0	66.0	5.50
A1175.6	–	5.60	0.2205	28.0	66.0	5.60
A1175.7	–	5.70	0.2244	28.0	66.0	5.70
A1175.8	–	5.80	0.2283	28.0	66.0	5.80
A1175.9	–	5.90	0.2323	28.0	66.0	5.90
A1176.0	–	6.00	0.2362	28.0	66.0	6.00
A1176.1	–	6.10	0.2402	31.0	70.0	6.10
A1176.2	–	6.20	0.2441	31.0	70.0	6.20
A1176.3	–	6.30	0.2480	31.0	70.0	6.30
A1171/4	1/4	6.35	0.2500	31.0	70.0	6.35
A1176.4	–	6.40	0.2520	31.0	70.0	6.40
A1176.5	–	6.50	0.2559	31.0	70.0	6.50
A1176.6	–	6.60	0.2598	31.0	70.0	6.60
A1176.7	–	6.70	0.2638	31.0	70.0	6.70
A1176.8	–	6.80	0.2677	34.0	74.0	6.80
A1176.9	–	6.90	0.2717	34.0	74.0	6.90
A1177.0	–	7.00	0.2756	34.0	74.0	7.00
A1177.1	–	7.10	0.2795	34.0	74.0	7.10
A1177.2	–	7.20	0.2835	34.0	74.0	7.20
A1177.3	–	7.30	0.2874	34.0	74.0	7.30
A1177.4	–	7.40	0.2913	34.0	74.0	7.40
A1177.5	–	7.50	0.2953	34.0	74.0	7.50
A1177.6	–	7.60	0.2992	37.0	79.0	7.60
A1177.7	–	7.70	0.3031	37.0	79.0	7.70
A1177.8	–	7.80	0.3071	37.0	79.0	7.80
A1177.9	–	7.90	0.3110	37.0	79.0	7.90
A1175/16	5/16	7.94	0.3125	37.0	79.0	7.94

Product	DC	DC	DC	LCF	OAL	DCON MS
	(inch)	(mm)	(inch)	(mm)	(mm)	(mm)
A1178.0	–	8.00	0.3150	37.0	79.0	8.00
A1178.1	–	8.10	0.3189	37.0	79.0	8.10
A1178.2	–	8.20	0.3228	37.0	79.0	8.20
A1178.3	–	8.30	0.3268	37.0	79.0	8.30
A1178.4	–	8.40	0.3307	37.0	79.0	8.40
A1178.5	–	8.50	0.3346	37.0	79.0	8.50
A1178.6	–	8.60	0.3386	40.0	84.0	8.60
A1178.7	–	8.70	0.3425	40.0	84.0	8.70
A1178.8	–	8.80	0.3465	40.0	84.0	8.80
A1178.9	–	8.90	0.3504	40.0	84.0	8.90
A1179.0	–	9.00	0.3543	40.0	84.0	9.00
A1179.1	–	9.10	0.3583	40.0	84.0	9.10
A1179.2	–	9.20	0.3622	40.0	84.0	9.20
A1179.3	–	9.30	0.3661	40.0	84.0	9.30
A1179.4	–	9.40	0.3701	40.0	84.0	9.40
A1179.5	–	9.50	0.3740	40.0	84.0	9.50
A1173/8	3/8	9.52	0.3750	43.0	89.0	9.52
A1179.6	–	9.60	0.3780	43.0	89.0	9.60
A1179.7	–	9.70	0.3819	43.0	89.0	9.70
A1179.8	–	9.80	0.3858	43.0	89.0	9.80
A1179.9	–	9.90	0.3898	43.0	89.0	9.90
A11710.0	–	10.00	0.3937	43.0	89.0	10.00
A11710.2	–	10.20	0.4016	43.0	89.0	10.20
A11710.5	–	10.50	0.4134	43.0	89.0	10.50
A11711.0	–	11.00	0.4331	47.0	95.0	11.00
A11711.5	–	11.50	0.4528	47.0	95.0	11.50
A11712.0	–	12.00	0.4724	51.0	102.0	12.00
A1171/2	1/2	12.70	0.5000	51.0	102.0	12.70
A11713.0	–	13.00	0.5118	51.0	102.0	13.00



A520



ADX HSS extra korte productieboor, DIN1897, TiN gecoat

Hoogproductieve spiraalboor voor het boren van nauwkeurige gaten (H9) bij hoge verspaningscondities. Met 130° tophoek en uitgedunde ziel zelfcentrerend. In te zetten op stationaire machines met instelbare constante voeding. TiN coating verbetert de prestaties en verlengt de standtijd. Geschikt voor vele materialen.



ADX

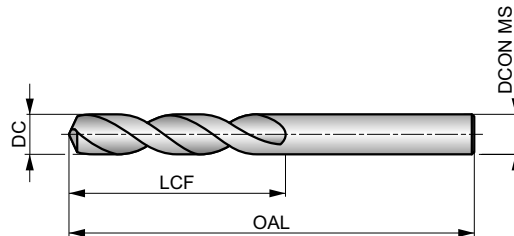

HSS	DIN 1897	2.5×D
130°	TiN	
λ 32-40°	R	DC h8

De tabel geeft de geschiktheid aan voor de materiaalgroep en de startwaarden voor de snijsnelheid (m/min) en de letter verwijst naar de toe te passen voeding (fn), zie vanaf pagina 175.

P1.1 ■ 53 M	P1.2 ■ 59 M	P1.3 ■ 61 M	P2.1 ■ 45 M	P2.2 ■ 40 K	P2.3 ■ 35 G	P3.1 ■ 31 I	P3.2 ■ 25 I	P3.3 ■ 21 G	P4.1 ■ 19 I	P4.2 ■ 16 G	P4.3 ■ 13 E	M1.1 ■ 41 I	M1.2 ■ 35 I
M2.1 ■ 37 I	M2.2 ■ 30 I	M3.1 ■ 19 I	M3.2 ■ 16 I	M3.3 ■ 14 I	M4.1 ■ 20 G	K1.1 ■ 48 M	K1.2 ■ 36 K	K1.3 ■ 27 K	K2.1 ■ 37 J	K2.2 ■ 30 J	K2.3 ■ 24 F	K3.1 ■ 33 J	K3.2 ■ 25 J
K3.3 ■ 20 F	K4.1 ■ 30 J	K4.2 ■ 23 J	K4.3 ■ 17 F	K4.4 ■ 14 F	K4.5 ■ 12 F	K5.1 ■ 34 J	K5.2 ■ 26 J	K5.3 ■ 20 F	N1.1 ■ 55 I	N1.2 ■ 41 I	N1.3 ■ 28 M	N2.1 ■ 57 K	N2.2 ■ 51 K
N2.3 ■ 37 K	N3.1 ■ 85 K	N3.2 ■ 50 I	N3.3 ■ 25 E	N4.1 ■ 65 G	N4.2 ■ 50 G	N4.3 ■ 35 F	S1.1 ■ 34 I	S1.2 ■ 20 G	S1.3 ■ 4 B	S2.1 ■ 15 G	S2.2 ■ 10 E	S3.1 ■ 11 G	S3.2 ■ 7 E
S4.1 ■ 9 G	S4.2 ■ 6 E												

Product	DC (inch)	DC (mm)	DC (inch)	LCF (mm)	OAL (mm)	DCON MS (mm)
A5203.0	–	3.00	0.1181	16.0	46.0	3.00
A5203.1	–	3.10	0.1220	18.0	49.0	3.10
A5201/8	1/8	3.18	0.1250	18.0	49.0	3.18
A5203.2	–	3.20	0.1260	18.0	49.0	3.20
A5203.3	–	3.30	0.1299	18.0	49.0	3.30
A5203.4	–	3.40	0.1339	20.0	52.0	3.40
A5203.5	–	3.50	0.1378	20.0	52.0	3.50
A5209/64	9/64	3.57	0.1406	20.0	52.0	3.57
A5203.6	–	3.60	0.1417	20.0	52.0	3.60
A5203.7	–	3.70	0.1457	20.0	52.0	3.70
A5203.8	–	3.80	0.1496	22.0	55.0	3.80
A5203.9	–	3.90	0.1535	22.0	55.0	3.90
A5205/32	5/32	3.97	0.1563	22.0	55.0	3.97
A5204.0	–	4.00	0.1575	22.0	55.0	4.00
A5204.1	–	4.10	0.1614	22.0	55.0	4.10
A5204.2	–	4.20	0.1654	22.0	55.0	4.20
A5204.3	–	4.30	0.1693	24.0	58.0	4.30
A52011/64	11/64	4.37	0.1719	24.0	58.0	4.37
A5204.4	–	4.40	0.1732	24.0	58.0	4.40
A5204.5	–	4.50	0.1772	24.0	58.0	4.50
A5204.6	–	4.60	0.1811	24.0	58.0	4.60
A5204.7	–	4.70	0.1850	24.0	58.0	4.70
A5203/16	3/16	4.76	0.1875	26.0	62.0	4.76
A5204.8	–	4.80	0.1890	26.0	62.0	4.80

Product	DC (inch)	DC (mm)	DC (inch)	LCF (mm)	OAL (mm)	DCON MS (mm)
A5204.9	–	4.90	0.1929	26.0	62.0	4.90
A5205.0	–	5.00	0.1969	26.0	62.0	5.00
A5205.1	–	5.10	0.2008	26.0	62.0	5.10
A52013/64	13/64	5.16	0.2031	26.0	62.0	5.16
A5205.2	–	5.20	0.2047	26.0	62.0	5.20
A5205.3	–	5.30	0.2087	26.0	62.0	5.30
A5205.4	–	5.40	0.2126	28.0	66.0	5.40
A5205.5	–	5.50	0.2165	28.0	66.0	5.50
A5207/32	7/32	5.56	0.2188	28.0	66.0	5.56
A5205.6	–	5.60	0.2205	28.0	66.0	5.60
A5205.7	–	5.70	0.2244	28.0	66.0	5.70
A5205.8	–	5.80	0.2283	28.0	66.0	5.80
A5205.9	–	5.90	0.2323	28.0	66.0	5.90
A52015/64	15/64	5.95	0.2344	28.0	66.0	5.95
A5206.0	–	6.00	0.2362	28.0	66.0	6.00
A5206.1	–	6.10	0.2402	31.0	70.0	6.10
A5206.2	–	6.20	0.2441	31.0	70.0	6.20
A5206.3	–	6.30	0.2480	31.0	70.0	6.30
A5201/4	1/4	6.35	0.2500	31.0	70.0	6.35
A5206.4	–	6.40	0.2520	31.0	70.0	6.40
A5206.5	–	6.50	0.2559	31.0	70.0	6.50
A5206.6	–	6.60	0.2598	31.0	70.0	6.60
A5206.7	–	6.70	0.2638	31.0	70.0	6.70
A52017/64	17/64	6.75	0.2656	34.0	74.0	6.75



Product	DC	DC	DC	LCF	OAL	D CON MS
	(inch)	(mm)	(inch)	(mm)	(mm)	(mm)
A5206.8	–	6.80	0.2677	34.0	74.0	6.80
A5206.9	–	6.90	0.2717	34.0	74.0	6.90
A5207.0	–	7.00	0.2756	34.0	74.0	7.00
A5207.1	–	7.10	0.2795	34.0	74.0	7.10
A5209/32	9/32	7.14	0.2813	34.0	74.0	7.14
A5207.2	–	7.20	0.2835	34.0	74.0	7.20
A5207.3	–	7.30	0.2874	34.0	74.0	7.30
A5207.4	–	7.40	0.2913	34.0	74.0	7.40
A5207.5	–	7.50	0.2953	34.0	74.0	7.50
A52019/64	19/64	7.54	0.2969	37.0	79.0	7.54
A5207.6	–	7.60	0.2992	37.0	79.0	7.60
A5207.7	–	7.70	0.3031	37.0	79.0	7.70
A5207.8	–	7.80	0.3071	37.0	79.0	7.80
A5207.9	–	7.90	0.3110	37.0	79.0	7.90
A5205/16	5/16	7.94	0.3125	37.0	79.0	7.94
A5208.0	–	8.00	0.3150	37.0	79.0	8.00
A5208.1	–	8.10	0.3189	37.0	79.0	8.10
A5208.2	–	8.20	0.3228	37.0	79.0	8.20
A5208.3	–	8.30	0.3268	37.0	79.0	8.30
A52021/64	21/64	8.33	0.3281	37.0	79.0	8.33
A5208.4	–	8.40	0.3307	37.0	79.0	8.40
A5208.5	–	8.50	0.3346	37.0	79.0	8.50
A5208.6	–	8.60	0.3386	40.0	84.0	8.60
A5208.7	–	8.70	0.3425	40.0	84.0	8.70
A52011/32	11/32	8.73	0.3438	40.0	84.0	8.73
A5208.8	–	8.80	0.3465	40.0	84.0	8.80
A5208.9	–	8.90	0.3504	40.0	84.0	8.90
A5209.0	–	9.00	0.3543	40.0	84.0	9.00
A5209.1	–	9.10	0.3583	40.0	84.0	9.10
A52023/64	23/64	9.13	0.3594	40.0	84.0	9.13
A5209.2	–	9.20	0.3622	40.0	84.0	9.20
A5209.3	–	9.30	0.3661	40.0	84.0	9.30
A5209.4	–	9.40	0.3701	40.0	84.0	9.40
A5209.5	–	9.50	0.3740	40.0	84.0	9.50
A5203/8	3/8	9.52	0.3750	43.0	89.0	9.52
A5209.6	–	9.60	0.3780	43.0	89.0	9.60
A5209.7	–	9.70	0.3819	43.0	89.0	9.70
A5209.8	–	9.80	0.3858	43.0	89.0	9.80
A5209.9	–	9.90	0.3898	43.0	89.0	9.90

Product	DC	DC	DC	LCF	OAL	D CON MS
	(inch)	(mm)	(inch)	(mm)	(mm)	(mm)
A52025/64	25/64	9.92	0.3906	43.0	89.0	9.92
A52010.0	–	10.00	0.3937	43.0	89.0	10.00
A52010.1	–	10.10	0.3976	43.0	89.0	10.10
A52010.2	–	10.20	0.4016	43.0	89.0	10.20
A52010.3	–	10.30	0.4055	43.0	89.0	10.30
A52013/32	13/32	10.32	0.4063	43.0	89.0	10.32
A52010.4	–	10.40	0.4094	43.0	89.0	10.40
A52010.5	–	10.50	0.4134	43.0	89.0	10.50
A52010.6	–	10.60	0.4173	43.0	89.0	10.60
A52010.7	–	10.70	0.4213	47.0	95.0	10.70
A52027/64	27/64	10.72	0.4219	47.0	95.0	10.72
A52010.8	–	10.80	0.4252	47.0	95.0	10.80
A52010.9	–	10.90	0.4291	47.0	95.0	10.90
A52011.0	–	11.00	0.4331	47.0	95.0	11.00
A52011.1	–	11.10	0.4370	47.0	95.0	11.10
A5207/16	7/16	11.11	0.4375	47.0	95.0	11.11
A52011.2	–	11.20	0.4409	47.0	95.0	11.20
A52011.3	–	11.30	0.4449	47.0	95.0	11.30
A52011.4	–	11.40	0.4488	47.0	95.0	11.40
A52011.5	–	11.50	0.4528	47.0	95.0	11.50
A52029/64	29/64	11.51	0.4531	47.0	95.0	11.51
A52011.6	–	11.60	0.4567	47.0	95.0	11.60
A52011.7	–	11.70	0.4606	47.0	95.0	11.70
A52011.8	–	11.80	0.4646	47.0	95.0	11.80
A52011.9	–	11.90	0.4685	51.0	102.0	11.90
A52015/32	15/32	11.91	0.4688	51.0	102.0	11.91
A52012.0	–	12.00	0.4724	51.0	102.0	12.00
A52012.1	–	12.10	0.4764	51.0	102.0	12.10
A52012.2	–	12.20	0.4803	51.0	102.0	12.20
A52012.3	–	12.30	0.4843	51.0	102.0	12.30
A52031/64	31/64	12.30	0.4844	51.0	102.0	12.30
A52012.4	–	12.40	0.4882	51.0	102.0	12.40
A52012.5	–	12.50	0.4921	51.0	102.0	12.50
A52012.6	–	12.60	0.4961	51.0	102.0	12.60
A52012.7	–	12.70	0.5000	51.0	102.0	12.70
A5201/2	1/2	12.70	0.5000	51.0	102.0	12.70
A52012.8	–	12.80	0.5039	51.0	102.0	12.80
A52012.9	–	12.90	0.5079	51.0	102.0	12.90
A52013.0	–	13.00	0.5118	51.0	102.0	13.00



A124



HSS extra korte boor, HM gesoldeerde punt

De gesoldeerde hardmetalen punt geeft de hoge prestaties van een hardmetalen boor met een stabiel en minder bros HSS lichaam. Een 118°, 4-vlaks punt, helpt de zelfcentering waardoor het een economische keuze is. Kan gebruikt worden in zowel conventionele als CNC machines. De stoomontlaten afwerking houdt de snijvloeistof vast.

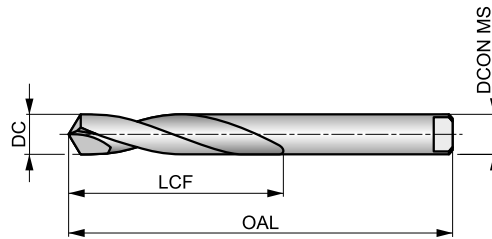

HSS HM	DIN 8037	2.5×D
118°	Bright ST	
λ 10-20°	R	

De tabel geeft de geschiktheid aan voor de materiaalgroep en de startwaarden voor de snijnsnelheid (m/min) en de letter verwijst naar de toe te passen voeding (fn), zie vanaf pagina 175.

P2.3 ■ 40 C	P3.3 ■ 40 C	P4.2 ■ 30 C	P4.3 ■ 24 A	M3.1 ■ 41 C	M3.2 ■ 35 C	M3.3 ■ 32 C	M4.1 ■ 35 C	K1.1 ■ 55 C	K1.2 ■ 41 C	K1.3 ■ 31 C	K2.1 ■ 49 C	K2.2 ■ 40 C	K2.3 ■ 32 A
K3.1 ■ 44 C	K3.2 ■ 33 C	K3.3 ■ 27 A	K4.1 ■ 40 C	K4.2 ■ 30 C	K4.3 ■ 22 A	K4.4 ■ 19 A	K4.5 ■ 16 A	K5.1 ■ 46 C	K5.2 ■ 34 C	K5.3 ■ 27 A	N3.1 ■ 119 E	N3.2 ■ 170 G	N4.2 ■ 60 E
S1.1 ■ 40 A	S1.2 ■ 35 A	S1.3 ■ 25 A	S2.1 ■ 33 A	S2.2 ■ 28 A	S3.1 ■ 25 A	S3.2 ■ 20 A	S4.1 ■ 20 A	S4.2 ■ 16 A					

Met meeneemlip volgens DIN 1809.

Product	DC	DC	LCF	OAL	DCON MS
	(mm)	(inch)			
A1243.0	3.00	0.1181	20.0	50.0	3.00
A1243.2	3.20	0.1260	25.0	56.0	3.20
A1243.5	3.50	0.1378	25.0	56.0	3.50
A1244.0	4.00	0.1575	25.0	56.0	4.00
A1244.2	4.20	0.1654	28.0	63.0	4.20
A1244.5	4.50	0.1772	28.0	63.0	4.50
A1244.8	4.80	0.1890	28.0	63.0	4.80
A1245.0	5.00	0.1969	28.0	63.0	5.00
A1245.2	5.20	0.2047	32.0	71.0	5.20
A1245.5	5.50	0.2165	32.0	71.0	5.50
A1245.8	5.80	0.2283	32.0	71.0	5.80
A1246.0	6.00	0.2362	32.0	71.0	6.00
A1246.5	6.50	0.2559	32.0	71.0	6.50
A1246.8	6.80	0.2677	40.0	80.0	6.80
A1247.0	7.00	0.2756	40.0	80.0	7.00

Product	DC	DC	LCF	OAL	DCON MS
	(mm)	(inch)			
A1247.5	7.50	0.2953	40.0	80.0	7.50
A1248.0	8.00	0.3150	40.0	80.0	8.00
A1248.5	8.50	0.3346	50.0	90.0	8.50
A1249.0	9.00	0.3543	50.0	90.0	9.00
A1249.5	9.50	0.3740	50.0	90.0	9.50
A12410.0	10.00	0.3937	56.0	100.0	10.00
A12410.5	10.50	0.4134	56.0	100.0	10.50
A12411.0	11.00	0.4331	56.0	100.0	11.00
A12411.5	11.50	0.4528	63.0	112.0	11.50
A12412.0	12.00	0.4724	63.0	112.0	12.00
A12413.0	13.00	0.5118	63.0	112.0	13.00
A12414.0	14.00	0.5512	71.0	125.0	14.00
A12415.0	15.00	0.5906	71.0	125.0	15.00
A12416.0	16.00	0.6299	80.0	140.0	16.00



A720



HSS-E (5% Co) micro boor

Microboren in zeer kleine diameters van 0,15 mm t/m 1,40 mm. Om het opnemen te vergemakkelijken, hebben alle boren een schachtdiameter van 1,00 mm of 1,50 mm. Met een 4-vlaks punt van 118°, wat de zelfcentering verbetert en de snijkrachten vermindert.

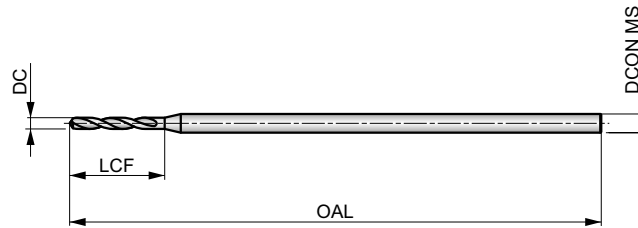

HSS-E	DIN 1899	2.5×D
118°	Bright	
λ 20-35°	R	

De tabel geeft de geschiktheid aan voor de materiaalgroep en de startwaarden voor de snijsnelheid (m/min) en de letter verwijst naar de toe te passen voeding (fn), zie vanaf pagina 175.

P1.1 ■ 36 A	P1.2 ■ 40 A	P1.3 ■ 41 A	P2.1 ■ 31 A	P2.2 ■ 27 A	P2.3 ■ 24 A	P3.1 ■ 25 A	P3.2 ■ 20 A	P3.3 ■ 17 A	P4.1 ■ 15 A	P4.2 ■ 13 A	P4.3 ■ 10 A	M1.1 ■ 30 A	M1.2 ■ 26 A
M2.1 ■ 27 A	M2.2 ■ 22 A	M3.1 ■ 12 A	M3.2 ■ 10 A	M3.3 ■ 9 A	M4.1 ■ 15 A	K1.1 ■ 30 A	K1.2 ■ 22 A	K1.3 ■ 17 A	K2.1 ■ 25 A	K2.2 ■ 20 A	K2.3 ■ 16 A	K3.1 ■ 22 A	K3.2 ■ 17 A
K3.3 ■ 13 A	K4.1 ■ 20 A	K4.2 ■ 15 A	K4.3 ■ 11 A	K4.4 ■ 10 A	K4.5 ■ 8 A	K5.1 ■ 23 A	K5.2 ■ 17 A	K5.3 ■ 13 A	N1.1 ■ 35 A	N1.2 ■ 26 A	N1.3 ■ 18 A	N2.1 ■ 42 A	N2.2 ■ 37 A
N2.3 ■ 27 A	N3.1 ■ 68 A	N3.2 ■ 40 A	N3.3 ■ 20 A	N4.1 ■ 48 A	N4.2 ■ 25 A	S1.1 ■ 23 A	S1.2 ■ 17 A	S1.3 ■ 8 A	S2.1 ■ 9 A	S2.2 ■ 6 A	S3.1 ■ 7 A	S3.2 ■ 4 A	S4.1 ■ 5 A
S4.2 ■ 3 A													

Product	DC (mm)	DC (inch)	LCF (mm)	OAL (mm)	DCON MS (mm)
A720.15	0.15	0.0059	1.0	25.0	1.00
A720.16	0.16	0.0063	1.4	25.0	1.00
A720.17	0.17	0.0067	1.4	25.0	1.00
A720.18	0.18	0.0070	1.4	25.0	1.00
A720.2	0.20	0.0079	1.8	25.0	1.00
A720.22	0.22	0.0087	1.8	25.0	1.00
A720.25	0.25	0.0098	2.2	25.0	1.00
A720.27	0.27	0.0106	2.2	25.0	1.00
A720.28	0.28	0.0110	2.2	25.0	1.00
A720.3	0.30	0.0118	2.2	25.0	1.00
A720.35	0.35	0.0138	2.8	25.0	1.00
A720.38	0.38	0.0150	2.8	25.0	1.00
A720.39	0.39	0.0154	3.6	25.0	1.00
A720.4	0.40	0.0157	3.6	25.0	1.00
A720.45	0.45	0.0177	3.6	25.0	1.00
A720.5	0.50	0.0197	4.0	25.0	1.00

Product	DC (mm)	DC (inch)	LCF (mm)	OAL (mm)	DCON MS (mm)
A720.55	0.55	0.0217	4.5	25.0	1.00
A720.6	0.60	0.0236	4.5	25.0	1.00
A720.62	0.62	0.0244	5.0	25.0	1.00
A720.65	0.65	0.0256	5.0	25.0	1.00
A720.7	0.70	0.0276	5.6	25.0	1.00
A720.75	0.75	0.0295	5.6	25.0	1.00
A720.8	0.80	0.0315	6.3	25.0	1.50
A720.85	0.85	0.0335	6.3	25.0	1.50
A720.9	0.90	0.0354	7.1	25.0	1.50
A720.95	0.95	0.0374	7.1	25.0	1.50
A7201.0	1.00	0.0394	8.0	25.0	1.50
A7201.05	1.05	0.0413	8.0	25.0	1.50
A7201.1	1.10	0.0433	9.0	25.0	1.50
A7201.2	1.20	0.0472	10.0	25.0	1.50
A7201.3	1.30	0.0512	10.0	25.0	1.50
A7201.4	1.40	0.0551	11.2	25.0	1.50



A920



PFX HSS-E (5% Co) extra korte productieboor, DIN1897

Hoogproductieve spiraalboor voor het boren van gaten van hoge kwaliteit en nauwkeurigheid bij hoge snelheden en voedingen (H10). Zelfcenterende 130° tophoek en speciale parabolische spaangroefvorm helpen in samenwerking met de unieke snijkantsgeometrie om spanen zo te vormen dat ze makkelijk zijn af te voeren. Daardoor is het mogelijk diepe gaten te boren in één arbeidsgang. Geschikt voor vele materialen.

PFX

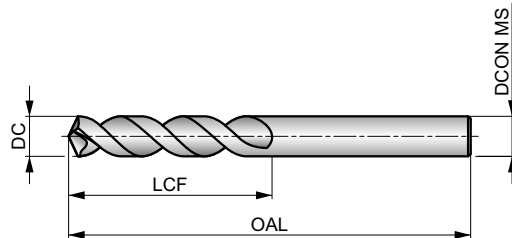

HSS-E	DIN ANSI	3xD
130°	Bright	
λ > 35°	R	DC h8

De tabel geeft de geschiktheid aan voor de materiaalgroep en de startwaarden voor de snijsnelheid (m/min) en de letter verwijst naar de toe te passen voeding (fn), zie vanaf pagina 175.

P1.1 ■ 42 J	P1.2 ■ 47 J	P1.3 ■ 49 J	P2.1 ■ 36 J	P2.2 ■ 32 I	P2.3 ■ 28 E	P3.1 ■ 34 I	P3.2 ■ 27 I	P3.3 ■ 23 E	P4.1 ■ 20 I	P4.2 ■ 17 E	P4.3 ■ 14 E	M1.1 ■ 21 F	M1.2 ■ 17 F
M2.1 ■ 18 F	M2.2 ■ 15 F	M3.1 ■ 8 F	M3.2 ■ 7 F	M3.3 ■ 6 F	M4.1 ■ 9 D	K1.1 ■ 34 L	K1.2 ■ 25 L	K1.3 ■ 19 L	K2.1 ■ 32 L	K2.2 ■ 26 L	K2.3 ■ 21 J	K3.1 ■ 28 L	K3.2 ■ 22 L
K3.3 ■ 17 J	K4.1 ■ 26 L	K4.2 ■ 20 L	K4.3 ■ 14 J	K4.4 ■ 12 J	K4.5 ■ 10 J	K5.1 ■ 30 L	K5.2 ■ 22 L	K5.3 ■ 17 J	N1.1 ■ 75 L	N1.2 ■ 56 L	N1.3 ■ 38 N	N2.1 ■ 62 N	N2.2 ■ 55 N
N2.3 ■ 40 N	N3.1 ■ 112 J	N3.2 ■ 66 J	N3.3 ■ 33 H	N4.1 ■ 55 J	N4.2 ■ 40 H	S1.1 ■ 30 G	S1.2 ■ 18 G	S1.3 ■ 10 C	S2.1 ■ 12 G	S2.2 ■ 8 E	S3.1 ■ 9 G	S3.2 ■ 6 E	S4.1 ■ 7 G
S4.2 ■ 5 E													

Product	DC (inch)	DC (mm)	DC (inch)	LCF (mm)	OAL (mm)	DCON MS (mm)
A9201.0	–	1.00	0.0394	6.0	26.0	1.00
A9201.1	–	1.10	0.0433	7.0	28.0	1.10
A9203/64	3/64	1.19	0.0469	13.0	35.0	1.19
A9201.2	–	1.20	0.0472	8.0	30.0	1.20
A9201.25	–	1.25	0.0492	8.0	30.0	1.25
A9201.3	–	1.30	0.0512	8.0	30.0	1.30
A9201.35	–	1.35	0.0531	9.0	32.0	1.35
A9201.4	–	1.40	0.0551	9.0	32.0	1.40
A9201.5	–	1.50	0.0591	9.0	32.0	1.50
A9201.55	–	1.55	0.0610	10.0	34.0	1.55
A9201/16	1/16	1.59	0.0625	16.0	41.0	1.59
A9201.6	–	1.60	0.0630	10.0	34.0	1.60
A9201.7	–	1.70	0.0669	10.0	34.0	1.70
A9201.75	–	1.75	0.0689	11.0	36.0	1.75
A9201.8	–	1.80	0.0709	11.0	36.0	1.80
A9201.9	–	1.90	0.0748	11.0	36.0	1.90
A9205/64	5/64	1.98	0.0781	17.0	43.0	1.98
A9202.0	–	2.00	0.0787	12.0	38.0	2.00
A9202.1	–	2.10	0.0827	12.0	38.0	2.10
A9202.15	–	2.15	0.0846	13.0	40.0	2.15
A9202.2	–	2.20	0.0866	13.0	40.0	2.20
A9202.3	–	2.30	0.0906	13.0	40.0	2.30
A9202.35	–	2.35	0.0925	14.0	43.0	2.35
A9203/32	3/32	2.38	0.0938	19.0	41.0	2.38

Product	DC (inch)	DC (mm)	DC (inch)	LCF (mm)	OAL (mm)	DCON MS (mm)
A9202.4	–	2.40	0.0945	14.0	43.0	2.40
A9202.5	–	2.50	0.0984	14.0	43.0	2.50
A9202.6	–	2.60	0.1024	14.0	43.0	2.60
A9202.7	–	2.70	0.1063	16.0	46.0	2.70
A9207/64	7/64	2.78	0.1094	21.0	46.0	2.78
A9202.8	–	2.80	0.1102	16.0	46.0	2.80
A9202.9	–	2.90	0.1142	16.0	46.0	2.90
A9203.0	–	3.00	0.1181	16.0	46.0	3.00
A9203.1	–	3.10	0.1220	18.0	49.0	3.10
A9201/8	1/8	3.18	0.1250	22.0	48.0	3.18
A9203.2	–	3.20	0.1260	18.0	49.0	3.20
A9203.3	–	3.30	0.1299	18.0	49.0	3.30
A9203.4	–	3.40	0.1339	20.0	52.0	3.40
A9203.5	–	3.50	0.1378	20.0	52.0	3.50
A9209/64	9/64	3.57	0.1406	24.0	49.0	3.57
A9203.6	–	3.60	0.1417	20.0	52.0	3.60
A9203.7	–	3.70	0.1457	20.0	52.0	3.70
A9203.8	–	3.80	0.1496	22.0	55.0	3.80
A9203.9	–	3.90	0.1535	22.0	55.0	3.90
A9205/32	5/32	3.97	0.1563	25.0	52.0	3.97
A9204.0	–	4.00	0.1575	22.0	55.0	4.00
A9204.1	–	4.10	0.1614	22.0	55.0	4.10
A9204.2	–	4.20	0.1654	22.0	55.0	4.20
A9204.3	–	4.30	0.1693	24.0	58.0	4.30



Product	DC	DC	DC	LCF	OAL	D CON MS
	(inch)	(mm)	(inch)	(mm)	(mm)	(mm)
A92011/64	11/64	4.37	0.1719	27.0	54.0	4.37
A9204.4	–	4.40	0.1732	24.0	58.0	4.40
A9204.5	–	4.50	0.1772	24.0	58.0	4.50
A9204.6	–	4.60	0.1811	24.0	58.0	4.60
A9204.7	–	4.70	0.1850	24.0	58.0	4.70
A9203/16	3/16	4.76	0.1875	29.0	56.0	4.76
A9204.8	–	4.80	0.1890	26.0	62.0	4.80
A9204.9	–	4.90	0.1929	26.0	62.0	4.90
A9205.0	–	5.00	0.1969	26.0	62.0	5.00
A9205.1	–	5.10	0.2008	26.0	62.0	5.10
A92013/64	13/64	5.16	0.2031	30.0	57.0	5.16
A9205.2	–	5.20	0.2047	26.0	62.0	5.20
A9205.3	–	5.30	0.2087	26.0	62.0	5.30
A9205.4	–	5.40	0.2126	28.0	66.0	5.40
A9205.5	–	5.50	0.2165	28.0	66.0	5.50
A9207/32	7/32	5.56	0.2188	32.0	60.0	5.56
A9205.6	–	5.60	0.2205	28.0	66.0	5.60
A9205.7	–	5.70	0.2244	28.0	66.0	5.70
A9205.8	–	5.80	0.2283	28.0	66.0	5.80
A9205.9	–	5.90	0.2323	28.0	66.0	5.90
A92015/64	15/64	5.95	0.2344	33.0	62.0	5.95
A9206.0	–	6.00	0.2362	28.0	66.0	6.00
A9206.1	–	6.10	0.2402	31.0	70.0	6.10
A9206.2	–	6.20	0.2441	31.0	70.0	6.20
A9206.3	–	6.30	0.2480	31.0	70.0	6.30
A9201/4	1/4	6.35	0.2500	35.0	64.0	6.35
A9206.4	–	6.40	0.2520	31.0	70.0	6.40
A9206.5	–	6.50	0.2559	31.0	70.0	6.50
A9206.6	–	6.60	0.2598	31.0	70.0	6.60
A9206.7	–	6.70	0.2638	31.0	70.0	6.70
A92017/64	17/64	6.75	0.2656	37.0	67.0	6.75
A9206.8	–	6.80	0.2677	34.0	74.0	6.80
A9206.9	–	6.90	0.2717	34.0	74.0	6.90
A9207.0	–	7.00	0.2756	34.0	74.0	7.00
A9207.1	–	7.10	0.2795	34.0	74.0	7.10
A9209/32	9/32	7.14	0.2813	38.0	68.0	7.14
A9207.2	–	7.20	0.2835	34.0	74.0	7.20
A9207.3	–	7.30	0.2874	34.0	74.0	7.30
A9207.4	–	7.40	0.2913	34.0	74.0	7.40
A9207.5	–	7.50	0.2953	34.0	74.0	7.50
A92019/64	19/64	7.54	0.2969	40.0	70.0	7.54
A9207.6	–	7.60	0.2992	37.0	79.0	7.60
A9207.7	–	7.70	0.3031	37.0	79.0	7.70
A9207.8	–	7.80	0.3071	37.0	79.0	7.80
A9207.9	–	7.90	0.3110	37.0	79.0	7.90
A9205/16	5/16	7.94	0.3125	41.0	71.0	7.94
A9208.0	–	8.00	0.3150	37.0	79.0	8.00
A9208.1	–	8.10	0.3189	37.0	79.0	8.10
A9208.2	–	8.20	0.3228	37.0	79.0	8.20
A9208.3	–	8.30	0.3268	37.0	79.0	8.30
A92021/64	21/64	8.33	0.3281	43.0	75.0	8.33
A9208.4	–	8.40	0.3307	37.0	79.0	8.40
A9208.5	–	8.50	0.3346	37.0	79.0	8.50
A9208.6	–	8.60	0.3386	40.0	84.0	8.60
A9208.7	–	8.70	0.3425	40.0	84.0	8.70
A92011/32	11/32	8.73	0.3438	43.0	76.0	8.73
A9208.8	–	8.80	0.3465	40.0	84.0	8.80
A9208.9	–	8.90	0.3504	40.0	84.0	8.90
A9209.0	–	9.00	0.3543	40.0	84.0	9.00
A9209.1	–	9.10	0.3583	40.0	84.0	9.10
A92023/64	23/64	9.13	0.3594	44.0	78.0	9.13
A9209.2	–	9.20	0.3622	40.0	84.0	9.20

Product	DC	DC	DC	LCF	OAL	D CON MS
	(inch)	(mm)	(inch)	(mm)	(mm)	(mm)
A9209.3	–	9.30	0.3661	40.0	84.0	9.30
A9209.4	–	9.40	0.3701	40.0	84.0	9.40
A9209.5	–	9.50	0.3740	40.0	84.0	9.50
A9203/8	3/8	9.52	0.3750	46.0	79.0	9.52
A9209.6	–	9.60	0.3780	43.0	89.0	9.60
A9209.7	–	9.70	0.3819	43.0	89.0	9.70
A9209.8	–	9.80	0.3858	43.0	89.0	9.80
A9209.9	–	9.90	0.3898	43.0	89.0	9.90
A92025/64	25/64	9.92	0.3906	48.0	83.0	9.92
A92010.0	–	10.00	0.3937	43.0	89.0	10.00
A92010.2	–	10.20	0.4016	43.0	89.0	10.20
A92010.3	–	10.30	0.4055	43.0	89.0	10.30
A92013/32	13/32	10.32	0.4063	49.0	84.0	10.32
A92010.5	–	10.50	0.4134	43.0	89.0	10.50
A92027/64	27/64	10.72	0.4219	51.0	86.0	10.72
A92010.8	–	10.80	0.4252	47.0	95.0	10.80
A92011.0	–	11.00	0.4331	47.0	95.0	11.00
A9207/16	7/16	11.11	0.4375	52.0	87.0	11.11
A92011.5	–	11.50	0.4528	47.0	95.0	11.50
A92029/64	29/64	11.51	0.4531	54.0	90.0	11.51
A92011.8	–	11.80	0.4646	47.0	95.0	11.80
A92015/32	15/32	11.91	0.4688	54.0	92.0	11.91
A92012.0	–	12.00	0.4724	51.0	102.0	12.00
A92012.2	–	12.20	0.4803	51.0	102.0	12.20
A92031/64	31/64	12.30	0.4844	56.0	94.0	12.30
A92012.5	–	12.50	0.4921	51.0	102.0	12.50
A9201/2	1/2	12.70	0.5000	57.0	95.0	12.70
A92013.0	–	13.00	0.5118	51.0	102.0	13.00
A92033/64	33/64	13.10	0.5156	60.0	98.0	13.10
A92013.5	–	13.50	0.5315	54.0	107.0	13.50
A92035/64	35/64	13.89	0.5469	64.0	102.0	13.89
A92014.0	–	14.00	0.5512	54.0	107.0	14.00
A9209/16	9/16	14.29	0.5625	64.0	102.0	14.29
A92014.5	–	14.50	0.5709	56.0	111.0	14.50
A92037/64	37/64	14.68	0.5781	67.0	105.0	14.68
A92014.75	–	14.75	0.5807	56.0	111.0	14.75
A92015.0	–	15.00	0.5906	56.0	111.0	15.00
A92019/32	19/32	15.08	0.5938	67.0	105.0	15.08
A92039/64	39/64	15.48	0.6094	70.0	108.0	15.48
A92015.5	–	15.50	0.6102	58.0	115.0	15.50
A9205/8	5/8	15.88	0.6250	70.0	108.0	15.88
A92016.0	–	16.00	0.6299	58.0	115.0	16.00
A92041/64	41/64	16.27	0.6406	73.0	114.0	16.27
A92016.5	–	16.50	0.6496	60.0	119.0	16.50
A92021/32	21/32	16.67	0.6563	73.0	114.0	16.67
A92016.75	–	16.75	0.6594	60.0	119.0	16.75
A92017.0	–	17.00	0.6693	60.0	119.0	17.00
A92043/64	43/64	17.07	0.6719	73.0	117.0	17.07
A92011/16	11/16	17.46	0.6875	73.0	117.0	17.46
A92017.5	–	17.50	0.6890	62.0	123.0	17.50
A92045/64	45/64	17.86	0.7031	76.0	121.0	17.86
A92018.0	–	18.00	0.7087	62.0	123.0	18.00
A92023/32	23/32	18.26	0.7188	76.0	121.0	18.26
A92018.5	–	18.50	0.7283	64.0	127.0	18.50
A92047/64	47/64	18.65	0.7344	79.0	127.0	18.65
A92019.0	–	19.00	0.7480	64.0	127.0	19.00
A9203/4	3/4	19.05	0.7500	79.0	127.0	19.05
A92049/64	49/64	19.45	0.7656	83.0	130.0	19.45
A92019.5	–	19.50	0.7677	66.0	131.0	19.50
A92025/32	25/32	19.84	0.7813	83.0	130.0	19.84
A92020.0	–	20.00	0.7874	66.0	131.0	20.00



A921



PFX HSS-E (5% Co) extra korte productieboor, DIN1897, Alcrona-Top gecoat

Hoogproductieve spiraalboor voor het boren van gaten van hoge kwaliteit en nauwkeurigheid bij hoge snelheden en voedingen (H10). Zelfcenterende 130° tophoek en speciale parabolische spaangroefvorm helpen in samenwerking met de unieke snijkantsgeometrie om spanen zo te vormen dat ze makkelijk zijn af te voeren. Daardoor is het mogelijk diepe gaten te boren in één arbeidsgang. Geschikt voor vele materialen.



PFX

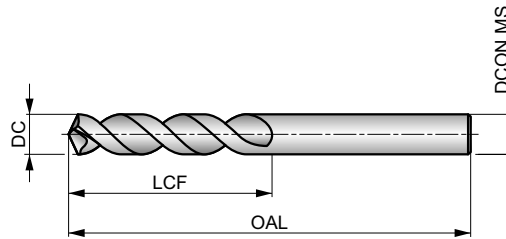

HSS-E	DIN ANSI	3xD
130°	Alcrona Top	
$\lambda > 35^\circ$	R	DC h8

De tabel geeft de geschiktheid aan voor de materiaalgroep en de startwaarden voor de snijsnelheid (m/min) en de letter verwijst naar de toe te passen voeding (fn), zie vanaf pagina 175.

P1.1 ■ 70 M	P1.2 ■ 79 M	P1.3 ■ 81 M	P2.1 ■ 60 M	P2.2 ■ 53 J	P2.3 ■ 47 G	P3.1 ■ 56 J	P3.2 ■ 45 J	P3.3 ■ 38 G	P4.1 ■ 33 J	P4.2 ■ 28 G	P4.3 ■ 23 G	M1.1 ■ 23 F	M1.2 ■ 20 F
M2.1 ■ 21 F	M2.2 ■ 17 F	M3.1 ■ 10 F	M3.2 ■ 9 F	M3.3 ■ 8 F	M4.1 ■ 11 D	K1.1 ■ 53 L	K1.2 ■ 39 L	K1.3 ■ 29 L	K2.1 ■ 52 L	K2.2 ■ 42 L	K2.3 ■ 33 J	K3.1 ■ 46 L	K3.2 ■ 35 L
K3.3 ■ 28 J	K4.1 ■ 42 L	K4.2 ■ 32 L	K4.3 ■ 23 J	K4.4 ■ 20 J	K4.5 ■ 17 J	K5.1 ■ 48 L	K5.2 ■ 36 L	K5.3 ■ 28 J	S1.1 ■ 48 I	S1.2 ■ 29 I	S1.3 ■ 16 E	S2.1 ■ 19 I	S2.2 ■ 14 G
S3.1 ■ 14 I	S3.2 ■ 10 G	S4.1 ■ 11 I	S4.2 ■ 8 G										

Product	DC (inch)	DC (mm)	DC (inch)	LCF (mm)	OAL (mm)	DCON MS (mm)
A9212.5	–	2.50	0.0984	14.0	43.0	2.50
A9212.6	–	2.60	0.1024	14.0	43.0	2.60
A9212.7	–	2.70	0.1063	16.0	46.0	2.70
A9217/64	7/64	2.78	0.1094	21.0	46.0	2.78
A9212.9	–	2.90	0.1142	16.0	46.0	2.90
A9213.0	–	3.00	0.1181	16.0	46.0	3.00
A9213.1	–	3.10	0.1220	18.0	49.0	3.10
A9211/8	1/8	3.18	0.1250	22.0	48.0	3.18
A9213.2	–	3.20	0.1260	18.0	49.0	3.20
A9213.3	–	3.30	0.1299	18.0	49.0	3.30
A9213.4	–	3.40	0.1339	20.0	52.0	3.40
A9213.5	–	3.50	0.1378	20.0	52.0	3.50
A9219/64	9/64	3.57	0.1406	24.0	49.0	3.57
A9213.6	–	3.60	0.1417	20.0	52.0	3.60
A9213.7	–	3.70	0.1457	20.0	52.0	3.70
A9213.8	–	3.80	0.1496	22.0	55.0	3.80
A9213.9	–	3.90	0.1535	22.0	55.0	3.90
A9215/32	5/32	3.97	0.1563	25.0	52.0	3.97
A9214.0	–	4.00	0.1575	22.0	55.0	4.00
A9214.1	–	4.10	0.1614	22.0	55.0	4.10
A9214.2	–	4.20	0.1654	22.0	55.0	4.20
A9214.3	–	4.30	0.1693	24.0	58.0	4.30
A92111/64	11/64	4.37	0.1719	27.0	54.0	4.37
A9214.4	–	4.40	0.1732	24.0	58.0	4.40
A9214.5	–	4.50	0.1772	24.0	58.0	4.50
A9214.6	–	4.60	0.1811	24.0	58.0	4.60

Product	DC (inch)	DC (mm)	DC (inch)	LCF (mm)	OAL (mm)	DCON MS (mm)
A9214.7	–	4.70	0.1850	24.0	58.0	4.70
A9213/16	3/16	4.76	0.1875	29.0	56.0	4.76
A9214.8	–	4.80	0.1890	26.0	62.0	4.80
A9214.9	–	4.90	0.1929	26.0	62.0	4.90
A9215.0	–	5.00	0.1969	26.0	62.0	5.00
A9215.1	–	5.10	0.2008	26.0	62.0	5.10
A92113/64	13/64	5.16	0.2031	30.0	57.0	5.16
A9215.2	–	5.20	0.2047	26.0	62.0	5.20
A9215.3	–	5.30	0.2087	26.0	62.0	5.30
A9215.4	–	5.40	0.2126	28.0	66.0	5.40
A9215.5	–	5.50	0.2165	28.0	66.0	5.50
A9217/32	7/32	5.56	0.2188	32.0	60.0	5.56
A9215.6	–	5.60	0.2205	28.0	66.0	5.60
A9215.7	–	5.70	0.2244	28.0	66.0	5.70
A9215.8	–	5.80	0.2283	28.0	66.0	5.80
A9215.9	–	5.90	0.2323	28.0	66.0	5.90
A92115/64	15/64	5.95	0.2344	33.0	62.0	5.95
A9216.0	–	6.00	0.2362	28.0	66.0	6.00
A9216.1	–	6.10	0.2402	31.0	70.0	6.10
A9216.2	–	6.20	0.2441	31.0	70.0	6.20
A9216.3	–	6.30	0.2480	31.0	70.0	6.30
A9211/4	1/4	6.35	0.2500	35.0	64.0	6.35
A9216.4	–	6.40	0.2520	31.0	70.0	6.40
A9216.5	–	6.50	0.2559	31.0	70.0	6.50
A9216.6	–	6.60	0.2598	31.0	70.0	6.60
A9216.7	–	6.70	0.2638	31.0	70.0	6.70



Product	DC	DC	DC	LCF	OAL	DCON MS
	(inch)	(mm)	(inch)	(mm)	(mm)	(mm)
A92117/64	17/64	6.75	0.2656	37.0	67.0	6.75
A9216.8	–	6.80	0.2677	34.0	74.0	6.80
A9216.9	–	6.90	0.2717	34.0	74.0	6.90
A9217.0	–	7.00	0.2756	34.0	74.0	7.00
A9217.1	–	7.10	0.2795	34.0	74.0	7.10
A9219/32	9/32	7.14	0.2813	38.0	68.0	7.14
A9217.2	–	7.20	0.2835	34.0	74.0	7.20
A9217.3	–	7.30	0.2874	34.0	74.0	7.30
A9217.4	–	7.40	0.2913	34.0	74.0	7.40
A9217.5	–	7.50	0.2953	34.0	74.0	7.50
A92119/64	19/64	7.54	0.2969	40.0	70.0	7.54
A9217.6	–	7.60	0.2992	37.0	79.0	7.60
A9217.7	–	7.70	0.3031	37.0	79.0	7.70
A9217.8	–	7.80	0.3071	37.0	79.0	7.80
A9217.9	–	7.90	0.3110	37.0	79.0	7.90
A9215/16	5/16	7.94	0.3125	41.0	71.0	7.94
A9218.0	–	8.00	0.3150	37.0	79.0	8.00
A9218.1	–	8.10	0.3189	37.0	79.0	8.10
A9218.2	–	8.20	0.3228	37.0	79.0	8.20
A9218.3	–	8.30	0.3268	37.0	79.0	8.30
A92121/64	21/64	8.33	0.3281	43.0	75.0	8.33
A9218.4	–	8.40	0.3307	37.0	79.0	8.40
A9218.5	–	8.50	0.3346	37.0	79.0	8.50
A9218.6	–	8.60	0.3386	40.0	84.0	8.60
A9218.7	–	8.70	0.3425	40.0	84.0	8.70
A92111/32	11/32	8.73	0.3438	43.0	76.0	8.73
A9218.8	–	8.80	0.3465	40.0	84.0	8.80
A9218.9	–	8.90	0.3504	40.0	84.0	8.90
A9219.0	–	9.00	0.3543	40.0	84.0	9.00
A9219.1	–	9.10	0.3583	40.0	84.0	9.10
A92123/64	23/64	9.13	0.3594	44.0	78.0	9.13
A9219.2	–	9.20	0.3622	40.0	84.0	9.20
A9219.3	–	9.30	0.3661	40.0	84.0	9.30
A9219.4	–	9.40	0.3701	40.0	84.0	9.40
A9219.5	–	9.50	0.3740	40.0	84.0	9.50
A9213/8	3/8	9.52	0.3750	46.0	79.0	9.52
A9219.6	–	9.60	0.3780	43.0	89.0	9.60

Product	DC	DC	DC	LCF	OAL	DCON MS
	(inch)	(mm)	(inch)	(mm)	(mm)	(mm)
A9219.7	–	9.70	0.3819	43.0	89.0	9.70
A9219.8	–	9.80	0.3858	43.0	89.0	9.80
A9219.9	–	9.90	0.3898	43.0	89.0	9.90
A92125/64	25/64	9.92	0.3906	48.0	83.0	9.92
A92110.0	–	10.00	0.3937	43.0	89.0	10.00
A92110.2	–	10.20	0.4016	43.0	89.0	10.20
A92110.3	–	10.30	0.4055	43.0	89.0	10.30
A92113/32	13/32	10.32	0.4063	49.0	84.0	10.32
A92110.5	–	10.50	0.4134	43.0	89.0	10.50
A92127/64	27/64	10.72	0.4219	51.0	86.0	10.72
A92110.8	–	10.80	0.4252	47.0	95.0	10.80
A92111.0	–	11.00	0.4331	47.0	95.0	11.00
A9217/16	7/16	11.11	0.4375	52.0	87.0	11.11
A92111.5	–	11.50	0.4528	47.0	95.0	11.50
A92129/64	29/64	11.51	0.4531	54.0	90.0	11.51
A92111.8	–	11.80	0.4646	47.0	95.0	11.80
A92115/32	15/32	11.91	0.4688	54.0	92.0	11.91
A92112.0	–	12.00	0.4724	51.0	102.0	12.00
A92131/64	31/64	12.30	0.4844	56.0	94.0	12.30
A92112.5	–	12.50	0.4921	51.0	102.0	12.50
A9211/2	1/2	12.70	0.5000	57.0	95.0	12.70
A92113.0	–	13.00	0.5118	51.0	102.0	13.00
A92133/64	33/64	13.10	0.5156	60.0	98.0	13.10
A92113.5	–	13.50	0.5315	54.0	107.0	13.50
A92135/64	35/64	13.89	0.5469	64.0	102.0	13.89
A92114.0	–	14.00	0.5512	54.0	107.0	14.00
A9219/16	9/16	14.29	0.5625	64.0	102.0	14.29
A92114.5	–	14.50	0.5709	56.0	111.0	14.50
A92137/64	37/64	14.68	0.5781	67.0	105.0	14.68
A92114.75	–	14.75	0.5807	56.0	111.0	14.75
A92115.0	–	15.00	0.5906	56.0	111.0	15.00
A92119/32	19/32	15.08	0.5938	67.0	105.0	15.08
A92139/64	39/64	15.48	0.6094	70.0	108.0	15.48
A92115.5	–	15.50	0.6102	58.0	115.0	15.50
A9215/8	5/8	15.88	0.6250	70.0	108.0	15.88
A92116.0	–	16.00	0.6299	58.0	115.0	16.00



A002



HSS korte spiraalboor, DIN338, TiN-Tip gecoat

Veelzijdige spiraalboor voor gebruik in hand en stationaire machines. Voor het boren in vele materialen. Boort zeer licht met unieke centreerkwaliteit door de PS-puntgeometrie. Doordat de boor niet verloopt bij het aanboren is hij ook ideaal voor het boren in buis en ronde oppervlakken. TiN-Tip coating verbetert de prestaties en verlengt de standtijd. De ruime en blanke spaangroeven zorgen verder voor een adequate afvoer van spanen.

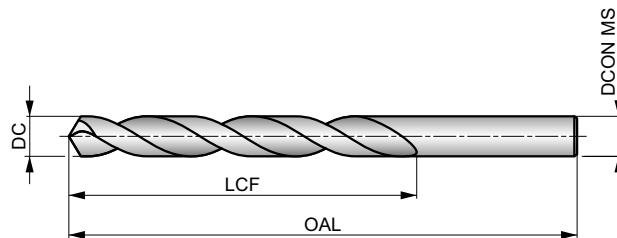

HSS	DIN 338	4xD
118°	TiN-Tip	
λ 20-35°	R	DC h8

De tabel geeft de geschiktheid aan voor de materiaalgroep en de startwaarden voor de snijsnelheid (m/min) en de letter verwijst naar de toe te passen voeding (fn), zie vanaf pagina 175.

P1.1 ■ 46 J	P1.2 ■ 52 J	P1.3 ■ 54 J	P2.1 ■ 40 J	P2.2 ■ 35 F	P2.3 ■ 31 F	P3.1 ■ 27 F	P3.2 ■ 21 F	P3.3 ■ 18 F	P4.1 ■ 16 F	P4.2 ■ 13 F	P4.3 ■ 11 E	M1.1 ■ 27 F	M1.2 ■ 23 F
M2.1 ■ 24 F	M2.2 ■ 20 F	M3.1 ■ 14 G	M3.2 ■ 12 G	M3.3 ■ 11 G	M4.1 ■ 16 C	K1.1 ■ 40 J	K1.2 ■ 30 E	K1.3 ■ 22 E	K2.1 ■ 34 E	K2.2 ■ 28 E	K2.3 ■ 22 E	K3.1 ■ 30 E	K3.2 ■ 23 E
K3.3 ■ 19 E	K4.1 ■ 28 E	K4.2 ■ 21 E	K4.3 ■ 16 E	K4.4 ■ 13 E	K4.5 ■ 11 E	K5.1 ■ 32 E	K5.2 ■ 24 E	K5.3 ■ 19 E	N1.1 ■ 41 K	N1.2 ■ 31 K	N1.3 ■ 21 J	N2.1 ■ 51 I	N2.2 ■ 46 I
N2.3 ■ 33 I	N3.1 ■ 56 H	N3.2 ■ 33 I	N3.3 ■ 17 G	N4.1 ■ 30 I	N4.2 ■ 50 H	N4.3 ■ 35 F	S1.1 ■ 23 F	S1.2 ■ 13 D	S1.3 ■ 7 B	S2.1 ■ 9 E	S2.2 ■ 4 A	S3.1 ■ 7 E	S3.2 ■ 3 A
S4.1 ■ 5 E	S4.2 ■ 2 A												

DC < 2mm blank; DC >= 2mm TiN-Tip gecoat en met Split Point.
Deze producten zijn ook in een set verkrijgbaar. Zie A087, A089, A094, A095 of A099.

Product	DC (inch)	DC (mm)	DC (inch)	LCF (mm)	OAL (mm)	DCON MS (mm)
A0021.0	—	1.00	0.0394	12.0	34.0	1.00
A0021.1	—	1.10	0.0433	14.0	36.0	1.10
A0023/64	3/64	1.19	0.0469	16.0	38.0	1.19
A0021.2	—	1.20	0.0472	16.0	38.0	1.20
A0021.3	—	1.30	0.0512	16.0	38.0	1.30
A0021.4	—	1.40	0.0551	18.0	40.0	1.40
A0021.5	—	1.50	0.0591	18.0	40.0	1.50
A0021/16	1/16	1.59	0.0625	20.0	43.0	1.59
A0021.6	—	1.60	0.0630	20.0	43.0	1.60
A0021.7	—	1.70	0.0669	20.0	43.0	1.70
A0021.8	—	1.80	0.0709	22.0	46.0	1.80
A0021.9	—	1.90	0.0748	22.0	46.0	1.90
A0025/64	5/64	1.98	0.0781	24.0	49.0	1.98
A0022.0	—	2.00	0.0787	24.0	49.0	2.00
A0022.1	—	2.10	0.0827	24.0	49.0	2.10
A0022.2	—	2.20	0.0866	27.0	53.0	2.20
A0022.3	—	2.30	0.0906	27.0	53.0	2.30
A0023/32	3/32	2.38	0.0938	30.0	57.0	2.38
A0022.4	—	2.40	0.0945	30.0	57.0	2.40
A0022.5	—	2.50	0.0984	30.0	57.0	2.50
A0022.6	—	2.60	0.1024	30.0	57.0	2.60
A0022.7	—	2.70	0.1063	33.0	61.0	2.70
A0027/64	7/64	2.78	0.1094	33.0	61.0	2.78
A0022.8	—	2.80	0.1102	33.0	61.0	2.80

Product	DC (inch)	DC (mm)	DC (inch)	LCF (mm)	OAL (mm)	DCON MS (mm)
A0022.9	—	2.90	0.1142	33.0	61.0	2.90
A0023.0	—	3.00	0.1181	33.0	61.0	3.00
A0023.1	—	3.10	0.1220	36.0	65.0	3.10
A0021/8	1/8	3.18	0.1250	36.0	65.0	3.18
A0023.2	—	3.20	0.1260	36.0	65.0	3.20
A0023.25	—	3.25	0.1280	36.0	65.0	3.25
A0023.3	—	3.30	0.1299	36.0	65.0	3.30
A0023.4	—	3.40	0.1339	39.0	70.0	3.40
A0023.5	—	3.50	0.1378	39.0	70.0	3.50
A0029/64	9/64	3.57	0.1406	39.0	70.0	3.57
A0023.6	—	3.60	0.1417	39.0	70.0	3.60
A0023.7	—	3.70	0.1457	39.0	70.0	3.70
A0023.8	—	3.80	0.1496	43.0	75.0	3.80
A0023.9	—	3.90	0.1535	43.0	75.0	3.90
A0025/32	5/32	3.97	0.1563	43.0	75.0	3.97
A0024.0	—	4.00	0.1575	43.0	75.0	4.00
A0024.1	—	4.10	0.1614	43.0	75.0	4.10
A0024.2	—	4.20	0.1654	43.0	75.0	4.20
A0024.3	—	4.30	0.1693	47.0	80.0	4.30
A00211/64	11/64	4.37	0.1719	47.0	80.0	4.37
A0024.4	—	4.40	0.1732	47.0	80.0	4.40
A0024.5	—	4.50	0.1772	47.0	80.0	4.50
A0024.6	—	4.60	0.1811	47.0	80.0	4.60
A0024.7	—	4.70	0.1850	47.0	80.0	4.70



Product	DC	DC	DC	LCF	OAL	D CON MS
	(inch)	(mm)	(inch)	(mm)	(mm)	(mm)
A0023/16	3/16	4.76	0.1875	52.0	86.0	4.76
A0024.8	–	4.80	0.1890	52.0	86.0	4.80
A0024.9	–	4.90	0.1929	52.0	86.0	4.90
A0025.0	–	5.00	0.1969	52.0	86.0	5.00
A0025.1	–	5.10	0.2008	52.0	86.0	5.10
A00213/64	13/64	5.16	0.2031	52.0	86.0	5.16
A0025.2	–	5.20	0.2047	52.0	86.0	5.20
A0025.3	–	5.30	0.2087	52.0	86.0	5.30
A0025.4	–	5.40	0.2126	57.0	93.0	5.40
A0025.5	–	5.50	0.2165	57.0	93.0	5.50
A0027/32	7/32	5.56	0.2188	57.0	93.0	5.56
A0025.6	–	5.60	0.2205	57.0	93.0	5.60
A0025.7	–	5.70	0.2244	57.0	93.0	5.70
A0025.8	–	5.80	0.2283	57.0	93.0	5.80
A0025.9	–	5.90	0.2323	57.0	93.0	5.90
A00215/64	15/64	5.95	0.2344	57.0	93.0	5.95
A0026.0	–	6.00	0.2362	57.0	93.0	6.00
A0026.1	–	6.10	0.2402	63.0	101.0	6.10
A0026.2	–	6.20	0.2441	63.0	101.0	6.20
A0026.3	–	6.30	0.2480	63.0	101.0	6.30
A0021/4	1/4	6.35	0.2500	63.0	101.0	6.35
A0026.4	–	6.40	0.2520	63.0	101.0	6.40
A0026.5	–	6.50	0.2559	63.0	101.0	6.50
A0026.6	–	6.60	0.2598	63.0	101.0	6.60
A0026.7	–	6.70	0.2638	63.0	101.0	6.70
A00217/64	17/64	6.75	0.2656	69.0	109.0	6.75
A0026.8	–	6.80	0.2677	69.0	109.0	6.80
A0026.9	–	6.90	0.2717	69.0	109.0	6.90
A0027.0	–	7.00	0.2756	69.0	109.0	7.00
A0027.1	–	7.10	0.2795	69.0	109.0	7.10
A0029/32	9/32	7.14	0.2813	69.0	109.0	7.14
A0027.2	–	7.20	0.2835	69.0	109.0	7.20
A0027.3	–	7.30	0.2874	69.0	109.0	7.30
A0027.4	–	7.40	0.2913	69.0	109.0	7.40
A0027.5	–	7.50	0.2953	69.0	109.0	7.50
A00219/64	19/64	7.54	0.2969	75.0	117.0	7.54
A0027.6	–	7.60	0.2992	75.0	117.0	7.60
A0027.7	–	7.70	0.3031	75.0	117.0	7.70
A0027.8	–	7.80	0.3071	75.0	117.0	7.80
A0027.9	–	7.90	0.3110	75.0	117.0	7.90
A0025/16	5/16	7.94	0.3125	75.0	117.0	7.94
A0028.0	–	8.00	0.3150	75.0	117.0	8.00
A0028.1	–	8.10	0.3189	75.0	117.0	8.10
A0028.2	–	8.20	0.3228	75.0	117.0	8.20
A0028.3	–	8.30	0.3268	75.0	117.0	8.30
A00221/64	21/64	8.33	0.3281	75.0	117.0	8.33
A0028.4	–	8.40	0.3307	75.0	117.0	8.40
A0028.5	–	8.50	0.3346	75.0	117.0	8.50
A0028.6	–	8.60	0.3386	81.0	125.0	8.60
A0028.7	–	8.70	0.3425	81.0	125.0	8.70
A00211/32	11/32	8.73	0.3438	81.0	125.0	8.73
A0028.8	–	8.80	0.3465	81.0	125.0	8.80
A0028.9	–	8.90	0.3504	81.0	125.0	8.90
A0029.0	–	9.00	0.3543	81.0	125.0	9.00
A0029.1	–	9.10	0.3583	81.0	125.0	9.10
A00223/64	23/64	9.13	0.3594	81.0	125.0	9.13
A0029.2	–	9.20	0.3622	81.0	125.0	9.20
A0029.3	–	9.30	0.3661	81.0	125.0	9.30
A0029.4	–	9.40	0.3701	81.0	125.0	9.40
A0029.5	–	9.50	0.3740	81.0	125.0	9.50
A0023/8	3/8	9.52	0.3750	87.0	133.0	9.52
A0029.6	–	9.60	0.3780	87.0	133.0	9.60
A0029.7	–	9.70	0.3819	87.0	133.0	9.70
A0029.8	–	9.80	0.3858	87.0	133.0	9.80
A0029.9	–	9.90	0.3898	87.0	133.0	9.90
A00225/64	25/64	9.92	0.3906	87.0	133.0	9.92
A00210.0	–	10.00	0.3937	87.0	133.0	10.00

Product	DC	DC	DC	LCF	OAL	D CON MS
	(inch)	(mm)	(inch)	(mm)	(mm)	(mm)
A00210.1	–	10.10	0.3976	87.0	133.0	10.10
A00210.2	–	10.20	0.4016	87.0	133.0	10.20
A00210.3	–	10.30	0.4055	87.0	133.0	10.30
A00213/32	13/32	10.32	0.4063	87.0	133.0	10.32
A00210.4	–	10.40	0.4094	87.0	133.0	10.40
A00210.5	–	10.50	0.4134	87.0	133.0	10.50
A00210.6	–	10.60	0.4173	87.0	133.0	10.60
A00210.7	–	10.70	0.4213	94.0	142.0	10.70
A00227/64	27/64	10.72	0.4219	94.0	142.0	10.72
A00210.8	–	10.80	0.4252	94.0	142.0	10.80
A00210.9	–	10.90	0.4291	94.0	142.0	10.90
A00211.0	–	11.00	0.4331	94.0	142.0	11.00
A00211.1	–	11.10	0.4370	94.0	142.0	11.10
A0027/16	7/16	11.11	0.4375	94.0	142.0	11.11
A00211.2	–	11.20	0.4409	94.0	142.0	11.20
A00211.3	–	11.30	0.4449	94.0	142.0	11.30
A00211.4	–	11.40	0.4488	94.0	142.0	11.40
A00211.5	–	11.50	0.4528	94.0	142.0	11.50
A00229/64	29/64	11.51	0.4531	94.0	142.0	11.51
A00211.6	–	11.60	0.4567	94.0	142.0	11.60
A00211.7	–	11.70	0.4606	94.0	142.0	11.70
A00211.8	–	11.80	0.4646	94.0	142.0	11.80
A00211.9	–	11.90	0.4685	101.0	151.0	11.90
A00215/32	15/32	11.91	0.4688	101.0	151.0	11.91
A00212.0	–	12.00	0.4724	101.0	151.0	12.00
A00212.1	–	12.10	0.4764	101.0	151.0	12.10
A00212.2	–	12.20	0.4803	101.0	151.0	12.20
A00212.3	–	12.30	0.4843	101.0	151.0	12.30
A00231/64	31/64	12.30	0.4844	101.0	151.0	12.30
A00212.4	–	12.40	0.4882	101.0	151.0	12.40
A00212.5	–	12.50	0.4921	101.0	151.0	12.50
A00212.6	–	12.60	0.4961	101.0	151.0	12.60
A00212.7	–	12.70	0.5000	101.0	151.0	12.70
A0021/2	1/2	12.70	0.5000	101.0	151.0	12.70
A00212.8	–	12.80	0.5039	101.0	151.0	12.80
A00212.9	–	12.90	0.5079	101.0	151.0	12.90
A00213.0	–	13.00	0.5118	101.0	151.0	13.00
A00233/64	33/64	13.10	0.5156	101.0	151.0	13.10
A00213.1	–	13.10	0.5157	101.0	151.0	13.10
A00213.2	–	13.20	0.5197	101.0	151.0	13.20
A00213.25	–	13.25	0.5217	108.0	160.0	13.25
A00213.3	–	13.30	0.5236	108.0	160.0	13.30
A00213.4	–	13.40	0.5276	108.0	160.0	13.40
A00217/32	17/32	13.49	0.5313	108.0	160.0	13.49
A00213.5	–	13.50	0.5315	108.0	160.0	13.50
A00213.6	–	13.60	0.5354	108.0	160.0	13.60
A00213.7	–	13.70	0.5394	108.0	160.0	13.70
A00213.75	–	13.75	0.5413	108.0	160.0	13.75
A00213.8	–	13.80	0.5433	108.0	160.0	13.80
A00235/64	35/64	13.89	0.5469	108.0	160.0	13.89
A00213.9	–	13.90	0.5472	108.0	160.0	13.90
A00214.0	–	14.00	0.5512	108.0	160.0	14.00
A00214.25	–	14.25	0.5610	114.0	169.0	14.25
A0029/16	9/16	14.29	0.5625	114.0	169.0	14.29
A00214.5	–	14.50	0.5709	114.0	169.0	14.50
A00237/64	37/64	14.68	0.5781	114.0	169.0	14.68
A00214.75	–	14.75	0.5807	114.0	169.0	14.75
A00215.0	–	15.00	0.5906	114.0	169.0	15.00
A00219/32	19/32	15.08	0.5938	120.0	178.0	15.08
A00215.25	–	15.25	0.6004	120.0	178.0	15.25
A00239/64	39/64	15.48	0.6094	120.0	178.0	15.48
A00215.5	–	15.50	0.6102	120.0	178.0	15.50
A00215.75	–	15.75	0.6201	120.0	178.0	15.75
A0025/8	5/8	15.88	0.6250	120.0	178.0	15.88
A00216.0	–	16.00	0.6299	120.0	178.0	16.00



A002S



HSS korte spiraalboor, DIN338, TiN-Tip gecoat, blister

Veelzijdige spiraalboor in blister voor gebruik in hand en stationaire machines. Voor het boren in vele materialen. Boort zeer licht met unieke centreerkwaliteit door de PS-puntgeometrie. Doordat de boor niet verloopt bij het aanboren is hij ook ideaal voor het boren in buis en ronde oppervlakken. TiN-Tip coating verbetert de prestaties en verlengt de standtijd. De ruime en blanke spaangroeven zorgen verder voor een adequate afvoer van spanen.

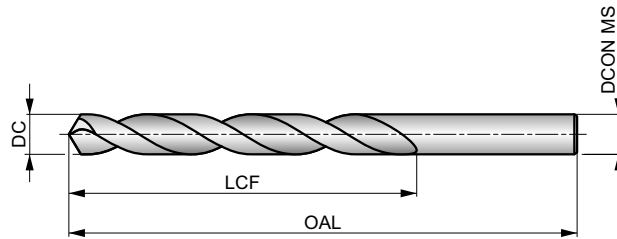

HSS	DIN 338	4xD
118°	TiN-Tip	
λ 20-35°	R	DC h8

De tabel geeft de geschiktheid aan voor de materiaalgroep en de startwaarden voor de snijsnelheid (m/min) en de letter verwijst naar de toe te passen voeding (fn), zie vanaf pagina 175.

P1.1 ■ 46 J	P1.2 ■ 52 J	P1.3 ■ 54 J	P2.1 ■ 40 J	P2.2 ■ 35 F	P2.3 ■ 31 F	P3.1 ■ 27 F	P3.2 ■ 21 F	P3.3 ■ 18 F	P4.1 ■ 16 F	P4.2 ■ 13 F	P4.3 ■ 11 E	M1.1 ■ 27 F	M1.2 ■ 23 F
M2.1 ■ 24 F	M2.2 ■ 20 F	M3.1 ■ 14 G	M3.2 ■ 12 G	M3.3 ■ 11 G	M4.1 ■ 16 C	K1.1 ■ 40 J	K1.2 ■ 30 E	K1.3 ■ 22 E	K2.1 ■ 34 E	K2.2 ■ 28 E	K2.3 ■ 22 E	K3.1 ■ 30 E	K3.2 ■ 23 E
K3.3 ■ 19 E	K4.1 ■ 28 E	K4.2 ■ 21 E	K4.3 ■ 16 E	K4.4 ■ 13 E	K4.5 ■ 11 E	K5.1 ■ 32 E	K5.2 ■ 24 E	K5.3 ■ 19 E	N1.1 ■ 41 K	N1.2 ■ 31 K	N1.3 ■ 21 J	N2.1 ■ 51 I	N2.2 ■ 46 I
N2.3 ■ 33 I	N3.1 ■ 56 H	N3.2 ■ 33 I	N3.3 ■ 17 G	N4.1 ■ 30 I	N4.2 ■ 50 H	N4.3 ■ 35 F	S1.1 ■ 23 F	S1.2 ■ 13 D	S1.3 ■ 7 B	S2.1 ■ 9 E	S2.2 ■ 4 A	S3.1 ■ 7 E	S3.2 ■ 3 A
S4.1 ■ 5 E	S4.2 ■ 2 A												

DC <= 5mm: 2 stuks in 1 verpakking.

Product	DC (inch)	DC (mm)	DC (inch)	LCF (mm)	OAL (mm)	DCON MS (mm)
A002S2.0	-	2.00	0.0787	24.0	49.0	2.00
A002S2.5	-	2.50	0.0984	30.0	57.0	2.50
A002S3.0	-	3.00	0.1181	33.0	61.0	3.00
A002S1/8	1/8	3.18	0.1250	36.0	65.0	3.18
A002S3.2	-	3.20	0.1260	36.0	65.0	3.20
A002S3.3	-	3.30	0.1299	36.0	65.0	3.30
A002S3.5	-	3.50	0.1378	39.0	70.0	3.50
A002S5/32	5/32	3.97	0.1563	43.0	75.0	3.97
A002S4.0	-	4.00	0.1575	43.0	75.0	4.00
A002S4.1	-	4.10	0.1614	43.0	75.0	4.10
A002S4.2	-	4.20	0.1654	43.0	75.0	4.20
A002S4.5	-	4.50	0.1772	47.0	80.0	4.50
A002S3/16	3/16	4.76	0.1875	52.0	86.0	4.76
A002S5.0	-	5.00	0.1969	52.0	86.0	5.00
A002S13/64	13/64	5.16	0.2031	52.0	86.0	5.16
A002S5.5	-	5.50	0.2165	57.0	93.0	5.50
A002S7/32	7/32	5.56	0.2188	57.0	93.0	5.56
A002S6.0	-	6.00	0.2362	57.0	93.0	6.00
A002S1/4	1/4	6.35	0.2500	63.0	101.0	6.35
A002S6.5	-	6.50	0.2559	63.0	101.0	6.50

Product	DC (inch)	DC (mm)	DC (inch)	LCF (mm)	OAL (mm)	DCON MS (mm)
A002S17/64	17/64	6.75	0.2656	69.0	109.0	6.75
A002S6.8	-	6.80	0.2677	69.0	109.0	6.80
A002S7.0	-	7.00	0.2756	69.0	109.0	7.00
A002S7.5	-	7.50	0.2953	69.0	109.0	7.50
A002S5/16	5/16	7.94	0.3125	75.0	117.0	7.94
A002S8.0	-	8.00	0.3150	75.0	117.0	8.00
A002S8.2	-	8.20	0.3228	75.0	117.0	8.20
A002S8.5	-	8.50	0.3346	75.0	117.0	8.50
A002S9.0	-	9.00	0.3543	81.0	125.0	9.00
A002S9.5	-	9.50	0.3740	81.0	125.0	9.50
A002S3/8	3/8	9.52	0.3750	87.0	133.0	9.52
A002S10.0	-	10.00	0.3937	87.0	133.0	10.00
A002S10.2	-	10.20	0.4016	87.0	133.0	10.20
A002S10.5	-	10.50	0.4134	87.0	133.0	10.50
A002S11.0	-	11.00	0.4331	94.0	142.0	11.00
A002S11.5	-	11.50	0.4528	94.0	142.0	11.50
A002S12.0	-	12.00	0.4724	101.0	151.0	12.00
A002S12.5	-	12.50	0.4921	101.0	151.0	12.50
A002S1/2	1/2	12.70	0.5000	101.0	151.0	12.70
A002S13.0	-	13.00	0.5118	101.0	151.0	13.00



A100



HSS spiraalboor, DIN338, stoomontlaten

Een precisie geslepen, veelzijdige boor met een 118° conventionele punt, die stabiliteit geeft en gemakkelijk naslijpbaar is, waardoor hij zeer economisch is. Bruikbaar voor hand en stationaire machines. De stoomontlaten afwerking houdt snijvloestof vast en voorkomt het aanlassen van spanen. Geschikt voor vele materialen.

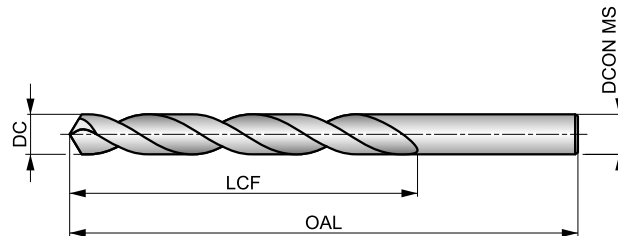

HSS	DIN 338	4xD
118°	ST	
λ 20-35°	R	DC h8

De tabel geeft de geschiktheid aan voor de materiaalgroep en de startwaarden voor de snijsnelheid (m/min) en de letter verwijst naar de toe te passen voeding (fn), zie vanaf pagina 175.

P1.1 ■ 33 H	P1.2 ■ 37 H	P1.3 ■ 38 H	P2.1 ■ 28 H	P2.2 ■ 25 F	P2.3 ■ 22 E	P3.1 ■ 19 F	P3.2 ■ 15 F	P3.3 ■ 13 E	P4.1 ■ 11 F	P4.2 ■ 10 E	P4.3 ■ 8 D	M1.1 ■ 21 E	M1.2 ■ 17 E
M2.1 ■ 18 E	M2.2 ■ 15 E	M3.1 ■ 9 G	M3.2 ■ 8 G	M3.3 ■ 7 G	M4.1 ■ 9 C	K1.1 ■ 30 H	K1.2 ■ 22 F	K1.3 ■ 17 F	K2.1 ■ 25 E	K2.2 ■ 20 E	K2.3 ■ 16 E	K3.1 ■ 22 E	K3.2 ■ 17 E
K3.3 ■ 13 E	K4.1 ■ 20 E	K4.2 ■ 15 E	K4.3 ■ 11 E	K4.4 ■ 10 E	K4.5 ■ 8 E	K5.1 ■ 23 E	K5.2 ■ 17 E	K5.3 ■ 13 E	N1.1 ■ 33 J	N1.2 ■ 25 J	N1.3 ■ 17 I	N2.1 ■ 42 H	N2.2 ■ 37 H
N2.3 ■ 27 H	N3.1 ■ 59 H	N3.2 ■ 35 I	N3.3 ■ 18 G	N4.1 ■ 30 J	N4.2 ■ 28 H	N4.3 ■ 14 F	S1.1 ■ 23 E	S1.2 ■ 12 D	S1.3 ■ 6 B	S2.1 ■ 8 E	S2.2 ■ 4 A	S3.1 ■ 6 E	S3.2 ■ 3 A
S4.1 ■ 5 E	S4.2 ■ 2 A												

DC ≤ 1mm; 3/64"; N60 blank.

Deze producten zijn ook in een set verkrijgbaar. Zie A190, A191 en A199.

Product	DC	DC	DC	LCF	OAL	DCON MS	Product	DC	DC	DC	LCF	OAL	DCON MS
	(inch)	(mm)	(inch)	(mm)	(mm)	(mm)		(inch)	(mm)	(inch)	(mm)	(mm)	(mm)
A100.2	–	0.20	0.0079	2.5	19.0	0.20	A100.6	–	0.60	0.0236	7.0	24.0	0.60
A100.25	–	0.25	0.0098	3.0	19.0	0.25	A100N73	N73	0.61	0.0240	8.0	26.0	0.61
A100.3	–	0.30	0.0118	3.0	19.0	0.30	A100.62	–	0.62	0.0244	8.0	26.0	0.62
A100.32	–	0.32	0.0126	4.0	19.0	0.32	A100N72	N72	0.64	0.0250	8.0	26.0	0.64
A100N80	N80	0.34	0.0135	4.0	19.0	0.34	A100.65	–	0.65	0.0256	8.0	26.0	0.65
A100.35	–	0.35	0.0138	4.0	19.0	0.35	A100N71	N71	0.66	0.0260	8.0	26.0	0.66
A100N79	N79	0.37	0.0145	4.0	19.0	0.37	A100.68	–	0.68	0.0268	9.0	28.0	0.68
A100.38	–	0.38	0.0150	4.0	19.0	0.38	A100.7	–	0.70	0.0276	9.0	28.0	0.70
A1001/64	1/64	0.40	0.0156	5.0	20.0	0.40	A100N70	N70	0.71	0.0280	9.0	28.0	0.71
A100.4	–	0.40	0.0157	5.0	20.0	0.40	A100.72	–	0.72	0.0283	9.0	28.0	0.72
A100N78	N78	0.41	0.0160	5.0	20.0	0.41	A100N69	N69	0.74	0.0292	9.0	28.0	0.74
A100.42	–	0.42	0.0165	5.0	20.0	0.42	A100.75	–	0.75	0.0295	9.0	28.0	0.75
A100.45	–	0.45	0.0177	5.0	20.0	0.45	A100.78	–	0.78	0.0307	10.0	30.0	0.78
A100N77	N77	0.46	0.0180	5.0	20.0	0.46	A1001/32	1/32	0.79	0.0313	10.0	30.0	0.79
A100.48	–	0.48	0.0189	5.0	20.0	0.48	A100N68	N68	0.79	0.0310	10.0	30.0	0.79
A100.5	–	0.50	0.0197	6.0	22.0	0.50	A100.8	–	0.80	0.0315	10.0	30.0	0.80
A100N76	N76	0.51	0.0200	6.0	22.0	0.51	A100N67	N67	0.81	0.0320	10.0	30.0	0.81
A100.52	–	0.52	0.0205	6.0	22.0	0.52	A100.82	–	0.82	0.0323	10.0	30.0	0.82
A100N75	N75	0.53	0.0210	6.0	22.0	0.53	A100N66	N66	0.84	0.0330	10.0	30.0	0.84
A100.55	–	0.55	0.0217	7.0	24.0	0.55	A100.85	–	0.85	0.0335	10.0	30.0	0.85
A100N74	N74	0.57	0.0225	7.0	24.0	0.57	A100.88	–	0.88	0.0346	11.0	32.0	0.88
A100.58	–	0.58	0.0228	7.0	24.0	0.58	A100N65	N65	0.89	0.0350	11.0	32.0	0.89



Product	DC	DC	DC	LCF	OAL	DCON MS
	(inch)	(mm)	(inch)	(mm)	(mm)	(mm)
A100.9	—	0.90	0.0354	11.0	32.0	0.90
A100N64	N64	0.91	0.0360	11.0	32.0	0.91
A100.92	—	0.92	0.0362	11.0	32.0	0.92
A100N63	N63	0.94	0.0370	11.0	32.0	0.94
A100.95	—	0.95	0.0374	11.0	32.0	0.95
A100N62	N62	0.97	0.0380	12.0	34.0	0.97
A100.98	—	0.98	0.0386	12.0	34.0	0.98
A100N61	N61	0.99	0.0390	12.0	34.0	0.99
A1001.0	—	1.00	0.0394	12.0	34.0	1.00
A100N60	N60	1.02	0.0400	12.0	34.0	1.02
A100N59	N59	1.04	0.0410	12.0	34.0	1.04
A1001.05	—	1.05	0.0413	12.0	34.0	1.05
A100N58	N58	1.07	0.0420	14.0	36.0	1.07
A100N57	N57	1.09	0.0430	14.0	36.0	1.09
A1001.1	—	1.10	0.0433	14.0	36.0	1.10
A1001.15	—	1.15	0.0453	14.0	36.0	1.15
A100N56	N56	1.18	0.0465	14.0	36.0	1.18
A1003/64	3/64	1.19	0.0469	16.0	38.0	1.19
A1001.2	—	1.20	0.0472	16.0	38.0	1.20
A1001.25	—	1.25	0.0492	16.0	38.0	1.25
A1001.3	—	1.30	0.0512	16.0	38.0	1.30
A100N55	N55	1.32	0.0520	16.0	38.0	1.32
A1001.35	—	1.35	0.0531	18.0	40.0	1.35
A1001.4	—	1.40	0.0551	18.0	40.0	1.40
A100N54	N54	1.40	0.0550	18.0	40.0	1.40
A1001.45	—	1.45	0.0571	18.0	40.0	1.45
A1001.5	—	1.50	0.0591	18.0	40.0	1.50
A100N53	N53	1.51	0.0595	20.0	43.0	1.51
A1001.55	—	1.55	0.0610	20.0	43.0	1.55
A1001/16	1/16	1.59	0.0625	20.0	43.0	1.59
A1001.6	—	1.60	0.0630	20.0	43.0	1.60
A100N52	N52	1.61	0.0635	20.0	43.0	1.61
A1001.65	—	1.65	0.0650	20.0	43.0	1.65
A1001.7	—	1.70	0.0669	20.0	43.0	1.70
A100N51	N51	1.70	0.0670	22.0	46.0	1.70
A1001.75	—	1.75	0.0689	22.0	46.0	1.75
A100N50	N50	1.78	0.0700	22.0	46.0	1.78
A1001.8	—	1.80	0.0709	22.0	46.0	1.80
A1001.85	—	1.85	0.0728	22.0	46.0	1.85
A100N49	N49	1.85	0.0730	22.0	46.0	1.85
A1001.9	—	1.90	0.0748	22.0	46.0	1.90
A100N48	N48	1.93	0.0760	24.0	49.0	1.93
A1001.95	—	1.95	0.0768	24.0	49.0	1.95
A1005/64	5/64	1.98	0.0781	24.0	49.0	1.98
A100N47	N47	1.99	0.0785	24.0	49.0	1.99
A1002.0	—	2.00	0.0787	24.0	49.0	2.00
A1002.05	—	2.05	0.0807	24.0	49.0	2.05
A100N46	N46	2.06	0.0810	24.0	49.0	2.06
A100N45	N45	2.08	0.0820	24.0	49.0	2.08
A1002.1	—	2.10	0.0827	24.0	49.0	2.10
A1002.15	—	2.15	0.0846	27.0	53.0	2.15
A100N44	N44	2.18	0.0860	27.0	53.0	2.18
A1002.2	—	2.20	0.0866	27.0	53.0	2.20
A1002.25	—	2.25	0.0886	27.0	53.0	2.25
A100N43	N43	2.26	0.0890	27.0	53.0	2.26
A1002.3	—	2.30	0.0906	27.0	53.0	2.30
A1002.35	—	2.35	0.0925	27.0	53.0	2.35
A1003/32	3/32	2.38	0.0938	30.0	57.0	2.38
A100N42	N42	2.38	0.0935	30.0	57.0	2.38
A1002.4	—	2.40	0.0945	30.0	57.0	2.40
A100N41	N41	2.44	0.0960	30.0	57.0	2.44
A1002.45	—	2.45	0.0965	30.0	57.0	2.45

Product	DC	DC	DC	LCF	OAL	DCON MS
	(inch)	(mm)	(inch)	(mm)	(mm)	(mm)
A100N40	N40	2.49	0.0980	30.0	57.0	2.49
A1002.5	—	2.50	0.0984	30.0	57.0	2.50
A100N39	N39	2.53	0.0995	30.0	57.0	2.53
A1002.55	—	2.55	0.1004	30.0	57.0	2.55
A100N38	N38	2.58	0.1015	30.0	57.0	2.58
A1002.6	—	2.60	0.1024	30.0	57.0	2.60
A100N37	N37	2.64	0.1040	30.0	57.0	2.64
A1002.65	—	2.65	0.1043	30.0	57.0	2.65
A1002.7	—	2.70	0.1063	33.0	61.0	2.70
A100N36	N36	2.71	0.1065	33.0	61.0	2.71
A1002.75	—	2.75	0.1083	33.0	61.0	2.75
A1007/64	7/64	2.78	0.1094	33.0	61.0	2.78
A100N35	N35	2.79	0.1100	33.0	61.0	2.79
A1002.8	—	2.80	0.1102	33.0	61.0	2.80
A100N34	N34	2.82	0.1110	33.0	61.0	2.82
A1002.85	—	2.85	0.1122	33.0	61.0	2.85
A100N33	N33	2.87	0.1130	33.0	61.0	2.87
A1002.9	—	2.90	0.1142	33.0	61.0	2.90
A1002.95	—	2.95	0.1161	33.0	61.0	2.95
A100N32	N32	2.95	0.1160	33.0	61.0	2.95
A1003.0	—	3.00	0.1181	33.0	61.0	3.00
A100N31	N31	3.05	0.1200	36.0	65.0	3.05
A1003.1	—	3.10	0.1220	36.0	65.0	3.10
A1003.15	—	3.15	0.1240	36.0	65.0	3.15
A1001/8	1/8	3.18	0.1250	36.0	65.0	3.18
A1003.2	—	3.20	0.1260	36.0	65.0	3.20
A1003.25	—	3.25	0.1280	36.0	65.0	3.25
A100N30	N30	3.26	0.1285	36.0	65.0	3.26
A1003.3	—	3.30	0.1299	36.0	65.0	3.30
A1003.4	—	3.40	0.1339	39.0	70.0	3.40
A100N29	N29	3.45	0.1360	39.0	70.0	3.45
A1003.5	—	3.50	0.1378	39.0	70.0	3.50
A1009/64	9/64	3.57	0.1406	39.0	70.0	3.57
A100N28	N28	3.57	0.1405	39.0	70.0	3.57
A1003.6	—	3.60	0.1417	39.0	70.0	3.60
A100N27	N27	3.66	0.1440	39.0	70.0	3.66
A1003.7	—	3.70	0.1457	39.0	70.0	3.70
A100N26	N26	3.73	0.1470	39.0	70.0	3.73
A1003.75	—	3.75	0.1476	39.0	70.0	3.75
A1003.8	—	3.80	0.1496	43.0	75.0	3.80
A100N25	N25	3.80	0.1495	43.0	75.0	3.80
A100N24	N24	3.86	0.1520	43.0	75.0	3.86
A1003.9	—	3.90	0.1535	43.0	75.0	3.90
A100N23	N23	3.91	0.1540	43.0	75.0	3.91
A1005/32	5/32	3.97	0.1563	43.0	75.0	3.97
A100N22	N22	3.99	0.1570	43.0	75.0	3.99
A1004.0	—	4.00	0.1575	43.0	75.0	4.00
A100N21	N21	4.04	0.1590	43.0	75.0	4.04
A100N20	N20	4.09	0.1610	43.0	75.0	4.09
A1004.1	—	4.10	0.1614	43.0	75.0	4.10
A1004.2	—	4.20	0.1654	43.0	75.0	4.20
A100N19	N19	4.22	0.1660	43.0	75.0	4.22
A1004.25	—	4.25	0.1673	43.0	75.0	4.25
A1004.3	—	4.30	0.1693	47.0	80.0	4.30
A100N18	N18	4.31	0.1695	47.0	80.0	4.31
A10011/64	11/64	4.37	0.1719	47.0	80.0	4.37
A100N17	N17	4.39	0.1730	47.0	80.0	4.39
A1004.4	—	4.40	0.1732	47.0	80.0	4.40
A1004.5	—	4.50	0.1772	47.0	80.0	4.50
A100N16	N16	4.50	0.1770	47.0	80.0	4.50
A100N15	N15	4.57	0.1800	47.0	80.0	4.57
A1004.6	—	4.60	0.1811	47.0	80.0	4.60



Product	DC	DC	DC	LCF	OAL	D CON MS
	(inch)	(mm)	(inch)	(mm)	(mm)	(mm)
A100N14	N14	4.62	0.1820	47.0	80.0	4.62
A1004.7	–	4.70	0.1850	47.0	80.0	4.70
A100N13	N13	4.70	0.1850	47.0	80.0	4.70
A1004.75	–	4.75	0.1870	47.0	80.0	4.75
A1003/16	3/16	4.76	0.1875	52.0	86.0	4.76
A1004.8	–	4.80	0.1890	52.0	86.0	4.80
A100N12	N12	4.80	0.1890	52.0	86.0	4.80
A100N11	N11	4.85	0.1910	52.0	86.0	4.85
A1004.9	–	4.90	0.1929	52.0	86.0	4.90
A100N10	N10	4.92	0.1935	52.0	86.0	4.92
A100N9	N9	4.98	0.1960	52.0	86.0	4.98
A1005.0	–	5.00	0.1969	52.0	86.0	5.00
A100N8	N8	5.06	0.1990	52.0	86.0	5.06
A1005.1	–	5.10	0.2008	52.0	86.0	5.10
A100N7	N7	5.11	0.2010	52.0	86.0	5.11
A10013/64	13/64	5.16	0.2031	52.0	86.0	5.16
A100N6	N6	5.18	0.2040	52.0	86.0	5.18
A1005.2	–	5.20	0.2047	52.0	86.0	5.20
A100N5	N5	5.22	0.2055	52.0	86.0	5.22
A1005.25	–	5.25	0.2067	52.0	86.0	5.25
A1005.3	–	5.30	0.2087	52.0	86.0	5.30
A100N4	N4	5.31	0.2090	57.0	93.0	5.31
A1005.4	–	5.40	0.2126	57.0	93.0	5.40
A100N3	N3	5.41	0.2130	57.0	93.0	5.41
A1005.5	–	5.50	0.2165	57.0	93.0	5.50
A1007/32	7/32	5.56	0.2188	57.0	93.0	5.56
A1005.6	–	5.60	0.2205	57.0	93.0	5.60
A100N2	N2	5.61	0.2210	57.0	93.0	5.61
A1005.7	–	5.70	0.2244	57.0	93.0	5.70
A1005.75	–	5.75	0.2264	57.0	93.0	5.75
A100N1	1	5.79	0.2280	57.0	93.0	5.79
A1005.8	–	5.80	0.2283	57.0	93.0	5.80
A1005.9	–	5.90	0.2323	57.0	93.0	5.90
A100A	A	5.94	0.2340	57.0	93.0	5.94
A10015/64	15/64	5.95	0.2344	57.0	93.0	5.95
A1006.0	–	6.00	0.2362	57.0	93.0	6.00
A100B	B	6.03	0.2380	63.0	101.0	6.03
A1006.1	–	6.10	0.2402	63.0	101.0	6.10
A100C	C	6.15	0.2420	63.0	101.0	6.15
A1006.2	–	6.20	0.2441	63.0	101.0	6.20
A1006.25	–	6.25	0.2461	63.0	101.0	6.25
A100D	D	6.25	0.2460	63.0	101.0	6.25
A1006.3	–	6.30	0.2480	63.0	101.0	6.30
A1001/4	1/4	6.35	0.2500	63.0	101.0	6.35
A100E	E	6.35	0.2500	63.0	101.0	6.35
A1006.4	–	6.40	0.2520	63.0	101.0	6.40
A1006.5	–	6.50	0.2559	63.0	101.0	6.50
A100F	F	6.53	0.2570	63.0	101.0	6.53
A1006.6	–	6.60	0.2598	63.0	101.0	6.60
A100G	G	6.63	0.2610	63.0	101.0	6.63
A1006.7	–	6.70	0.2638	63.0	101.0	6.70
A10017/64	17/64	6.75	0.2656	69.0	109.0	6.75
A1006.75	–	6.75	0.2657	69.0	109.0	6.75
A100H	H	6.76	0.2660	69.0	109.0	6.76
A1006.8	–	6.80	0.2677	69.0	109.0	6.80
A1006.9	–	6.90	0.2717	69.0	109.0	6.90
A100I	I	6.91	0.2720	69.0	109.0	6.91
A1007.0	–	7.00	0.2756	69.0	109.0	7.00
A100J	J	7.04	0.2770	69.0	109.0	7.04
A1007.1	–	7.10	0.2795	69.0	109.0	7.10
A1009/32	9/32	7.14	0.2813	69.0	109.0	7.14
A100K	K	7.14	0.2810	69.0	109.0	7.14

Product	DC	DC	DC	LCF	OAL	D CON MS
	(inch)	(mm)	(inch)	(mm)	(mm)	(mm)
A1007.2	–	7.20	0.2835	69.0	109.0	7.20
A1007.25	–	7.25	0.2854	69.0	109.0	7.25
A1007.3	–	7.30	0.2874	69.0	109.0	7.30
A100L	L	7.37	0.2900	69.0	109.0	7.37
A1007.4	–	7.40	0.2913	69.0	109.0	7.40
A100M	M	7.49	0.2949	69.0	109.0	7.49
A1007.5	–	7.50	0.2953	69.0	109.0	7.50
A10019/64	19/64	7.54	0.2969	75.0	117.0	7.54
A1007.6	–	7.60	0.2992	75.0	117.0	7.60
A100N	N	7.67	0.3020	75.0	117.0	7.67
A1007.7	–	7.70	0.3031	75.0	117.0	7.70
A1007.75	–	7.75	0.3051	75.0	117.0	7.75
A1007.8	–	7.80	0.3071	75.0	117.0	7.80
A1007.9	–	7.90	0.3110	75.0	117.0	7.90
A1005/16	5/16	7.94	0.3125	75.0	117.0	7.94
A1008.0	–	8.00	0.3150	75.0	117.0	8.00
A100O	O	8.03	0.3160	75.0	117.0	8.03
A1008.1	–	8.10	0.3189	75.0	117.0	8.10
A1008.2	–	8.20	0.3228	75.0	117.0	8.20
A100P	P	8.20	0.3230	75.0	117.0	8.20
A1008.25	–	8.25	0.3248	75.0	117.0	8.25
A1008.3	–	8.30	0.3268	75.0	117.0	8.30
A10021/64	21/64	8.33	0.3281	75.0	117.0	8.33
A1008.4	–	8.40	0.3307	75.0	117.0	8.40
A100Q	Q	8.43	0.3320	75.0	117.0	8.43
A1008.5	–	8.50	0.3346	75.0	117.0	8.50
A1008.6	–	8.60	0.3386	81.0	125.0	8.60
A100R	R	8.61	0.3390	81.0	125.0	8.61
A1008.7	–	8.70	0.3425	81.0	125.0	8.70
A10011/32	11/32	8.73	0.3438	81.0	125.0	8.73
A1008.75	–	8.75	0.3445	81.0	125.0	8.75
A1008.8	–	8.80	0.3465	81.0	125.0	8.80
A100S	S	8.84	0.3480	81.0	125.0	8.84
A1008.9	–	8.90	0.3504	81.0	125.0	8.90
A1009.0	–	9.00	0.3543	81.0	125.0	9.00
A100T	T	9.09	0.3580	81.0	125.0	9.09
A1009.1	–	9.10	0.3583	81.0	125.0	9.10
A10023/64	23/64	9.13	0.3594	81.0	125.0	9.13
A1009.2	–	9.20	0.3622	81.0	125.0	9.20
A1009.25	–	9.25	0.3642	81.0	125.0	9.25
A1009.3	–	9.30	0.3661	81.0	125.0	9.30
A100U	U	9.35	0.3680	81.0	125.0	9.35
A1009.4	–	9.40	0.3701	81.0	125.0	9.40
A1009.5	–	9.50	0.3740	81.0	125.0	9.50
A1003/8	3/8	9.52	0.3750	87.0	133.0	9.52
A100V	V	9.58	0.3770	87.0	133.0	9.58
A1009.6	–	9.60	0.3780	87.0	133.0	9.60
A1009.7	–	9.70	0.3819	87.0	133.0	9.70
A1009.75	–	9.75	0.3839	87.0	133.0	9.75
A1009.8	–	9.80	0.3858	87.0	133.0	9.80
A100W	W	9.80	0.3860	87.0	133.0	9.80
A1009.9	–	9.90	0.3898	87.0	133.0	9.90
A10025/64	25/64	9.92	0.3906	87.0	133.0	9.92
A10010.0	–	10.00	0.3937	87.0	133.0	10.00
A100X	X	10.08	0.3970	87.0	133.0	10.08
A10010.1	–	10.10	0.3976	87.0	133.0	10.10
A10010.2	–	10.20	0.4016	87.0	133.0	10.20
A10010.25	–	10.25	0.4035	87.0	133.0	10.25
A100Y	Y	10.26	0.4040	87.0	133.0	10.26
A10010.3	–	10.30	0.4055	87.0	133.0	10.30
A10013/32	13/32	10.32	0.4063	87.0	133.0	10.32
A10010.4	–	10.40	0.4094	87.0	133.0	10.40



Product	DC	DC	DC	LCF	OAL	DCON MS
	(inch)	(mm)	(inch)	(mm)	(mm)	(mm)
A100Z	Z	10.49	0.4130	87.0	133.0	10.49
A10010.5	–	10.50	0.4134	87.0	133.0	10.50
A10010.6	–	10.60	0.4173	87.0	133.0	10.60
A10010.7	–	10.70	0.4213	94.0	142.0	10.70
A10027/64	27/64	10.72	0.4219	94.0	142.0	10.72
A10010.75	–	10.75	0.4232	94.0	142.0	10.75
A10010.8	–	10.80	0.4252	94.0	142.0	10.80
A10010.9	–	10.90	0.4291	94.0	142.0	10.90
A10011.0	–	11.00	0.4331	94.0	142.0	11.00
A10011.1	–	11.10	0.4370	94.0	142.0	11.10
A1007/16	7/16	11.11	0.4375	94.0	142.0	11.11
A10011.2	–	11.20	0.4409	94.0	142.0	11.20
A10011.25	–	11.25	0.4429	94.0	142.0	11.25
A10011.3	–	11.30	0.4449	94.0	142.0	11.30
A10011.4	–	11.40	0.4488	94.0	142.0	11.40
A10011.5	–	11.50	0.4528	94.0	142.0	11.50
A10029/64	29/64	11.51	0.4531	94.0	142.0	11.51
A10011.6	–	11.60	0.4567	94.0	142.0	11.60
A10011.7	–	11.70	0.4606	94.0	142.0	11.70
A10011.75	–	11.75	0.4626	94.0	142.0	11.75
A10011.8	–	11.80	0.4646	94.0	142.0	11.80
A10011.9	–	11.90	0.4685	101.0	151.0	11.90
A10015/32	15/32	11.91	0.4688	101.0	151.0	11.91
A10012.0	–	12.00	0.4724	101.0	151.0	12.00
A10012.1	–	12.10	0.4764	101.0	151.0	12.10
A10012.2	–	12.20	0.4803	101.0	151.0	12.20
A10012.25	–	12.25	0.4823	101.0	151.0	12.25
A10012.3	–	12.30	0.4843	101.0	151.0	12.30
A10031/64	31/64	12.30	0.4844	101.0	151.0	12.30
A10012.4	–	12.40	0.4882	101.0	151.0	12.40
A10012.5	–	12.50	0.4921	101.0	151.0	12.50
A10012.6	–	12.60	0.4961	101.0	151.0	12.60
A10012.7	–	12.70	0.5000	101.0	151.0	12.70
A1001/2	1/2	12.70	0.5000	101.0	151.0	12.70
A10012.75	–	12.75	0.5020	101.0	151.0	12.75
A10012.8	–	12.80	0.5039	101.0	151.0	12.80
A10012.9	–	12.90	0.5079	101.0	151.0	12.90
A10013.0	–	13.00	0.5118	101.0	151.0	13.00
A10033/64	33/64	13.10	0.5156	101.0	151.0	13.10

Product	DC	DC	DC	LCF	OAL	DCON MS
	(inch)	(mm)	(inch)	(mm)	(mm)	(mm)
A10013.1	–	13.10	0.5157	101.0	151.0	13.10
A10013.2	–	13.20	0.5197	101.0	151.0	13.20
A10013.25	–	13.25	0.5217	108.0	160.0	13.25
A10013.3	–	13.30	0.5236	108.0	160.0	13.30
A10013.4	–	13.40	0.5276	108.0	160.0	13.40
A10017/32	17/32	13.49	0.5313	108.0	160.0	13.49
A10013.5	–	13.50	0.5315	108.0	160.0	13.50
A10013.6	–	13.60	0.5354	108.0	160.0	13.60
A10013.7	–	13.70	0.5394	108.0	160.0	13.70
A10013.75	–	13.75	0.5413	108.0	160.0	13.75
A10013.8	–	13.80	0.5433	108.0	160.0	13.80
A10035/64	35/64	13.89	0.5469	108.0	160.0	13.89
A10013.9	–	13.90	0.5472	108.0	160.0	13.90
A10014.0	–	14.00	0.5512	108.0	160.0	14.00
A10014.25	–	14.25	0.5610	114.0	169.0	14.25
A1009/16	9/16	14.29	0.5625	114.0	169.0	14.29
A10014.5	–	14.50	0.5709	114.0	169.0	14.50
A10037/64	37/64	14.68	0.5781	114.0	169.0	14.68
A10014.75	–	14.75	0.5807	114.0	169.0	14.75
A10015.0	–	15.00	0.5906	114.0	169.0	15.00
A10019/32	19/32	15.08	0.5938	120.0	178.0	15.08
A10015.25	–	15.25	0.6004	120.0	178.0	15.25
A10039/64	39/64	15.48	0.6094	120.0	178.0	15.48
A10015.5	–	15.50	0.6102	120.0	178.0	15.50
A10015.75	–	15.75	0.6201	120.0	178.0	15.75
A1005/8	5/8	15.88	0.6250	120.0	178.0	15.88
A10016.0	–	16.00	0.6299	120.0	178.0	16.00
A10041/64	41/64	16.27	0.6406	125.0	184.0	16.27
A10016.5	–	16.50	0.6496	125.0	184.0	16.50
A10021/32	21/32	16.67	0.6563	125.0	184.0	16.67
A10017.0	–	17.00	0.6693	125.0	184.0	17.00
A10043/64	43/64	17.07	0.6719	130.0	191.0	17.07
A10011/16	11/16	17.46	0.6875	130.0	191.0	17.46
A10017.5	–	17.50	0.6890	130.0	191.0	17.50
A10018.0	–	18.00	0.7087	130.0	191.0	18.00
A10018.5	–	18.50	0.7283	135.0	198.0	18.50
A10019.0	–	19.00	0.7480	135.0	198.0	19.00
A10019.5	–	19.50	0.7677	140.0	205.0	19.50
A10020.0	–	20.00	0.7874	140.0	205.0	20.00



A101



HSS spiraalboor, DIN338, stoomontlaten, links snijdend

Een precisie geslepen, veelzijdige linksdraaiende boor met een 118° conventionele punt, die stabiliteit geeft en gemakkelijk naslijpbaar is, waardoor hij zeer economisch is. Bruikbaar voor hand en stationaire machines. De stoomontlaten afwerking houdt snijvloeistof vast en voorkomt het aanlassen van spanen. Geschikt voor vele materialen.

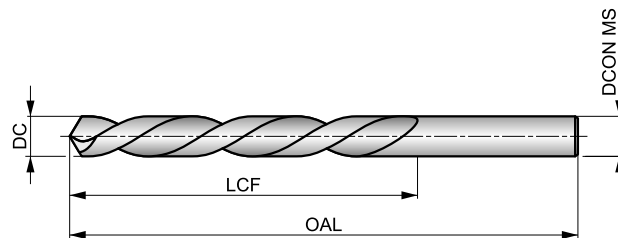

HSS	DIN 338	4xD
118°	ST	
20-35°	L	DC h8

De tabel geeft de geschiktheid aan voor de materiaalgroep en de startwaarden voor de snijsnelheid (m/min) en de letter verwijst naar de toe te passen voeding (fn), zie vanaf pagina 175.

P1.1 ■ 33 H	P1.2 ■ 37 H	P1.3 ■ 38 H	P2.1 ■ 28 H	P2.2 ■ 25 F	P2.3 ■ 22 E	P3.1 ■ 19 F	P3.2 ■ 15 F	P3.3 ■ 13 E	P4.1 ■ 11 F	P4.2 ■ 10 E	P4.3 ■ 8 D	M1.1 ■ 21 E	M1.2 ■ 17 E
M2.1 ■ 18 E	M2.2 ■ 15 E	M3.1 ■ 9 G	M3.2 ■ 8 G	M3.3 ■ 7 G	M4.1 ■ 9 C	K1.1 ■ 30 H	K1.2 ■ 22 F	K1.3 ■ 17 F	K2.1 ■ 25 E	K2.2 ■ 20 E	K2.3 ■ 16 E	K3.1 ■ 22 E	K3.2 ■ 17 E
K3.3 ■ 13 E	K4.1 ■ 20 E	K4.2 ■ 15 E	K4.3 ■ 11 E	K4.4 ■ 10 E	K4.5 ■ 8 E	K5.1 ■ 23 E	K5.2 ■ 17 E	K5.3 ■ 13 E	N1.1 ■ 33 J	N1.2 ■ 25 J	N1.3 ■ 17 I	N2.1 ■ 42 H	N2.2 ■ 37 H
N2.3 ■ 27 H	N3.1 ■ 59 H	N3.2 ■ 35 I	N3.3 ■ 18 G	N4.1 ■ 30 J	N4.2 ■ 28 H	N4.3 ■ 14 F	S1.1 ■ 23 E	S1.2 ■ 12 D	S1.3 ■ 6 B	S2.1 ■ 8 E	S2.2 ■ 4 A	S3.1 ■ 6 E	S3.2 ■ 3 A
S4.1 ■ 5 E	S4.2 ■ 2 A												

DC <= 3mm blank.

Product	DC (mm)	DC (inch)	LCF (mm)	OAL (mm)	DCON MS (mm)	Product	DC (mm)	DC (inch)	LCF (mm)	OAL (mm)	DCON MS (mm)
A1011.0	1.00	0.0394	12.0	34.0	1.00	A1013.2	3.20	0.1260	36.0	65.0	3.20
A1011.1	1.10	0.0433	14.0	36.0	1.10	A1013.3	3.30	0.1299	36.0	65.0	3.30
A1011.2	1.20	0.0472	16.0	38.0	1.20	A1013.5	3.50	0.1378	39.0	70.0	3.50
A1011.25	1.25	0.0492	16.0	38.0	1.25	A1013.8	3.80	0.1496	43.0	75.0	3.80
A1011.3	1.30	0.0512	16.0	38.0	1.30	A1014.0	4.00	0.1575	43.0	75.0	4.00
A1011.4	1.40	0.0551	18.0	40.0	1.40	A1014.2	4.20	0.1654	43.0	75.0	4.20
A1011.5	1.50	0.0591	18.0	40.0	1.50	A1014.5	4.50	0.1772	47.0	80.0	4.50
A1011.6	1.60	0.0630	20.0	43.0	1.60	A1014.8	4.80	0.1890	52.0	86.0	4.80
A1011.7	1.70	0.0669	20.0	43.0	1.70	A1015.0	5.00	0.1969	52.0	86.0	5.00
A1011.8	1.80	0.0709	22.0	46.0	1.80	A1015.1	5.10	0.2008	52.0	86.0	5.10
A1011.9	1.90	0.0748	22.0	46.0	1.90	A1015.2	5.20	0.2047	52.0	86.0	5.20
A1012.0	2.00	0.0787	24.0	49.0	2.00	A1015.5	5.50	0.2165	57.0	93.0	5.50
A1012.1	2.10	0.0827	24.0	49.0	2.10	A1016.0	6.00	0.2362	57.0	93.0	6.00
A1012.2	2.20	0.0866	27.0	53.0	2.20	A1016.5	6.50	0.2559	63.0	101.0	6.50
A1012.3	2.30	0.0906	27.0	53.0	2.30	A1017.0	7.00	0.2756	69.0	109.0	7.00
A1012.4	2.40	0.0945	30.0	57.0	2.40	A1017.5	7.50	0.2953	69.0	109.0	7.50
A1012.5	2.50	0.0984	30.0	57.0	2.50	A1018.0	8.00	0.3150	75.0	117.0	8.00
A1012.6	2.60	0.1024	30.0	57.0	2.60	A1018.5	8.50	0.3346	75.0	117.0	8.50
A1012.7	2.70	0.1063	33.0	61.0	2.70	A1019.0	9.00	0.3543	81.0	125.0	9.00
A1012.8	2.80	0.1102	33.0	61.0	2.80	A10110.0	10.00	0.3937	87.0	133.0	10.00
A1012.9	2.90	0.1142	33.0	61.0	2.90	A10111.0	11.00	0.4331	94.0	142.0	11.00
A1013.0	3.00	0.1181	33.0	61.0	3.00	A10112.0	12.00	0.4724	101.0	151.0	12.00



A108



HSS VA spiraalboor, DIN338, stoomontlaten, voor roestvast staal

Eerste keus bij het boren van roestvast staal uit de hand, maar ook effectief in stationaire machines. De split point van 135° helpt bij het zelfcentreren en vermindert de snijkrachten. Speciale extra scherpe geometrie van de snijkanten zorgt voor unieke en ongeëvenaarde boorervaring in roestvaste staalsoorten. De stoomontlaten afwerking helpt voorkomen dat werkstukmateriaal aan de snijkant blijft kleven.

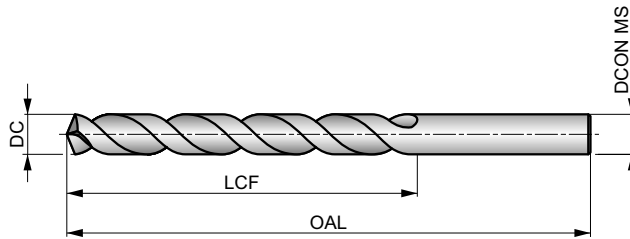

HSS	DIN 338	4xD
135°	ST	
λ > 35°	R	DC h8

De tabel geeft de geschiktheid aan voor de materiaalgroep en de startwaarden voor de snijsnelheid (m/min) en de letter verwijst naar de toe te passen voeding (fn), zie vanaf pagina 175.

P1.1 33 I	P1.2 37 I	P1.3 38 I	P2.1 28 I	P2.2 25 G	P2.3 22 E	P3.1 19 F	P3.2 15 F	P3.3 13 E	P4.1 11 F	P4.2 10 E	P4.3 8 D	M1.1 21 E	M1.2 17 E
M2.1 18 E	M2.2 15 E	M3.1 10 G	M3.2 9 G	M3.3 8 G	M4.1 10 D	K1.1 30 H	K1.2 22 F	K1.3 17 F	K2.1 25 E	K2.2 20 E	K2.3 16 E	K3.1 22 E	K3.2 17 E
K3.3 13 E	K4.1 20 E	K4.2 15 E	K4.3 11 E	K4.4 10 E	K4.5 8 E	K5.1 23 E	K5.2 17 E	K5.3 13 E	N1.1 33 J	N1.2 25 J	N1.3 17 I	N2.1 42 H	N2.2 37 H
N2.3 27 H	N3.1 59 H	N3.2 35 I	N3.3 18 G	N4.1 30 J	N4.2 28 H	N4.3 14 F	S1.1 25 G	S1.2 16 E	S1.3 7 B	S2.1 9 G	S2.2 8 E	S3.1 7 G	S3.2 6 E
S4.1 5 G	S4.2 5 E												

DC > 1.5mm (1/16") split point.

Deze producten zijn ook in een set verkrijgbaar. Zie A188.

Product	DC (inch)	DC (mm)	DC (inch)	LCF (mm)	OAL (mm)	DCON MS (mm)
A1081.0	—	1.00	0.0394	12.0	34.0	1.00
A1081.1	—	1.10	0.0433	14.0	36.0	1.10
A1081.2	—	1.20	0.0472	16.0	38.0	1.20
A1081.3	—	1.30	0.0512	16.0	38.0	1.30
A1081.4	—	1.40	0.0551	18.0	40.0	1.40
A1081.5	—	1.50	0.0591	18.0	40.0	1.50
A1081/16	1/16	1.59	0.0625	20.0	43.0	1.59
A1081.6	—	1.60	0.0630	20.0	43.0	1.60
A1081.7	—	1.70	0.0669	20.0	43.0	1.70
A1081.8	—	1.80	0.0709	22.0	46.0	1.80
A1081.9	—	1.90	0.0748	22.0	46.0	1.90
A1085/64	5/64	1.98	0.0781	24.0	49.0	1.98
A1082.0	—	2.00	0.0787	24.0	49.0	2.00
A1082.1	—	2.10	0.0827	24.0	49.0	2.10
A1082.2	—	2.20	0.0866	27.0	53.0	2.20
A1082.3	—	2.30	0.0906	27.0	53.0	2.30
A1083/32	3/32	2.38	0.0938	30.0	57.0	2.38
A1082.4	—	2.40	0.0945	30.0	57.0	2.40
A1082.5	—	2.50	0.0984	30.0	57.0	2.50
A1082.6	—	2.60	0.1024	30.0	57.0	2.60
A1082.7	—	2.70	0.1063	33.0	61.0	2.70
A1087/64	7/64	2.78	0.1094	33.0	61.0	2.78

Product	DC (inch)	DC (mm)	DC (inch)	LCF (mm)	OAL (mm)	DCON MS (mm)
A1082.8	—	2.80	0.1102	33.0	61.0	2.80
A1082.9	—	2.90	0.1142	33.0	61.0	2.90
A1083.0	—	3.00	0.1181	33.0	61.0	3.00
A1083.1	—	3.10	0.1220	36.0	65.0	3.10
A1081/8	1/8	3.18	0.1250	36.0	65.0	3.18
A1083.2	—	3.20	0.1260	36.0	65.0	3.20
A1083.3	—	3.30	0.1299	36.0	65.0	3.30
A1083.4	—	3.40	0.1339	39.0	70.0	3.40
A1083.5	—	3.50	0.1378	39.0	70.0	3.50
A1089/64	9/64	3.57	0.1406	39.0	70.0	3.57
A1083.6	—	3.60	0.1417	39.0	70.0	3.60
A1083.7	—	3.70	0.1457	39.0	70.0	3.70
A1083.8	—	3.80	0.1496	43.0	75.0	3.80
A1083.9	—	3.90	0.1535	43.0	75.0	3.90
A1085/32	5/32	3.97	0.1563	43.0	75.0	3.97
A1084.0	—	4.00	0.1575	43.0	75.0	4.00
A1084.1	—	4.10	0.1614	43.0	75.0	4.10
A1084.2	—	4.20	0.1654	43.0	75.0	4.20
A1084.3	—	4.30	0.1693	47.0	80.0	4.30
A10811/64	11/64	4.37	0.1719	47.0	80.0	4.37
A1084.4	—	4.40	0.1732	47.0	80.0	4.40
A1084.5	—	4.50	0.1772	47.0	80.0	4.50



Product	DC	DC	DC	LCF	OAL	D CON MS
	(inch)	(mm)	(inch)	(mm)	(mm)	(mm)
A1084.6	–	4.60	0.1811	47.0	80.0	4.60
A1084.7	–	4.70	0.1850	47.0	80.0	4.70
A1083/16	3/16	4.76	0.1875	52.0	86.0	4.76
A1084.8	–	4.80	0.1890	52.0	86.0	4.80
A1084.9	–	4.90	0.1929	52.0	86.0	4.90
A108N10	N10	4.92	0.1935	52.0	86.0	4.92
A1085.0	–	5.00	0.1969	52.0	86.0	5.00
A1085.1	–	5.10	0.2008	52.0	86.0	5.10
A10813/64	13/64	5.16	0.2031	52.0	86.0	5.16
A1085.2	–	5.20	0.2047	52.0	86.0	5.20
A1085.3	–	5.30	0.2087	52.0	86.0	5.30
A1085.4	–	5.40	0.2126	57.0	93.0	5.40
A1085.5	–	5.50	0.2165	57.0	93.0	5.50
A1087/32	7/32	5.56	0.2188	57.0	93.0	5.56
A1085.6	–	5.60	0.2205	57.0	93.0	5.60
A1085.7	–	5.70	0.2244	57.0	93.0	5.70
A1085.8	–	5.80	0.2283	57.0	93.0	5.80
A1085.9	–	5.90	0.2323	57.0	93.0	5.90
A10815/64	15/64	5.95	0.2344	57.0	93.0	5.95
A1086.0	–	6.00	0.2362	57.0	93.0	6.00
A1086.1	–	6.10	0.2402	63.0	101.0	6.10
A1086.2	–	6.20	0.2441	63.0	101.0	6.20
A1086.3	–	6.30	0.2480	63.0	101.0	6.30
A1081/4	1/4	6.35	0.2500	63.0	101.0	6.35
A1086.4	–	6.40	0.2520	63.0	101.0	6.40
A1086.5	–	6.50	0.2559	63.0	101.0	6.50
A1086.6	–	6.60	0.2598	63.0	101.0	6.60
A1086.7	–	6.70	0.2638	63.0	101.0	6.70
A10817/64	17/64	6.75	0.2656	69.0	109.0	6.75
A1086.8	–	6.80	0.2677	69.0	109.0	6.80
A1086.9	–	6.90	0.2717	69.0	109.0	6.90
A1087.0	–	7.00	0.2756	69.0	109.0	7.00
A1087.1	–	7.10	0.2795	69.0	109.0	7.10
A1089/32	9/32	7.14	0.2813	69.0	109.0	7.14
A1087.2	–	7.20	0.2835	69.0	109.0	7.20
A1087.3	–	7.30	0.2874	69.0	109.0	7.30
A1087.4	–	7.40	0.2913	69.0	109.0	7.40
A1087.5	–	7.50	0.2953	69.0	109.0	7.50
A10819/64	19/64	7.54	0.2969	75.0	117.0	7.54
A1087.6	–	7.60	0.2992	75.0	117.0	7.60
A1087.7	–	7.70	0.3031	75.0	117.0	7.70
A1087.8	–	7.80	0.3071	75.0	117.0	7.80
A1087.9	–	7.90	0.3110	75.0	117.0	7.90
A1085/16	5/16	7.94	0.3125	75.0	117.0	7.94
A1088.0	–	8.00	0.3150	75.0	117.0	8.00
A1088.1	–	8.10	0.3189	75.0	117.0	8.10
A1088.2	–	8.20	0.3228	75.0	117.0	8.20
A1088.3	–	8.30	0.3268	75.0	117.0	8.30

Product	DC	DC	DC	LCF	OAL	D CON MS
	(inch)	(mm)	(inch)	(mm)	(mm)	(mm)
A10821/64	21/64	8.33	0.3281	75.0	117.0	8.33
A1088.4	–	8.40	0.3307	75.0	117.0	8.40
A1088.5	–	8.50	0.3346	75.0	117.0	8.50
A1088.6	–	8.60	0.3386	81.0	125.0	8.60
A1088.7	–	8.70	0.3425	81.0	125.0	8.70
A10811/32	11/32	8.73	0.3438	81.0	125.0	8.73
A1088.8	–	8.80	0.3465	81.0	125.0	8.80
A1088.9	–	8.90	0.3504	81.0	125.0	8.90
A1089.0	–	9.00	0.3543	81.0	125.0	9.00
A1089.1	–	9.10	0.3583	81.0	125.0	9.10
A10823/64	23/64	9.13	0.3594	81.0	125.0	9.13
A1089.2	–	9.20	0.3622	81.0	125.0	9.20
A1089.3	–	9.30	0.3661	81.0	125.0	9.30
A1089.4	–	9.40	0.3701	81.0	125.0	9.40
A1089.5	–	9.50	0.3740	81.0	125.0	9.50
A1083/8	3/8	9.52	0.3750	87.0	133.0	9.52
A1089.6	–	9.60	0.3780	87.0	133.0	9.60
A1089.7	–	9.70	0.3819	87.0	133.0	9.70
A1089.8	–	9.80	0.3858	87.0	133.0	9.80
A1089.9	–	9.90	0.3898	87.0	133.0	9.90
A10825/64	25/64	9.92	0.3906	87.0	133.0	9.92
A10810.0	–	10.00	0.3937	87.0	133.0	10.00
A10810.2	–	10.20	0.4016	87.0	133.0	10.20
A10813/32	13/32	10.32	0.4063	87.0	133.0	10.32
A10810.5	–	10.50	0.4134	87.0	133.0	10.50
A10827/64	27/64	10.72	0.4219	94.0	142.0	10.72
A10810.8	–	10.80	0.4252	94.0	142.0	10.80
A10811.0	–	11.00	0.4331	94.0	142.0	11.00
A1087/16	7/16	11.11	0.4375	94.0	142.0	11.11
A10811.5	–	11.50	0.4528	94.0	142.0	11.50
A10829/64	29/64	11.51	0.4531	94.0	142.0	11.51
A10811.8	–	11.80	0.4646	94.0	142.0	11.80
A10815/32	15/32	11.91	0.4688	101.0	151.0	11.91
A10812.0	–	12.00	0.4724	101.0	151.0	12.00
A10812.2	–	12.20	0.4803	101.0	151.0	12.20
A10831/64	31/64	12.30	0.4844	101.0	151.0	12.30
A10812.5	–	12.50	0.4921	101.0	151.0	12.50
A1081/2	1/2	12.70	0.5000	101.0	151.0	12.70
A10812.8	–	12.80	0.5039	101.0	151.0	12.80
A10812.9	–	12.90	0.5079	101.0	151.0	12.90
A10813.0	–	13.00	0.5118	101.0	151.0	13.00
A10813.5	–	13.50	0.5315	108.0	160.0	13.50
A10814.0	–	14.00	0.5512	108.0	160.0	14.00
A10814.5	–	14.50	0.5709	114.0	169.0	14.50
A10815.0	–	15.00	0.5906	114.0	169.0	15.00
A10815.25	–	15.25	0.6004	120.0	178.0	15.25
A10815.5	–	15.50	0.6102	120.0	178.0	15.50
A10816.0	–	16.00	0.6299	120.0	178.0	16.00



A147



HSS-E (5% Co), korte spiraalboor, DIN338, voor roestvast staal

Veelzijdige en goed presterende boor voor het machinaal boren van roestvast staal. Maar ook kan eventueel ook worden gebruikt voor handmatige bewerkingen. Een 130° gespleten punt helpt bij het zelfcentreren van de boor en vermindert de snijkrachten.

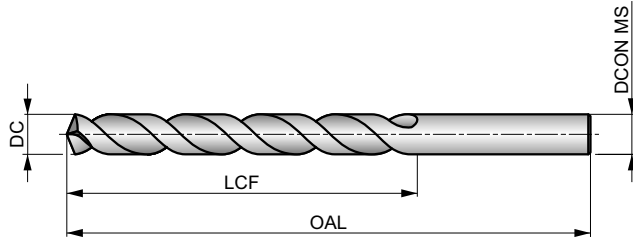

HSS-E	DIN 338	4xD
130°	Bright	
VA	R	DC h8

De tabel geeft de geschiktheid aan voor de materiaalgroep en de startwaarden voor de snijsnelheid (m/min) en de letter verwijst naar de toe te passen voeding (fn), zie vanaf pagina 175.

P1.1 33 I	P1.2 37 I	P1.3 38 I	P2.1 28 I	P2.2 25 G	P2.3 22 E	P3.1 19 F	P3.2 15 F	P3.3 13 E	P4.1 11 F	P4.2 10 E	P4.3 8 D	M1.1 21 E	M1.2 17 E
M2.1 18 E	M2.2 15 E	M2.3 13 B	M3.1 10 G	M3.2 9 G	M3.3 8 G	M4.1 10 D	M4.2 9 B	K1.1 30 H	K1.2 22 F	K1.3 17 F	K2.1 25 E	K2.2 20 E	K2.3 16 E
K3.1 22 E	K3.2 17 E	K3.3 13 E	K4.1 20 E	K4.2 15 E	K4.3 11 E	K4.4 10 E	K4.5 8 E	K5.1 23 E	K5.2 17 E	K5.3 13 E	N1.1 33 J	N1.2 25 J	N1.3 17 I
N2.1 42 H	N2.2 37 H	N2.3 27 H	N3.1 59 H	N3.2 35 I	N3.3 18 G	N4.1 30 J	N4.2 28 H	N4.3 14 F	S1.1 25 G	S1.2 16 E	S1.3 7 B	S2.1 9 G	S2.2 8 E
S3.1 7 G	S3.2 6 E	S4.1 5 G	S4.2 5 E										

Product	DC (inch)	DC (mm)	DC (inch)	LCF (mm)	OAL (mm)	DCON MS (mm)
A147.3	-	0.30	0.0118	3.0	19.0	0.30
A147.4	-	0.40	0.0157	5.0	20.0	0.40
A147.5	-	0.50	0.0197	6.0	22.0	0.50
A147.6	-	0.60	0.0236	7.0	24.0	0.60
A147.7	-	0.70	0.0276	9.0	28.0	0.70
A147.8	-	0.80	0.0315	10.0	30.0	0.80
A147.9	-	0.90	0.0354	11.0	32.0	0.90
A1471.0	-	1.00	0.0394	12.0	34.0	1.00
A1471.1	-	1.10	0.0433	14.0	36.0	1.10
A1471.2	-	1.20	0.0472	16.0	38.0	1.20
A1471.3	-	1.30	0.0512	16.0	38.0	1.30
A1471.4	-	1.40	0.0551	18.0	40.0	1.40
A1471.5	-	1.50	0.0591	18.0	40.0	1.50
A1471/16	1/16	1.59	0.0625	20.0	43.0	1.59
A1471.6	-	1.60	0.0630	20.0	43.0	1.60
A1471.7	-	1.70	0.0669	20.0	43.0	1.70
A1471.8	-	1.80	0.0709	22.0	46.0	1.80
A1471.9	-	1.90	0.0748	22.0	46.0	1.90
A1472.0	-	2.00	0.0787	24.0	49.0	2.00
A1472.1	-	2.10	0.0827	24.0	49.0	2.10
A1472.2	-	2.20	0.0866	27.0	53.0	2.20
A1472.3	-	2.30	0.0906	27.0	53.0	2.30
A1473/32	3/32	2.38	0.0938	30.0	57.0	2.38
A1472.4	-	2.40	0.0945	30.0	57.0	2.40

Product	DC (inch)	DC (mm)	DC (inch)	LCF (mm)	OAL (mm)	DCON MS (mm)
A1472.5	-	2.50	0.0984	30.0	57.0	2.50
A1472.6	-	2.60	0.1024	30.0	57.0	2.60
A1472.7	-	2.70	0.1063	33.0	61.0	2.70
A1472.8	-	2.80	0.1102	33.0	61.0	2.80
A1472.9	-	2.90	0.1142	33.0	61.0	2.90
A1473.0	-	3.00	0.1181	33.0	61.0	3.00
A1473.1	-	3.10	0.1220	36.0	65.0	3.10
A1471/8	1/8	3.18	0.1250	36.0	65.0	3.18
A1473.2	-	3.20	0.1260	36.0	65.0	3.20
A1473.3	-	3.30	0.1299	36.0	65.0	3.30
A1473.4	-	3.40	0.1339	39.0	70.0	3.40
A1473.5	-	3.50	0.1378	39.0	70.0	3.50
A1473.6	-	3.60	0.1417	39.0	70.0	3.60
A1473.7	-	3.70	0.1457	39.0	70.0	3.70
A1473.8	-	3.80	0.1496	43.0	75.0	3.80
A1473.9	-	3.90	0.1535	43.0	75.0	3.90
A1475/32	5/32	3.97	0.1563	43.0	75.0	3.97
A1474.0	-	4.00	0.1575	43.0	75.0	4.00
A1474.1	-	4.10	0.1614	43.0	75.0	4.10
A1474.2	-	4.20	0.1654	43.0	75.0	4.20
A1474.3	-	4.30	0.1693	47.0	80.0	4.30
A1474.4	-	4.40	0.1732	47.0	80.0	4.40
A1474.5	-	4.50	0.1772	47.0	80.0	4.50
A1474.6	-	4.60	0.1811	47.0	80.0	4.60



Product	DC	DC	DC	LCF	OAL	DCON MS
	(inch)	(mm)	(inch)	(mm)	(mm)	(mm)
A1474.7	–	4.70	0.1850	47.0	80.0	4.70
A1473/16	3/16	4.76	0.1875	52.0	86.0	4.76
A1474.8	–	4.80	0.1890	52.0	86.0	4.80
A1474.9	–	4.90	0.1929	52.0	86.0	4.90
A1475.0	–	5.00	0.1969	52.0	86.0	5.00
A1475.1	–	5.10	0.2008	52.0	86.0	5.10
A1475.2	–	5.20	0.2047	52.0	86.0	5.20
A1475.3	–	5.30	0.2087	52.0	86.0	5.30
A1475.4	–	5.40	0.2126	57.0	93.0	5.40
A1475.5	–	5.50	0.2165	57.0	93.0	5.50
A1475.6	–	5.60	0.2205	57.0	93.0	5.60
A1475.7	–	5.70	0.2244	57.0	93.0	5.70
A1475.8	–	5.80	0.2283	57.0	93.0	5.80
A1475.9	–	5.90	0.2323	57.0	93.0	5.90
A1476.0	–	6.00	0.2362	57.0	93.0	6.00
A1476.1	–	6.10	0.2402	63.0	101.0	6.10
A1476.2	–	6.20	0.2441	63.0	101.0	6.20
A1476.3	–	6.30	0.2480	63.0	101.0	6.30
A1471/4	1/4	6.35	0.2500	63.0	101.0	6.35
A1476.4	–	6.40	0.2520	63.0	101.0	6.40
A1476.5	–	6.50	0.2559	63.0	101.0	6.50
A1476.6	–	6.60	0.2598	63.0	101.0	6.60
A1476.7	–	6.70	0.2638	63.0	101.0	6.70
A1476.8	–	6.80	0.2677	69.0	109.0	6.80
A1476.9	–	6.90	0.2717	69.0	109.0	6.90
A1477.0	–	7.00	0.2756	69.0	109.0	7.00
A1477.1	–	7.10	0.2795	69.0	109.0	7.10
A1477.2	–	7.20	0.2835	69.0	109.0	7.20
A1477.3	–	7.30	0.2874	69.0	109.0	7.30
A1477.4	–	7.40	0.2913	69.0	109.0	7.40
A1477.5	–	7.50	0.2953	69.0	109.0	7.50
A1477.6	–	7.60	0.2992	75.0	117.0	7.60
A1477.7	–	7.70	0.3031	75.0	117.0	7.70
A1477.8	–	7.80	0.3071	75.0	117.0	7.80

Product	DC	DC	DC	LCF	OAL	DCON MS
	(inch)	(mm)	(inch)	(mm)	(mm)	(mm)
A1477.9	–	7.90	0.3110	75.0	117.0	7.90
A1478.0	–	8.00	0.3150	75.0	117.0	8.00
A1478.1	–	8.10	0.3189	75.0	117.0	8.10
A1478.2	–	8.20	0.3228	75.0	117.0	8.20
A1478.3	–	8.30	0.3268	75.0	117.0	8.30
A1478.4	–	8.40	0.3307	75.0	117.0	8.40
A1478.5	–	8.50	0.3346	75.0	117.0	8.50
A1478.6	–	8.60	0.3386	81.0	125.0	8.60
A1478.7	–	8.70	0.3425	81.0	125.0	8.70
A1478.8	–	8.80	0.3465	81.0	125.0	8.80
A1478.9	–	8.90	0.3504	81.0	125.0	8.90
A1479.0	–	9.00	0.3543	81.0	125.0	9.00
A1479.1	–	9.10	0.3583	81.0	125.0	9.10
A1479.2	–	9.20	0.3622	81.0	125.0	9.20
A1479.3	–	9.30	0.3661	81.0	125.0	9.30
A1479.4	–	9.40	0.3701	81.0	125.0	9.40
A1479.5	–	9.50	0.3740	81.0	125.0	9.50
A1479.6	–	9.60	0.3780	87.0	133.0	9.60
A1479.7	–	9.70	0.3819	87.0	133.0	9.70
A1479.8	–	9.80	0.3858	87.0	133.0	9.80
A1479.9	–	9.90	0.3898	87.0	133.0	9.90
A14710.0	–	10.00	0.3937	87.0	133.0	10.00
A14710.2	–	10.20	0.4016	87.0	133.0	10.20
A14710.5	–	10.50	0.4134	87.0	133.0	10.50
A14711.0	–	11.00	0.4331	94.0	142.0	11.00
A14711.2	–	11.20	0.4409	94.0	142.0	11.20
A14711.5	–	11.50	0.4528	94.0	142.0	11.50
A14712.0	–	12.00	0.4724	101.0	151.0	12.00
A14712.5	–	12.50	0.4921	101.0	151.0	12.50
A14713.0	–	13.00	0.5118	101.0	151.0	13.00
A14713.5	–	13.50	0.5315	108.0	160.0	13.50
A14714.0	–	14.00	0.5512	108.0	160.0	14.00
A14714.5	–	14.50	0.5709	114.0	169.0	14.50
A14715.0	–	15.00	0.5906	114.0	169.0	15.00



A777



HSS-E (8% Co) spiraalboor, bronskleurig

Heavy Duty spiraalboor voor het boren in materialen met een hoge treksterkte. De 135° splitpoint helpt bij het zelfcentreren. De bronzen afwerking is een dunne oxide-laag die zich vormt op het oppervlak van het gereedschap en is een indicatie voor 8% Cobalt HSS-E Boor.

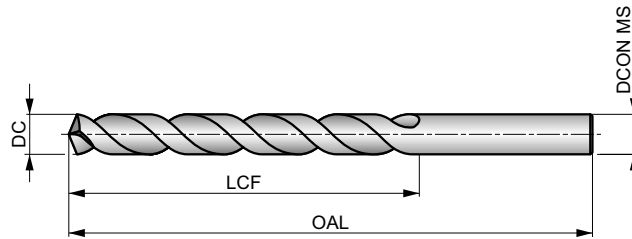

HSS-E	DIN 338	4xD
135°	Bronze	
λ 20-35°	R	DC h8

De tabel geeft de geschiktheid aan voor de materiaalgroep en de startwaarden voor de snijsnelheid (m/min) en de letter verwijst naar de toe te passen voeding (fn), zie vanaf pagina 175.

P1.1 ■36 H	P1.2 ■40 H	P1.3 ■41 H	P2.1 ■31 H	P2.2 ■27 G	P2.3 ■24 E	P3.1 ■25 F	P3.2 ■20 F	P3.3 ■17 E	P4.1 ■15 F	P4.2 ■13 E	P4.3 ■10 D	M1.1 ■30 E	M1.2 ■26 E
M2.1 ■27 E	M2.2 ■22 E	M3.1 ■13 G	M3.2 ■11 G	M3.3 ■10 G	M4.1 ■15 C	K1.1 ■35 H	K1.2 ■26 D	K1.3 ■19 D	K2.1 ■27 E	K2.2 ■22 E	K2.3 ■18 E	K3.1 ■24 E	K3.2 ■18 E
K3.3 ■15 E	K4.1 ■22 E	K4.2 ■17 E	K4.3 ■12 E	K4.4 ■11 E	K4.5 ■9 E	K5.1 ■25 E	K5.2 ■19 E	K5.3 ■15 E	N1.1 ■33 J	N1.2 ■25 J	N1.3 ■17 I	N2.1 ■46 H	N2.2 ■42 H
N2.3 ■30 H	N3.1 ■68 H	N3.2 ■40 F	N3.3 ■20 H	S1.1 ■28 F	S1.2 ■20 D	S1.3 ■11 C	S2.1 ■9 E	S2.2 ■8 B	S3.1 ■7 E	S3.2 ■6 B	S4.1 ■5 E	S4.2 ■5 B	

NAS907J. DC <= 1.4mm viervlaks punt.
Deze producten zijn ook in een set verkrijgbaar. Zie A295.

Product	DC (inch)	DC (mm)	DC (inch)	LCF (mm)	OAL (mm)	DCON MS (mm)
A777.3	-	0.30	0.0118	3.0	19.0	0.30
A777.35	-	0.35	0.0138	4.0	19.0	0.35
A777.4	-	0.40	0.0157	5.0	20.0	0.40
A777.45	-	0.45	0.0177	5.0	20.0	0.45
A777.5	-	0.50	0.0197	6.0	22.0	0.50
A777.55	-	0.55	0.0217	7.0	24.0	0.55
A777.6	-	0.60	0.0236	7.0	24.0	0.60
A777.65	-	0.65	0.0256	8.0	26.0	0.65
A777.7	-	0.70	0.0276	9.0	28.0	0.70
A777.8	-	0.80	0.0315	10.0	30.0	0.80
A777.9	-	0.90	0.0354	11.0	32.0	0.90
A777.95	-	0.95	0.0374	11.0	32.0	0.95
A7771.0	-	1.00	0.0394	12.0	34.0	1.00
A7771.1	-	1.10	0.0433	14.0	36.0	1.10
A7771.2	-	1.20	0.0472	16.0	38.0	1.20
A7771.3	-	1.30	0.0512	16.0	38.0	1.30
A7771.4	-	1.40	0.0551	18.0	40.0	1.40
A7771.5	-	1.50	0.0591	18.0	40.0	1.50
A7771/16	1/16	1.59	0.0625	20.0	43.0	1.59
A7771.6	-	1.60	0.0630	20.0	43.0	1.60
A7771.7	-	1.70	0.0669	20.0	43.0	1.70
A7771.8	-	1.80	0.0709	22.0	46.0	1.80
A7771.9	-	1.90	0.0748	22.0	46.0	1.90
A7775/64	5/64	1.98	0.0781	24.0	49.0	1.98

Product	DC (inch)	DC (mm)	DC (inch)	LCF (mm)	OAL (mm)	DCON MS (mm)
A7772.0	-	2.00	0.0787	24.0	49.0	2.00
A7772.1	-	2.10	0.0827	24.0	49.0	2.10
A7772.2	-	2.20	0.0866	27.0	53.0	2.20
A7772.3	-	2.30	0.0906	27.0	53.0	2.30
A7773/32	3/32	2.38	0.0938	30.0	57.0	2.38
A7772.4	-	2.40	0.0945	30.0	57.0	2.40
A7772.5	-	2.50	0.0984	30.0	57.0	2.50
A7772.6	-	2.60	0.1024	30.0	57.0	2.60
A7772.7	-	2.70	0.1063	33.0	61.0	2.70
A7777/64	7/64	2.78	0.1094	33.0	61.0	2.78
A7772.8	-	2.80	0.1102	33.0	61.0	2.80
A7772.9	-	2.90	0.1142	33.0	61.0	2.90
A7773.0	-	3.00	0.1181	33.0	61.0	3.00
A7773.1	-	3.10	0.1220	36.0	65.0	3.10
A7771/8	1/8	3.18	0.1250	36.0	65.0	3.18
A7773.2	-	3.20	0.1260	36.0	65.0	3.20
A7773.3	-	3.30	0.1299	36.0	65.0	3.30
A7773.4	-	3.40	0.1339	39.0	70.0	3.40
A7773.5	-	3.50	0.1378	39.0	70.0	3.50
A7779/64	9/64	3.57	0.1406	39.0	70.0	3.57
A7773.6	-	3.60	0.1417	39.0	70.0	3.60
A7773.7	-	3.70	0.1457	39.0	70.0	3.70
A7773.8	-	3.80	0.1496	43.0	75.0	3.80
A7773.9	-	3.90	0.1535	43.0	75.0	3.90



Product	DC	DC	DC	LCF	OAL	D CON MS
	(inch)	(mm)	(inch)	(mm)	(mm)	(mm)
A7775/32	5/32	3.97	0.1563	43.0	75.0	3.97
A7774.0	–	4.00	0.1575	43.0	75.0	4.00
A7774.1	–	4.10	0.1614	43.0	75.0	4.10
A7774.2	–	4.20	0.1654	43.0	75.0	4.20
A7774.3	–	4.30	0.1693	47.0	80.0	4.30
A77711/64	11/64	4.37	0.1719	47.0	80.0	4.37
A7774.4	–	4.40	0.1732	47.0	80.0	4.40
A7774.5	–	4.50	0.1772	47.0	80.0	4.50
A7774.6	–	4.60	0.1811	47.0	80.0	4.60
A7774.7	–	4.70	0.1850	47.0	80.0	4.70
A7773/16	3/16	4.76	0.1875	52.0	86.0	4.76
A7774.8	–	4.80	0.1890	52.0	86.0	4.80
A7774.9	–	4.90	0.1929	52.0	86.0	4.90
A7775.0	–	5.00	0.1969	52.0	86.0	5.00
A7775.1	–	5.10	0.2008	52.0	86.0	5.10
A77713/64	13/64	5.16	0.2031	52.0	86.0	5.16
A7775.2	–	5.20	0.2047	52.0	86.0	5.20
A7775.3	–	5.30	0.2087	52.0	86.0	5.30
A7775.4	–	5.40	0.2126	57.0	93.0	5.40
A7775.5	–	5.50	0.2165	57.0	93.0	5.50
A7777/32	7/32	5.56	0.2188	57.0	93.0	5.56
A7775.6	–	5.60	0.2205	57.0	93.0	5.60
A7775.7	–	5.70	0.2244	57.0	93.0	5.70
A7775.8	–	5.80	0.2283	57.0	93.0	5.80
A7775.9	–	5.90	0.2323	57.0	93.0	5.90
A77715/64	15/64	5.95	0.2344	57.0	93.0	5.95
A7776.0	–	6.00	0.2362	57.0	93.0	6.00
A7776.1	–	6.10	0.2402	63.0	101.0	6.10
A7776.2	–	6.20	0.2441	63.0	101.0	6.20
A7776.3	–	6.30	0.2480	63.0	101.0	6.30
A7771/4	1/4	6.35	0.2500	63.0	101.0	6.35
A7776.4	–	6.40	0.2520	63.0	101.0	6.40
A7776.5	–	6.50	0.2559	63.0	101.0	6.50
A7776.6	–	6.60	0.2598	63.0	101.0	6.60
A7776.7	–	6.70	0.2638	63.0	101.0	6.70
A77717/64	17/64	6.75	0.2656	69.0	109.0	6.75
A7776.8	–	6.80	0.2677	69.0	109.0	6.80
A7776.9	–	6.90	0.2717	69.0	109.0	6.90
A7777.0	–	7.00	0.2756	69.0	109.0	7.00
A7777.1	–	7.10	0.2795	69.0	109.0	7.10
A7779/32	9/32	7.14	0.2813	69.0	109.0	7.14
A7777.2	–	7.20	0.2835	69.0	109.0	7.20
A7777.3	–	7.30	0.2874	69.0	109.0	7.30
A7777.4	–	7.40	0.2913	69.0	109.0	7.40
A7777.5	–	7.50	0.2953	69.0	109.0	7.50
A77719/64	19/64	7.54	0.2969	75.0	117.0	7.54
A7777.6	–	7.60	0.2992	75.0	117.0	7.60
A7777.7	–	7.70	0.3031	75.0	117.0	7.70
A7777.8	–	7.80	0.3071	75.0	117.0	7.80
A7777.9	–	7.90	0.3110	75.0	117.0	7.90
A7775/16	5/16	7.94	0.3125	75.0	117.0	7.94
A7778.0	–	8.00	0.3150	75.0	117.0	8.00

Product	DC	DC	DC	LCF	OAL	D CON MS
	(inch)	(mm)	(inch)	(mm)	(mm)	(mm)
A7778.1	–	8.10	0.3189	75.0	117.0	8.10
A7778.2	–	8.20	0.3228	75.0	117.0	8.20
A7778.3	–	8.30	0.3268	75.0	117.0	8.30
A77721/64	21/64	8.33	0.3281	75.0	117.0	8.33
A7778.4	–	8.40	0.3307	75.0	117.0	8.40
A7778.5	–	8.50	0.3346	75.0	117.0	8.50
A7778.6	–	8.60	0.3386	81.0	125.0	8.60
A7778.7	–	8.70	0.3425	81.0	125.0	8.70
A77711/32	11/32	8.73	0.3438	81.0	125.0	8.73
A7778.8	–	8.80	0.3465	81.0	125.0	8.80
A7778.9	–	8.90	0.3504	81.0	125.0	8.90
A7779.0	–	9.00	0.3543	81.0	125.0	9.00
A7779.1	–	9.10	0.3583	81.0	125.0	9.10
A77723/64	23/64	9.13	0.3594	81.0	125.0	9.13
A7779.2	–	9.20	0.3622	81.0	125.0	9.20
A7779.3	–	9.30	0.3661	81.0	125.0	9.30
A7779.4	–	9.40	0.3701	81.0	125.0	9.40
A7779.5	–	9.50	0.3740	81.0	125.0	9.50
A7773/8	3/8	9.52	0.3750	87.0	133.0	9.52
A7779.6	–	9.60	0.3780	87.0	133.0	9.60
A7779.7	–	9.70	0.3819	87.0	133.0	9.70
A7779.8	–	9.80	0.3858	87.0	133.0	9.80
A7779.9	–	9.90	0.3898	87.0	133.0	9.90
A77725/64	25/64	9.92	0.3906	87.0	133.0	9.92
A77710.0	–	10.00	0.3937	87.0	133.0	10.00
A77710.1	–	10.10	0.3976	87.0	133.0	10.10
A77710.2	–	10.20	0.4016	87.0	133.0	10.20
A77713/32	13/32	10.32	0.4063	87.0	133.0	10.32
A77710.5	–	10.50	0.4134	87.0	133.0	10.50
A77727/64	27/64	10.72	0.4219	94.0	142.0	10.72
A77710.8	–	10.80	0.4252	94.0	142.0	10.80
A77711.0	–	11.00	0.4331	94.0	142.0	11.00
A7777/16	7/16	11.11	0.4375	94.0	142.0	11.11
A77711.2	–	11.20	0.4409	94.0	142.0	11.20
A77711.5	–	11.50	0.4528	94.0	142.0	11.50
A77729/64	29/64	11.51	0.4531	94.0	142.0	11.51
A77711.8	–	11.80	0.4646	94.0	142.0	11.80
A77715/32	15/32	11.91	0.4688	101.0	151.0	11.91
A77712.0	–	12.00	0.4724	101.0	151.0	12.00
A77712.2	–	12.20	0.4803	101.0	151.0	12.20
A77731/64	31/64	12.30	0.4844	101.0	151.0	12.30
A77712.5	–	12.50	0.4921	101.0	151.0	12.50
A7771/2	1/2	12.70	0.5000	101.0	151.0	12.70
A77712.8	–	12.80	0.5039	101.0	151.0	12.80
A77713.0	–	13.00	0.5118	101.0	151.0	13.00
A77713.5	–	13.50	0.5315	108.0	160.0	13.50
A77714.0	–	14.00	0.5512	108.0	160.0	14.00
A77714.5	–	14.50	0.5709	114.0	169.0	14.50
A77715.0	–	15.00	0.5906	114.0	169.0	15.00
A77715.5	–	15.50	0.6102	120.0	178.0	15.50
A77716.0	–	16.00	0.6299	120.0	178.0	16.00



A160



HSS korte boor, HM gesoldeerde punt

De gesoldeerde hardmetalen punt geeft de hoge prestaties van een hardmetalen boor met een stabiel en minder bros HSS lichaam. Een 118°, 4-vlaks punt, helpt de zelfcentering waardoor het een economische keuze is. Kan gebruikt worden in zowel conventionele als CNC machines. De stoomontlaten afwerking houdt de snijvloeistof vast.

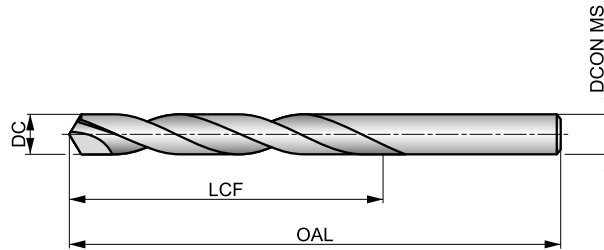

HSS HM	DIN 338	4xD
118°	Bright ST	
λ 20-35°	R	DC h8

De tabel geeft de geschiktheid aan voor de materiaalgroep en de startwaarden voor de snijnsnelheid (m/min) en de letter verwijst naar de toe te passen voeding (fn), zie vanaf pagina 175.

P1.1 ▣73 E	P1.2 ▣82 E	P1.3 ▣85 E	P2.1 ▣63 E	P2.2 ▣55 D	P2.3 ▣49 C	P3.1 ▣59 D	P3.2 ▣47 D	P3.3 ▣40 C	P4.1 ▣35 D	P4.2 ▣30 C	P4.3 ▣24 A	M1.1 ▣55 B	M1.2 ▣46 B
M2.1 ▣49 B	M2.2 ▣40 B	M3.1 ▣41 C	M3.2 ▣35 C	M3.3 ▣32 C	M4.1 ▣35 A	K1.1 ▣50 C	K1.2 ▣37 A	K1.3 ▣28 A	K2.1 ▣43 A	K2.2 ▣35 A	K2.3 ▣28 A	K3.1 ▣38 A	K3.2 ▣29 A
K3.3 ▣24 A	K4.1 ▣35 A	K4.2 ▣27 A	K4.3 ▣20 A	K4.4 ▣17 A	K4.5 ▣14 A	K5.1 ▣40 A	K5.2 ▣30 A	K5.3 ▣23 A	N1.1 ▣50 I	N1.2 ▣38 I	N1.3 ▣25 H	N2.1 ▣62 G	N2.2 ▣55 G
N2.3 ▣40 G	N3.1 ▣119 C	N3.2 ▣70 G	N3.3 ▣35 D	N4.2 ▣60 E	S1.1 ▣35 A	S1.2 ▣35 A	S1.3 ▣25 A	S2.1 ▣33 A	S2.2 ▣28 A	S3.1 ▣25 A	S3.2 ▣20 A	S4.1 ▣20 A	S4.2 ▣16 A

Product	DC	DC	LCF	OAL	DCON MS
	(mm)	(inch)			
A1604.0	4.00	0.1575	43.0	75.0	4.00
A1604.5	4.50	0.1772	47.0	80.0	4.50
A1605.0	5.00	0.1969	52.0	86.0	5.00
A1605.5	5.50	0.2165	57.0	93.0	5.50
A1606.0	6.00	0.2362	57.0	93.0	6.00
A1606.5	6.50	0.2559	63.0	101.0	6.50
A1606.8	6.80	0.2677	69.0	109.0	6.80
A1607.0	7.00	0.2756	69.0	109.0	7.00
A1607.5	7.50	0.2953	69.0	109.0	7.50
A1608.0	8.00	0.3150	75.0	117.0	8.00
A1608.5	8.50	0.3346	75.0	117.0	8.50
A1609.0	9.00	0.3543	81.0	125.0	9.00
A1609.5	9.50	0.3740	81.0	125.0	9.50
A16010.0	10.00	0.3937	87.0	133.0	10.00
A16010.2	10.20	0.4016	87.0	133.0	10.20
A16010.5	10.50	0.4134	87.0	133.0	10.50
A16011.0	11.00	0.4331	94.0	142.0	11.00
A16011.5	11.50	0.4528	94.0	142.0	11.50
A16012.0	12.00	0.4724	101.0	151.0	12.00
A16013.0	13.00	0.5118	101.0	151.0	13.00
A16014.0	14.00	0.5512	108.0	160.0	14.00
A16015.0	15.00	0.5906	114.0	169.0	15.00
A16016.0	16.00	0.6299	120.0	178.0	16.00



A510



ADX HSS productieboor, DIN338, TiN gecoat

Hoogproductieve spiraalboor voor het boren van nauwkeurige gaten (H9) bij hoge verspaningscondities. Met 130° tophoek en uitgedunde ziel zelfcenterend. In te zetten op stationaire machines met instelbare constante voeding. TiN coating verbetert de prestaties en verlengt de standtijd. Geschikt voor vele materialen.



ADX

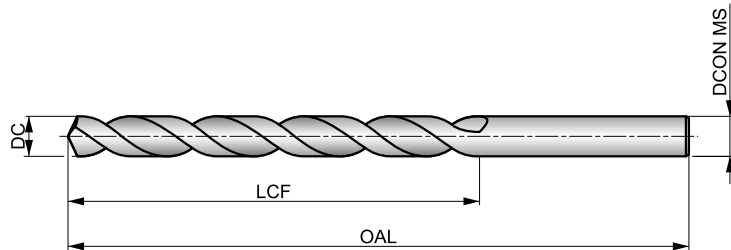

HSS	DIN 338	4xD
130°	TiN	
λ 32-40°	R	DC h8

De tabel geeft de geschiktheid aan voor de materiaalgroep en de startwaarden voor de snijsnelheid (m/min) en de letter verwijst naar de toe te passen voeding (fn), zie vanaf pagina 175.

P1.1 ■ 53 M	P1.2 ■ 59 M	P1.3 ■ 61 M	P2.1 ■ 45 M	P2.2 ■ 40 K	P2.3 ■ 35 F	P3.1 ■ 31 H	P3.2 ■ 25 H	P3.3 ■ 21 F	P4.1 ■ 19 H	P4.2 ■ 16 F	P4.3 ■ 13 D	M1.1 ■ 38 G	M1.2 ■ 32 G
M2.1 ■ 34 G	M2.2 ■ 28 G	M3.1 ■ 16 I	M3.2 ■ 14 I	M3.3 ■ 13 I	M4.1 ■ 19 G	K1.1 ■ 42 K	K1.2 ■ 31 J	K1.3 ■ 23 J	K2.1 ■ 34 J	K2.2 ■ 28 J	K2.3 ■ 22 F	K3.1 ■ 30 J	K3.2 ■ 23 J
K3.3 ■ 19 F	K4.1 ■ 28 J	K4.2 ■ 21 J	K4.3 ■ 16 F	K4.4 ■ 13 F	K4.5 ■ 11 F	K5.1 ■ 32 J	K5.2 ■ 24 J	K5.3 ■ 19 F	N1.1 ■ 50 G	N1.2 ■ 38 G	N1.3 ■ 25 M	N2.1 ■ 48 I	N2.2 ■ 43 I
N2.3 ■ 31 I	N3.1 ■ 85 I	N3.2 ■ 50 I	N3.3 ■ 25 D	N4.1 ■ 65 G	N4.2 ■ 50 G	N4.3 ■ 35 F	S1.1 ■ 32 G	S1.2 ■ 20 H	S1.3 ■ 4 B	S2.1 ■ 12 E	S2.2 ■ 8 E	S3.1 ■ 9 E	S3.2 ■ 6 E
S4.1 ■ 7 E	S4.2 ■ 5 E												

Product	DC (inch)	DC (mm)	DC (inch)	LCF (mm)	OAL (mm)	DCON MS (mm)	Product	DC (inch)	DC (mm)	DC (inch)	LCF (mm)	OAL (mm)	DCON MS (mm)
A5103.0	–	3.00	0.1181	33.0	61.0	3.00	A5104.9	–	4.90	0.1929	52.0	86.0	4.90
A5103.1	–	3.10	0.1220	36.0	65.0	3.10	A5105.0	–	5.00	0.1969	52.0	86.0	5.00
A5101/8	1/8	3.18	0.1250	36.0	65.0	3.18	A5105.1	–	5.10	0.2008	52.0	86.0	5.10
A5103.2	–	3.20	0.1260	36.0	65.0	3.20	A51013/64	13/64	5.16	0.2031	52.0	86.0	5.16
A5103.3	–	3.30	0.1299	36.0	65.0	3.30	A5105.2	–	5.20	0.2047	52.0	86.0	5.20
A5103.4	–	3.40	0.1339	39.0	70.0	3.40	A5105.3	–	5.30	0.2087	52.0	86.0	5.30
A5103.5	–	3.50	0.1378	39.0	70.0	3.50	A5105.4	–	5.40	0.2126	57.0	93.0	5.40
A5109/64	9/64	3.57	0.1406	39.0	70.0	3.57	A5105.5	–	5.50	0.2165	57.0	93.0	5.50
A5103.6	–	3.60	0.1417	39.0	70.0	3.60	A5107/32	7/32	5.56	0.2188	57.0	93.0	5.56
A5103.7	–	3.70	0.1457	39.0	70.0	3.70	A5105.6	–	5.60	0.2205	57.0	93.0	5.60
A5103.8	–	3.80	0.1496	43.0	75.0	3.80	A5105.7	–	5.70	0.2244	57.0	93.0	5.70
A5103.9	–	3.90	0.1535	43.0	75.0	3.90	A5105.8	–	5.80	0.2283	57.0	93.0	5.80
A5105/32	5/32	3.97	0.1563	43.0	75.0	3.97	A5105.9	–	5.90	0.2323	57.0	93.0	5.90
A5104.0	–	4.00	0.1575	43.0	75.0	4.00	A51015/64	15/64	5.95	0.2344	57.0	93.0	5.95
A5104.1	–	4.10	0.1614	43.0	75.0	4.10	A5106.0	–	6.00	0.2362	57.0	93.0	6.00
A5104.2	–	4.20	0.1654	43.0	75.0	4.20	A5106.1	–	6.10	0.2402	63.0	101.0	6.10
A5104.3	–	4.30	0.1693	47.0	80.0	4.30	A5106.2	–	6.20	0.2441	63.0	101.0	6.20
A51011/64	11/64	4.37	0.1719	47.0	80.0	4.37	A5106.3	–	6.30	0.2480	63.0	101.0	6.30
A5104.4	–	4.40	0.1732	47.0	80.0	4.40	A5101/4	1/4	6.35	0.2500	63.0	101.0	6.35
A5104.5	–	4.50	0.1772	47.0	80.0	4.50	A5106.4	–	6.40	0.2520	63.0	101.0	6.40
A5104.6	–	4.60	0.1811	47.0	80.0	4.60	A5106.5	–	6.50	0.2559	63.0	101.0	6.50
A5104.7	–	4.70	0.1850	47.0	80.0	4.70	A5106.6	–	6.60	0.2598	63.0	101.0	6.60
A5103/16	3/16	4.76	0.1875	52.0	86.0	4.76	A5106.7	–	6.70	0.2638	63.0	101.0	6.70
A5104.8	–	4.80	0.1890	52.0	86.0	4.80	A51017/64	17/64	6.75	0.2656	69.0	109.0	6.75



Product	DC	DC	DC	LCF	OAL	D CON MS
	(inch)	(mm)	(inch)	(mm)	(mm)	(mm)
A5106.8	—	6.80	0.2677	69.0	109.0	6.80
A5106.9	—	6.90	0.2717	69.0	109.0	6.90
A5107.0	—	7.00	0.2756	69.0	109.0	7.00
A5107.1	—	7.10	0.2795	69.0	109.0	7.10
A5109/32	9/32	7.14	0.2813	69.0	109.0	7.14
A5107.2	—	7.20	0.2835	69.0	109.0	7.20
A5107.3	—	7.30	0.2874	69.0	109.0	7.30
A5107.4	—	7.40	0.2913	69.0	109.0	7.40
A5107.5	—	7.50	0.2953	69.0	109.0	7.50
A51019/64	19/64	7.54	0.2969	75.0	117.0	7.54
A5107.6	—	7.60	0.2992	75.0	117.0	7.60
A5107.7	—	7.70	0.3031	75.0	117.0	7.70
A5107.8	—	7.80	0.3071	75.0	117.0	7.80
A5107.9	—	7.90	0.3110	75.0	117.0	7.90
A5105/16	5/16	7.94	0.3125	75.0	117.0	7.94
A5108.0	—	8.00	0.3150	75.0	117.0	8.00
A5108.1	—	8.10	0.3189	75.0	117.0	8.10
A5108.2	—	8.20	0.3228	75.0	117.0	8.20
A5108.3	—	8.30	0.3268	75.0	117.0	8.30
A51021/64	21/64	8.33	0.3281	75.0	117.0	8.33
A5108.4	—	8.40	0.3307	75.0	117.0	8.40
A5108.5	—	8.50	0.3346	75.0	117.0	8.50
A5108.6	—	8.60	0.3386	81.0	125.0	8.60
A5108.7	—	8.70	0.3425	81.0	125.0	8.70
A51011/32	11/32	8.73	0.3438	81.0	125.0	8.73
A5108.8	—	8.80	0.3465	81.0	125.0	8.80
A5108.9	—	8.90	0.3504	81.0	125.0	8.90
A5109.0	—	9.00	0.3543	81.0	125.0	9.00
A5109.1	—	9.10	0.3583	81.0	125.0	9.10
A51023/64	23/64	9.13	0.3594	81.0	125.0	9.13
A5109.2	—	9.20	0.3622	81.0	125.0	9.20
A5109.3	—	9.30	0.3661	81.0	125.0	9.30
A5109.4	—	9.40	0.3701	81.0	125.0	9.40
A5109.5	—	9.50	0.3740	81.0	125.0	9.50
A5103/8	3/8	9.52	0.3750	87.0	133.0	9.52
A5109.6	—	9.60	0.3780	87.0	133.0	9.60
A5109.7	—	9.70	0.3819	87.0	133.0	9.70
A5109.8	—	9.80	0.3858	87.0	133.0	9.80
A5109.9	—	9.90	0.3898	87.0	133.0	9.90
A51025/64	25/64	9.92	0.3906	87.0	133.0	9.92

Product	DC	DC	DC	LCF	OAL	D CON MS
	(inch)	(mm)	(inch)	(mm)	(mm)	(mm)
A51010.0	—	10.00	0.3937	87.0	133.0	10.00
A51010.1	—	10.10	0.3976	87.0	133.0	10.10
A51010.2	—	10.20	0.4016	87.0	133.0	10.20
A51010.3	—	10.30	0.4055	87.0	133.0	10.30
A51013/32	13/32	10.32	0.4063	87.0	133.0	10.32
A51010.4	—	10.40	0.4094	87.0	133.0	10.40
A51010.5	—	10.50	0.4134	87.0	133.0	10.50
A51010.6	—	10.60	0.4173	87.0	133.0	10.60
A51010.7	—	10.70	0.4213	94.0	142.0	10.70
A51027/64	27/64	10.72	0.4219	94.0	142.0	10.72
A51010.8	—	10.80	0.4252	94.0	142.0	10.80
A51010.9	—	10.90	0.4291	94.0	142.0	10.90
A51011.0	—	11.00	0.4331	94.0	142.0	11.00
A51011.1	—	11.10	0.4370	94.0	142.0	11.10
A5107/16	7/16	11.11	0.4375	94.0	142.0	11.11
A51011.2	—	11.20	0.4409	94.0	142.0	11.20
A51011.3	—	11.30	0.4449	94.0	142.0	11.30
A51011.4	—	11.40	0.4488	94.0	142.0	11.40
A51011.5	—	11.50	0.4528	94.0	142.0	11.50
A51029/64	29/64	11.51	0.4531	94.0	142.0	11.51
A51011.6	—	11.60	0.4567	94.0	142.0	11.60
A51011.7	—	11.70	0.4606	94.0	142.0	11.70
A51011.8	—	11.80	0.4646	94.0	142.0	11.80
A51011.9	—	11.90	0.4685	101.0	151.0	11.90
A51015/32	15/32	11.91	0.4688	101.0	151.0	11.91
A51012.0	—	12.00	0.4724	101.0	151.0	12.00
A51012.1	—	12.10	0.4764	101.0	151.0	12.10
A51012.2	—	12.20	0.4803	101.0	151.0	12.20
A51012.3	—	12.30	0.4843	101.0	151.0	12.30
A51031/64	31/64	12.30	0.4844	101.0	151.0	12.30
A51012.4	—	12.40	0.4882	101.0	151.0	12.40
A51012.5	—	12.50	0.4921	101.0	151.0	12.50
A51012.6	—	12.60	0.4961	101.0	151.0	12.60
A51012.7	—	12.70	0.5000	101.0	151.0	12.70
A5101/2	1/2	12.70	0.5000	101.0	151.0	12.70
A51012.8	—	12.80	0.5039	101.0	151.0	12.80
A51012.9	—	12.90	0.5079	101.0	151.0	12.90
A51013.0	—	13.00	0.5118	101.0	151.0	13.00
A51014.0	—	14.00	0.5512	108.0	160.0	14.00



A553



ADX HSS-E productieboor, DIN338, TiAIN gecoat, met koelkanalen

Hoogproductieve spiraalboor voor het boren van nauwkeurige gaten (H9) bij hoge verspaningscondities. Met 130° tophoek en uitgedunde ziel zelfcenterend. In te zetten op stationaire machines met instelbare constante voeding. TiN coating verbetert de prestaties en verlengt de standtijd. Voorzien van gladde eenheidsschacht conform DIN6535HA. Geschikt voor vele materialen.

ADX

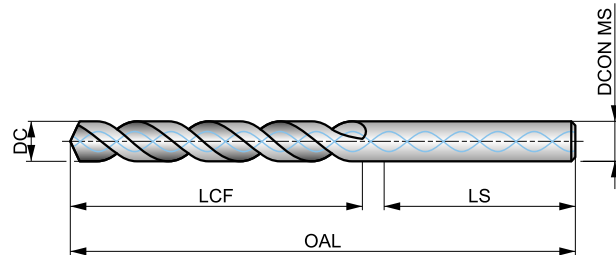

HSS-E	DORMER	5xD
130°	TiAIN Top	DIN 6535HA
$\lambda > 35^\circ$	R	
DC h8		

De tabel geeft de geschiktheid aan voor de materiaalgroep en de startwaarden voor de snijsnelheid (m/min) en de letter verwijst naar de toe te passen voeding (fn), zie vanaf pagina 175.

P1.1 ■ 80 L	P1.2 ■ 89 L	P1.3 ■ 92 L	P2.1 ■ 68 L	P2.2 ■ 60 L	P2.3 ■ 53 F	P3.1 ■ 41 H	P3.2 ■ 33 H	P3.3 ■ 28 F	P4.1 ■ 25 H	P4.2 ■ 21 F	P4.3 ■ 17 D	M1.1 ■ 55 G	M1.2 ■ 46 G
M2.1 ■ 49 G	M2.2 ■ 40 G	M3.1 ■ 22 I	M3.2 ■ 19 I	M3.3 ■ 17 I	M4.1 ■ 27 G	K1.1 ■ 70 K	K1.2 ■ 52 J	K1.3 ■ 39 J	K2.1 ■ 55 J	K2.2 ■ 45 J	K2.3 ■ 36 F	K3.1 ■ 49 J	K3.2 ■ 37 J
K3.3 ■ 30 F	K4.1 ■ 45 J	K4.2 ■ 34 J	K4.3 ■ 25 F	K4.4 ■ 22 F	K4.5 ■ 18 F	K5.1 ■ 51 J	K5.2 ■ 39 J	K5.3 ■ 30 F	N1.1 ■ 70 H	N1.2 ■ 53 H	N1.3 ■ 35 M	N2.1 ■ 85 I	N2.2 ■ 76 I
N2.3 ■ 55 I	N3.1 ■ 144 I	N3.2 ■ 85 I	N3.3 ■ 43 G	N4.1 ■ 90 G	S1.1 ■ 45 G	S1.2 ■ 30 E	S1.3 ■ 8 C	S2.1 ■ 20 E	S2.2 ■ 14 G	S3.1 ■ 15 E	S3.2 ■ 10 G	S4.1 ■ 12 E	S4.2 ■ 8 G

DCON MS passing h6.

Product	DC (mm)	DC (inch)	LCF (mm)	OAL (mm)	LS (mm)	DCON MS (mm)	Product	DC (mm)	DC (inch)	LCF (mm)	OAL (mm)	LS (mm)	DCON MS (mm)
A5535.0	5.00	0.1969	36.0	79.0	36.0	6.00	A55311.3	11.30	0.4449	94.0	150.0	45.0	12.00
A5535.2	5.20	0.2047	38.0	79.0	36.0	6.00	A55311.5	11.50	0.4528	94.0	150.0	45.0	12.00
A5535.5	5.50	0.2165	40.0	79.0	36.0	6.00	A55312.0	12.00	0.4724	94.0	150.0	45.0	12.00
A5536.0	6.00	0.2362	43.0	79.0	36.0	6.00	A55312.5	12.50	0.4921	101.0	160.0	45.0	14.00
A5536.3	6.30	0.2480	46.0	87.0	36.0	8.00	A55313.0	13.00	0.5118	101.0	160.0	45.0	14.00
A5536.5	6.50	0.2559	47.0	87.0	36.0	8.00	A55313.5	13.50	0.5315	101.0	160.0	45.0	14.00
A5536.8	6.80	0.2677	48.0	87.0	36.0	8.00	A55314.0	14.00	0.5512	101.0	160.0	45.0	14.00
A5536.9	6.90	0.2717	48.0	87.0	36.0	8.00	A55314.25	14.25	0.5610	108.0	170.0	48.0	16.00
A5537.0	7.00	0.2756	48.0	87.0	36.0	8.00	A55314.5	14.50	0.5709	108.0	170.0	48.0	16.00
A5537.4	7.40	0.2913	54.0	94.0	36.0	8.00	A55315.0	15.00	0.5906	108.0	170.0	48.0	16.00
A5537.5	7.50	0.2953	54.0	94.0	36.0	8.00	A55315.25	15.25	0.6004	108.0	170.0	48.0	16.00
A5538.0	8.00	0.3150	58.0	94.0	36.0	8.00	A55315.5	15.50	0.6102	108.0	170.0	48.0	16.00
A5538.5	8.50	0.3346	75.0	130.0	40.0	10.00	A55316.0	16.00	0.6299	108.0	170.0	48.0	16.00
A5538.7	8.70	0.3425	75.0	130.0	40.0	10.00	A55316.5	16.50	0.6496	125.0	190.0	48.0	18.00
A5539.0	9.00	0.3543	75.0	130.0	40.0	10.00	A55317.0	17.00	0.6693	125.0	190.0	48.0	18.00
A5539.5	9.50	0.3740	75.0	130.0	40.0	10.00	A55317.5	17.50	0.6890	130.0	190.0	48.0	18.00
A55310.0	10.00	0.3937	75.0	130.0	40.0	10.00	A55317.75	17.75	0.6988	130.0	190.0	48.0	18.00
A55310.2	10.20	0.4016	87.0	150.0	45.0	12.00	A55318.0	18.00	0.7087	130.0	190.0	48.0	18.00
A55310.3	10.30	0.4055	87.0	150.0	45.0	12.00	A55319.0	19.00	0.7480	135.0	200.0	50.0	20.00
A55310.5	10.50	0.4134	87.0	150.0	45.0	12.00	A55319.25	19.25	0.7579	140.0	200.0	50.0	20.00
A55311.0	11.00	0.4331	94.0	150.0	45.0	12.00	A55320.0	20.00	0.7874	140.0	200.0	50.0	20.00



A900



PFX HSS-E (5% Co) productieboor, DIN338

Hoogproductieve spiraalboor voor het boren van gaten van hoge kwaliteit en nauwkeurigheid bij hoge snelheden en voedingen (H10). Zelfcentrerende 130° tophoek en speciale parabolische spaangroefvorm helpen in samenwerking met de unieke snijkantsgeometrie om spanen zo te vormen dat ze makkelijk zijn af te voeren. Daardoor is het mogelijk diepe gaten te boren in één arbeidsgang. Geschikt voor vele materialen.

PFX

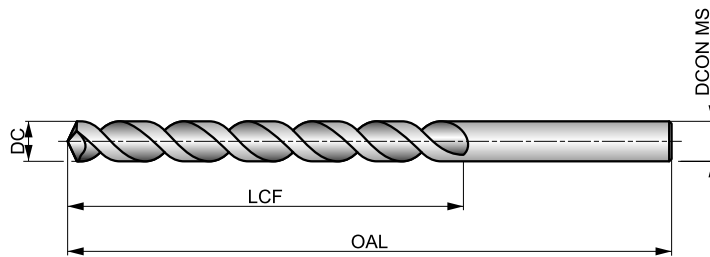

HSS-E	DIN ANSI	6xD
130°	Bright	
λ>35°	R	DC h8

De tabel geeft de geschiktheid aan voor de materiaalgroep en de startwaarden voor de snijsnelheid (m/min) en de letter verwijst naar de toe te passen voeding (fn), zie vanaf pagina 175.

P1.1 ■ 34 H	P1.2 ■ 39 H	P1.3 ■ 40 H	P2.1 ■ 30 H	P2.2 ■ 26 H	P2.3 ■ 23 E	P3.1 ■ 31 H	P3.2 ■ 25 H	P3.3 ■ 21 E	P4.1 ■ 19 H	P4.2 ■ 16 E	P4.3 ■ 13 E	M1.1 ■ 21 E	M1.2 ■ 17 E
M2.1 ■ 18 E	M2.2 ■ 15 E	M3.1 ■ 8 E	M3.2 ■ 7 E	M3.3 ■ 6 E	M4.1 ■ 9 C	K1.1 ■ 24 J	K1.2 ■ 18 J	K1.3 ■ 13 J	K2.1 ■ 23 J	K2.2 ■ 19 J	K2.3 ■ 15 I	K3.1 ■ 21 J	K3.2 ■ 16 J
K3.3 ■ 13 I	K4.1 ■ 19 J	K4.2 ■ 14 J	K4.3 ■ 11 I	K4.4 ■ 9 I	K4.5 ■ 8 I	K5.1 ■ 22 J	K5.2 ■ 16 J	K5.3 ■ 13 I	N1.1 ■ 60 J	N1.2 ■ 45 J	N1.3 ■ 30 N	N2.1 ■ 62 N	N2.2 ■ 55 N
N2.3 ■ 40 N	N3.1 ■ 90 H	N3.2 ■ 53 I	N3.3 ■ 27 G	N4.1 ■ 55 I	N4.2 ■ 40 G	S1.1 ■ 22 E	S1.2 ■ 15 E	S1.3 ■ 6 C	S2.1 ■ 9 G	S2.2 ■ 8 C	S3.1 ■ 7 G	S3.2 ■ 6 C	S4.1 ■ 5 G
S4.2 ■ 5 C													

Product	DC (inch)	DC (mm)	DC (inch)	LCF (mm)	OAL (mm)	DCON MS (mm)
A9001.0	-	1.00	0.0394	12.0	34.0	1.00
A9001.1	-	1.10	0.0433	14.0	36.0	1.10
A9003/64	3/64	1.19	0.0469	19.0	44.0	1.19
A9001.2	-	1.20	0.0472	16.0	38.0	1.20
A9001.25	-	1.25	0.0492	16.0	36.0	1.25
A9001.3	-	1.30	0.0512	16.0	38.0	1.30
A9001.4	-	1.40	0.0551	18.0	40.0	1.40
A9001.5	-	1.50	0.0591	18.0	40.0	1.50
A9001.55	-	1.55	0.0610	20.0	43.0	1.55
A9001/16	1/16	1.59	0.0625	22.0	48.0	1.59
A9001.6	-	1.60	0.0630	20.0	43.0	1.60
A9001.7	-	1.70	0.0669	20.0	43.0	1.70
A9001.75	-	1.75	0.0689	22.0	46.0	1.75
A9001.8	-	1.80	0.0709	22.0	46.0	1.80
A9001.9	-	1.90	0.0748	22.0	46.0	1.90
A9005/64	5/64	1.98	0.0781	25.0	51.0	1.98
A9002.0	-	2.00	0.0787	24.0	49.0	2.00
A9002.1	-	2.10	0.0827	24.0	49.0	2.10
A9002.15	-	2.15	0.0846	27.0	53.0	2.15
A9002.2	-	2.20	0.0866	27.0	53.0	2.20
A9002.3	-	2.30	0.0906	27.0	53.0	2.30
A9003/32	3/32	2.38	0.0937	32.0	57.0	2.38
A9002.4	-	2.40	0.0945	30.0	57.0	2.40
A9002.5	-	2.50	0.0984	30.0	57.0	2.50

Product	DC (inch)	DC (mm)	DC (inch)	LCF (mm)	OAL (mm)	DCON MS (mm)
A9002.6	-	2.60	0.1024	30.0	57.0	2.60
A9002.7	-	2.70	0.1063	33.0	61.0	2.70
A9007/64	7/64	2.78	0.1094	38.0	67.0	2.78
A9002.8	-	2.80	0.1102	33.0	61.0	2.80
A9002.9	-	2.90	0.1142	33.0	61.0	2.90
A9003.0	-	3.00	0.1181	33.0	61.0	3.00
A9003.1	-	3.10	0.1220	36.0	65.0	3.10
A9001/8	1/8	3.18	0.1250	41.0	70.0	3.18
A9003.2	-	3.20	0.1260	36.0	65.0	3.20
A9003.3	-	3.30	0.1299	36.0	65.0	3.30
A9003.4	-	3.40	0.1339	39.0	70.0	3.40
A9003.5	-	3.50	0.1378	39.0	70.0	3.50
A9009/64	9/64	3.57	0.1406	44.0	73.0	3.57
A9003.6	-	3.60	0.1417	39.0	70.0	3.60
A9003.7	-	3.70	0.1457	39.0	70.0	3.70
A9003.8	-	3.80	0.1496	43.0	75.0	3.80
A9003.9	-	3.90	0.1535	43.0	75.0	3.90
A9005/32	5/32	3.97	0.1563	51.0	79.0	3.97
A9004.0	-	4.00	0.1575	43.0	75.0	4.00
A9004.1	-	4.10	0.1614	43.0	75.0	4.10
A9004.2	-	4.20	0.1654	43.0	75.0	4.20
A9004.3	-	4.30	0.1693	47.0	80.0	4.30
A90011/64	11/64	4.37	0.1719	54.0	83.0	4.37
A9004.4	-	4.40	0.1732	47.0	80.0	4.40



Product	DC	DC	DC	LCF	OAL	D CON MS
	(inch)	(mm)	(inch)	(mm)	(mm)	(mm)
A9004.5	–	4.50	0.1772	47.0	80.0	4.50
A9004.6	–	4.60	0.1811	47.0	80.0	4.60
A9004.7	–	4.70	0.1850	47.0	80.0	4.70
A9003/16	3/16	4.76	0.1875	59.0	89.0	4.76
A9004.8	–	4.80	0.1890	52.0	86.0	4.80
A9004.9	–	4.90	0.1929	52.0	86.0	4.90
A9005.0	–	5.00	0.1969	52.0	86.0	5.00
A9005.1	–	5.10	0.2008	52.0	86.0	5.10
A90013/64	13/64	5.16	0.2031	62.0	92.0	5.16
A9005.2	–	5.20	0.2047	52.0	86.0	5.20
A9005.3	–	5.30	0.2087	52.0	86.0	5.30
A9005.4	–	5.40	0.2126	57.0	93.0	5.40
A9005.5	–	5.50	0.2165	57.0	93.0	5.50
A9007/32	7/32	5.56	0.2188	64.0	95.0	5.56
A9005.6	–	5.60	0.2205	57.0	93.0	5.60
A9005.7	–	5.70	0.2244	57.0	93.0	5.70
A9005.8	–	5.80	0.2283	57.0	93.0	5.80
A9005.9	–	5.90	0.2323	57.0	93.0	5.90
A90015/64	15/64	5.95	0.2344	67.0	98.0	5.95
A9006.0	–	6.00	0.2362	57.0	93.0	6.00
A9006.1	–	6.10	0.2402	63.0	101.0	6.10
A9006.2	–	6.20	0.2441	63.0	101.0	6.20
A9006.3	–	6.30	0.2480	63.0	101.0	6.30
A9001/4	1/4	6.35	0.2500	70.0	102.0	6.35
A9006.4	–	6.40	0.2520	63.0	101.0	6.40
A9006.5	–	6.50	0.2559	63.0	101.0	6.50
A9006.6	–	6.60	0.2598	63.0	101.0	6.60
A9006.7	–	6.70	0.2638	63.0	101.0	6.70
A90017/64	17/64	6.75	0.2656	73.0	105.0	6.75
A9006.8	–	6.80	0.2677	69.0	109.0	6.80
A9006.9	–	6.90	0.2717	69.0	109.0	6.90
A9007.0	–	7.00	0.2756	69.0	109.0	7.00
A9007.1	–	7.10	0.2795	69.0	109.0	7.10
A9009/32	9/32	7.14	0.2813	75.0	108.0	7.14
A9007.2	–	7.20	0.2835	69.0	109.0	7.20
A9007.3	–	7.30	0.2874	69.0	109.0	7.30
A9007.4	–	7.40	0.2913	69.0	109.0	7.40
A9007.5	–	7.50	0.2953	69.0	109.0	7.50
A90019/64	19/64	7.54	0.2969	78.0	111.0	7.54
A9007.6	–	7.60	0.2992	75.0	117.0	7.60
A9007.7	–	7.70	0.3031	75.0	117.0	7.70
A9007.8	–	7.80	0.3071	75.0	117.0	7.80
A9007.9	–	7.90	0.3110	75.0	117.0	7.90
A9005/16	5/16	7.94	0.3125	81.0	114.0	7.94
A9008.0	–	8.00	0.3150	75.0	117.0	8.00
A9008.1	–	8.10	0.3189	75.0	117.0	8.10
A9008.2	–	8.20	0.3228	75.0	117.0	8.20
A9008.3	–	8.30	0.3268	75.0	117.0	8.30
A90021/64	21/64	8.33	0.3281	84.0	117.0	8.33
A9008.4	–	8.40	0.3307	75.0	117.0	8.40
A9008.5	–	8.50	0.3346	75.0	117.0	8.50
A9008.6	–	8.60	0.3386	81.0	125.0	8.60
A9008.7	–	8.70	0.3425	81.0	125.0	8.70
A90011/32	11/32	8.73	0.3438	87.0	121.0	8.73
A9008.8	–	8.80	0.3465	81.0	125.0	8.80
A9008.9	–	8.90	0.3504	81.0	125.0	8.90
A9009.0	–	9.00	0.3543	81.0	125.0	9.00
A9009.1	–	9.10	0.3583	81.0	125.0	9.10
A90023/64	23/64	9.13	0.3594	89.0	124.0	9.13
A9009.2	–	9.20	0.3622	81.0	125.0	9.20

Product	DC	DC	DC	LCF	OAL	D CON MS
	(inch)	(mm)	(inch)	(mm)	(mm)	(mm)
A9009.3	–	9.30	0.3661	81.0	125.0	9.30
A9009.4	–	9.40	0.3701	81.0	125.0	9.40
A9009.5	–	9.50	0.3740	81.0	125.0	9.50
A9003/8	3/8	9.52	0.3750	92.0	127.0	9.52
A9009.6	–	9.60	0.3780	87.0	133.0	9.60
A9009.7	–	9.70	0.3819	87.0	133.0	9.70
A9009.8	–	9.80	0.3858	87.0	133.0	9.80
A9009.9	–	9.90	0.3898	87.0	133.0	9.90
A90025/64	25/64	9.92	0.3906	95.0	130.0	9.92
A90010.0	–	10.00	0.3937	87.0	133.0	10.00
A90010.2	–	10.20	0.4016	87.0	133.0	10.20
A90010.3	–	10.30	0.4055	87.0	133.0	10.30
A90013/32	13/32	10.32	0.4063	98.0	133.0	10.32
A90010.4	–	10.40	0.4094	87.0	133.0	10.40
A90010.5	–	10.50	0.4134	87.0	133.0	10.50
A90027/64	27/64	10.72	0.4219	100.0	137.0	10.72
A90010.8	–	10.80	0.4252	94.0	142.0	10.80
A90011.0	–	11.00	0.4331	94.0	142.0	11.00
A9007/16	7/16	11.11	0.4375	103.0	140.0	11.11
A90011.5	–	11.50	0.4528	94.0	142.0	11.50
A90029/64	29/64	11.51	0.4531	106.0	143.0	11.51
A90011.8	–	11.80	0.4646	94.0	142.0	11.80
A90015/32	15/32	11.91	0.4688	110.0	146.0	11.91
A90012.0	–	12.00	0.4724	101.0	151.0	12.00
A90031/64	31/64	12.30	0.4844	111.0	149.0	12.30
A90012.5	–	12.50	0.4921	101.0	151.0	12.50
A9001/2	1/2	12.70	0.5000	101.0	151.0	12.70
A90013.0	–	13.00	0.5118	101.0	151.0	13.00
A90033/64	33/64	13.10	0.5156	122.0	168.0	13.10
A90013.5	–	13.50	0.5315	108.0	160.0	13.50
A90035/64	35/64	13.89	0.5469	122.0	168.0	13.89
A90014.0	–	14.00	0.5512	108.0	160.0	14.00
A9009/16	9/16	14.29	0.5625	122.0	168.0	14.29
A90014.5	–	14.50	0.5709	114.0	169.0	14.50
A90037/64	37/64	14.68	0.5781	122.0	168.0	14.68
A90015.0	–	15.00	0.5906	114.0	169.0	15.00
A90019/32	19/32	15.08	0.5938	132.0	181.0	15.08
A90039/64	39/64	15.48	0.6094	132.0	181.0	15.48
A90015.5	–	15.50	0.6102	120.0	178.0	15.50
A9005/8	5/8	15.88	0.6250	132.0	181.0	15.88
A90016.0	–	16.00	0.6299	120.0	178.0	16.00
A90041/64	41/64	16.27	0.6406	132.0	181.0	16.27
A90016.5	–	16.50	0.6496	125.0	184.0	16.50
A90021/32	21/32	16.67	0.6563	132.0	181.0	16.67
A90017.0	–	17.00	0.6693	125.0	184.0	17.00
A90043/64	43/64	17.07	0.6719	143.0	194.0	17.07
A90011/16	11/16	17.46	0.6875	143.0	194.0	17.46
A90017.5	–	17.50	0.6890	130.0	191.0	17.50
A90045/64	45/64	17.86	0.7031	130.0	191.0	17.86
A90018.0	–	18.00	0.7087	130.0	191.0	18.00
A90023/32	23/32	18.26	0.7188	130.0	191.0	18.26
A90018.5	–	18.50	0.7283	135.0	198.0	18.50
A90047/64	47/64	18.65	0.7344	135.0	198.0	18.65
A90019.0	–	19.00	0.7480	135.0	198.0	19.00
A9003/4	3/4	19.05	0.7500	135.0	198.0	19.05
A90049/64	49/64	19.45	0.7656	135.0	198.0	19.45
A90019.5	–	19.50	0.7677	140.0	205.0	19.50
A90025/32	25/32	19.84	0.7813	140.0	205.0	19.84
A90020.0	–	20.00	0.7874	140.0	205.0	20.00



A901



PFX HSS-E (5% Co) productieboor, DIN338, Alcrona-Top gecoat

Hoogproductieve spiraalboor voor het boren van gaten van hoge kwaliteit en nauwkeurigheid bij hoge snelheden en voedingen (H10). Zelfcenterende 130° tophoek en speciale parabolische spaangroefvorm helpen in samenwerking met de unieke snijkantsgeometrie om spanen zo te vormen dat ze makkelijk zijn af te voeren. Daardoor is het mogelijk diepe gaten te boren in één arbeidsgang. Geschikt voor vele materialen.



PFX

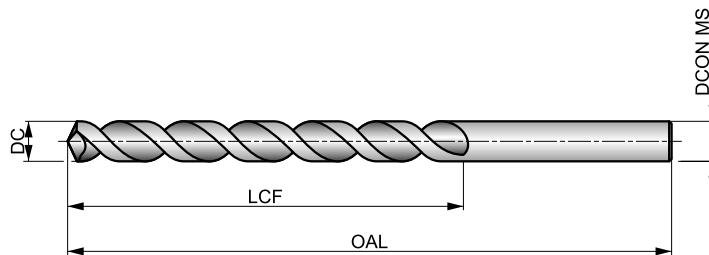

HSS-E	DIN ANSI	6xD
130°	Alcrona Top	
$\lambda > 35^\circ$	R	DC h8

De tabel geeft de geschiktheid aan voor de materiaalgroep en de startwaarden voor de snijsnelheid (m/min) en de letter verwijst naar de toe te passen voeding (fn), zie vanaf pagina 175.

P1.1 ■ 58 J	P1.2 ■ 65 J	P1.3 ■ 68 J	P2.1 ■ 50 J	P2.2 ■ 44 I	P2.3 ■ 39 G	P3.1 ■ 49 I	P3.2 ■ 39 I	P3.3 ■ 33 G	P4.1 ■ 29 I	P4.2 ■ 25 G	P4.3 ■ 20 G	M1.1 ■ 23 E	M1.2 ■ 20 E
M2.1 ■ 21 E	M2.2 ■ 17 E	M3.1 ■ 10 E	M3.2 ■ 9 E	M3.3 ■ 8 E	M4.1 ■ 11 C	K1.1 ■ 58 I	K1.2 ■ 43 I	K1.3 ■ 32 I	K2.1 ■ 42 J	K2.2 ■ 34 J	K2.3 ■ 27 I	K3.1 ■ 37 J	K3.2 ■ 28 J
K3.3 ■ 23 I	K4.1 ■ 34 J	K4.2 ■ 26 J	K4.3 ■ 19 I	K4.4 ■ 16 I	K4.5 ■ 14 I	K5.1 ■ 39 J	K5.2 ■ 29 J	K5.3 ■ 23 I	S1.1 ■ 35 G	S1.2 ■ 24 G	S1.3 ■ 10 E	S2.1 ■ 15 I	S2.2 ■ 14 E
S3.1 ■ 11 I	S3.2 ■ 10 E	S4.1 ■ 9 I	S4.2 ■ 8 E										

Product	DC (inch)	DC (mm)	DC (inch)	LCF (mm)	OAL (mm)	DCON MS (mm)
A9011.5	–	1.50	0.0591	18.0	40.0	1.50
A9011.55	–	1.55	0.0610	20.0	43.0	1.55
A9011/16	1/16	1.59	0.0625	22.0	48.0	1.59
A9011.6	–	1.60	0.0630	20.0	43.0	1.60
A9011.75	–	1.75	0.0689	22.0	46.0	1.75
A9011.8	–	1.80	0.0709	22.0	46.0	1.80
A9011.9	–	1.90	0.0748	22.0	46.0	1.90
A9015/64	5/64	1.98	0.0781	25.0	51.0	1.98
A9012.0	–	2.00	0.0787	24.0	49.0	2.00
A9012.1	–	2.10	0.0827	24.0	49.0	2.10
A9012.15	–	2.15	0.0846	27.0	53.0	2.15
A9013/32	3/32	2.38	0.0937	32.0	57.0	2.38
A9012.4	–	2.40	0.0945	30.0	57.0	2.40
A9012.5	–	2.50	0.0984	30.0	57.0	2.50
A9012.6	–	2.60	0.1024	30.0	57.0	2.60
A9012.7	–	2.70	0.1063	33.0	61.0	2.70
A9017/64	7/64	2.78	0.1094	38.0	67.0	2.78
A9012.9	–	2.90	0.1142	33.0	61.0	2.90
A9013.0	–	3.00	0.1181	33.0	61.0	3.00
A9013.1	–	3.10	0.1220	36.0	65.0	3.10
A9011/8	1/8	3.18	0.1250	41.0	70.0	3.18
A9013.2	–	3.20	0.1260	36.0	65.0	3.20
A9013.3	–	3.30	0.1299	36.0	65.0	3.30
A9013.4	–	3.40	0.1339	39.0	70.0	3.40
A9013.5	–	3.50	0.1378	39.0	70.0	3.50
A9013.6	–	3.60	0.1417	39.0	70.0	3.60

Product	DC (inch)	DC (mm)	DC (inch)	LCF (mm)	OAL (mm)	DCON MS (mm)
A9019/64	9/64	3.57	0.1406	44.0	73.0	3.57
A9013.7	–	3.70	0.1457	39.0	70.0	3.70
A9013.8	–	3.80	0.1496	43.0	75.0	3.80
A9013.9	–	3.90	0.1535	43.0	75.0	3.90
A9015/32	5/32	3.97	0.1563	51.0	79.0	3.97
A9014.0	–	4.00	0.1575	43.0	75.0	4.00
A9014.1	–	4.10	0.1614	43.0	75.0	4.10
A9014.2	–	4.20	0.1654	43.0	75.0	4.20
A9014.3	–	4.30	0.1693	47.0	80.0	4.30
A90111/64	11/64	4.37	0.1719	54.0	83.0	4.37
A9014.4	–	4.40	0.1732	47.0	80.0	4.40
A9014.5	–	4.50	0.1772	47.0	80.0	4.50
A9014.6	–	4.60	0.1811	47.0	80.0	4.60
A9014.7	–	4.70	0.1850	47.0	80.0	4.70
A9013/16	3/16	4.76	0.1875	59.0	89.0	4.76
A9014.8	–	4.80	0.1890	52.0	86.0	4.80
A9014.9	–	4.90	0.1929	52.0	86.0	4.90
A9015.0	–	5.00	0.1969	52.0	86.0	5.00
A9015.1	–	5.10	0.2008	52.0	86.0	5.10
A90113/64	13/64	5.16	0.2031	62.0	92.0	5.16
A9015.2	–	5.20	0.2047	52.0	86.0	5.20
A9015.3	–	5.30	0.2087	52.0	86.0	5.30
A9015.4	–	5.40	0.2126	57.0	93.0	5.40
A9015.5	–	5.50	0.2165	57.0	93.0	5.50
A9017/32	7/32	5.56	0.2188	64.0	95.0	5.56
A9015.6	–	5.60	0.2205	57.0	93.0	5.60



Product	DC	DC	DC	LCF	OAL	DCON MS
	(inch)	(mm)	(inch)	(mm)	(mm)	(mm)
A9015.7	–	5.70	0.2244	57.0	93.0	5.70
A9015.8	–	5.80	0.2283	57.0	93.0	5.80
A9015.9	–	5.90	0.2323	57.0	93.0	5.90
A90115/64	15/64	5.95	0.2344	67.0	98.0	5.95
A9016.0	–	6.00	0.2362	57.0	93.0	6.00
A9016.1	–	6.10	0.2402	63.0	101.0	6.10
A9016.2	–	6.20	0.2441	63.0	101.0	6.20
A9016.3	–	6.30	0.2480	63.0	101.0	6.30
A9011/4	1/4	6.35	0.2500	70.0	102.0	6.35
A9016.4	–	6.40	0.2520	63.0	101.0	6.40
A9016.5	–	6.50	0.2559	63.0	101.0	6.50
A9016.6	–	6.60	0.2598	63.0	101.0	6.60
A9016.7	–	6.70	0.2638	63.0	101.0	6.70
A90117/64	17/64	6.75	0.2656	73.0	105.0	6.75
A9016.8	–	6.80	0.2677	69.0	109.0	6.80
A9016.9	–	6.90	0.2717	69.0	109.0	6.90
A9017.0	–	7.00	0.2756	69.0	109.0	7.00
A9017.1	–	7.10	0.2795	69.0	109.0	7.10
A9019/32	9/32	7.14	0.2813	75.0	108.0	7.14
A9017.2	–	7.20	0.2835	69.0	109.0	7.20
A9017.3	–	7.30	0.2874	69.0	109.0	7.30
A9017.4	–	7.40	0.2913	69.0	109.0	7.40
A9017.5	–	7.50	0.2953	69.0	109.0	7.50
A90119/64	19/64	7.54	0.2969	78.0	111.0	7.54
A9017.6	–	7.60	0.2992	75.0	117.0	7.60
A9017.7	–	7.70	0.3031	75.0	117.0	7.70
A9017.8	–	7.80	0.3071	75.0	117.0	7.80
A9017.9	–	7.90	0.3110	75.0	117.0	7.90
A9015/16	5/16	7.94	0.3125	81.0	114.0	7.94
A9018.0	–	8.00	0.3150	75.0	117.0	8.00
A9018.1	–	8.10	0.3189	75.0	117.0	8.10
A9018.2	–	8.20	0.3228	75.0	117.0	8.20
A9018.3	–	8.30	0.3268	75.0	117.0	8.30
A90121/64	21/64	8.33	0.3281	84.0	117.0	8.33
A9018.4	–	8.40	0.3307	75.0	117.0	8.40
A9018.5	–	8.50	0.3346	75.0	117.0	8.50
A9018.6	–	8.60	0.3386	81.0	125.0	8.60
A9018.7	–	8.70	0.3425	81.0	125.0	8.70
A90111/32	11/32	8.73	0.3438	87.0	121.0	8.73
A9018.8	–	8.80	0.3465	81.0	125.0	8.80
A9018.9	–	8.90	0.3504	81.0	125.0	8.90
A9019.0	–	9.00	0.3543	81.0	125.0	9.00
A9019.1	–	9.10	0.3583	81.0	125.0	9.10

Product	DC	DC	DC	LCF	OAL	DCON MS
	(inch)	(mm)	(inch)	(mm)	(mm)	(mm)
A90123/64	23/64	9.13	0.3594	89.0	124.0	9.13
A9019.2	–	9.20	0.3622	81.0	125.0	9.20
A9019.3	–	9.30	0.3661	81.0	125.0	9.30
A9019.4	–	9.40	0.3701	81.0	125.0	9.40
A9019.5	–	9.50	0.3740	81.0	125.0	9.50
A9013/8	3/8	9.52	0.3750	92.0	127.0	9.52
A9019.6	–	9.60	0.3780	87.0	133.0	9.60
A9019.7	–	9.70	0.3819	87.0	133.0	9.70
A9019.8	–	9.80	0.3858	87.0	133.0	9.80
A9019.9	–	9.90	0.3898	87.0	133.0	9.90
A90125/64	25/64	9.92	0.3906	95.0	130.0	9.92
A90110.0	–	10.00	0.3937	87.0	133.0	10.00
A90110.2	–	10.20	0.4016	87.0	133.0	10.20
A90110.3	–	10.30	0.4055	87.0	133.0	10.30
A90113/32	13/32	10.32	0.4063	98.0	133.0	10.32
A90110.4	–	10.40	0.4094	87.0	133.0	10.40
A90110.5	–	10.50	0.4134	87.0	133.0	10.50
A90127/64	27/64	10.72	0.4219	100.0	137.0	10.72
A90110.8	–	10.80	0.4252	94.0	142.0	10.80
A90111.0	–	11.00	0.4331	94.0	142.0	11.00
A9017/16	7/16	11.11	0.4375	103.0	140.0	11.11
A90111.5	–	11.50	0.4528	94.0	142.0	11.50
A90129/64	29/64	11.51	0.4531	106.0	143.0	11.51
A90111.8	–	11.80	0.4646	94.0	142.0	11.80
A90115/32	15/32	11.91	0.4688	110.0	146.0	11.91
A90112.0	–	12.00	0.4724	101.0	151.0	12.00
A90131/64	31/64	12.30	0.4844	111.0	149.0	12.30
A90112.5	–	12.50	0.4921	101.0	151.0	12.50
A9011/2	1/2	12.70	0.5000	101.0	151.0	12.70
A90113.0	–	13.00	0.5118	101.0	151.0	13.00
A90133/64	33/64	13.10	0.5156	122.0	168.0	13.10
A90113.5	–	13.50	0.5315	108.0	160.0	13.50
A90135/64	35/64	13.89	0.5469	122.0	168.0	13.89
A90114.0	–	14.00	0.5512	108.0	160.0	14.00
A9019/16	9/16	14.29	0.5625	122.0	168.0	14.29
A90114.5	–	14.50	0.5709	114.0	169.0	14.50
A90137/64	37/64	14.68	0.5781	122.0	168.0	14.68
A90115.0	–	15.00	0.5906	114.0	169.0	15.00
A90119/32	19/32	15.08	0.5938	132.0	181.0	15.08
A90139/64	39/64	15.48	0.6094	132.0	181.0	15.48
A90115.5	–	15.50	0.6102	120.0	178.0	15.50
A9015/8	5/8	15.88	0.6250	132.0	181.0	15.88
A90116.0	–	16.00	0.6299	120.0	178.0	16.00



A170



HSS boor met gereduceerde schacht, stoomontlaten

Een 1/2 inch cilindrische schacht maakt het mogelijk om deze boor, zelfs met een grote boor diameter, vast te klemmen in conventionele, handbediende elektrische gereedschappen. Een 118° punt maakt naslijpen gemakkelijk. De stoomontlaten afwerking houdt snijvloeistof vast en voorkomt het aanlassen van spanen. Geschikt voor het boren van vele materialen.

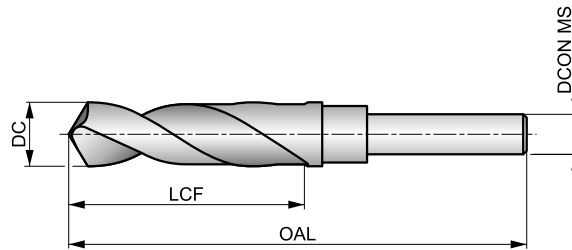

HSS	DORMER	4xD
118°	ST	
λ 20-35°	R	DC h8

De tabel geeft de geschiktheid aan voor de materiaalgroep en de startwaarden voor de snijnsnelheid (m/min) en de letter verwijst naar de toe te passen voeding (fn), zie vanaf pagina 175.

P1.1 ■ 33 H	P1.2 ■ 37 H	P1.3 ■ 38 H	P2.1 ■ 28 H	P2.2 ■ 25 F	P2.3 ■ 22 D	P3.1 ■ 19 E	P3.2 ■ 15 E	P3.3 ■ 13 D	P4.1 ■ 11 E	P4.2 ■ 10 D	P4.3 ■ 8 C	M1.1 ■ 21 D	M1.2 ■ 17 D
M2.1 ■ 18 D	M2.2 ■ 15 D	M3.1 ■ 8 F	M3.2 ■ 7 F	M3.3 ■ 6 F	M4.1 ■ 7 B	K1.1 ■ 27 H	K1.2 ■ 20 E	K1.3 ■ 15 E	K2.1 ■ 23 D	K2.2 ■ 19 D	K2.3 ■ 15 D	K3.1 ■ 21 D	K3.2 ■ 16 D
K3.3 ■ 13 D	K4.1 ■ 19 D	K4.2 ■ 14 D	K4.3 ■ 11 D	K4.4 ■ 19 D	K4.5 ■ 8 D	K5.1 ■ 22 D	K5.2 ■ 16 D	K5.3 ■ 13 D	N1.1 ■ 33 I	N1.2 ■ 25 I	N1.3 ■ 17 H	N2.1 ■ 42 G	N2.2 ■ 37 G
N2.3 ■ 27 G	N3.1 ■ 56 G	N3.2 ■ 33 H	N3.3 ■ 17 F	N4.1 ■ 30 I	N4.2 ■ 28 G	N4.3 ■ 14 E	S1.1 ■ 17 E	S1.2 ■ 9 C	S1.3 ■ 5 A	S2.1 ■ 5 D	S2.2 ■ 4 A	S3.1 ■ 4 D	S3.2 ■ 3 A
S4.1 ■ 3 D	S4.2 ■ 2 A												

Product	DC	DC	DC	LCF	OAL	LCF	OAL	DCON MS
	(inch)	(mm)	(inch)	(inch)	(inch)	(mm)	(mm)	
A17013.0	-	13.00	0.5118	-	-	83.0	156.0	12,7
A17033/64	33/64	13.10	0.5156	3.1/8	6"	-	-	12,7
A17017/32	17/32	13.49	0.5313	3.1/8	6"	-	-	12,7
A17013.5	-	13.50	0.5315	-	-	83.0	156.0	12,7
A17035/64	35/64	13.89	0.5469	3.1/8	6"	-	-	12,7
A17014.0	-	14.00	0.5512	-	-	83.0	156.0	12,7
A1709/16	9/16	14.29	0.5625	3.1/8	6"	-	-	12,7
A17014.5	-	14.50	0.5709	-	-	83.0	156.0	12,7
A17037/64	37/64	14.68	0.5781	3.1/8	6"	-	-	12,7
A17015.0	-	15.00	0.5906	-	-	83.0	156.0	12,7
A17019/32	19/32	15.08	0.5938	3.1/8	6"	-	-	12,7
A17039/64	39/64	15.48	0.6094	3.1/8	6"	-	-	12,7
A17015.5	-	15.50	0.6102	-	-	83.0	156.0	12,7
A1705/8	5/8	15.88	0.6250	3.1/8	6"	-	-	12,7
A17016.0	-	16.00	0.6299	-	-	84.0	157.0	12,7
A17041/64	41/64	16.27	0.6406	3.1/8	6"	-	-	12,7
A17016.5	-	16.50	0.6496	-	-	84.0	157.0	12,7
A17021/32	21/32	16.67	0.6563	3.1/8	6"	-	-	12,7
A17017.0	-	17.00	0.6693	-	-	84.0	157.0	12,7
A17043/64	43/64	17.07	0.6719	3.1/8	6"	-	-	12,7
A17011/16	11/16	17.46	0.6875	3.1/8	6"	-	-	12,7
A17017.5	-	17.50	0.6890	-	-	84.0	157.0	12,7
A17045/64	45/64	17.86	0.7031	3.1/8	6"	-	-	12,7
A17018.0	-	18.00	0.7087	-	-	84.0	157.0	12,7



Product	DC	DC	DC	LCF	OAL	LCF	OAL	DCON MS
	(inch)	(mm)	(inch)	(inch)	(inch)	(mm)	(mm)	(mm)
A17023/32	23/32	18.26	0.7188	3.1/8	6"	—	—	12,7
A17018.5	—	18.50	0.7283	—	—	84.0	157.0	12,7
A17047/64	47/64	18.65	0.7344	3.1/8	6"	—	—	12,7
A17019.0	—	19.00	0.7480	—	—	84.0	157.0	12,7
A1703/4	3/4	19.05	0.7500	3.1/8	6"	—	—	12,7
A17049/64	49/64	19.45	0.7656	3"	6"	—	—	12,7
A17019.5	—	19.50	0.7677	—	—	81.0	158.0	12,7
A17025/32	25/32	19.84	0.7813	3"	6"	—	—	12,7
A17020.0	—	20.00	0.7874	—	—	81.0	158.0	12,7
A17051/64	51/64	20.24	0.7969	3"	6"	—	—	12,7
A17013/16	13/16	20.64	0.8125	3"	6"	—	—	12,7
A17021.0	—	21.00	0.8268	—	—	82.0	158.0	12,7
A17053/64	53/64	21.03	0.8281	3"	6"	—	—	12,7
A17027/32	27/32	21.43	0.8437	3"	6"	—	—	12,7
A17055/64	55/64	21.83	0.8594	3"	6"	—	—	12,7
A17022.0	—	22.00	0.8661	—	—	82.0	158.0	12,7
A1707/8	7/8	22.22	0.8750	3"	6"	—	—	12,7
A17057/64	57/64	22.62	0.8906	3"	6"	—	—	12,7
A17023.0	—	23.00	0.9055	—	—	82.0	158.0	12,7
A17029/32	29/32	23.02	0.9063	3"	6"	—	—	12,7
A17059/64	59/64	23.42	0.9219	3"	6"	—	—	12,7
A17015/16	15/16	23.81	0.9375	3"	6"	—	—	12,7
A17024.0	—	24.00	0.9449	—	—	83.0	159.0	12,7
A17061/64	61/64	24.21	0.9531	3"	6"	—	—	12,7
A17031/32	31/32	24.61	0.9688	3"	6"	—	—	12,7
A17025.0	—	25.00	0.9843	—	—	83.0	159.0	12,7
A17063/64	63/64	25.00	0.9844	3"	6"	—	—	12,7
A1701	1"	25.40	1.0000	3"	6"	—	—	12,7
A1701.1/32	1.1/32	26.19	1.0313	3"	6"	—	—	12,7
A1701.1/16	1.1/16	26.99	1.0625	3"	6"	—	—	12,7
A1701.7/64	1.7/64	28.18	1.1094	3"	6"	—	—	12,7
A1701.1/8	1.1/8	28.58	1.1250	3"	6"	—	—	12,7
A1701.9/64	1.9/64	28.97	1.1406	3"	6"	—	—	12,7
A1701.5/32	1.5/32	29.37	1.1563	3"	6"	—	—	12,7
A1701.3/16	1.3/16	30.16	1.1875	3"	6"	—	—	12,7
A1701.7/32	1.7/32	30.96	1.2188	3"	6"	—	—	12,7
A1701.1/4	1.1/4	31.75	1.2500	3"	6"	—	—	12,7
A1701.5/16	1.5/16	33.34	1.3125	3"	6"	—	—	12,7
A1701.3/8	1.3/8	34.93	1.3750	3"	6"	—	—	12,7
A1701.7/16	1.7/16	36.51	1.4375	3"	6"	—	—	12,7
A1701.1/2	1.1/2	38.10	1.5000	3"	6"	—	—	12,7



A243



HSS spiraalboor met extra lange schacht, NAS907

NAS907 standaard met een 135° split point die helpt bij het zelfcentreren en voorkomt dat de punt van de boor over het oppervlak van het materiaal verloopt. De lange totale lengte in combinatie met de korte spiraallengte maakt hem ideaal voor het boren op moeilijk bereikbare plaatsen en is geschikt voor vele materialen.

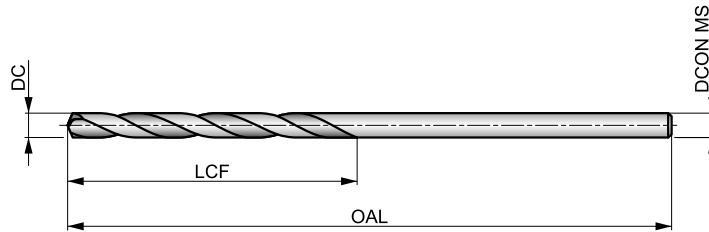

HSS	NAS 907	4xD
135°	Bright	
λ 20-35°	R	DC h8

De tabel geeft de geschiktheid aan voor de materiaalgroep en de startwaarden voor de snijnsnelheid (m/min) en de letter verwijst naar de toe te passen voeding (fn), zie vanaf pagina 175.

P2.2 ▣ 25 F	P2.3 ▣ 22 E	P3.1 ▣ 19 F	P3.2 ▣ 15 F	P3.3 ▣ 13 E	P4.1 ▣ 11 F	P4.2 ▣ 10 E	P4.3 ▣ 8 D	M1.1 ▣ 21 E	M1.2 ▣ 17 E	M2.1 ▣ 18 E	M2.2 ▣ 15 E	M3.1 ▣ 9 G	M3.2 ▣ 8 G
M3.3 ▣ 7 G	M4.1 ▣ 9 C	K1.1 ▣ 30 I	K1.2 ▣ 22 F	K1.3 ▣ 17 F	K2.1 ▣ 25 E	K2.2 ▣ 20 E	K2.3 ▣ 16 E	K3.1 ▣ 22 E	K3.2 ▣ 17 E	K3.3 ▣ 13 E	K4.1 ▣ 20 E	K4.2 ▣ 15 E	K4.3 ▣ 11 E
K4.4 ▣ 10 E	K4.5 ▣ 8 E	K5.1 ▣ 23 E	K5.2 ▣ 17 E	K5.3 ▣ 13 E	N3.1 ▣ 27 H	S1.1 ▣ 23 F	S1.2 ▣ 12 D	S1.3 ▣ 6 B	S2.1 ▣ 8 E	S2.2 ▣ 4 A	S3.1 ▣ 6 E	S3.2 ▣ 3 A	S4.1 ▣ 5 E
S4.2 ▣ 2 A													

6" OAL.

Product	DC (inch)	DC (inch)	LCF (inch)	OAL (inch)	DCON MS (inch)
A2433/32X6	3/32	0.0938	1.1/4	6"	0.0938
A243N40X6	N40	0.0980	1.3/8	6"	0.0980
A2431/8X6	1/8	0.1250	1.5/8	6"	0.1250
A243N30X6	N30	0.1285	1.5/8	6"	0.1285
A2435/32X6	5/32	0.1563	2"	6"	0.1563
A243N21X6	N21	0.1590	2.1/8	6"	0.1590

Product	DC (inch)	DC (inch)	LCF (inch)	OAL (inch)	DCON MS (inch)
A243N20X6	N20	0.1610	2.1/8	6"	0.1610
A2433/16X6	3/16	0.1875	2.5/16	6"	0.1875
A243N11X6	N11	0.1910	2.5/16	6"	0.1910
A243N10X6	N10	0.1935	2.7/16	6"	0.1935
A2431/4X6	1/4	0.2500	2.3/4	6"	0.2500



A244



HSS spiraalboor met extra lange schacht, NAS907

NAS907 standaard met een 118° split point die helpt bij het zelfcentreren en voorkomt dat de punt van de boor over het oppervlak van het materiaal verloopt. De lange totale lengte in combinatie met de korte spiraallengte maakt hem ideaal voor het boren op moeilijk bereikbare plaatsen en is geschikt voor vele materialen.

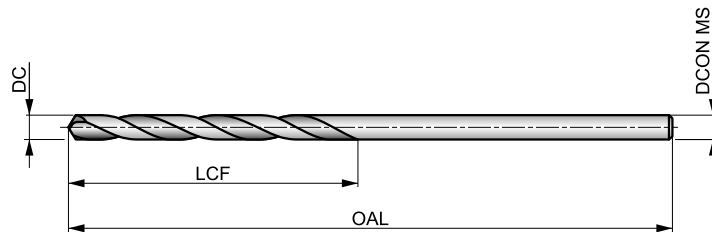

HSS	NAS 907	4xD
118°	Bright	
20-35°	R	DC h8

De tabel geeft de geschiktheid aan voor de materiaalgroep en de startwaarden voor de snijsnelheid (m/min) en de letter verwijst naar de toe te passen voeding (fn), zie vanaf pagina 175.

P2.2 ■ 25 F	P2.3 ■ 22 E	P3.1 ■ 19 F	P3.2 ■ 15 F	P3.3 ■ 13 E	P4.1 ■ 11 F	P4.2 ■ 10 E	P4.3 ■ 8 D	M1.1 ■ 21 E	M1.2 ■ 17 E	M2.1 ■ 18 E	M2.2 ■ 15 E	M3.1 ■ 9 G	M3.2 ■ 8 G
M3.3 ■ 7 G	M4.1 ■ 9 C	K1.1 ■ 30 I	K1.2 ■ 22 F	K1.3 ■ 17 F	K2.1 ■ 25 E	K2.2 ■ 20 E	K2.3 ■ 16 E	K3.1 ■ 22 E	K3.2 ■ 17 E	K3.3 ■ 13 E	K4.1 ■ 20 E	K4.2 ■ 15 E	K4.3 ■ 11 E
K4.4 ■ 10 E	K4.5 ■ 8 E	K5.1 ■ 23 E	K5.2 ■ 17 E	K5.3 ■ 13 E	N3.1 ■ 27 H	S1.1 ■ 23 F	S1.2 ■ 12 D	S1.3 ■ 6 B	S2.1 ■ 8 E	S2.2 ■ 4 A	S3.1 ■ 6 E	S3.2 ■ 3 A	S4.1 ■ 5 E
S4.2 ■ 2 A													

6°OAL

Product	DC (inch)	DC (inch)	LCF (inch)	OAL (inch)	DCON MS (inch)
A2441/8X6	1/8	0.1250	1.5/8	6"	0.1250
A2445/32X6	5/32	0.1563	2"	6"	0.1563
A2443/16X6	3/16	0.1875	2.5/16	6"	0.1875
A2441/4X6	1/4	0.2500	2.3/4	6"	0.2500



A110



HSS lange spiraalboor, DIN340, stoomontlaten

Precisie geslepen boor voor diepere gaten. De conventionele punt van 118° is gemakkelijk na te slijpen, waardoor hij zeer economisch is. Geschikt voor het boren van vele materialen. De stoomontlaten afwerking houdt snijvloeistof vast en voorkomt het aanlassen van spanen. Voor hand en stationaire boormachines.

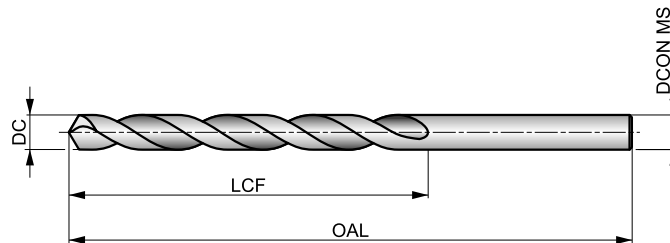

HSS	DIN 340	6xD
118°	ST	
λ 20-35°	R	DC h8

De tabel geeft de geschiktheid aan voor de materiaalgroep en de startwaarden voor de snijnsnelheid (m/min) en de letter verwijst naar de toe te passen voeding (fn), zie vanaf pagina 175.

P1.1 ■ 27 G	P1.2 ■ 30 G	P1.3 ■ 31 G	P2.1 ■ 23 G	P2.2 ■ 20 E	P2.3 ■ 18 D	P3.1 ■ 13 E	P3.2 ■ 11 E	P3.3 ■ 9 D	P4.1 ■ 8 E	P4.2 ■ 7 D	P4.3 ■ 5 B	M1.1 ■ 14 D	M1.2 ■ 12 D
M2.1 ■ 12 D	M2.2 ■ 10 D	M3.1 ■ 7 F	M3.2 ■ 6 F	M3.3 ■ 5 F	M4.1 ■ 4 B	K1.1 ■ 28 H	K1.2 ■ 21 E	K1.3 ■ 16 E	K2.1 ■ 18 D	K2.2 ■ 15 D	K2.3 ■ 12 D	K3.1 ■ 16 D	K3.2 ■ 12 D
K3.3 ■ 10 D	K4.1 ■ 15 D	K4.2 ■ 11 D	K4.3 ■ 8 D	K4.4 ■ 7 D	K4.5 ■ 6 D	K5.1 ■ 17 D	K5.2 ■ 13 D	K5.3 ■ 10 D	N1.1 ■ 32 I	N1.2 ■ 24 I	N1.3 ■ 16 H	N2.1 ■ 42 G	N2.2 ■ 37 G
N2.3 ■ 27 G	N3.1 ■ 54 G	N3.2 ■ 32 H	N3.3 ■ 16 E	N4.1 ■ 35 I	N4.2 ■ 26 G	N4.3 ■ 12 E	S1.1 ■ 17 E	S1.2 ■ 9 C	S1.3 ■ 4 A	S2.1 ■ 5 D	S2.2 ■ 4 A	S3.1 ■ 4 D	S3.2 ■ 3 A
S4.1 ■ 3 D	S4.2 ■ 2 A												

DC <= 1mm; 1/16" blank.

Product	DC (inch)	DC (mm)	DC (inch)	LCF (mm)	OAL (mm)	DCON MS (mm)
A110.5	-	0.50	0.0197	12.0	32.0	0.50
A110.6	-	0.60	0.0236	15.0	35.0	0.60
A110.7	-	0.70	0.0276	21.0	42.0	0.70
A1101/32	1/32	0.79	0.0313	25.0	46.0	0.79
A110.8	-	0.80	0.0315	25.0	46.0	0.80
A110.9	-	0.90	0.0354	29.0	51.0	0.90
A1101.0	-	1.00	0.0394	33.0	56.0	1.00
A1101.1	-	1.10	0.0433	37.0	60.0	1.10
A1101.2	-	1.20	0.0472	41.0	65.0	1.20
A1101.3	-	1.30	0.0512	41.0	65.0	1.30
A1101.4	-	1.40	0.0551	45.0	70.0	1.40
A1101.5	-	1.50	0.0591	45.0	70.0	1.50
A1101/16	1/16	1.59	0.0625	50.0	76.0	1.59
A1101.6	-	1.60	0.0630	50.0	76.0	1.60
A1101.7	-	1.70	0.0669	50.0	76.0	1.70
A1101.75	-	1.75	0.0689	53.0	80.0	1.75
A1101.8	-	1.80	0.0709	53.0	80.0	1.80
A1101.9	-	1.90	0.0748	53.0	80.0	1.90
A1105/64	5/64	1.98	0.0781	56.0	85.0	1.98
A1102.0	-	2.00	0.0787	56.0	85.0	2.00
A1102.05	-	2.05	0.0807	56.0	85.0	2.05
A1102.1	-	2.10	0.0827	56.0	85.0	2.10
A1102.2	-	2.20	0.0866	59.0	90.0	2.20
A1102.25	-	2.25	0.0886	59.0	90.0	2.25

Product	DC (inch)	DC (mm)	DC (inch)	LCF (mm)	OAL (mm)	DCON MS (mm)
A1102.3	-	2.30	0.0906	59.0	90.0	2.30
A1103/32	3/32	2.38	0.0938	62.0	95.0	2.38
A1102.4	-	2.40	0.0945	62.0	95.0	2.40
A1102.5	-	2.50	0.0984	62.0	95.0	2.50
A1102.6	-	2.60	0.1024	62.0	95.0	2.60
A1102.7	-	2.70	0.1063	66.0	100.0	2.70
A1107/64	7/64	2.78	0.1094	66.0	100.0	2.78
A1102.8	-	2.80	0.1102	66.0	100.0	2.80
A1102.9	-	2.90	0.1142	66.0	100.0	2.90
A1103.0	-	3.00	0.1181	66.0	100.0	3.00
A1103.1	-	3.10	0.1220	69.0	106.0	3.10
A1101/8	1/8	3.18	0.1250	69.0	106.0	3.18
A1103.2	-	3.20	0.1260	69.0	106.0	3.20
A1103.25	-	3.25	0.1280	69.0	106.0	3.25
A1103.3	-	3.30	0.1299	69.0	106.0	3.30
A1103.4	-	3.40	0.1339	73.0	112.0	3.40
A1103.5	-	3.50	0.1378	73.0	112.0	3.50
A1109/64	9/64	3.57	0.1406	73.0	112.0	3.57
A1103.6	-	3.60	0.1417	73.0	112.0	3.60
A1103.7	-	3.70	0.1457	73.0	112.0	3.70
A1103.75	-	3.75	0.1476	73.0	112.0	3.75
A1103.8	-	3.80	0.1496	78.0	119.0	3.80
A1103.9	-	3.90	0.1535	78.0	119.0	3.90
A1105/32	5/32	3.97	0.1563	78.0	119.0	3.97



Product	DC	DC	DC	LCF	OAL	D CON MS
	(inch)	(mm)	(inch)	(mm)	(mm)	(mm)
A1104.0	–	4.00	0.1575	78.0	119.0	4.00
A1104.1	–	4.10	0.1614	78.0	119.0	4.10
A1104.2	–	4.20	0.1654	78.0	119.0	4.20
A1104.25	–	4.25	0.1673	78.0	119.0	4.25
A1104.3	–	4.30	0.1693	82.0	126.0	4.30
A11011/64	11/64	4.37	0.1719	82.0	126.0	4.37
A1104.4	–	4.40	0.1732	82.0	126.0	4.40
A1104.5	–	4.50	0.1772	82.0	126.0	4.50
A1104.6	–	4.60	0.1811	82.0	126.0	4.60
A1104.7	–	4.70	0.1850	82.0	126.0	4.70
A1104.75	–	4.75	0.1870	82.0	126.0	4.75
A1103/16	3/16	4.76	0.1875	87.0	132.0	4.76
A1104.8	–	4.80	0.1890	87.0	132.0	4.80
A1104.9	–	4.90	0.1929	87.0	132.0	4.90
A1105.0	–	5.00	0.1969	87.0	132.0	5.00
A1105.1	–	5.10	0.2008	87.0	132.0	5.10
A11013/64	13/64	5.16	0.2031	87.0	132.0	5.16
A1105.2	–	5.20	0.2047	87.0	132.0	5.20
A1105.25	–	5.25	0.2067	87.0	132.0	5.25
A1105.3	–	5.30	0.2087	87.0	132.0	5.30
A1105.4	–	5.40	0.2126	91.0	139.0	5.40
A1105.5	–	5.50	0.2165	91.0	139.0	5.50
A1107/32	7/32	5.56	0.2188	91.0	139.0	5.56
A1105.6	–	5.60	0.2205	91.0	139.0	5.60
A1105.7	–	5.70	0.2244	91.0	139.0	5.70
A1105.75	–	5.75	0.2264	91.0	139.0	5.75
A1105.8	–	5.80	0.2283	91.0	139.0	5.80
A1105.9	–	5.90	0.2323	91.0	139.0	5.90
A11015/64	15/64	5.95	0.2344	91.0	139.0	5.95
A1106.0	–	6.00	0.2362	91.0	139.0	6.00
A1106.1	–	6.10	0.2402	97.0	148.0	6.10
A1106.2	–	6.20	0.2441	97.0	148.0	6.20
A1106.25	–	6.25	0.2461	97.0	148.0	6.25
A1106.3	–	6.30	0.2480	97.0	148.0	6.30
A1101/4	1/4	6.35	0.2500	97.0	148.0	6.35
A1106.4	–	6.40	0.2520	97.0	148.0	6.40
A1106.5	–	6.50	0.2559	97.0	148.0	6.50
A1106.6	–	6.60	0.2598	97.0	148.0	6.60
A1106.7	–	6.70	0.2638	97.0	148.0	6.70
A11017/64	17/64	6.75	0.2656	102.0	156.0	6.75
A1106.75	–	6.75	0.2657	102.0	156.0	6.75
A1106.8	–	6.80	0.2677	102.0	156.0	6.80
A1106.9	–	6.90	0.2717	102.0	156.0	6.90
A1107.0	–	7.00	0.2756	102.0	156.0	7.00
A1107.1	–	7.10	0.2795	102.0	156.0	7.10
A1109/32	9/32	7.14	0.2813	102.0	156.0	7.14
A1107.2	–	7.20	0.2835	102.0	156.0	7.20
A1107.25	–	7.25	0.2854	102.0	156.0	7.25
A1107.3	–	7.30	0.2874	102.0	156.0	7.30
A1107.4	–	7.40	0.2913	102.0	156.0	7.40
A1107.5	–	7.50	0.2953	102.0	156.0	7.50
A1107.6	–	7.60	0.2992	109.0	165.0	7.60
A1107.7	–	7.70	0.3031	109.0	165.0	7.70
A1107.75	–	7.75	0.3051	109.0	165.0	7.75
A1107.8	–	7.80	0.3071	109.0	165.0	7.80
A1107.9	–	7.90	0.3110	109.0	165.0	7.90
A1105/16	5/16	7.94	0.3125	109.0	165.0	7.94
A1108.0	–	8.00	0.3150	109.0	165.0	8.00
A1108.1	–	8.10	0.3189	109.0	165.0	8.10
A1108.2	–	8.20	0.3228	109.0	165.0	8.20
A1108.25	–	8.25	0.3248	109.0	165.0	8.25
A1108.3	–	8.30	0.3268	109.0	165.0	8.30
A1108.4	–	8.40	0.3307	109.0	165.0	8.40
A1108.5	–	8.50	0.3346	109.0	165.0	8.50
A1108.6	–	8.60	0.3386	115.0	175.0	8.60

Product	DC	DC	DC	LCF	OAL	D CON MS
	(inch)	(mm)	(inch)	(mm)	(mm)	(mm)
A1108.7	–	8.70	0.3425	115.0	175.0	8.70
A11011/32	11/32	8.73	0.3438	115.0	175.0	8.73
A1108.75	–	8.75	0.3445	115.0	175.0	8.75
A1108.8	–	8.80	0.3465	115.0	175.0	8.80
A1108.9	–	8.90	0.3504	115.0	175.0	8.90
A1109.0	–	9.00	0.3543	115.0	175.0	9.00
A1109.1	–	9.10	0.3583	115.0	175.0	9.10
A1109.2	–	9.20	0.3622	115.0	175.0	9.20
A1109.25	–	9.25	0.3642	115.0	175.0	9.25
A1109.3	–	9.30	0.3661	115.0	175.0	9.30
A1109.4	–	9.40	0.3701	115.0	175.0	9.40
A1109.5	–	9.50	0.3740	115.0	175.0	9.50
A1103/8	3/8	9.52	0.3750	121.0	184.0	9.52
A1109.6	–	9.60	0.3780	121.0	184.0	9.60
A1109.7	–	9.70	0.3819	121.0	184.0	9.70
A1109.75	–	9.75	0.3839	121.0	184.0	9.75
A1109.8	–	9.80	0.3858	121.0	184.0	9.80
A1109.9	–	9.90	0.3898	121.0	184.0	9.90
A11010.0	–	10.00	0.3937	121.0	184.0	10.00
A11010.1	–	10.10	0.3976	121.0	184.0	10.10
A11010.2	–	10.20	0.4016	121.0	184.0	10.20
A11010.25	–	10.25	0.4035	121.0	184.0	10.25
A11010.3	–	10.30	0.4055	121.0	184.0	10.30
A11013/32	13/32	10.32	0.4063	121.0	184.0	10.32
A11010.5	–	10.50	0.4134	121.0	184.0	10.50
A11010.75	–	10.75	0.4232	128.0	195.0	10.75
A11010.8	–	10.80	0.4252	128.0	195.0	10.80
A11011.0	–	11.00	0.4331	128.0	195.0	11.00
A1107/16	7/16	11.11	0.4375	128.0	195.0	11.11
A11011.25	–	11.25	0.4429	128.0	195.0	11.25
A11011.4	–	11.40	0.4488	128.0	195.0	11.40
A11011.5	–	11.50	0.4528	128.0	195.0	11.50
A11011.75	–	11.75	0.4626	128.0	195.0	11.75
A11012.0	–	12.00	0.4724	134.0	205.0	12.00
A11012.1	–	12.10	0.4764	134.0	205.0	12.10
A11012.25	–	12.25	0.4823	134.0	205.0	12.25
A11012.5	–	12.50	0.4921	134.0	205.0	12.50
A1101/2	1/2	12.70	0.5000	134.0	205.0	12.70
A11013.0	–	13.00	0.5118	134.0	205.0	13.00
A11017/32	17/32	13.49	0.5313	140.0	214.0	13.49
A11013.5	–	13.50	0.5315	140.0	214.0	13.50
A11014.0	–	14.00	0.5512	140.0	214.0	14.00
A1109/16	9/16	14.29	0.5625	144.0	220.0	14.29
A11014.5	–	14.50	0.5709	144.0	220.0	14.50
A11015.0	–	15.00	0.5906	144.0	220.0	15.00
A11015.5	–	15.50	0.6102	149.0	227.0	15.50
A1105/8	5/8	15.88	0.6250	149.0	227.0	15.88
A11016.0	–	16.00	0.6299	149.0	227.0	16.00
A11016.5	–	16.50	0.6496	154.0	235.0	16.50
A11017.0	–	17.00	0.6693	154.0	235.0	17.00
A11011/16	11/16	17.46	0.6875	158.0	241.0	17.46
A11017.5	–	17.50	0.6890	158.0	241.0	17.50
A11018.0	–	18.00	0.7087	158.0	241.0	18.00
A11018.5	–	18.50	0.7283	162.0	247.0	18.50
A11019.0	–	19.00	0.7480	162.0	247.0	19.00
A1103/4	3/4	19.05	0.7500	166.0	254.0	19.05
A11019.5	–	19.50	0.7677	166.0	254.0	19.50
A11020.0	–	20.00	0.7874	166.0	254.0	20.00
A11021.0	–	21.00	0.8268	171.0	261.0	21.00
A11022.0	–	22.00	0.8661	176.0	268.0	22.00
A1107/8	7/8	22.22	0.8750	176.0	268.0	22.22
A11015/16	15/16	23.81	0.9375	185.0	282.0	23.81
A1101	1"	25.40	1.0000	190.0	290.0	25.40



A940



PFX HSS-E (5% Co) lange productieboor, DIN340

Hoogproductieve spiraalboor voor het boren van gaten van hoge kwaliteit en nauwkeurigheid bij hoge snelheden en voedingen (H10). Zelfcentrerende 130° tophoek en speciale parabolische spaangroefvorm helpen in samenwerking met de unieke snijkantsgeometrie om spanen zo te vormen dat ze makkelijk zijn af te voeren. Daardoor is het mogelijk diepe gaten te boren in één arbeidsgang. Geschikt voor vele materialen.

PFX

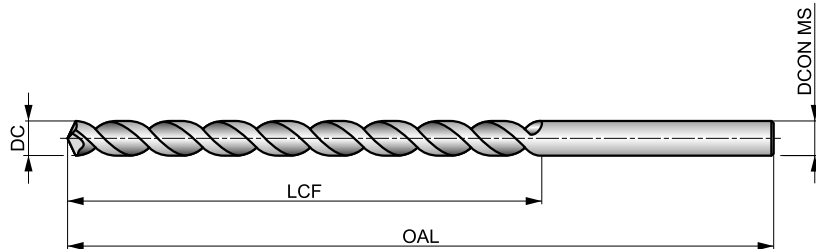

HSS-E	DIN ANSI	10xD
130°	Bright	
λ>35°	R	DC h8

De tabel geeft de geschiktheid aan voor de materiaalgroep en de startwaarden voor de snijsnelheid (m/min) en de letter verwijst naar de toe te passen voeding (fn), zie vanaf pagina 175.

P1.1 ■ 29 F	P1.2 ■ 33 F	P1.3 ■ 34 F	P2.1 ■ 25 F	P2.2 ■ 22 G	P2.3 ■ 19 C	P3.1 ■ 25 G	P3.2 ■ 20 G	P3.3 ■ 17 C	P4.1 ■ 15 G	P4.2 ■ 13 C	P4.3 ■ 10 C	M1.1 ■ 21 C	M1.2 ■ 17 C
M2.1 ■ 18 C	M2.2 ■ 15 C	M3.1 ■ 8 E	M3.2 ■ 7 E	M3.3 ■ 6 E	M4.1 ■ 9 B	K2.1 ■ 20 I	K2.2 ■ 16 I	K2.3 ■ 13 H	K3.1 ■ 17 I	K3.2 ■ 13 I	K3.3 ■ 11 H	K4.1 ■ 16 I	K4.2 ■ 12 I
K4.3 ■ 9 H	K4.4 ■ 8 H	K4.5 ■ 6 H	K5.1 ■ 18 I	K5.2 ■ 14 I	K5.3 ■ 11 H	N1.1 ■ 53 H	N1.2 ■ 40 H	N1.3 ■ 27 N	N2.1 ■ 62 N	N2.2 ■ 55 N	N2.3 ■ 40 N	N3.1 ■ 119 G	N3.2 ■ 70 F
N3.3 ■ 35 F	N4.1 ■ 55 H	N4.2 ■ 40 F	S1.1 ■ 18 E	S1.2 ■ 13 C	S1.3 ■ 6 C								

DC >= 9.6mm minder dan 10xD.

Product	DC (inch)	DC (mm)	DC (inch)	LCF (mm)	OAL (mm)	DCON MS (mm)
A9401.0	-	1.00	0.0394	33.0	56.0	1.00
A9401.1	-	1.10	0.0433	37.0	60.0	1.10
A9403/64	3/64	1.19	0.0469	29.0	57.0	1.19
A9401.2	-	1.20	0.0472	41.0	65.0	1.20
A9401.3	-	1.30	0.0512	41.0	65.0	1.30
A9401.4	-	1.40	0.0551	45.0	70.0	1.40
A9401.5	-	1.50	0.0591	45.0	70.0	1.50
A9401/16	1/16	1.59	0.0625	44.0	76.0	1.59
A9401.6	-	1.60	0.0630	50.0	76.0	1.60
A9401.7	-	1.70	0.0669	50.0	76.0	1.70
A9401.8	-	1.80	0.0709	53.0	80.0	1.80
A9401.9	-	1.90	0.0748	53.0	80.0	1.90
A9405/64	5/64	1.98	0.0781	51.0	95.0	1.98
A9402.0	-	2.00	0.0787	56.0	85.0	2.00
A9402.1	-	2.10	0.0827	56.0	85.0	2.10
A9402.2	-	2.20	0.0866	59.0	90.0	2.20
A9402.3	-	2.30	0.0906	59.0	90.0	2.30
A9403/32	3/32	2.38	0.0938	57.0	108.0	2.38
A9402.4	-	2.40	0.0945	62.0	95.0	2.40
A9402.5	-	2.50	0.0984	62.0	95.0	2.50
A9402.6	-	2.60	0.1024	62.0	95.0	2.60
A9402.7	-	2.70	0.1063	66.0	100.0	2.70
A9407/64	7/64	2.78	0.1094	64.0	117.0	2.78
A9402.8	-	2.80	0.1102	66.0	100.0	2.80
A9402.9	-	2.90	0.1142	66.0	100.0	2.90

Product	DC (inch)	DC (mm)	DC (inch)	LCF (mm)	OAL (mm)	DCON MS (mm)
A9403.0	-	3.00	0.1181	66.0	100.0	3.00
A9403.1	-	3.10	0.1220	69.0	106.0	3.10
A9401/8	1/8	3.18	0.1250	70.0	130.0	3.18
A9403.2	-	3.20	0.1260	69.0	106.0	3.20
A9403.3	-	3.30	0.1299	69.0	106.0	3.30
A9403.4	-	3.40	0.1339	73.0	112.0	3.40
A9403.5	-	3.50	0.1378	73.0	112.0	3.50
A9409/64	9/64	3.57	0.1406	76.0	137.0	3.57
A9403.6	-	3.60	0.1417	73.0	112.0	3.60
A9403.7	-	3.70	0.1457	73.0	112.0	3.70
A9403.8	-	3.80	0.1496	78.0	119.0	3.80
A9403.9	-	3.90	0.1535	78.0	119.0	3.90
A9405/32	5/32	3.97	0.1563	76.0	137.0	3.97
A9404.0	-	4.00	0.1575	78.0	119.0	4.00
A9404.1	-	4.10	0.1614	78.0	119.0	4.10
A9404.2	-	4.20	0.1654	78.0	119.0	4.20
A9404.3	-	4.30	0.1693	82.0	126.0	4.30
A94011/64	11/64	4.37	0.1719	86.0	146.0	4.37
A9404.4	-	4.40	0.1732	82.0	126.0	4.40
A9404.5	-	4.50	0.1772	82.0	126.0	4.50
A9404.6	-	4.60	0.1811	82.0	126.0	4.60
A9404.7	-	4.70	0.1850	82.0	126.0	4.70
A9403/16	3/16	4.76	0.1875	86.0	146.0	4.76
A9404.8	-	4.80	0.1890	87.0	132.0	4.80
A9404.9	-	4.90	0.1929	87.0	132.0	4.90



Product	DC	DC	DC	LCF	OAL	D CON MS
	(inch)	(mm)	(inch)	(mm)	(mm)	(mm)
A9405.0	–	5.00	0.1969	87.0	132.0	5.00
A9405.1	–	5.10	0.2008	87.0	132.0	5.10
A94013/64	13/64	5.16	0.2031	92.0	152.0	5.16
A9405.2	–	5.20	0.2047	87.0	132.0	5.20
A9405.3	–	5.30	0.2087	87.0	132.0	5.30
A9405.4	–	5.40	0.2126	91.0	139.0	5.40
A9405.5	–	5.50	0.2165	91.0	139.0	5.50
A9407/32	7/32	5.56	0.2188	92.0	152.0	5.56
A9405.6	–	5.60	0.2205	91.0	139.0	5.60
A9405.7	–	5.70	0.2244	91.0	139.0	5.70
A9405.8	–	5.80	0.2283	91.0	139.0	5.80
A9405.9	–	5.90	0.2323	91.0	139.0	5.90
A94015/64	15/64	5.95	0.2344	95.0	156.0	5.95
A9406.0	–	6.00	0.2362	91.0	139.0	6.00
A9406.1	–	6.10	0.2402	97.0	148.0	6.10
A9406.2	–	6.20	0.2441	97.0	148.0	6.20
A9406.3	–	6.30	0.2480	97.0	148.0	6.30
A9401/4	1/4	6.35	0.2500	95.0	156.0	6.35
A9406.4	–	6.40	0.2520	97.0	148.0	6.40
A9406.5	–	6.50	0.2559	97.0	148.0	6.50
A9406.6	–	6.60	0.2598	97.0	148.0	6.60
A9406.7	–	6.70	0.2638	97.0	148.0	6.70
A94017/64	17/64	6.75	0.2656	98.0	159.0	6.75
A9406.8	–	6.80	0.2677	102.0	156.0	6.80
A9406.9	–	6.90	0.2717	102.0	156.0	6.90
A9407.0	–	7.00	0.2756	102.0	156.0	7.00
A9407.1	–	7.10	0.2795	102.0	156.0	7.10
A9409/32	9/32	7.14	0.2813	98.0	159.0	7.14
A9407.2	–	7.20	0.2835	102.0	156.0	7.20
A9407.3	–	7.30	0.2874	102.0	156.0	7.30
A9407.4	–	7.40	0.2913	102.0	156.0	7.40
A9407.5	–	7.50	0.2953	102.0	156.0	7.50
A94019/64	19/64	7.54	0.2969	102.0	162.0	7.54
A9407.6	–	7.60	0.2992	109.0	165.0	7.60
A9407.7	–	7.70	0.3031	109.0	165.0	7.70
A9407.8	–	7.80	0.3071	109.0	165.0	7.80
A9407.9	–	7.90	0.3110	109.0	165.0	7.90
A9405/16	5/16	7.94	0.3125	102.0	162.0	7.94
A9408.0	–	8.00	0.3150	109.0	165.0	8.00
A9408.1	–	8.10	0.3189	109.0	165.0	8.10
A9408.2	–	8.20	0.3228	109.0	165.0	8.20
A9408.3	–	8.30	0.3268	109.0	165.0	8.30
A94021/64	21/64	8.33	0.3281	105.0	165.0	8.33
A9408.4	–	8.40	0.3307	109.0	165.0	8.40
A9408.5	–	8.50	0.3346	109.0	165.0	8.50
A9408.6	–	8.60	0.3386	115.0	175.0	8.60
A9408.7	–	8.70	0.3425	115.0	175.0	8.70
A94011/32	11/32	8.73	0.3438	105.0	165.0	8.73
A9408.8	–	8.80	0.3465	115.0	175.0	8.80
A9408.9	–	8.90	0.3504	115.0	175.0	8.90
A9409.0	–	9.00	0.3543	115.0	175.0	9.00
A9409.1	–	9.10	0.3583	115.0	175.0	9.10
A94023/64	23/64	9.13	0.3594	108.0	171.0	9.13
A9409.2	–	9.20	0.3622	115.0	175.0	9.20
A9409.3	–	9.30	0.3661	115.0	175.0	9.30
A9409.4	–	9.40	0.3701	115.0	175.0	9.40

Product	DC	DC	DC	LCF	OAL	D CON MS
	(inch)	(mm)	(inch)	(mm)	(mm)	(mm)
A9409.5	–	9.50	0.3740	115.0	175.0	9.50
A9403/8	3/8	9.52	0.3750	108.0	171.0	9.52
A9409.6	–	9.60	0.3780	121.0	184.0	9.60
A9409.7	–	9.70	0.3819	121.0	184.0	9.70
A9409.8	–	9.80	0.3858	121.0	184.0	9.80
A9409.9	–	9.90	0.3898	121.0	184.0	9.90
A94025/64	25/64	9.92	0.3906	111.0	178.0	9.92
A94010.0	–	10.00	0.3937	121.0	184.0	10.00
A94010.2	–	10.20	0.4016	121.0	184.0	10.20
A94010.3	–	10.30	0.4055	121.0	184.0	10.30
A94013/32	13/32	10.32	0.4063	111.0	178.0	10.32
A94010.5	–	10.50	0.4134	121.0	184.0	10.50
A94027/64	27/64	10.72	0.4219	117.0	184.0	10.72
A94011.0	–	11.00	0.4331	128.0	195.0	11.00
A9407/16	7/16	11.11	0.4375	117.0	184.0	11.11
A94011.2	–	11.20	0.4409	128.0	195.0	11.20
A94011.5	–	11.50	0.4528	128.0	195.0	11.50
A94029/64	29/64	11.51	0.4531	121.0	190.0	11.51
A94011.8	–	11.80	0.4646	128.0	195.0	11.80
A94015/32	15/32	11.91	0.4688	121.0	190.0	11.91
A94012.0	–	12.00	0.4724	134.0	205.0	12.00
A94012.2	–	12.20	0.4803	134.0	205.0	12.20
A94031/64	31/64	12.30	0.4844	121.0	197.0	12.30
A94012.5	–	12.50	0.4921	134.0	205.0	12.50
A9401/2	1/2	12.70	0.5000	121.0	197.0	12.70
A94013.0	–	13.00	0.5118	134.0	205.0	13.00
A94033/64	33/64	13.10	0.5156	121.0	203.0	13.10
A94017/32	17/32	13.49	0.5313	121.0	203.0	13.49
A94013.5	–	13.50	0.5315	140.0	214.0	13.50
A94035/64	35/64	13.89	0.5469	124.0	210.0	13.89
A94014.0	–	14.00	0.5512	140.0	214.0	14.00
A9409/16	9/16	14.29	0.5625	124.0	210.0	14.29
A94014.5	–	14.50	0.5709	144.0	220.0	14.50
A94037/64	37/64	14.68	0.5781	124.0	222.0	14.68
A94015.0	–	15.00	0.5906	144.0	220.0	15.00
A94019/32	19/32	15.08	0.5938	124.0	222.0	15.08
A94039/64	39/64	15.48	0.6094	124.0	222.0	15.48
A94015.5	–	15.50	0.6102	149.0	227.0	15.50
A9405/8	5/8	15.88	0.6250	124.0	222.0	15.88
A94016.0	–	16.00	0.6299	149.0	227.0	16.00
A94041/64	41/64	16.27	0.6406	130.0	229.0	16.27
A94016.5	–	16.50	0.6496	154.0	235.0	16.50
A94021/32	21/32	16.67	0.6563	130.0	229.0	16.67
A94017.0	–	17.00	0.6693	154.0	235.0	17.00
A94043/64	43/64	17.07	0.6719	137.0	235.0	17.07
A94011/16	11/16	17.46	0.6875	137.0	235.0	17.46
A94017.5	–	17.50	0.6890	158.0	241.0	17.50
A94045/64	45/64	17.86	0.7031	143.0	241.0	17.86
A94018.0	–	18.00	0.7087	158.0	241.0	18.00
A94023/32	23/32	18.26	0.7188	143.0	241.0	18.26
A94047/64	47/64	18.65	0.7344	149.0	248.0	18.65
A94019.0	–	19.00	0.7480	162.0	247.0	19.00
A9403/4	3/4	19.05	0.7500	149.0	248.0	19.05
A94049/64	49/64	19.45	0.7656	152.0	251.0	19.45
A94025/32	25/32	19.84	0.7813	152.0	251.0	19.84
A94020.0	–	20.00	0.7874	166.0	254.0	20.00



A941



PFX HSS-E (5% Co) lange productieboor, DIN340, Alcrona-Top gecoat

Hoogproductieve spiraalboor voor het boren van gaten van hoge kwaliteit en nauwkeurigheid bij hoge snelheden en voedingen (H10). Zelfcenterende 130° tophoek en speciale parabolische spaangroefvorm helpen in samenwerking met de unieke snijkantsgeometrie om spanen zo te vormen dat ze makkelijk zijn af te voeren. Daardoor is het mogelijk diepe gaten te boren in één arbeidsgang. Geschikt voor vele materialen.

PFX

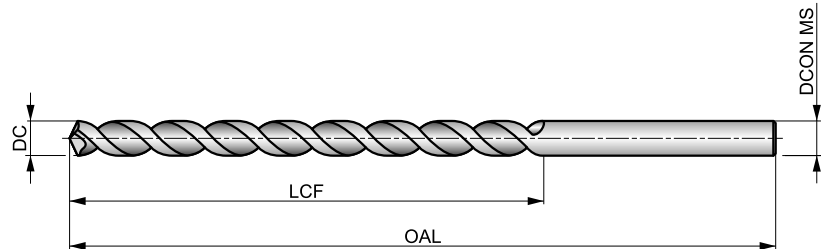

HSS-E	DIN ANSI	10xD
130°	Alcrona Top	
λ>35°	R	DC h8

De tabel geeft de geschiktheid aan voor de materiaalgroep en de startwaarden voor de snijsnelheid (m/min) en de letter verwijst naar de toe te passen voeding (fn), zie vanaf pagina 175.

P1.1 ■ 48 G	P1.2 ■ 53 G	P1.3 ■ 55 G	P2.1 ■ 41 G	P2.2 ■ 36 G	P2.3 ■ 32 D	P3.1 ■ 34 G	P3.2 ■ 27 G	P3.3 ■ 23 D	P4.1 ■ 20 G	P4.2 ■ 17 D	P4.3 ■ 14 D	M1.1 ■ 23 C	M1.2 ■ 20 C
M2.1 ■ 21 C	M2.2 ■ 17 C	M3.1 ■ 10 E	M3.2 ■ 9 E	M3.3 ■ 8 E	M4.1 ■ 11 B	K1.1 ■ 36 I	K1.2 ■ 27 I	K1.3 ■ 20 I	K2.1 ■ 37 I	K2.2 ■ 30 I	K2.3 ■ 24 H	K3.1 ■ 33 I	K3.2 ■ 25 I
K3.3 ■ 20 H	K4.1 ■ 30 I	K4.2 ■ 23 I	K4.3 ■ 17 H	K4.4 ■ 14 H	K4.5 ■ 12 H	K5.1 ■ 34 I	K5.2 ■ 26 I	K5.3 ■ 20 H	S1.1 ■ 25 F	S1.2 ■ 18 D	S1.3 ■ 18 D		

DC >= 9.6mm minder dan 10xD.

Product	DC	DC	DC	LCF	OAL	DCON MS
	(inch)	(mm)	(inch)			
A9411.0	-	1.00	0.0394	33.0	56.0	1.00
A9413/64	3/64	1.19	0.0469	29.0	57.0	1.19
A9411.5	-	1.50	0.0591	45.0	70.0	1.50
A9411/16	1/16	1.59	0.0625	44.0	76.0	1.59
A9415/64	5/64	1.98	0.0781	51.0	95.0	1.98
A9412.0	-	2.00	0.0787	56.0	85.0	2.00
A9413/32	3/32	2.38	0.0938	57.0	108.0	2.38
A9412.5	-	2.50	0.0984	62.0	95.0	2.50
A9417/64	7/64	2.78	0.1094	64.0	117.0	2.78
A9413.0	-	3.00	0.1181	66.0	100.0	3.00
A9413.1	-	3.10	0.1220	69.0	106.0	3.10
A9411/8	1/8	3.18	0.1250	70.0	130.0	3.18
A9413.2	-	3.20	0.1260	69.0	106.0	3.20
A9413.3	-	3.30	0.1299	69.0	106.0	3.30
A9413.4	-	3.40	0.1339	73.0	112.0	3.40
A9413.5	-	3.50	0.1378	73.0	112.0	3.50
A9419/64	9/64	3.57	0.1406	76.0	137.0	3.57
A9413.6	-	3.60	0.1417	73.0	112.0	3.60
A9413.7	-	3.70	0.1457	73.0	112.0	3.70
A9413.8	-	3.80	0.1496	78.0	119.0	3.80
A9413.9	-	3.90	0.1535	78.0	119.0	3.90
A9415/32	5/32	3.97	0.1563	76.0	137.0	3.97
A9414.0	-	4.00	0.1575	78.0	119.0	4.00
A9414.1	-	4.10	0.1614	78.0	119.0	4.10
A9414.2	-	4.20	0.1654	78.0	119.0	4.20
A9414.3	-	4.30	0.1693	82.0	126.0	4.30
A94111/64	11/64	4.37	0.1719	86.0	146.0	4.37

Product	DC	DC	DC	LCF	OAL	DCON MS
	(inch)	(mm)	(inch)			
A9414.4	-	4.40	0.1732	82.0	126.0	4.40
A9414.5	-	4.50	0.1772	82.0	126.0	4.50
A9414.6	-	4.60	0.1811	82.0	126.0	4.60
A9414.7	-	4.70	0.1850	82.0	126.0	4.70
A9413/16	3/16	4.76	0.1875	86.0	146.0	4.76
A9414.8	-	4.80	0.1890	87.0	132.0	4.80
A9414.9	-	4.90	0.1929	87.0	132.0	4.90
A9415.0	-	5.00	0.1969	87.0	132.0	5.00
A9415.1	-	5.10	0.2008	87.0	132.0	5.10
A94113/64	13/64	5.16	0.2031	92.0	152.0	5.16
A9415.2	-	5.20	0.2047	87.0	132.0	5.20
A9415.3	-	5.30	0.2087	87.0	132.0	5.30
A9415.4	-	5.40	0.2126	91.0	139.0	5.40
A9415.5	-	5.50	0.2165	91.0	139.0	5.50
A9417/32	7/32	5.56	0.2188	92.0	152.0	5.56
A9415.6	-	5.60	0.2205	91.0	139.0	5.60
A9415.7	-	5.70	0.2244	91.0	139.0	5.70
A9415.8	-	5.80	0.2283	91.0	139.0	5.80
A9415.9	-	5.90	0.2323	91.0	139.0	5.90
A94115/64	15/64	5.95	0.2344	95.0	156.0	5.95
A9416.0	-	6.00	0.2362	91.0	139.0	6.00
A9416.1	-	6.10	0.2402	97.0	148.0	6.10
A9416.2	-	6.20	0.2441	97.0	148.0	6.20
A9416.3	-	6.30	0.2480	97.0	148.0	6.30
A9411/4	1/4	6.35	0.2500	95.0	156.0	6.35
A9416.4	-	6.40	0.2520	97.0	148.0	6.40
A9416.5	-	6.50	0.2559	97.0	148.0	6.50



Product	DC	DC	DC	LCF	OAL	DCON MS
	(inch)	(mm)	(inch)	(mm)	(mm)	(mm)
A9416.6	–	6.60	0.2598	97.0	148.0	6.60
A9416.7	–	6.70	0.2638	97.0	148.0	6.70
A94117/64	17/64	6.75	0.2656	98.0	159.0	6.75
A9416.8	–	6.80	0.2677	102.0	156.0	6.80
A9416.9	–	6.90	0.2717	102.0	156.0	6.90
A9417.0	–	7.00	0.2756	102.0	156.0	7.00
A9417.1	–	7.10	0.2795	102.0	156.0	7.10
A9419/32	9/32	7.14	0.2813	98.0	159.0	7.14
A9417.2	–	7.20	0.2835	102.0	156.0	7.20
A9417.3	–	7.30	0.2874	102.0	156.0	7.30
A9417.4	–	7.40	0.2913	102.0	156.0	7.40
A9417.5	–	7.50	0.2953	102.0	156.0	7.50
A94119/64	19/64	7.54	0.2969	102.0	162.0	7.54
A9417.6	–	7.60	0.2992	109.0	165.0	7.60
A9417.7	–	7.70	0.3031	109.0	165.0	7.70
A9417.8	–	7.80	0.3071	109.0	165.0	7.80
A9417.9	–	7.90	0.3110	109.0	165.0	7.90
A9415/16	5/16	7.94	0.3125	102.0	162.0	7.94
A9418.0	–	8.00	0.3150	109.0	165.0	8.00
A9418.1	–	8.10	0.3189	109.0	165.0	8.10
A9418.2	–	8.20	0.3228	109.0	165.0	8.20
A9418.3	–	8.30	0.3268	109.0	165.0	8.30
A94121/64	21/64	8.33	0.3281	105.0	165.0	8.33
A9418.4	–	8.40	0.3307	109.0	165.0	8.40
A9418.5	–	8.50	0.3346	109.0	165.0	8.50
A9418.6	–	8.60	0.3386	115.0	175.0	8.60
A9418.7	–	8.70	0.3425	115.0	175.0	8.70
A94111/32	11/32	8.73	0.3438	105.0	165.0	8.73
A9418.8	–	8.80	0.3465	115.0	175.0	8.80
A9418.9	–	8.90	0.3504	115.0	175.0	8.90
A9419.0	–	9.00	0.3543	115.0	175.0	9.00
A9419.1	–	9.10	0.3583	115.0	175.0	9.10
A94123/64	23/64	9.13	0.3594	108.0	171.0	9.13
A9419.2	–	9.20	0.3622	115.0	175.0	9.20
A9419.3	–	9.30	0.3661	115.0	175.0	9.30
A9419.4	–	9.40	0.3701	115.0	175.0	9.40
A9419.5	–	9.50	0.3740	115.0	175.0	9.50
A9413/8	3/8	9.52	0.3750	108.0	171.0	9.52

Product	DC	DC	DC	LCF	OAL	DCON MS
	(inch)	(mm)	(inch)	(mm)	(mm)	(mm)
A9419.6	–	9.60	0.3780	121.0	184.0	9.60
A9419.7	–	9.70	0.3819	121.0	184.0	9.70
A9419.8	–	9.80	0.3858	121.0	184.0	9.80
A9419.9	–	9.90	0.3898	121.0	184.0	9.90
A94125/64	25/64	9.92	0.3906	111.0	178.0	9.92
A94110.0	–	10.00	0.3937	121.0	184.0	10.00
A94110.2	–	10.20	0.4016	121.0	184.0	10.20
A94110.3	–	10.30	0.4055	121.0	184.0	10.30
A94113/32	13/32	10.32	0.4063	111.0	178.0	10.32
A94110.5	–	10.50	0.4134	121.0	184.0	10.50
A94127/64	27/64	10.72	0.4219	117.0	184.0	10.72
A94111.0	–	11.00	0.4331	128.0	195.0	11.00
A9417/16	7/16	11.11	0.4375	117.0	184.0	11.11
A94111.2	–	11.20	0.4409	128.0	195.0	11.20
A94111.5	–	11.50	0.4528	128.0	195.0	11.50
A94129/64	29/64	11.51	0.4531	121.0	190.0	11.51
A94111.8	–	11.80	0.4646	128.0	195.0	11.80
A94115/32	15/32	11.91	0.4688	121.0	190.0	11.91
A94112.0	–	12.00	0.4724	134.0	205.0	12.00
A94112.2	–	12.20	0.4803	134.0	205.0	12.20
A94131/64	31/64	12.30	0.4844	121.0	197.0	12.30
A94112.5	–	12.50	0.4921	134.0	205.0	12.50
A9411/2	1/2	12.70	0.5000	121.0	197.0	12.70
A94113.0	–	13.00	0.5118	134.0	205.0	13.00
A94133/64	33/64	13.10	0.5156	121.0	203.0	13.10
A94113.5	–	13.50	0.5315	140.0	214.0	13.50
A94135/64	35/64	13.89	0.5469	124.0	210.0	13.89
A94114.0	–	14.00	0.5512	140.0	214.0	14.00
A9419/16	9/16	14.29	0.5625	124.0	210.0	14.29
A94114.5	–	14.50	0.5709	144.0	220.0	14.50
A94137/64	37/64	14.68	0.5781	124.0	222.0	14.68
A94115.0	–	15.00	0.5906	144.0	220.0	15.00
A94119/32	19/32	15.08	0.5938	124.0	222.0	15.08
A94139/64	39/64	15.48	0.6094	124.0	222.0	15.48
A94115.5	–	15.50	0.6102	149.0	227.0	15.50
A9415/8	5/8	15.88	0.6250	124.0	222.0	15.88
A94116.0	–	16.00	0.6299	149.0	227.0	16.00



A125



HSS extra lange spiraalboor, stoomontlaten

Precisie geslepen boor voor zeer diepe gaten. De conventionele punt van 118° is gemakkelijk na te slijpen, waardoor hij zeer economisch is. Geschikt voor het boren van vele materialen. De stoomontlaten afwerking houdt snijvloestof vast en voorkomt het aanslassen van spanen. Voor hand en stationaire boormachines.

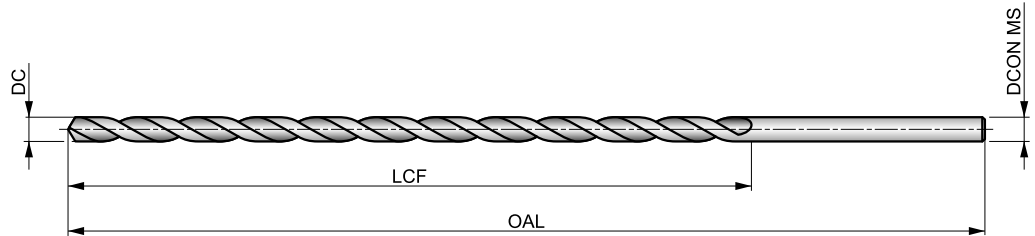

HSS	BS 328	10×D
118°	ST	
λ 20-35°	R	DC h8

De tabel geeft de geschiktheid aan voor de materiaalgroep en de startwaarden voor de snijsnelheid (m/min) en de letter verwijst naar de toe te passen voeding (fn), zie vanaf pagina 175.

P1.1 ■ 21 E	P1.2 ■ 24 E	P1.3 ■ 25 E	P2.1 ■ 18 E	P2.2 ■ 16 C	P2.3 ■ 14 A	P3.1 ■ 9 C	P3.2 ■ 7 C	P3.3 ■ 6 A	P4.1 ■ 5 C	P4.2 ■ 4 A	P4.3 ■ 4 A	M1.1 ■ 12 C	M1.2 ■ 10 C
M2.1 ■ 11 C	M2.2 ■ 9 C	M3.1 ■ 5 E	M3.2 ■ 4 E	M3.3 ■ 4 E	M4.1 ■ 8 A	K1.1 ■ 22 G	K1.2 ■ 16 D	K1.3 ■ 12 D	K2.1 ■ 16 C	K2.2 ■ 13 C	K2.3 ■ 10 C	K3.1 ■ 14 C	K3.2 ■ 11 C
K3.3 ■ 9 C	K4.1 ■ 13 C	K4.2 ■ 10 C	K4.3 ■ 7 C	K4.4 ■ 6 C	K4.5 ■ 5 C	K5.1 ■ 15 C	K5.2 ■ 11 C	K5.3 ■ 9 C	N1.1 ■ 24 H	N1.2 ■ 18 H	N1.3 ■ 12 G	N2.1 ■ 34 F	N2.2 ■ 30 F
N2.3 ■ 22 F	N3.1 ■ 56 F	N3.2 ■ 33 G	N3.3 ■ 17 D	N4.1 ■ 30 H	N4.2 ■ 26 F	N4.3 ■ 10 D	S1.1 ■ 11 D	S1.2 ■ 9 B	S1.3 ■ 5 A	S2.1 ■ 5 C	S2.2 ■ 4 A	S3.1 ■ 4 C	S3.2 ■ 3 A
S4.1 ■ 3 C	S4.2 ■ 2 A												

DC <= 2.2mm; 5/64" blank.

Product	DC (inch)	DC (mm)	DC (inch)	LCF (mm)	OAL (mm)	DCON MS (mm)
A1251.4X160	-	1.40	0.0551	100.0	160.0	1.40
A1251.5X125	-	1.50	0.0591	80.0	125.0	1.50
A1251.5X160	-	1.50	0.0591	100.0	160.0	1.50
A1251/16X125	1/16	1.59	0.0625	80.0	125.0	1.59
A1251/16X160	1/16	1.59	0.0625	100.0	160.0	1.59
A1251.8X160	-	1.80	0.0709	100.0	160.0	1.80
A1255/64X125	5/64	1.98	0.0781	80.0	125.0	1.98
A1255/64X160	5/64	1.98	0.0781	100.0	160.0	1.98
A1252.0X125	-	2.00	0.0787	80.0	125.0	2.00
A1252.0X160	-	2.00	0.0787	100.0	160.0	2.00
A1252.2X160	-	2.20	0.0866	100.0	160.0	2.20
A1253/32X125	3/32	2.38	0.0938	80.0	125.0	2.38
A1253/32X160	3/32	2.38	0.0938	100.0	160.0	2.38
A1252.5X125	-	2.50	0.0984	80.0	125.0	2.50
A1252.5X160	-	2.50	0.0984	100.0	160.0	2.50
A1257/64X125	7/64	2.78	0.1094	80.0	125.0	2.78
A1257/64X160	7/64	2.78	0.1094	100.0	160.0	2.78
A1253.0X160	-	3.00	0.1181	100.0	160.0	3.00
A1253.0X200	-	3.00	0.1181	150.0	200.0	3.00
A1253.0X250	-	3.00	0.1181	200.0	250.0	3.00
A1251/8X160	1/8	3.18	0.1252	100.0	160.0	3.18
A1251/8X200	1/8	3.18	0.1252	150.0	200.0	3.18
A1251/8X250	1/8	3.18	0.1252	200.0	250.0	3.18
A1251/8X315	1/8	3.18	0.1252	250.0	310.0	3.18
A1253.3X160	-	3.30	0.1299	100.0	160.0	3.30
A1253.5X160	-	3.50	0.1378	100.0	160.0	3.50

Product	DC (inch)	DC (mm)	DC (inch)	LCF (mm)	OAL (mm)	DCON MS (mm)
A1253.5X200	-	3.50	0.1378	150.0	200.0	3.50
A1253.5X250	-	3.50	0.1378	200.0	250.0	3.50
A1259/64X160	9/64	3.57	0.1406	100.0	160.0	3.57
A1259/64X200	9/64	3.57	0.1406	150.0	200.0	3.57
A1259/64X315	9/64	3.57	0.1406	250.0	310.0	3.57
A1255/32X160	5/32	3.97	0.1563	100.0	160.0	3.97
A1255/32X200	5/32	3.97	0.1563	150.0	200.0	3.97
A1255/32X250	5/32	3.97	0.1563	200.0	250.0	3.97
A1255/32X315	5/32	3.97	0.1563	250.0	310.0	3.97
A1254.0X160	-	4.00	0.1575	100.0	160.0	4.00
A1254.0X200	-	4.00	0.1575	150.0	200.0	4.00
A1254.0X250	-	4.00	0.1575	200.0	250.0	4.00
A1254.0X315	-	4.00	0.1575	250.0	310.0	4.00
A12511/64X160	11/64	4.37	0.1719	100.0	160.0	4.37
A12511/64X200	11/64	4.37	0.1719	150.0	200.0	4.37
A12511/64X315	11/64	4.37	0.1719	250.0	310.0	4.37
A1254.5X160	-	4.50	0.1772	100.0	160.0	4.50
A1254.5X200	-	4.50	0.1772	150.0	200.0	4.50
A1254.5X250	-	4.50	0.1772	200.0	250.0	4.50
A1254.5X315	-	4.50	0.1772	250.0	310.0	4.50
A1253/16X160	3/16	4.76	0.1875	100.0	160.0	4.76
A1253/16X200	3/16	4.76	0.1875	150.0	200.0	4.76
A1253/16X250	3/16	4.76	0.1875	200.0	250.0	4.76
A1253/16X315	3/16	4.76	0.1875	250.0	310.0	4.76
A1253/16X400	3/16	4.76	0.1875	300.0	400.0	4.76
A1255.0X160	-	5.00	0.1969	100.0	160.0	5.00



Product	DC	DC	DC	LCF	OAL	DCON MS
	(inch)	(mm)	(inch)	(mm)	(mm)	(mm)
A1255.0X200	–	5.00	0.1969	150.0	200.0	5.00
A1255.0X250	–	5.00	0.1969	200.0	250.0	5.00
A1255.0X315	–	5.00	0.1969	250.0	310.0	5.00
A1255.0X400	–	5.00	0.1969	300.0	400.0	5.00
A12513/64X200	13/64	5.16	0.2031	150.0	200.0	5.16
A12513/64X250	13/64	5.16	0.2031	200.0	250.0	5.16
A12513/64X315	13/64	5.16	0.2031	250.0	310.0	5.16
A1255.5X200	–	5.50	0.2165	150.0	200.0	5.50
A1255.5X250	–	5.50	0.2165	200.0	250.0	5.50
A1255.5X315	–	5.50	0.2165	250.0	310.0	5.50
A1257/32X200	7/32	5.56	0.2188	150.0	200.0	5.56
A1257/32X250	7/32	5.56	0.2188	200.0	250.0	5.56
A1257/32X315	7/32	5.56	0.2188	250.0	310.0	5.56
A12515/64X200	15/64	5.95	0.2344	150.0	200.0	5.95
A12515/64X250	15/64	5.95	0.2344	200.0	250.0	5.95
A12515/64X315	15/64	5.95	0.2344	250.0	310.0	5.95
A1256.0X200	–	6.00	0.2362	150.0	200.0	6.00
A1256.0X250	–	6.00	0.2362	200.0	250.0	6.00
A1256.0X315	–	6.00	0.2362	250.0	310.0	6.00
A1256.0X400	–	6.00	0.2362	300.0	400.0	6.00
A1251/4X200	1/4	6.35	0.2500	150.0	200.0	6.35
A1251/4X250	1/4	6.35	0.2500	200.0	250.0	6.35
A1251/4X315	1/4	6.35	0.2500	250.0	310.0	6.35
A1251/4X400	1/4	6.35	0.2500	300.0	400.0	6.35
A1251/4X500	1/4	6.35	0.2500	400.0	460.0	6.35
A1256.5X200	–	6.50	0.2559	150.0	200.0	6.50
A1256.5X250	–	6.50	0.2559	200.0	250.0	6.50
A1256.5X315	–	6.50	0.2559	250.0	310.0	6.50
A12517/64X200	17/64	6.75	0.2656	150.0	200.0	6.75
A12517/64X250	17/64	6.75	0.2656	200.0	250.0	6.75
A12517/64X500	17/64	6.75	0.2656	400.0	460.0	6.75
A1257.0X200	–	7.00	0.2756	150.0	200.0	7.00
A1257.0X250	–	7.00	0.2756	200.0	250.0	7.00
A1257.0X315	–	7.00	0.2756	250.0	310.0	7.00
A1259/32X200	9/32	7.14	0.2813	150.0	200.0	7.14
A1259/32X250	9/32	7.14	0.2813	200.0	250.0	7.14
A1259/32X315	9/32	7.14	0.2813	250.0	310.0	7.14
A1259/32X500	9/32	7.14	0.2813	400.0	460.0	7.14
A1257.5X200	–	7.50	0.2953	150.0	200.0	7.50
A1257.5X250	–	7.50	0.2953	200.0	250.0	7.50
A1257.5X315	–	7.50	0.2953	250.0	310.0	7.50
A12519/64X315	19/64	7.54	0.2969	250.0	310.0	7.54
A12519/64X500	19/64	7.54	0.2969	400.0	460.0	7.54
A1255/16X200	5/16	7.94	0.3125	150.0	200.0	7.94
A1255/16X250	5/16	7.94	0.3125	200.0	250.0	7.94
A1255/16X315	5/16	7.94	0.3125	250.0	310.0	7.94
A1255/16X400	5/16	7.94	0.3125	300.0	400.0	7.94
A1255/16X500	5/16	7.94	0.3125	400.0	460.0	7.94
A1258.0X250	–	8.00	0.3150	200.0	250.0	8.00
A1258.0X315	–	8.00	0.3150	250.0	310.0	8.00
A1258.0X400	–	8.00	0.3150	300.0	400.0	8.00
A12521/64X315	21/64	8.33	0.3281	250.0	310.0	8.33
A12521/64X500	21/64	8.33	0.3281	400.0	460.0	8.33
A1258.5X250	–	8.50	0.3346	200.0	250.0	8.50
A1258.5X315	–	8.50	0.3346	250.0	310.0	8.50
A12511/32X250	11/32	8.73	0.3438	200.0	250.0	8.73
A12511/32X315	11/32	8.73	0.3438	250.0	310.0	8.73
A12511/32X400	11/32	8.73	0.3438	300.0	400.0	8.73
A12511/32X500	11/32	8.73	0.3438	400.0	460.0	8.73
A1259.0X250	–	9.00	0.3543	200.0	250.0	9.00
A1259.0X315	–	9.00	0.3543	250.0	310.0	9.00
A1259.0X400	–	9.00	0.3543	300.0	400.0	9.00
A12523/64X315	23/64	9.13	0.3594	250.0	310.0	9.13
A12523/64X500	23/64	9.13	0.3594	400.0	460.0	9.13
A1259.5X250	–	9.50	0.3740	200.0	250.0	9.50
A1259.5X315	–	9.50	0.3740	250.0	310.0	9.50
A1253/8X250	3/8	9.52	0.3750	200.0	250.0	9.52
A1253/8X315	3/8	9.52	0.3750	250.0	310.0	9.52
A1253/8X400	3/8	9.52	0.3750	300.0	400.0	9.52

Product	DC	DC	DC	LCF	OAL	DCON MS
	(inch)	(mm)	(inch)	(mm)	(mm)	(mm)
A1253/8X500	3/8	9.52	0.3750	400.0	460.0	9.52
A12525/64X315	25/64	9.92	0.3906	250.0	310.0	9.92
A12525/64X500	25/64	9.92	0.3906	400.0	460.0	9.92
A12510.0X250	–	10.00	0.3937	200.0	250.0	10.00
A12510.0X315	–	10.00	0.3937	250.0	310.0	10.00
A12510.0X400	–	10.00	0.3937	300.0	400.0	10.00
A12513/32X250	13/32	10.32	0.4063	200.0	250.0	10.32
A12513/32X315	13/32	10.32	0.4063	250.0	310.0	10.32
A12513/32X500	13/32	10.32	0.4063	400.0	460.0	10.32
A12510.5X250	–	10.50	0.4134	200.0	250.0	10.50
A12510.5X315	–	10.50	0.4134	250.0	310.0	10.50
A12510.5X400	–	10.50	0.4134	300.0	400.0	10.50
A12527/64X315	27/64	10.72	0.4219	250.0	310.0	10.72
A12511.0X250	–	11.00	0.4331	200.0	250.0	11.00
A12511.0X315	–	11.00	0.4331	250.0	310.0	11.00
A12511.0X400	–	11.00	0.4331	300.0	400.0	11.00
A1257/16X250	7/16	11.11	0.4375	200.0	250.0	11.11
A1257/16X315	7/16	11.11	0.4375	250.0	310.0	11.11
A1257/16X400	7/16	11.11	0.4375	300.0	400.0	11.11
A1257/16X500	7/16	11.11	0.4375	400.0	460.0	11.11
A12529/64X315	29/64	11.51	0.4531	250.0	310.0	11.51
A12529/64X500	29/64	11.51	0.4531	400.0	460.0	11.51
A12515/32X250	15/32	11.91	0.4688	200.0	250.0	11.91
A12515/32X315	15/32	11.91	0.4688	250.0	310.0	11.91
A12515/32X500	15/32	11.91	0.4688	400.0	460.0	11.91
A12512.0X250	–	12.00	0.4724	200.0	250.0	12.00
A12512.0X315	–	12.00	0.4724	250.0	310.0	12.00
A12512.0X400	–	12.00	0.4724	300.0	400.0	12.00
A12531/64X315	31/64	12.30	0.4844	250.0	310.0	12.30
A12531/64X500	31/64	12.30	0.4844	400.0	460.0	12.30
A1251/2X250	1/2	12.70	0.5000	200.0	250.0	12.70
A1251/2X315	1/2	12.70	0.5000	250.0	310.0	12.70
A1251/2X400	1/2	12.70	0.5000	300.0	400.0	12.70
A1251/2X500	1/2	12.70	0.5000	400.0	460.0	12.70
A12513.0X315	–	13.00	0.5118	250.0	310.0	13.00
A12513.0X400	–	13.00	0.5118	300.0	400.0	13.00
A12533/64X315	33/64	13.10	0.5156	250.0	310.0	13.10
A12533/64X500	33/64	13.10	0.5156	400.0	460.0	13.10
A12517/32X315	17/32	13.49	0.5313	250.0	310.0	13.49
A12517/32X500	17/32	13.49	0.5313	400.0	460.0	13.49
A12535/64X315	35/64	13.89	0.5469	250.0	310.0	13.89
A12535/64X500	35/64	13.89	0.5469	400.0	460.0	13.89
A12514.0X315	–	14.00	0.5512	250.0	310.0	14.00
A12514.0X400	–	14.00	0.5512	300.0	400.0	14.00
A1259/16X315	9/16	14.29	0.5625	250.0	310.0	14.29
A1259/16X500	9/16	14.29	0.5625	400.0	460.0	14.29
A12537/64X315	37/64	14.68	0.5781	250.0	310.0	14.68
A12519/32X315	19/32	15.08	0.5938	250.0	310.0	15.08
A12519/32X500	19/32	15.08	0.5938	400.0	460.0	15.08
A12539/64X315	39/64	15.48	0.6094	250.0	310.0	15.48
A12539/64X500	39/64	15.48	0.6094	400.0	460.0	15.48
A1255/8X315	5/8	15.88	0.6250	250.0	310.0	15.88
A1255/8X500	5/8	15.88	0.6250	400.0	460.0	15.88
A12521/32X315	21/32	16.67	0.6563	250.0	310.0	16.67
A12521/32X500	21/32	16.67	0.6563	400.0	460.0	16.67
A12511/16X315	11/16	17.46	0.6875	250.0	310.0	17.46
A12511/16X500	11/16	17.46	0.6875	400.0	460.0	17.46
A12523/32X315	23/32	18.26	0.7188	250.0	310.0	18.26
A12523/32X500	23/32	18.26	0.7188	400.0	460.0	18.26
A1253/4X315	3/4	19.05	0.7500	250.0	310.0	19.05
A1253/4X500	3/4	19.05	0.7500	400.0	460.0	19.05
A12525/32X500	25/32	19.84	0.7813	400.0	460.0	19.84
A12513/16X500	13/16	20.64	0.8125	400.0	460.0	20.64
A1257/8X500	7/8	22.22	0.8750	400.0	460.0	22.22
A12515/16X500	15/16	23.81	0.9375	400.0	460.0	23.81
A1251X500	1"	25.40	1.0000	400.0	460.0	25.40



A976



PFX HSS-E (5% Co) extra lange productieboor, DIN1869-1

Hoogproductieve spiraalboor voor het boren van gaten van hoge kwaliteit en nauwkeurigheid bij hoge snelheden en voedingen (H10). Zelfcentrerende 130° tophoek en speciale parabolische spaangroefvorm helpen in samenwerking met de unieke snijkantsgeometrie om spanen zo te vormen dat ze makkelijk zijn af te voeren. Daardoor is het mogelijk diepe gaten te boren in één arbeidsgang. Geschikt voor vele materialen.

PFX

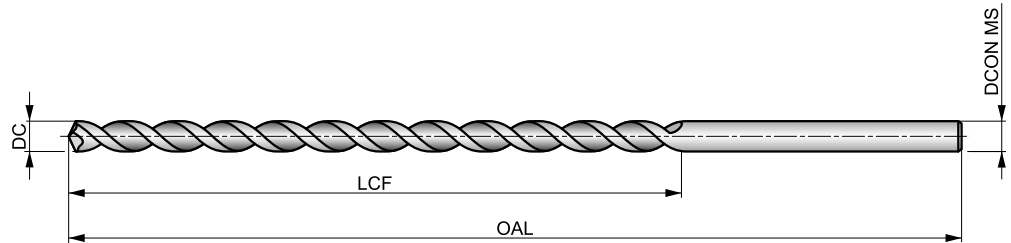

HSS-E	DIN 1869-1	15×D
130°	Bright	
λ>35°	R	DC h8

De tabel geeft de geschiktheid aan voor de materiaalgroep en de startwaarden voor de snijsnelheid (m/min) en de letter verwijst naar de toe te passen voeding (fn), zie vanaf pagina 175.

P1.1 ■29 C	P1.2 ■33 C	P1.3 ■34 C	P2.1 ■25 C	P2.2 ■22 C	P2.3 ■19 A	P3.1 ■18 C	P3.2 ■14 C	P3.3 ■12 A	P4.1 ■11 C	P4.2 ■9 A	P4.3 ■7 A	M1.1 ■16 B	M1.2 ■14 B
M2.1 ■15 B	M2.2 ■12 B	M3.1 ■8 C	M3.2 ■7 C	M3.3 ■6 C	M4.1 ■8 A	K2.1 ■20 C	K2.2 ■16 C	K2.3 ■13 A	K3.1 ■17 C	K3.2 ■13 C	K3.3 ■11 A	K4.1 ■16 C	K4.2 ■12 C
K4.3 ■9 A	K4.4 ■8 A	K4.5 ■6 A	K5.1 ■18 C	K5.2 ■14 C	K5.3 ■11 A	N3.1 ■30 D	S1.1 ■15 C	S1.2 ■11 A	S1.3 ■5 A				

Product	DC (inch)	DC (mm)	DC (inch)	LCF (mm)	OAL (mm)	DCON MS (mm)
A9761.5	—	1.50	0.0591	75.0	115.0	1.50
A9762.0X125	—	2.00	0.0787	85.0	125.0	2.00
A9762.1X125	—	2.10	0.0827	85.0	125.0	2.10
A9762.2X135	—	2.20	0.0866	90.0	135.0	2.20
A9762.3X135	—	2.30	0.0906	90.0	135.0	2.30
A9762.4X140	—	2.40	0.0945	95.0	140.0	2.40
A9762.5X140	—	2.50	0.0984	95.0	140.0	2.50
A9762.6X140	—	2.60	0.1024	95.0	140.0	2.60
A9762.7X150	—	2.70	0.1063	100.0	150.0	2.70
A9762.8X150	—	2.80	0.1102	100.0	150.0	2.80
A9762.9X150	—	2.90	0.1142	100.0	150.0	2.90
A9763.0X150	—	3.00	0.1181	100.0	150.0	3.00
A9763.1X155	—	3.10	0.1220	105.0	155.0	3.10
A9761/8	1/8	3.18	0.1252	105.0	155.0	3.18
A9763.2X155	—	3.20	0.1260	105.0	155.0	3.20
A9763.3X155	—	3.30	0.1299	105.0	155.0	3.30
A9763.4X165	—	3.40	0.1339	115.0	165.0	3.40
A9763.5X165	—	3.50	0.1378	115.0	165.0	3.50
A9763.6X165	—	3.60	0.1417	115.0	165.0	3.60
A9763.7X165	—	3.70	0.1457	115.0	165.0	3.70
A9763.8X175	—	3.80	0.1496	120.0	175.0	3.80
A9763.9X175	—	3.90	0.1535	120.0	175.0	3.90
A9765/32	5/32	3.97	0.1563	120.0	175.0	3.97
A9764.0X175	—	4.00	0.1575	120.0	175.0	4.00
A9764.1X175	—	4.10	0.1614	120.0	175.0	4.10
A9764.2X175	—	4.20	0.1654	120.0	175.0	4.20
A9764.3X185	—	4.30	0.1693	125.0	185.0	4.30
A9764.4X185	—	4.40	0.1732	125.0	185.0	4.40

Product	DC (inch)	DC (mm)	DC (inch)	LCF (mm)	OAL (mm)	DCON MS (mm)
A9764.5X185	—	4.50	0.1772	125.0	185.0	4.50
A9764.6X185	—	4.60	0.1811	125.0	185.0	4.60
A9764.7X185	—	4.70	0.1850	125.0	185.0	4.70
A9763/16	3/16	4.76	0.1875	135.0	195.0	4.76
A9764.8X195	—	4.80	0.1890	135.0	195.0	4.80
A9764.9X195	—	4.90	0.1929	135.0	195.0	4.90
A9765.0X195	—	5.00	0.1969	135.0	195.0	5.00
A9765.1X195	—	5.10	0.2008	135.0	195.0	5.10
A9765.2X195	—	5.20	0.2047	135.0	195.0	5.20
A9765.3X195	—	5.30	0.2087	135.0	195.0	5.30
A9765.4X205	—	5.40	0.2126	140.0	205.0	5.40
A9765.5X205	—	5.50	0.2165	140.0	205.0	5.50
A9765.6X205	—	5.60	0.2205	140.0	205.0	5.60
A9765.7X205	—	5.70	0.2244	140.0	205.0	5.70
A9765.8X205	—	5.80	0.2283	140.0	205.0	5.80
A9765.9X205	—	5.90	0.2323	140.0	205.0	5.90
A9766.0X205	—	6.00	0.2362	140.0	205.0	6.00
A9766.1X215	—	6.10	0.2402	150.0	215.0	6.10
A9766.2X215	—	6.20	0.2441	150.0	215.0	6.20
A9766.3X215	—	6.30	0.2480	150.0	215.0	6.30
A9761/4	1/4	6.35	0.2500	150.0	215.0	6.35
A9766.4X215	—	6.40	0.2520	150.0	215.0	6.40
A9766.5X215	—	6.50	0.2559	150.0	215.0	6.50
A9766.6X215	—	6.60	0.2598	150.0	215.0	6.60
A9766.7X215	—	6.70	0.2638	150.0	215.0	6.70
A9766.8X225	—	6.80	0.2677	155.0	225.0	6.80
A9766.9X225	—	6.90	0.2717	155.0	225.0	6.90
A9767.0X225	—	7.00	0.2756	155.0	225.0	7.00



Product	DC	DC	DC	LCF	OAL	DCON MS
	(inch)	(mm)	(inch)	(mm)	(mm)	(mm)
A9767.5X225	–	7.50	0.2953	155.0	225.0	7.50
A9765/16	5/16	7.94	0.3125	165.0	240.0	7.94
A9768.0X240	–	8.00	0.3150	165.0	240.0	8.00
A9768.5X240	–	8.50	0.3346	165.0	240.0	8.50
A97611/32	11/32	8.73	0.3438	175.0	250.0	8.73
A9769.0X250	–	9.00	0.3543	175.0	250.0	9.00
A9769.5X250	–	9.50	0.3740	175.0	250.0	9.50
A9763/8	3/8	9.52	0.3750	185.0	265.0	9.52
A97610.0X265	–	10.00	0.3937	185.0	265.0	10.00

¹⁾ Dormer norm.

Product	DC	DC	DC	LCF	OAL	DCON MS
	(inch)	(mm)	(inch)	(mm)	(mm)	(mm)
A97610.5	–	10.50	0.4134	185.0	265.0	10.50
A97611.0	–	11.00	0.4331	195.0	280.0	11.00
A9767/16	7/16	11.11	0.4375	195.0	280.0	11.11
A97611.5	–	11.50	0.4528	195.0	280.0	11.50
A97612.0	–	12.00	0.4724	205.0	295.0	12.00
A97612.5	–	12.50	0.4921	205.0	295.0	12.50
A9761/2	1/2	12.70	0.5000	205.0	295.0	12.70
A97613.0	–	13.00	0.5118	205.0	295.0	13.00
A97614.0 ¹⁾	–	14.00	0.5512	215.0	310.0	14.00



A977



PFX HSS-E (5% Co) superlange productieboor, DIN1869-2

Hoogproductieve spiraalboor voor het boren van gaten van hoge kwaliteit en nauwkeurigheid bij hoge snelheden en voedingen (H10). Zelfcentrerende 130° tophoek en speciale parabolische spaangroefvorm helpen in samenwerking met de unieke snijkantsgeometrie om spanen zo te vormen dat ze makkelijk zijn af te voeren. Daardoor is het mogelijk diepe gaten te boren in één arbeidsgang. Geschikt voor vele materialen.



PFX

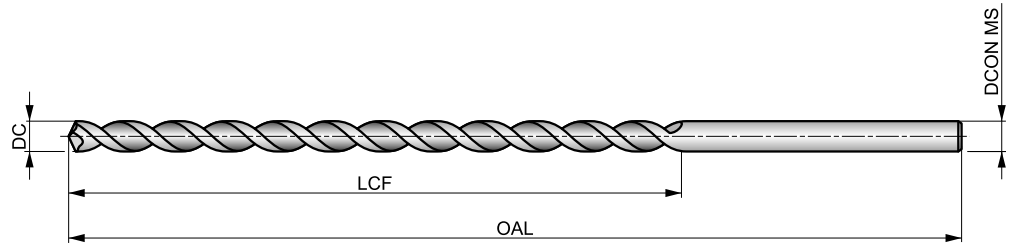

HSS-E	DIN 1869-2	20×D
130°	Bright	
λ>35°	R	DC h8

De tabel geeft de geschiktheid aan voor de materiaalgroep en de startwaarden voor de snijsnelheid (m/min) en de letter verwijst naar de toe te passen voeding (fn), zie vanaf pagina 175.

P1.1 ■29 B	P1.2 ■33 B	P1.3 ■34 B	P2.1 ■25 B	P2.2 ■22 B	P2.3 ■19 A	P3.1 ■18 B	P3.2 ■14 B	P3.3 ■12 A	P4.1 ■11 B	P4.2 ■9 A	P4.3 ■7 A	M1.1 ■16 B	M1.2 ■14 B
M2.1 ■15 B	M2.2 ■12 B	M3.1 ■8 B	M3.2 ■7 B	M3.3 ■6 B	M4.1 ■8 A	K2.1 ■20 B	K2.2 ■16 B	K2.3 ■13 A	K3.1 ■17 B	K3.2 ■13 B	K3.3 ■11 A	K4.1 ■16 B	K4.2 ■12 B
K4.3 ■9 A	K4.4 ■8 A	K4.5 ■6 A	K5.1 ■18 B	K5.2 ■14 B	K5.3 ■11 A	N3.1 ■30 C	S1.1 ■15 B	S1.2 ■11 A	S1.3 ■5 A				

Product	DC (inch)	DC (mm)	DC (inch)	LCF (mm)	OAL (mm)	DCON MS (mm)
A9771.5 ¹⁾	—	1.50	0.0591	100.0	150.0	1.50
A9771/16 ¹⁾	1/16	1.59	0.0625	100.0	150.0	1.59
A9772.0 ¹⁾	—	2.00	0.0787	110.0	160.0	2.00
A9773/32 ¹⁾	3/32	2.38	0.0938	115.0	170.0	2.38
A9773.0X190	—	3.00	0.1181	130.0	190.0	3.00
A9771/8	1/8	3.18	0.1250	135.0	200.0	3.18
A9773.5X210	—	3.50	0.1378	145.0	210.0	3.50
A9774.0X220	—	4.00	0.1575	150.0	220.0	4.00
A9774.5X235	—	4.50	0.1772	160.0	235.0	4.50
A9773/16	3/16	4.76	0.1875	170.0	245.0	4.76
A9775.0X245	—	5.00	0.1969	170.0	245.0	5.00
A9775.5X260	—	5.50	0.2165	180.0	260.0	5.50
A9776.0X260	—	6.00	0.2362	180.0	260.0	6.00
A9771/4	1/4	6.35	0.2500	190.0	275.0	6.35
A9776.5X275	—	6.50	0.2559	190.0	275.0	6.50

¹⁾ Dormer norm.

Product	DC (inch)	DC (mm)	DC (inch)	LCF (mm)	OAL (mm)	DCON MS (mm)
A9777.0X290	—	7.00	0.2756	200.0	290.0	7.00
A9777.5X290	—	7.50	0.2953	200.0	290.0	7.50
A9778.0X305	—	8.00	0.3150	210.0	305.0	8.00
A9778.5X305	—	8.50	0.3346	210.0	305.0	8.50
A97711/32	11/32	8.73	0.3438	220.0	320.0	8.73
A9779.0X320	—	9.00	0.3543	220.0	320.0	9.00
A9779.5X320	—	9.50	0.3740	220.0	320.0	9.50
A97710.0X340	—	10.00	0.3937	235.0	340.0	10.00
A97710.5	—	10.50	0.4134	235.0	340.0	10.50
A97711.0	—	11.00	0.4331	250.0	365.0	11.00
A97711.5	—	11.50	0.4528	250.0	365.0	11.50
A97712.0	—	12.00	0.4724	260.0	375.0	12.00
A97712.5	—	12.50	0.4921	260.0	375.0	12.50
A97713.0	—	13.00	0.5118	260.0	375.0	13.00
A97714.0 ¹⁾	—	14.00	0.5512	270.0	390.0	14.00



A978



PFX HSS-E (5% Co) superlange productieboor, DIN1869-3

Hoogproductieve spiraalboor voor het boren van gaten van hoge kwaliteit en nauwkeurigheid bij hoge snelheden en voedingen (H10). Zelfcenterende 130° tophoek en speciale parabolische spaangroefvorm helpen in samenwerking met de unieke snijkantsgeometrie om spanen zo te vormen dat ze makkelijk zijn af te voeren. Daardoor is het mogelijk diepe gaten te boren in één arbeidsgang. Geschikt voor vele materialen.

PFX

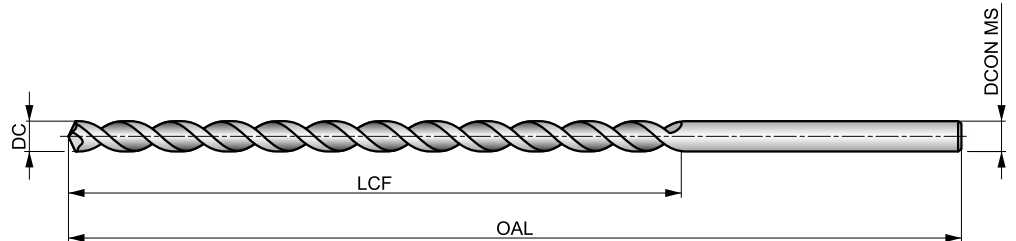

HSS-E	DIN 1869-3	25xD
130°	Bright	
$\lambda > 35^\circ$	R	DC h8

De tabel geeft de geschiktheid aan voor de materiaalgroep en de startwaarden voor de snijsnelheid (m/min) en de letter verwijst naar de toe te passen voeding (fn), zie vanaf pagina 175.

P1.1 ▣ 29 A	P1.2 ▣ 33 A	P1.3 ▣ 34 A	P2.1 ▣ 25 A	P2.2 ▣ 22 A	P2.3 ▣ 19 A	P3.1 ▣ 18 A	P3.2 ▣ 14 A	P3.3 ▣ 12 A	P4.1 ▣ 11 A	P4.2 ▣ 9 A	P4.3 ▣ 7 A	M1.1 ▣ 16 A	M1.2 ▣ 14 A
M2.1 ▣ 15 A	M2.2 ▣ 12 A	M3.1 ▣ 8 A	M3.2 ▣ 7 A	M3.3 ▣ 6 A	M4.1 ▣ 8 A	K2.1 ▣ 20 A	K2.2 ▣ 16 A	K2.3 ▣ 13 A	K3.1 ▣ 17 A	K3.2 ▣ 13 A	K3.3 ▣ 11 A	K4.1 ▣ 16 A	K4.2 ▣ 12 A
K4.3 ▣ 9 A	K4.4 ▣ 8 A	K4.5 ▣ 6 A	K5.1 ▣ 18 A	K5.2 ▣ 14 A	K5.3 ▣ 11 A	N3.1 ▣ 30 B	S1.1 ▣ 15 A	S1.2 ▣ 11 A	S1.3 ▣ 5 A				

Product	DC	DC	DC	LCF	OAL	DCON MS
	(inch)	(mm)	(inch)			
A9783.0 ¹⁾	–	3.00	0.1181	160.0	240.0	3.00
A9783.5X265	–	3.50	0.1378	180.0	265.0	3.50
A9784.0X280	–	4.00	0.1575	190.0	280.0	4.00
A9784.5X295	–	4.50	0.1772	200.0	295.0	4.50
A9785.0X315	–	5.00	0.1969	210.0	315.0	5.00
A9785.5X330	–	5.50	0.2165	225.0	330.0	5.50
A9786.0X330	–	6.00	0.2362	225.0	330.0	6.00
A9781/4	1/4	6.35	0.2500	235.0	350.0	6.35
A9786.5X350	–	6.50	0.2559	235.0	350.0	6.50
A9787.0X370	–	7.00	0.2756	250.0	370.0	7.00
A9787.5X370	–	7.50	0.2953	250.0	370.0	7.50
A9788.0X390	–	8.00	0.3150	265.0	390.0	8.00
A9788.5X390	–	8.50	0.3346	265.0	390.0	8.50
A9789.0X410	–	9.00	0.3543	280.0	410.0	9.00
A9789.5X410	–	9.50	0.3740	280.0	410.0	9.50
A97810.0X430	–	10.00	0.3937	295.0	430.0	10.00

¹⁾ Dormer norm.



A130



HSS spiraalboor, MC schacht, stoomontlaten

Morseconusboor met een sterke 118° tophoek die gemakkelijk naslijpbaar is. Het robuuste ontwerp zorgt voor betere prestaties bij gebruik op conventionele machines. Geschikt voor het boren van vele materialen. De stoomontlaten afwerking houdt snijvloeistof vast en voorkomt het aanlassen van spanen. Geschikt voor het boren in vele materialen.

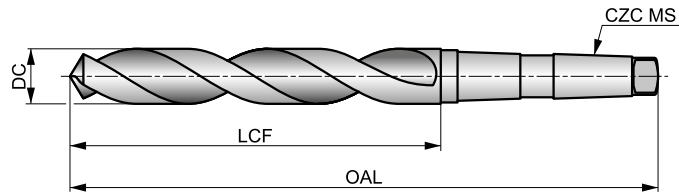

HSS	DIN 345	4xD
118°	ST	
λ 20-35°	R	DC h8

De tabel geeft de geschiktheid aan voor de materiaalgroep en de startwaarden voor de snijnsnelheid (m/min) en de letter verwijst naar de toe te passen voeding (fn), zie vanaf pagina 175.

P1.1 ■ 33 I	P1.2 ■ 37 I	P1.3 ■ 38 I	P2.1 ■ 28 I	P2.2 ■ 25 F	P2.3 ■ 22 E	P3.1 ■ 18 F	P3.2 ■ 14 F	P3.3 ■ 12 E	P4.1 ■ 11 F	P4.2 ■ 9 E	P4.3 ■ 7 D	M1.1 ■ 21 E	M1.2 ■ 17 E
M2.1 ■ 18 E	M2.2 ■ 15 E	M3.1 ■ 10 G	M3.2 ■ 9 G	M3.3 ■ 8 G	M4.1 ■ 10 C	K1.1 ■ 30 I	K1.2 ■ 22 E	K1.3 ■ 17 E	K2.1 ■ 25 E	K2.2 ■ 20 E	K2.3 ■ 16 E	K3.1 ■ 22 E	K3.2 ■ 17 E
K3.3 ■ 13 E	K4.1 ■ 20 E	K4.2 ■ 15 E	K4.3 ■ 11 E	K4.4 ■ 10 E	K4.5 ■ 8 E	K5.1 ■ 23 E	K5.2 ■ 17 E	K5.3 ■ 13 E	N1.1 ■ 26 J	N1.2 ■ 20 J	N1.3 ■ 13 I	N2.1 ■ 43 H	N2.2 ■ 39 H
N2.3 ■ 28 H	N3.1 ■ 59 H	N3.2 ■ 35 I	N3.3 ■ 18 F	N4.1 ■ 30 K	N4.2 ■ 28 J	N4.3 ■ 14 H	S1.1 ■ 23 F	S1.2 ■ 13 D	S1.3 ■ 7 B	S2.1 ■ 9 E	S2.2 ■ 6 A	S3.1 ■ 7 E	S3.2 ■ 4 A
S4.1 ■ 5 E	S4.2 ■ 3 A												

DC > 14mm uitgedunde ziel.

Product	DC	DC	DC	LCF	OAL	CZC MS
	(inch)	(mm)	(inch)	(mm)	(mm)	
A1303.0	—	3.00	0.1181	33.0	114.0	MK 1
A1301/8	1/8	3.18	0.1252	36.0	117.0	MK 1
A1303.2	—	3.20	0.1260	36.0	117.0	MK 1
A1303.25	—	3.25	0.1280	36.0	117.0	MK 1
A1303.3	—	3.30	0.1299	36.0	117.0	MK 1
A1303.5	—	3.50	0.1378	39.0	120.0	MK 1
A1309/64	9/64	3.57	0.1406	39.0	120.0	MK 1
A1303.75	—	3.75	0.1476	39.0	120.0	MK 1
A1305/32	5/32	3.97	0.1563	43.0	124.0	MK 1
A1304.0	—	4.00	0.1575	43.0	124.0	MK 1
A1304.1	—	4.10	0.1614	43.0	124.0	MK 1
A1304.2	—	4.20	0.1654	43.0	124.0	MK 1
A1304.25	—	4.25	0.1673	43.0	124.0	MK 1
A13011/64	11/64	4.37	0.1719	47.0	128.0	MK 1
A1304.5	—	4.50	0.1772	47.0	128.0	MK 1
A1304.75	—	4.75	0.1870	52.0	128.0	MK 1
A1303/16	3/16	4.76	0.1875	52.0	133.0	MK 1
A1304.8	—	4.80	0.1890	52.0	133.0	MK 1
A1304.9	—	4.90	0.1929	52.0	133.0	MK 1
A1305.0	—	5.00	0.1969	52.0	133.0	MK 1
A1305.1	—	5.10	0.2008	52.0	133.0	MK 1
A13013/64	13/64	5.16	0.2031	52.0	133.0	MK 1
A1305.2	—	5.20	0.2047	52.0	133.0	MK 1



Product	DC	DC	DC	LCF	OAL	CZC MS
	(inch)	(mm)	(inch)	(mm)	(mm)	
A1305.25	–	5.25	0.2067	52.0	133.0	MK 1
A1305.4	–	5.40	0.2126	57.0	138.0	MK 1
A1305.5	–	5.50	0.2165	57.0	138.0	MK 1
A1307/32	7/32	5.56	0.2188	57.0	138.0	MK 1
A1305.7	–	5.70	0.2244	57.0	138.0	MK 1
A1305.75	–	5.75	0.2264	57.0	138.0	MK 1
A1305.8	–	5.80	0.2283	57.0	138.0	MK 1
A1305.9	–	5.90	0.2323	57.0	138.0	MK 1
A13015/64	15/64	5.95	0.2344	57.0	138.0	MK 1
A1306.0	–	6.00	0.2362	57.0	138.0	MK 1
A1306.1	–	6.10	0.2402	63.0	144.0	MK 1
A1306.2	–	6.20	0.2441	63.0	144.0	MK 1
A1306.25	–	6.25	0.2461	63.0	144.0	MK 1
A1306.3	–	6.30	0.2480	63.0	144.0	MK 1
A1301/4	1/4	6.35	0.2500	63.0	144.0	MK 1
A1306.4	–	6.40	0.2520	63.0	144.0	MK 1
A1306.5	–	6.50	0.2559	63.0	144.0	MK 1
A1306.6	–	6.60	0.2598	63.0	144.0	MK 1
A1306.7	–	6.70	0.2638	63.0	144.0	MK 1
A13017/64	17/64	6.75	0.2656	69.0	150.0	MK 1
A1306.75	–	6.75	0.2657	69.0	150.0	MK 1
A1306.8	–	6.80	0.2677	69.0	150.0	MK 1
A1306.9	–	6.90	0.2717	69.0	150.0	MK 1
A1307.0	–	7.00	0.2756	69.0	150.0	MK 1
A1309/32	9/32	7.14	0.2813	69.0	150.0	MK 1
A1307.2	–	7.20	0.2835	69.0	150.0	MK 1
A1307.25	–	7.25	0.2854	69.0	150.0	MK 1
A1307.3	–	7.30	0.2874	69.0	150.0	MK 1
A1307.4	–	7.40	0.2913	69.0	150.0	MK 1
A1307.5	–	7.50	0.2953	69.0	150.0	MK 1
A13019/64	19/64	7.54	0.2969	75.0	156.0	MK 1
A1307.7	–	7.70	0.3031	75.0	156.0	MK 1
A1307.75	–	7.75	0.3051	75.0	156.0	MK 1
A1307.8	–	7.80	0.3071	75.0	156.0	MK 1
A1307.9	–	7.90	0.3110	75.0	156.0	MK 1
A1305/16	5/16	7.94	0.3125	75.0	156.0	MK 1
A1308.0	–	8.00	0.3150	75.0	156.0	MK 1
A1308.1	–	8.10	0.3189	75.0	156.0	MK 1
A1308.2	–	8.20	0.3228	75.0	156.0	MK 1
A1308.25	–	8.25	0.3248	75.0	156.0	MK 1
A1308.3	–	8.30	0.3268	75.0	156.0	MK 1
A13021/64	21/64	8.33	0.3281	75.0	156.0	MK 1
A1308.4	–	8.40	0.3307	75.0	156.0	MK 1
A1308.5	–	8.50	0.3346	75.0	156.0	MK 1
A1308.6	–	8.60	0.3386	81.0	162.0	MK 1
A1308.7	–	8.70	0.3425	81.0	162.0	MK 1
A13011/32	11/32	8.73	0.3438	81.0	162.0	MK 1
A1308.75	–	8.75	0.3445	81.0	162.0	MK 1
A1308.8	–	8.80	0.3465	81.0	162.0	MK 1
A1308.9	–	8.90	0.3504	81.0	162.0	MK 1
A1309.0	–	9.00	0.3543	81.0	162.0	MK 1
A1309.1	–	9.10	0.3583	81.0	162.0	MK 1
A13023/64	23/64	9.13	0.3594	81.0	162.0	MK 1
A1309.2	–	9.20	0.3622	81.0	162.0	MK 1
A1309.25	–	9.25	0.3642	81.0	162.0	MK 1
A1309.3	–	9.30	0.3661	81.0	162.0	MK 1
A1309.5	–	9.50	0.3740	81.0	162.0	MK 1
A1303/8	3/8	9.52	0.3750	87.0	168.0	MK 1
A1309.6	–	9.60	0.3780	87.0	168.0	MK 1
A1309.7	–	9.70	0.3819	87.0	168.0	MK 1
A1309.75	–	9.75	0.3839	87.0	168.0	MK 1
A1309.8	–	9.80	0.3858	87.0	168.0	MK 1



Product	DC	DC	DC	LCF	OAL	CZC MS
	(inch)	(mm)	(inch)	(mm)	(mm)	
A1309.9	—	9.90	0.3898	87.0	168.0	MK 1
A13025/64	25/64	9.92	0.3906	87.0	168.0	MK 1
A13010.0	—	10.00	0.3937	87.0	168.0	MK 1
A13010.1	—	10.10	0.3976	87.0	168.0	MK 1
A13010.2	—	10.20	0.4016	87.0	168.0	MK 1
A13010.25	—	10.25	0.4035	87.0	168.0	MK 1
A13010.3	—	10.30	0.4055	87.0	168.0	MK 1
A13013/32	13/32	10.32	0.4063	87.0	168.0	MK 1
A13010.5	—	10.50	0.4134	87.0	168.0	MK 1
A13027/64	27/64	10.72	0.4219	94.0	175.0	MK 1
A13010.75	—	10.75	0.4232	94.0	175.0	MK 1
A13010.8	—	10.80	0.4252	94.0	175.0	MK 1
A13010.9	—	10.90	0.4291	94.0	175.0	MK 1
A13011.0	—	11.00	0.4331	94.0	175.0	MK 1
A13011.1	—	11.10	0.4370	94.0	175.0	MK 1
A1307/16	7/16	11.11	0.4375	94.0	175.0	MK 1
A13011.2	—	11.20	0.4409	94.0	175.0	MK 1
A13011.25	—	11.25	0.4429	94.0	175.0	MK 1
A13011.3	—	11.30	0.4449	94.0	175.0	MK 1
A13011.4	—	11.40	0.4488	94.0	175.0	MK 1
A13011.5	—	11.50	0.4528	94.0	175.0	MK 1
A13029/64	29/64	11.51	0.4531	94.0	175.0	MK 1
A13011.6	—	11.60	0.4567	94.0	175.0	MK 1
A13011.7	—	11.70	0.4606	94.0	175.0	MK 1
A13011.75	—	11.75	0.4626	94.0	175.0	MK 1
A13011.8	—	11.80	0.4646	94.0	175.0	MK 1
A13011.9	—	11.90	0.4685	101.0	182.0	MK 1
A13015/32	15/32	11.91	0.4688	101.0	182.0	MK 1
A13012.0	—	12.00	0.4724	101.0	182.0	MK 1
A13012.1	—	12.10	0.4764	101.0	182.0	MK 1
A13012.2	—	12.20	0.4803	101.0	182.0	MK 1
A13012.25	—	12.25	0.4823	101.0	182.0	MK 1
A13031/64	31/64	12.30	0.4844	101.0	182.0	MK 1
A13012.3	—	12.30	0.4843	101.0	182.0	MK 1
A13012.4	—	12.40	0.4882	101.0	182.0	MK 1
A13012.5	—	12.50	0.4921	101.0	182.0	MK 1
A13012.6	—	12.60	0.4961	101.0	182.0	MK 1
A13012.7	—	12.70	0.5000	101.0	182.0	MK 1
A1301/2	1/2	12.70	0.5000	101.0	182.0	MK 1
A13012.75	—	12.75	0.5020	101.0	182.0	MK 1
A13012.8	—	12.80	0.5039	101.0	182.0	MK 1
A13012.9	—	12.90	0.5079	101.0	182.0	MK 1
A13013.0	—	13.00	0.5118	101.0	182.0	MK 1
A13033/64	33/64	13.10	0.5156	101.0	182.0	MK 1
A13013.2	—	13.20	0.5197	101.0	182.0	MK 1
A13013.25	—	13.25	0.5217	108.0	189.0	MK 1
A13017/32	17/32	13.49	0.5313	108.0	189.0	MK 1
A13013.5	—	13.50	0.5315	108.0	189.0	MK 1
A13013.6	—	13.60	0.5354	108.0	189.0	MK 1
A13013.7	—	13.70	0.5394	108.0	189.0	MK 1
A13013.75	—	13.75	0.5413	108.0	189.0	MK 1
A13013.8	—	13.80	0.5433	108.0	189.0	MK 1
A13035/64	35/64	13.89	0.5469	108.0	189.0	MK 1
A13013.9	—	13.90	0.5472	108.0	189.0	MK 1
A13014.0	—	14.00	0.5512	108.0	189.0	MK 1
A13014.1	—	14.10	0.5551	114.0	212.0	MK 2
A13014.2	—	14.20	0.5591	114.0	212.0	MK 2
A13014.25	—	14.25	0.5610	114.0	212.0	MK 2
A1309/16	9/16	14.29	0.5625	114.0	212.0	MK 2
A13014.3	—	14.30	0.5630	114.0	212.0	MK 2
A13014.4	—	14.40	0.5669	114.0	212.0	MK 2
A13014.5	—	14.50	0.5709	114.0	212.0	MK 2



Product	DC	DC	DC	LCF	OAL	CZC MS
	(inch)	(mm)	(inch)	(mm)	(mm)	
A13014.6	–	14.60	0.5748	114.0	212.0	MK 2
A13037/64	37/64	14.68	0.5781	114.0	212.0	MK 2
A13014.7	–	14.70	0.5787	114.0	212.0	MK 2
A13014.75	–	14.75	0.5807	114.0	212.0	MK 2
A13014.8	–	14.80	0.5827	114.0	212.0	MK 2
A13014.9	–	14.90	0.5866	114.0	212.0	MK 2
A13015.0	–	15.00	0.5906	114.0	212.0	MK 2
A13019/32	19/32	15.08	0.5938	120.0	218.0	MK 2
A13015.1	–	15.10	0.5945	120.0	218.0	MK 2
A13015.2	–	15.20	0.5984	120.0	218.0	MK 2
A13015.25	–	15.25	0.6004	120.0	218.0	MK 2
A13039/64	39/64	15.48	0.6094	120.0	218.0	MK 2
A13015.5	–	15.50	0.6102	120.0	218.0	MK 2
A13015.7	–	15.70	0.6181	120.0	218.0	MK 2
A13015.75	–	15.75	0.6201	120.0	218.0	MK 2
A13015.8	–	15.80	0.6220	120.0	218.0	MK 2
A1305/8	5/8	15.88	0.6250	120.0	218.0	MK 2
A13015.9	–	15.90	0.6260	120.0	218.0	MK 2
A13016.0	–	16.00	0.6299	120.0	218.0	MK 2
A13016.1	–	16.10	0.6339	125.0	223.0	MK 2
A13016.2	–	16.20	0.6378	125.0	223.0	MK 2
A13016.25	–	16.25	0.6398	125.0	223.0	MK 2
A13041/64	41/64	16.27	0.6406	125.0	223.0	MK 2
A13016.5	–	16.50	0.6496	125.0	223.0	MK 2
A13021/32	21/32	16.67	0.6563	125.0	223.0	MK 2
A13016.75	–	16.75	0.6594	125.0	223.0	MK 2
A13017.0	–	17.00	0.6693	125.0	223.0	MK 2
A13043/64	43/64	17.07	0.6719	130.0	228.0	MK 2
A13017.25	–	17.25	0.6791	130.0	228.0	MK 2
A13011/16	11/16	17.46	0.6875	130.0	228.0	MK 2
A13017.5	–	17.50	0.6890	130.0	228.0	MK 2
A13017.75	–	17.75	0.6988	130.0	228.0	MK 2
A13045/64	45/64	17.86	0.7031	130.0	228.0	MK 2
A13018.0	–	18.00	0.7087	130.0	228.0	MK 2
A13018.25	–	18.25	0.7185	135.0	233.0	MK 2
A13023/32	23/32	18.26	0.7188	135.0	233.0	MK 2
A13018.5	–	18.50	0.7283	135.0	233.0	MK 2
A13047/64	47/64	18.65	0.7344	135.0	233.0	MK 2
A13018.75	–	18.75	0.7382	135.0	233.0	MK 2
A13019.0	–	19.00	0.7480	135.0	233.0	MK 2
A1303/4	3/4	19.05	0.7500	140.0	238.0	MK 2
A13019.25	–	19.25	0.7579	140.0	238.0	MK 2
A13049/64	49/64	19.45	0.7656	140.0	238.0	MK 2
A13019.5	–	19.50	0.7677	140.0	238.0	MK 2
A13019.75	–	19.75	0.7776	140.0	238.0	MK 2
A13025/32	25/32	19.84	0.7813	140.0	238.0	MK 2
A13020.0	–	20.00	0.7874	140.0	238.0	MK 2
A13051/64	51/64	20.24	0.7969	145.0	243.0	MK 2
A13020.25	–	20.25	0.7972	145.0	243.0	MK 2
A13020.4	–	20.40	0.8031	145.0	243.0	MK 2
A13020.5	–	20.50	0.8071	145.0	243.0	MK 2
A13013/16	13/16	20.64	0.8125	145.0	243.0	MK 2
A13020.75	–	20.75	0.8169	145.0	243.0	MK 2
A13021.0	–	21.00	0.8268	145.0	243.0	MK 2
A13053/64	53/64	21.03	0.8281	145.0	243.0	MK 2
A13021.25	–	21.25	0.8366	150.0	248.0	MK 2
A13027/32	27/32	21.43	0.8437	150.0	248.0	MK 2
A13021.5	–	21.50	0.8465	150.0	248.0	MK 2
A13021.75	–	21.75	0.8563	150.0	248.0	MK 2
A13055/64	55/64	21.83	0.8594	150.0	248.0	MK 2
A13022.0	–	22.00	0.8661	150.0	248.0	MK 2
A1307/8	7/8	22.22	0.8750	150.0	248.0	MK 2



Product	DC	DC	DC	LCF	OAL	CZC MS
	(inch)	(mm)	(inch)	(mm)	(mm)	
A13022.25	—	22.25	0.8760	150.0	248.0	MK 2
A13022.5	—	22.50	0.8858	155.0	253.0	MK 2
A13057/64	57/64	22.62	0.8906	155.0	253.0	MK 2
A13022.75	—	22.75	0.8957	155.0	253.0	MK 2
A13023.0	—	23.00	0.9055	155.0	253.0	MK 2
A13029/32	29/32	23.02	0.9063	155.0	253.0	MK 2
A13023.25	—	23.25	0.9154	155.0	276.0	MK 3
A13059/64	59/64	23.42	0.9219	155.0	276.0	MK 3
A13023.5	—	23.50	0.9252	155.0	276.0	MK 3
A13023.75	—	23.75	0.9350	160.0	281.0	MK 3
A13015/16	15/16	23.81	0.9375	160.0	281.0	MK 3
A13024.0	—	24.00	0.9449	160.0	281.0	MK 3
A13061/64	61/64	24.21	0.9531	160.0	281.0	MK 3
A13024.25	—	24.25	0.9547	160.0	281.0	MK 3
A13024.5	—	24.50	0.9646	160.0	281.0	MK 3
A13031/32	31/32	24.61	0.9688	160.0	281.0	MK 3
A13024.75	—	24.75	0.9744	160.0	281.0	MK 3
A13025.0	—	25.00	0.9843	160.0	281.0	MK 3
A13063/64	63/64	25.00	0.9844	160.0	286.0	MK 3
A13025.25	—	25.25	0.9941	165.0	286.0	MK 3
A1301	1"	25.40	1.0000	165.0	286.0	MK 3
A13025.5	—	25.50	1.0039	165.0	286.0	MK 3
A13025.75	—	25.75	1.0138	165.0	286.0	MK 3
A13026.0	—	26.00	1.0236	165.0	286.0	MK 3
A13026.25	—	26.25	1.0335	165.0	286.0	MK 3
A13026.5	—	26.50	1.0433	165.0	286.0	MK 3
A13026.75	—	26.75	1.0531	170.0	291.0	MK 3
A1301.1/16	1.1/16	26.99	1.0625	170.0	291.0	MK 3
A13027.0	—	27.00	1.0630	170.0	291.0	MK 3
A13027.25	—	27.25	1.0728	170.0	291.0	MK 3
A13027.5	—	27.50	1.0827	170.0	291.0	MK 3
A13027.75	—	27.75	1.0925	170.0	291.0	MK 3
A13028.0	—	28.00	1.1024	170.0	291.0	MK 3
A13028.25	—	28.25	1.1122	175.0	296.0	MK 3
A13028.5	—	28.50	1.1220	175.0	296.0	MK 3
A1301.1/8	1.1/8	28.58	1.1250	175.0	296.0	MK 3
A13028.75	—	28.75	1.1319	175.0	296.0	MK 3
A13029.0	—	29.00	1.1417	175.0	296.0	MK 3
A13029.25	—	29.25	1.1516	175.0	296.0	MK 3
A1301.5/32	1.5/32	29.37	1.1563	175.0	296.0	MK 3
A13029.5	—	29.50	1.1614	175.0	296.0	MK 3
A13029.75	—	29.75	1.1713	175.0	296.0	MK 3
A13030.0	—	30.00	1.1811	175.0	296.0	MK 3
A1301.3/16	1.3/16	30.16	1.1875	180.0	301.0	MK 3
A13030.25	—	30.25	1.1909	180.0	301.0	MK 3
A13030.5	—	30.50	1.2008	180.0	301.0	MK 3
A13030.75	—	30.75	1.2106	180.0	301.0	MK 3
A1301.7/32	1.7/32	30.96	1.2188	180.0	301.0	MK 3
A13031.0	—	31.00	1.2205	180.0	301.0	MK 3
A13031.25	—	31.25	1.2303	180.0	301.0	MK 3
A13031.5	—	31.50	1.2402	180.0	301.0	MK 3
A13031.75	—	31.75	1.2500	185.0	306.0	MK 3
A1301.1/4	1.1/4	31.75	1.2500	185.0	306.0	MK 3
A13032.0	—	32.00	1.2598	185.0	334.0	MK 4
A13032.5	—	32.50	1.2795	185.0	334.0	MK 4
A1301.9/32	1.9/32	32.54	1.2813	185.0	334.0	MK 4
A13033.0	—	33.00	1.2992	185.0	334.0	MK 4
A1301.5/16	1.5/16	33.34	1.3125	185.0	334.0	MK 4
A13033.5	—	33.50	1.3189	185.0	334.0	MK 4
A13034.0	—	34.00	1.3386	190.0	339.0	MK 4
A1301.11/32	1.11/32	34.13	1.3438	190.0	339.0	MK 4
A13034.5	—	34.50	1.3583	190.0	339.0	MK 4



Product	DC	DC	DC	LCF	OAL	CZC MS
	(inch)	(mm)	(inch)	(mm)	(mm)	
A1301.3/8	1.3/8	34.93	1.3750	190.0	339.0	MK 4
A13035.0	–	35.00	1.3780	190.0	339.0	MK 4
A13035.5	–	35.50	1.3976	190.0	339.0	MK 4
A1301.13/32	1.13/32	35.72	1.4063	195.0	344.0	MK 4
A13036.0	–	36.00	1.4173	195.0	344.0	MK 4
A13036.5	–	36.50	1.4370	195.0	344.0	MK 4
A1301.7/16	1.7/16	36.51	1.4375	195.0	344.0	MK 4
A13037.0	–	37.00	1.4567	195.0	344.0	MK 4
A13037.5	–	37.50	1.4764	195.0	344.0	MK 4
A13038.0	–	38.00	1.4961	200.0	349.0	MK 4
A1301.1/2	1.1/2	38.10	1.5000	200.0	349.0	MK 4
A13038.5	–	38.50	1.5157	200.0	349.0	MK 4
A13039.0	–	39.00	1.5354	200.0	349.0	MK 4
A13039.5	–	39.50	1.5551	200.0	349.0	MK 4
A1301.9/16	1.9/16	39.69	1.5625	200.0	349.0	MK 4
A13040.0	–	40.00	1.5748	200.0	349.0	MK 4
A13040.5	–	40.50	1.5945	205.0	354.0	MK 4
A13041.0	–	41.00	1.6142	205.0	354.0	MK 4
A1301.5/8	1.5/8	41.28	1.6250	205.0	354.0	MK 4
A13041.5	–	41.50	1.6339	205.0	354.0	MK 4
A13042.0	–	42.00	1.6535	205.0	354.0	MK 4
A13042.5	–	42.50	1.6732	205.0	354.0	MK 4
A1301.11/16	1.11/16	42.86	1.6875	210.0	359.0	MK 4
A13043.0	–	43.00	1.6929	210.0	359.0	MK 4
A13043.5	–	43.50	1.7126	210.0	359.0	MK 4
A13044.0	–	44.00	1.7323	210.0	359.0	MK 4
A1301.3/4	1.3/4	44.45	1.7500	210.0	359.0	MK 4
A13044.5	–	44.50	1.7520	210.0	359.0	MK 4
A13045.0	–	45.00	1.7717	210.0	359.0	MK 4
A13045.5	–	45.50	1.7913	215.0	364.0	MK 4
A13046.0	–	46.00	1.8110	215.0	364.0	MK 4
A13046.5	–	46.50	1.8307	215.0	364.0	MK 4
A13047.0	–	47.00	1.8504	215.0	364.0	MK 4
A13047.5	–	47.50	1.8701	215.0	364.0	MK 4
A13048.0	–	48.00	1.8898	220.0	369.0	MK 4
A13048.5	–	48.50	1.9094	220.0	369.0	MK 4
A13049.0	–	49.00	1.9291	220.0	369.0	MK 4
A13049.5	–	49.50	1.9488	220.0	369.0	MK 4
A13050.0	–	50.00	1.9685	220.0	369.0	MK 4
A1302	2"	50.80	2.0000	225.0	374.0	MK 4



A530



HSS spiraalboor, MC schacht, TiN gecoat

Morseconusboor met een sterke 118° tophoek die gemakkelijk naslijpbaar is. Het robuuste ontwerp zorgt voor betere prestaties bij gebruik op conventionele machines. Geschikt voor het boren van vele materialen. TiN coating verbetert de prestaties en verlengt de standtijd.

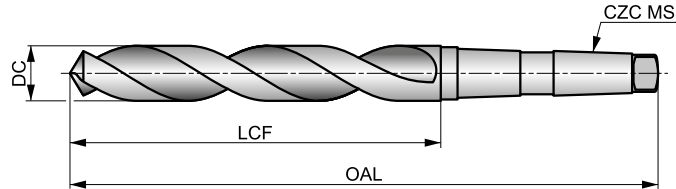

HSS	DIN 345	4xD
118°	TiN	
λ 20-35°	R	DC h8

De tabel geeft de geschiktheid aan voor de materiaalgroep en de startwaarden voor de snijsnelheid (m/min) en de letter verwijst naar de toe te passen voeding (fn), zie vanaf pagina 175.

P1.1 ■ 40 I	P1.2 ■ 45 I	P1.3 ■ 46 I	P2.1 ■ 34 I	P2.2 ■ 30 F	P2.3 ■ 27 E	P3.1 ■ 29 F	P3.2 ■ 24 F	P3.3 ■ 20 E	P4.1 ■ 18 F	P4.2 ■ 15 E	P4.3 ■ 12 D	M1.1 ■ 33 E	M1.2 ■ 28 E
M2.1 ■ 29 E	M2.2 ■ 24 E	M3.1 ■ 15 G	M3.2 ■ 13 G	M3.3 ■ 12 G	M4.1 ■ 20 C	K1.1 ■ 36 I	K1.2 ■ 27 E	K1.3 ■ 20 E	K2.1 ■ 33 E	K2.2 ■ 27 E	K2.3 ■ 22 E	K3.1 ■ 29 E	K3.2 ■ 22 E
K3.3 ■ 18 E	K4.1 ■ 27 E	K4.2 ■ 21 E	K4.3 ■ 15 E	K4.4 ■ 13 E	K4.5 ■ 11 E	K5.1 ■ 31 E	K5.2 ■ 23 E	K5.3 ■ 18 E	N1.1 ■ 55 I	N1.2 ■ 41 I	N1.3 ■ 28 I	N2.1 ■ 54 G	N2.2 ■ 48 G
N2.3 ■ 35 G	N3.1 ■ 93 G	N3.2 ■ 55 I	N3.3 ■ 28 G	N4.1 ■ 50 J	N4.2 ■ 50 H	N4.3 ■ 35 F	S1.1 ■ 32 F	S1.2 ■ 18 D	S1.3 ■ 13 B	S2.1 ■ 8 E	S2.2 ■ 4 A	S3.1 ■ 6 E	S3.2 ■ 3 A
S4.1 ■ 5 E	S4.2 ■ 2 A												

DC >= 14mm uitgedunde ziel.

Product	DC		LCF	OAL	CZC MS
	(mm)	(inch)			
A5308.5	8.50	0.3346	75.0	156.0	MK 1
A5309.0	9.00	0.3543	81.0	162.0	MK 1
A53010.0	10.00	0.3937	87.0	168.0	MK 1
A53010.2	10.20	0.4016	87.0	168.0	MK 1
A53010.5	10.50	0.4134	87.0	168.0	MK 1
A53011.0	11.00	0.4331	94.0	175.0	MK 1
A53011.5	11.50	0.4528	94.0	175.0	MK 1
A53011.75	11.75	0.4626	94.0	175.0	MK 1
A53012.0	12.00	0.4724	101.0	182.0	MK 1
A53012.5	12.50	0.4921	101.0	182.0	MK 1
A53013.0	13.00	0.5118	101.0	182.0	MK 1
A53013.5	13.50	0.5315	108.0	189.0	MK 1
A53014.0	14.00	0.5512	108.0	189.0	MK 1
A53014.5	14.50	0.5709	114.0	212.0	MK 2
A53015.0	15.00	0.5906	114.0	212.0	MK 2
A53015.25	15.25	0.6004	120.0	218.0	MK 2
A53015.5	15.50	0.6102	120.0	218.0	MK 2
A53016.0	16.00	0.6299	120.0	218.0	MK 2
A53016.5	16.50	0.6496	125.0	223.0	MK 2
A53017.0	17.00	0.6693	125.0	223.0	MK 2
A53017.5	17.50	0.6890	130.0	228.0	MK 2
A53018.0	18.00	0.7087	130.0	228.0	MK 2
A53018.5	18.50	0.7283	135.0	233.0	MK 2
A53019.0	19.00	0.7480	135.0	233.0	MK 2
A53019.5	19.50	0.7677	140.0	238.0	MK 2
A53020.0	20.00	0.7874	140.0	238.0	MK 2

Product	DC		LCF	OAL	CZC MS
	(mm)	(inch)			
A53020.5	20.50	0.8071	145.0	243.0	MK 2
A53021.0	21.00	0.8268	145.0	243.0	MK 2
A53021.5	21.50	0.8465	150.0	248.0	MK 2
A53022.0	22.00	0.8661	150.0	248.0	MK 2
A53022.5	22.50	0.8858	155.0	253.0	MK 2
A53023.0	23.00	0.9055	155.0	253.0	MK 2
A53023.5	23.50	0.9252	155.0	276.0	MK 3
A53024.0	24.00	0.9449	160.0	281.0	MK 3
A53024.5	24.50	0.9646	160.0	281.0	MK 3
A53025.0	25.00	0.9843	160.0	281.0	MK 3
A53025.5	25.50	1.0039	165.0	286.0	MK 3
A53026.0	26.00	1.0236	165.0	286.0	MK 3
A53026.5	26.50	1.0433	165.0	286.0	MK 3
A53027.0	27.00	1.0630	170.0	291.0	MK 3
A53027.5	27.50	1.0827	170.0	291.0	MK 3
A53028.0	28.00	1.1024	170.0	291.0	MK 3
A53028.5	28.50	1.1220	175.0	296.0	MK 3
A53029.0	29.00	1.1417	175.0	296.0	MK 3
A53029.5	29.50	1.1614	175.0	296.0	MK 3
A53030.0	30.00	1.1811	175.0	296.0	MK 3
A53031.0	31.00	1.2205	180.0	301.0	MK 3
A53032.0	32.00	1.2598	185.0	334.0	MK 4
A53033.0	33.00	1.2992	185.0	334.0	MK 4
A53035.0	35.00	1.3780	190.0	339.0	MK 4
A53040.0	40.00	1.5748	200.0	349.0	MK 4



A730



HSS-E (8% Co) MC spiraalboor, bronskleurig

Aanbevolen voor moeilijk te bewerken materialen en zware omstandigheden. De tophoek van 180° zorgt voor een sterke punt die gemakkelijk naslijpbaar is. Geschikt voor het boren van vele materialen. De bronzen afwerking is een dunne oxide-laag en het is een indicatie voor kobalt.

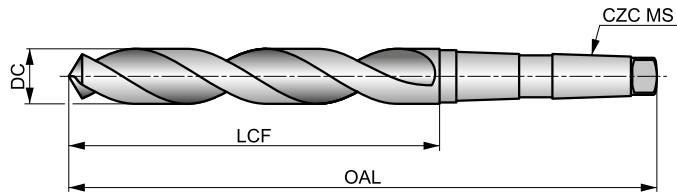

HSS-E	DIN 345	4xD
118°	Bronze	
λ 20-35°	R	DC h8

De tabel geeft de geschiktheid aan voor de materiaalgroep en de startwaarden voor de snijsnelheid (m/min) en de letter verwijst naar de toe te passen voeding (fn), zie vanaf pagina 175.

P1.1 ■ 36 H	P1.2 ■ 40 H	P1.3 ■ 41 H	P2.1 ■ 31 H	P2.2 ■ 27 G	P2.3 ■ 24 E	P3.1 ■ 25 F	P3.2 ■ 20 F	P3.3 ■ 17 E	P4.1 ■ 15 F	P4.2 ■ 13 E	P4.3 ■ 10 D	M1.1 ■ 33 E	M1.2 ■ 28 E
M2.1 ■ 29 E	M2.2 ■ 24 E	M3.1 ■ 13 G	M3.2 ■ 11 G	M3.3 ■ 10 G	M4.1 ■ 17 C	K1.1 ■ 35 J	K1.2 ■ 26 G	K1.3 ■ 19 G	K2.1 ■ 27 E	K2.2 ■ 22 E	K2.3 ■ 18 E	K3.1 ■ 24 E	K3.2 ■ 18 E
K3.3 ■ 15 E	K4.1 ■ 22 E	K4.2 ■ 17 E	K4.3 ■ 12 E	K4.4 ■ 11 E	K4.5 ■ 9 E	K5.1 ■ 25 E	K5.2 ■ 19 E	K5.3 ■ 15 E	N1.1 ■ 33 J	N1.2 ■ 25 J	N1.3 ■ 17 I	N2.1 ■ 46 H	N2.2 ■ 42 H
N2.3 ■ 30 H	N3.1 ■ 68 H	N3.2 ■ 40 J	N3.3 ■ 20 L	N4.1 ■ 35 K	N4.2 ■ 28 J	N4.3 ■ 20 H	S1.1 ■ 28 G	S1.2 ■ 20 D	S1.3 ■ 11 C	S2.1 ■ 9 E	S2.2 ■ 8 B	S3.1 ■ 7 E	S3.2 ■ 6 B
S4.1 ■ 5 E	S4.2 ■ 5 B												

DC >= 14mm uitgedunde ziel.

Product	DC (mm)	DC (inch)	LCF (mm)	OAL (mm)	CZC MS	Product	DC (mm)	DC (inch)	LCF (mm)	OAL (mm)	CZC MS
A73010.0	10.00	0.3937	87.0	168.0	MK 1	A73016.25	16.25	0.6398	120.0	218.0	MK 2
A73010.2	10.20	0.4016	87.0	168.0	MK 1	A73016.5	16.50	0.6496	125.0	223.0	MK 2
A73010.5	10.50	0.4134	87.0	168.0	MK 1	A73017.0	17.00	0.6693	125.0	223.0	MK 2
A73010.8	10.80	0.4252	94.0	175.0	MK 1	A73017.25	17.25	0.6791	130.0	228.0	MK 2
A73011.0	11.00	0.4331	94.0	175.0	MK 1	A73017.5	17.50	0.6890	130.0	228.0	MK 2
A73011.5	11.50	0.4528	94.0	175.0	MK 1	A73017.75	17.75	0.6988	130.0	228.0	MK 2
A73011.8	11.80	0.4646	94.0	175.0	MK 1	A73018.0	18.00	0.7087	130.0	228.0	MK 2
A73012.0	12.00	0.4724	101.0	182.0	MK 1	A73018.25	18.25	0.7185	135.0	233.0	MK 2
A73012.2	12.20	0.4803	101.0	182.0	MK 1	A73018.5	18.50	0.7283	135.0	233.0	MK 2
A73012.5	12.50	0.4921	101.0	182.0	MK 1	A73018.75	18.75	0.7382	135.0	233.0	MK 2
A73012.8	12.80	0.5039	101.0	182.0	MK 1	A73019.0	19.00	0.7480	135.0	233.0	MK 2
A73013.0	13.00	0.5118	101.0	182.0	MK 1	A73019.25	19.25	0.7579	140.0	238.0	MK 2
A73013.5	13.50	0.5315	108.0	189.0	MK 1	A73019.5	19.50	0.7677	140.0	238.0	MK 2
A73013.8	13.80	0.5433	108.0	189.0	MK 1	A73019.75	19.75	0.7776	140.0	238.0	MK 2
A73014.0	14.00	0.5512	108.0	189.0	MK 1	A73020.0	20.00	0.7874	140.0	238.0	MK 2
A73014.25	14.25	0.5610	114.0	212.0	MK 2	A73020.25	20.25	0.7972	145.0	243.0	MK 2
A73014.5	14.50	0.5709	114.0	212.0	MK 2	A73020.5	20.50	0.8071	145.0	243.0	MK 2
A73014.75	14.75	0.5807	114.0	212.0	MK 2	A73020.75	20.75	0.8169	145.0	243.0	MK 2
A73015.0	15.00	0.5906	114.0	212.0	MK 2	A73021.0	21.00	0.8268	145.0	243.0	MK 2
A73015.25	15.25	0.6004	120.0	218.0	MK 2	A73021.5	21.50	0.8465	150.0	248.0	MK 2
A73015.5	15.50	0.6102	120.0	218.0	MK 2	A73022.0	22.00	0.8661	150.0	248.0	MK 2
A73015.75	15.75	0.6201	120.0	218.0	MK 2	A73022.5	22.50	0.8858	155.0	253.0	MK 2
A73016.0	16.00	0.6299	120.0	218.0	MK 2	A73023.0	23.00	0.9055	155.0	253.0	MK 2



Product	DC	DC	LCF	OAL	CZC MS
	(mm)	(inch)	(mm)	(mm)	
A73023.5	23.50	0.9252	155.0	276.0	MK 3
A73024.0	24.00	0.9449	160.0	281.0	MK 3
A73024.5	24.50	0.9646	160.0	281.0	MK 3
A73025.0	25.00	0.9843	160.0	281.0	MK 3
A73025.5	25.50	1.0039	165.0	286.0	MK 3
A73026.0	26.00	1.0236	165.0	286.0	MK 3
A73026.5	26.50	1.0433	165.0	286.0	MK 3
A73027.0	27.00	1.0630	170.0	291.0	MK 3

Product	DC	DC	LCF	OAL	CZC MS
	(mm)	(inch)	(mm)	(mm)	
A73027.5	27.50	1.0827	170.0	291.0	MK 3
A73028.0	28.00	1.1024	170.0	291.0	MK 3
A73028.5	28.50	1.1220	175.0	296.0	MK 3
A73029.0	29.00	1.1417	175.0	296.0	MK 3
A73030.0	30.00	1.1811	175.0	296.0	MK 3
A73031.0	31.00	1.2205	180.0	301.0	MK 3
A73032.0	32.00	1.2598	185.0	334.0	MK 4



A166



HSS MC boor, HM gesoldeerde punt

De gesoldeerde hardmetalen punt geeft de hoge prestaties van een hardmetalen boor met een stabiel en minder bros HSS lichaam. Een 118°, 4-vlaks punt, helpt de zelfcentering waardoor het een economische keuze is. Kan gebruikt worden in zowel conventionele als CNC machines. De stoomontlaten afwerking houdt de snijvloestof vast.

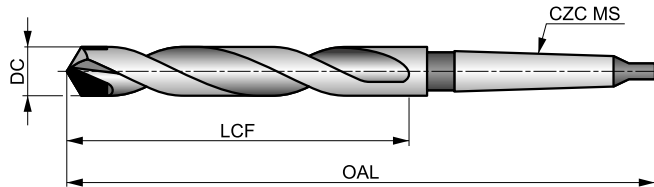

HSS HM	DIN 345	4×D
118°	Bright ST	
20-35°	R	DC h8

De tabel geeft de geschiktheid aan voor de materiaalgroep en de startwaarden voor de snijsnelheid (m/min) en de letter verwijst naar de toe te passen voeding (fn), zie vanaf pagina 175.

P1.1 ▣73 E	P1.2 ▣82 E	P1.3 ▣85 E	P2.1 ▣63 E	P2.2 ▣55 D	P2.3 ▣49 C	P3.1 ▣59 D	P3.2 ▣47 D	P3.3 ▣40 C	P4.1 ▣35 D	P4.2 ▣30 C	P4.3 ▣24 A	M1.1 ▣55 B	M1.2 ▣46 B
M2.1 ▣49 B	M2.2 ▣40 B	M3.1 ▣41 C	M3.2 ▣35 C	M3.3 ▣32 C	M4.1 ▣35 A	K1.1 ▣50 C	K1.2 ▣37 C	K1.3 ▣28 C	K2.1 ▣43 C	K2.2 ▣35 C	K2.3 ▣28 A	K3.1 ▣38 C	K3.2 ▣29 C
K3.3 ▣24 A	K4.1 ▣35 C	K4.2 ▣27 C	K4.3 ▣20 A	K4.4 ▣17 A	K4.5 ▣14 A	K5.1 ▣40 C	K5.2 ▣30 C	K5.3 ▣23 A	N1.1 ▣50 I	N1.2 ▣38 I	N1.3 ▣25 H	N2.1 ▣62 G	N2.2 ▣55 G
N2.3 ▣40 G	N3.1 ▣127 C	N3.2 ▣75 G	N3.3 ▣38 D	N4.2 ▣60 E	S1.1 ▣35 A	S1.2 ▣35 A	S1.3 ▣25 A	S2.1 ▣33 A	S2.2 ▣28 A	S3.1 ▣25 A	S3.2 ▣20 A	S4.1 ▣20 A	S4.2 ▣16 A

Product	DC	DC	LCF	OAL	CZC MS	Product	DC	DC	LCF	OAL	CZC MS
	(mm)	(inch)					(mm)	(mm)			
A16610.0	10.00	0.3937	87.0	168.0	MK 1	A16620.0	20.00	0.7874	140.0	238.0	MK 2
A16610.5	10.50	0.4134	87.0	168.0	MK 1	A16621.0	21.00	0.8268	145.0	243.0	MK 2
A16611.0	11.00	0.4331	94.0	175.0	MK 1	A16622.0	22.00	0.8661	150.0	248.0	MK 2
A16611.5	11.50	0.4528	94.0	175.0	MK 1	A16622.5	22.50	0.8858	155.0	253.0	MK 2
A16612.0	12.00	0.4724	101.0	182.0	MK 1	A16623.0	23.00	0.9055	155.0	253.0	MK 2
A16613.0	13.00	0.5118	101.0	182.0	MK 1	A16624.0	24.00	0.9449	160.0	281.0	MK 3
A16613.5	13.50	0.5315	108.0	189.0	MK 1	A16625.0	25.00	0.9843	160.0	281.0	MK 3
A16614.0	14.00	0.5512	108.0	189.0	MK 1	A16626.0	26.00	1.0236	165.0	286.0	MK 3
A16615.0	15.00	0.5906	114.0	212.0	MK 2	A16627.0	27.00	1.0630	170.0	291.0	MK 3
A16616.0	16.00	0.6299	120.0	218.0	MK 2	A16628.0	28.00	1.1024	170.0	291.0	MK 3
A16617.0	17.00	0.6693	125.0	223.0	MK 2	A16629.0	29.00	1.1417	175.0	296.0	MK 3
A16617.5	17.50	0.6890	130.0	228.0	MK 2	A16630.0	30.00	1.1811	175.0	296.0	MK 3
A16618.0	18.00	0.7087	130.0	228.0	MK 2	A16632.0	32.00	1.2598	185.0	334.0	MK 4
A16619.0	19.00	0.7480	135.0	233.0	MK 2	A16633.0	33.00	1.2992	185.0	334.0	MK 4



A350



HSS lange MC spiraalboor (DIN341), stoomontlaten

Aanbevolen voor het boren van diepe gaten of voor toepassingen waarbij een groter bereik vereist is. Een tophoek van 118° is gemakkelijk na te slijpen en zorgt voor sterkte. De stoomontlaten afwerking houdt snijvloeistof vast en voorkomt het aanlassen van spanen. Geschikt voor het boren van vele materialen.

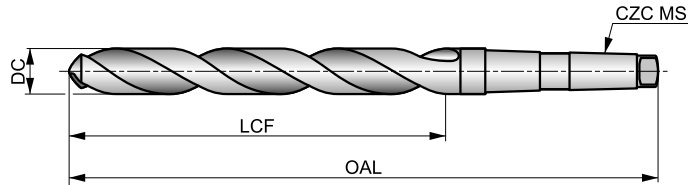

HSS	DIN 341	6xD
118°	ST	
λ 20-35°	R	DC h8

De tabel geeft de geschiktheid aan voor de materiaalgroep en de startwaarden voor de snijnelheid (m/min) en de letter verwijst naar de toe te passen voeding (fn), zie vanaf pagina 175.

P1.1 ■ 27 I	P1.2 ■ 30 I	P1.3 ■ 31 I	P2.1 ■ 23 I	P2.2 ■ 20 G	P2.3 ■ 18 E	P3.1 ■ 15 F	P3.2 ■ 12 F	P3.3 ■ 10 E	P4.1 ■ 9 F	P4.2 ■ 7 E	P4.3 ■ 6 D	M1.1 ■ 18 E	M1.2 ■ 15 E
M2.1 ■ 16 E	M2.2 ■ 13 E	M3.1 ■ 5 G	M3.2 ■ 4 G	M3.3 ■ 4 G	M4.1 ■ 8 C	K1.1 ■ 26 I	K1.2 ■ 19 F	K1.3 ■ 14 F	K2.1 ■ 22 E	K2.2 ■ 18 E	K2.3 ■ 14 E	K3.1 ■ 20 E	K3.2 ■ 15 E
K3.3 ■ 12 E	K4.1 ■ 18 E	K4.2 ■ 14 E	K4.3 ■ 10 E	K4.4 ■ 9 E	K4.5 ■ 7 E	K5.1 ■ 21 E	K5.2 ■ 15 E	K5.3 ■ 12 E	N1.1 ■ 33 J	N1.2 ■ 25 J	N1.3 ■ 17 I	N2.1 ■ 42 H	N2.2 ■ 37 H
N2.3 ■ 27 H	N3.1 ■ 59 H	N3.2 ■ 35 I	N3.3 ■ 18 F	N4.1 ■ 35 L	N4.2 ■ 26 J	N4.3 ■ 12 H	S1.1 ■ 16 F	S1.2 ■ 9 D	S1.3 ■ 5 B	S2.1 ■ 5 E	S2.2 ■ 4 A	S3.1 ■ 4 E	S3.2 ■ 3 A
S4.1 ■ 3 E	S4.2 ■ 2 A												

Product	DC (mm)	DC (inch)	LCF (mm)	OAL (mm)	CZC MS
A3505.0	5.00	0.1969	74.0	155.0	MK 1
A3505.5	5.50	0.2165	80.0	161.0	MK 1
A3506.0	6.00	0.2362	80.0	161.0	MK 1
A3506.7	6.70	0.2638	86.0	167.0	MK 1
A3506.8	6.80	0.2677	93.0	174.0	MK 1
A3507.0	7.00	0.2756	93.0	174.0	MK 1
A3507.5	7.50	0.2953	93.0	174.0	MK 1
A3508.0	8.00	0.3150	100.0	181.0	MK 1
A3508.4	8.40	0.3307	100.0	181.0	MK 1
A3508.5	8.50	0.3346	100.0	181.0	MK 1
A3508.75	8.75	0.3445	107.0	188.0	MK 1
A3509.0	9.00	0.3543	107.0	188.0	MK 1
A3509.5	9.50	0.3740	107.0	188.0	MK 1
A3509.8	9.80	0.3858	116.0	197.0	MK 1
A35010.0	10.00	0.3937	116.0	197.0	MK 1
A35010.2	10.20	0.4016	116.0	197.0	MK 1
A35010.5	10.50	0.4134	116.0	197.0	MK 1
A35010.7	10.70	0.4213	125.0	206.0	MK 1
A35011.0	11.00	0.4331	125.0	206.0	MK 1
A35011.5	11.50	0.4528	125.0	206.0	MK 1
A35011.75	11.75	0.4626	125.0	206.0	MK 1
A35011.8	11.80	0.4646	125.0	206.0	MK 1
A35012.0	12.00	0.4724	134.0	215.0	MK 1
A35012.5	12.50	0.4921	134.0	215.0	MK 1

Product	DC (mm)	DC (inch)	LCF (mm)	OAL (mm)	CZC MS
A35013.0	13.00	0.5118	134.0	215.0	MK 1
A35013.5	13.50	0.5315	142.0	223.0	MK 1
A35014.0	14.00	0.5512	142.0	223.0	MK 1
A35014.25	14.25	0.5610	147.0	245.0	MK 2
A35014.5	14.50	0.5709	147.0	245.0	MK 2
A35014.75	14.75	0.5807	147.0	245.0	MK 2
A35015.0	15.00	0.5906	147.0	245.0	MK 2
A35015.25	15.25	0.6004	153.0	251.0	MK 2
A35015.5	15.50	0.6102	153.0	251.0	MK 2
A35015.75	15.75	0.6201	153.0	251.0	MK 2
A35016.0	16.00	0.6299	153.0	251.0	MK 2
A35016.25	16.25	0.6398	159.0	257.0	MK 2
A35016.5	16.50	0.6496	159.0	257.0	MK 2
A35016.75	16.75	0.6594	159.0	257.0	MK 2
A35017.0	17.00	0.6693	159.0	257.0	MK 2
A35017.25	17.25	0.6791	165.0	263.0	MK 2
A35017.5	17.50	0.6890	165.0	263.0	MK 2
A35018.0	18.00	0.7087	165.0	263.0	MK 2
A35018.5	18.50	0.7283	171.0	269.0	MK 2
A35019.0	19.00	0.7480	171.0	269.0	MK 2
A35019.5	19.50	0.7677	177.0	275.0	MK 2
A35019.75	19.75	0.7776	177.0	275.0	MK 2
A35020.0	20.00	0.7874	177.0	275.0	MK 2
A35020.25	20.25	0.7972	184.0	282.0	MK 2



Product	DC	DC	LCF	OAL	CZC MS
	(mm)	(inch)	(mm)	(mm)	
A35020.5	20.50	0.8071	184.0	282.0	MK 2
A35021.0	21.00	0.8268	184.0	282.0	MK 2
A35021.5	21.50	0.8465	191.0	289.0	MK 2
A35022.0	22.00	0.8661	191.0	289.0	MK 2
A35022.5	22.50	0.8858	198.0	296.0	MK 2
A35023.0	23.00	0.9055	198.0	296.0	MK 2
A35023.5	23.50	0.9252	198.0	319.0	MK 3
A35024.0	24.00	0.9449	206.0	327.0	MK 3
A35024.5	24.50	0.9646	206.0	327.0	MK 3
A35025.0	25.00	0.9843	206.0	327.0	MK 3
A35025.5	25.50	1.0039	214.0	335.0	MK 3
A35026.0	26.00	1.0236	214.0	335.0	MK 3
A35026.5	26.50	1.0433	214.0	335.0	MK 3
A35027.0	27.00	1.0630	222.0	343.0	MK 3
A35027.5	27.50	1.0827	222.0	343.0	MK 3
A35028.0	28.00	1.1024	222.0	343.0	MK 3
A35029.0	29.00	1.1417	230.0	351.0	MK 3
A35030.0	30.00	1.1811	230.0	351.0	MK 3
A35030.5	30.50	1.2008	239.0	360.0	MK 3
A35031.0	31.00	1.2205	239.0	360.0	MK 3

Product	DC	DC	LCF	OAL	CZC MS
	(mm)	(inch)	(mm)	(mm)	
A35031.5	31.50	1.2402	239.0	360.0	MK 3
A35032.0	32.00	1.2598	248.0	397.0	MK 4
A35033.0	33.00	1.2992	248.0	397.0	MK 4
A35034.0	34.00	1.3386	257.0	406.0	MK 4
A35035.0	35.00	1.3780	257.0	406.0	MK 4
A35036.0	36.00	1.4173	267.0	416.0	MK 4
A35037.0	37.00	1.4567	267.0	416.0	MK 4
A35038.0	38.00	1.4961	277.0	426.0	MK 4
A35039.0	39.00	1.5354	277.0	426.0	MK 4
A35040.0	40.00	1.5748	277.0	426.0	MK 4
A35041.0	41.00	1.6142	287.0	436.0	MK 4
A35042.0	42.00	1.6535	287.0	436.0	MK 4
A35043.0	43.00	1.6929	298.0	447.0	MK 4
A35044.0	44.00	1.7323	298.0	447.0	MK 4
A35045.0	45.00	1.7717	298.0	447.0	MK 4
A35046.0	46.00	1.8110	310.0	459.0	MK 4
A35047.0	47.00	1.8504	310.0	459.0	MK 4
A35048.0	48.00	1.8898	321.0	470.0	MK 4
A35050.0	50.00	1.9685	321.0	470.0	MK 4



A345



HSS extra lange MC spiraalboor (DIN1870-1), stoomontlaten

Aanbevolen voor het boren van zeer diepe gaten of voor toepassingen waarbij een groter bereik vereist is. Een tophoek van 118° is gemakkelijk na te slijpen en zorgt voor sterkte. De stoomontlaten afwerking houdt snijvloeistof vast en voorkomt het aanlassen van spanen. Geschikt voor het boren van vele materialen.

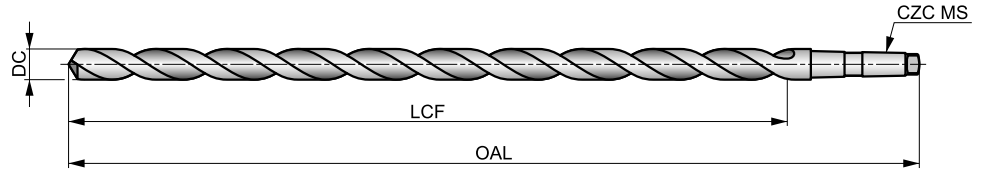

HSS	DIN 1870(1)	10×D
118°	ST	
λ 20-35°	R	DC h8

De tabel geeft de geschiktheid aan voor de materiaalgroep en de startwaarden voor de snijnsnelheid (m/min) en de letter verwijst naar de toe te passen voeding (fn), zie vanaf pagina 175.

P1.1 ■ 23 G	P1.2 ■ 25 G	P1.3 ■ 26 G	P2.1 ■ 19 G	P2.2 ■ 17 E	P2.3 ■ 15 C	P3.1 ■ 9 D	P3.2 ■ 7 D	P3.3 ■ 6 C	P4.1 ■ 5 D	P4.2 ■ 4 C	P4.3 ■ 4 B	M1.1 ■ 16 C	M1.2 ■ 14 C
M2.1 ■ 15 C	M2.2 ■ 12 C	M3.1 ■ 5 E	M3.2 ■ 4 E	M3.3 ■ 4 E	M4.1 ■ 8 A	K1.1 ■ 22 G	K1.2 ■ 16 D	K1.3 ■ 12 D	K2.1 ■ 16 C	K2.2 ■ 13 C	K2.3 ■ 10 C	K3.1 ■ 14 C	K3.2 ■ 11 C
K3.3 ■ 9 C	K4.1 ■ 13 C	K4.2 ■ 10 C	K4.3 ■ 7 C	K4.4 ■ 6 C	K4.5 ■ 5 C	K5.1 ■ 15 C	K5.2 ■ 11 C	K5.3 ■ 9 C	N1.1 ■ 33 H	N1.2 ■ 25 H	N1.3 ■ 17 G	N2.1 ■ 42 F	N2.2 ■ 37 F
N2.3 ■ 27 F	N3.1 ■ 56 F	N3.2 ■ 33 G	N3.3 ■ 17 D	N4.1 ■ 30 J	N4.2 ■ 30 H	N4.3 ■ 10 F	S1.1 ■ 15 D	S1.2 ■ 9 B	S1.3 ■ 5 A	S2.1 ■ 5 C	S2.2 ■ 4 A	S3.1 ■ 4 C	S3.2 ■ 3 A
S4.1 ■ 3 C	S4.2 ■ 2 A												

DC > 25.4mm minder dan 10xD.

Product	DC (inch)	DC (mm)	DC (inch)	LCF (mm)	OAL (mm)	CZC MS
A3458.0	–	8.00	0.3150	165.0	265.0	MK 1
A3458.5	–	8.50	0.3346	165.0	265.0	MK 1
A3459.0	–	9.00	0.3543	175.0	275.0	MK 1
A3459.5	–	9.50	0.3740	175.0	275.0	MK 1
A3453/8	3/8	9.52	0.3750	185.0	285.0	MK 1
A34510.0	–	10.00	0.3937	185.0	285.0	MK 1
A34513/32	13/32	10.32	0.4063	185.0	285.0	MK 1
A34510.5	–	10.50	0.4134	185.0	285.0	MK 1
A34511.0	–	11.00	0.4331	195.0	300.0	MK 1
A3457/16	7/16	11.11	0.4375	195.0	300.0	MK 1
A34511.5	–	11.50	0.4528	195.0	300.0	MK 1
A34529/64	29/64	11.51	0.4531	205.0	310.0	MK 1
A34512.0	–	12.00	0.4724	205.0	310.0	MK 1
A34512.5	–	12.50	0.4921	205.0	310.0	MK 1
A3451/2	1/2	12.70	0.5000	205.0	310.0	MK 1
A34513.0	–	13.00	0.5118	205.0	310.0	MK 1
A34517/32	17/32	13.49	0.5313	220.0	325.0	MK 1
A34513.5	–	13.50	0.5315	220.0	325.0	MK 1
A34514.0	–	14.00	0.5512	220.0	325.0	MK 1
A3459/16	9/16	14.29	0.5625	220.0	340.0	MK 2
A34537/64	37/64	14.68	0.5781	220.0	340.0	MK 2
A34515.0	–	15.00	0.5906	220.0	340.0	MK 2
A34539/64	39/64	15.48	0.6094	230.0	355.0	MK 2

Product	DC (inch)	DC (mm)	DC (inch)	LCF (mm)	OAL (mm)	CZC MS
A34515.5	–	15.50	0.6102	230.0	355.0	MK 2
A3455/8	5/8	15.88	0.6250	230.0	355.0	MK 2
A34516.0	–	16.00	0.6299	230.0	355.0	MK 2
A34541/64	41/64	16.27	0.6406	230.0	355.0	MK 2
A34516.5	–	16.50	0.6496	230.0	355.0	MK 2
A34521/32	21/32	16.67	0.6563	230.0	355.0	MK 2
A34517.0	–	17.00	0.6693	230.0	355.0	MK 2
A34511/16	11/16	17.46	0.6875	245.0	370.0	MK 2
A34517.5	–	17.50	0.6890	245.0	370.0	MK 2
A34518.0	–	18.00	0.7087	245.0	370.0	MK 2
A34518.5	–	18.50	0.7283	245.0	370.0	MK 2
A34519.0	–	19.00	0.7480	245.0	370.0	MK 2
A3453/4	3/4	19.05	0.7500	260.0	385.0	MK 2
A34519.5	–	19.50	0.7677	260.0	385.0	MK 2
A34520.0	–	20.00	0.7874	260.0	385.0	MK 2
A34520.5	–	20.50	0.8071	260.0	385.0	MK 2
A34521.0	–	21.00	0.8268	260.0	385.0	MK 2
A34521.5	–	21.50	0.8465	270.0	405.0	MK 2
A34522.0	–	22.00	0.8661	270.0	405.0	MK 2
A3457/8	7/8	22.22	0.8750	270.0	405.0	MK 2
A34522.5	–	22.50	0.8858	270.0	405.0	MK 3
A34523.0	–	23.00	0.9055	270.0	405.0	MK 3
A34523.5	–	23.50	0.9252	270.0	425.0	MK 3



Product	DC	DC	DC	LCF	OAL	CZC MS
	(inch)	(mm)	(inch)	(mm)	(mm)	
A34524.0	–	24.00	0.9449	290.0	440.0	MK 3
A34524.5	–	24.50	0.9646	290.0	440.0	MK 3
A34525.0	–	25.00	0.9843	290.0	440.0	MK 3
A3451	1"	25.40	1.0000	290.0	440.0	MK 3
A34525.5	–	25.50	1.0039	290.0	440.0	MK 3
A34526.0	–	26.00	1.0236	290.0	440.0	MK 3
A34526.5	–	26.50	1.0433	290.0	440.0	MK 3
A34527.0	–	27.00	1.0630	305.0	460.0	MK 3
A34528.0	–	28.00	1.1024	305.0	460.0	MK 3
A34529.0	–	29.00	1.1417	305.0	460.0	MK 3
A34530.0	–	30.00	1.1811	305.0	460.0	MK 3
A3451.1/4	1.1/4	31.75	1.2500	320.0	480.0	MK 3

Product	DC	DC	DC	LCF	OAL	CZC MS
	(inch)	(mm)	(inch)	(mm)	(mm)	
A34531.0	–	31.00	1.2205	320.0	480.0	MK 3
A34532.0	–	32.00	1.2598	320.0	505.0	MK 4
A34533.0	–	33.00	1.2992	320.0	505.0	MK 4
A34534.0	–	34.00	1.3386	340.0	530.0	MK 4
A34535.0	–	35.00	1.3780	340.0	530.0	MK 4
A34536.0	–	36.00	1.4173	340.0	530.0	MK 4
A34537.0	–	37.00	1.4567	340.0	530.0	MK 4
A34538.0	–	38.00	1.4961	360.0	555.0	MK 4
A3451.1/2	1.1/2	38.10	1.5000	360.0	555.0	MK 4
A34539.0	–	39.00	1.5354	360.0	555.0	MK 4
A34540.0	–	40.00	1.5748	360.0	555.0	MK 4



A951



PFX HSS extra lange MC boor, DIN1870-1

Een veelzijdige boor met een speciaal parabolisch spiraalontwerp voor het boren van diepe gaten in een enkele beweging. De boor heeft een zelfcentrerende punt van 130° (centreren met een korte PFX boor wordt aanbevolen) zodat de kracht die nodig is om het gat te boren wordt verminderd. Geschikt voor het boren van vele materialen.

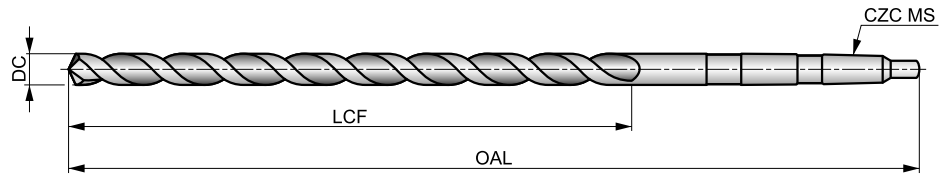

HSS	DIN 1870(1)	15×D
130°	Bright ST	
λ>35°	R	DC h8

De tabel geeft de geschiktheid aan voor de materiaalgroep en de startwaarden voor de snijsnelheid (m/min) en de letter verwijst naar de toe te passen voeding (fn), zie vanaf pagina 175.

P1.1 ■ 25 G	P1.2 ■ 28 G	P1.3 ■ 29 G	P2.1 ■ 22 G	P2.2 ■ 19 E	P2.3 ■ 17 C	P3.1 ■ 12 D	P3.2 ■ 9 D	P3.3 ■ 8 C	P4.1 ■ 7 D	P4.2 ■ 6 C	P4.3 ■ 5 B	M1.1 ■ 16 C	M1.2 ■ 14 C
M2.1 ■ 15 C	M2.2 ■ 12 C	M3.1 ■ 7 E	M3.2 ■ 6 E	M3.3 ■ 5 E	M4.1 ■ 12 A	K1.1 ■ 22 G	K1.2 ■ 16 D	K1.3 ■ 12 D	K2.1 ■ 16 C	K2.2 ■ 13 C	K2.3 ■ 10 C	K3.1 ■ 14 C	K3.2 ■ 11 C
K3.3 ■ 9 C	K4.1 ■ 13 C	K4.2 ■ 10 C	K4.3 ■ 7 C	K4.4 ■ 6 C	K4.5 ■ 5 C	K5.1 ■ 15 C	K5.2 ■ 11 C	K5.3 ■ 9 C	N1.1 ■ 30 H	N1.2 ■ 23 H	N1.3 ■ 15 G	N2.1 ■ 37 F	N2.2 ■ 33 F
N2.3 ■ 24 F	N3.1 ■ 56 F	N3.2 ■ 33 G	N3.3 ■ 17 D	N4.1 ■ 30 J	N4.2 ■ 30 H	N4.3 ■ 10 F	S1.1 ■ 18 D	S1.2 ■ 10 B	S1.3 ■ 6 A	S2.1 ■ 7 C	S2.2 ■ 4 A	S3.1 ■ 5 C	S3.2 ■ 3 A
S4.1 ■ 4 C	S4.2 ■ 2 A												

DC >= 14.5mm minder dan 15xD; DC > 23mm blank.

Product	DC	DC	LCF	OAL	CZC MS	Product	DC	DC	LCF	OAL	CZC MS
	(mm)	(inch)					(mm)	(mm)			
A95110.0	10.00	0.3937	185.0	285.0	MK 1	A95118.5	18.50	0.7283	245.0	370.0	MK 2
A95111.0	11.00	0.4331	195.0	300.0	MK 1	A95119.0	19.00	0.7480	245.0	370.0	MK 2
A95112.0	12.00	0.4724	205.0	310.0	MK 1	A95119.5	19.50	0.7677	260.0	385.0	MK 2
A95112.5	12.50	0.4921	205.0	310.0	MK 1	A95120.0	20.00	0.7874	260.0	385.0	MK 2
A95113.0	13.00	0.5118	205.0	310.0	MK 1	A95121.0	21.00	0.8268	260.0	385.0	MK 2
A95113.5	13.50	0.5315	220.0	325.0	MK 1	A95122.0	22.00	0.8661	270.0	405.0	MK 2
A95114.0	14.00	0.5512	220.0	325.0	MK 1	A95123.0	23.00	0.9055	270.0	405.0	MK 2
A95114.5	14.50	0.5709	220.0	340.0	MK 2	A95124.0	24.00	0.9449	290.0	440.0	MK 3
A95115.0	15.00	0.5906	220.0	340.0	MK 2	A95125.0	25.00	0.9843	290.0	440.0	MK 3
A95115.5	15.50	0.6102	230.0	355.0	MK 2	A95126.0	26.00	1.0236	290.0	440.0	MK 3
A95116.0	16.00	0.6299	230.0	355.0	MK 2	A95127.0	27.00	1.0630	305.0	460.0	MK 3
A95116.5	16.50	0.6496	230.0	355.0	MK 2	A95128.0	28.00	1.1024	305.0	460.0	MK 3
A95117.0	17.00	0.6693	230.0	355.0	MK 2	A95129.0	29.00	1.1417	305.0	460.0	MK 3
A95117.5	17.50	0.6890	245.0	370.0	MK 2	A95130.0	30.00	1.1811	305.0	460.0	MK 3
A95118.0	18.00	0.7087	245.0	370.0	MK 2						



A952



PFX HSS superlange MC boor, DIN1870-2

Een veelzijdige boor met een speciaal parabolisch spiraalontwerp voor het boren van diepe gaten in een enkele beweging. De boor heeft een zelfcentrerende punt van 130° (centreren met een korte PFX boor wordt aanbevolen) zodat de kracht die nodig is om het gat te boren wordt verminderd. Geschikt voor het boren van vele materialen.

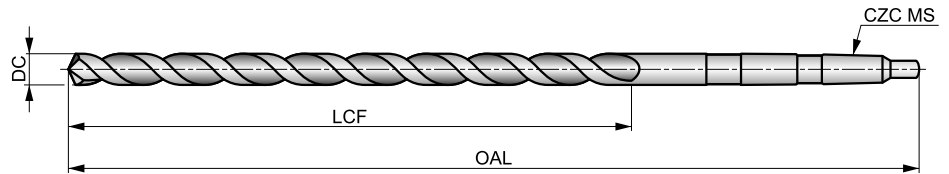

HSS	DIN 1870(2)	20xD
130°	Bright ST	
$\lambda > 35^\circ$	R	DC h8

De tabel geeft de geschiktheid aan voor de materiaalgroep en de startwaarden voor de snijsnelheid (m/min) en de letter verwijst naar de toe te passen voeding (fn), zie vanaf pagina 175.

P1.1 ■ 25 G	P1.2 ■ 28 G	P1.3 ■ 29 G	P2.1 ■ 22 G	P2.2 ■ 19 E	P2.3 ■ 17 C	P3.1 ■ 12 D	P3.2 ■ 9 D	P3.3 ■ 8 C	P4.1 ■ 7 D	P4.2 ■ 6 C	P4.3 ■ 5 B	M1.1 ■ 16 C	M1.2 ■ 14 C
M2.1 ■ 15 C	M2.2 ■ 12 C	M3.1 ■ 17 E	M3.2 ■ 16 E	M3.3 ■ 5 E	M4.1 ■ 12 A	K1.1 ■ 22 G	K1.2 ■ 16 D	K1.3 ■ 12 D	K2.1 ■ 16 C	K2.2 ■ 13 C	K2.3 ■ 10 C	K3.1 ■ 14 C	K3.2 ■ 11 C
K3.3 ■ 9 C	K4.1 ■ 13 C	K4.2 ■ 10 C	K4.3 ■ 7 C	K4.4 ■ 6 C	K4.5 ■ 5 C	K5.1 ■ 15 C	K5.2 ■ 11 C	K5.3 ■ 9 C	N1.1 ■ 30 H	N1.2 ■ 23 H	N1.3 ■ 15 G	N2.1 ■ 37 F	N2.2 ■ 33 F
N2.3 ■ 24 F	N3.1 ■ 56 F	N3.2 ■ 33 G	N3.3 ■ 17 D	N4.1 ■ 30 J	N4.2 ■ 30 H	N4.3 ■ 10 F	S1.1 ■ 18 D	S1.2 ■ 10 B	S1.3 ■ 6 A	S2.1 ■ 7 C	S2.2 ■ 4 A	S3.1 ■ 5 C	S3.2 ■ 3 A
S4.1 ■ 4 C	S4.2 ■ 2 A												

DC >= 14.5mm minder dan 20xD; DC > 23mm blank.

Product	DC (mm)	DC (inch)	LCF (mm)	OAL (mm)	CZC MS
A9528.0	8.00	0.3150	210.0	330.0	MK 1
A9528.5	8.50	0.3346	210.0	330.0	MK 1
A9529.0	9.00	0.3543	220.0	345.0	MK 1
A95210.0	10.00	0.3937	235.0	360.0	MK 1
A95210.5	10.50	0.4134	235.0	360.0	MK 1
A95211.0	11.00	0.4331	250.0	375.0	MK 1
A95211.5	11.50	0.4528	250.0	375.0	MK 1
A95212.0	12.00	0.4724	260.0	395.0	MK 1
A95212.5	12.50	0.4921	260.0	395.0	MK 1
A95213.0	13.00	0.5118	260.0	395.0	MK 1
A95213.5	13.50	0.5315	275.0	410.0	MK 1
A95214.0	14.00	0.5512	275.0	410.0	MK 1
A95214.5	14.50	0.5709	275.0	425.0	MK 2
A95215.0	15.00	0.5906	275.0	425.0	MK 2
A95215.5	15.50	0.6102	295.0	445.0	MK 2
A95216.0	16.00	0.6299	295.0	445.0	MK 2
A95216.5	16.50	0.6496	295.0	445.0	MK 2
A95217.0	17.00	0.6693	295.0	445.0	MK 2
A95217.5	17.50	0.6890	310.0	465.0	MK 2
A95218.0	18.00	0.7087	310.0	465.0	MK 2
A95218.5	18.50	0.7283	310.0	465.0	MK 2
A95219.0	19.00	0.7480	310.0	465.0	MK 2
A95219.5	19.50	0.7677	325.0	490.0	MK 2
A95220.0	20.00	0.7874	325.0	490.0	MK 2
A95221.0	21.00	0.8268	325.0	490.0	MK 2
A95222.0	22.00	0.8661	345.0	515.0	MK 2
A95223.0	23.00	0.9055	345.0	515.0	MK 2
A95224.0	24.00	0.9449	365.0	555.0	MK 3
A95225.0	25.00	0.9843	365.0	555.0	MK 3
A95226.0	26.00	1.0236	365.0	555.0	MK 3
A95227.0	27.00	1.0630	385.0	580.0	MK 3
A95228.0	28.00	1.1024	385.0	580.0	MK 3
A95229.0	29.00	1.1417	385.0	580.0	MK 3
A95230.0	30.00	1.1811	385.0	580.0	MK 3
A95231.0	31.00	1.2205	410.0	610.0	MK 3
A95232.0	32.00	1.2598	410.0	635.0	MK 4
A95233.0	33.00	1.2992	410.0	635.0	MK 4
A95234.0	34.00	1.3386	430.0	665.0	MK 4
A95235.0	35.00	1.3780	430.0	665.0	MK 4
A95238.0	38.00	1.4961	460.0	695.0	MK 4
A95240.0	40.00	1.5748	460.0	695.0	MK 4



A400



HSS meerfasen trapboor, 90°, stoomontlaten

Meerfasentrapboor volgens DIN8374 norm is bedoeld voor het verzinken van standaard metrische schroeven onder 90°. De kleine en grote diameter van de boor hebben beide hun eigen spaangroefprofiel zodat de spanen beter worden gevormd en elkaar niet in de weg zitten. De A400 boort enkele tienden groter dan de schroefmaat en verzinkt gelijktijdig de kop. Geschikt voor het boren van vele materialen.

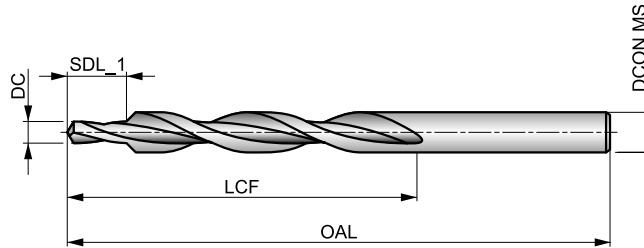

HSS	DIN 8374	4xD
90°	ST	
λ 20-35°	R	118°

De tabel geeft de geschiktheid aan voor de materiaalgroep en de startwaarden voor de snijsnelheid (m/min) en de letter verwijst naar de toe te passen voeding (fn), zie vanaf pagina 175.

P1.1 ■ 29 G	P1.2 ■ 33 G	P1.3 ■ 34 G	P2.1 ■ 25 G	P2.2 ■ 22 E	P2.3 ■ 19 C	P3.1 ■ 15 E	P3.2 ■ 12 E	P3.3 ■ 10 C	P4.1 ■ 9 E	P4.2 ■ 7 C	P4.3 ■ 6 C	M1.1 ■ 22 E	M1.2 ■ 19 E
M2.1 ■ 20 E	M2.2 ■ 16 E	M3.1 ■ 10 G	M3.2 ■ 9 G	M3.3 ■ 8 G	M4.1 ■ 12 C	K1.1 ■ 30 G	K1.2 ■ 22 E	K1.3 ■ 17 E	K2.1 ■ 23 E	K2.2 ■ 19 E	K2.3 ■ 15 C	K3.1 ■ 21 E	K3.2 ■ 16 E
K3.3 ■ 13 C	K4.1 ■ 19 E	K4.2 ■ 14 E	K4.3 ■ 11 C	K4.4 ■ 9 C	K4.5 ■ 8 C	K5.1 ■ 22 E	K5.2 ■ 16 E	K5.3 ■ 13 C	N1.1 ■ 45 E	N1.2 ■ 34 E	N1.3 ■ 23 E	N2.1 ■ 49 E	N2.2 ■ 44 E
N2.3 ■ 32 E	N3.1 ■ 68 E	N3.2 ■ 40 E	N3.3 ■ 20 E	N4.1 ■ 30 I	S1.1 ■ 23 E	S1.2 ■ 14 C	S1.3 ■ 8 A	S2.1 ■ 8 C	S2.2 ■ 6 A	S3.1 ■ 6 C	S3.2 ■ 4 A	S4.1 ■ 5 C	S4.2 ■ 3 A

Product	TDZ	DC	DC	LCF	OAL	SDL_1	DCON MS
		(mm)	(inch)				
A400M3	M3	3.20	0.1260	57.0	93.0	9.00	6.00
A400M4	M4	4.30	0.1693	75.0	117.0	11.00	8.00
A400M5	M5	5.30	0.2087	87.0	133.0	13.00	10.00
A400M6	M6	6.40	0.2520	94.0	142.0	15.00	11.50
A400M8	M8	8.40	0.3307	114.0	169.0	19.00	15.00
A400M10	M10	10.50	0.4134	135.0	198.0	23.00	19.00



A402



HSS meergefasen trapboor, 180°, stoomontlaten

Meergefasen trapboor volgens DIN8374 norm is bedoeld voor het verzinken van standaard metrische schroeven onder 180°. De kleine en grote diameter van de boor hebben beide hun eigen spaangroefprofiel zodat de spanen beter worden gevormd en elkaar niet in de weg zitten. Geschikt voor het boren van vele materialen.

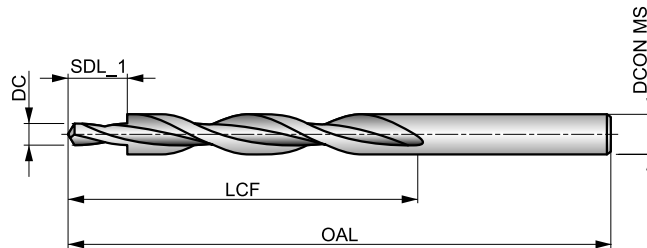

HSS	DIN 8376	4xD
180°	ST	
λ 20-35°	R	118°

De tabel geeft de geschiktheid aan voor de materiaalgroep en de startwaarden voor de snijsnelheid (m/min) en de letter verwijst naar de toe te passen voeding (fn), zie vanaf pagina 175.

P1.1 ■ 29 G	P1.2 ■ 33 G	P1.3 ■ 34 G	P2.1 ■ 25 G	P2.2 ■ 22 E	P2.3 ■ 19 C	P3.1 ■ 15 E	P3.2 ■ 12 E	P3.3 ■ 10 C	P4.1 ■ 9 E	P4.2 ■ 17 C	P4.3 ■ 16 C	M1.1 ■ 22 E	M1.2 ■ 19 E
M2.1 ■ 20 E	M2.2 ■ 16 E	M3.1 ■ 10 G	M3.2 ■ 9 G	M3.3 ■ 8 G	M4.1 ■ 12 C	K1.1 ■ 30 G	K1.2 ■ 22 E	K1.3 ■ 17 E	K2.1 ■ 23 E	K2.2 ■ 19 E	K2.3 ■ 15 C	K3.1 ■ 21 E	K3.2 ■ 16 E
K3.3 ■ 13 C	K4.1 ■ 19 E	K4.2 ■ 14 E	K4.3 ■ 11 C	K4.4 ■ 9 C	K4.5 ■ 8 C	K5.1 ■ 22 E	K5.2 ■ 16 E	K5.3 ■ 13 C	N1.1 ■ 45 E	N1.2 ■ 34 E	N1.3 ■ 23 E	N2.1 ■ 49 E	N2.2 ■ 44 E
N2.3 ■ 32 E	N3.1 ■ 68 E	N3.2 ■ 40 E	N3.3 ■ 20 E	N4.1 ■ 30 I	S1.1 ■ 23 E	S1.2 ■ 14 C	S1.3 ■ 8 A	S2.1 ■ 8 C	S2.2 ■ 6 A	S3.1 ■ 6 C	S3.2 ■ 4 A	S4.1 ■ 5 C	S4.2 ■ 3 A

Product	TDZ	DC	DC	LCF	OAL	SDL_1	DCON MS
		(mm)	(inch)				
A402M3	M3	3.40	0.1339	57.0	93.0	9.00	6.00
A402M4	M4	4.50	0.1772	75.0	117.0	11.00	8.00
A402M5	M5	5.50	0.2165	87.0	133.0	13.00	10.00
A402M6	M6	6.60	0.2598	94.0	142.0	15.00	11.00
A402M8	M8	9.00	0.3543	114.0	169.0	19.00	15.00
A402M10	M10	11.00	0.4331	130.0	191.0	23.00	18.00



A405



HSS meerfasen MC trapboor, 180°, stoomontlaten

Meerfasentrapboor met morseconus volgens DIN8377 norm is bedoeld voor het verzinken van standaard metrische schroeven onder 180°. De kleine en grote diameter van de boor hebben beide hun eigen spaangroefprofiel zodat de spanen beter worden gevormd en elkaar niet in de weg zitten. Geschikt voor het boren van vele materialen.

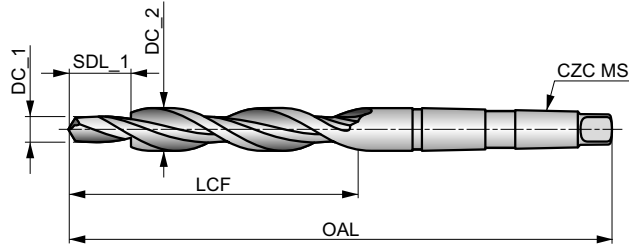

HSS	DIN 8377	4xD
180°	ST	
λ 20-35°	R	118°

De tabel geeft de geschiktheid aan voor de materiaalgroep en de startwaarden voor de snijsnelheid (m/min) en de letter verwijst naar de toe te passen voeding (fn), zie vanaf pagina 175.

P1.1 ■ 29 G	P1.2 ■ 33 G	P1.3 ■ 34 G	P2.1 ■ 25 G	P2.2 ■ 22 E	P2.3 ■ 19 C	P3.1 ■ 15 E	P3.2 ■ 12 E	P3.3 ■ 10 C	P4.1 ■ 9 E	P4.2 ■ 7 C	P4.3 ■ 6 C	M1.1 ■ 22 E	M1.2 ■ 19 E
M2.1 ■ 20 E	M2.2 ■ 16 E	M3.1 ■ 10 G	M3.2 ■ 9 G	M3.3 ■ 8 G	M4.1 ■ 12 C	K1.1 ■ 30 G	K1.2 ■ 22 E	K1.3 ■ 17 E	K2.1 ■ 23 E	K2.2 ■ 19 E	K2.3 ■ 15 C	K3.1 ■ 21 E	K3.2 ■ 16 E
K3.3 ■ 13 C	K4.1 ■ 19 E	K4.2 ■ 14 E	K4.3 ■ 11 C	K4.4 ■ 9 C	K4.5 ■ 8 C	K5.1 ■ 22 E	K5.2 ■ 16 E	K5.3 ■ 13 C	N1.1 ■ 45 E	N1.2 ■ 34 E	N1.3 ■ 23 E	N2.1 ■ 49 E	N2.2 ■ 44 E
N2.3 ■ 32 E	N3.1 ■ 68 E	N3.2 ■ 40 E	N3.3 ■ 20 E	N4.1 ■ 30 I	S1.1 ■ 23 E	S1.2 ■ 14 C	S1.3 ■ 8 A	S2.1 ■ 8 C	S2.2 ■ 6 A	S3.1 ■ 6 C	S3.2 ■ 4 A	S4.1 ■ 5 C	S4.2 ■ 3 A

Product	TDZ	DC_1	DC_1	DC_2	LCF	OAL	SDL_1	CZC MS
		(mm)	(inch)	(mm)	(mm)	(mm)	(mm)	
A405M6	M6	6.60	0.2598	11.00	94.0	175.0	15.00	MK 1
A405M8	M8	9.00	0.3543	15.00	114.0	212.0	19.00	MK 2
A405M10	M10	11.00	0.4331	18.00	130.0	228.0	23.00	MK 2
A405M12	M12	13.50	0.5315	20.00	140.0	238.0	27.00	MK 2
A405M14	M14	15.50	0.6102	24.00	160.0	281.0	31.00	MK 3
A405M16	M16	17.50	0.6890	26.00	165.0	286.0	35.00	MK 3
A405M18	M18	20.00	0.7874	30.00	175.0	296.0	39.00	MK 3



A412



HSS trapboor, 90°, stoomontlaten

Ontworpen voor het boren van afgeschuinde gaten voor standaard metrische schroeven. Tophoek van 118° en verzinkhoek van 90°. Stoomontlaten afwerking houdt snijvloeistof vast en voorkomt het aanlassen van spanen. Geschikt voor het boren van vele materialen. Geschikt voor zowel CNC als conventionele machines.

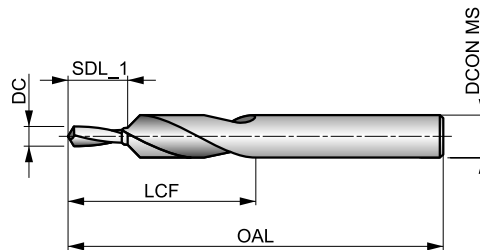

HSS	DORMER	2.5×D
90°	ST	
R	118°	

De tabel geeft de geschiktheid aan voor de materiaalgroep en de startwaarden voor de snijsnelheid (m/min) en de letter verwijst naar de toe te passen voeding (fn), zie vanaf pagina 175.

P1.1 ■ 29 I	P1.2 ■ 33 I	P1.3 ■ 34 I	P2.1 ■ 25 I	P2.2 ■ 22 G	P2.3 ■ 19 E	P3.1 ■ 15 G	P3.2 ■ 12 G	P3.3 ■ 10 E	P4.1 ■ 9 G	P4.2 ■ 17 E	P4.3 ■ 16 C	M1.1 ■ 22 G	M1.2 ■ 19 G
M2.1 ■ 20 G	M2.2 ■ 16 G	M3.1 ■ 10 I	M3.2 ■ 9 I	M3.3 ■ 8 I	M4.1 ■ 12 E	K1.1 ■ 30 G	K1.2 ■ 22 E	K1.3 ■ 17 E	K2.1 ■ 23 E	K2.2 ■ 19 E	K2.3 ■ 15 E	K3.1 ■ 21 E	K3.2 ■ 16 E
K3.3 ■ 13 E	K4.1 ■ 19 E	K4.2 ■ 14 E	K4.3 ■ 11 E	K4.4 ■ 9 E	K4.5 ■ 8 E	K5.1 ■ 22 E	K5.2 ■ 16 E	K5.3 ■ 13 E	N1.1 ■ 45 G	N1.2 ■ 34 G	N1.3 ■ 23 G	N2.1 ■ 42 G	N2.2 ■ 37 G
N2.3 ■ 27 G	N3.1 ■ 68 G	N3.2 ■ 40 G	N3.3 ■ 20 G	N4.1 ■ 30 I	S1.1 ■ 27 G	S1.2 ■ 16 E	S1.3 ■ 8 C	S2.1 ■ 11 G	S2.2 ■ 6 C	S3.1 ■ 8 G	S3.2 ■ 4 C	S4.1 ■ 6 G	S4.2 ■ 3 C

Product	TDZ	DC	DC	LCF	OAL	SDL_1	DCON MS
		(mm)	(inch)				
A412M3	M3	3.40	0.1339	31.0	70.0	9.00	6.60
A412M4	M4	4.50	0.1772	40.0	84.0	11.00	9.00
A412M5	M5	5.50	0.2165	47.0	95.0	13.00	11.00
A412M6	M6	6.60	0.2598	51.0	102.0	15.00	13.00
A412M8	M8	9.00	0.3543	62.0	123.0	19.00	17.20
A412M10	M10	11.00	0.4331	70.0	141.0	23.00	21.50



A413



HSS trapboor, 180°, stoomontlaten

Ontworpen voor het boren van afgeschuinde gaten voor standaard metrische schroeven. Tophoek van 118° en verzinkhoek van 180°. Stoomontlaten afwerking houdt snijvloeistof vast en voorkomt het aanlassen van spanen. Geschikt voor het boren van vele materialen. Geschikt voor zowel CNC als conventionele machines.

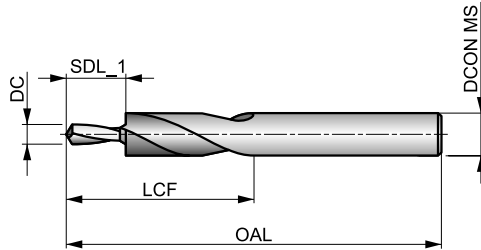

HSS	DORMER	2.5×D
180°	ST	
R	118°	

De tabel geeft de geschiktheid aan voor de materiaalgroep en de startwaarden voor de snijnsnelheid (m/min) en de letter verwijst naar de toe te passen voeding (fn), zie vanaf pagina 175.

P1.1 ■ 29 I	P1.2 ■ 33 I	P1.3 ■ 34 I	P2.1 ■ 25 I	P2.2 ■ 22 G	P2.3 ■ 19 E	P3.1 ■ 15 G	P3.2 ■ 12 G	P3.3 ■ 10 E	P4.1 ■ 9 G	P4.2 ■ 7 E	P4.3 ■ 6 C	M1.1 ■ 22 G	M1.2 ■ 19 G
M2.1 ■ 20 G	M2.2 ■ 16 G	M3.1 ■ 10 I	M3.2 ■ 9 I	M3.3 ■ 8 I	M4.1 ■ 12 E	K1.1 ■ 30 G	K1.2 ■ 22 E	K1.3 ■ 17 E	K2.1 ■ 23 E	K2.2 ■ 19 E	K2.3 ■ 15 E	K3.1 ■ 21 E	K3.2 ■ 16 E
K3.3 ■ 13 E	K4.1 ■ 19 E	K4.2 ■ 14 E	K4.3 ■ 11 E	K4.4 ■ 9 E	K4.5 ■ 8 E	K5.1 ■ 22 E	K5.2 ■ 16 E	K5.3 ■ 13 E	N1.1 ■ 45 G	N1.2 ■ 34 G	N1.3 ■ 23 G	N2.1 ■ 42 G	N2.2 ■ 37 G
N2.3 ■ 27 G	N3.1 ■ 68 G	N3.2 ■ 40 G	N3.3 ■ 20 G	N4.1 ■ 30 I	S1.1 ■ 27 G	S1.2 ■ 16 E	S1.3 ■ 8 C	S2.1 ■ 11 G	S2.2 ■ 6 C	S3.1 ■ 8 G	S3.2 ■ 4 C	S4.1 ■ 6 G	S4.2 ■ 3 C

Product	TDZ	DC	DC	LCF	OAL	SDL_1	DCON MS
		(mm)	(inch)				
A413M3	M3	3.40	0.1339	28.0	66.0	9.00	6.00
A413M4	M4	4.50	0.1772	37.0	79.0	11.00	8.00
A413M5	M5	5.50	0.2165	43.0	89.0	13.00	10.00
A413M6	M6	6.60	0.2598	47.0	95.0	15.00	11.00
A413M8	M8	9.00	0.3543	56.0	111.0	19.00	15.00
A413M10	M10	11.00	0.4331	62.0	123.0	23.00	18.00



A200



HSS centerboor DIN333A, 118° tophoek en 60° centreerhoek

Centerboor voor het maken van een nauwkeurig gat in het uiteinde van een as, zodat deze vervolgens stabiel kan worden opgespannen om bewerkt te worden. Dubbelzijdig uitgevoerd met een aanschuifhoek van 60°. Geschikt voor veel verschillende materialen.

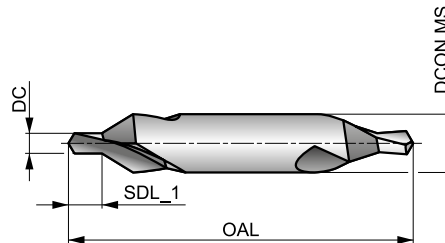
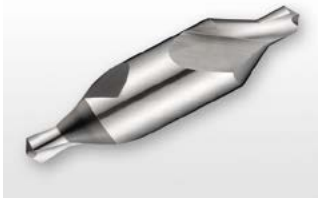

HSS	DIN 333A	1×D
60°	Bright	
R	118°	

De tabel geeft de geschiktheid aan voor de materiaalgroep en de startwaarden voor de snijsnelheid (m/min) en de letter verwijst naar de toe te passen voeding (fn), zie vanaf pagina 175.

P1.1 ■ 33 I	P1.2 ■ 37 I	P1.3 ■ 38 I	P2.1 ■ 28 I	P2.2 ■ 25 G	P2.3 ■ 22 E	P3.1 ■ 19 F	P3.2 ■ 15 F	P3.3 ■ 13 E	P4.1 ■ 11 F	P4.2 ■ 10 E	P4.3 ■ 8 D	M1.1 ■ 21 E	M1.2 ■ 17 E
M2.1 ■ 18 E	M2.2 ■ 15 E	M3.1 ■ 9 G	M3.2 ■ 8 G	M3.3 ■ 7 G	M4.1 ■ 10 C	K1.1 ■ 30 I	K1.2 ■ 22 F	K1.3 ■ 17 F	K2.1 ■ 25 E	K2.2 ■ 20 E	K2.3 ■ 16 E	K3.1 ■ 22 E	K3.2 ■ 17 E
K3.3 ■ 13 E	K4.1 ■ 20 E	K4.2 ■ 15 E	K4.3 ■ 11 E	K4.4 ■ 10 E	K4.5 ■ 8 E	K5.1 ■ 23 E	K5.2 ■ 17 E	K5.3 ■ 13 E	N1.1 ■ 33 J	N1.2 ■ 25 J	N1.3 ■ 17 I	N2.1 ■ 42 H	N2.2 ■ 37 H
N2.3 ■ 27 H	N3.1 ■ 56 H	N3.2 ■ 33 I	N3.3 ■ 17 G	N4.1 ■ 30 J	N4.2 ■ 28 H	N4.3 ■ 14 F	S1.1 ■ 24 F	S1.2 ■ 13 D	S1.3 ■ 7 B	S2.1 ■ 7 E	S2.2 ■ 6 A	S3.1 ■ 5 E	S3.2 ■ 4 A
S4.1 ■ 4 E	S4.2 ■ 3 A												

Deze producten zijn ook in een set verkrijgbaar. Zie A296.

Product	DC	DC	SDL_1	OAL	DCON MS
	(mm)	(inch)	(mm)	(mm)	(mm)
A200.5X3.15 ¹⁾	0.50	0.0197	0.9 - 0.6	25.0	3.15
A200.8X3.15 ¹⁾	0.80	0.0315	1.3 - 1.0	25.0	3.15
A2001.0X3.15	1.00	0.0394	1.7 - 1.3	31.0	3.15
A2001.25X3.15	1.25	0.0492	2.0 - 1.6	31.0	3.15
A2001.6X4.0	1.60	0.0630	2.6 - 2.0	35.0	4.00
A2002.0X5.0	2.00	0.0787	3.1 - 2.5	40.0	5.00
A2002.5X6.3	2.50	0.0984	3.8 - 3.1	45.0	6.30
A2003.15X8.0	3.15	0.1240	4.6 - 3.9	50.0	8.00
A2004.0X10.0	4.00	0.1575	5.9 - 5.0	55.0	10.00
A2005.0X12.5	5.00	0.1969	7.2 - 6.3	63.0	12.50
A2006.3X16.0	6.30	0.2480	8.9 - 8.0	71.0	16.00
A2008.0X20.0	8.00	0.3150	11.1 - 10.1	80.0	20.00
A20010.0X25.0	10.00	0.3937	13.8 - 12.8	100.0	25.00
A20012.5X31.5	12.50	0.4921	17.5 - 16.5	125.0	31.50

¹⁾ Alleen enkelzijdig.



A205



HSS centerboor DIN333A, 118° tophoek en 60° centreehoek, TiN gecoat

Centerboor voor het maken van een nauwkeurig gat in het uiteinde van een as, zodat deze vervolgens stabiel kan worden opgespannen om bewerkt te worden. Dubbelzijdig uitgevoerd met een aanschuifhoek van 60°. TiN coating verbetert de prestaties en verlengt de standtijd. Geschikt voor veel verschillende materialen.

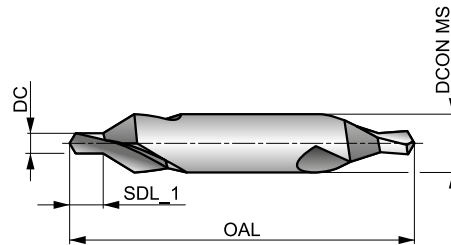

HSS	DIN 333A	1xD
60°	TiN	
R	118°	

De tabel geeft de geschiktheid aan voor de materiaalgroep en de startwaarden voor de snijsnelheid (m/min) en de letter verwijst naar de toe te passen voeding (fn), zie vanaf pagina 175.

P1.1 ■ 40 I	P1.2 ■ 45 I	P1.3 ■ 46 I	P2.1 ■ 34 I	P2.2 ■ 30 G	P2.3 ■ 27 E	P3.1 ■ 24 F	P3.2 ■ 19 F	P3.3 ■ 16 E	P4.1 ■ 14 F	P4.2 ■ 12 E	P4.3 ■ 10 D	M1.1 ■ 25 E	M1.2 ■ 21 E
M2.1 ■ 22 E	M2.2 ■ 18 E	M3.1 ■ 12 G	M3.2 ■ 10 G	M3.3 ■ 9 G	M4.1 ■ 12 C	K1.1 ■ 36 I	K1.2 ■ 27 F	K1.3 ■ 20 F	K2.1 ■ 30 E	K2.2 ■ 24 E	K2.3 ■ 19 E	K3.1 ■ 26 E	K3.2 ■ 20 E
K3.3 ■ 16 E	K4.1 ■ 24 E	K4.2 ■ 18 E	K4.3 ■ 13 E	K4.4 ■ 11 E	K4.5 ■ 10 E	K5.1 ■ 27 E	K5.2 ■ 21 E	K5.3 ■ 16 E	N1.1 ■ 40 J	N1.2 ■ 30 J	N1.3 ■ 20 I	N2.1 ■ 49 H	N2.2 ■ 44 H
N2.3 ■ 32 H	N3.1 ■ 68 H	N3.2 ■ 40 I	N3.3 ■ 20 G	N4.1 ■ 36 J	N4.2 ■ 34 H	N4.3 ■ 17 F	S1.1 ■ 29 F	S1.2 ■ 16 D	S1.3 ■ 8 B	S2.1 ■ 8 E	S2.2 ■ 7 A	S3.1 ■ 6 E	S3.2 ■ 5 A
S4.1 ■ 5 E	S4.2 ■ 4 A												

Product	DC	DC	SDL_1	OAL	D CON MS
	(mm)	(inch)	(mm)	(mm)	(mm)
A2051.0X3.15	1.00	0.0394	1.7 - 1.3	31.0	3.15
A2051.25X3.15	1.25	0.0492	2.0 - 1.6	31.0	3.15
A2051.6X4.0	1.60	0.0630	2.6 - 2.0	35.0	4.00
A2052.0X5.0	2.00	0.0787	3.1 - 2.5	40.0	5.00
A2052.5X6.3	2.50	0.0984	3.8 - 3.1	45.0	6.30
A2053.15X8.0	3.15	0.1240	4.6 - 3.9	50.0	8.00
A2054.0X10.0	4.00	0.1575	5.9 - 5.0	55.0	10.00
A2055.0X12.5	5.00	0.1969	7.2 - 6.3	63.0	12.50



A206



HSS-E centerboor DIN333A, 118° tophoek en 60° centreerhoek

Centerboor voor het maken van een nauwkeurig gat in het uiteinde van een as, zodat deze vervolgens stabiel kan worden opgespannen om bewerkt te worden. Dubbelzijdig uitgevoerd met een aanschuifhoek van 60°. Geschikt voor veel verschillende materialen.

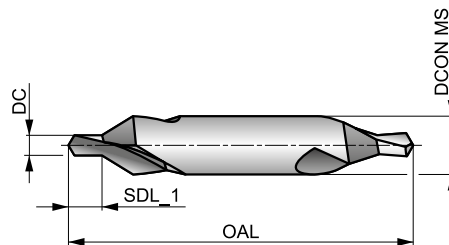
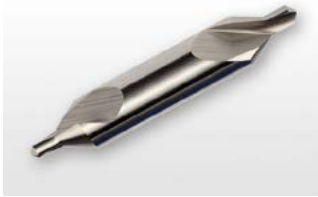

HSS-E	DIN 333A	1×D
60°	Bright	
R	118°	

De tabel geeft de geschiktheid aan voor de materiaalgroep en de startwaarden voor de snijsnelheid (m/min) en de letter verwijst naar de toe te passen voeding (fn), zie vanaf pagina 175.

P1.1 ■ 40 I	P1.2 ■ 45 I	P1.3 ■ 46 I	P2.1 ■ 34 I	P2.2 ■ 30 G	P2.3 ■ 27 E	P3.1 ■ 24 F	P3.2 ■ 19 F	P3.3 ■ 16 E	P4.1 ■ 14 F	P4.2 ■ 12 E	P4.3 ■ 10 D	M1.1 ■ 25 E	M1.2 ■ 21 E
M2.1 ■ 22 E	M2.2 ■ 18 E	M3.1 ■ 12 G	M3.2 ■ 10 G	M3.3 ■ 9 G	M4.1 ■ 12 C	K1.1 ■ 36 I	K1.2 ■ 27 F	K1.3 ■ 20 F	K2.1 ■ 30 E	K2.2 ■ 24 E	K2.3 ■ 19 E	K3.1 ■ 26 E	K3.2 ■ 20 E
K3.3 ■ 16 E	K4.1 ■ 24 E	K4.2 ■ 18 E	K4.3 ■ 13 E	K4.4 ■ 11 E	K4.5 ■ 10 E	K5.1 ■ 27 E	K5.2 ■ 21 E	K5.3 ■ 16 E	N1.1 ■ 40 J	N1.2 ■ 30 J	N1.3 ■ 20 I	N2.1 ■ 49 H	N2.2 ■ 44 H
N2.3 ■ 32 H	N3.1 ■ 68 H	N3.2 ■ 40 I	N3.3 ■ 20 G	N4.1 ■ 36 J	N4.2 ■ 34 H	N4.3 ■ 17 F	S1.1 ■ 29 F	S1.2 ■ 16 D	S1.3 ■ 8 B	S2.1 ■ 8 E	S2.2 ■ 7 A	S3.1 ■ 6 E	S3.2 ■ 5 A
S4.1 ■ 5 E	S4.2 ■ 4 A												

Product	DC	DC	SDL_1	OAL	DCON MS
	(mm)	(inch)	(mm)	(mm)	(mm)
A2061.0X3.15	1.00	0.0394	1.7 - 1.3	31.0	3.15
A2061.25X3.15	1.25	0.0492	2.0 - 1.6	31.0	3.15
A2061.6X4.0	1.60	0.0630	2.6 - 2.0	35.0	4.00
A2062.0X5.0	2.00	0.0787	3.1 - 2.5	40.0	5.00
A2062.5X6.3	2.50	0.0984	3.8 - 3.1	45.0	6.30
A2063.15X8.0	3.15	0.1240	4.6 - 3.9	50.0	8.00
A2064.0X10.0	4.00	0.1575	5.9 - 5.0	55.0	10.00
A2065.0X12.5	5.00	0.1969	7.2 - 6.3	63.0	12.50



A266



HSS-E centerboor DIN333A, 118° tophoek en 60° centreerhoek, TiAlN gecoat

Centerboor voor het maken van een nauwkeurig gat in het uiteinde van een as, zodat deze vervolgens stabiel kan worden opgespannen om bewerkt te worden. Dubbelzijdig uitgevoerd met een aanschuinhoek van 60°. TiAlN coating verbetert de prestaties en verlengt de standtijd. Geschikt voor veel verschillende materialen.

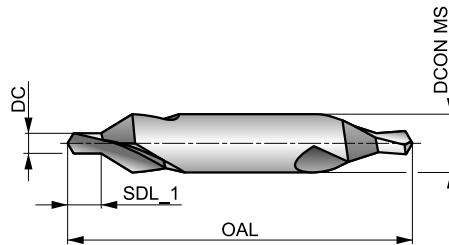

HSS-E	DIN 333A	1xD
60°	TiAlN	
R	118°	

De tabel geeft de geschiktheid aan voor de materiaalgroep en de startwaarden voor de snijnsnelheid (m/min) en de letter verwijst naar de toe te passen voeding (fn), zie vanaf pagina 175.

P1.1 ■ 40 I	P1.2 ■ 45 I	P1.3 ■ 46 I	P2.1 ■ 34 I	P2.2 ■ 30 G	P2.3 ■ 27 E	P3.1 ■ 24 F	P3.2 ■ 19 F	P3.3 ■ 16 E	P4.1 ■ 14 F	P4.2 ■ 12 E	P4.3 ■ 10 D	M1.1 ■ 25 E	M1.2 ■ 21 E
M2.1 ■ 22 E	M2.2 ■ 18 E	M3.1 ■ 12 G	M3.2 ■ 10 G	M3.3 ■ 9 G	M4.1 ■ 12 C	K1.1 ■ 36 I	K1.2 ■ 27 F	K1.3 ■ 20 F	K2.1 ■ 30 E	K2.2 ■ 24 E	K2.3 ■ 19 E	K3.1 ■ 26 E	K3.2 ■ 20 E
K3.3 ■ 16 E	K4.1 ■ 24 E	K4.2 ■ 18 E	K4.3 ■ 13 E	K4.4 ■ 11 E	K4.5 ■ 10 E	K5.1 ■ 27 E	K5.2 ■ 21 E	K5.3 ■ 16 E	N1.1 ■ 40 J	N1.2 ■ 30 J	N1.3 ■ 20 I	N2.1 ■ 49 H	N2.2 ■ 44 H
N2.3 ■ 32 H	N3.1 ■ 68 H	N3.2 ■ 40 I	N3.3 ■ 20 G	N4.1 ■ 36 J	N4.2 ■ 34 H	N4.3 ■ 17 F	S1.1 ■ 29 F	S1.2 ■ 16 D	S1.3 ■ 8 B	S2.1 ■ 8 E	S2.2 ■ 7 A	S3.1 ■ 6 E	S3.2 ■ 5 A
S4.1 ■ 5 E	S4.2 ■ 4 A												

Product	DC	DC	SDL_1	OAL	DCON MS
	(mm)	(inch)	(mm)	(mm)	(mm)
A2661.0X3.15	1.00	0.0394	1.7 - 1.3	31.0	3.15
A2661.25X3.15	1.25	0.0492	2.0 - 1.6	31.0	3.15
A2661.6X4.0	1.60	0.0630	2.6 - 2.0	35.0	4.00
A2662.0X5.0	2.00	0.0787	3.1 - 2.5	40.0	5.00
A2662.5X6.3	2.50	0.0984	3.8 - 3.1	45.0	6.30
A2663.15X8.0	3.15	0.1240	4.6 - 3.9	50.0	8.00
A2664.0X10.0	4.00	0.1575	5.9 - 5.0	55.0	10.00
A2665.0X12.5	5.00	0.1969	7.2 - 6.3	63.0	12.50



A210

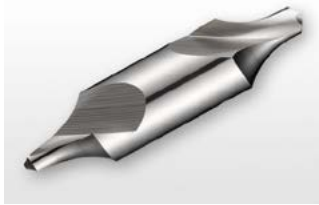

HSS centerboor DIN333R, 118° tophoek en concave centreerradius

Centerboor voor het maken van een nauwkeurig gat in het uiteinde van een as, zodat deze vervolgens stabiel kan worden opgespannen om bewerkt te worden. Dubbelzijdig uitgevoerd met een radius als aanschuining. Geschikt voor veel verschillende materialen.

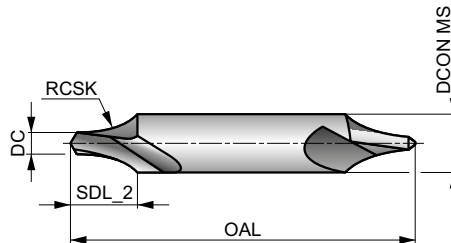

HSS	DIN 333R	1×D
R	Bright	
R	118°	

De tabel geeft de geschiktheid aan voor de materiaalgroep en de startwaarden voor de snijsnelheid (m/min) en de letter verwijst naar de toe te passen voeding (fn), zie vanaf pagina 175.

P1.1 ■ 33 I	P1.2 ■ 37 I	P1.3 ■ 38 I	P2.1 ■ 28 I	P2.2 ■ 25 G	P2.3 ■ 22 E	P3.1 ■ 19 F	P3.2 ■ 15 F	P3.3 ■ 13 E	P4.1 ■ 11 F	P4.2 ■ 10 E	P4.3 ■ 8 D	M1.1 ■ 21 E	M1.2 ■ 17 E
M2.1 ■ 18 E	M2.2 ■ 15 E	M3.1 ■ 9 G	M3.2 ■ 8 G	M3.3 ■ 7 G	M4.1 ■ 10 C	K1.1 ■ 30 I	K1.2 ■ 22 F	K1.3 ■ 17 F	K2.1 ■ 25 E	K2.2 ■ 20 E	K2.3 ■ 16 E	K3.1 ■ 22 E	K3.2 ■ 17 E
K3.3 ■ 13 E	K4.1 ■ 20 E	K4.2 ■ 15 E	K4.3 ■ 11 E	K4.4 ■ 10 E	K4.5 ■ 8 E	K5.1 ■ 23 E	K5.2 ■ 17 E	K5.3 ■ 13 E	N1.1 ■ 33 J	N1.2 ■ 25 J	N1.3 ■ 17 I	N2.1 ■ 42 H	N2.2 ■ 37 H
N2.3 ■ 27 H	N3.1 ■ 56 H	N3.2 ■ 33 I	N3.3 ■ 17 G	N4.1 ■ 30 J	N4.2 ■ 28 H	N4.3 ■ 14 F	S1.1 ■ 24 F	S1.2 ■ 13 D	S1.3 ■ 7 B	S2.1 ■ 7 E	S2.2 ■ 6 A	S3.1 ■ 5 E	S3.2 ■ 4 A
S4.1 ■ 4 E	S4.2 ■ 3 A												

Product	DC	DC	SDL_2	OAL	RCSK	DCON MS
	(mm)	(inch)	(mm)	(mm)	(mm)	(mm)
A210.5X3.15 ¹⁾	0.50	0.0197	2.6 - 2.3	25.0	2.50 - 2.00	3.15
A210.8X3.15 ¹⁾	0.80	0.0315	2.9 - 2.6	25.0	3.15 - 2.50	3.15
A2101.0X3.15	1.00	0.0394	3.3 - 3.0	31.0	3.65 - 2.90	3.15
A2101.25X3.15	1.25	0.0492	3.6 - 3.3	31.0	3.95 - 3.15	3.15
A2101.6X4.0	1.60	0.0630	4.7 - 4.2	35.0	5.00 - 4.00	4.00
A2102.0X5.0	2.00	0.0787	5.4 - 5.0	40.0	6.25 - 5.00	5.00
A2102.5X6.3	2.50	0.0984	6.8 - 6.3	45.0	7.88 - 6.30	6.30
A2103.15X8.0	3.15	0.1240	8.5 - 8.0	50.0	10.00 - 8.00	8.00
A2104.0X10.0	4.00	0.1575	10.6 - 10.0	55.0	12.50 - 10.00	10.00
A2105.0X12.5	5.00	0.1969	13.1 - 12.5	63.0	15.63 - 12.50	12.50
A2106.3X16.0	6.30	0.2480	16.6 - 16.0	71.0	20.00 - 16.00	16.00
A2108.0X20.0	8.00	0.3150	20.7 - 20.0	80.0	25.00 - 20.00	20.00
A21010.0X25.0	10.00	0.3937	25.7 - 25.0	100.0	31.25 - 25.00	25.00

¹⁾ Alleen enkelzijdig.



A201



HSS centerboor, 122° tophoek en 60° centreehoek

Centerboor voor het maken van een nauwkeurig gat in het uiteinde van een as, zodat deze vervolgens stabiel kan worden opgespannen om bewerkt te worden. Dubbelzijdig uitgevoerd met een aanschuifhoek van 60°. Geschikt voor veel verschillende materialen.

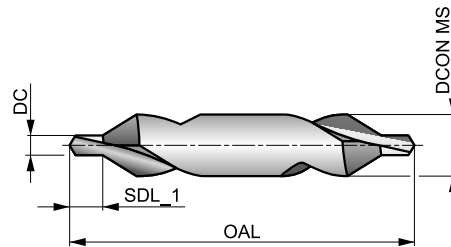

HSS	DORMER	1xD
60°	Bright	
R	122°	

De tabel geeft de geschiktheid aan voor de materiaalgroep en de startwaarden voor de snijsnelheid (m/min) en de letter verwijst naar de toe te passen voeding (fn), zie vanaf pagina 175.

P1.1 ■ 33 I	P1.2 ■ 37 I	P1.3 ■ 38 I	P2.1 ■ 28 I	P2.2 ■ 25 G	P2.3 ■ 22 E	P3.1 ■ 19 F	P3.2 ■ 15 F	P3.3 ■ 13 E	P4.1 ■ 11 F	P4.2 ■ 10 E	P4.3 ■ 8 D	M1.1 ■ 21 E	M1.2 ■ 17 E
M2.1 ■ 18 E	M2.2 ■ 15 E	M3.1 ■ 9 G	M3.2 ■ 8 G	M3.3 ■ 7 G	M4.1 ■ 10 C	K1.1 ■ 30 I	K1.2 ■ 22 F	K1.3 ■ 17 F	K2.1 ■ 25 E	K2.2 ■ 20 E	K2.3 ■ 16 E	K3.1 ■ 22 E	K3.2 ■ 17 E
K3.3 ■ 13 E	K4.1 ■ 20 E	K4.2 ■ 15 E	K4.3 ■ 11 E	K4.4 ■ 10 E	K4.5 ■ 8 E	K5.1 ■ 23 E	K5.2 ■ 17 E	K5.3 ■ 13 E	N1.1 ■ 33 J	N1.2 ■ 25 J	N1.3 ■ 17 I	N2.1 ■ 42 H	N2.2 ■ 37 H
N2.3 ■ 27 H	N3.1 ■ 56 H	N3.2 ■ 33 I	N3.3 ■ 17 G	N4.1 ■ 30 J	N4.2 ■ 28 H	N4.3 ■ 14 F	S1.1 ■ 24 F	S1.2 ■ 13 D	S1.3 ■ 7 B	S2.1 ■ 7 E	S2.2 ■ 6 A	S3.1 ■ 5 E	S3.2 ■ 4 A
S4.1 ■ 4 E	S4.2 ■ 3 A												

Product	DC	DC	SDL_1	OAL	DCON MS
	(mm)	(inch)			
A201.63X3.15 ¹⁾	0.63	0.0248	1.2 - 0.9	20.0	3.15
A201.75X3.5	0.75	0.0295	1.3 - 1.0	35.0	3.50
A2011.0X4.0	1.00	0.0394	2.1 - 1.5	35.0	4.00
A2011.5X5.0	1.50	0.0591	2.8 - 2.0	40.0	5.00
A2011.6X5.0	1.60	0.0630	2.4 - 2.0	40.0	5.00
A2012.0X6.0	2.00	0.0787	4.0 - 3.0	45.0	6.00
A2012.0X6.3	2.00	0.0787	2.9 - 2.5	45.0	6.30
A2012.5X8.0	2.50	0.0984	4.5 - 3.5	50.0	8.00
A2013.0X8.0	3.00	0.1181	4.4 - 3.9	50.0	8.00
A2013.0X10.0	3.00	0.1181	5.0 - 4.0	56.0	10.00
A2013.15X10.0	3.15	0.1240	4.4 - 3.9	56.0	10.00
A2014.0X12.0	4.00	0.1575	6.2 - 5.0	66.0	12.00
A2015.0X14.0	5.00	0.1969	7.7 - 6.5	78.0	14.00
A2016.0X18.0	6.00	0.2362	9.2 - 8.0	90.0	18.00

¹⁾ Alleen enkelzijdig.



A225



HSS centerboor BS328, 120° tophoek en 60° centreerhoek

Centerboor voor het maken van een nauwkeurig gat in het uiteinde van een as, zodat deze vervolgens stabiel kan worden opgespannen om bewerkt te worden. Dubbelzijdig uitgevoerd met een aanschuifhoek van 60°. Geschikt voor veel verschillende materialen.

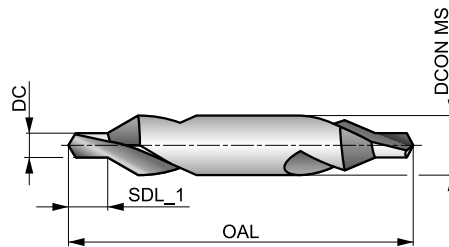
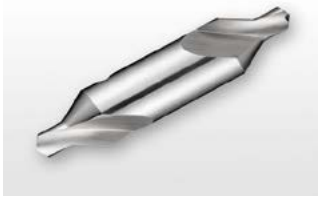

HSS	BS 328	1×D
60°	Bright	
R	120°	

De tabel geeft de geschiktheid aan voor de materiaalgroep en de startwaarden voor de snijsnelheid (m/min) en de letter verwijst naar de toe te passen voeding (fn), zie vanaf pagina 175.

P1.1 ■ 33 I	P1.2 ■ 37 I	P1.3 ■ 38 I	P2.1 ■ 28 I	P2.2 ■ 25 G	P2.3 ■ 22 E	P3.1 ■ 19 F	P3.2 ■ 15 F	P3.3 ■ 13 E	P4.1 ■ 11 F	P4.2 ■ 10 E	P4.3 ■ 8 D	M1.1 ■ 21 E	M1.2 ■ 17 E
M2.1 ■ 18 E	M2.2 ■ 15 E	M3.1 ■ 9 G	M3.2 ■ 8 G	M3.3 ■ 7 G	M4.1 ■ 10 C	K1.1 ■ 30 I	K1.2 ■ 22 F	K1.3 ■ 17 F	K2.1 ■ 25 E	K2.2 ■ 20 E	K2.3 ■ 16 E	K3.1 ■ 22 E	K3.2 ■ 17 E
K3.3 ■ 13 E	K4.1 ■ 20 E	K4.2 ■ 15 E	K4.3 ■ 11 E	K4.4 ■ 10 E	K4.5 ■ 8 E	K5.1 ■ 23 E	K5.2 ■ 17 E	K5.3 ■ 13 E	N1.1 ■ 33 J	N1.2 ■ 25 J	N1.3 ■ 17 I	N2.1 ■ 42 H	N2.2 ■ 37 H
N2.3 ■ 27 H	N3.1 ■ 56 H	N3.2 ■ 33 I	N3.3 ■ 17 G	N4.1 ■ 30 J	N4.2 ■ 28 H	N4.3 ■ 14 F	S1.1 ■ 24 F	S1.2 ■ 13 D	S1.3 ■ 7 B	S2.1 ■ 7 E	S2.2 ■ 6 A	S3.1 ■ 5 E	S3.2 ■ 4 A
S4.1 ■ 4 E	S4.2 ■ 3 A												

Deze producten zijn ook in een set verkrijgbaar. Zie A296.

Product	Nr.	DC (inch)	DC (inch)	SDL_1 (inch)	OAL (inch)	DCONMS (inch)
A225BS1	BS1	3/64	0.0469	5/64 - 1/16	1.1/2	1/8
A225BS2	BS2	1/16	0.0625	3/32 - 5/64	1.3/4	3/16
A225BS3	BS3	3/32	0.0938	5/32 - 1/8	2"	1/4
A225BS4	BS4	1/8	0.1250	3/16 - 5/32	2.1/4	5/16
A225BS5	BS5	3/16	0.1875	9/32 - 1/4	2.1/2	7/16
A225BS5A	BSSA	7/32	0.2188	5/16 - 9/32	2.3/4	1/2
A225BS6	BS6	1/4	0.2500	3/8 - 5/16	3"	5/8
A225BS7	BS7	5/16	0.3125	15/32 - 13/32	3.1/2	3/4



A237



HSS-E centerboor DIN333A, 118° tophoek en 60° centreerhoek

Centerboor voor het maken van een nauwkeurig gat in het uiteinde van een as, zodat deze vervolgens stabiel kan worden opgespannen om bewerkt te worden. Dubbelzijdig uitgevoerd met een aanschuinhoek van 60°. Plat vlak aan de schacht voor betere klemming in de houder. Geschikt voor veel verschillende materialen.

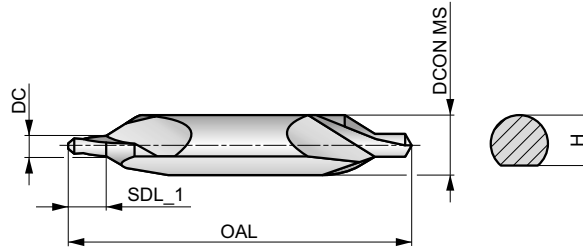

HSS-E	DIN 333A	1xD
60°	Bright	H
R	118°	

De tabel geeft de geschiktheid aan voor de materiaalgroep en de startwaarden voor de snijnsnelheid (m/min) en de letter verwijst naar de toe te passen voeding (fn), zie vanaf pagina 175.

P1.1 ■ 33 I	P1.2 ■ 37 I	P1.3 ■ 38 I	P2.1 ■ 28 I	P2.2 ■ 25 G	P2.3 ■ 22 E	P3.1 ■ 19 F	P3.2 ■ 15 F	P3.3 ■ 13 E	P4.1 ■ 11 F	P4.2 ■ 10 E	P4.3 ■ 8 D	M1.1 ■ 21 E	M1.2 ■ 17 E
M2.1 ■ 18 E	M2.2 ■ 15 E	M3.1 ■ 9 G	M3.2 ■ 8 G	M3.3 ■ 7 G	M4.1 ■ 10 C	K1.1 ■ 30 I	K1.2 ■ 22 F	K1.3 ■ 17 F	K2.1 ■ 25 E	K2.2 ■ 20 E	K2.3 ■ 16 E	K3.1 ■ 22 E	K3.2 ■ 17 E
K3.3 ■ 13 E	K4.1 ■ 20 E	K4.2 ■ 15 E	K4.3 ■ 11 E	K4.4 ■ 10 E	K4.5 ■ 8 E	K5.1 ■ 23 E	K5.2 ■ 17 E	K5.3 ■ 13 E	N1.1 ■ 33 J	N1.2 ■ 25 J	N1.3 ■ 17 I	N2.1 ■ 42 H	N2.2 ■ 37 H
N2.3 ■ 27 H	N3.1 ■ 56 H	N3.2 ■ 33 I	N3.3 ■ 17 G	N4.1 ■ 30 J	N4.2 ■ 28 H	N4.3 ■ 14 F	S1.1 ■ 24 F	S1.2 ■ 13 D	S1.3 ■ 7 B	S2.1 ■ 7 E	S2.2 ■ 6 A	S3.1 ■ 5 E	S3.2 ■ 4 A
S4.1 ■ 4 E	S4.2 ■ 3 A												

Product	DC	DC	SDL_1	OAL	DCON MS	H
	(mm)	(inch)	(mm)	(mm)	(mm)	(mm)
A2371.6X4.0	1.60	0.0630	2.6 - 2.0	35.0	4.00	3.25 - 3.15
A2372.0X5.0	2.00	0.0787	3.1 - 2.5	40.0	5.00	4.20 - 4.10
A2372.5X6.3	2.50	0.0984	3.8 - 3.1	45.0	6.30	5.35 - 5.25
A2373.15X8.0	3.15	0.1240	4.6 - 3.9	50.0	8.00	6.95 - 6.85
A2374.0X10.0	4.00	0.1575	5.9 - 5.0	55.0	10.00	8.40 - 8.30
A2375.0X12.5	5.00	0.1969	7.2 - 6.3	63.0	12.50	10.95 - 10.85
A2376.3X16.0	6.30	0.2480	8.9 - 8.0	71.0	16.00	14.00 - 13.90
A2378.0X20.0	8.00	0.3150	11.1 - 10.1	80.0	20.00	17.90 - 17.80
A23710.0X25.0	10.00	0.3937	13.8 - 12.8	100.0	25.00	22.50 - 22.40



A238



HSS-E centerboor DIN333R, 118° tophoek en concave centreerradius

Centerboor voor het maken van een nauwkeurig gat in het uiteinde van een as, zodat deze vervolgens stabiel kan worden opgespannen om bewerkt te worden. Dubbelzijdig uitgevoerd met een radius als aanschuining. Plat vlak aan de schacht voor betere klemming in de houder. Geschikt voor veel verschillende materialen.

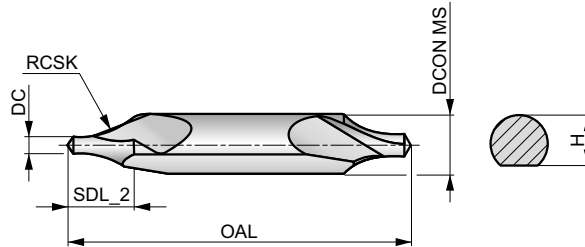

HSS-E	DIN 333R	1xD
R	Bright	H
R	118°	

De tabel geeft de geschiktheid aan voor de materiaalgroep en de startwaarden voor de snijsnelheid (m/min) en de letter verwijst naar de toe te passen voeding (fn), zie vanaf pagina 175.

P1.1 ■ 33 I	P1.2 ■ 37 I	P1.3 ■ 38 I	P2.1 ■ 28 I	P2.2 ■ 25 G	P2.3 ■ 22 E	P3.1 ■ 19 F	P3.2 ■ 15 F	P3.3 ■ 13 E	P4.1 ■ 11 F	P4.2 ■ 10 E	P4.3 ■ 8 D	M1.1 ■ 21 E	M1.2 ■ 17 E
M2.1 ■ 18 E	M2.2 ■ 15 E	M3.1 ■ 9 G	M3.2 ■ 8 G	M3.3 ■ 7 G	M4.1 ■ 10 C	K1.1 ■ 30 I	K1.2 ■ 22 F	K1.3 ■ 17 F	K2.1 ■ 25 E	K2.2 ■ 20 E	K2.3 ■ 16 E	K3.1 ■ 22 E	K3.2 ■ 17 E
K3.3 ■ 13 E	K4.1 ■ 20 E	K4.2 ■ 15 E	K4.3 ■ 11 E	K4.4 ■ 10 E	K4.5 ■ 8 E	K5.1 ■ 23 E	K5.2 ■ 17 E	K5.3 ■ 13 E	N1.1 ■ 33 J	N1.2 ■ 25 J	N1.3 ■ 17 I	N2.1 ■ 42 H	N2.2 ■ 37 H
N2.3 ■ 27 H	N3.1 ■ 56 H	N3.2 ■ 33 I	N3.3 ■ 17 G	N4.1 ■ 30 J	N4.2 ■ 28 H	N4.3 ■ 14 F	S1.1 ■ 24 F	S1.2 ■ 13 D	S1.3 ■ 7 B	S2.1 ■ 7 E	S2.2 ■ 6 A	S3.1 ■ 5 E	S3.2 ■ 4 A
S4.1 ■ 4 E	S4.2 ■ 3 A												

Product	DC	DC	SDL_2	OAL	RCSR	DCON MS	H
	(mm)	(inch)	(mm)	(mm)	(mm)	(mm)	(mm)
A2381.6X4.0	1.60	0.0630	4.7 - 4.2	35.0	5.00 - 4.00	4.00	3.25 - 3.15
A2382.0X5.0	2.00	0.0787	5.4 - 5.0	40.0	6.25 - 5.00	5.00	4.20 - 4.10
A2382.5X6.3	2.50	0.0984	6.8 - 6.3	45.0	7.88 - 6.30	6.30	5.35 - 5.25
A2383.15X8.0	3.15	0.1240	8.5 - 8.0	50.0	10.00 - 8.00	8.00	6.95 - 6.85
A2384.0X10.0	4.00	0.1575	10.6 - 10.0	55.0	12.50 - 10.00	10.00	8.40 - 8.30
A2385.0X12.5	5.00	0.1969	13.1 - 12.5	63.0	15.63 - 12.50	12.50	10.95 - 10.85
A2386.3X16.0	6.30	0.2480	16.6 - 16.0	71.0	20.00 - 16.00	16.00	14.00 - 13.90
A2388.0X20.0	8.00	0.3150	20.7 - 20.0	80.0	25.00 - 20.00	20.00	17.90 - 17.80



A242



HSS-E lange centerboor, 118° tophoek en 60° centreerhoek

Lange centerboor voor het maken van een nauwkeurig gat in het uiteinde van een as, zodat deze vervolgens stabiel kan worden opgespannen om bewerkt te worden. Dubbelzijdig uitgevoerd met een aanschuifhoek van 60°. Plat vlak aan de schacht voor betere klemming in de houder. Geschikt voor veel verschillende materialen.

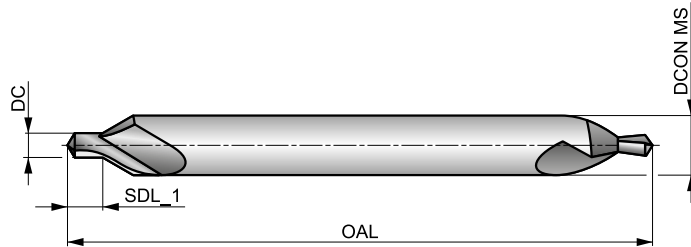

HSS-E		1xD
60°	Bright	
R	118°	

De tabel geeft de geschiktheid aan voor de materiaalgroep en de startwaarden voor de snijnsnelheid (m/min) en de letter verwijst naar de toe te passen voeding (fn), zie vanaf pagina 175.

P1.1 ■ 33 I	P1.2 ■ 37 I	P1.3 ■ 38 I	P2.1 ■ 28 I	P2.2 ■ 25 G	P2.3 ■ 22 E	P3.1 ■ 19 F	P3.2 ■ 15 F	P3.3 ■ 13 E	P4.1 ■ 11 F	P4.2 ■ 10 E	P4.3 ■ 8 D	M1.1 ■ 21 E	M1.2 ■ 17 E
M2.1 ■ 18 E	M2.2 ■ 15 E	M3.1 ■ 9 G	M3.2 ■ 8 G	M3.3 ■ 7 G	M4.1 ■ 10 C	K1.1 ■ 30 I	K1.2 ■ 22 F	K1.3 ■ 17 F	K2.1 ■ 25 E	K2.2 ■ 20 E	K2.3 ■ 16 E	K3.1 ■ 22 E	K3.2 ■ 17 E
K3.3 ■ 13 E	K4.1 ■ 20 E	K4.2 ■ 15 E	K4.3 ■ 11 E	K4.4 ■ 10 E	K4.5 ■ 8 E	K5.1 ■ 23 E	K5.2 ■ 17 E	K5.3 ■ 13 E	N1.1 ■ 33 J	N1.2 ■ 25 J	N1.3 ■ 17 I	N2.1 ■ 42 H	N2.2 ■ 37 H
N2.3 ■ 27 H	N3.1 ■ 56 H	N3.2 ■ 33 I	N3.3 ■ 17 G	N4.1 ■ 30 J	N4.2 ■ 28 H	N4.3 ■ 14 F	S1.1 ■ 24 F	S1.2 ■ 13 D	S1.3 ■ 7 B	S2.1 ■ 7 E	S2.2 ■ 6 A	S3.1 ■ 5 E	S3.2 ■ 4 A
S4.1 ■ 4 E	S4.2 ■ 3 A												

Product	DC	DC	SDL_1	OAL	DCON MS
	(mm)	(inch)	(mm)	(mm)	(mm)
A2421.0X4.0	1.00	0.0394	1.7 - 1.3	100.0	4.00
A2421.5X5.0	1.50	0.0591	2.6 - 2.0	100.0	5.00
A2422.0X6.0	2.00	0.0787	3.1 - 2.5	100.0	6.00
A2422.5X8.0	2.50	0.0984	3.8 - 3.1	100.0	8.00
A2423.0X8.0	3.00	0.1181	4.6 - 3.9	100.0	8.00
A2423.0X10.0	3.00	0.1181	4.6 - 3.9	100.0	10.00
A2424.0X10.0	4.00	0.1575	5.9 - 5.0	100.0	10.00
A2424.0X12.0	4.00	0.1575	5.9 - 5.0	100.0	12.00
A2425.0X12.0	5.00	0.1969	7.2 - 6.3	100.0	12.00



A088

DORMER



HSS extra korte boor A022, TiN-Tip gecoat, in set 24-delig

Een set bestaande uit 24 verschillende diameters van de A022 plaatwerkboor in een stevige cassette. De boren zijn geschikt voor gebruik in zowel hand als stationaire machines in vele toepassingen. TiN-Tip coating verbetert de prestaties en verlengt de standtijd.

HSS	DIN ANSI	2.5×D
135°		
20-35°		DC h8

A=type, B=aantal, C=diameters.

Product	Nr.	A	B	C
A0882005	2005	A022	24	1.0 mm - 10.5 mm x 0.5 mm + 3.3 mm, 4.2 mm, 6.8 mm, 10.2 mm

A095

DORMER



HSS spiraalboor A002, TiN-Tip gecoat, in set

Diverse sets qua samenstelling met verschillende diameters van de populaire A002 boor in een gemakkelijk mee te nemen compacte cassette, met duidelijk aangegeven maten voor een gemakkelijke selectie. De boren zijn geschikt voor gebruik in zowel hand als stationaire machines en in vele toepassingen. TiN-Tip coating verbetert de prestaties en verlengt de standtijd.

HSS	DIN 338	4×D
118°		
20-35°		DC h8

DC < 2mm blank; DC ≥ 2mm TiN-Tip gecoat en met Split Point. A=type, B=aantal in set, C=diameters in set.

Product	Nr.	A	B	C
A09518	18	A002	29	1/16 inch - 1/2 inch x 1/64 inch
A09520	20	A002	15	1/16 inch - 1/2 inch x 1/32 inch
A095200	200	A002	24	1.0 mm - 10.5 mm x 0.5 mm + 3.3 mm, 4.2 mm, 6.8 mm, 10.2 mm
A095201	201	A002	19	1.0 mm - 10.0 mm x 0.5 mm
A095202	202	A002	51	1.0 mm - 6.0 mm x 0.1 mm
A095203	203	A002	41	6.0 mm - 10.0 mm x 0.1 mm
A095204	204	A002	25	1.0 mm - 13.0 mm x 0.5 mm
A095206	206	A002	29	1.0 mm - 13.0 mm x 0.5 mm + 3.3 mm, 4.2 mm, 6.8 mm, 10.2 mm
A095209	209	A002	91	1.0 mm - 10.0 mm x 0.1 mm



A087

DORMER



HSS spiraalboor A002, TiN-Tip gecoat in set, 19-delig

Een set met 19 verschillende diameters van de populaire A002 boor in een gemakkelijk mee te nemen compacte cassette, met duidelijk aangegeven maten voor een gemakkelijke selectie. De boren zijn geschikt voor gebruik in zowel hand als stationaire machines en in vele toepassingen. TiN-Tip coating verbetert de prestaties en verlengt de standtijd.

HSS	DIN 338	4×D
118°	TiN-Tip	
λ20-35°	R	DC h8

A=type, B=aantal, C=diameters 1.0mm =< DC >= 2.9mm 118° 4-vlaks punt.

Product	Nr.	A	B	C
A087201	201	A002	19	1.0 mm - 10.0 mm x 0.5 mm

A094

DORMER



HSS spiraalboor A002, TiN-Tip gecoat, in set

Een set (13 of 19-delig) met verschillende diameters van de populaire A002 boor in een gemakkelijk mee te nemen compacte cassette, met duidelijk aangegeven maten voor een gemakkelijke selectie. De boren zijn geschikt voor gebruik in zowel hand als stationaire machines en in vele toepassingen. TiN-Tip coating verbetert de prestaties en verlengt de standtijd.

HSS	DIN 338	4×D
118°	TiN-Tip	
λ20-35°	R	DC h8

A=type, B=aantal, C=diameters 1.0mm =< DC >= 2.9mm 118° 4-vlaks punt.

Product	Nr.	A	B	C
A094413	413	A002	13	1.5 mm - 6.5 mm x 0.5 mm + 3.3 mm, 4.2 mm
A094419	419	A002	19	1.0 mm - 10.0 mm x 0.5 mm



A089



HSS spiraalboor A002, TiN-Tip gecoat, in set 5-delig

Een set met 19 verschillende diameters van de populaire A002 boor in een gemakkelijk mee te nemen compacte cassette, met duidelijk aangegeven maten voor een gemakkelijke selectie. De boren zijn geschikt voor gebruik in zowel hand als stationaire machines en in vele toepassingen. TiN-Tip coating verbetert de prestaties en verlengt de standtijd.

HSS	DIN 338	4xD
118°	TiN-Tip	
20-35°	R	DC h8

A=type, B=aantal, C=diameters.

Product	Nr.	A	B	C
A08910	10	A002	5	A0024.0, A0025.0, A0026.0, A0028.0, A00210.0



A099

DORMER



Toonbankdisplay met HSS-boren A002, TiN-Tip gecoat

Een vrijstaande toonbankdispenser met een groot aantal maten A002 boren. Ontworpen om op een toonbank of ander geschikt vlak oppervlak te worden geplaatst, zodat de boren goed zichtbaar zijn en gemakkelijk kunnen worden uitgenomen wanneer ze nodig zijn. Gemakkelijk bij te vullen met andere A002 boren, voor jarenlang gebruik.

HSS	DIN 338	4xD
118°	TiN-Tip	
λ 20-35°	R	DC h8

DC < 2mm blank; DC >= 2mm TiN-Tip gecoat en met Split Point. A=type, B=aantal in set, C=diameters in set.

Product	Nr.	A	B	C
A099F1	F1	A002	380	5 x (13/32, 7/16, 15/32, 1/2) inch; 10 x (5/64, 7/64, 9/64, 11/64, 13/64, 15/64, 17/64, 9/32, 19/64, 5/16, 21/64, 11/32, 23/64, 3/8) inch; 20 x (1/16, 7/32, 1/4) inch; 30 x 3/32 inch; 40 x (5/32, 3/16) inch; 50 x 1/8 inch
A099M1	M1	A002	340	5 x (10.50, 11.00, 11.50, 12.00, 12.50, 13.00) mm; 10 x (1.50, 2.50, 3.50, 4.50, 5.50, 6.50, 7.00, 7.50, 8.00, 8.50, 9.00, 9.50, 10.00) mm; 20 x (1.00, 5.00, 6.00) mm; 30 x 2.00 mm; 40 x 4.00 mm; 50 x 3.00 mm

A099

DORMER



Werkbankdispenser met HSS boren A002, TiN-Tip gecoat

Een vrijstaande werkbankdispenser met een groot aantal maten A002 boren. Voorzien van unieke meetgroef waardoor de boren makkelijk terug te plaatsen zijn in het daarvoor bestemde gat. Ideaal voor de machine- bankwerker die altijd de juiste maat boor onder handbereik wil hebben.

HSS	DIN 338	4xD
118°	TiN-Tip	
λ 20-35°	R	DC h8

DC < 2mm blank; DC >= 2mm TiN-Tip gecoat en met Split Point. A=type, B=aantal in set, C=diameters in set.

Product	Nr.	A	B	C
A099DRILLBOY	DRILLBOY	A002	43	3 x (3.0 mm, 3.3 mm, 3.5 mm, 4.0 mm) + 2 x (4.2 mm, 4.5 mm, 5.0 mm, 5.5 mm, 6.0 mm, 6.5 mm, 6.8 mm, 7.0 mm, 7.5 mm, 8.0 mm) + 8.5 mm, 9.0 mm, 9.5 mm, 10.0 mm, 10.2 mm, 10.5 mm, 11.0 mm, 11.5 mm, 12.0 mm, 12.5 mm, 13.0 mm



A199

DORMER



Toonbankdisplay met HSS-boren A002, TiN-Tip gecoat

Een vrijstaande toonbankdispenser met een groot aantal maten A100 boren. Ontworpen om op een toonbank of ander geschikt vlak oppervlak te plaatsen voor een opvallende uitstalling en waar de boren gemakkelijk kunnen worden uitgenomen wanneer nodig. Gemakkelijk bij te vullen met andere A100 boren, voor jarenlang gebruik.

HSS	DIN 338	4xD
118°	ST	
20-35°		DC h8

A=type, B=aantal, C=diameters.

Product	Nr.	A	B	C
A199F1	F1	A100	380	5 x (13/32, 7/16, 15/32, 1/2) inch; 10 x (5/64, 7/64, 9/64, 11/64, 13/64, 15/64, 17/64, 9/32, 19/64, 5/16, 21/64, 11/32, 23/64, 3/8) inch; 20 x (1/16, 7/32, 1/4) inch; 30 x 3/32 inch; 40 x (5/32, 3/16) inch; 50 x 1/8 inch
A199M1	M1	A100	340	5 x (10.50, 11.00, 11.50, 12.00, 12.50, 13.00) mm; 10 x (1.50, 2.50, 3.50, 4.50, 5.50, 6.50, 7.00, 7.50, 8.00, 8.50, 9.00, 9.50, 10.00) mm; 20 x (1.00, 5.00, 6.00) mm; 30 x 2.00 mm; 40 x 4.00 mm; 50 x 3.00mm

A080

DORMER



Lege dispenser

De dispenser wordt leeg geleverd, zodat de boren afzonderlijk kunnen worden gekocht, in hoeveelheden die passen bij de toonbankverkoop. De dispenser wordt geleverd in rood plastic, gemarkeerd met een Dormer-logo en een afbeelding van verschillende Dormer-boren. Metrische of fractionele boordiameters zijn aangegeven op de drie schappen.

Lege display.

Product	Nr.	C
A080M1EMPTY	M1EMPTY	(1.00, 1.50, 2.00, 2.50, 3.00, 3.50, 4.00, 4.50, 5.00, 5.50, 6.00, 6.50, 7.00, 7.50, 8.00, 8.50, 9.00, 9.50, 10.00, 10.50, 11.00, 11.50, 12.00) mm
A080F1EMPTY	F1EMPTY	(1/16, 5/64, 3/32, 7/64, 1/8, 9/64, 5/32, 11/64, 3/16, 13/64, 7/32, 15/64, 1/4, 17/64, 9/32, 19/64, 5/16, 21/64, 11/32, 3/8, 13/32, 7/16, 1/2) inch



A190

DORMER



HSS spiraalboor, A100, stoomontlaten, in set

Een set met A100 boren van verschillende metrische diameters in een slim ontworpen roterende dispenser die het selecteren van de gewenste maat zeer eenvoudig maakt. In verschillende diameter samenstellingen.

HSS	DIN 338	4xD
118°		
λ 20-35°		DC h8

A=type, B=aantal, C=diameters DC <= 1mm; 3/64"; N60 blank.

Product	Nr.	A	B	C
A1903	3	A100	21	1/16 inch - 3/8 inch x 1/64 inch
A19012	12	A100	60	No.1 - No.60
A19018	18	A100	29	1/16 inch - 1/2 inch x 1/64 inch
A19020	20	A100	15	1/16 inch - 1/2 inch x 1/32 inch
A190201	201	A100	19	1.0 mm - 10.0 mm x 0.5 mm
A190202	202	A100	51	1.0 mm - 6.0 mm x 0.1 mm
A190203	203	A100	41	6.0 mm - 10.0 mm x 0.1 mm
A190204	204	A100	25	1.0 mm - 13.0 mm x 0.5 mm
A190206	206	A100	29	1.0 mm - 13.0 mm x 0.5 mm + 3.3 mm, 4.2 mm, 6.8 mm, 10.2 mm
A190209 ¹⁾	209	A100	91	1.0 mm - 10.0 mm x 0.1 mm

¹⁾ Bestaat uit 2 borensets: set 1 (1.0-5.9 x 0.1mm); set 2 (6.0-10.0 x 0.1mm).



A191

DORMER

HSS spiraalboor A100, stoomontlaten, in set

Een set met A100 boren van verschillende diameters in een gemakkelijk mee te nemen compacte koffer met duidelijk weergegeven maten en gemakkelijke boorkeuze. A100 boren met conventionele 118° tophoek in een handige plastic koffer waarbij het selecteren van de gewenste boormaat zeer eenvoudig is.



HSS	DIN 338	4xD
118°		
20-35°		DC h8

A=type, B=aantal, C=diameters DC <= 1mm; 3/64"; N60 blank.

Product	Nr.	A	B	C
A19131M	31M	A100	20	0.3 mm - 1.0 mm x 0.05 mm + 0.38 mm, 0.52 mm, 0.58 mm, 0.78 mm, 0.82 mm
A19161-80	61-80	A100	20	No.61 - No. 80

A191

DORMER

HSS spiraalboor A100, stoomontlaten, in set

Een set met A100 boren van verschillende metrische diameters in een slim ontworpen roterende dispenser die het selecteren van de gewenste maat zeer eenvoudig maakt. Draai de doorzichtige bovenkant, totdat de gewenste maat wordt gemarkeerd door het gat in de houder, en draai de set ondersteboven om de boor uit te nemen.



HSS	DIN 338	4xD
118°		
20-35°		DC h8

A=type, B=aantal, C=diameters DC <= 1mm; 3/64"; N60 blank.

Product	Nr.	A	B	C
A191413	413	A100	13	1.5 mm - 6.5 mm x 0.5 mm + 3.3 mm, 4.2 mm
A191419	419	A100	19	1.0 mm - 10.0 mm x 0.5 mm



A188

DORMER



HSS spiraalboor voor RVS, A108, stoomontlaten, in set

Een set van verschillende fractionele maten van de A108 boren die speciaal geschikt zijn voor het boren in roestvast staal en dan met name in de handboormachine. Maar ook geschikt voor de conventionele stationaire machines. In een handige kunststof cassette.

HSS	DIN 338	4xD
135°	ST	
$\lambda > 35^\circ$	R	DC h8

A=type, B=aantal, C=diameters DC > 1.5mm; 1/16" met Split Point.

Product	Nr.	A	B	C
A188201	201	A108	19	1.0 mm - 10.0 mm x 0.5 mm
A188204	204	A108	25	1.0 mm - 13.0 mm x 0.5 mm

A295

DORMER



HSS-E (8% Co) spiraalboor, A777, bronskleurig, in set

Een set in 19 of 25-delige uitvoering van de A777 boren in een handige kunststof cassette. De A777 boren zijn ontworpen met een 135° split point ter bevordering van het zelfcentrerend boren en de snijkrachten te verminderen.

HSS-E	DIN 338	4xD
135°	Bronze	
$\lambda 20-35^\circ$	R	DC h8

A=type, B=aantal, C=diameters DC <= 1.4mm viervlaks punt.

Product	Nr.	A	B	C
A295219	219	A777	19	1.0 mm - 10.0 mm x 0.5 mm
A295225	225	A777	25	1.0 mm - 13.0 mm x 0.5 mm



A296

DORMER

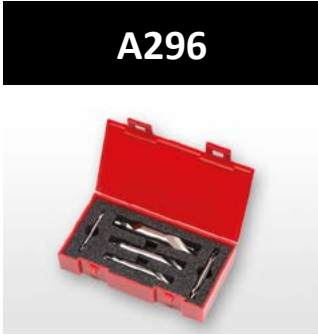

HSS centerboor DIN333A, in set

Een set van vijf centerboren in een handige kunststof cassette. Voor het maken van een nauwkeurig gat in het uiteinde van een as, zodat deze vervolgens stabiel kan worden opgespannen om bewerkt te worden. Dubbelzijdig uitgevoerd met een aanschuinhoek van 118° (A200) of 120° (A225).

A296200 - 118° punt DIN333A, A296225 - 120° punt BS328. A=type, B=aantal, C=diameters.

Product	Nr.	A	B	C
A296200	200	A200	5	1.00 mm, 2.00 mm, 2.50 mm, 3.15 mm, 4.00 mm
A296225	225	A225	5	BS1, BS2, BS3, BS4, BS5

M150

DORMER



MC verloophuls, oliegehard

Adapter om boren met een kleinere morseconus op te nemen in machinespindels met een grotere morseconus.

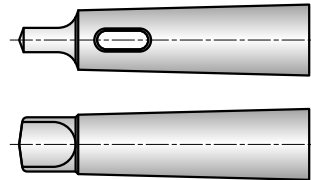

K= externe morseconus; K1=interne morseconus.

Product	Nr.	K = Nr.	K1 = Nr.
M1501-0	10	Nr. 1	Nr. 0
M1502-1	21	Nr. 2	Nr. 1
M1503-1	31	Nr. 3	Nr. 1
M1504-1	41	Nr. 4	Nr. 1
M1503-2	32	Nr. 3	Nr. 2
M1504-2	42	Nr. 4	Nr. 2
M1505-2	52	Nr. 5	Nr. 2
M1504-3	43	Nr. 4	Nr. 3
M1505-3	53	Nr. 5	Nr. 3
M1505-4	54	Nr. 5	Nr. 4
M1506-5	65	Nr. 6	Nr. 5



M151

DORMER



MC verloophuls, gehard en geslepen

Adapter om boren met een kleinere morseconus op te nemen in machinespindels met een grotere morseconus.

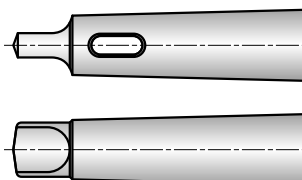

K= externe morseconus; K1=interne morseconus.

Product	Nr.	K = Nr.	K1 = Nr.
M1511-0	10	Nr. 1	Nr. 0
M1512-1	21	Nr. 2	Nr. 1
M1513-1	31	Nr. 3	Nr. 1
M1514-1	41	Nr. 4	Nr. 1
M1513-2	32	Nr. 3	Nr. 2
M1514-2	42	Nr. 4	Nr. 2
M1515-2	52	Nr. 5	Nr. 2
M1514-3	43	Nr. 4	Nr. 3
M1515-3	53	Nr. 5	Nr. 3
M1515-4	54	Nr. 5	Nr. 4
M1516-5	65	Nr. 6	Nr. 5

M152

DORMER



Uitdrijfspie

Voor het uitdrijven van gereedschappen met een morseconus schacht uit machinespindels en verloophulzen.



Product	Nr.
M1520	Nr. 0
M15212	Nr. 1 + 2
M15234	Nr. 3 + 4
M15245	Nr. 4 + 5
M1526	Nr. 6



DRILLING FEED RATE CHART

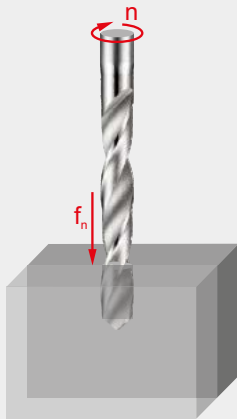

Voeding per omwenteling (f_n in mm/omw)
Afhankelijk van de werkomstandigheden
kan het nodig zijn om deze
aan te passen met $\pm 25\%$.

Hoe gebruik je deze tabel om de voeding per omwenteling (f_n) te bepalen:

1. Zoek uw Alpha Code op de productpagina (voorbeeld: 46J,,J" is de Alpha Code).
2. Zoek de dichtstbijzijnde diameter voor uw boorbewerking in de bovenste rij van de tabel.
3. Zoek uw Alpha Code in de linker kolom van de tabel.
4. Het snijpunt (cel) van de diameter en Alpha Code is de voeding per omwenteling (f_n).

		ø DC (mm)																		
		0.15	0.50	1.00	2.00	3.00	4.00	5.00	6.00	8.00	10.00	12.00	15.00	16.00	20.00	25.00	30.00	40.00	50.00	100.00
Voedingssnelheden	A	0.003	0.006	0.012	0.023	0.029	0.032	0.036	0.042	0.054	0.062	0.069	0.082	0.086	0.110	0.125	0.135	0.155	0.175	0.263
	B	0.004	0.007	0.014	0.028	0.037	0.041	0.046	0.053	0.067	0.080	0.090	0.103	0.108	0.135	0.153	0.165	0.188	0.208	0.312
	C	0.004	0.008	0.015	0.032	0.044	0.050	0.056	0.064	0.080	0.098	0.110	0.125	0.130	0.160	0.180	0.195	0.220	0.240	0.360
	D	0.004	0.008	0.016	0.038	0.053	0.060	0.068	0.078	0.098	0.119	0.130	0.149	0.155	0.188	0.210	0.228	0.253	0.275	0.413
	E	0.004	0.009	0.017	0.043	0.062	0.071	0.080	0.092	0.115	0.140	0.150	0.173	0.180	0.215	0.240	0.260	0.285	0.310	0.465
	F	0.005	0.009	0.018	0.050	0.073	0.084	0.095	0.109	0.138	0.165	0.178	0.202	0.210	0.248	0.275	0.295	0.320	0.343	0.515
	G	0.005	0.010	0.019	0.056	0.084	0.096	0.109	0.126	0.160	0.190	0.205	0.231	0.240	0.280	0.310	0.330	0.355	0.375	0.563
	H	0.005	0.010	0.020	0.066	0.102	0.116	0.130	0.150	0.190	0.228	0.243	0.271	0.280	0.320	0.355	0.375	0.398	0.418	0.627
	I	0.005	0.011	0.021	0.076	0.119	0.134	0.150	0.173	0.220	0.265	0.280	0.310	0.320	0.360	0.400	0.420	0.440	0.460	0.690
	J	0.006	0.012	0.024	0.084	0.135	0.152	0.170	0.197	0.250	0.298	0.315	0.349	0.360	0.405	0.445	0.465	0.485	0.503	0.755
	K	0.007	0.013	0.026	0.092	0.150	0.170	0.190	0.220	0.280	0.330	0.350	0.388	0.400	0.450	0.490	0.510	0.530	0.545	0.818
	L	0.007	0.014	0.028	0.101	0.165	0.186	0.208	0.240	0.305	0.360	0.385	0.419	0.430	0.485	0.525	0.545	0.568	0.588	0.882
	M	0.008	0.015	0.030	0.110	0.180	0.202	0.225	0.260	0.330	0.390	0.420	0.450	0.460	0.520	0.560	0.580	0.605	0.630	0.945
	N	0.008	0.016	0.032	0.119	0.195	0.218	0.242	0.280	0.355	0.420	0.455	0.481	0.490	0.555	0.595	0.615	0.642	0.672	1.008
	S	0.002	0.004	0.008	0.014	0.020	0.025	0.030	0.037	0.050	0.080	0.100	0.123	0.130	0.150	0.170	0.190	0.220	0.240	–
	T	0.004	0.008	0.015	0.028	0.040	0.050	0.060	0.070	0.090	0.110	0.130	0.160	0.170	0.190	0.210	0.230	0.260	0.275	–
	U	0.007	0.013	0.026	0.048	0.070	0.080	0.090	0.107	0.140	0.170	0.200	0.223	0.230	0.240	0.270	0.300	0.360	0.375	–
	V	0.010	0.019	0.038	0.069	0.100	0.115	0.130	0.153	0.200	0.250	0.280	0.310	0.320	0.340	0.400	0.440	0.510	0.530	–
	W	0.012	0.025	0.049	0.089	0.130	0.150	0.170	0.200	0.260	0.330	0.380	0.418	0.430	0.450	0.470	0.490	0.520	0.540	–
	X	0.014	0.028	0.056	0.103	0.150	0.180	0.210	0.250	0.330	0.420	0.480	0.533	0.550	0.580	–	–	–	–	–
Y	0.017	0.034	0.068	0.124	0.180	0.220	0.260	0.317	0.430	0.550	0.700	0.700	0.700	0.740	–	–	–	–	–	
Z	0.024	0.047	0.094	0.172	0.250	0.325	0.400	0.533	0.800	1.000	1.100	1.175	1.200	1.200	–	–	–	–	–	



BOREN
TECHNISCHE INFORMATIE



VHM & HSS BOREN - TECHNISCHE INFORMATIE

Benamingen bij boren

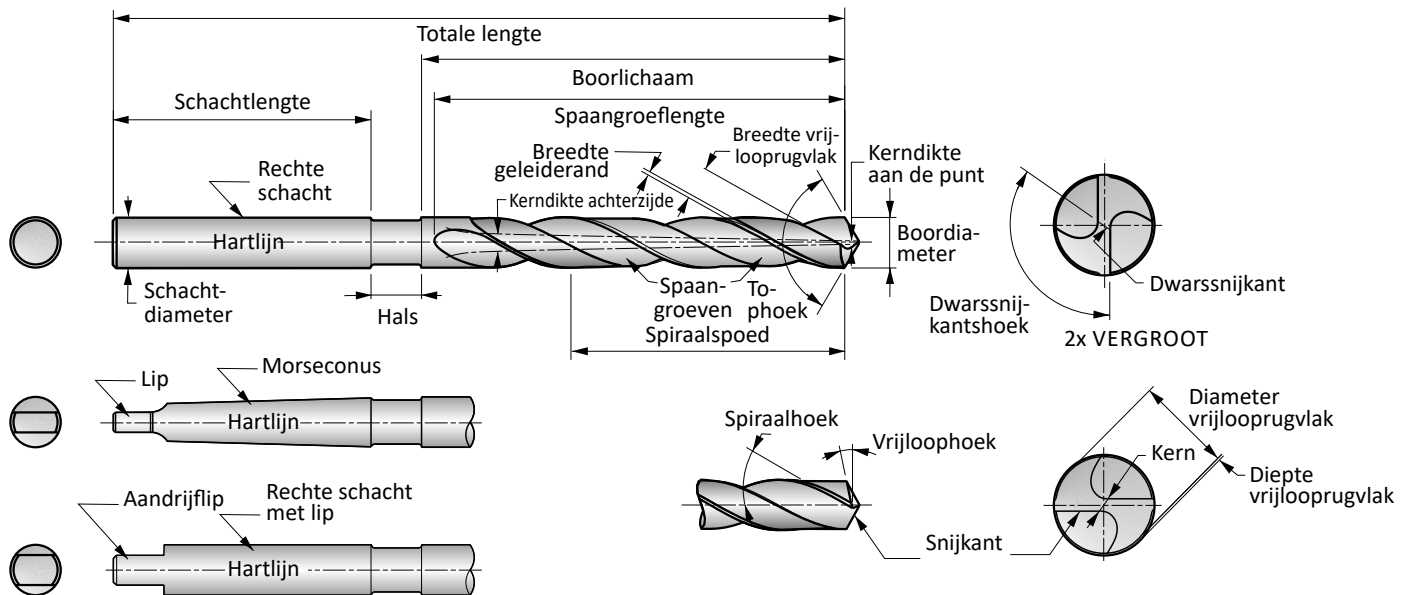

- **Hartlijn** - denkbeeldige rechte lijn in de lengterichting van een boor
- **Achterslijping** - een geringe afname in diameter van voor naar achter
- **Boorlichaam** - Het gedeelte van een boor dat zich uitstrekt van de schacht of hals tot de buitenste hoeken van de snijkanten.
- **Diepte vrijlooprugvlak** - De diepte van het vrijlooprugvlak vanaf de geleiderand dat is weggeslepen zodat het niet tegen de wanden van het gat aankomt.
- **Dwarssnijkant** - (ziel) de overgang die de snijkanten in het hart verbindt.
- **Dwarssnijkantshoek** - de hoek tussen de dwarssnijkant en de snijkanten, gezien op de kopse kant.
- **Diameter vrijlooprugvlak** - De diameter gemeten op de vrijlooprugvlakken van de boor.
- **Dwarssnijkant** - of ziel, is de verbinding tussen de snijkanten over de kern van de boor. De ziel van de boor is het niet snijdende deel van de punt wat zich in het materiaal drukt.
- **Boordiameter** - Diameter van de boor gemeten aan de punt op de geleidingsranden.
- **Paangroeflengte** - De lengte van de buitenste hoeken van de lippen tot de uiterste achterkant van de groeven. Inclusief de uitloop van de slijpsteek of profielfrees die de groeven aanbrengt. Het is derhalve niet gelijk aan de bruikbare lengte van de boor.
- **Spaangroef** - Spiraalvormige of rechte groeven geslepen of gevormd in het lichaam van een boor om snijkanten te maken, spanen af te voeren en snijvloeistof naar de snijkanten te voeren.
- **Spiraalhoek** - De hoek waaronder de spaangroef is aangebracht t.o.v de hartlijn.
- **Vrijlooprugvlak** - Het deel tussen de spaangroeven.
- **Breedte vrijlooprugvlak** - De afstand tussen de hiel en de geleiderand.
- **Spiraalspoed** - de axiale vooruitgang van een snijkant in één omwenteling van de omtrek.
- **Vrijloophoek van de snijkant** - De axiale vrijloophoek bij de neushoek van de lip.
- **Snijkanten** - de scherpe kanten van een boor met twee spiralen die zich uitstrekken van de dwarssnijkant tot de neus.
- **Geleiderand** - het cilindrische gedeelte van het rugvlak, dat niet is weggeslepen, om ruimte te maken.
- **Hals** - Het in diameter gereduceerde gedeelte tussen het boorlichaam en de schacht.
- **Totale lengte** - De lengte van het uiteinde van de schacht tot de buitenste hoeken van de snijkant. Dit is zonder de afschuining aan het schachteinde dat vaak gebruikt wordt bij boren met cilindrische schacht, noch de conische punt van een boor.
- **Punt** - Het snijdende uiteinde van een boor, bestaande uit de uiteinden van de snijkanten de kern. Qua vorm lijkt hij op een kegel, maar hij wijkt af van een echte kegel om vrijloop te creëren achter de snijkanten.
- **Conventioneel** - Meest voorkomende boorpunten hebben een hoek van 118° en worden het meest gebruikt omdat zij bevredigende resultaten opleveren in een grote verscheidenheid van materialen. Een mogelijke beperking is dat de rechte ziel bijdraagt tot verlopen van de punt, waardoor het vaak nodig is het gat te centreren voor een betere nauwkeurigheid.

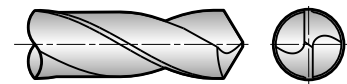

- **Split-Point** - Viervlaks aanslijpingen werden oorspronkelijk ontwikkeld voor gebruik op boren ontworpen voor diepe oliegaten in krukassen van auto's. Sinds zijn ontstaan is de split-point wijdverspreid toegepast op zowel 118° en 135° top-hoeken. De belangrijkste voordelen zijn de mogelijkheid om boordruk te verminderen en verlopen bij de boorpunt te elimineren. Dit is vooral een voordeel wanneer de boor wordt gebruikt in een handboormachine of in boortoepassingen waar boorbussen niet kunnen worden gebruikt. De split-point heeft ook twee positieve schuine snijkanten die zich uitstrekken tot het midden van de boor, die kunnen helpen als spaanbreker om kleine spanen te produceren die gemakkelijk kunnen worden afgevoerd.

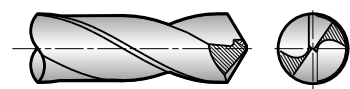

- **Zieluitdunning** - Werden ontwikkeld voor het boren van taaie legeringen. Ze worden vaak gebruikt voor boren met een dikke kern waardoor de punt hogere boordruk nodig zou hebben om in het materiaal te dringen. Door deze verkorting van de dwarsnijkant ontstaan twee extra snijkanten die helpen de staan te vormen en af te voeren. tevens wordt de torsie verminderd in taaie materialen. Zieluitdunning wordt toegepast op boorpunten met een tophoek van 118° en 135° waardoor ze geschikt zijn voor het boren van een grote verscheidenheid aan materialen.

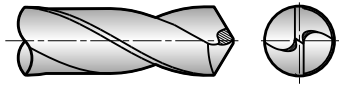

- **Tophoek** - De inbegrepen hoek tussen de snijkanten geprojecteerd op een vlak evenwijdig met de hartlijn en evenwijdig met de twee snijkanten.

Algemene tips voor het boren

1. Kies de meest geschikte boor voor de toepassing, rekening houdend met het te bewerken materiaal, de mogelijkheden van de machine werktuig en al of niet te gebruiken koeling.
2. Instabiliteit van het werkstuk en de spindel van de machine kan schade veroorzaken aan de boor, het werkstuk en de machine - zorg te allen tijde voor maximale stabiliteit. Dit kan worden verbeterd door de kortst mogelijke boor voor de toepassing te kiezen.
3. Het opspannen van het gereedschap is een belangrijk aspect van de boorbewerking en de boor mag niet slippen of bewegen in de gereedschapshouder.
4. Het juiste gebruik van morseconusboren berust op een zuivere passing tussen de conische oppervlakken van het gereedschap en de gereedschapshouder. Indien nodig gebruik alleen een hamer met

- **Relatieve snijkantshoogte** - Het verschil in uitslag van een meetklok tussen de snijkanten van een boor. Gemeten in een rechte hoek ten opzichte van de snijkant op een bepaalde afstand van de as van het gereedschap.
- **Schacht** - Het deel van een boor waarmee deze wordt vastgehouden en aangedreven.
- **Uitdrijflijp** - Het afgeplatte uiteinde van een conische schacht, bedoeld om de boor uit te drijven uit een conus of spindel.
- **Meeneemlijp** - Twee tegenover elkaar liggende parallelle aandrijfvlakken op het uiteinde van een rechte schacht.
- **Morseconusboren** - boren met conische schacht, geschikt voormontage in machinespindels, hulzen of opnames. Conischeschachten hebben over het algemeen een uitdrijflijp.
- **Kern** - Het centrale gedeelte van het boorlichaam. Gevormd bij het aanbrengen van de spaangroeven.
- **Kerndikte** - De dikte van het kern bij de punt, tenzij een andere specifieke plaats is aangegeven.

- een zachte kop om de boor in de spindel of houder te tikken.
5. Het gebruik de juiste koel- en smeermiddelen wordt aanbevolen voor de specifieke boorbewerking. Gebruik deze in voldoende hoeveelheid en zorg voor een overvloedige toevoer, vooral bij de boorpunt.
6. Het afvoeren van spanen tijdens het boren is van essentieel belang voor een correcte boorproces. Voorkom ophoping van spanen in de spaangroef.
7. Wanneer u een boor naslijpt, moet u er altijd voor zorgen dat de juiste puntgeometrie wordt geproduceerd en dat eventuele slijtage is verwijderd.



VHM & HSS BOREN - TECHNISCHE INFORMATIE

Beweringsstrategie voor diepgatboren

Voor het boren van diepe gaten kunnen verschillende methodes toegepast worden om de gewenste diepte te bereiken. Onderstaand voorbeeld geeft vier manieren om een gat van 10xD te boren.

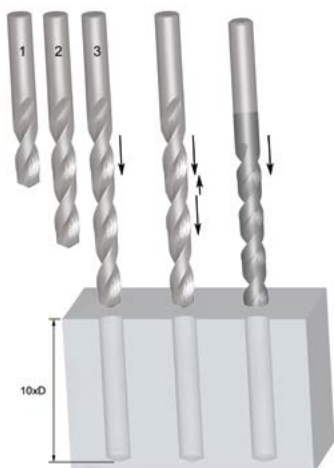

Meerdere boren		Meerdere boren
Aantal gebruikte boren	3 (2,5xD, 6xD, 10xD)	2 (2,5xD, 10xD)
Type boor	Standaard geometrie, algemeen gebruik	Standaard geometrie, algemeen gebruik
+ / -	Duur, tijdrovend	Goedkoper, snel

Lossend boren		Boren zonder te lossen
Aantal gebruikte boren	1 (10xD)	1 (10xD)
Type boor	Standaard geometrie, algemeen gebruik	Toepassingsgerichte boren
+ / -	Tijdrovend	Goedkoopst, snelst

Problemen en oplossingen bij boren

PROBLEEM	OORZAAK	OPLOSSING
Gebroken of gedraaide lip	Slecht contact tussen de morseconus en de spindel	Spindel en/of verloophuizen, opnames reinigen en beschadigingen verhelpen
Gespleten over de ziel van de boor	Te hoge voeding	Reduceer de voeding naar de juiste waarde
	Onvoldoende vrijloop	Herslijp volgens specificatie
	Ziel te veel uitgedund	Herslijp volgens specificatie
	Punt van de boor hard gestoten	Voorkom het stoten van de boorpunt. Let op met het plaatsen en verwijderen van morseconus boren
Versleten hoeken van de snijkant (de neus)	Te hoge snijsnelheid	Reduceer de snijsnelheid naar de juiste waarde – misschien kan de voeding verhoogd worden
Uitbreken van de hoeken van de snijkant	Onstabiliteit van het werkstuk	Verbeter de stabiliteit van het werkstuk
Afbrakken van de snijkant	Te grote vrijloop	Herslijp volgens specificatie
Breuk bij de uitloop van de spaangroef	Het vollopen van de spaangroef met spanen	Tijdig lossen of een diepgat boor toepassen
	De boor slijpt in de houder	Voorkom dat de boor kan slippen in de houder of spindel
Spiraelvormige vertekening in de wand van het gat	Onvoldoende voeding	Verhoog de voeding
	Slechte centreer werking van de boor	Gebruik een centreerboor om aan te centreren
Overmaat van het geboorde gat	Geen juiste puntgeometrie	Controleer of de boor juist herslepen is
	Onvoldoende spaanafvoer	Pas de snelheid, voeding of de diepte tussen het lossen aan om de spanen beter af te voeren



VHM & HSS BOREN - TECHNISCHE INFORMATIE

Gatgrootte / haalbare gattoleranties

Naarmate geometrie, basismateriaal en coatingen geavanceerder worden, zal het vermogen van een boor om een nauwkeurigere gatmaat te produceren toenemen. In het algemeen zal een boor met

standaard geometrie een maatvoering tot H12 bereiken. Maar als de configuratie van de boor geavanceerder wordt, kan de haalbare nauwkeurigheid, onder gunstige omstandigheden H8 zijn.

Om een beter inzicht te geven, staan hieronder de producttypes en hun haalbare gattoleranties vermeld:

HSS boren voor algemeen gebruik - H12

HSS / HSCo parabolische spiraalboren voor diepe gaten (PFX) - H10

HSS / HSCo hoge prestatie TiN/ TiALN gecoat (ADX) - H10

Volhardmetaal hoge prestatie TiN/ TiALN gecoat (CDX, Force) - H8/H9

Nominale gatdiameter (mm)

Ø (mm)	H8	H9	H10	H12
≤ 3	0 / +0.014	0 / +0.025	0 / +0.040	0 / +0.100
> 3 ≤ 6	0 / +0.018	0 / +0.030	0 / +0.048	0 / +0.120
> 6 ≤ 10	0 / +0.022	0 / +0.036	0 / +0.058	0 / +0.150
> 10 ≤ 18	0 / +0.027	0 / +0.043	0 / +0.070	0 / +0.180
> 18 ≤ 30	0 / +0.033	0 / +0.052	0 / +0.084	0 / +0.210

Nominale gatdiameter (inches)

Ø (inch)	H8	H9	H10	H12
≤ .1181	0 / +0.0006"	0 / +0.0010"	0 / +0.0016"	0 / +0.0040"
>.1181≤.2362	0 / +0.0007"	0 / +0.0012"	0 / +0.0019"	0 / +0.0048"
>.2362≤.3937	0 / +0.0009"	0 / +0.0015"	0 / +0.0023"	0 / +0.0059"
>.3937≤.7087	0 / +0.0011"	0 / +0.0017"	0 / +0.0028"	0 / +0.0071"
>.7087≤1.1811	0 / +0.0013"	0 / +0.0021"	0 / +0.0033"	0 / +0.0083"

Gezien de mogelijkheid van sommige boren om een nauwkeuriger gat te produceren, moet de nodige aandacht worden besteed aan geboorde gaten die secundaire bewerkingen ondergaan, b.v. tappen

en ruimen. De diameter van de boor zal groter gekozen moeten worden ten opzichte van wat wordt aanbevolen om rekening te houden met het feit dat de geproduceerde gatgrootte kleiner zal zijn.

Optimaliseren van het boorproces / Probleemoplossing

Boorkeuze

Gebruik de kortste boor die de toepassing toelaat voor een maximale stijfheid van het gereedschap.

Houders

Gereedschapshouders en spantangen moeten een goede concentriciteit tussen de boor en de spindel van de machine hebben. Gebruik een axiale aanslag om te voorkomen het gereedschap in de houder gedrukt wordt. Klem het gereedschap nooit op de spiraal en span de houder nooit te strak aan. De rondlooptrouwbaarheid van het gereedschap moet nauwkeurig worden gecontroleerd en gehandhaafd.

Werkstuk

Een stevig en stijf werkstuk is nodig om doorbuiging te minimaliseren, vooral bij toepassingen met doorlopende gaten.

Koelmiddelen

Koelmiddelen worden aanbevolen bij het boren van zacht staal en hittebestendige legeringen. Het doel van de koelvloeistof is om de spanen weg te leiden van het snijgereedschap en het werkstuk. Een te hoge druk van de koelvloeistof en/of te veel volume kan de prestaties negatief beïnvloeden.

Bij gebruik van koelkanaalboren, moet de koelmiddeldruk hoger zijn dan normaal. De aanbevolen druk is minimaal 10,3 bar of 150 PSI. Naarmate de diameter van de boor kleiner wordt, is de benodigde druk hoger. Dit is om de spaan te helpen bij het evacueren door de nauwere spaangroeven.



VHM & HSS BOREN - TECHNISCHE INFORMATIE

Probleemoplossingen bij boren

Probleem	Oplossing
Slijtage op de neushoeken	Verlaag de snijnsnelheid
	Verhoog de voeding (IPR)
	Richt de koelvloeistofstraal beter
	Verhoog de koeldruk
	Slijp een neushoekfase aan de boor
Uitbrokkelen van de dwarssnijkant	Controleer de rondloopnauwkeurigheid
	Controleer de werkstukopspanning
	Controleer of de ziel wel zuiver in het midden zit en de snijkantshoogte gelijk is
	Verlaag de voeding
Uitbrokkelen van de snijkanten	Controleer de rondloopnauwkeurigheid
	Controleer de werkstukopspanning
	Verlaag de snijnsnelheid
	Verklein de vrijloophoek
	Lep de snijkanten
Scheuren van de geleiderand	Controleer de werkstukopspanning
	Achterslijping dient vergroot te worden
	Controleer de rondloopnauwkeurigheid
	Zorg voor betere spaanafvoer, kies boor met meer spaangroefruimte (alleen bij HSS/HSS-E)
	Kies bij horizontaal boren voor een flauwere spiraal
	Verhoog de voeding
	Verlaag de voeding bij een startgatboring
	Richt de koelvloeistofstraal beter
Verhoog de koelvloeistofdruk	
Overmaatse gatdiameter	Verhoog snijnsnelheid of verlaag voeding
	Controleer de werkstukopspanning
	Controleer de rondloopnauwkeurigheid
	Zorg voor betere spaanafvoer, kies boor met meer spaanruimte (alleen bij HSS/HSS-E)
	Controleer de boordiameter
Ondermaatse gatdiameter	Richt de koelvloeistofstraal beter
	Verlaag de snijnsnelheid of verhoog de voeding
	Controleer de boordiameter
On rondheid van het gat	Controleer de slingering van de boor
	Controleer de werkstukopspanning
	Controleer of de ziel wel zuiver in het midden zit en de snijkantshoogte gelijk is
	Zorg voor betere spaanafvoer, kies boor met meer spaanruimte (alleen bij HSS/HSS-E)
Boorbreek	Zorg voor betere spaanafvoer, kies boor met meer spaanruimte (alleen bij HSS/HSS-E)
	Controleer de werkstukopspanning
	Controleer de slingering van de boor
	Verlaag de voeding
	Richt de koelvloeistofstraal beter
	Verhoog de koelvloeistofdruk



ALGEMEEN - TECHNISCHE INFORMATIE

	Soort	Hardheid (HV10)	C %	W %	Mo %	Cr %	V %	Co %	Basismateriaal
	M2	810 – 850	0.9	6.4	5.0	4.2	1.8	–	HSS
	M35	830 – 870	0.93	6.4	5.0	4.2	1.8	4.8	HSCO
	M42	870 – 960	1.08	1.5	9.4	3.9	1.2	8.0	

Kenmerken	HSS materialen	Hardmetaal	K10/30F (veel toegepast voor VHM gereedschap)
Hardheid (HV30)	800-950	1300 – 1800	1600
Dichtheid (g/cm ³)	8.0 – 9.0	7.2 – 15	14.45
Drukvastheid (N/mm ²)	3000 – 4000	3000 – 8000	6250
Buigvastheid (N/mm ²)	2500 – 4000	1000 – 4700	4300
Hittebestendigheid (°C)	550	1000	900
E-module (KN/mm ²)	260 – 300	460 – 630	580
Korrelgrootte (µm)	–	0.2 – 10	0.8

De verhouding van harde delen (WC) en het bindmetaal (Co) geeft de volgende veranderingen in de eigenschappen.

Karakteristiek	Hoger WC gehalte geeft	Hoger Co gehalte geeft
Hardheid	Hogere hardheid	Minder hardheid
Drukvastheid (CS)	Hoger CS	Lager CS
Buigvastheid (BS)	Lager BS	Hoger BS

Ook de korrelgrootte beïnvloedt de materiaaleigenschappen. Kleine korrelgroottes betekenen een hogere hardheid en grove korrels geven meer taaheid.

Kenmerken van Oppervlaktebehandelingen en Coatings

Oppervlakte behandeling	Kleur	Coating materiaal	Hardheid (HV)	Dikte (µm)	Coating structuur	Wrijvings coëfficiënt t.o.v. staal	Max. inzet tot °C
	Zwart/Blauw	Fe ₃ O ₄	400	Max. 5	Verhoog de koelvloeistofdruk	–	550
	Bronze	Fe ₃ O ₄	400	Max. 5	Omzetting in de oppervlakte	–	550
	Goud	TiN	2300	1 – 4	Enkellaags	0.4	600
	Donker grijs	TiAlN	3300	3	Nano structuur	0.3 – 0.35	900



ALGEMEEN - TECHNISCHE INFORMATIE

Industrienormen voor de passing van schachten en gaten

Tolerantiewaarden worden getoond in microns (μm)

Formule voor microns ...1 $\mu\text{m} = 0.001 \text{ mm} / 0.000039''$

Tolerantie	Diameter (mm)							
	> 1 ≤ 3	> 3 ≤ 6	> 6 ≤ 10	> 10 ≤ 18	> 18 ≤ 30	> 30 ≤ 50	> 50 ≤ 80	> 80 ≤ 120
	Diameter (inch)							
	> 0.039" ≤ 0.118"	> 0.118" ≤ 0.236"	> 0.236" ≤ 0.394"	> 0.394" ≤ 0.709"	> 0.709" ≤ 1.181"	> 1.181" ≤ 1.968"	> 1.968" ≤ 3.149"	> 3.149" ≤ 4.724"
	Tolerantiewaarden (μm)							
e8	-14 / -28	-20 / -38	-25 / -47	-32 / -59	-40 / -73	-50 / -89	-60 / -106	-72 / -126
f6	-6 / -12	-10 / -18	-13 / -22	-16 / -27	-20 / -33	-25 / -41	-30 / -49	-36 / -58
f7	-6 / -16	-10 / -22	-13 / -28	-16 / -34	-20 / -41	-25 / -50	-30 / -60	-36 / -71
h6	0 / -6	0 / -8	0 / -9	0 / -11	0 / -13	0 / -16	0 / -19	0 / -22
h7	0 / -10	0 / -12	0 / -15	0 / -18	0 / -21	0 / -25	0 / -30	0 / -35
h8	0 / -14	0 / -18	0 / -22	0 / -27	0 / -33	0 / -39	0 / -46	0 / -54
h9	0 / -25	0 / -30	0 / -36	0 / -43	0 / -52	0 / -62	0 / -74	0 / -87
h10	0 / -40	0 / -48	0 / -58	0 / -70	0 / -84	0 / -100	0 / -120	0 / -140
h11	0 / -60	0 / -75	0 / -90	0 / -110	0 / -130	0 / -160	0 / -190	0 / -220
h12	0 / -100	0 / -120	0 / -150	0 / -180	0 / -210	0 / -250	0 / -300	0 / -350
k10	+40 / 0	+48 / 0	+58 / 0	+70 / 0	+84 / 0	+100 / 0	+120 / 0	+140 / 0
k12	+100 / 0	+120 / 0	+150 / 0	+180 / 0	+210 / 0	+250 / 0	+300 / 0	+350 / 0
m7	+2 / +12	+4 / +16	+6 / +21	+7 / +25	+8 / +29	+9 / +34	+11 / +41	+13 / +48
js14	+/-125	+/-150	+/-180	+/-215	+/-260	+/-310	+/-370	+/-435
js16	+/-300	+/-375	+/-450	+/-550	+/-650	+/-800	+/-950	+/-1100
H7	+10 / 0	+12 / 0	+15 / 0	+18 / 0	+21 / 0	+25 / 0	+30 / 0	+35 / 0
H8	+14 / 0	+18 / 0	+22 / 0	+27 / 0	+33 / 0	+39 / 0	+46 / 0	+54 / 0
H9	+25 / 0	+30 / 0	+36 / 0	+43 / 0	+52 / 0	+62 / 0	+74 / 0	+87 / 0
H12	+100 / 0	+120 / 0	+150 / 0	+180 / 0	+210 / 0	+250 / 0	+300 / 0	+350 / 0
P9	-6 / -31	-12 / -42	-15 / -51	-18 / -61	-22 / -74	-26 / -86	-32 / -106	-37 / -124
S7	-13 / -22	-15 / -27	-17 / -32	-21 / -39	-27 / -48	-34 / -59	-42 / -72	-58 / -93



ALGEMEEN - TECHNISCHE INFORMATIE

Snijsnelheidstabel

		Vc															
m/min.		5	8	10	15	20	25	30	40	50	60	70	80	90	100	110	150
SFM (feet/min.)		16	26	32	50	66	82	98	130	165	197	230	262	296	330	362	495
Ø		Toerental															
mm	inch																
1.00	–	1592	2546	3183	4775	6366	7958	9549	12732	15916	19099	22282	25465	28648	31831	35014	47747
1.50	–	1061	1698	2122	3183	4244	5305	6366	8488	10610	12732	14854	16977	19099	21221	23343	31831
2.00	–	796	1273	1592	2387	3183	3979	4775	6366	7958	9549	11141	12732	14324	15916	17507	23873
2.50	–	637	1019	1273	1910	2546	3183	3820	5093	6366	7639	8913	10186	11459	12732	14006	19099
3.00	–	531	849	1061	1592	2122	2653	3183	4244	5305	6366	7427	8488	9549	10610	11671	15916
3.18	1/8	500	801	1001	1501	2002	2502	3003	4004	5005	6006	7007	8008	9009	10010	11011	15015
3.50	–	455	728	909	1364	1819	2274	2728	3638	4547	5457	6366	7276	8185	9095	10004	13642
4.00	–	398	637	796	1194	1592	1989	2387	3183	3979	4775	5570	6366	7162	7958	8754	11937
4.50	–	354	566	707	1061	1415	1768	2122	2829	3537	4244	4951	5659	6366	7074	7781	10610
4.76	3/16	334	535	669	1003	1337	1672	2006	2675	3344	4012	4681	5350	6018	6687	7356	10031
5.00	–	318	509	637	955	1273	1592	1910	2546	3183	3820	4456	5093	5730	6366	7003	9549
6.00	–	265	424	531	796	1061	1326	1592	2122	2653	3183	3714	4244	4775	5305	5836	7958
6.35	1/4	251	401	501	752	1003	1253	1504	2005	2506	3008	3509	4010	4511	5013	5514	7519
7.00	–	227	364	455	682	909	1137	1364	1819	2274	2728	3183	3638	4093	4547	5002	6821
7.94	5/16	200	321	401	601	802	1002	1203	1604	2004	2405	2806	3207	3608	4009	4410	6013
8.00	–	199	318	398	597	796	995	1194	1592	1989	2387	2785	3183	3581	3979	4377	5968
9.00	–	177	283	354	531	707	884	1061	1415	1768	2122	2476	2829	3183	3537	3890	5305
9.53	3/8	167	267	334	501	668	835	1002	1336	1670	2004	2338	2672	3006	3340	3674	5010
10.00		159	255	318	477	637	796	955	1273	1592	1910	2228	2546	2865	3183	3501	4775
11.11	7/16	143	229	287	430	573	716	860	1146	1433	1719	2006	2292	2579	2865	3152	4298
12.00		133	212	265	398	531	663	796	1061	1326	1592	1857	2122	2387	2653	2918	3979
12.70	1/2	125	201	251	376	501	627	752	1003	1253	1504	1754	2005	2256	2506	2757	3760
14.00		114	182	227	341	455	568	682	909	1137	1364	1592	1819	2046	2274	2501	3410
14.29	9/16	111	178	223	334	446	557	668	891	1114	1337	1559	1782	2005	2228	2450	3341
15.00	–	106	170	212	318	424	531	637	849	1061	1273	1485	1698	1910	2122	2334	3183
15.88	5/8	100	160	200	301	401	501	601	802	1002	1203	1403	1604	1804	2004	2205	3007
16.00	–	99	159	199	298	398	497	597	796	995	1194	1393	1592	1790	1989	2188	2984
17.46	11/16	91	146	182	273	365	456	547	729	912	1094	1276	1458	1641	1823	2005	2735
18.00	–	88	141	177	265	354	442	531	707	884	1061	1238	1415	1592	1768	1945	2653
19.05	3/4	84	134	167	251	334	418	501	668	835	1003	1170	1337	1504	1671	1838	2506
20.00	–	80	127	159	239	318	398	477	637	796	955	1114	1273	1432	1592	1751	2387
24.00	–	66	106	133	199	265	332	398	531	663	796	928	1061	1194	1326	1459	1989
25.00	–	64	102	127	191	255	318	382	509	637	764	891	1019	1146	1273	1401	1910
27.00	–	59	94	118	177	236	295	354	472	589	707	825	943	1061	1179	1297	1768
30.00	–	53	85	106	159	212	265	318	424	531	637	743	849	955	1061	1167	1592
32.00	–	50	80	99	149	199	249	298	398	497	597	696	796	895	995	1094	1492
36.00	–	44	71	88	133	177	221	265	354	442	531	619	707	796	884	973	1326
40.00	–	40	64	80	119	159	199	239	318	398	477	557	637	716	796	875	1194
50.00	–	32	51	64	95	127	159	191	255	318	382	446	509	573	637	700	955



ALGEMEEN - TECHNISCHE INFORMATIE

Hardheid en Treksterkte

HV	HRC	HB	Treksterkte	
			(N/mm ²)	(Tons/sq. in.)
940	68	–	–	–
900	67	–	–	–
864	66	–	–	–
829	65	–	–	–
800	64	–	–	–
773	63	–	–	–
745	62	–	–	–
720	61	–	–	–
698	60	–	–	–
675	59	–	–	–
655	58	–	2200	142
650	–	618	2180	141
640	–	608	2145	139
639	57	607	2140	138
630	–	599	2105	136
620	–	589	2070	134
615	56	584	2050	133
610	–	580	2030	131
600	–	570	1995	129
596	55	567	1980	128
590	–	561	1955	126
580	–	551	1920	124
578	54	549	1910	124
570	–	542	1880	122
560	53	532	1845	119
550	–	523	1810	117
544	52	517	1790	116
540	–	513	1775	115
530	–	504	1740	113
527	51	501	1730	112
520	–	494	1700	110
514	50	488	1680	109
510	–	485	1665	108
500	–	475	1630	105
497	49	472	1620	105
490	–	466	1595	103
484	48	460	1570	102
480	–	456	1555	101
473	47	449	1530	99
470	–	447	1520	98
460	–	437	1485	96
458	46	435	1480	96
450	–	428	1455	94
446	45	424	1440	93
440	–	418	1420	92

HV	HRC	HB	Treksterkte	
			(N/mm ²)	(Tons/sq. in.)
434	44	413	1400	91
423	43	402	1360	88
413	42	393	1330	86
403	41	383	1300	84
392	40	372	1260	82
382	39	363	1230	80
373	38	354	1200	78
364	37	346	1170	76
355	36	337	1140	74
350	–	333	1125	73
345	35	328	1110	72
340	–	323	1095	71
336	34	319	1080	70
330	–	314	1060	69
327	33	311	1050	68
320	–	304	1030	67
317	32	301	1020	66
310	31	295	995	64
302	30	287	970	63
300	–	285	965	62
295	–	280	950	61
293	29	278	940	61
290	–	276	930	60
287	28	273	920	60
285	–	271	915	59
280	27	266	900	58
275	–	261	880	57
272	26	258	870	56
270	–	257	865	56
268	25	255	860	56
265	–	252	850	55
260	24	247	835	54
255	23	242	820	53
250	22	238	800	52
245	–	233	785	51
243	21	231	780	50
240	–	228	770	50
235	–	223	755	49
230	–	219	740	48
225	–	214	720	47
220	–	209	705	46
215	–	204	690	45
210	–	199	675	44
205	–	195	660	43
200	–	190	640	41



SNIJOLIE



M200-1



M200 No.1, blauw, snijolie voor zware bewerkingen

Een hoogwaardige chloorvrije snijolie voor zware bewerkingen, zoals bij tappen, kotteren en boren met de hand of met een kolomboormachine. Voor langere standtijden en betere oppervlaktekwaliteit. Eerste keus voor staal met hoge treksterkte, roestvast staal en superlegeringen.

Product	Nr.
M2000.25NR.1BLUE	1/4 Ltr. 12x
M2001.0NR.1BLUE	1 Ltr.
M2005.0NR.1BLUE	5 Ltr.
M20020.0NR.1BLUE	20 Ltr.

M200-2



M200 No.2, rood, snijolie voor non-ferro materialen

Een hoogwaardige chloorvrije olie voor verspanende bewerkingen in aluminium en aluminiumlegeringen. Voor smering en koeling om een lange standtijd van het gereedschap te bevorderen en een uitstekende oppervlaktekwaliteit te garanderen. Weinig impact op het milieu dankzij uitstekende antimist eigenschappen, hoge oxidatiestabiliteit en geringe geur.

Product	Nr.
M2000.25NR.2RED	1/4 Ltr. 12x
M2001.0NR.2RED	1 Ltr.
M2005.0NR.2RED	5 Ltr.



M200-3



M200 No.3, groen, snijolie voor algemene toepassingen

Een hoogwaardige chloorvrije snijolie met extreme druk (EP) additieven voor een langere standtijd van het gereedschap. Voor algemene snij- of vormbewerkingen, zoals tappen, kotten en boren in staal of gietstaal en roestast staal.

Product	Nr.
M2000.25NR.3GREEN	1/4 Ltr. 12x
M2001.0NR.3GREEN	1 Ltr.
M2005.0NR.3GREEN	5 Ltr.



DORMER PRAMET



REACH FOR THE SKIES

We hebben honderden nieuwe producten toegevoegd aan ons snijgereedschapsassortiment, met een specifieke focus op vliegtuigrompen en montagetoeepassingen. Dit zitten allemaal in een nieuwe publicatie, die u nu kunt downloaden.

Simply Reliable.





**RUIMERS
EN VERZINKBOREN**





GATBEWERKING - ALGEMENE INHOUD

6		WMG & ISO 13399
12	BOREN	INSTRUCTIES
15		VOLHARDMETAAL BOREN
66		HSS BOREN
176		TECHNISCHE INFORMATIE
186		SNIJOLIE
190		RUIMERS EN VERZINKBOREN
264	WISSELPLAATBOREN	INSTRUCTIES
271		HYDRA BOREN
297		TECHNISCHE INFORMATIE
307		WISSELPLAATBOREN
327		TECHNISCHE INFORMATIE
350	KOTTERSYSTEMEN	INSTRUCTIES
359		KOTTERKOPPEN
376		KOTTER ACCESSOIRES
381		WISSELPLATEN
404		OPNAMES
418		KOTTERSETS
429		TECHNISCHE INFORMATIE



RUIMERS EN VERZINKBOREN - UITLEG PRODUCTPAGINA

1 B400



VHM machineruimer, cilindrische schacht, H7

Ontworpen om een afwerking te geven binnen de grenzen van de H7 gattolerantie. Voor superieure prestaties en een langere standtijd bij het ruimen van harde en abrasieve materialen. Het spiraalvormige spiraalontwerp, met extreem ongelijke afstand tussen de tanden, vermindert trillingen en verbetert de rondheid, diameter en oppervlakteafwerking van de gaten.

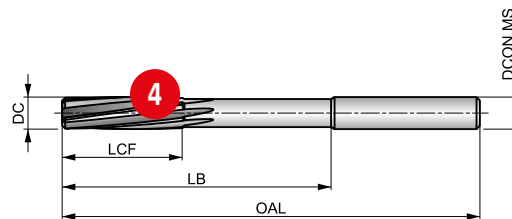

HM	Bright	DIN 8093
R	B	
H7		

De tabel geeft de geschiktheid aan voor de materiaalgroep en de startwaarden voor de snijsnelheid (m/min) en de letter verwijst naar de toe te passen voeding (fn), zie vanaf pagina 251.

P1.1	P1.2	P1.3	P2.1	P2.2	P2.3	P3.1	P3.2	P3.3	P4.1	P4.2	P4.3	M1.1	M1.2
■ 23 B	■ 26 B	■ 27 B	■ 20 B	■ 18 B	■ 16 C	■ 16 B	■ 13 B	■ 11 C	■ 10 B	■ 8 C	■ 7 C	■ 10 C	■ 8 C
M2.1	M2.2	M2.3	K1.1	K1.2	K1.3	K2.1	K2.2	K2.3	K3.1	K3.2	K3.3	K5.1	K5.2
■ 9 C	■ 7 C	■ 6 B	■ 20 D	■ 15 D	■ 11 D	■ 2	■ 17 D	■ 14 D	■ 18 D	■ 14 D	■ 11 D	■ 19 D	■ 15 D
K5.3	N1.1	N1.2	N1.3	N2.1	N2.2	N2.3	N3.1	N3.2	N3.3	N4.1	N4.2		
■ 11 D	■ 60 D	■ 45 D	■ 30 D	■ 38 D	■ 35 D	■ 25 D	■ 64 E	■ 38 E	■ 19 E	■ 35 C	■ 30 C		

DCON MS passing h6; DC >= 14 mm VHM slijkant.

Product	DC	OAL	LCF	LB	NOF	DCON MS
	[mm]	[mm]	[mm]	[mm]		[mm]
B4001.0	1.00	34.0	5.5	15.00	3	1.00
B4001.2	1.20	38.0	7.5	16.50	3	1.20
B4001.4	1.40	40.0	8.0	18.00	3	1.50
B4001.5	1.50	40.0	8.0	18.00	3	1.50
B4001.6	1.60	43.0	9.0	20.00	3	1.60
B4001.8	1.80	46.0	10.0	22.00	4	1.80
B4002.0	2.00	49.0	11.0	24.00	4	2.00
B4002.2	2.20	53.0	12.0	25.00	4	2.20
B4002.5	2.50	57.0	14.0	27.00	4	2.50
B4003.0	2.80	61.0	15.0	30.00	6	3.00
B4003.0	3.00	61.0	15.0	33.00	6	3.00
B4003.2	3.20	65.0	16.0	37.00	6	3.20

Product	DC	OAL	LCF	LB	NOF	DCON MS
	[mm]	[mm]	[mm]	[mm]		[mm]
B4004.5	4.50	80.0	21.0	52.00	6	4.50
B4005.0	5.00	86.0	23.0	58.00	6	5.00
B4005.5	5.50	93.0	26.0	57.00	6	5.60
B4006.0	6.00	93.0	26.0	57.00	6	5.60
B4006.5	6.50	101.0	28.0	65.00	6	6.30
B4007.0	7.00	109.0	31.0	73.00	6	7.10
B4008.0	8.00	117.0	33.0	81.00	6	8.00
B4009.0	9.00	125.0	36.0	85.00	6	9.00
B40010.0	10.00	133.0	38.0	93.00	6	10.00
B40012.0	12.00	151.0	44.0	111.00	6	10.00
B40014.0	14.00	160.0	47.0	115.00	6	12.50
B40016.0	16.00	170.0	52.0	125.00	6	12.50

Pos.	Omschrijving
1	Productfamiliecode
2	Productomschrijving
3	Afbeelding
4	Schematische afbeelding

Pos.	Omschrijving
5	Productkenmerken
6	Aanbevelingen materiaalgroep incl. snijsnelheid en voeding
7	Productcode
8	Productafmetingen



RUIMERS EN VERZINKBOREN – UITLEG PICTOGRAMMEN

ALGEMENE PICTOGRAMMEN

	Eerste keus gebruik
	Beperkte inzetbaarheid

HAALBARE PASSING (TCHA)

	H7 – Industrienorm voor tolerantieklasse van de gatdiameter		k11 – Industrienorm voor tolerantieklasse van de gatdiameter
	Hoge precisie tolerantieklasse van de gatdiameter		

TOEPASSINGSHOEK

	100° verzinkboor		20° conische boor		82° verzinkboor
	180° verzinkboor		60° verzinkboor		90° verzinkboor

PRODUCTIENORM (BSG)

	ANSI norm		DIN 219 – Opsteekruimer norm		DIN 8050 – Parallele schacht ruimer norm
	BS 328 – Boor en ruimer norm		DIN 311 – Morseconus schacht klinkgatruimer norm		DIN 8051 – Morseconus schacht ruimer norm
	DIN 206 – Handruimer norm		DIN 334 C – Rechte schacht verzinkboor norm		DIN 8093 – Rechte schacht ruimer norm
	DIN 208 – Morseconus schacht ruimer norm		DIN 334 D – Morseconus schacht verzinkboor norm		DIN 8094 – Morseconus schacht ruimer norm
	DIN 212 – Machine ruimer norm		DIN 335 A – Rechte schacht verzinkboor norm		DIN 9 – Pengat ruimer norm
	DIN 217 – Opsteekruimer norm		DIN 335 C – Rechte schacht verzinkboor norm		Dormer norm
	DIN 2179 – Parallele schacht pengat ruimer norm		DIN 335 D – Morseconus schacht verzinkboor norm		
	DIN 2180 – Morseconus schacht pengat ruimer norm		DIN 373 – Verzinkboor norm		

COATING

	Aluminium Titanium Carbon Nitride Coating		Combinatie blank en stoomontladen		Titanium Aluminium Nitride Coating
	Blank (ongecoat)		Stoomontladen en bronskleurige Oxide behandeling		Titanium Nitride Coating

SNIJRICHTING

	Rechts
--	--------

BASISMATERIAAL (BMC)

	Hardmetaal		Snelstaal
	Cobalt gelegeerd snelstaal		







RUIMERS EN VERZINKBOREN – UITLEG PICTOGRAMMEN

UITVOERING RUIMER

A	DIN uitvoering A – Rechte spaangroeven $\leq \varnothing 3.5\text{mm}$
B	DIN uitvoering B – Gespiraliseerde spaangroeven $\leq \varnothing 3.5\text{mm}$
E	DIN uitvoering C – Rechte spaangroeven $\geq \varnothing 4.0\text{mm}$

SCHACHT

	Cilindrische schacht / rechte schacht		Cilindrische schacht met lip
	Cilindrische schacht met 3 geslepen vlakken		DIN 6535 HA cilindrische schacht
	Cilindrische schacht met zeskant		Morseconus schacht
	cilindrische schacht met vierkant		

CONICITEIT

	1:48 Coniciteit (1/4" per foot conisch)		1:50 Coniciteit (1 mm per 50 mm conisch)
--	---	---	--



RUIMERS EN VERZINKBOREN – NAVIGATOR BASISMATERIAAL







Gereedschapsmaterialen

Snelstaal		Een medium gelegerd snelstaal dat goede bewerkbaarheid en goede prestaties heeft. HSS wordt gekenmerkt door hardheid, taaïheid en slijtvastheid, waardoor het aantrekkelijk is voor vele toepassingen, bijvoorbeeld bij boren en tappen.
Kobalt snelstaal		Dit snelstaal bevat kobalt voor verhoogde warmtehardheid. Hierdoor biedt het een goede combinatie van taaïheid en hardheid. Het heeft een goede bewerkbaarheid en goede slijtvastheid, waardoor het ideaal is voor het produceren van boren, tappen, ruimers en frezen.

Basismateriaal

Hardmetaal		<p>Een gesinterd poedermetallurgisch substraat, bestaande uit een metalen volhardmetaal composiet met bindmiddelmetaal. Het meest centrale ruwe materiaal is wolfram carbide (WC). Wolfram carbide draagt bij aan de hardheid van het materiaal. Tantaal carbide (TaC), titaan carbide (TiC) en niobium carbide (NbC) vullen WC aan en passen de eigenschap aan de gewenste eigenschappen aan. Deze drie materialen worden kubische carbides genoemd. Kobalt (Co) fungeert als een bindmiddel en houdt het materiaal bij elkaar.</p> <p>Carbidematerialen worden vaak gekenmerkt door hoge compressiesterkte, hoge hardheid en daardoor hoge slijtvastheid, maar ook door beperkte buigsterkte en taaïheid. Carbide wordt gebruikt in tappen, ruimers, frezen, boren en draadfrezen.</p>
-------------------	---	--

Oppervlakte coatingen

Titanium Nitride (TiN)		Titaniumnitride is een goudkleurige keramische coating die wordt toegepast door fysieke dampafzetting (PVD). Hoge hardheid in combinatie met lage wrijvings eigenschappen zorgt voor aanzienlijk langere standtijd of betere snijprestaties van gereedschappen die niet zijn gecoat. TiN coatings worden voornamelijk gebruikt voor boren en tappen.
Aluminium Titanium Carbon Nitride (AlTiCN)		Aluminium Titaan Carbon-Nitride (AlTiCN) is een PVD coating die speciaal werd ontwikkeld om te voldoen aan de strenge eisen van de medische industrie. Het is echter eveneens toepasbaar op bepaalde snijgereedschappen dankzij een dunne-film technologie van hoge kwaliteit, met uitstekende microhardheid en adhesie-eigenschappen.
Titaan Aluminium Nitride coating (TiAlN)		Titaan aluminiumnitride is een multilaags keramische coating die wordt aangebracht door PVD-coatingtechnologie en wordt gekenmerkt door hoge taaïheid en oxidatiestabiliteit. Deze eigenschappen maken het ideaal voor hogere snelheden en voedingen, terwijl de standtijd van het gereedschap wordt verbeterd. TiAlN wordt gebruikt bij boor-, tap- en freestoe toepassingen en is geschikt voor gebruik bij bewerkingen zonder koelmiddel.
Blank (niet gecoat)		Blanke uitvoering (niet-gecoat oppervlak) verbetert de spaanafvoer bij zachte of non-ferro materialen en behoudt scherpe snijkanten in slijtvaste materialen.
Combinatie blank en stoomontlaten		Combinatie van blank en stoomontlaten kan effectief zijn omdat het blauwe oxide en meer poreuze oppervlak fungeert om de snijvloei stof vast te houden terwijl het blanke oppervlak de afvoer van spanen verbetert. Deze combinatie wordt bereikt door het blanke oppervlak na het stoomontlaten te slijpen.
Stoomontlaten en bronskleurige Oxide behandeling		De combinatie van stoomontlaten en bronskleurige oxide behandeling kan doeltreffend zijn, omdat het poreuzere oppervlak van de blauwe oxide de snijvloei stof vasthoudt, terwijl het bronzen oppervlak helpt bij het afvoeren van spanen. Beide oppervlaktebehandelingen geven een zekere oppervlaktebescherming aan het gereedschap. Deze combinaties worden bereikt door twee verschillende hardingscycli te gebruiken. Vertaald met www.DeepL.com/Translator (gratis versie)



Productfamiliecode	<table border="1"> <tr> <td>Basismateriaal (BMC)</td><td>HM</td><td>HM</td><td>HM</td><td>HM</td><td>HM</td><td>HSS</td><td>HSS</td><td>HSS</td><td>HSS-E</td><td>HSS</td><td>HSS</td><td>HSS</td><td>HSS</td></tr> <tr> <td>Coating</td><td>Bright</td><td>Bright</td><td>Bright</td><td>Bright</td><td>Bright</td><td>Bright ST</td><td>Bright</td><td></td><td>Bright ST</td><td>Bright ST</td><td>Bright ST</td><td>Bright</td><td>ST Bronze</td></tr> <tr> <td>Productienorm (BSG)</td><td>DIN 8093</td><td>DIN 8093</td><td>DIN 8050</td><td>DIN 8094</td><td>DIN 8051</td><td>DIN 206</td><td>DORMER</td><td>DORMER</td><td>BS 328</td><td>BS 328</td><td>DIN 9</td><td>DIN 9</td><td>ANSI</td></tr> <tr> <td>Snijrichting</td><td>R</td><td>R</td><td>R</td><td>R</td><td>R</td><td>R</td><td>R</td><td></td><td>R</td><td>R</td><td>R</td><td>R</td><td>R</td></tr> <tr> <td>Schacht</td><td></td><td></td><td></td><td></td><td></td><td></td><td></td><td></td><td></td><td></td><td></td><td></td><td></td></tr> <tr> <td>Verzinkhoek</td><td></td><td></td><td></td><td></td><td></td><td></td><td></td><td></td><td></td><td></td><td></td><td></td><td></td></tr> <tr> <td>Spaangroefvorm</td><td>B</td><td>B</td><td>A</td><td>B</td><td>A</td><td>B</td><td></td><td></td><td>B</td><td>A</td><td>A</td><td>B</td><td></td></tr> <tr> <td>Haalbare passing (TCHA)</td><td>H7</td><td>$\begin{matrix} \phi.95-5.5 \\ +0.004 \\ \phi5.51-12 \\ +0.005 \end{matrix}$</td><td>H7</td><td>H7</td><td>H7</td><td>H7</td><td></td><td></td><td>H7</td><td></td><td></td><td></td><td></td></tr> <tr> <td>Coniciteit</td><td></td><td></td><td></td><td></td><td></td><td></td><td></td><td></td><td></td><td>1:48</td><td>1:50</td><td>1:50</td><td></td></tr> </table>													Basismateriaal (BMC)	HM	HM	HM	HM	HM	HSS	HSS	HSS	HSS-E	HSS	HSS	HSS	HSS	Coating	Bright	Bright	Bright	Bright	Bright	Bright ST	Bright		Bright ST	Bright ST	Bright ST	Bright	ST Bronze	Productienorm (BSG)	DIN 8093	DIN 8093	DIN 8050	DIN 8094	DIN 8051	DIN 206	DORMER	DORMER	BS 328	BS 328	DIN 9	DIN 9	ANSI	Snijrichting	R	R	R	R	R	R	R		R	R	R	R	R	Schacht														Verzinkhoek														Spaangroefvorm	B	B	A	B	A	B			B	A	A	B		Haalbare passing (TCHA)	H7	$\begin{matrix} \phi.95-5.5 \\ +0.004 \\ \phi5.51-12 \\ +0.005 \end{matrix}$	H7	H7	H7	H7			H7					Coniciteit										1:48	1:50	1:50	
	Basismateriaal (BMC)	HM	HM	HM	HM	HM	HSS	HSS	HSS	HSS-E	HSS	HSS	HSS	HSS																																																																																																																													
Coating	Bright	Bright	Bright	Bright	Bright	Bright ST	Bright		Bright ST	Bright ST	Bright ST	Bright	ST Bronze																																																																																																																														
Productienorm (BSG)	DIN 8093	DIN 8093	DIN 8050	DIN 8094	DIN 8051	DIN 206	DORMER	DORMER	BS 328	BS 328	DIN 9	DIN 9	ANSI																																																																																																																														
Snijrichting	R	R	R	R	R	R	R		R	R	R	R	R																																																																																																																														
Schacht																																																																																																																																											
Verzinkhoek																																																																																																																																											
Spaangroefvorm	B	B	A	B	A	B			B	A	A	B																																																																																																																															
Haalbare passing (TCHA)	H7	$\begin{matrix} \phi.95-5.5 \\ +0.004 \\ \phi5.51-12 \\ +0.005 \end{matrix}$	H7	H7	H7	H7			H7																																																																																																																																		
Coniciteit										1:48	1:50	1:50																																																																																																																															
	B400	B481	B441	B411	B442	B100	B334	B335	B901	B301	B903	B952	B122																																																																																																																														
	1.00 - 20.00	0.98 - 12.05	10.00 - 20.00	5.00 - 30.00	10.00 - 20.00	1.50 - 50.00	N000 - N16	N000BLADES - N16NUT	1.50 - 1/2	1/16 - 1/2	1.50 - 20.00	1.20 - 50.00	3/8 - 1.1/16																																																																																																																														
	200	201	203	204	205	206	208	209	210	211	212	213	214																																																																																																																														
P	P1	■	■	■	■	■	■	■	■	■	■	■	■																																																																																																																														
	P2	■	■	■	■	■	■	■	■	■	■	■	■																																																																																																																														
	P3	■	■	■	■	■	■	■	■	■	■	■	■																																																																																																																														
	P4	■	■	■	■	■	■	■	■	■	■	■	■																																																																																																																														
M	M1	■	■	■	■	■	■	■	■	■	■	■	■																																																																																																																														
	M2	■	■	■	■	■	■	■	■	■	■	■	■																																																																																																																														
	M3																																																																																																																																										
	M4																																																																																																																																										
K	K1	■	■	■	■	■	■	■	■	■	■	■	■																																																																																																																														
	K2	■	■	■	■	■	■	■	■	■	■	■	■																																																																																																																														
	K3	■	■	■	■	■	■	■	■	■	■	■	■																																																																																																																														
	K4																																																																																																																																										
	K5	■	■	■	■	■	■	■	■	■	■	■	■																																																																																																																														
N	N1	■	■	■	■	■	■	■	■	■	■	■	■																																																																																																																														
	N2	■	■	■	■	■	■	■	■	■	■	■	■																																																																																																																														
	N3	■	■	■	■	■	■	■	■	■	■	■	■																																																																																																																														
	N4	■	■	■	■	■	■	■	■	■	■	■	■																																																																																																																														
	N5																																																																																																																																										
S	S1																																																																																																																																										
	S2																																																																																																																																										
	S3																																																																																																																																										
	S4																																																																																																																																										
H	H1																																																																																																																																										
	H2																																																																																																																																										
	H3																																																																																																																																										
	H4																																																																																																																																										

■ Geschikt ■ Beperkt geschikt



	HSS-E	HSS-E	HSS-E	HSS-E	HSS-E	HSS-E	HSS	HSS-E	HSS-E	HSS-E		HM	HSS	HSS
	Bright	Bright	Bright	Bright	Bright	Bright ST	Bright ST	Bright	Bright ST	Bright		Bright	Bright	TIN
	DIN 2179	DIN 212	DIN 212	DIN 212	DIN 208	BS 328	DIN 311	DIN 2180	DIN 219	DIN 217		DIN 335C	DIN 334C	DIN 334C
		B	B	E	B	B		B						
		H7	$\begin{matrix} \phi 95-5.5 \\ +0.004 \\ \phi 5.51-12 \\ +0.005 \end{matrix}$	H7	H7	H7	k11		H7					
	1:50							1:50						
	B953	B180	B170	B157	B161	B101	B121	B954	B955	B956	B957	G400	G135	G335
	1.00 - 12.00	1.50 - 20.00	0.98 - 12.00	2.00 - 20.00	3.00 - 50.00	3.00 - 2"	10.00 - 30.00	5.00 - 30.00	25.00 - 80.00	13.00 - 40.00	N3DRIVER - N9WASHER	6.30 - 31.00	6.30 - 25.00	6.30 - 25.00
	215	216	218	220	221	222	224	225	226	227	228	229	230	231
P1	■	■	■	■	■	■	■	■	■			■	■	■
P2	■	■	■	■	■	■	■	■	■			■	■	■
P3	▣	■	■	▣	■	■	■	▣	■			■	▣	■
P4	▣	▣	▣		▣	▣	▣	▣	▣			■	▣	■
M1	▣	▣	▣	▣	▣	▣		▣	▣			■	▣	▣
M2	▣	▣	▣	▣	▣			▣	▣			▣	▣	▣
M3												▣		▣
M4												▣		
K1	■	■	■		■	■	■	■	■			■	▣	■
K2	■	■	■		■	■	■	■	■			■	▣	■
K3	▣	▣	▣		▣	▣	▣	▣	▣			■	▣	■
K4												■		▣
K5												■	▣	■
N1	▣	■	■	■	■	■	■	■	■			■	▣	■
N2	■	■	■	■	■	■	■	■	■			■	■	■
N3	▣	■	■	■	■	■	■	■	■			■	■	■
N4	▣	▣	▣		▣	▣	▣	▣	▣			■	▣	▣
N5												■		
S1												■		
S2												▣		
S3												▣		
S4												▣		
H1												■		
H2												■		
H3												▣		
H4												▣		

■ Geschikt ▣ Beperkt geschikt



Basismateriaal (BMC)	HSS	HSS	HSS	HSS-E	HSS	HSS	HSS	HSS	HSS	HSS-E	HSS-E	HSS
Coating	Bright	Bright	Bright	Bright	Bright	TIAIN	Bright	TIAIN	Bright	ALTiCN	Bright	Bright
Productienorm (BSG)	DIN 334D	DIN 335C	DORMER	DORMER	DIN 335C	DIN 335C	DIN 335C	DIN 335C	DIN 335C	DIN 335C	DORMER	DORMER
Snijrichting	R	R	R	R	R	R	R	R	R	R	R	R
Schacht												
Verzinkhoek	60°	82°	90°	90°	90°	90°	90°	90°	90°	90°	90°	90°
Spaangroefvorm												
Haalbare passing (TCHA)												
Coniciteit												
Productfamiliecode	G137	G154	G129	G149	G136	G560	G106	G506	G142	G570	G107	G600
	16.00 - 80.00	6.30 - 25.00	6.00 - 31.50	5.00 - 50.00	4.30 - 31.00	6.30 - 31.00	6.30 - 50.00	6.30 - 50.00	4.80 - 31.00	6.30 - 31.00	6.30 - 20.50	6.30 - 25.00
	232	233	234	235	236	237	238	239	240	241	242	243
P	P1	■	■	■	■	■	■	■	■	■	■	■
	P2	■	■	■	■	■	■	■	■	■	■	■
	P3	■	■	■	■	■	■	■	■	■	■	■
	P4	■	■	■	■	■	■	■	■	■	■	■
M	M1	■	■	■	■	■	■	■	■	■	■	■
	M2	■	■	■	■	■	■	■	■	■	■	■
	M3								■	■	■	■
	M4								■	■	■	■
K	K1	■	■	■	■	■	■	■	■	■	■	■
	K2	■	■	■	■	■	■	■	■	■	■	■
	K3	■	■	■	■	■	■	■	■	■	■	■
	K4						■	■	■	■	■	■
	K5	■	■	■	■	■	■	■	■	■	■	■
N	N1	■	■	■	■	■	■	■	■	■	■	■
	N2	■	■	■	■	■	■	■	■	■	■	■
	N3	■	■	■	■	■	■	■	■	■	■	■
	N4	■	■	■	■	■	■	■	■	■	■	■
	N5								■			
S	S1											
	S2											
	S3											
	S4											
H	H1											
	H2											
	H3											
	H4											

■ Geschikt ■ Beperkt geschikt

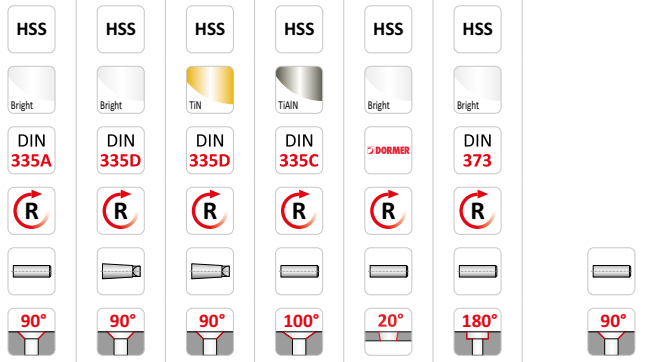

G132	G138	G338	G171	G314	G125	G236
------	------	------	------	------	------	------

8.00 - 20.00	25.00 - 80.00	25.00 - 63.00	6.30 - 25.00	4.00 - 9.00	6.50 - 20.00	Set
--------------	---------------	---------------	--------------	-------------	--------------	-----

244	245	246	247	248	249	250
-----	-----	-----	-----	-----	-----	-----

P1						
P2	■	■	■	■	■	■
P3	■	■	■	■	■	■
P4	■	■	■	■	■	■
M1		■	■	■	■	■
M2		■	■	■	■	■
M3	■					
M4	■					
K1	■	■	■	■	■	■
K2	■	■	■	■	■	■
K3	■	■	■	■	■	■
K4	■	■	■	■	■	■
K5	■	■	■	■	■	■
N1	■	■	■	■	■	■
N2	■	■	■	■	■	■
N3	■	■	■	■	■	■
N4	■	■	■	■	■	■
N5						
S1						
S2						
S3						
S4						
H1						
H2						
H3						
H4						



B400



VHM machineringer, cilindrische schacht, H7

Ontworpen om een afwerking te geven binnen de grenzen van de H7 gattolerantie. Voor uitstekende prestaties en een langere standtijd bij het ruimen van harde en abrasieve materialen. Het spiraalvormige spiraalontwerp, met extreem ongelijke afstand tussen de tanden, vermindert trillingen en verbetert de rondheid, diameter en oppervlakteafwerking van de gaten.

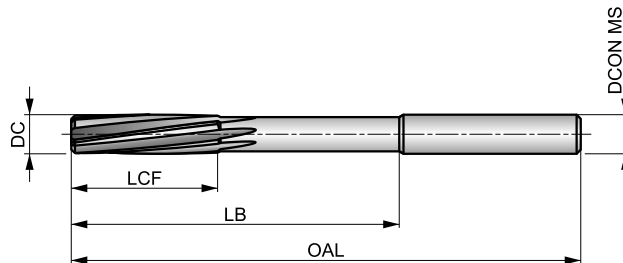

HM	Bright	DIN 8093
R		B
H7		

De tabel geeft de geschiktheid aan voor de materiaalgroep en de startwaarden voor de snijsnelheid (m/min) en de letter verwijst naar de toe te passen voeding (fn), zie vanaf pagina 251.

P1.1 ■ 23 B	P1.2 ■ 26 B	P1.3 ■ 27 B	P2.1 ■ 20 B	P2.2 ■ 18 B	P2.3 ■ 16 C	P3.1 ■ 16 B	P3.2 ■ 13 B	P3.3 ■ 11 C	P4.1 ■ 10 B	P4.2 ■ 8 C	P4.3 ■ 7 C	M1.1 ▣ 10 C	M1.2 ▣ 8 C
M2.1 ▣ 19 C	M2.2 ▣ 17 C	M2.3 ▣ 16 B	K1.1 ■ 20 D	K1.2 ■ 15 D	K1.3 ■ 11 D	K2.1 ■ 21 D	K2.2 ■ 17 D	K2.3 ■ 14 D	K3.1 ■ 18 D	K3.2 ■ 14 D	K3.3 ■ 11 D	K5.1 ■ 19 D	K5.2 ■ 15 D
K5.3 ■ 11 D	N1.1 ▣ 60 D	N1.2 ■ 45 D	N1.3 ■ 30 D	N2.1 ■ 38 D	N2.2 ■ 35 D	N2.3 ■ 25 D	N3.1 ■ 64 E	N3.2 ■ 38 E	N3.3 ▣ 19 E	N4.1 ▣ 35 C	N4.2 ▣ 30 C		

DCON MS passing h6; DC >= 14 mm VHM snijkanten.

Product	DC (mm)	OAL (mm)	LCF (mm)	LB (mm)	NOF	DCON MS (mm)
B4001.0	1.00	34.0	5.5	15.00	3	1.00
B4001.2	1.20	38.0	7.5	16.50	3	1.20
B4001.4	1.40	40.0	8.0	18.00	3	1.50
B4001.5	1.50	40.0	8.0	18.00	3	1.50
B4001.6	1.60	43.0	9.0	20.00	3	1.60
B4001.8	1.80	46.0	10.0	22.00	4	1.80
B4002.0	2.00	49.0	11.0	24.00	4	2.00
B4002.2	2.20	53.0	12.0	25.00	4	2.20
B4002.5	2.50	57.0	14.0	29.00	4	2.50
B4002.8	2.80	61.0	15.0	33.00	6	3.00
B4003.0	3.00	61.0	15.0	33.00	6	3.00
B4003.2	3.20	65.0	16.0	37.00	6	3.20
B4003.5	3.50	70.0	18.0	42.00	6	3.50
B4004.0	4.00	75.0	19.0	47.00	6	4.00

Product	DC (mm)	OAL (mm)	LCF (mm)	LB (mm)	NOF	DCON MS (mm)
B4004.5	4.50	80.0	21.0	52.00	6	4.50
B4005.0	5.00	86.0	23.0	58.00	6	5.00
B4005.5	5.50	93.0	26.0	57.00	6	5.60
B4006.0	6.00	93.0	26.0	57.00	6	5.60
B4006.5	6.50	101.0	28.0	65.00	6	6.30
B4007.0	7.00	109.0	31.0	73.00	6	7.10
B4008.0	8.00	117.0	33.0	81.00	6	8.00
B4009.0	9.00	125.0	36.0	85.00	6	9.00
B40010.0	10.00	133.0	38.0	93.00	6	10.00
B40012.0	12.00	151.0	44.0	111.00	6	10.00
B40014.0	14.00	160.0	47.0	115.00	6	12.50
B40016.0	16.00	170.0	52.0	125.00	6	12.50
B40018.0	18.00	182.0	56.0	137.00	6	14.00
B40020.0	20.00	195.0	60.0	147.00	6	16.00



B481



VHM machineruimer, cilindrische eenheidsschacht, 0,01mm oplopend

Machineruimer met eenheidsschacht voor hoge prestaties bij CNC-bewerking. Verschillende incrementen maken het mogelijk om nauwkeurige diameters en passingen te produceren. Hoogwaardige hardmetalen snijkanten zorgen voor sterk verbeterde prestaties en een langere standtijd bij het ruimen van harde en abrasieve materialen. Uiterst ongelijke afstand tussen de snijkanten om trillingen te verminderen.

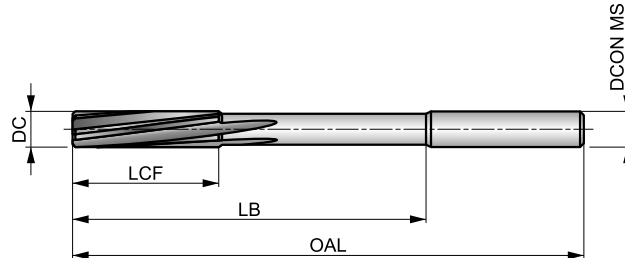

HM	Bright	DIN 8093
R	DIN 6535HA	B
$\varnothing_{95-5.5}$ $+0.004$ $\varnothing_{5.51-12}$ $+0.005$		

De tabel geeft de geschiktheid aan voor de materiaalgroep en de startwaarden voor de snijsnelheid (m/min) en de letter verwijst naar de toe te passen voeding (fn), zie vanaf pagina 251.

P1.1 ■ 23 B	P1.2 ■ 26 B	P1.3 ■ 27 B	P2.1 ■ 20 B	P2.2 ■ 18 B	P2.3 ■ 16 C	P3.1 ■ 16 B	P3.2 ■ 13 B	P3.3 ■ 11 C	P4.1 ■ 10 B	P4.2 ■ 8 C	P4.3 ■ 7 C	M1.1 ■ 10 C	M1.2 ■ 8 C
M2.1 ■ 9 C	M2.2 ■ 7 C	M2.3 ■ 6 B	K1.1 ■ 20 D	K1.2 ■ 15 D	K1.3 ■ 11 D	K2.1 ■ 21 D	K2.2 ■ 17 D	K2.3 ■ 14 D	K3.1 ■ 18 D	K3.2 ■ 14 D	K3.3 ■ 11 D	K5.1 ■ 19 D	K5.2 ■ 15 D
K5.3 ■ 11 D	N1.1 ■ 60 D	N1.2 ■ 45 D	N1.3 ■ 30 D	N2.1 ■ 38 D	N2.2 ■ 35 D	N2.3 ■ 25 D	N3.1 ■ 64 E	N3.2 ■ 38 E	N3.3 ■ 19 E	N4.1 ■ 35 C	N4.2 ■ 30 C		

DCON MS passing h6.

Product	DC	OAL	LCF	LB	NOF	DCON MS
	(mm)	(mm)	(mm)	(mm)		(mm)
B4810.98	0.98	50.0	6.0	28.00	3	3.00
B4810.99	0.99	50.0	6.0	28.00	3	3.00
B4811.00	1.00	50.0	6.0	28.00	3	3.00
B4811.01	1.01	50.0	6.0	28.00	3	3.00
B4811.02	1.02	50.0	6.0	28.00	3	3.00
B4811.03	1.03	50.0	6.0	28.00	3	3.00
B4811.48	1.48	50.0	9.0	28.00	3	3.00
B4811.49	1.49	50.0	9.0	28.00	3	3.00
B4811.50	1.50	50.0	9.0	28.00	3	3.00
B4811.51	1.51	50.0	10.0	28.00	3	3.00
B4811.52	1.52	50.0	10.0	28.00	3	3.00
B4811.53	1.53	50.0	10.0	28.00	3	3.00
B4811.98	1.98	50.0	12.0	28.00	4	3.00
B4811.99	1.99	50.0	12.0	28.00	4	3.00
B4812.00	2.00	50.0	12.0	28.00	4	3.00
B4812.01	2.01	50.0	12.0	28.00	4	3.00
B4812.02	2.02	50.0	12.0	28.00	4	3.00
B4812.03	2.03	50.0	12.0	28.00	4	3.00
B4812.48	2.48	60.0	16.0	28.00	4	3.00
B4812.49	2.49	60.0	16.0	28.00	4	3.00
B4812.50	2.50	60.0	16.0	28.00	4	3.00
B4812.51	2.51	60.0	16.0	28.00	4	3.00
B4812.52	2.52	60.0	16.0	28.00	4	3.00
B4812.53	2.53	60.0	16.0	28.00	4	3.00
B4812.97	2.97	65.0	17.0	28.00	6	4.00
B4812.98	2.98	65.0	17.0	28.00	6	4.00
B4812.99	2.99	65.0	17.0	28.00	6	4.00
B4813.00	3.00	65.0	17.0	28.00	6	4.00
B4813.01	3.01	65.0	17.0	28.00	6	4.00
B4813.02	3.02	65.0	17.0	28.00	6	4.00
B4813.03	3.03	65.0	17.0	28.00	6	4.00
B4813.97	3.97	75.0	19.0	28.00	6	4.00
B4813.98	3.98	75.0	19.0	28.00	6	4.00
B4813.99	3.99	75.0	19.0	28.00	6	4.00
B4814.00	4.00	75.0	19.0	28.00	6	4.00
B4814.01	4.01	75.0	19.0	28.00	6	4.00
B4814.02	4.02	75.0	19.0	28.00	6	4.00
B4814.03	4.03	75.0	19.0	28.00	6	4.00
B4814.97	4.97	93.0	23.0	36.00	6	6.00
B4814.98	4.98	93.0	23.0	36.00	6	6.00
B4814.99	4.99	93.0	23.0	36.00	6	6.00
B4815.00	5.00	93.0	23.0	36.00	6	6.00
B4815.01	5.01	93.0	23.0	36.00	6	6.00
B4815.02	5.02	93.0	23.0	36.00	6	6.00
B4815.03	5.03	93.0	23.0	36.00	6	6.00
B4815.97	5.97	93.0	26.0	36.00	6	6.00
B4815.98	5.98	93.0	26.0	36.00	6	6.00
B4815.99	5.99	93.0	26.0	36.00	6	6.00
B4816.00	6.00	93.0	26.0	36.00	6	6.00
B4816.01	6.01	93.0	26.0	36.00	6	6.00
B4816.02	6.02	93.0	26.0	36.00	6	6.00
B4816.03	6.03	93.0	26.0	36.00	6	6.00
B4817.97	7.97	117.0	33.0	36.00	6	8.00
B4817.98	7.98	117.0	33.0	36.00	6	8.00



Product	DC	OAL	LCF	LB	NOF	DCON MS
	(mm)	(mm)	(mm)	(mm)		(mm)
B4817.99	7.99	117.0	33.0	36.00	6	8.00
B4818.00	8.00	117.0	33.0	36.00	6	8.00
B4818.01	8.01	117.0	33.0	36.00	6	8.00
B4818.02	8.02	117.0	33.0	36.00	6	8.00
B4818.03	8.03	117.0	33.0	36.00	6	8.00
B4818.04	8.04	117.0	33.0	36.00	6	8.00
B4819.97	9.97	133.0	38.0	40.00	6	10.00
B4819.98	9.98	133.0	38.0	40.00	6	10.00
B4819.99	9.99	133.0	38.0	40.00	6	10.00
B48110.00	10.00	133.0	38.0	40.00	6	10.00
B48110.01	10.01	133.0	38.0	40.00	6	10.00
B48110.02	10.02	133.0	38.0	40.00	6	10.00

Product	DC	OAL	LCF	LB	NOF	DCON MS
	(mm)	(mm)	(mm)	(mm)		(mm)
B48110.03	10.03	133.0	38.0	40.00	6	10.00
B48110.04	10.04	133.0	38.0	40.00	6	10.00
B48110.05	10.05	133.0	38.0	40.00	6	10.00
B48111.97	11.97	151.0	44.0	45.00	6	12.00
B48111.98	11.98	151.0	44.0	45.00	6	12.00
B48111.99	11.99	151.0	44.0	45.00	6	12.00
B48112.00	12.00	151.0	44.0	45.00	6	12.00
B48112.01	12.01	151.0	44.0	45.00	6	12.00
B48112.02	12.02	151.0	44.0	45.00	6	12.00
B48112.03	12.03	151.0	44.0	45.00	6	12.00
B48112.04	12.04	151.0	44.0	45.00	6	12.00
B48112.05	12.05	151.0	44.0	45.00	6	12.00



B441



HM machineruimer, cilindrische schacht, H7

De gesoldeerde hardmetalen snijkanten zorgen voor een aanzienlijke verbetering van de prestaties en een langere standtijd van het gereedschap bij het ruimen van harde en abrasieve materialen. De spiraalvormige groeven hebben een ongelijke afstand tussen de tanden, wat trillingen effectief vermindert en de symmetrie, grootte en afwerking van de gaten verbetert.

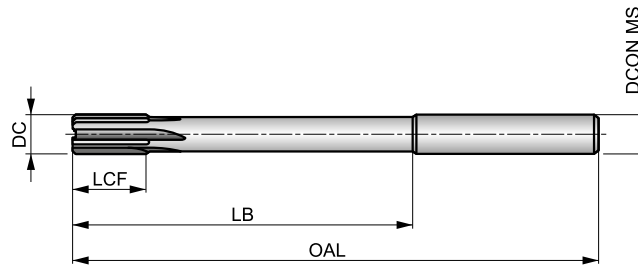

HM	Bright	DIN 8050
R		A
H7		

De tabel geeft de geschiktheid aan voor de materiaalgroep en de startwaarden voor de snijsnelheid (m/min) en de letter verwijst naar de toe te passen voeding (fn), zie vanaf pagina 251.

P1.1 ■ 23 B	P1.2 ■ 26 B	P1.3 ■ 27 B	P2.1 ■ 20 B	P2.2 ■ 18 B	P2.3 ■ 16 C	P3.1 ■ 16 B	P3.2 ■ 13 B	P3.3 ■ 11 C	P4.1 ■ 10 B	P4.2 ■ 8 C	P4.3 ■ 7 C	M1.1 ▣ 10 C	M1.2 ▣ 8 C
M2.1 ▣ 9 C	M2.2 ▣ 7 C	M2.3 ▣ 6 B	K1.1 ■ 20 D	K1.2 ■ 15 D	K1.3 ■ 11 D	K2.1 ■ 21 D	K2.2 ■ 17 D	K2.3 ■ 14 D	K3.1 ■ 18 D	K3.2 ■ 14 D	K3.3 ■ 11 D	K5.1 ■ 19 D	K5.2 ■ 15 D
K5.3 ■ 11 D	N1.1 ▣ 60 D	N1.2 ■ 45 D	N1.3 ■ 30 D	N2.1 ■ 38 D	N2.2 ■ 35 D	N2.3 ■ 25 D	N3.1 ■ 64 E	N3.2 ■ 38 E	N3.3 ▣ 19 E	N4.1 ▣ 35 C	N4.2 ▣ 30 C		

DCON MS passing h9; VHM snijkanten.

Product	DC (mm)	OAL (mm)	LCF (mm)	LB (mm)	NOF	DCON MS (mm)
B44110.0	10.00	133.0	19.0	87.00	6	10.00
B44111.0	11.00	142.0	19.0	96.00	6	10.00
B44112.0	12.00	151.0	19.0	105.00	6	10.00
B44113.0	13.00	151.0	19.0	105.00	6	10.00
B44114.0	14.00	160.0	19.0	110.00	6	12.50
B44115.0	15.00	162.0	19.0	112.00	6	12.50
B44116.0	16.00	170.0	22.0	120.00	6	12.50
B44117.0	17.00	175.0	22.0	123.00	6	14.00
B44118.0	18.00	182.0	22.0	130.00	6	14.00
B44119.0	19.00	189.0	22.0	131.00	6	16.00
B44120.0	20.00	195.0	22.0	137.00	6	16.00



B411



HM machineruimer, MC schacht, H7

De gesoldeerde hardmetalen snijkanten zorgen voor een aanzienlijke verbetering van de prestaties en een langere standtijd van het gereedschap bij het ruimen van harde en abrasieve materialen. De spiraalvormige groeven hebben een ongelijke afstand tussen de tanden, wat trillingen effectief vermindert en de symmetrie, grootte en afwerking van de gaten verbeterd.

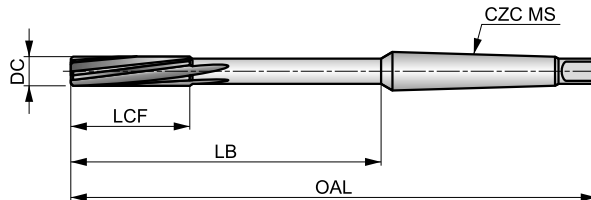

HM	Bright	DIN 8094
R		B
H7		

De tabel geeft de geschiktheid aan voor de materiaalgroep en de startwaarden voor de snijsnelheid (m/min) en de letter verwijst naar de toe te passen voeding (fn), zie vanaf pagina 251.

P1.1 ■ 23 B	P1.2 ■ 26 B	P1.3 ■ 27 B	P2.1 ■ 20 B	P2.2 ■ 18 B	P2.3 ■ 16 C	P3.1 ■ 16 B	P3.2 ■ 13 B	P3.3 ■ 11 C	P4.1 ■ 10 B	P4.2 ■ 8 C	P4.3 ■ 7 C	M1.1 ■ 10 C	M1.2 ■ 8 C
M2.1 ■ 19 C	M2.2 ■ 17 C	M2.3 ■ 16 B	K1.1 ■ 20 D	K1.2 ■ 15 D	K1.3 ■ 11 D	K2.1 ■ 21 D	K2.2 ■ 17 D	K2.3 ■ 14 D	K3.1 ■ 18 D	K3.2 ■ 14 D	K3.3 ■ 11 D	K5.1 ■ 19 D	K5.2 ■ 15 D
K5.3 ■ 11 D	N1.1 ■ 60 D	N1.2 ■ 45 D	N1.3 ■ 30 D	N2.1 ■ 38 D	N2.2 ■ 35 D	N2.3 ■ 25 D	N3.1 ■ 64 E	N3.2 ■ 38 E	N3.3 ■ 19 E	N4.1 ■ 35 C	N4.2 ■ 30 C		

DC <= 16mm VHM kop; DC > 16mm VHM snijkanten.

Product	DC (mm)	OAL (mm)	LCF (mm)	LB (mm)	NOF	CZC MS
B4115.0	5.00	133.0	23.0	67.50	6	MK 1
B4116.0	6.00	138.0	26.0	72.50	6	MK 1
B4117.0	7.00	150.0	31.0	84.50	6	MK 1
B4118.0	8.00	156.0	33.0	90.50	6	MK 1
B4119.0	9.00	162.0	36.0	96.50	6	MK 1
B41110.0	10.00	168.0	38.0	102.50	6	MK 1
B41112.0	12.00	182.0	44.0	116.50	6	MK 1
B41114.0	14.00	189.0	47.0	123.50	8	MK 1
B41115.0	15.00	204.0	50.0	124.00	8	MK 2
B41116.0	16.00	210.0	52.0	130.00	8	MK 2
B41117.0	17.00	214.0	54.0	134.00	6	MK 2
B41118.0	18.00	219.0	56.0	139.00	6	MK 2
B41119.0	19.00	223.0	58.0	143.00	6	MK 2
B41120.0	20.00	228.0	60.0	148.00	6	MK 2
B41122.0	22.00	237.0	64.0	157.00	6	MK 2
B41124.0	24.00	268.0	68.0	169.00	8	MK 3
B41125.0	25.00	268.0	68.0	169.00	8	MK 3
B41126.0	26.00	273.0	70.0	174.00	8	MK 3
B41130.0	30.00	281.0	73.0	182.00	8	MK 3



B442



HM machineruimer, MC schacht, H7

Ontworpen met extreem ongelijke verdeelde groeven om trillingen te verminderen en de diameter, rondheid en oppervlakteafwerking van de gaten te verbeteren. De 45° afschuining zorgt voor een precieze plaatsing en centering voor een betere kwaliteit en prestatie van de gaten. De gesoldeerde hardmetalen punt zorgt voor een langere standtijd en uitstekende prestaties.

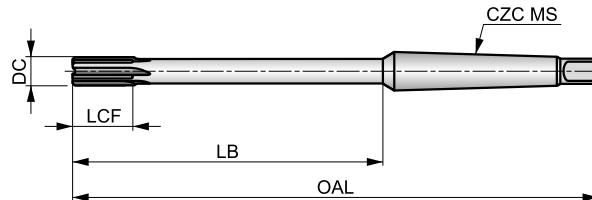

HM	Bright	DIN 8051
R		A
H7		

De tabel geeft de geschiktheid aan voor de materiaalgroep en de startwaarden voor de snijsnelheid (m/min) en de letter verwijst naar de toe te passen voeding (fn), zie vanaf pagina 251.

P1.1 ■ 23 B	P1.2 ■ 26 B	P1.3 ■ 27 B	P2.1 ■ 20 B	P2.2 ■ 18 B	P2.3 ■ 16 C	P3.1 ■ 16 B	P3.2 ■ 13 B	P3.3 ■ 11 C	P4.1 ■ 10 B	P4.2 ■ 8 C	P4.3 ■ 7 C	M1.1 ▣ 10 C	M1.2 ▣ 8 C
M2.1 ▣ 9 C	M2.2 ▣ 7 C	M2.3 ▣ 6 B	K1.1 ■ 20 D	K1.2 ■ 15 D	K1.3 ■ 11 D	K2.1 ■ 21 D	K2.2 ■ 17 D	K2.3 ■ 14 D	K3.1 ■ 18 D	K3.2 ■ 14 D	K3.3 ■ 11 D	K5.1 ■ 19 D	K5.2 ■ 15 D
K5.3 ■ 11 D	N1.1 ▣ 60 D	N1.2 ■ 45 D	N1.3 ■ 30 D	N2.1 ■ 38 D	N2.2 ■ 35 D	N2.3 ■ 25 D	N3.1 ■ 64 E	N3.2 ■ 38 E	N3.3 ▣ 19 E	N4.1 ▣ 35 C	N4.2 ▣ 30 C		

Product	DC (mm)	OAL (mm)	LCF (mm)	LB (mm)	NOF	CZC MS
B44210.0	10.00	168.0	19.0	102.50	6	MK 1
B44212.0	12.00	182.0	19.0	116.50	6	MK 1
B44214.0	14.00	189.0	19.0	123.50	6	MK 1
B44215.0	15.00	204.0	19.0	124.00	6	MK 2
B44216.0	16.00	210.0	22.0	130.00	6	MK 2
B44217.0	17.00	214.0	22.0	134.00	6	MK 2
B44218.0	18.00	219.0	22.0	139.00	6	MK 2
B44219.0	19.00	223.0	22.0	143.00	6	MK 2
B44220.0	20.00	228.0	22.0	148.00	6	MK 2



B100



HSS handruimer, cilindrische schacht, H7

Voornamelijk ontworpen voor ruimen met de hand. Met een nauwkeurig geslepen, linkse spiraal met rechtse (met de wijzers van de klok mee) snede voor soepel ruimen, waardoor een nauwkeurige diameter en een goede oppervlakteafwerking worden verkregen. Geschikt voor het ruimen van vele materialen.

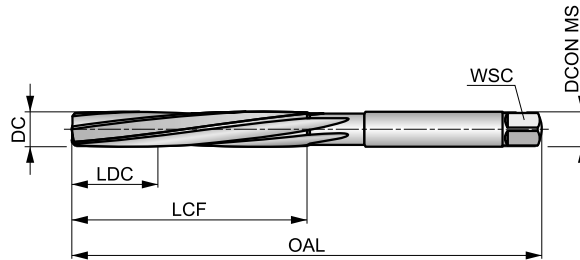

HSS	Bright ST	DIN 206
R		B
H7		

De tabel geeft de geschiktheid aan voor de materiaalgroep en de startwaarden voor de snijsnelheid (m/min) en de letter verwijst naar de toe te passen voeding (fn), zie vanaf pagina 251.

P1.1	P1.2	P1.3	P2.1	P2.2	P2.3	P3.1	P3.2	P3.3	P4.1	P4.2	P4.3	M1.1	M1.2
■	■	■	■	■	■	■	■	■	■	■	■	■	■
M2.1	K1.1	K1.2	K1.3	K2.1	K2.2	K2.3	K3.1	K3.2	N1.1	N1.2	N1.3	N2.1	N2.2
■	■	■	■	■	■	■	■	■	■	■	■	■	■
N2.3	N3.1	N3.2	N3.3	N4.1	N4.2								
■	■	■	■	■	■								

DCON MS passing e9.

Product	DC (inch)	DC (mm)	OAL (mm)	LCF (mm)	LDC (mm)	NOF	WSC (mm)	DCON MS (mm)
B1001.5	–	1.50	41.0	20.0	5.00	3	1.12	1.50
B1001/16	1/16	1.59	41.0	20.0	5.00	3	1.12	1.59
B1001.6	–	1.60	44.0	21.0	5.00	3	1.25	1.60
B1005/64	5/64	1.98	47.0	23.0	6.00	4	1.40	1.98
B1002.0	–	2.00	50.0	25.0	6.00	4	1.60	2.00
B1003/32	3/32	2.38	54.0	27.0	7.00	4	1.80	2.38
B1002.5	–	2.50	58.0	29.0	7.00	4	2.10	2.50
B1007/64	7/64	2.78	62.0	31.0	8.00	6	2.10	2.78
B1003.0	–	3.00	62.0	31.0	8.00	6	2.40	3.00
B1001/8	1/8	3.18	66.0	33.0	8.00	6	2.40	3.18
B1003.2	–	3.20	66.0	33.0	8.00	6	2.40	3.20
B1003.5	–	3.50	71.0	35.0	9.00	6	2.70	3.50
B1009/64	9/64	3.57	71.0	35.0	9.00	6	2.70	3.57
B1005/32	5/32	3.97	76.0	38.0	10.00	6	3.00	3.97
B1004.0	–	4.00	76.0	38.0	10.00	6	3.00	4.00
B10011/64	11/64	4.37	81.0	41.0	10.00	6	3.40	4.37
B1004.5	–	4.50	81.0	41.0	10.00	6	3.40	4.50
B1003/16	3/16	4.76	87.0	44.0	11.00	6	3.80	4.76
B1005.0	–	5.00	87.0	44.0	11.00	6	3.80	5.00
B10013/64	13/64	5.16	87.0	44.0	11.00	6	3.80	5.16
B1005.5	–	5.50	93.0	47.0	12.00	6	4.30	5.50
B1007/32	7/32	5.56	93.0	47.0	12.00	6	4.30	5.56
B10015/64	15/64	5.95	93.0	47.0	12.00	6	4.90	5.95
B1006.0	–	6.00	93.0	47.0	12.00	6	4.90	6.00
B1001/4	1/4	6.35	100.0	50.0	13.00	6	4.90	6.35
B1006.5	–	6.50	100.0	50.0	13.00	6	4.90	6.50
B10017/64	17/64	6.75	107.0	54.0	14.00	6	5.50	6.75



Product	DC	DC	OAL	LCF	LDC	NOF	WSC	DCON MS
	(inch)	(mm)	(mm)	(mm)	(mm)		(mm)	(mm)
B1007.0	–	7.00	107.0	54.0	14.00	6	5.50	7.00
B1009/32	9/32	7.14	107.0	54.0	14.00	6	6.20	7.14
B1007.5	–	7.50	107.0	54.0	14.00	6	6.20	7.50
B10019/64	19/64	7.54	115.0	58.0	15.00	6	6.20	7.54
B1005/16	5/16	7.94	115.0	58.0	15.00	6	6.20	7.94
B1008.0	–	8.00	115.0	58.0	15.00	6	6.20	8.00
B10021/64	21/64	8.33	115.0	58.0	15.00	6	7.00	8.33
B1008.5	–	8.50	115.0	58.0	15.00	6	7.00	8.50
B10011/32	11/32	8.73	124.0	62.0	16.00	6	7.00	8.73
B1009.0	–	9.00	124.0	62.0	16.00	6	7.00	9.00
B10023/64	23/64	9.13	124.0	62.0	16.00	6	8.00	9.13
B1009.5	–	9.50	124.0	62.0	16.00	6	8.00	9.50
B1003/8	3/8	9.52	124.0	62.0	17.00	6	8.00	9.52
B10025/64	25/64	9.92	133.0	66.0	17.00	6	8.00	9.92
B10010.0	–	10.00	133.0	66.0	17.00	6	8.00	10.00
B10013/32	13/32	10.32	133.0	66.0	17.00	6	8.00	10.32
B10010.5	–	10.50	133.0	66.0	17.00	6	8.00	10.50
B10011.0	–	11.00	142.0	71.0	18.00	6	9.00	11.00
B1007/16	7/16	11.11	142.0	71.0	18.00	6	9.00	11.11
B10011.5	–	11.50	142.0	71.0	18.00	6	9.00	11.50
B10012.0	–	12.00	152.0	76.0	19.00	6	9.00	12.00
B10012.5	–	12.50	152.0	76.0	19.00	6	10.00	12.50
B1001/2	1/2	12.70	152.0	76.0	19.00	6	10.00	12.70
B10013.0	–	13.00	152.0	76.0	19.00	6	10.00	13.00
B10017/32	17/32	13.49	163.0	81.0	20.00	8	11.00	13.49
B10013.5	–	13.50	163.0	81.0	20.00	8	11.00	13.50
B10014.0	–	14.00	163.0	81.0	20.00	8	11.00	14.00
B1009/16	9/16	14.29	163.0	81.0	20.00	8	11.00	14.29
B10014.5	–	14.50	163.0	81.0	20.00	8	11.00	14.50
B10015.0	–	15.00	163.0	81.0	20.00	8	12.00	15.00
B10019/32	19/32	15.08	163.0	81.0	22.00	8	12.00	15.08
B1005/8	5/8	15.88	175.0	87.0	22.00	8	12.00	15.88
B10016.0	–	16.00	175.0	87.0	22.00	8	12.00	16.00
B10017.0	–	17.00	175.0	87.0	22.00	8	13.00	17.00
B10011/16	11/16	17.46	188.0	93.0	23.00	8	14.50	17.46
B10018.0	–	18.00	188.0	93.0	23.00	8	14.50	18.00
B10019.0	–	19.00	188.0	93.0	23.00	8	14.50	19.00
B1003/4	3/4	19.05	188.0	93.0	25.00	8	14.50	19.05
B10020.0	–	20.00	201.0	100.0	25.00	8	16.00	20.00
B10013/16	13/16	20.64	201.0	100.0	25.00	8	16.00	20.64
B10021.0	–	21.00	201.0	100.0	25.00	8	16.00	21.00
B10022.0	–	22.00	215.0	107.0	27.00	8	18.00	22.00
B1007/8	7/8	22.22	215.0	107.0	27.00	8	18.00	22.22
B10023.0	–	23.00	215.0	107.0	27.00	8	18.00	23.00
B10024.0	–	24.00	231.0	115.0	29.00	8	18.00	24.00
B10025.0	–	25.00	231.0	115.0	29.00	8	20.00	25.00
B1001	1"	25.40	231.0	115.0	29.00	8	20.00	25.40
B10026.0	–	26.00	231.0	115.0	29.00	8	20.00	26.00
B10027.0	–	27.00	247.0	124.0	31.00	10	22.00	27.00
B10028.0	–	28.00	247.0	124.0	31.00	10	22.00	28.00
B10029.0	–	29.00	247.0	124.0	31.00	10	22.00	29.00
B10030.0	–	30.00	247.0	124.0	31.00	10	24.00	30.00
B10031.0	–	31.00	265.0	133.0	33.00	10	24.00	31.00
B10032.0	–	32.00	265.0	133.0	33.00	10	24.00	32.00
B10033.0	–	33.00	265.0	133.0	33.00	10	26.00	33.00
B10034.0	–	34.00	284.0	142.0	36.00	10	26.00	34.00
B10035.0	–	35.00	284.0	142.0	36.00	10	29.00	35.00
B10036.0	–	36.00	284.0	142.0	36.00	10	29.00	36.00
B10037.0	–	37.00	284.0	142.0	36.00	10	29.00	37.00
B10038.0	–	38.00	305.0	152.0	38.00	10	29.00	38.00
B10039.0	–	39.00	305.0	152.0	38.00	10	32.00	39.00
B10040.0	–	40.00	305.0	152.0	38.00	10	32.00	40.00
B10045.0	–	45.00	326.0	163.0	41.00	12	35.00	45.00
B10050.0	–	50.00	347.0	174.0	44.00	12	39.00	50.00



B334



HSS verstelbare handruimer

Deze handruimer is gemakkelijk aan te passen, zodat met één ruimer vele gaten met verschillende diameters kunnen worden gemaakt. Dankzij de nauwkeurig geslepen messen en de rechte spaangroeven gaat het ruimen soepel en worden de diameter en de oppervlakteafwerking van de gaten verbeterd. Geschikt voor ruimen in vele materialen.

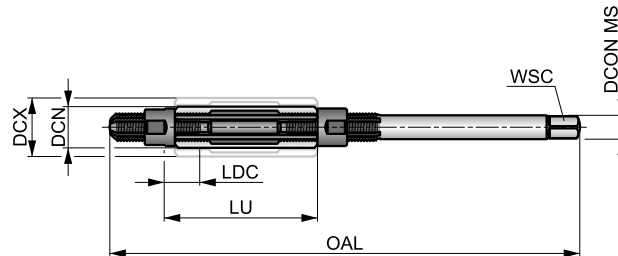

De tabel geeft de geschiktheid aan voor de materiaalgroep en de startwaarden voor de snijsnelheid (m/min) en de letter verwijst naar de toe te passen voeding (fn), zie vanaf pagina 251.

P1.1	P1.2	P1.3	P2.1	P2.2	P2.3	P3.1	P3.2	P3.3	P4.1	P4.2	P4.3	M1.1	M1.2
■	■	■	■	■	■	■	■	■	■	■	■	■	■
M2.1	K1.1	K1.2	K1.3	K2.1	K2.2	K2.3	K3.1	K3.2	N1.1	N1.2	N1.3	N2.1	N2.2
■	■	■	■	■	■	■	■	■	■	■	■	■	■
N2.3	N3.1	N3.2	N3.3	N4.1	N4.2								
■	■	■	■	■	■								

Product	Nr.	DCN	DCX	OAL	LU	LDC	NOF	WSC
		(mm)	(mm)	(mm)	(mm)	(mm)		
B334000	000	6.40	7.20	110.0	32.00	7.00	4	3.00
B33400	00	7.20	8.00	110.0	32.00	7.00	4	3.40
B3340	0	8.00	9.00	115.0	34.00	9.00	5	3.80
B3341	1	9.00	10.00	115.0	34.00	9.00	5	4.30
B3342	2	10.00	11.00	115.0	34.00	9.00	5	4.90
B3343	3	11.00	12.00	125.0	35.00	9.00	5	4.90
B3344	4	12.00	13.50	135.0	41.00	9.00	5	6.20
B3345	5	13.50	15.50	146.0	50.00	12.00	5	7.00
B3346	6	15.50	18.00	166.0	60.00	12.00	5	8.00
B3347	7	18.00	21.00	178.0	65.00	15.00	5	9.00
B3348	8	21.00	24.00	195.0	76.00	15.00	5	11.00
B3349	9	24.00	27.50	218.0	82.00	18.00	5	12.00
B33410	10	27.50	31.50	245.0	86.00	18.00	5	14.50
B33411	11	31.50	37.00	280.0	98.00	18.00	6	18.00
B33412	12	37.00	45.00	325.0	108.00	20.00	6	20.00
B33413	13	45.00	55.00	370.0	118.00	20.00	6	26.00
B33414	14	55.00	67.00	400.0	125.00	20.00	6	32.00
B33415	15	67.00	80.00	435.0	140.00	23.00	8	39.00
B33416	16	80.00	95.00	475.0	155.00	23.00	8	49.00



B335

DORMER



Onderdelen, messen en moeren, voor B334 verstelbare ruimer

De moer en de messen kunnen afzonderlijk worden aangekocht en zijn elk verkrijgbaar in 19 maten.

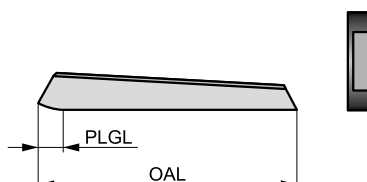

Product	Nr.	PLGL	OAL
		(mm)	(mm)
B335000BLADES	000	7.00	32.0
B335000NUT	000	–	–
B33500BLADES	00	7.00	32.0
B33500NUT	00	–	–
B3350BLADES	0	9.00	34.0
B3350NUT	0	–	–
B3351BLADES	1	9.00	34.0
B3351NUT	1	–	–
B3352BLADES	2	9.00	34.0
B3352NUT	2	–	–
B3353BLADES	3	9.00	35.0
B3353NUT	3	–	–
B3354BLADES	4	9.00	41.0
B3354NUT	4	–	–
B3355BLADES	5	12.00	50.0
B3355NUT	5	–	–
B3356BLADES	6	12.00	60.0
B3356NUT	6	–	–
B3357BLADES	7	15.00	65.0

Product	Nr.	PLGL	OAL
		(mm)	(mm)
B3357NUT	7	–	–
B3358BLADES	8	15.00	76.0
B3358NUT	8	–	–
B3359BLADES	9	18.00	82.0
B3359NUT	9	–	–
B33510BLADES	10	18.00	86.0
B33510NUT	10	–	–
B33511BLADES	11	18.00	98.0
B33511NUT	11	–	–
B33512BLADES	12	20.00	108.0
B33512NUT	12	–	–
B33513BLADES	13	20.00	118.0
B33513NUT	13	–	–
B33514BLADES	14	20.00	125.0
B33514NUT	14	–	–
B33515BLADES	15	23.00	140.0
B33515NUT	15	–	–
B33516BLADES	16	23.00	155.0
B33516NUT	16	–	–



B901



HSS-E machineruimer, cilindrische schacht, H7

Machineruimer met nauwkeurig geslepen geometrie, met linkse spiraal en rechts snijdend, verbetert de diameterkwaliteit van de gaten en de oppervlakteafwerking. De ruimer heeft een rechte schacht voor machinaal ruimen met hoge prestaties. Geschikt voor ruimen in vele materialen.

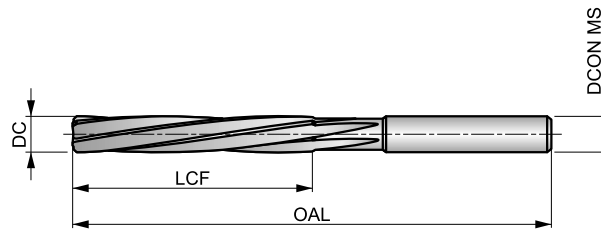

HSS-E	Bright ST	BS 328
R		B
H7		

De tabel geeft de geschiktheid aan voor de materiaalgroep en de startwaarden voor de snijsnelheid (m/min) en de letter verwijst naar de toe te passen voeding (fn), zie vanaf pagina 251.

P1.1 ■ 15 C	P1.2 ■ 16 C	P1.3 ■ 17 C	P2.1 ■ 13 C	P2.2 ■ 11 C	P2.3 ▧ 10 B	P3.1 ■ 7 B	P3.2 ■ 6 B	P3.3 ▧ 5 B	P4.1 ■ 4 B	P4.2 ▧ 4 B	P4.3 ▧ 3 A	M1.1 ▧ 10 C	M1.2 ▧ 8 C
M2.1 ▧ 9 C	K1.1 ■ 14 E	K1.2 ■ 10 D	K1.3 ▧ 8 D	K2.1 ■ 12 C	K2.2 ■ 10 C	K2.3 ▧ 8 C	K3.1 ▧ 11 C	K3.2 ▧ 8 C	N1.1 ▧ 23 F	N1.2 ■ 17 F	N1.3 ■ 12 F	N2.1 ■ 25 E	N2.2 ■ 22 E
N2.3 ▧ 14 E	N3.1 ■ 34 D	N3.2 ■ 20 E	N3.3 ■ 10 D	N4.1 ▧ 22 B	N4.2 ▧ 21 B								

Product	DC (inch)	DC (mm)	OAL (mm)	LCF (mm)	NOF	DCON MS (mm)
B9011.5	–	1.50	44.0	21.0	4	1.50
B9011/16	1/16	1.59	44.0	21.0	4	1.59
B9012.0	–	2.00	50.0	25.0	4	2.00
B9013/32	3/32	2.38	58.0	29.0	4	2.38
B9012.5	–	2.50	58.0	29.0	4	2.50
B9013.0	–	3.00	62.0	31.0	4	3.00
B9011/8	1/8	3.18	66.0	33.0	4	3.18
B9013.5	–	3.50	71.0	35.0	4	3.50
B9015/32	5/32	3.97	76.0	38.0	6	3.97
B9014.0	–	4.00	76.0	38.0	6	4.00
B9014.5	–	4.50	81.0	41.0	6	4.50
B9013/16	3/16	4.76	87.0	44.0	6	4.76
B9015.0	–	5.00	87.0	44.0	6	5.00
B90113/64	13/64	5.16	87.0	44.0	6	5.16
B9015.5	–	5.50	93.0	47.0	6	5.50

Product	DC (inch)	DC (mm)	OAL (mm)	LCF (mm)	NOF	DCON MS (mm)
B9017/32	7/32	5.56	93.0	47.0	6	5.56
B90115/64	15/64	5.95	93.0	47.0	6	5.95
B9016.0	–	6.00	93.0	47.0	6	6.00
B9011/4	1/4	6.35	100.0	50.0	6	6.35
B9017.0	–	7.00	107.0	54.0	6	7.00
B9019/32	9/32	7.14	107.0	54.0	6	7.14
B9015/16	5/16	7.94	115.0	58.0	6	7.94
B9018.0	–	8.00	115.0	58.0	6	8.00
B9019.0	–	9.00	124.0	62.0	6	9.00
B9013/8	3/8	9.52	133.0	66.0	6	9.52
B90110.0	–	10.00	133.0	66.0	6	10.00
B90111.0	–	11.00	142.0	71.0	6	11.00
B9017/16	7/16	11.11	142.0	71.0	6	11.11
B90112.0	–	12.00	152.0	76.0	6	12.00
B9011/2	1/2	12.70	152.0	76.0	6	12.70



B301



HSS conische pengatruimer, 1:48

Ontworpen voor het afwerken van conische gaten voor de opname van standaard imperiale conische pennen met een coniciteit van 1 op 48. Dankzij de conische aansnijding kan het gereedschap gemakkelijk worden gepositioneerd en gecentreerd in het voorgeboorde gat voor meer nauwkeurigheid en betere prestaties. Geschikt voor ruimen in vele materialen.

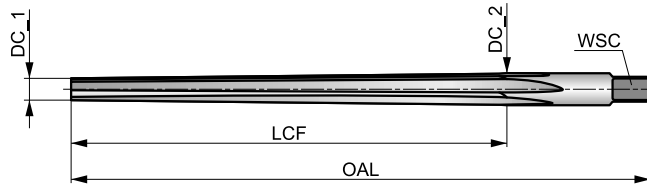

HSS	Bright ST	BS 328
R		A
1:48		

De tabel geeft de geschiktheid aan voor de materiaalgroep en de startwaarden voor de snijsnelheid (m/min) en de letter verwijst naar de toe te passen voeding (fn), zie vanaf pagina 251.

P1.1	P1.2	P1.3	P2.1	P2.2	P2.3	P3.1	P3.2	P3.3	P4.1	P4.2	P4.3	M1.1	M1.2
■	■	■	■	■	■	■	■	■	■	■	■	■	■
M2.1	K1.1	K1.2	K1.3	K2.1	K2.2	K2.3	K3.1	K3.2	N1.1	N1.2	N1.3	N2.1	N2.2
■	■	■	■	■	■	■	■	■	■	■	■	■	■
N2.3	N3.1	N3.2	N3.3	N4.1	N4.2								
■	■	■	■	■	■								

DC <= 1/4 bovengrens tolerantie +0.0030; DC >= 9/32 tolerantie +0.0050.

Product	nom d	DC_1	DC_2	OAL	LCF	NOF	WSC	DCON MS
		(mm)	(mm)	(mm)	(mm)		(mm)	(mm)
B3011/16	1/16	1.10	1.63	51.0	25.0	4	1.20	1.63
B3015/64	5/64	1.50	2.03	51.0	25.0	4	1.60	2.03
B3013/32	3/32	1.75	2.41	57.0	32.0	4	2.00	2.41
B3017/64	7/64	2.03	2.82	64.0	38.0	4	2.20	2.82
B3011/8	1/8	2.30	3.23	70.0	44.0	4	2.50	3.23
B3019/64	9/64	2.64	3.63	73.0	48.0	4	2.80	3.63
B3015/32	5/32	2.95	4.01	76.0	51.0	4	3.10	4.01
B30111/64	11/64	3.23	4.42	89.0	57.0	4	3.60	4.42
B3013/16	3/16	3.50	4.95	102.0	70.0	4	4.00	4.95
B3017/32	7/32	4.13	5.59	102.0	70.0	6	4.50	5.59
B3011/4	1/4	4.64	6.43	117.0	86.0	6	5.00	6.43
B3019/32	9/32	5.23	7.42	143.0	105.0	6	5.60	7.42
B3015/16	5/16	5.84	8.03	143.0	105.0	6	6.30	8.03
B30111/32	11/32	6.43	8.81	152.0	114.0	6	7.10	8.81
B3013/8	3/8	7.03	9.68	165.0	127.0	6	8.00	9.68
B30113/32	13/32	7.42	10.46	191.0	146.0	6	8.00	10.46
B3017/16	7/16	8.21	11.25	191.0	146.0	6	9.00	11.25
B3011/2	1/2	9.41	12.85	210.0	165.0	6	10.00	12.85



B903



HSS conische pengat-handruimer, 1:50

Ontworpen voor het afwerken van conische gaten voor de opname van standaard metrische conische pennen met een coniciteit van 1 op 50. Dankzij de conische aansnijding kan het gereedschap gemakkelijk worden gepositioneerd en gecentreerd in het voorgeboorde gat voor meer nauwkeurigheid en betere prestaties. Geschikt voor ruimen in vele materialen.

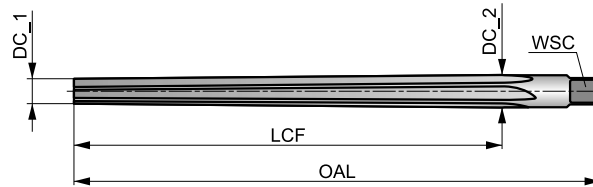

HSS	Bright ST	DIN 9
R		A
1:50		

De tabel geeft de geschiktheid aan voor de materiaalgroep en de startwaarden voor de snijsnelheid (m/min) en de letter verwijst naar de toe te passen voeding (fn), zie vanaf pagina 251.

P1.1	P1.2	P1.3	P2.1	P2.2	P2.3	P3.1	P3.2	P3.3	P4.1	P4.2	P4.3	M1.1	M1.2
■	■	■	■	■	■	■	■	■	■	■	■	■	■
M2.1	K1.1	K1.2	K1.3	K2.1	K2.2	K2.3	K3.1	K3.2	N1.1	N1.2	N1.3	N2.1	N2.2
■	■	■	■	■	■	■	■	■	■	■	■	■	■
N2.3	N3.1	N3.2	N3.3	N4.1	N4.2								
■	■	■	■	■	■								

DCON MS passing h11; DC <= 5mm tolerantie +0.0750; DC < 5mm tolerantie +0.1250.

Product	nom d	DC_1	DC_2	OAL	LCF	NOF	WSC	DCON MS
		(mm)	(mm)					
B9031.5	1.5	1.40	2.14	57.0	37.0	4	1.80	2.14
B9032.0	2.0	1.90	2.86	68.0	48.0	4	2.24	2.86
B9032.5	2.5	2.40	3.36	68.0	48.0	4	2.80	3.36
B9033.0	3.0	2.90	4.06	80.0	58.0	4	3.15	4.00
B9034.0	4.0	3.90	5.26	93.0	68.0	4	4.00	5.00
B9035.0	5.0	4.90	6.36	100.0	73.0	4	5.00	6.30
B9036.0	6.0	5.90	8.00	135.0	105.0	6	6.30	7.90
B9038.0	8.0	7.90	10.80	180.0	145.0	6	8.00	10.50
B90310.0	10.0	9.90	13.40	215.0	175.0	6	10.00	13.30
B90312.0	12.0	11.80	16.00	255.0	210.0	8	11.20	16.00
B90313.0	13.0	12.86	16.74	255.0	210.0	8	12.50	16.74
B90314.0	14.0	13.86	17.74	255.0	210.0	8	12.50	17.74
B90316.0	16.0	15.80	20.40	280.0	230.0	8	14.00	20.40
B90320.0	20.0	19.80	24.80	310.0	250.0	8	18.00	24.80



B952



HSS conische pengat-handruimer, 1:50

Met linkse spiraal en rechts snijdend, voor soepel ruimen met een nauwkeuriger diameter en betere afwerking. De conische aansnijding maakt het gemakkelijker om de ruimer in het gat te plaatsen en te centreren. Geschikt voor ruimen in vele materialen.

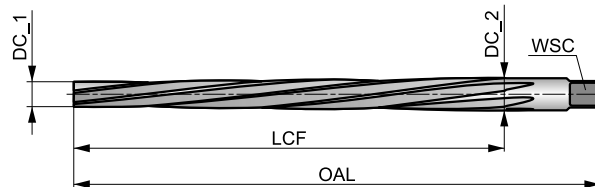

HSS	Bright	DIN 9
R		B
1:50		

De tabel geeft de geschiktheid aan voor de materiaalgroep en de startwaarden voor de snijsnelheid (m/min) en de letter verwijst naar de toe te passen voeding (fn), zie vanaf pagina 251.

P1.1	P1.2	P1.3	P2.1	P2.2	P2.3	P3.1	P3.2	P3.3	P4.1	P4.2	P4.3	M1.1	M1.2
■	■	■	■	■	■	■	■	■	■	■	■	■	■
M2.1	K1.1	K1.2	K1.3	K2.1	K2.2	K2.3	K3.1	K3.2	N1.1	N1.2	N1.3	N2.1	N2.2
■	■	■	■	■	■	■	■	■	■	■	■	■	■
N2.3	N3.1	N3.2	N3.3	N4.1	N4.2								
■	■	■	■	■	■								

DCON MS passing h11; DC <= 2.5mm rechte spaangroeven, vorm A.

Product	nom d	DC_1	DC_2	OAL	LCF	NOF	WSC	DCON MS
		(mm)	(mm)	(mm)	(mm)		(mm)	(mm)
B9521.2	1.2	1.10	1.74	50.0	32.0	3	2.40	3.15
B9521.5	1.5	1.40	2.14	57.0	37.0	3	2.40	3.15
B9522.0	2.0	1.90	2.86	68.0	48.0	3	2.40	3.15
B9522.5	2.5	2.40	3.36	68.0	48.0	4	2.40	3.15
B9523.0	3.0	2.90	4.06	80.0	58.0	5	3.00	4.00
B9523.5	3.5	3.40	4.66	87.0	63.0	5	3.40	4.50
B9524.0	4.0	3.90	5.26	93.0	68.0	5	3.80	5.00
B9524.5	4.5	4.40	5.80	95.0	70.0	5	4.30	5.60
B9525.0	5.0	4.90	6.36	100.0	73.0	5	4.90	6.30
B9525.5	5.5	5.40	7.20	118.0	90.0	6	5.50	7.10
B9526.0	6.0	5.90	8.00	135.0	105.0	6	6.20	8.00
B9526.5	6.5	6.40	8.60	140.0	110.0	6	6.20	8.00
B9527.0	7.0	6.90	9.40	160.0	125.0	6	7.00	9.00
B9528.0	8.0	7.90	10.80	180.0	145.0	6	8.00	10.00
B9529.0	9.0	8.90	12.10	195.0	160.0	6	9.00	11.20
B95210.0	10.0	9.90	13.40	215.0	175.0	6	10.00	12.50
B95212.0	12.0	11.80	16.00	255.0	210.0	8	11.00	14.00
B95213.0	13.0	12.80	17.00	255.0	210.0	8	12.00	16.00
B95214.0	14.0	13.80	18.00	255.0	210.0	8	12.00	16.00
B95216.0	16.0	15.80	20.40	280.0	230.0	8	14.50	18.00
B95220.0	20.0	19.80	24.80	310.0	250.0	8	18.00	22.40
B95225.0	25.0	24.70	30.70	370.0	300.0	10	22.00	28.00
B95230.0	30.0	29.70	36.10	400.0	320.0	10	24.00	31.50
B95240.0	40.0	39.70	46.50	430.0	340.0	12	32.00	40.00
B95250.0	50.0	49.70	56.90	460.0	360.0	12	39.00	50.00



B122



HSS carrosserieruimer, gereduceerde schacht, stoomontlaten/bronskleurig

Ontworpen voor het uitlijnen van dunwandige plaatmaterialen voorafgaand aan het verbinden door bouten of klingenagels. De conische voorsnijder maakt het lokaliseren en in lijn brengen van voorgeboorde gaten makkelijker. Geschikt voor vele materialen.

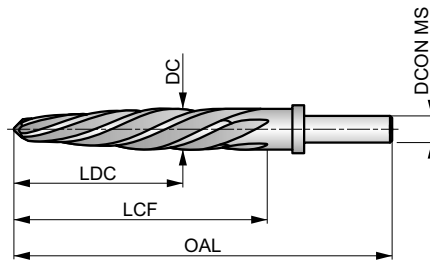

HSS	ST Bronze	ANSI
R		

De tabel geeft de geschiktheid aan voor de materiaalgroep en de startwaarden voor de snijsnelheid (m/min) en de letter verwijst naar de toe te passen voeding (fn), zie vanaf pagina 251.

P1.1 ■ 15 C	P1.2 ■ 16 C	P1.3 ■ 17 C	P2.1 ■ 13 C	P2.2 ■ 11 C	P3.1 ■ 7 B	M1.1 ■ 11 C	M1.2 ■ 10 B	M2.1 ■ 9 B	N1.1 ■ 23 F	N1.2 ■ 17 F	N2.1 ■ 23 E	N2.2 ■ 21 E	N3.1 ■ 34 D
N3.2 ■ 20 E	N4.1 ■ 22 B	N4.2 ■ 21 B											

Product	DC (inch)	DC (inch)	OAL (inch)	LCF (inch)	NOF	DCONMS (inch)
B1223/8	3/8	0.3750	4.5/8	2.1/2	4	3/8
B1221/2	1/2	0.5000	5.7/8	3.3/4	5	1/2
B1229/16	9/16	0.5625	5.7/8	3.3/4	5	1/2
B1225/8	5/8	0.6250	6.3/8	4.1/4	5	1/2
B12211/16	11/16	0.6875	6.3/8	4.1/4	5	1/2
B1223/4	3/4	0.7500	6.7/8	4.1/2	5	1/2
B12213/16	13/16	0.8125	6.7/8	4.1/2	5	1/2
B1227/8	7/8	0.8750	6.7/8	4.1/2	5	1/2
B12215/16	15/16	0.9375	6.7/8	4.1/2	5	1/2
B1221	1"	1.0000	6.7/8	4.1/2	5	1/2
B1221.1/16	1.1/16	1.0625	6.7/8	4.1/2	5	1/2



B953



HSS-E conische machine-schilruimer, 1:50

Met extra sterk links gespiraliseerd en rechts snijdend, voor soepel ruimen met een nauwkeuriger diameter en betere afwerking. De conische aansnijding maakt het gemakkelijker om de ruimer in het gat te plaatsen en te centreren. Geschikt voor ruimen in vele materialen.

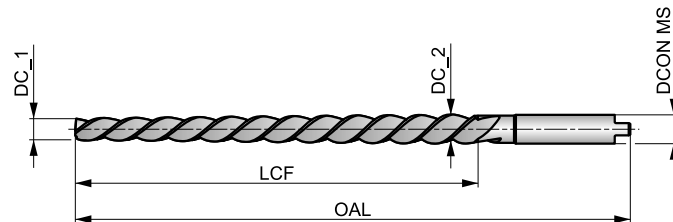

HSS-E	Bright	DIN 2179
R		1:50

De tabel geeft de geschiktheid aan voor de materiaalgroep en de startwaarden voor de snijsnelheid (m/min) en de letter verwijst naar de toe te passen voeding (fn), zie vanaf pagina 251.

P1.1 ■ 10 B	P1.2 ■ 12 B	P1.3 ■ 13 B	P2.1 ■ 9 B	P2.2 ■ 8 B	P2.3 ▣ 6 A	P3.1 ■ 7 A	P3.2 ▣ 6 A	P3.3 ▣ 3 A	P4.1 ■ 4 A	P4.2 ▣ 3 A	P4.3 ▣ 2 A	M1.1 ▣ 11 C	M1.2 ▣ 10 B
M2.1 ▣ 9 B	M2.2 ▣ 8 B	K1.1 ■ 10 C	K1.2 ■ 6 B	K1.3 ▣ 4 B	K2.1 ■ 8 A	K2.2 ■ 6 A	K2.3 ▣ 4 A	K3.1 ■ 7 A	K3.2 ▣ 4 A	N1.1 ▣ 14 D	N1.2 ■ 12 D	N1.3 ■ 9 D	N2.1 ■ 16 C
N2.2 ■ 14 C	N2.3 ▣ 10 C	N3.1 ■ 22 B	N3.2 ■ 14 C	N3.3 ▣ 6 B	N4.1 ▣ 22 B								

DCON MS passing h9.

Product	nom d	DC_1	DC_2	OAL	LCF	NOF	DCON MS
		(mm)	(mm)	(mm)	(mm)		(mm)
B9531.0	1.0	0.80	1.46	60.0	33.0	2	1.40
B9531.5	1.5	1.40	2.14	70.0	37.0	2	2.10
B9532.0	2.0	1.90	2.86	86.0	48.0	3	3.15
B9532.5	2.5	2.40	3.36	86.0	48.0	3	3.15
B9533.0	3.0	2.90	4.06	100.0	58.0	3	4.00
B9534.0	4.0	3.90	5.26	112.0	68.0	3	5.00
B9535.0	5.0	4.90	6.36	122.0	73.0	3	6.30
B9536.0	6.0	5.90	8.00	160.0	105.0	3	8.00
B9536.5	6.5	6.40	8.78	188.0	119.0	3	8.50
B9538.0	8.0	7.90	10.80	207.0	145.0	3	10.00
B95310.0	10.0	9.90	13.40	245.0	175.0	3	12.50
B95312.0	12.0	11.80	16.00	290.0	210.0	3	16.00



B180



HSS-E machineruimer, cilindrische eenheidsschacht, H7

Hoogwaardige ruimer voor CNC machines in nauwkeurige gereedschapshouders of opnames. De nauwkeurig geslepen linkse spiraal en rechte snijwerking zorgen voor soepel ruimen. Verbetert de diameter van de gaten en de oppervlakteafwerking. Geschikt voor ruimen in vele materialen.

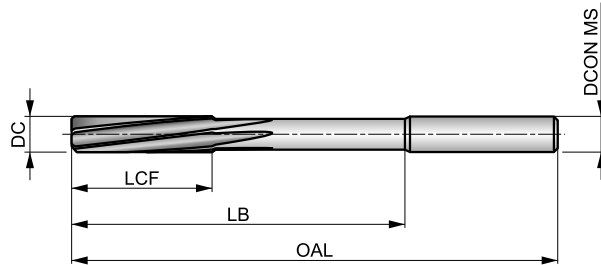

HSS-E	Bright	DIN 212
R	DIN 6535HA	B
H7		

De tabel geeft de geschiktheid aan voor de materiaalgroep en de startwaarden voor de snijsnelheid (m/min) en de letter verwijst naar de toe te passen voeding (fn), zie vanaf pagina 251.

P1.1 ■ 21 C	P1.2 ■ 24 C	P1.3 ■ 25 C	P2.1 ■ 18 C	P2.2 ■ 16 C	P2.3 ▣ 14 B	P3.1 ■ 13 B	P3.2 ■ 11 B	P3.3 ▣ 9 B	P4.1 ■ 8 B	P4.2 ▣ 7 B	P4.3 ▣ 5 A	M1.1 ▣ 11 C	M1.2 ▣ 10 B
M2.1 ▣ 9 B	K1.1 ■ 16 E	K1.2 ■ 12 D	K1.3 ▣ 9 D	K2.1 ■ 16 C	K2.2 ■ 13 C	K2.3 ▣ 10 C	K3.1 ■ 14 C	K3.2 ▣ 11 C	N1.1 ▣ 24 F	N1.2 ■ 18 F	N1.3 ■ 11 F	N2.1 ▣ 27 E	N2.2 ■ 24 E
N2.3 ■ 16 E	N3.1 ■ 47 D	N3.2 ■ 28 E	N3.3 ▣ 14 D	N4.1 ▣ 30 B									

DCON MS passing h6.

Product	DC	OAL	LCF	LB	NOF	DCON MS
	(mm)	(mm)	(mm)	(mm)		(mm)
B1801.5	1.50	40.0	8.0	18.00	3	2.00
B1801.6	1.60	43.0	9.0	20.00	3	2.00
B1801.7	1.70	43.0	9.0	20.00	3	2.00
B1801.8	1.80	46.0	10.0	22.00	4	2.00
B1801.9	1.90	46.0	10.0	22.00	4	2.00
B1802.0	2.00	49.0	11.0	24.00	4	2.00
B1802.1	2.10	49.0	11.0	24.00	4	2.00
B1802.2	2.20	53.0	12.0	26.00	4	3.00
B1802.3	2.30	53.0	12.0	26.00	4	3.00
B1802.4	2.40	57.0	14.0	28.00	4	3.00
B1802.5	2.50	57.0	14.0	28.00	4	3.00
B1802.6	2.60	57.0	14.0	28.00	4	3.00
B1802.7	2.70	61.0	15.0	32.00	6	3.00
B1802.8	2.80	61.0	15.0	32.00	6	3.00
B1802.9	2.90	61.0	15.0	32.00	6	3.00
B1803.0	3.00	61.0	15.0	32.00	6	3.00
B1803.1	3.10	65.0	16.0	35.00	6	4.00
B1803.2	3.20	65.0	16.0	35.00	6	4.00
B1803.3	3.30	65.0	16.0	35.00	6	4.00
B1803.4	3.40	70.0	18.0	40.00	6	4.00
B1803.5	3.50	70.0	18.0	40.00	6	4.00
B1803.6	3.60	70.0	18.0	40.00	6	4.00
B1803.7	3.70	70.0	18.0	40.00	6	4.00
B1803.8	3.80	75.0	19.0	43.00	6	4.00
B1803.9	3.90	75.0	19.0	43.00	6	4.00
B1804.0	4.00	75.0	19.0	43.00	6	4.00
B1804.1	4.10	75.0	19.0	43.00	6	4.00

Product	DC	OAL	LCF	LB	NOF	DCON MS
	(mm)	(mm)	(mm)	(mm)		(mm)
B1804.2	4.20	75.0	19.0	43.00	6	4.00
B1804.3	4.30	80.0	21.0	47.00	6	5.00
B1804.4	4.40	80.0	21.0	47.00	6	5.00
B1804.5	4.50	80.0	21.0	47.00	6	5.00
B1804.6	4.60	80.0	21.0	47.00	6	5.00
B1804.7	4.70	80.0	21.0	47.00	6	5.00
B1804.8	4.80	86.0	23.0	52.00	6	5.00
B1804.9	4.90	86.0	23.0	52.00	6	5.00
B1805.0	5.00	86.0	23.0	52.00	6	5.00
B1805.1	5.10	86.0	23.0	52.00	6	5.00
B1805.2	5.20	86.0	23.0	52.00	6	5.00
B1805.3	5.30	86.0	23.0	52.00	6	5.00
B1805.4	5.40	93.0	26.0	57.00	6	6.00
B1805.5	5.50	93.0	26.0	57.00	6	6.00
B1805.6	5.60	93.0	26.0	57.00	6	6.00
B1805.7	5.70	93.0	26.0	57.00	6	6.00
B1805.8	5.80	93.0	26.0	57.00	6	6.00
B1805.9	5.90	93.0	26.0	57.00	6	6.00
B1806.0	6.00	93.0	26.0	57.00	6	6.00
B1806.1	6.10	101.0	28.0	63.00	6	6.00
B1806.2	6.20	101.0	28.0	63.00	6	6.00
B1806.3	6.30	101.0	28.0	63.00	6	6.00
B1806.4	6.40	101.0	28.0	63.00	6	6.00
B1806.5	6.50	101.0	28.0	63.00	6	6.00
B1806.6	6.60	101.0	28.0	63.00	6	6.00
B1806.7	6.70	101.0	28.0	63.00	6	6.00
B1806.8	6.80	109.0	31.0	69.00	6	8.00



Product	DC	OAL	LCF	LB	NOF	DCON MS
	(mm)	(mm)	(mm)	(mm)		(mm)
B1806.9	6.90	109.0	31.0	69.00	6	8.00
B1807.0	7.00	109.0	31.0	69.00	6	8.00
B1807.1	7.10	109.0	31.0	69.00	6	8.00
B1807.2	7.20	109.0	31.0	69.00	6	8.00
B1807.3	7.30	109.0	31.0	69.00	6	8.00
B1807.4	7.40	109.0	31.0	69.00	6	8.00
B1807.5	7.50	109.0	31.0	69.00	6	8.00
B1807.6	7.60	117.0	33.0	75.00	6	8.00
B1807.7	7.70	117.0	33.0	75.00	6	8.00
B1807.8	7.80	117.0	33.0	75.00	6	8.00
B1807.9	7.90	117.0	33.0	75.00	6	8.00
B1808.0	8.00	117.0	33.0	75.00	6	8.00
B1808.1	8.10	117.0	33.0	75.00	6	8.00
B1808.2	8.20	117.0	33.0	75.00	6	8.00
B1808.3	8.30	117.0	33.0	75.00	6	8.00
B1808.4	8.40	117.0	33.0	75.00	6	8.00
B1808.5	8.50	117.0	33.0	75.00	6	8.00
B1808.6	8.60	125.0	36.0	81.00	6	10.00
B1808.7	8.70	125.0	36.0	81.00	6	10.00
B1808.8	8.80	125.0	36.0	81.00	6	10.00
B1808.9	8.90	125.0	36.0	81.00	6	10.00

Product	DC	OAL	LCF	LB	NOF	DCON MS
	(mm)	(mm)	(mm)	(mm)		(mm)
B1809.0	9.00	125.0	36.0	81.00	6	10.00
B1809.1	9.10	125.0	36.0	81.00	6	10.00
B1809.2	9.20	125.0	36.0	81.00	6	10.00
B1809.3	9.30	125.0	36.0	81.00	6	10.00
B1809.4	9.40	125.0	36.0	81.00	6	10.00
B1809.5	9.50	125.0	36.0	81.00	6	10.00
B1809.6	9.60	133.0	38.0	87.00	6	10.00
B1809.7	9.70	133.0	38.0	87.00	6	10.00
B1809.8	9.80	133.0	38.0	87.00	6	10.00
B1809.9	9.90	133.0	38.0	87.00	6	10.00
B18010.0	10.00	133.0	38.0	87.00	6	10.00
B18011.0	11.00	142.0	41.0	96.00	6	10.00
B18012.0	12.00	151.0	44.0	105.00	6	10.00
B18013.0	13.00	151.0	44.0	105.00	6	10.00
B18014.0	14.00	160.0	47.0	110.00	8	14.00
B18015.0	15.00	162.0	50.0	112.00	8	14.00
B18016.0	16.00	170.0	52.0	120.00	8	14.00
B18017.0	17.00	175.0	54.0	123.00	8	14.00
B18018.0	18.00	182.0	56.0	130.00	8	14.00
B18019.0	19.00	189.0	58.0	131.00	8	16.00
B18020.0	20.00	195.0	60.0	137.00	8	16.00



B170



HSS-E machineruimer, cilindrische schacht, 0,01mm oplopend

Verschillende incrementen stellen u in staat om nauwkeurige gatgroottes en extra gattoleranties te produceren. Met een linkse spiraal en een rechtse snijbeweging zorgt de nauwkeurig geslepen geometrie voor soepel ruimen. Verbeterd de diameter van de gaten en de oppervlakteafwerking. Geschikt voor ruimen in vele materialen.

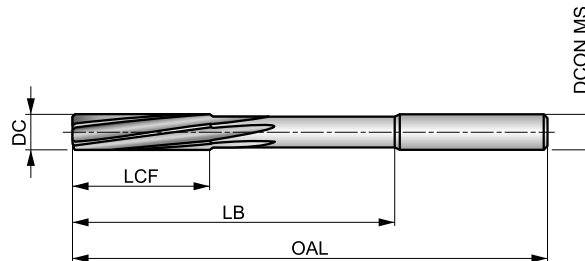

HSS-E	Bright	DIN 212
R		B
$\phi_{.95-5.5}$ $+0.004$ $\phi_{5.51-12}$ $+0.005$		

De tabel geeft de geschiktheid aan voor de materiaalgroep en de startwaarden voor de snijsnelheid (m/min) en de letter verwijst naar de toe te passen voeding (fn), zie vanaf pagina 251.

P1.1 ■ 21 C	P1.2 ■ 24 C	P1.3 ■ 25 C	P2.1 ■ 18 C	P2.2 ■ 16 C	P2.3 ■ 14 B	P3.1 ■ 13 B	P3.2 ■ 11 B	P3.3 ■ 9 B	P4.1 ■ 8 B	P4.2 ■ 7 B	P4.3 ■ 5 A	M1.1 ■ 11 C	M1.2 ■ 10 B
M2.1 ■ 9 B	K1.1 ■ 16 E	K1.2 ■ 12 D	K1.3 ■ 9 D	K2.1 ■ 16 C	K2.2 ■ 13 C	K2.3 ■ 10 C	K3.1 ■ 14 C	K3.2 ■ 11 C	N1.1 ■ 24 D	N1.2 ■ 18 F	N1.3 ■ 11 F	N2.1 ■ 27 E	N2.2 ■ 24 E
N2.3 ■ 16 E	N3.1 ■ 47 D	N3.2 ■ 28 E	N3.3 ■ 14 D	N4.1 ■ 30 B									

DCON MS passing h9.

Product	DC	OAL	LCF	LB	NOF	DCON MS
	(mm)	(mm)	(mm)	(mm)		(mm)
B170.98	0.98	34.0	5.5	15.00	3	1.00
B170.99	0.99	34.0	5.5	15.00	3	1.00
B1701.0	1.00	34.0	5.5	15.00	3	1.00
B1701.01	1.01	34.0	5.5	15.00	3	1.00
B1701.02	1.02	34.0	5.5	15.00	3	1.00
B1701.03	1.03	34.0	5.5	15.00	3	1.00
B1701.04	1.04	34.0	5.5	15.00	3	1.00
B1701.05	1.05	34.0	5.5	15.00	3	1.00
B1701.49	1.49	40.0	8.0	18.00	3	1.50
B1701.5	1.50	40.0	8.0	18.00	3	1.50
B1701.51	1.51	43.0	9.0	20.00	3	1.60
B1701.52	1.52	43.0	9.0	20.00	3	1.60
B1701.98	1.98	49.0	11.0	24.00	4	2.00
B1701.99	1.99	49.0	11.0	24.00	4	2.00
B1702.0	2.00	49.0	11.0	24.00	4	2.00
B1702.01	2.01	49.0	11.0	24.00	4	2.00
B1702.02	2.02	49.0	11.0	24.00	4	2.00
B1702.03	2.03	49.0	11.0	24.00	4	2.00
B1702.04	2.04	49.0	11.0	24.00	4	2.00
B1702.05	2.05	49.0	11.0	24.00	4	2.00
B1702.49	2.49	57.0	14.0	28.00	4	2.50
B1702.5	2.50	57.0	14.0	28.00	4	2.50
B1702.51	2.51	57.0	14.0	28.00	4	2.50
B1702.52	2.52	57.0	14.0	28.00	4	2.50
B1702.98	2.98	61.0	15.0	32.00	6	3.00
B1702.99	2.99	61.0	15.0	32.00	6	3.00
B1703.0	3.00	61.0	15.0	32.00	6	3.00

Product	DC	OAL	LCF	LB	NOF	DCON MS
	(mm)	(mm)	(mm)	(mm)		(mm)
B1703.01	3.01	65.0	16.0	35.00	6	3.20
B1703.02	3.02	65.0	16.0	35.00	6	3.20
B1703.03	3.03	65.0	16.0	35.00	6	3.20
B1703.04	3.04	65.0	16.0	35.00	6	3.20
B1703.05	3.05	65.0	16.0	35.00	6	3.20
B1703.49	3.49	70.0	18.0	40.00	6	3.50
B1703.5	3.50	70.0	18.0	40.00	6	3.50
B1703.51	3.51	70.0	18.0	40.00	6	3.50
B1703.52	3.52	70.0	18.0	40.00	6	3.50
B1703.98	3.98	75.0	19.0	43.00	6	4.00
B1703.99	3.99	75.0	19.0	43.00	6	4.00
B1704.0	4.00	75.0	19.0	43.00	6	4.00
B1704.01	4.01	75.0	19.0	43.00	6	4.00
B1704.02	4.02	75.0	19.0	43.00	6	4.00
B1704.03	4.03	75.0	19.0	43.00	6	4.00
B1704.04	4.04	75.0	19.0	43.00	6	4.00
B1704.05	4.05	75.0	19.0	43.00	6	4.00
B1704.49	4.49	80.0	21.0	47.00	6	4.50
B1704.5	4.50	80.0	21.0	47.00	6	4.50
B1704.51	4.51	80.0	21.0	47.00	6	4.50
B1704.52	4.52	80.0	21.0	47.00	6	4.50
B1704.98	4.98	86.0	23.0	52.00	6	5.00
B1704.99	4.99	86.0	23.0	52.00	6	5.00
B1705.0	5.00	86.0	23.0	52.00	6	5.00
B1705.01	5.01	86.0	23.0	52.00	6	5.00
B1705.02	5.02	86.0	23.0	52.00	6	5.00
B1705.03	5.03	86.0	23.0	52.00	6	5.00



Product	DC	OAL	LCF	LB	NOF	DCON MS
	(mm)	(mm)	(mm)	(mm)		(mm)
B1705.04	5.04	86.0	23.0	52.00	6	5.00
B1705.05	5.05	86.0	23.0	52.00	6	5.00
B1705.49	5.49	93.0	26.0	57.00	6	5.60
B1705.5	5.50	93.0	26.0	57.00	6	5.60
B1705.51	5.51	93.0	26.0	57.00	6	5.60
B1705.52	5.52	93.0	26.0	57.00	6	5.60
B1705.98	5.98	93.0	26.0	57.00	6	5.60
B1705.99	5.99	93.0	26.0	57.00	6	5.60
B1706.0	6.00	93.0	26.0	57.00	6	5.60
B1706.01	6.01	101.0	28.0	63.00	6	6.30
B1706.02	6.02	101.0	28.0	63.00	6	6.30
B1706.03	6.03	101.0	28.0	63.00	6	6.30
B1706.04	6.04	101.0	28.0	63.00	6	6.30
B1706.05	6.05	101.0	28.0	63.00	6	6.30
B1706.49	6.49	101.0	28.0	63.00	6	6.30
B1706.5	6.50	101.0	28.0	63.00	6	6.30
B1706.51	6.51	101.0	28.0	63.00	6	6.30
B1706.52	6.52	101.0	28.0	63.00	6	6.30
B1706.98	6.98	109.0	31.0	69.00	6	7.10
B1706.99	6.99	109.0	31.0	69.00	6	7.10
B1707.0	7.00	109.0	31.0	69.00	6	7.10
B1707.01	7.01	109.0	31.0	69.00	6	7.10
B1707.02	7.02	109.0	31.0	69.00	6	7.10
B1707.03	7.03	109.0	31.0	69.00	6	7.10
B1707.04	7.04	109.0	31.0	69.00	6	7.10
B1707.05	7.05	109.0	31.0	69.00	6	7.10
B1707.49	7.49	109.0	31.0	69.00	6	7.10
B1707.5	7.50	109.0	31.0	69.00	6	7.10
B1707.51	7.51	117.0	33.0	75.00	6	8.00
B1707.52	7.52	117.0	33.0	75.00	6	8.00
B1707.98	7.98	117.0	33.0	75.00	6	8.00
B1707.99	7.99	117.0	33.0	75.00	6	8.00
B1708.0	8.00	117.0	33.0	75.00	6	8.00
B1708.01	8.01	117.0	33.0	75.00	6	8.00
B1708.02	8.02	117.0	33.0	75.00	6	8.00
B1708.03	8.03	117.0	33.0	75.00	6	8.00
B1708.04	8.04	117.0	33.0	75.00	6	8.00
B1708.05	8.05	117.0	33.0	75.00	6	8.00
B1708.49	8.49	117.0	33.0	75.00	6	8.00
B1708.5	8.50	117.0	33.0	75.00	6	8.00

Product	DC	OAL	LCF	LB	NOF	DCON MS
	(mm)	(mm)	(mm)	(mm)		(mm)
B1708.51	8.51	125.0	36.0	81.00	6	9.00
B1708.52	8.52	125.0	36.0	81.00	6	9.00
B1708.98	8.98	125.0	36.0	81.00	6	9.00
B1708.99	8.99	125.0	36.0	81.00	6	9.00
B1709.0	9.00	125.0	36.0	81.00	6	9.00
B1709.01	9.01	125.0	36.0	81.00	6	9.00
B1709.02	9.02	125.0	36.0	81.00	6	9.00
B1709.03	9.03	125.0	36.0	81.00	6	9.00
B1709.04	9.04	125.0	36.0	81.00	6	9.00
B1709.05	9.05	125.0	36.0	81.00	6	9.00
B1709.49	9.49	125.0	36.0	81.00	6	9.00
B1709.5	9.50	125.0	36.0	81.00	6	9.00
B1709.51	9.51	133.0	38.0	87.00	6	10.00
B1709.52	9.52	133.0	38.0	87.00	6	10.00
B1709.98	9.98	133.0	38.0	87.00	6	10.00
B1709.99	9.99	133.0	38.0	87.00	6	10.00
B17010.0	10.00	133.0	38.0	87.00	6	10.00
B17010.01	10.01	133.0	38.0	87.00	6	10.00
B17010.02	10.02	133.0	38.0	87.00	6	10.00
B17010.03	10.03	133.0	38.0	87.00	6	10.00
B17010.04	10.04	133.0	38.0	87.00	6	10.00
B17010.05	10.05	133.0	38.0	87.00	6	10.00
B17010.49	10.49	133.0	38.0	87.00	6	10.00
B17010.51	10.51	133.0	38.0	87.00	6	10.00
B17010.52	10.52	133.0	38.0	87.00	6	10.00
B17010.98	10.98	142.0	41.0	96.00	6	10.00
B17010.99	10.99	142.0	41.0	96.00	6	10.00
B17011.0	11.00	142.0	41.0	96.00	6	10.00
B17011.01	11.01	142.0	41.0	96.00	6	10.00
B17011.02	11.02	142.0	41.0	96.00	6	10.00
B17011.03	11.03	142.0	41.0	96.00	6	10.00
B17011.04	11.04	142.0	41.0	96.00	6	10.00
B17011.05	11.05	142.0	41.0	96.00	6	10.00
B17011.49	11.49	142.0	41.0	96.00	6	10.00
B17011.5	11.50	142.0	41.0	96.00	6	10.00
B17011.51	11.51	142.0	41.0	96.00	6	10.00
B17011.52	11.52	142.0	41.0	96.00	6	10.00
B17011.98	11.98	151.0	44.0	105.00	6	10.00
B17011.99	11.99	151.0	44.0	105.00	6	10.00
B17012.0	12.00	151.0	44.0	105.00	6	10.00



B157



HSS-E schilruimer, cilindrische schacht, H7

De sterk gespiraliseerde linkse spaangroeven en de rechtse snijwerking leveren uitstekende prestaties, vooral voor langspanige materialen zoals bij de bewerking van non-ferromaterialen, zoals aluminium. Door de conische aansnijding is hij gemakkelijk te plaatsen en te centreren, wat zorgt voor betere prestaties en een betere kwaliteit van de gaten.

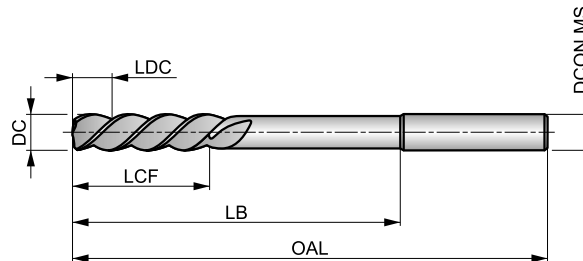

HSS-E	Bright	DIN 212
R		E
H7		

De tabel geeft de geschiktheid aan voor de materiaalgroep en de startwaarden voor de snijnsnelheid (m/min) en de letter verwijst naar de toe te passen voeding (fn), zie vanaf pagina 251.

P1.1 ■ 21 C	P1.2 ■ 24 C	P1.3 ■ 25 C	P2.1 ■ 18 C	P2.2 ■ 16 C	P3.1 ■ 13 B	P3.2 ■ 11 B	M1.1 ■ 11 C	M1.2 ■ 10 C	M2.1 ■ 9 C	M2.2 ■ 8 B	M2.3 ■ 7 B	N1.1 ■ 28 F	N1.2 ■ 21 F
N1.3 ■ 14 F	N2.1 ■ 31 E	N2.2 ■ 28 E	N2.3 ■ 20 E										

DCON MS passing h9.

Product	DC (mm)	OAL (mm)	LCF (mm)	LDC (mm)	LB (mm)	NOF	DCON MS (mm)
B1572.0	2.00	49.0	11.0	3.50	24.00	3	2.00
B1573.0	3.00	61.0	15.0	4.00	32.00	3	3.00
B1574.0	4.00	75.0	19.0	4.00	43.00	3	4.00
B1575.0	5.00	86.0	23.0	4.50	52.00	3	5.00
B1576.0	6.00	93.0	26.0	6.00	57.00	3	5.60
B1577.0	7.00	109.0	31.0	7.00	69.00	3	7.10
B1578.0	8.00	117.0	33.0	9.00	75.00	3	8.00
B1579.0	9.00	125.0	36.0	9.50	81.00	3	9.00
B15710.0	10.00	133.0	38.0	10.00	87.00	3	10.00
B15711.0	11.00	142.0	41.0	10.50	96.00	3	10.00
B15712.0	12.00	151.0	44.0	11.00	105.00	3	10.00
B15713.0	13.00	151.0	44.0	11.50	105.00	3	10.00
B15714.0	14.00	160.0	47.0	12.00	110.00	3	12.50
B15715.0	15.00	162.0	50.0	12.50	112.00	3	12.50
B15716.0	16.00	170.0	52.0	13.00	120.00	3	12.50
B15717.0	17.00	175.0	54.0	13.50	123.00	3	14.00
B15718.0	18.00	182.0	56.0	14.00	130.00	3	14.00
B15719.0	19.00	189.0	58.0	14.50	131.00	3	16.00
B15720.0	20.00	195.0	60.0	15.00	137.00	3	16.00



B161



HSS-E machineruimer, MC schacht, H7

De nauwkeurig geslepen linkse spiraal en rechtse snijwerking zorgen voor soepel ruimen. Verbetert de diameter van de gaten en de oppervlakteaafwerking. Geschikt voor ruimen in vele materialen.

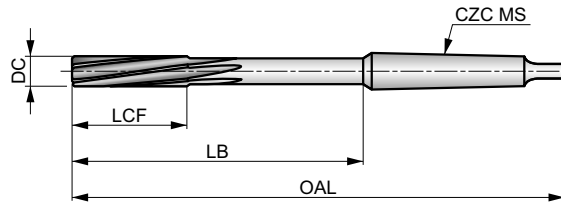

HSS-E	Bright	DIN 208
R		B
H7		

De tabel geeft de geschiktheid aan voor de materiaalgroep en de startwaarden voor de snijsnelheid (m/min) en de letter verwijst naar de toe te passen voeding (fn), zie vanaf pagina 251.

P1.1 ■ 21 C	P1.2 ■ 24 C	P1.3 ■ 25 C	P2.1 ■ 18 C	P2.2 ■ 16 C	P2.3 ■ 14 B	P3.1 ■ 13 B	P3.2 ■ 11 B	P3.3 ■ 9 B	P4.1 ■ 8 B	P4.2 ■ 7 B	P4.3 ■ 5 A	M1.1 ■ 11 C	M1.2 ■ 10 B
M2.1 ■ 9 B	K1.1 ■ 16 E	K1.2 ■ 12 D	K1.3 ■ 9 D	K2.1 ■ 16 C	K2.2 ■ 13 C	K2.3 ■ 10 C	K3.1 ■ 14 C	K3.2 ■ 11 C	N1.1 ■ 24 F	N1.2 ■ 18 F	N1.3 ■ 11 F	N2.1 ■ 27 E	N2.2 ■ 24 E
N2.3 ■ 16 E	N3.1 ■ 47 D	N3.2 ■ 28 E	N3.3 ■ 14 D	N4.1 ■ 30 B									

Product	DC (mm)	OAL (mm)	LCF (mm)	LB (mm)	NOF	CZC MS
B1613.0	3.00	113.0	15.0	47.50	6	MK 1
B1614.0	4.00	124.0	19.0	58.50	6	MK 1
B1615.0	5.00	133.0	23.0	67.50	6	MK 1
B1616.0	6.00	138.0	26.0	72.50	6	MK 1
B1617.0	7.00	150.0	31.0	84.50	6	MK 1
B1618.0	8.00	156.0	33.0	90.50	6	MK 1
B1619.0	9.00	162.0	36.0	96.50	6	MK 1
B16110.0	10.00	168.0	38.0	102.50	6	MK 1
B16111.0	11.00	175.0	41.0	109.50	6	MK 1
B16112.0	12.00	182.0	44.0	116.50	6	MK 1
B16113.0	13.00	182.0	44.0	116.50	6	MK 1
B16114.0	14.00	189.0	47.0	123.50	8	MK 1
B16115.0	15.00	204.0	50.0	124.00	8	MK 2
B16116.0	16.00	210.0	52.0	130.00	8	MK 2
B16117.0	17.00	214.0	54.0	134.00	8	MK 2
B16118.0	18.00	219.0	56.0	139.00	8	MK 2
B16119.0	19.00	223.0	58.0	143.00	8	MK 2
B16120.0	20.00	228.0	60.0	148.00	8	MK 2
B16121.0	21.00	232.0	62.0	152.00	8	MK 2
B16122.0	22.00	237.0	64.0	157.00	8	MK 2
B16123.0	23.00	241.0	66.0	161.00	8	MK 2
B16124.0	24.00	268.0	68.0	169.00	8	MK 3

Product	DC (mm)	OAL (mm)	LCF (mm)	LB (mm)	NOF	CZC MS
B16125.0	25.00	268.0	68.0	169.00	8	MK 3
B16126.0	26.00	273.0	70.0	174.00	8	MK 3
B16127.0	27.00	277.0	71.0	178.00	10	MK 3
B16128.0	28.00	277.0	71.0	178.00	10	MK 3
B16129.0	29.00	281.0	73.0	182.00	10	MK 3
B16130.0	30.00	281.0	73.0	182.00	10	MK 3
B16131.0	31.00	285.0	75.0	186.00	10	MK 3
B16132.0	32.00	317.0	77.0	193.00	10	MK 4
B16133.0	33.00	317.0	77.0	193.00	10	MK 4
B16134.0	34.00	321.0	78.0	197.00	10	MK 4
B16135.0	35.00	321.0	78.0	197.00	10	MK 4
B16136.0	36.00	325.0	79.0	201.00	10	MK 4
B16138.0	38.00	329.0	81.0	205.00	10	MK 4
B16140.0	40.00	329.0	81.0	205.00	10	MK 4
B16142.0	42.00	333.0	82.0	209.00	12	MK 4
B16144.0	44.00	336.0	83.0	212.00	12	MK 4
B16145.0	45.00	336.0	83.0	212.00	12	MK 4
B16146.0	46.00	340.0	84.0	216.00	12	MK 4
B16147.0	47.00	340.0	84.0	216.00	12	MK 4
B16148.0	48.00	344.0	86.0	220.00	12	MK 4
B16150.0	50.00	344.0	86.0	220.00	12	MK 4



B101



HSS-E machineruimer, MC schacht, H7

Machineruimer met morseconus volgens BS328 norm. Met een nauwkeurig geslepen, linkse spiraal met rechtse (met de wijzers van de klok mee) snede voor soepel ruimen, waardoor een nauwkeurige diameter en een goede oppervlakteafwerking worden verkregen. Geschikt voor het ruimen van vele materialen.

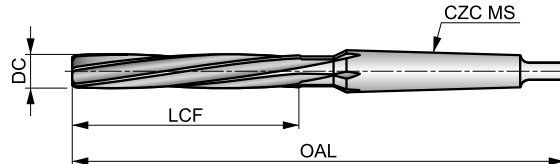

HSS-E	Bright ST	BS 328
R		B
H7		

De tabel geeft de geschiktheid aan voor de materiaalgroep en de startwaarden voor de snijsnelheid (m/min) en de letter verwijst naar de toe te passen voeding (fn), zie vanaf pagina 251.

P1.1 ■ 15 C	P1.2 ■ 16 C	P1.3 ■ 17 C	P2.1 ■ 13 C	P2.2 ■ 11 C	P2.3 ▣ 10 B	P3.1 ■ 7 B	P3.2 ■ 6 B	P3.3 ▣ 5 B	P4.1 ■ 4 B	P4.2 ▣ 4 B	P4.3 ▣ 3 A	M1.1 ▣ 7 B	M1.2 ▣ 6 A
K1.1 ■ 14 E	K1.2 ■ 10 D	K1.3 ▣ 8 D	K2.1 ■ 12 C	K2.2 ■ 10 C	K2.3 ▣ 8 C	K3.1 ■ 11 C	K3.2 ▣ 8 C	N1.1 ▣ 23 F	N1.2 ■ 17 F	N1.3 ■ 9 F	N2.1 ▣ 25 E	N2.2 ■ 18 E	N2.3 ■ 14 E
N3.1 ■ 34 D	N3.2 ■ 20 E	N3.3 ▣ 10 D	N4.1 ▣ 22 B										

Product	DC	DC	OAL	LCF	NOF	CZC MS
	(inch)	(mm)	(mm)	(mm)		
B1013.0	—	3.00	112.0	33.0	4	MK 1
B1011/8	1/8	3.18	112.0	33.0	4	MK 1
B1013.5	—	3.50	115.0	35.0	6	MK 1
B1014.0	—	4.00	117.0	38.0	6	MK 1
B1014.5	—	4.50	120.0	41.0	6	MK 1
B1013/16	3/16	4.76	124.0	44.0	6	MK 1
B1015.0	—	5.00	124.0	44.0	6	MK 1
B1015.5	—	5.50	127.0	47.0	6	MK 1
B1016.0	—	6.00	127.0	47.0	6	MK 1
B1011/4	1/4	6.35	130.0	50.0	6	MK 1
B1016.5	—	6.50	130.0	50.0	6	MK 1
B1017.0	—	7.00	134.0	54.0	6	MK 1
B1015/16	5/16	7.94	138.0	58.0	6	MK 1
B1018.0	—	8.00	138.0	58.0	6	MK 1
B1018.5	—	8.50	138.0	58.0	6	MK 1
B1019.0	—	9.00	142.0	62.0	6	MK 1
B1019.5	—	9.50	142.0	62.0	6	MK 1
B1013/8	3/8	9.52	146.0	66.0	6	MK 1
B10110.0	—	10.00	146.0	66.0	6	MK 1
B10110.5	—	10.50	146.0	66.0	6	MK 1
B10111.0	—	11.00	151.0	71.0	6	MK 1
B1017/16	7/16	11.11	151.0	71.0	6	MK 1
B10112.0	—	12.00	156.0	76.0	6	MK 1
B10112.5	—	12.50	156.0	76.0	6	MK 1
B1011/2	1/2	12.70	156.0	76.0	6	MK 1
B10113.0	—	13.00	156.0	76.0	6	MK 1
B10113.5	—	13.50	161.0	81.0	6	MK 1
B10114.0	—	14.00	161.0	81.0	8	MK 1

Product	DC	DC	OAL	LCF	NOF	CZC MS
	(inch)	(mm)	(mm)	(mm)		
B1019/16	9/16	14.29	181.0	81.0	8	MK 2
B10114.5	—	14.50	181.0	81.0	8	MK 2
B10115.0	—	15.00	181.0	81.0	8	MK 2
B10115.5	—	15.50	187.0	87.0	8	MK 2
B1015/8	5/8	15.88	187.0	87.0	8	MK 2
B10116.0	—	16.00	187.0	87.0	8	MK 2
B10116.5	—	16.50	187.0	87.0	8	MK 2
B10117.0	—	17.00	187.0	87.0	8	MK 2
B10118.0	—	18.00	193.0	93.0	8	MK 2
B10119.0	—	19.00	193.0	93.0	8	MK 2
B1013/4	3/4	19.05	200.0	100.0	8	MK 2
B10120.0	—	20.00	200.0	100.0	8	MK 2
B10113/16	13/16	20.64	200.0	100.0	8	MK 2
B10121.0	—	21.00	200.0	100.0	8	MK 2
B10122.0	—	22.00	207.0	107.0	8	MK 2
B1017/8	7/8	22.22	207.0	107.0	8	MK 2
B10123.0	—	23.00	207.0	107.0	8	MK 2
B10124.0	—	24.00	242.0	115.0	8	MK 3
B10125.0	—	25.00	242.0	115.0	10	MK 3
B1011	1"	25.40	242.0	115.0	10	MK 3
B10126.0	—	26.00	242.0	115.0	10	MK 3
B10127.0	—	27.00	251.0	124.0	10	MK 3
B10128.0	—	28.00	251.0	124.0	10	MK 3
B1011.1/8	1.1/8	28.58	251.0	124.0	10	MK 3
B10129.0	—	29.00	251.0	124.0	10	MK 3
B10130.0	—	30.00	251.0	124.0	10	MK 3
B10131.0	—	31.00	260.0	133.0	10	MK 3
B1011.1/4	1.1/4	31.75	260.0	133.0	10	MK 3



Product	DC	DC	OAL	LCF	NOF	CZC MS
	(inch)	(mm)	(mm)	(mm)		
B10132.0	–	32.00	293.0	133.0	10	MK 4
B10134.0	–	34.00	302.0	142.0	10	MK 4
B1011.3/8	1.3/8	34.93	302.0	142.0	10	MK 4
B10135.0	–	35.00	302.0	142.0	10	MK 4
B10136.0	–	36.00	302.0	142.0	10	MK 4
B10137.0	–	37.00	302.0	142.0	10	MK 4
B10138.0	–	38.00	312.0	152.0	10	MK 4
B1011.1/2	1.1/2	38.10	312.0	152.0	10	MK 4
B10139.0	–	39.00	312.0	152.0	10	MK 4
B10140.0	–	40.00	312.0	152.0	10	MK 4
B10141.0	–	41.00	312.0	152.0	10	MK 4

Product	DC	DC	OAL	LCF	NOF	CZC MS
	(inch)	(mm)	(mm)	(mm)		
B10142.0	–	42.00	312.0	152.0	10	MK 4
B10143.0	–	43.00	323.0	163.0	10	MK 4
B10144.0	–	44.00	323.0	163.0	10	MK 4
B1011.3/4	1.3/4	44.45	323.0	163.0	10	MK 4
B10145.0	–	45.00	323.0	163.0	12	MK 4
B10146.0	–	46.00	323.0	163.0	12	MK 4
B10147.0	–	47.00	323.0	163.0	12	MK 4
B10148.0	–	48.00	334.0	174.0	12	MK 4
B10150.0	–	50.00	334.0	174.0	12	MK 4
B1012	2"	50.80	334.0	174.0	12	MK 4



B121



HSS klinkgatruimer, MC schacht

Ontworpen voor het uitlijnen van gaten in grote constructies, waar twee of meer onderdelen worden samengevoegd, voordat ze met bouten of klinknagels worden vastgezet. De korte conische aansnijding (1 op 10) maakt het gemakkelijker om de ruimer in de voorgeboorde gaten te plaatsen en te centreren. Geschikt voor ruimen in vele materialen.

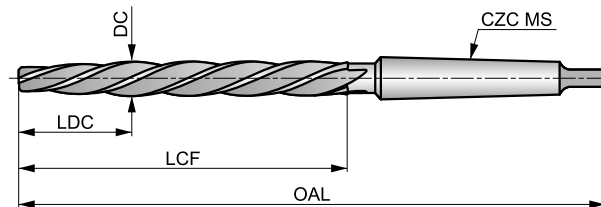

HSS	Bright ST	DIN 311
R		k11

De tabel geeft de geschiktheid aan voor de materiaalgroep en de startwaarden voor de snijsnelheid (m/min) en de letter verwijst naar de toe te passen voeding (fn), zie vanaf pagina 251.

P1.1 ■ 15 C	P1.2 ■ 16 C	P1.3 ■ 17 C	P2.1 ■ 13 C	P2.2 ■ 11 C	P2.3 ▣ 10 B	P3.1 ■ 7 B	P3.2 ■ 6 B	P3.3 ▣ 5 B	P4.1 ■ 4 B	P4.2 ▣ 4 B	P4.3 ▣ 3 A	K1.1 ■ 14 E	K1.2 ■ 10 D
K1.3 ▣ 8 D	K2.1 ■ 12 C	K2.2 ■ 10 C	K2.3 ▣ 8 C	K3.1 ▣ 11 C	K3.2 ▣ 8 C	N1.1 ▣ 23 F	N1.2 ■ 17 F	N1.3 ■ 9 F	N2.1 ▣ 21 E	N2.2 ■ 18 E	N2.3 ▣ 14 E	N3.1 ■ 34 D	N3.2 ■ 20 E
N3.3 ▣ 10 D	N4.1 ▣ 21 B												

Met 1:10 conische aansnijding (LDC).

Product	DC (mm)	OAL (mm)	LCF (mm)	LDC (mm)	NOF	CZC MS
B12110.0	10.00	171.0	95.0	30.00	4	MK 1
B12111.0	11.00	176.0	100.0	33.00	4	MK 1
B12112.0	12.00	199.0	105.0	39.00	4	MK 2
B12113.0	13.00	199.0	105.0	39.00	4	MK 2
B12114.0	14.00	209.0	115.0	42.00	4	MK 2
B12115.0	15.00	219.0	125.0	45.00	4	MK 2
B12116.0	16.00	229.0	135.0	48.00	4	MK 2
B12117.0	17.00	251.0	135.0	51.00	4	MK 3
B12118.0	18.00	261.0	145.0	58.00	4	MK 3
B12119.0	19.00	261.0	145.0	58.00	4	MK 3
B12120.0	20.00	271.0	155.0	62.00	4	MK 3
B12121.0	21.00	271.0	155.0	62.00	4	MK 3
B12122.0	22.00	281.0	165.0	66.00	4	MK 3
B12123.0	23.00	281.0	165.0	66.00	4	MK 3
B12124.0	24.00	296.0	180.0	72.00	4	MK 3
B12125.0	25.00	296.0	180.0	72.00	4	MK 3
B12126.0	26.00	296.0	180.0	72.00	4	MK 3
B12130.0	30.00	311.0	195.0	78.00	5	MK 3



B954



HSS-E conische machine-schilruimer, MC schacht, 1:50

Met extra sterk links gespiraliseerd en rechts snijdend, voor soepel ruimen met een nauwkeuriger diameter en betere afwerking. Ontworpen voor het nabewerken van conische gaten en voor het gebruik van standaard metrische conische pennen met een coniciteit van 1:50. Geschikt voor ruimen in vele materialen.

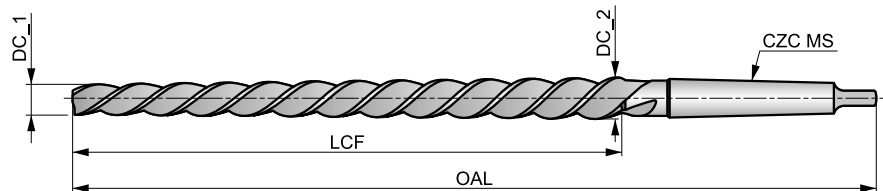

HSS-E	Bright	DIN 2180
R	1:50	

De tabel geeft de geschiktheid aan voor de materiaalgroep en de startwaarden voor de snijsnelheid (m/min) en de letter verwijst naar de toe te passen voeding (fn), zie vanaf pagina 251.

P1.1 ■ 10 B	P1.2 ■ 12 B	P1.3 ■ 13 B	P2.1 ■ 9 B	P2.2 ■ 8 B	P2.3 ▣ 6 A	P3.1 ■ 7 A	P3.2 ■ 6 A	P3.3 ▣ 3 A	P4.1 ■ 4 A	P4.2 ▣ 3 A	P4.3 ▣ 2 A	M1.1 ▣ 11 C	M1.2 ▣ 10 B
M2.1 ▣ 9 B	M2.2 ▣ 8 B	K1.1 ■ 10 C	K1.2 ■ 6 B	K1.3 ▣ 4 B	K2.1 ■ 8 A	K2.2 ■ 6 A	K2.3 ▣ 4 A	K3.1 ■ 11 A	K3.2 ▣ 8 A	N1.1 ▣ 14 F	N1.2 ■ 12 F	N1.3 ■ 9 F	N2.1 ■ 16 E
N2.2 ■ 14 E	N2.3 ▣ 10 E	N3.1 ■ 22	N3.2 ■ 14 E	N3.3 ▣ 6	N4.1 ▣ 22 B								

Product	nom d	DC_1	DC_2	OAL	LCF	NOF	CZC MS
		(mm)	(mm)	(mm)	(mm)		
B9545.0	5.0	4.90	6.36	155.0	73.0	3	MK 1
B9546.0	6.0	5.90	8.00	187.0	105.0	3	MK 1
B9548.0	8.0	7.90	10.80	227.0	145.0	3	MK 1
B95410.0	10.0	9.90	13.40	257.0	175.0	3	MK 1
B95412.0	12.0	11.80	16.00	315.0	210.0	3	MK 2
B95413.0	13.0	12.86	16.74	295.0	194.0	3	MK 2
B95414.0	14.0	13.86	17.74	295.0	194.0	3	MK 2
B95416.0	16.0	15.80	20.40	335.0	230.0	3	MK 2
B95420.0	20.0	19.80	24.80	377.0	250.0	3	MK 3
B95425.0	25.0	24.70	30.70	427.0	300.0	3	MK 3
B95430.0	30.0	29.70	36.10	475.0	320.0	4	MK 4



B955



HSS-E opsteek-machineruimer, H7

Ruimers voor gebruik met een opsteekhouder die past in de boring van de ruimer. Precisiegeslepen met een linkse spiraal en rechts snijdend om soepel ruimen mogelijk te maken. Met een 45° schuine aansnijding voor nauwkeurige positionering en centrering in het gat om de prestaties en de kwaliteit van het gat te verbeteren. Geschikt voor ruimen in vele materialen.

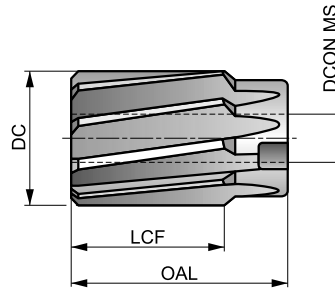

HSS-E	Bright ST	DIN 219
R	B	H7

De tabel geeft de geschiktheid aan voor de materiaalgroep en de startwaarden voor de snijsnelheid (m/min) en de letter verwijst naar de toe te passen voeding (fn), zie vanaf pagina 251.

P1.1 ■ 15 C	P1.2 ■ 16 C	P1.3 ■ 17 C	P2.1 ■ 13 C	P2.2 ■ 11 C	P2.3 ▧ 10 B	P3.1 ■ 7 B	P3.2 ■ 6 B	P3.3 ▧ 5 B	P4.1 ■ 4 B	P4.2 ▧ 4 B	P4.3 ▧ 3 A	M1.1 ▧ 11 C	M1.2 ▧ 10 B
M2.1 ▧ 9 B	K1.1 ■ 10 E	K1.2 ■ 8 D	K1.3 ▧ 7 D	K2.1 ■ 10 C	K2.2 ■ 9 C	K2.3 ▧ 6 C	K3.1 ▧ 10 C	K3.2 ▧ 7 C	N1.1 ▧ 17 F	N1.2 ■ 17 F	N1.3 ■ 10 F	N2.1 ▧ 23 E	N2.2 ■ 21 E
N2.3 ■ 13 E	N3.1 ■ 34 D	N3.2 ■ 20 E	N3.3 ▧ 10 D	N4.1 ▧ 24 C									

Product	DC (mm)	OAL (mm)	LCF (mm)	NOF	DCON MS (mm)
B95525.0	25.00	45.0	32.0	8	13.00
B95526.0	26.00	45.0	32.0	8	13.00
B95527.0	27.00	45.0	32.0	8	13.00
B95528.0	28.00	45.0	32.0	8	13.00
B95529.0	29.00	45.0	32.0	8	13.00
B95530.0	30.00	45.0	32.0	8	13.00
B95531.0	31.00	50.0	36.0	10	16.00
B95532.0	32.00	50.0	36.0	10	16.00
B95534.0	34.00	50.0	36.0	10	16.00
B95535.0	35.00	50.0	36.0	10	16.00
B95536.0	36.00	56.0	40.0	10	19.00
B95537.0	37.00	56.0	40.0	10	19.00
B95538.0	38.00	56.0	40.0	10	19.00
B95540.0	40.00	56.0	40.0	10	19.00

Product	DC (mm)	OAL (mm)	LCF (mm)	NOF	DCON MS (mm)
B95542.0	42.00	56.0	40.0	10	19.00
B95544.0	44.00	63.0	45.0	12	22.00
B95545.0	45.00	63.0	45.0	12	22.00
B95548.0	48.00	63.0	45.0	12	22.00
B95550.0	50.00	63.0	45.0	12	22.00
B95552.0	52.00	71.0	50.0	12	27.00
B95555.0	55.00	71.0	50.0	12	27.00
B95558.0	58.00	71.0	50.0	12	27.00
B95560.0	60.00	71.0	50.0	12	27.00
B95565.0	65.00	80.0	56.0	14	32.00
B95570.0	70.00	80.0	56.0	14	32.00
B95575.0	75.00	90.0	63.0	14	40.00
B95580.0	80.00	90.0	63.0	14	40.00



B956



Opsteekhouder voor B955 ruimers

Gereedschapshouder voor het bevestigen van opsteekruimers. Voorzien van morseconus om rechtstreeks in de machinespindel te worden opgenomen. Voor reserveonderdelen voor de opsteekhouders (schroeven, moeren en ringen), zie Dormer's B957 assortiment voor de beschikbaarheid.

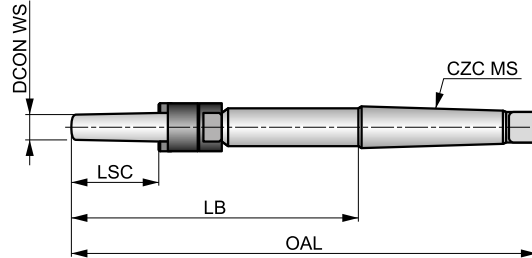

HSS-E



DIN 217



Product	DCON WS (mm)	OAL (mm)	LSC (mm)	LB (mm)	CZC MS
B95613.0	13.00	250.0	45	151.00	MK 3
B95616.0	16.00	261.0	50	162.00	MK 3
B95619.0	19.00	298.0	56	174.00	MK 4
B95622.0	22.00	312.0	63	188.00	MK 4
B95627.0	27.00	359.0	71	203.00	MK 5
B95632.0	32.00	376.0	80	220.00	MK 5
B95640.0	40.00	396.0	90	240.00	MK 5



B957

DORMER

Onderdelen voor B956 opsteekhouder

De B957 reeks reserveonderdelen voor B956 opsteekhouders bestaat uit schroeven, moeren en ringen. Kunnen afzonderlijk per maat worden geleverd. De B957-meeneemringen, moeren en sluitringen zijn vervaardigd volgens de vereiste normen.

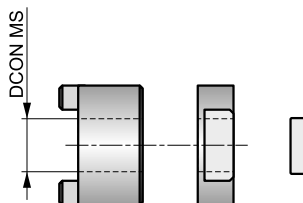

Product	Nr.	DCON MS
		(mm)
B957N3DRIVER	3	13.00
B957N3NUT	3	–
B957N3WASHER	3	–
B957N4DRIVER	4	16.00
B957N4NUT	4	–
B957N4WASHER	4	–
B957N5DRIVER	5	19.00
B957N5NUT	5	–
B957N5WASHER	5	–
B957N6DRIVER	6	22.00
B957N6NUT	6	–
B957N6WASHER	6	–
B957N7DRIVER	7	27.00
B957N7NUT	7	–
B957N7WASHER	7	–
B957N8DRIVER	8	32.00
B957N8NUT	8	–
B957N8WASHER	8	–
B957N9DRIVER	9	40.00
B957N9NUT	9	–
B957N9WASHER	9	–



G400



VHM verzinkboor 90°, cilindrische schacht

Hoogwaardige 90° verzinkboor in volhardmetalen uitvoering, ontworpen voor gebruik met CNC-machines waar een hoge productiviteit en kwaliteit vereist zijn. Kan worden gebruikt in harde en abrasieve materialen. Voor het afschuiven van gaten voor speciale bevestigingsmiddelen en het verwijderen van bramen uit geboorde gaten.

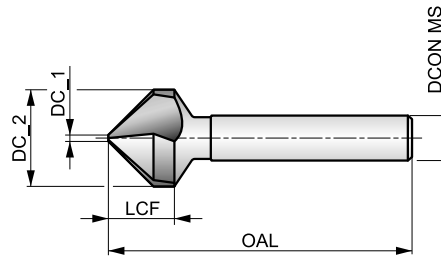

HM	Bright	DIN 335C
R	90°	

De tabel geeft de geschiktheid aan voor de materiaalgroep en de startwaarden voor de snijsnelheid (m/min) en de letter verwijst naar de toe te passen voeding (fn), zie vanaf pagina 251.

P1.1 ■ 64 E	P1.2 ■ 72 E	P1.3 ■ 74 E	P2.1 ■ 55 E	P2.2 ■ 48 D	P2.3 ■ 43 B	P3.1 ■ 45 D	P3.2 ■ 36 D	P3.3 ■ 30 B	P4.1 ■ 26 D	P4.2 ■ 23 B	P4.3 ■ 18 A	M1.1 ■ 24 C	M1.2 ■ 21 C
M2.1 ■ 22 C	M2.2 ▣ 18 C	M2.3 ▣ 15 B	M3.1 ■ 20 B	M3.2 ▣ 17 B	M3.3 ▣ 15 B	M4.1 ▣ 15 A	M4.2 ▣ 13 A	K1.1 ■ 45 F	K1.2 ■ 33 D	K1.3 ■ 25 D	K2.1 ■ 46 C	K2.2 ■ 37 C	K2.3 ▣ 30 C
K3.1 ■ 41 C	K3.2 ■ 31 C	K3.3 ▣ 25 C	K4.1 ■ 38 C	K4.2 ■ 28 C	K4.3 ■ 21 C	K4.4 ▣ 18 C	K4.5 ▣ 15 C	K5.1 ■ 43 C	K5.2 ■ 32 C	K5.3 ■ 25 C	N1.1 ▣ 75 G	N1.2 ■ 55 G	N1.3 ■ 40 F
N2.1 ■ 40 F	N2.2 ■ 36 F	N2.3 ■ 26 F	N3.1 ■ 42 F	N3.2 ■ 25 F	N3.3 ▣ 13 D	N4.3 ■ 17 E	S1.1 ■ 12 C	S1.2 ■ 10 A	S1.3 ▣ 9 A	S2.1 ■ 8 B	S2.2 ▣ 7 A	S3.1 ■ 6 B	S3.2 ▣ 5 A
S4.1 ■ 5 B	S4.2 ▣ 4 A	H1.1 ■ 12 A	H2.1 ■ 7 A	H2.2 ▣ 6 B	H3.1 ■ 8 A	H3.2 ▣ 7 B	H4.1 ■ 5 A	H4.2 ▣ 4 B					

DCON MS passing h6.

Product	DC_2 (mm)	DC_1 (mm)	LCF (mm)	OAL (mm)	DCON MS (mm)	NOF
G4006.3	6.30	1.50	5.0	45.0	5.00	3
G4008.3	8.30	2.00	6.0	50.0	6.00	3
G40010.4	10.40	2.50	7.1	50.0	6.00	3
G40012.4	12.40	2.80	8.0	56.0	8.00	3
G40016.5	16.50	3.20	10.0	60.0	10.00	3
G40020.5	20.50	3.50	12.5	63.0	10.00	3
G40025.0	25.00	3.80	15.0	67.0	10.00	3
G40031.0	31.00	4.20	18.0	71.0	12.00	3



G135



HSS verzinkboor 60°, cilindrische schacht

Met een hoek van 60° voor het afschuiven van gaten voor speciale bevestigingsmiddelen en het verwijderen van bramen uit geboorde gaten met een diameter t/m 25.0 mm. Voor gebruik in zowel machine- als handbewerkingen. Geschikt voor het afschuiven van gaten in vele materialen.

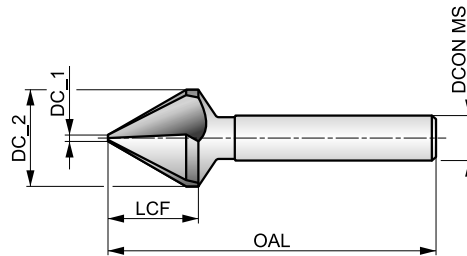

HSS	Bright	DIN 334C
R	60°	

De tabel geeft de geschiktheid aan voor de materiaalgroep en de startwaarden voor de snijsnelheid (m/min) en de letter verwijst naar de toe te passen voeding (fn), zie vanaf pagina 251.

P1.1 ■ 23 E	P1.2 ■ 26 E	P1.3 ■ 27 E	P2.1 ■ 20 E	P2.2 ■ 18 D	P2.3 ▣ 16 B	P3.1 ■ 16 D	P3.2 ▣ 13 D	P3.3 ▣ 11 B	P4.1 ■ 10 D	P4.2 ▣ 8 B	M1.1 ▣ 8 C	M1.2 ▣ 6 C	M2.1 ▣ 7 C
M2.2 ▣ 6 C	K1.1 ▣ 20 F	K1.2 ▣ 15 D	K2.1 ▣ 21 C	K2.2 ▣ 17 C	K3.1 ▣ 18 C	K3.2 ▣ 14 C	K5.1 ▣ 19 C	K5.2 ▣ 15 C	N1.1 ▣ 40 G	N1.2 ■ 30 G	N1.3 ▣ 20 F	N2.1 ■ 20 F	N2.2 ▣ 18 F
N3.1 ■ 21 F	N3.2 ■ 12 F	N3.3 ▣ 6 D	N4.1 ▣ 40 G	N4.2 ▣ 35 G									

DCON MS passing h9.

Product	DC_2 (mm)	DC_1 (mm)	LCF (mm)	OAL (mm)	DCON MS (mm)	NOF
G1356.3	6.30	1.60	6.8	45.0	5.00	3
G1358.0	8.00	2.00	8.5	50.0	6.00	3
G13510.0	10.00	2.50	7.6	50.0	6.00	3
G13512.5	12.50	3.20	11.7	56.0	8.00	3
G13516.0	16.00	4.00	14.5	63.0	10.00	3
G13520.0	20.00	5.00	17.5	67.0	10.00	3
G13525.0	25.00	6.30	20.5	71.0	10.00	3



G335



HSS verzinkboor 60°, cilindrische schacht, TiN gecoat

Met een hoek van 60° voor het afschuiven van gaten voor speciale bevestigingsmiddelen en het verwijderen van bramen uit geboorde gaten. TiN coating verbetert de prestaties en verlengt de standtijd. Voor gebruik in zowel machine- als handbewerkingen. Geschikt voor het afschuiven van gaten in vele materialen.

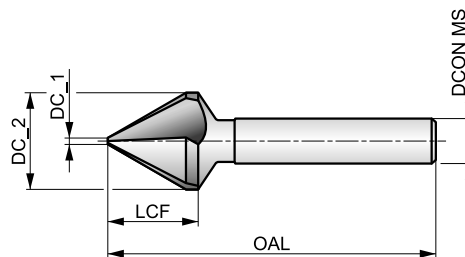

HSS	TiN	DIN 334C
R	60°	

De tabel geeft de geschiktheid aan voor de materiaalgroep en de startwaarden voor de snijsnelheid (m/min) en de letter verwijst naar de toe te passen voeding (fn), zie vanaf pagina 251.

P1.1 ■ 33 E	P1.2 ■ 37 E	P1.3 ■ 38 E	P2.1 ■ 28 E	P2.2 ■ 25 D	P2.3 ■ 22 B	P3.1 ■ 23 D	P3.2 ■ 18 D	P3.3 ■ 15 B	P4.1 ■ 13 D	P4.2 ■ 11 B	P4.3 ■ 9 B	M1.1 ■ 10 C	M1.2 ■ 8 C
M2.1 ■ 19 C	M3.1 ■ 8 B	K1.1 ■ 34 F	K1.2 ■ 25 D	K1.3 ■ 19 D	K2.1 ■ 35 C	K2.2 ■ 28 C	K2.3 ■ 23 C	K3.1 ■ 31 C	K3.2 ■ 24 C	K3.3 ■ 19 C	K4.1 ■ 29 C	K4.2 ■ 22 C	K4.3 ■ 16 C
K5.1 ■ 32 C	K5.2 ■ 24 C	K5.3 ■ 19 C	N1.1 ■ 53 G	N1.2 ■ 40 G	N1.3 ■ 27 F	N2.1 ■ 27 F	N2.2 ■ 24 F	N2.3 ■ 17 F	N3.1 ■ 28 F	N3.2 ■ 16 F	N3.3 ■ 8 D	N4.1 ■ 58 G	N4.2 ■ 50 G

DCON MS passing h9.

Product	DC_2 (mm)	DC_1 (mm)	LCF (mm)	OAL (mm)	DCON MS (mm)	NOF
G3356.3	6.30	1.60	6.8	45.0	5.00	3
G3358.0	8.00	2.00	8.5	50.0	6.00	3
G33510.0	10.00	2.50	7.6	50.0	6.00	3
G33512.5	12.50	3.20	11.7	56.0	8.00	3
G33516.0	16.00	4.00	14.5	63.0	10.00	3
G33520.0	20.00	5.00	17.5	67.0	10.00	3
G33525.0	25.00	6.30	20.5	71.0	10.00	3



G137



HSS verzinkboor 60°, MC schacht

Met een hoek van 60° voor het afschuiven van gaten voor speciale bevestigingsmiddelen en het verwijderen van bramen uit geboorde gaten. Door de morseconus direct op te nemen in de MC machinespindel. Geschikt voor het afschuiven van gaten in vele materialen.

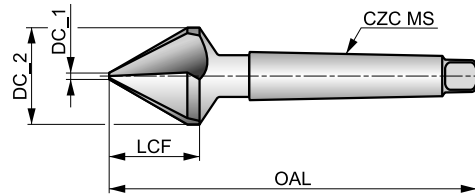

HSS	Bright	DIN 334D
R	60°	

De tabel geeft de geschiktheid aan voor de materiaalgroep en de startwaarden voor de snijsnelheid (m/min) en de letter verwijst naar de toe te passen voeding (fn), zie vanaf pagina 251.

P1.1 ■ 23 E	P1.2 ■ 26 E	P1.3 ■ 27 E	P2.1 ■ 20 E	P2.2 ■ 18 D	P2.3 ▣ 16 B	P3.1 ■ 16 D	P3.2 ▣ 13 D	P3.3 ▣ 11 B	P4.1 ■ 10 D	P4.2 ▣ 8 B	M1.1 ▣ 8 C	M1.2 ▣ 6 C	M2.1 ▣ 7 C
M2.2 ▣ 6 C	K1.1 ▣ 20 F	K1.2 ▣ 15 D	K2.1 ▣ 21 C	K2.2 ▣ 17 C	K3.1 ▣ 18 C	K3.2 ▣ 14 C	K5.1 ▣ 19 C	K5.2 ▣ 15 C	N1.1 ▣ 40 G	N1.2 ■ 30 G	N1.3 ▣ 20 F	N2.1 ■ 20 F	N2.2 ▣ 18 F
N3.1 ■ 21 F	N3.2 ■ 12 F	N3.3 ▣ 6 D	N4.1 ▣ 40 G	N4.2 ▣ 35 G									

Product	DC_2 (mm)	DC_1 (mm)	LCF (mm)	OAL (mm)	CZC MS	NOF
G13716.0	16.00	4.00	14.5	90.0	MK 1	3
G13720.0	20.00	5.00	17.5	106.0	MK 2	3
G13725.0	25.00	6.30	20.0	112.0	MK 2	3
G13731.5	31.50	10.00	23.0	118.0	MK 2	3
G13740.0	40.00	12.50	28.5	150.0	MK 3	3
G13750.0	50.00	16.00	36.0	160.0	MK 3	3
G13763.0	63.00	20.00	43.0	190.0	MK 4	3
G13780.0	80.00	25.00	54.0	200.0	MK 4	3



G154



HSS verzinkboor 82°, cilindrische schacht

Een 82° verzinkboor voor het afschuiven van gaten en voor het verwijderen van bramen uit geboorde gaten. Veelzijdig gereedschap, dat kan worden gebruikt in hand- en machinetoepassingen. Geschikt voor het afschuiven van gaten in vele materialen.

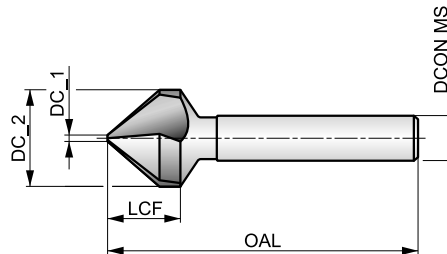

HSS	Bright	DIN 335C
R	82°	

De tabel geeft de geschiktheid aan voor de materiaalgroep en de startwaarden voor de snijsnelheid (m/min) en de letter verwijst naar de toe te passen voeding (fn), zie vanaf pagina 251.

P1.1 ■ 23 E	P1.2 ■ 26 E	P1.3 ■ 27 E	P2.1 ■ 20 E	P2.2 ■ 18 D	P2.3 ▧ 16 B	P3.1 ■ 16 D	P3.2 ■ 13 D	P3.3 ▧ 11 B	P4.1 ■ 10 D	P4.2 ▧ 8 B	M1.1 ▧ 8 C	M1.2 ▧ 6 C	M2.1 ▧ 7 C
M2.2 ▧ 16 C	K1.1 ▧ 20 F	K1.2 ▧ 15 D	K2.1 ▧ 21 C	K2.2 ▧ 17 C	K3.1 ▧ 18 C	K3.2 ▧ 14 C	K5.1 ▧ 14 C	K5.2 ▧ 10 C	N1.1 ▧ 40 G	N1.2 ■ 30 G	N1.3 ▧ 20 F	N2.1 ■ 20 F	N2.2 ▧ 18 F
N3.1 ■ 21 F	N3.2 ■ 12 F	N3.3 ▧ 6 D	N4.1 ▧ 40 G	N4.2 ▧ 35 G									

DCON MS passing h9.

Product	DC_2 (mm)	DC_1 (mm)	LCF (mm)	OAL (mm)	DCON MS (mm)	NOF
G1546.3	6.30	1.50	5.5	45.0	5.00	3
G1548.3	8.30	2.00	6.5	50.0	6.00	3
G15410.4	10.40	2.50	7.6	50.0	6.00	3
G15412.4	12.40	2.80	8.5	56.0	8.00	3
G15416.5	16.50	3.20	10.5	60.0	10.00	3
G15420.5	20.50	3.50	13.0	63.0	10.00	3
G15425.0	25.00	3.80	15.5	67.0	10.00	3



G129



HSS verzinkboor 90°, 1-snijder, cilindrische schacht

Een 90° verzinkboor met blanke afwerking voor het afschuiven en voor het verwijderen van bramen uit geboorde gaten. Het ontwerp met één snijkant onderdrukt trillingen en hakkelen voor een soepele afschuinbewerking. Geschikt voor het afschuiven van gaten in zacht staal en middelsterke non-ferromaterialen zoals aluminium.

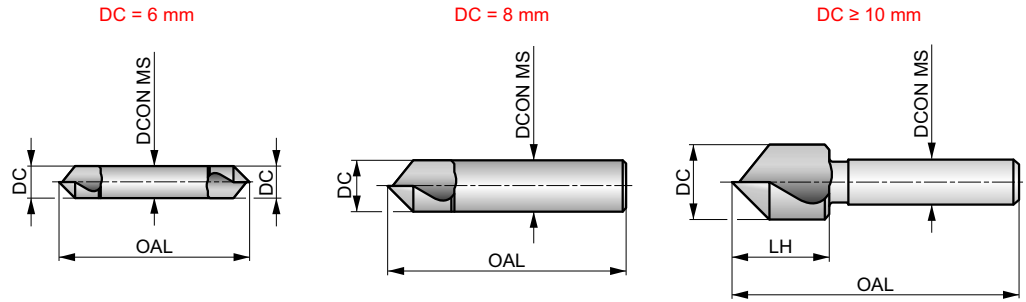

HSS	Bright	DORMER
R	90°	

De tabel geeft de geschiktheid aan voor de materiaalgroep en de startwaarden voor de snijsnelheid (m/min) en de letter verwijst naar de toe te passen voeding (fn), zie vanaf pagina 251.

P1.1 ■ 21 D	P1.2 ■ 24 D	P1.3 ■ 25 D	P2.1 ■ 18 D	P2.2 ■ 16 C	P2.3 ▣ 14 A	P3.1 ■ 13 B	P3.2 ▣ 11 B	M1.1 ▣ 8 B	M1.2 ▣ 6 B	M2.1 ▣ 7 B	K1.1 ▣ 18 D	K1.2 ▣ 13 C	K2.1 ▣ 19 A
K2.2 ▣ 15 A	K3.1 ▣ 16 A	K3.2 ▣ 12 A	N1.1 ■ 34 D	N1.2 ■ 25 D	N1.3 ▣ 16 C	N2.1 ▣ 16 C	N2.2 ▣ 14 C	N3.1 ■ 17 C	N3.2 ■ 9 C	N3.3 ▣ 5 B	N4.1 ▣ 35 D	N4.2 ▣ 30 D	

DCON MS passing h9.

Product	DC (mm)	LH (mm)	OAL (mm)	DCON MS (mm)	NOF
G1296.0	6.00	–	45.0	6.00	1
G1298.0	8.00	–	50.0	8.00	1
G12910.0	10.00	17.0	49.0	8.00	1
G12912.5	12.50	17.0	49.0	8.00	1
G12916.0	16.00	20.0	56.0	10.00	1
G12920.0	20.00	24.0	60.0	10.00	1
G12925.0	25.00	25.0	75.0	12.00	1
G12931.5	31.50	29.0	80.0	12.00	1



G149



HSS-E verzinkboor 90°, cilindrische schacht, dwarsgat

Een 90° verzinkboor voor het afschuiven van gaten en voor het verwijderen van bramen uit geboorde gaten. Het speciale ontwerp met schuine boring leidt de spanen weg van de snijkant voor een vlotte werking. Geschikt voor het afschuiven van gaten in vele zachte en langspanige materialen.

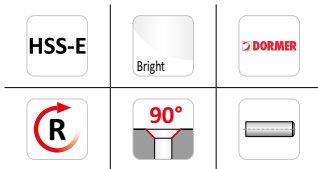
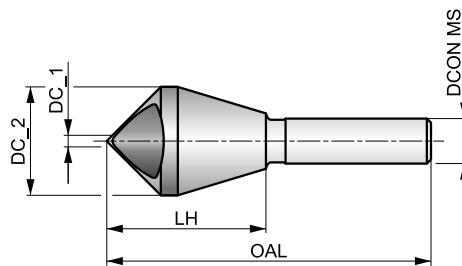

De tabel geeft de geschiktheid aan voor de materiaalgroep en de startwaarden voor de snijsnelheid (m/min) en de letter verwijst naar de toe te passen voeding (fn), zie vanaf pagina 251.

P1.1 ▣ 21 D	P1.2 ▣ 24 D	P1.3 ▣ 25 D	P2.1 ▣ 18 D	P2.2 ▣ 16 C	P2.3 ▣ 14 A	P3.1 ▣ 16 B	P3.2 ▣ 13 B	M1.1 ▣ 8 B	M1.2 ▣ 6 B	M2.1 ▣ 7 B	K1.1 ▣ 18 D	K2.1 ▣ 19 A	K3.1 ▣ 16 A
K5.1 ▣ 14 A	N1.1 ▣ 34 D	N1.2 ▣ 25 D	N1.3 ▣ 16 C	N2.1 ▣ 16 C	N2.2 ▣ 14 C	N3.1 ▣ 17 C	N3.2 ▣ 9 C	N3.3 ▣ 5 B	N4.1 ▣ 17 D	N4.2 ▣ 5 D			

Product	DC_2 (mm)	DC_1 (mm)	LH (mm)	OAL (mm)	DCON MS (mm)	DC (mm)	NOF
G1495	5.00	2.00	19.0	45.0	6.00	10.00	1
G14910	10.00	5.00	23.0	48.0	8.00	14.00	1
G14915	15.00	10.00	34.0	65.0	10.00	21.00	1
G14920	20.00	15.00	43.0	84.0	12.00	28.00	1
G14925	25.00	20.00	48.0	102.0	15.00	35.00	1
G14930	30.00	25.00	61.0	115.0	15.00	44.00	1
G14935	35.00	30.00	65.0	127.0	15.00	48.00	1
G14940	40.00	35.00	66.0	136.0	15.00	53.00	1
G14950	50.00	40.00	85.0	166.0	20.00	60.00	1



G136



HSS verzinkboor 90°, cilindrische schacht

Een 90° verzinkboor voor het afschuiven van gaten en voor het verwijderen van bramen uit geboorde gaten. De gereduceerde schacht maakt het mogelijk verzinkboren met een grotere diameter te gebruiken in standaard houders en boorkoppen. Veelzijdig gereedschap, dat kan worden gebruikt in hand- en machinetoepassingen. Geschikt voor het afschuiven van gaten in vele materialen.

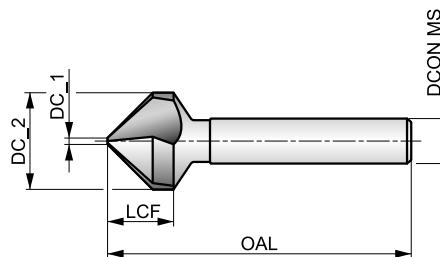

HSS	Bright	DIN 335C
R	90°	

De tabel geeft de geschiktheid aan voor de materiaalgroep en de startwaarden voor de snijsnelheid (m/min) en de letter verwijst naar de toe te passen voeding (fn), zie vanaf pagina 251.

P1.1 ■ 23 E	P1.2 ■ 26 E	P1.3 ■ 27 E	P2.1 ■ 20 E	P2.2 ■ 18 D	P2.3 ■ 16 B	P3.1 ■ 16 D	P3.2 ■ 13 D	P3.3 ■ 11 B	P4.1 ■ 10 D	P4.2 ■ 8 B	M1.1 ■ 8 C	M1.2 ■ 6 C	M2.1 ■ 7 C
M2.2 ■ 16 C	K1.1 ■ 20 F	K1.2 ■ 15 D	K2.1 ■ 21 C	K2.2 ■ 17 C	K3.1 ■ 18 C	K3.2 ■ 14 C	K5.1 ■ 19 C	K5.2 ■ 15 C	N1.1 ■ 40 G	N1.2 ■ 30 G	N1.3 ■ 20 F	N2.1 ■ 20 F	N2.2 ■ 18 F
N3.1 ■ 21 F	N3.2 ■ 12 F	N3.3 ■ 6 D	N4.1 ■ 40 G	N4.2 ■ 35 G									

DCON MS passing h9.

Deze producten zijn ook in een set verkrijgbaar. Zie G236.

Product	DC_2	DC_1	LCF	OAL	DCON MS	NOF
	(mm)	(mm)	(mm)	(mm)	(mm)	
G1364.3	4.30	1.30	4.0	40.0	4.00	3
G1365.0	5.00	1.50	4.5	40.0	4.00	3
G1365.3	5.30	1.50	4.5	40.0	4.00	3
G1365.8	5.80	1.50	5.0	45.0	5.00	3
G1366.0	6.00	1.50	5.0	45.0	5.00	3
G1366.3	6.30	1.50	5.5	45.0	5.00	3
G1367.0	7.00	1.80	5.5	50.0	6.00	3
G1367.3	7.30	1.80	6.1	50.0	6.00	3
G1368.0	8.00	2.00	6.1	50.0	6.00	3
G1368.3	8.30	2.00	6.5	50.0	6.00	3
G1369.4	9.40	2.20	7.2	50.0	6.00	3
G13610.0	10.00	2.50	7.6	50.0	6.00	3
G13610.4	10.40	2.50	7.6	50.0	6.00	3

Product	DC_2	DC_1	LCF	OAL	DCON MS	NOF
	(mm)	(mm)	(mm)	(mm)	(mm)	
G13611.5	11.50	2.80	8.0	56.0	8.00	3
G13612.4	12.40	2.80	8.5	56.0	8.00	3
G13613.4	13.40	2.90	9.0	56.0	8.00	3
G13615.0	15.00	3.20	9.5	60.0	10.00	3
G13616.5	16.50	3.20	10.5	60.0	10.00	3
G13619.0	19.00	3.50	11.7	63.0	10.00	3
G13620.5	20.50	3.50	13.0	63.0	10.00	3
G13623.0	23.00	3.80	13.7	67.0	10.00	3
G13625.0	25.00	3.80	15.5	67.0	10.00	3
G13626.0	26.00	3.80	15.5	67.0	10.00	3
G13628.0	28.00	4.00	16.5	71.0	12.00	3
G13630.0	30.00	4.20	18.5	71.0	12.00	3
G13631.0	31.00	4.20	18.5	71.0	12.00	3



G560



HSS verzinkboor 90°, cilindrische schacht, TiAlN gecoat

Een 90° verzinkboor voor het afschuiven van standaard bevestigingsgaten en het verwijderen van bramen uit geboorde gaten. De gereduceerde schacht maakt het mogelijk verzinkboren met een grotere diameter te gebruiken in standaard houders en boorkoppen. Veelzijdig gereedschap, geschikt voor hand- en machinetoepassingen. TiAlN coating verbetert de prestaties en verlengt de standtijd.

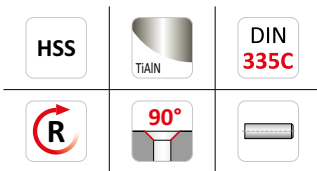
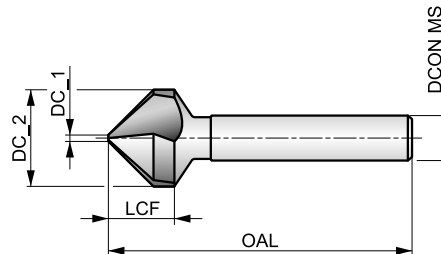

De tabel geeft de geschiktheid aan voor de materiaalgroep en de startwaarden voor de snijsnelheid (m/min) en de letter verwijst naar de toe te passen voeding (fn), zie vanaf pagina 251.

P1.1 ■ 40 E	P1.2 ■ 45 E	P1.3 ■ 46 E	P2.1 ■ 34 E	P2.2 ■ 30 D	P2.3 ■ 27 B	P3.1 ■ 28 D	P3.2 ■ 22 D	P3.3 ■ 19 B	P4.1 ■ 16 D	P4.2 ■ 14 B	P4.3 ▣ 11 B	M1.1 ▣ 11 C	M1.2 ▣ 9 C
M2.1 ▣ 10 C	M2.2 ▣ 9 C	M2.3 ▣ 8 B	K1.1 ■ 41 F	K1.2 ■ 30 D	K1.3 ▣ 23 D	K2.1 ■ 42 C	K2.2 ■ 34 C	K2.3 ▣ 27 C	K3.1 ■ 37 C	K3.2 ■ 28 C	K3.3 ▣ 23 C	K4.1 ▣ 34 C	K4.2 ▣ 26 C
K4.3 ▣ 19 C	K5.1 ■ 39 C	K5.2 ■ 29 C	K5.3 ▣ 23 C	N1.1 ▣ 60 G	N1.2 ▣ 45 G	N1.3 ■ 30 F	N2.1 ■ 30 F	N2.2 ■ 27 F	N2.3 ■ 19 F	N3.1 ■ 32 F	N3.2 ■ 18 F	N3.3 ▣ 19 D	N4.1 ▣ 62 G
N4.2 ▣ 155 G													

DCON MS passing h9.

Deze producten zijn ook in een set verkrijgbaar. Zie G236.

Product	DC_2 (mm)	DC_1 (mm)	LCF (mm)	OAL (mm)	DCON MS (mm)	NOF
G5606.3	6.30	1.50	5.5	45.0	5.00	3
G5608.0	8.00	2.00	6.1	50.0	6.00	3
G5608.3	8.30	2.00	6.5	50.0	6.00	3
G56010.0	10.00	2.50	7.6	50.0	6.00	3
G56010.4	10.40	2.50	7.6	50.0	6.00	3
G56012.4	12.40	2.80	8.5	56.0	8.00	3
G56016.5	16.50	3.20	10.5	60.0	10.00	3
G56020.5	20.50	3.50	13.0	63.0	10.00	3
G56025.0	25.00	3.80	15.5	67.0	10.00	3
G56031.0	31.00	4.20	18.5	71.0	12.00	3



G106



HSS 90° verzinkboor, 3-vlaks cilindrische schacht

Een 90° verzinkboor voor het afschuiven van standaard bevestigingsgaten en het verwijderen van bramen uit geboorde gaten. De schacht met drie geslepen vlakken zorgt voor een betere houvast in drieklauwboorhouders, vooral bij gebruik in handgereedschap. Geschikt voor het afschuiven van gaten in vele materialen.

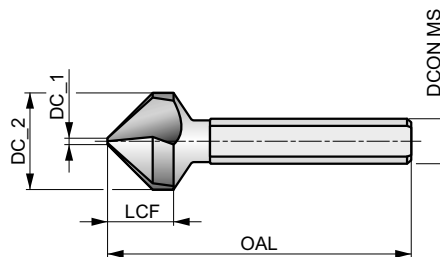

HSS	Bright	DIN 335C
R	90°	

De tabel geeft de geschiktheid aan voor de materiaalgroep en de startwaarden voor de snijnsnelheid (m/min) en de letter verwijst naar de toe te passen voeding (fn), zie vanaf pagina 251.

P1.1 ■ 23 E	P1.2 ■ 26 E	P1.3 ■ 27 E	P2.1 ■ 20 E	P2.2 ■ 18 D	P2.3 ■ 16 B	P3.1 ■ 16 D	P3.2 ■ 13 D	P3.3 ■ 11 B	P4.1 ■ 10 D	P4.2 ■ 8 B	M1.1 ■ 8 C	M1.2 ■ 6 C	M2.1 ■ 7 C
M2.2 ■ 16 C	K1.1 ■ 20 F	K1.2 ■ 15 D	K2.1 ■ 21 C	K2.2 ■ 17 C	K3.1 ■ 18 C	K3.2 ■ 14 C	K5.1 ■ 19 C	K5.2 ■ 15 C	N1.1 ■ 40 G	N1.2 ■ 30 G	N1.3 ■ 20 F	N2.1 ■ 20 F	N2.2 ■ 18 F
N3.1 ■ 21 F	N3.2 ■ 12 F	N3.3 ■ 6 D	N4.1 ■ 40 G	N4.2 ■ 35 G									

DCON MS passing h9.

Deze producten zijn ook in een set verkrijgbaar. Zie G236.

Product	DC_2 (mm)	DC_1 (mm)	LCF (mm)	OAL (mm)	DCON MS (mm)	NOF
G1066.3	6.30	1.50	5.6	45.0	5.00	3
G1068.3	8.30	2.00	6.9	50.0	6.00	3
G10610.4	10.40	2.50	7.8	50.0	6.00	3
G10612.4	12.40	2.80	8.6	56.0	8.00	3
G10616.5	16.50	3.20	11.1	60.0	10.00	3
G10620.5	20.50	3.50	12.9	63.0	10.00	3
G10625.0	25.00	3.80	15.7	67.0	10.00	3
G10631.0	31.00	4.20	18.5	71.0	12.00	3
G10634.0	34.00	4.50	19.0	103.0	16.00	3
G10637.0	37.00	4.50	21.2	118.0	16.00	3
G10640.0	40.00	4.50	20.0	118.0	16.00	3
G10650.0	50.00	5.00	23.6	126.0	16.00	3



G506



HSS 90° verzinkboor, 3-vlaks cilindrische schacht, TiAlN gecoat

Een 90° verzinkboor voor het afschuiven van standaard bevestigingsgaten en het verwijderen van bramen uit geboorde gaten. De schacht met drie geslepen vlakken zorgt voor een betere houvast in drieklauwboorhouders, vooral bij gebruik in handgereedschap. TiAlN coating verbetert de prestaties en verlengt de standtijd. Geschikt voor het afschuiven van gaten in vele materialen.

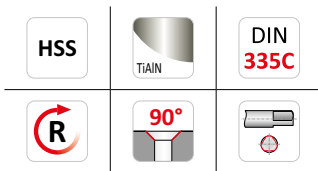
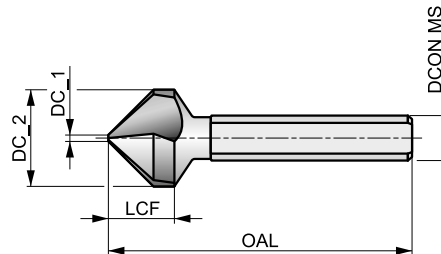

De tabel geeft de geschiktheid aan voor de materiaalgroep en de startwaarden voor de snijsnelheid (m/min) en de letter verwijst naar de toe te passen voeding (fn), zie vanaf pagina 251.

P1.1 ■ 40 E	P1.2 ■ 45 E	P1.3 ■ 46 E	P2.1 ■ 34 E	P2.2 ■ 30 D	P2.3 ■ 27 B	P3.1 ■ 28 D	P3.2 ■ 22 D	P3.3 ■ 19 B	P4.1 ■ 16 D	P4.2 ■ 14 B	P4.3 ▣ 11 B	M1.1 ▣ 11 C	M1.2 ▣ 9 C
M2.1 ▣ 10 C	M2.2 ▣ 9 C	M2.3 ▣ 8 B	K1.1 ■ 41 F	K1.2 ■ 30 D	K1.3 ▣ 23 D	K2.1 ■ 42 C	K2.2 ■ 34 C	K2.3 ▣ 27 C	K3.1 ■ 37 C	K3.2 ■ 28 C	K3.3 ▣ 23 C	K4.1 ▣ 34 C	K4.2 ▣ 26 C
K4.3 ▣ 19 C	K5.1 ■ 39 C	K5.2 ■ 29 C	K5.3 ▣ 23 C	N1.1 ▣ 60 G	N1.2 ▣ 45 G	N1.3 ■ 30 F	N2.1 ■ 30 F	N2.2 ■ 27 F	N2.3 ■ 19 F	N3.1 ■ 32 F	N3.2 ■ 18 F	N3.3 ▣ 9 D	N4.1 ▣ 62 G
N4.2 ▣ 55 G													

DCON MS passing h9.

Deze producten zijn ook in een set verkrijgbaar. Zie G236.

Product	DC_2 (mm)	DC_1 (mm)	LCF (mm)	OAL (mm)	DCON MS (mm)	NOF
G5066.3	6.30	1.50	5.6	45.0	5.00	3
G5068.3	8.30	2.00	6.9	50.0	6.00	3
G50610.4	10.40	2.50	7.8	50.0	6.00	3
G50612.4	12.40	2.80	8.6	56.0	8.00	3
G50616.5	16.50	3.20	11.1	60.0	10.00	3
G50620.5	20.50	3.50	12.9	63.0	10.00	3
G50625.0	25.00	3.80	15.7	67.0	10.00	3
G50631.0	31.00	4.20	18.5	71.0	12.00	3
G50634.0	34.00	4.50	19.0	103.0	16.00	3
G50637.0	37.00	4.50	21.2	118.0	16.00	3
G50640.0	40.00	4.50	20.0	118.0	16.00	3
G50650.0	50.00	5.00	23.6	126.0	16.00	3



G142



HSS verzinkboor 90°, cilindrische schacht, voor RVS

Een 90° verzinkboor voor het afschuiven van gaten voor standaard bevestigingsmiddelen en voor het verwijderen van bramen uit geboorde gaten. Grotere vrijloophoek voor extra scherpe snijkanten, wat de prestaties verbetert bij het bewerken van taaiere materialen, zoals roestvast staal en non-ferromaterialen. Kan zowel met de hand als machinaal worden gebruikt.

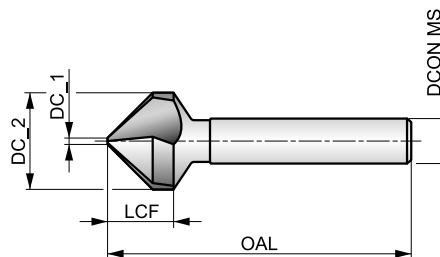

HSS	Bright	DIN 335C
R	90°	

De tabel geeft de geschiktheid aan voor de materiaalgroep en de startwaarden voor de snijsnelheid (m/min) en de letter verwijst naar de toe te passen voeding (fn), zie vanaf pagina 251.

P1.1 ■ 23 E	P1.2 ■ 26 E	P1.3 ■ 27 E	P2.1 ■ 20 E	P2.2 ■ 18 D	P2.3 ▣ 16 B	P3.1 ■ 16 D	P3.2 ■ 13 D	P3.3 ▣ 11 B	P4.1 ■ 10 D	P4.2 ▣ 8 B	M1.1 ■ 11 C	M1.2 ■ 9 C	M2.1 ■ 10 C
M2.2 ▣ 8 C	M3.1 ■ 7 B	M3.2 ▣ 6 B	M4.1 ▣ 4 A	N1.1 ■ 40 G	N1.2 ■ 30 G	N1.3 ▣ 20 F	N2.1 ▣ 20 F	N2.2 ▣ 18 F	N2.3 ▣ 20 F	N3.1 ■ 34 F	N3.2 ■ 20 F	N3.3 ■ 10 D	N4.1 ■ 40 G
N4.2 ■ 35 G													

DCON MS passing h9.

Product	DC_2 (mm)	DC_1 (mm)	LCF (mm)	OAL (mm)	DCON MS (mm)	NOF
G1424.8	4.80	1.30	4.5	40.0	4.00	3
G1425.0	5.00	1.50	4.5	40.0	4.00	3
G1426.0	6.00	1.50	5.0	45.0	5.00	3
G1426.3	6.30	1.50	5.5	45.0	5.00	3
G1427.0	7.00	1.80	5.5	50.0	6.00	3
G1427.3	7.30	1.80	6.1	50.0	6.00	3
G1428.0	8.00	2.00	6.1	50.0	6.00	3
G1428.3	8.30	2.00	6.5	50.0	6.00	3
G14210.0	10.00	2.50	7.6	50.0	6.00	3
G14210.4	10.40	2.50	7.6	50.0	6.00	3
G14211.5	11.50	2.80	8.0	56.0	8.00	3
G14212.4	12.40	2.80	8.5	56.0	8.00	3
G14215.0	15.00	3.20	9.5	60.0	10.00	3
G14216.5	16.50	3.20	10.5	60.0	10.00	3
G14219.0	19.00	3.50	11.7	63.0	10.00	3
G14220.5	20.50	3.50	13.0	63.0	10.00	3
G14223.0	23.00	3.80	13.7	67.0	10.00	3
G14225.0	25.00	3.80	15.5	67.0	10.00	3
G14231.0	31.00	4.20	18.5	71.0	12.00	3



G570



HSS-E verzinkboor 90°, cilindrische schacht, AlTiCN gecoat

Een 90° verzinkboor om gaten af te schuiven voor standaard bevestigingsmiddelen en om bramen uit geboorde gaten te verwijderen. Kan worden gebruikt in machine- en handbediende toepassingen. Bijzonder geschikt voor het afschuiven van gaten in harde en abrasieve materialen. AlTiCN coating verbetert de prestaties en verlengt de standtijd.

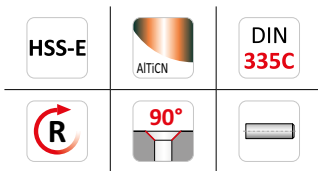
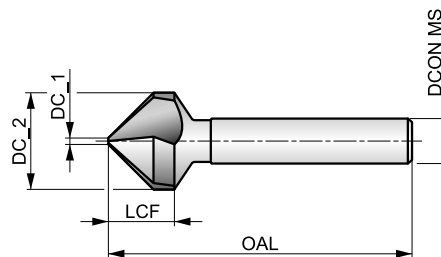

De tabel geeft de geschiktheid aan voor de materiaalgroep en de startwaarden voor de snijsnelheid (m/min) en de letter verwijst naar de toe te passen voeding (fn), zie vanaf pagina 251.

P1.1 ■ 40 E	P1.2 ■ 45 E	P1.3 ■ 46 E	P2.1 ■ 34 E	P2.2 ■ 30 D	P2.3 ■ 27 B	P3.1 ■ 28 D	P3.2 ■ 22 D	P3.3 ■ 19 B	P4.1 ■ 16 D	P4.2 ■ 14 B	P4.3 ■ 11 B	M1.1 ■ 23 C	M1.2 ■ 20 C
M2.1 ■ 21 C	M2.2 ■ 17 C	M2.3 ■ 14 A	M3.1 ■ 14 B	M3.2 ■ 12 B	M3.3 ■ 11 B	M4.1 ■ 15 A	M4.2 ■ 13 A	K1.1 ■ 41 C	K1.2 ■ 30 C	K1.3 ■ 23 C	K2.1 ■ 42 C	K2.2 ■ 34 C	K2.3 ■ 27 C
K3.1 ■ 37 C	K3.2 ■ 28 C	K3.3 ■ 23 C	K4.1 ■ 34 C	K4.2 ■ 26 C	K4.3 ■ 19 C	K5.1 ■ 39 C	K5.2 ■ 29 C	K5.3 ■ 23 C	N1.1 ■ 60 G	N1.2 ■ 45 G	N1.3 ■ 30 F	N2.1 ■ 30 F	N2.2 ■ 27 F
N2.3 ■ 19 F	N3.1 ■ 32 F	N3.2 ■ 18 F	N3.3 ■ 9 D										

DCON MS passing h9.

Product	DC_2 (mm)	DC_1 (mm)	LCF (mm)	OAL (mm)	DCON MS (mm)	NOF
G5706.3	6.30	1.50	6.5	45.0	5.00	3
G5708.3	8.30	2.00	8.2	50.0	6.00	3
G57010.4	10.40	2.50	9.7	50.0	6.00	3
G57012.4	12.40	2.80	10.6	56.0	8.00	3
G57016.5	16.50	3.20	13.9	60.0	10.00	3
G57020.5	20.50	3.50	17.1	63.0	10.00	3
G57025.0	25.00	3.80	21.4	67.0	10.00	3
G57031.0	31.00	4.20	24.4	71.0	12.00	3



G107



HSS-E 90° verzinkboor, zeskant schacht

Een veelzijdige verzinkboor met een 1/4" zeskantige schacht waardoor hij gemakkelijker te gebruiken is met adapters voor elektrische schroevendraaiers. De 90° verzinkboor maakt afschuiningen voor standaard bevestigingsmiddelen en verwijdert bramen van geboorde gaten. Geschikt voor het afschuiven van gaten in vele materialen.

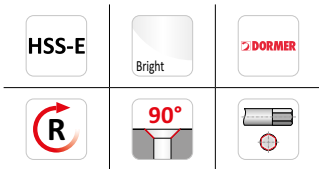
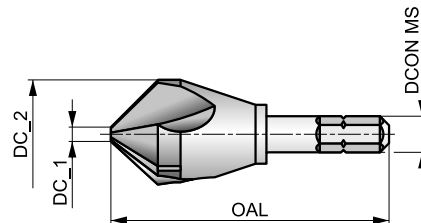

De tabel geeft de geschiktheid aan voor de materiaalgroep en de startwaarden voor de snijsnelheid (m/min) en de letter verwijst naar de toe te passen voeding (fn), zie vanaf pagina 251.

P1.1 ■ 23 E	P1.2 ■ 26 E	P1.3 ■ 27 E	P2.1 ■ 20 E	P2.2 ■ 18 D	P2.3 ▣ 16 B	P3.1 ■ 16 D	P3.2 ■ 13 D	P3.3 ▣ 11 B	P4.1 ■ 10 D	P4.2 ▣ 8 B	M1.1 ▣ 11 C	M1.2 ▣ 9 C	M2.1 ▣ 10 C
M2.2 ▣ 9 C	M2.3 ▣ 8 B	K1.1 ■ 20 F	K1.2 ▣ 15 D	K2.1 ■ 21 C	K2.2 ▣ 17 C	K3.1 ■ 18 C	K3.2 ▣ 14 C	K4.1 ▣ 15 C	K5.1 ■ 19 C	K5.2 ▣ 15 C	N1.1 ▣ 40 G	N1.2 ■ 30 G	N1.3 ▣ 20 F
N2.1 ▣ 20 F	N2.2 ▣ 18 F	N2.3 ▣ 20 F	N3.1 ■ 21 F	N3.2 ▣ 12 F	N3.3 ▣ 6 D	N4.1 ▣ 40 G	N4.2 ▣ 35 G						

6.35; 1/4" zeskantschacht; DIN 74

Product	DC_2	DC_1	OAL	DCONMS	CZC MS	NOF
	(mm)	(mm)	(mm)	(inch)		
G1076.3	6.30	1.50	50.0	1/4"	M2-M3	3
G1078.3	8.30	2.00	50.0	1/4"	M4	3
G10710.4	10.40	2.50	50.0	1/4"	M5	3
G10712.4	12.40	2.80	50.0	1/4"	M6	3
G10716.5	16.50	3.20	50.0	1/4"	M8	3
G10720.5	20.50	3.50	50.0	1/4"	M10	3



G600



HSS verzinkboor 90°, lange uitvoering, cilindrische schacht

De verlengde schacht maakt het mogelijk om gaten af te schuiven op moeilijk bereikbare plaatsen. De 90° verzinkboor maakt afschuiningen voor standaard bevestigingsmiddelen en verwijdert bramen van geboorde gaten. Geschikt voor het afschuiven van gaten in vele materialen.

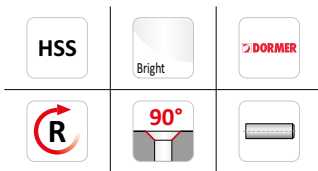
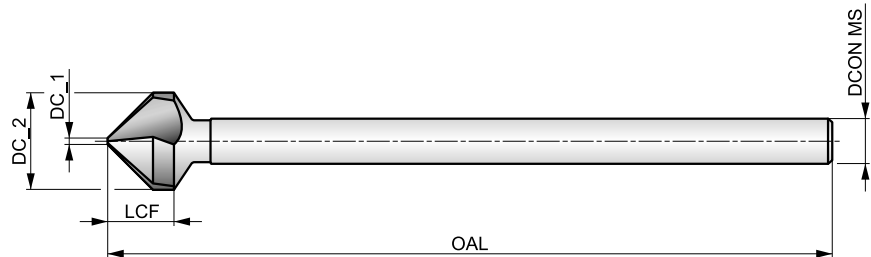

De tabel geeft de geschiktheid aan voor de materiaalgroep en de startwaarden voor de snijsnelheid (m/min) en de letter verwijst naar de toe te passen voeding (fn), zie vanaf pagina 251.

P1.1 ■ 20 E	P1.2 ■ 22 E	P1.3 ■ 23 E	P2.1 ■ 17 E	P2.2 ■ 15 D	P2.3 ■ 13 B	P3.1 ■ 12 D	P3.2 ■ 9 D	P3.3 ■ 8 B	P4.1 ■ 7 D	P4.2 ■ 6 B	M1.1 ■ 8 C	M1.2 ■ 6 C	M2.1 ■ 7 C
M2.2 ■ 16 C	K1.1 ■ 17 E	K1.2 ■ 12 C	K2.1 ■ 18 B	K2.2 ■ 14 B	K3.1 ■ 15 B	K3.2 ■ 11 B	K5.1 ■ 16 B	K5.2 ■ 12 B	N1.1 ■ 35 G	N1.2 ■ 25 G	N1.3 ■ 15 F	N2.1 ■ 15 F	N2.2 ■ 13 F
N3.1 ■ 16 E	N3.2 ■ 10 E	N3.3 ■ 5 C											

DCON MS passing h9.

Product	DC_2 (mm)	DC_1 (mm)	LCF (mm)	OAL (mm)	DCON MS (mm)	NOF
G6006.3	6.30	1.30	5.6	154.0	5.00	3
G6008.3	8.30	1.80	6.9	155.0	6.00	3
G60010.4	10.40	2.20	7.8	157.0	6.00	3
G60012.4	12.40	2.50	8.6	158.0	8.00	3
G60015.0	15.00	2.80	10.3	159.0	10.00	3
G60016.5	16.50	2.80	11.1	161.0	10.00	3
G60020.5	20.50	3.00	12.9	164.0	10.00	3
G60025.0	25.00	3.20	15.7	168.0	10.00	3



G132



HSS verzinkboor 90°, cilindrische schacht, meersnijder

Een 90° verzinkboor om gaten af te schuiven voor standaard bevestigingsmiddelen en om bramen uit geboorde gaten te verwijderen. Meervoudige spaangroeven om spanen en trillingen te verminderen, waardoor het afschuiven soepel verloopt. Veelzijdig gereedschap voor gebruik in hand- en machinetoepassingen. Geschikt voor het afschuiven van gaten in vele materialen.

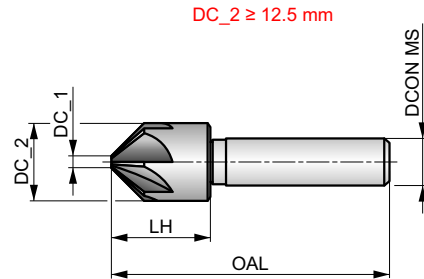
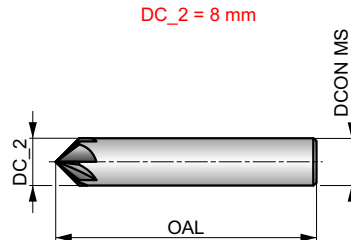

HSS	Bright	DIN 335A
R	90°	

De tabel geeft de geschiktheid aan voor de materiaalgroep en de startwaarden voor de snijnsnelheid (m/min) en de letter verwijst naar de toe te passen voeding (fn), zie vanaf pagina 251.

P2.2 18 E	P2.3 16 D	P3.2 13 D	P3.3 11 B	P4.1 10 D	P4.2 8 C	P4.3 7 B	M3.3 3 A	M4.1 4 A	K1.1 20 F	K1.2 15 D	K1.3 11 D	K2.2 17 C	K2.3 14 D
K3.1 18 E	K3.2 14 E	K3.3 11 D	K4.1 17 C	K4.2 13 C	K5.1 19	K5.2 15	K5.3 11 D	N1.3 20 F	N2.3 13 F	N3.2 12 F	N4.3 5 G		

DCON MS passing h9.

Product	DC_2 (mm)	DC_1 (mm)	LH (mm)	OAL (mm)	DCON MS (mm)	NOF
G1328.0	8.00	—	—	48.0	8.00	5
G13212.5	12.50	2.00	15.5	48.0	8.00	5
G13216.0	16.00	3.20	19.5	56.0	10.00	7
G13220.0	20.00	5.00	23.0	60.0	10.00	7



G138



HSS verzinkboor 90°, MC schacht

Een 90° verzinkboor, ontworpen voor het afschuiven van standaard bevestigingsgaten en het verwijderen van bramen uit geboorde gaten. Dankzij de conische schacht kan het gereedschap worden gebruikt voor directe opname in de MC spindel. Geschikt voor het afschuiven van gaten in vele materialen.

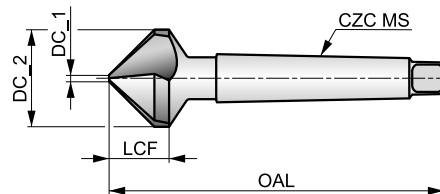

HSS	Bright	DIN 335D
R	90°	

De tabel geeft de geschiktheid aan voor de materiaalgroep en de startwaarden voor de snijsnelheid (m/min) en de letter verwijst naar de toe te passen voeding (fn), zie vanaf pagina 251.

P1.1 ■ 23 E	P1.2 ■ 26 E	P1.3 ■ 27 E	P2.1 ■ 20 E	P2.2 ■ 18 D	P2.3 ▣ 16 B	P3.1 ■ 16 D	P3.2 ▣ 13 D	P3.3 ▣ 11 B	P4.1 ■ 10 D	P4.2 ▣ 8 B	M1.1 ▣ 8	M1.2 ▣ 6	M2.1 ▣ 7
M2.2 ▣ 6	K1.1 ▣ 20 F	K1.2 ▣ 15 D	K2.1 ▣ 21 C	K2.2 ▣ 17 C	K3.1 ▣ 18 C	K3.2 ▣ 14 C	K5.1 ▣ 19 C	K5.2 ▣ 15 C	N1.1 ▣ 40 G	N1.2 ■ 30 G	N1.3 ▣ 20 F	N2.1 ■ 20 F	N2.2 ▣ 18 F
N3.1 ■ 21 F	N3.2 ■ 12 F	N3.3 ▣ 6 D	N4.1 ▣ 40 G	N4.2 ▣ 35 G									

Product	DC_2 (mm)	DC_1 (mm)	LCF (mm)	OAL (mm)	CZC MS	NOF
G13825.0	25.00	3.80	15.5	106.0	MK 2	3
G13830.0	30.00	4.20	18.5	112.0	MK 2	3
G13831.0	31.00	4.20	20.0	112.0	MK 2	3
G13834.0	34.00	4.50	19.5	118.0	MK 2	3
G13837.0	37.00	4.80	21.7	118.0	MK 2	3
G13840.0	40.00	10.00	20.5	140.0	MK 3	3
G13850.0	50.00	14.00	24.1	150.0	MK 3	3
G13863.0	63.00	16.00	28.5	180.0	MK 4	3
G13880.0	80.00	22.00	36.0	190.0	MK 4	3



G338



HSS verzinkboor 90°, MC schacht, TiN gecoat

Een 90° verzinkboor, ontworpen voor het afschuiven van standaard bevestigingsgaten en het verwijderen van bramen uit geboorde gaten. Dankzij de conische schacht kan het gereedschap worden gebruikt voor directe opname in de MC spindel. TiN coating verbetert de prestaties en verlengt de standtijd. Geschikt voor het afschuiven van gaten in vele materialen.

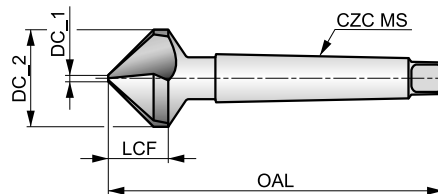

HSS	TiN	DIN 335D
R	90°	

De tabel geeft de geschiktheid aan voor de materiaalgroep en de startwaarden voor de snijsnelheid (m/min) en de letter verwijst naar de toe te passen voeding (fn), zie vanaf pagina 251.

P1.1 ■ 33 E	P1.2 ■ 37 E	P1.3 ■ 38 E	P2.1 ■ 28 E	P2.2 ■ 25 D	P2.3 ■ 22 B	P3.1 ■ 23 D	P3.2 ■ 18 D	P3.3 ■ 15 B	P4.1 ■ 13 D	P4.2 ■ 11 B	P4.3 ■ 9 B	M1.1 ■ 11 C	M1.2 ■ 9 C
M2.1 ■ 10 C	M2.2 ■ 9 C	M2.3 ■ 8 B	K1.1 ■ 34 F	K1.2 ■ 25 D	K1.3 ■ 19 D	K2.1 ■ 35 C	K2.2 ■ 28 C	K2.3 ■ 23 C	K3.1 ■ 31 C	K3.2 ■ 24 C	K3.3 ■ 19 C	K4.1 ■ 29 C	K4.2 ■ 22 C
K4.3 ■ 16 C	K5.1 ■ 32 C	K5.2 ■ 24 C	K5.3 ■ 19 C	N1.1 ■ 53 G	N1.2 ■ 40 G	N1.3 ■ 27 F	N2.1 ■ 27 F	N2.2 ■ 24 F	N2.3 ■ 17 F	N3.1 ■ 28 F	N3.2 ■ 16 F	N3.3 ■ 8 D	N4.1 ■ 58 G
N4.2 ■ 50 G													

Product	DC_2 (mm)	DC_1 (mm)	LCF (mm)	OAL (mm)	CZC MS	NOF
G33825.0	25.00	3.80	15.5	106.0	MK 2	3
G33831.0	31.00	4.20	20.0	112.0	MK 2	3
G33837.0	37.00	4.80	21.7	118.0	MK 2	3
G33840.0	40.00	10.00	20.5	140.0	MK 3	3
G33850.0	50.00	14.00	24.1	150.0	MK 3	3
G33863.0	63.00	16.00	28.5	180.0	MK 4	3



G171



HSS verzinkboor 100°, cilindrische schacht, TiAIN gecoat

Een 100° verzinkboor, ontworpen voor het afschuiven van standaard bevestigingsgaten en het verwijderen van bramen. Een veelzijdig gereedschap met een TiAIN coating die de prestaties verbetert en de standtijd verlengt. Veelzijdig gereedschap dat zowel met de hand als machinaal kan worden gebruikt. Geschikt voor het afschuiven van gaten in vele materialen.

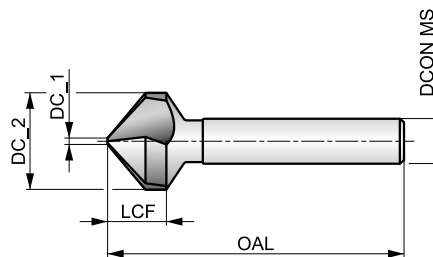

De tabel geeft de geschiktheid aan voor de materiaalgroep en de startwaarden voor de snijsnelheid (m/min) en de letter verwijst naar de toe te passen voeding (fn), zie vanaf pagina 251.

P1.1 ■ 40 E	P1.2 ■ 45 E	P1.3 ■ 46 E	P2.1 ■ 34 E	P2.2 ■ 30 D	P2.3 ■ 27 B	P3.1 ■ 28 D	P3.2 ■ 22 D	P3.3 ■ 19 B	P4.1 ■ 16 D	P4.2 ■ 14 B	P4.3 ▣ 11 B	M1.1 ▣ 11 C	M1.2 ▣ 9 C
M2.1 ▣ 10 C	K1.1 ■ 41 F	K1.2 ■ 30 D	K1.3 ▣ 23 D	K2.1 ■ 42 C	K2.2 ■ 34 C	K2.3 ▣ 27 C	K3.1 ■ 37 C	K3.2 ■ 28 C	K3.3 ▣ 23 C	K4.1 ▣ 34 C	K4.2 ▣ 26 C	K4.3 ▣ 19 C	K5.1 ■ 39 C
K5.2 ■ 29 C	K5.3 ▣ 23 C	N1.1 ▣ 60 G	N1.2 ▣ 45 G	N1.3 ■ 30 F	N2.1 ■ 30 F	N2.2 ■ 27 F	N2.3 ■ 19 F	N3.1 ■ 32 F	N3.2 ■ 18 F	N3.3 ▣ 9 D	N4.1 ▣ 62 G	N4.2 ▣ 55 G	

DCON MS passing h9.

Product	DC_2 (mm)	DC_1 (mm)	LCF (mm)	OAL (mm)	DCON MS (mm)	NOF
G1716.3	6.30	1.50	4.5	44.0	5.00	3
G1718.3	8.30	2.00	5.5	49.0	6.00	3
G17110.4	10.40	2.50	6.6	49.0	6.00	3
G17112.4	12.40	2.80	7.0	53.0	8.00	3
G17116.5	16.50	3.20	9.0	56.0	10.00	3
G17120.5	20.50	3.50	11.0	61.0	10.00	3
G17125.0	25.00	3.80	13.5	65.0	10.00	3



G314



HSS getrapte boor voor plaatmateriaal

Kegelvormige stappenboor hebben een meervoudig getrappt ontwerp, waardoor gaten geleidelijk kunnen worden vergroot tot de gewenste diameter. Door de gereduceerde schacht kunnen alle diameters in een standaard boorkop of opname worden geklemd. Geschikt voor het vergroten van gaten in vele materialen.

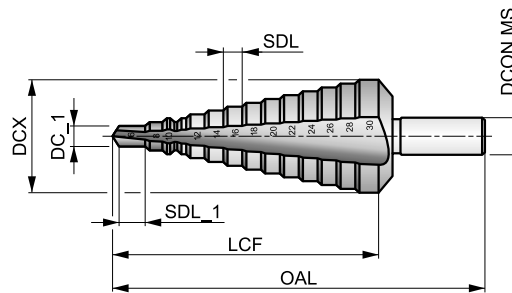

HSS	Bright	DORMER
R	20°	

De tabel geeft de geschiktheid aan voor de materiaalgroep en de startwaarden voor de snijsnelheid (m/min) en de letter verwijst naar de toe te passen voeding (fn), zie vanaf pagina 251.

P1.1 ■ 20	P1.2 ■ 22	P1.3 ■ 23	P2.1 ■ 17	P2.2 ■ 15	P2.3 ■ 13	P3.1 ■ 12	P3.2 ■ 9	M1.1 ■ 8	M1.2 ■ 6	M2.1 ■ 7	K1.1 ■ 17	N1.1 ■ 30	N1.2 ■ 23
N1.3 ■ 15	N2.1 ■ 31	N2.2 ■ 28	N3.1 ■ 34	N3.2 ■ 20	N3.3 ■ 10	N4.1 ■ 30	N4.2 ■ 20						

SDI = Stapgrote in diameter.

Product	Nr.	DC_1	DCX	SDL	SDI	SDL_1	LCF	OAL	DCON MS
		(mm)	(mm)	(mm)	(mm)	(mm)	(mm)	(mm)	(mm)
G314412	412	4.00	12.00	5.00	4 - 5 - 6 - 7 - 8 - 9 - 10 - 11 - 12	5.00	61.0	80.0	6.00
G3141220	1220	12.00	20.00	4.00	12 - 13 - 14 - 15 - 16 - 17 - 18 - 19 - 20	4.00	55.0	76.0	9.00
G3142030	2030	20.00	30.00	4.00	20 - 21 - 22 - 23 - 24 - 25 - 26 - 27 - 28 - 29 - 30	4.00	67.0	88.0	12.00
G3143040	3040	30.00	40.00	4.00	30 - 31 - 32 - 33 - 34 - 35 - 36 - 37 - 38 - 39 - 40	4.00	74.0	98.0	13.00
G314420	420	4.00	20.00	4.00	4 - 6 - 8 - 10 - 12 - 14 - 16 - 18 - 20	4.00	48.0	76.0	8.00
G314630	630	6.00	30.00	4.00	6 - 8 - 10 - 12 - 14 - 16 - 18 - 20 - 22 - 24 - 26 - 28 - 30	4.00	73.0	98.0	10.00
G314M	M	9.00	36.00	3.00	9 - 12 - 15 - 18 - 21 - 24 - 27 - 30 - 33 - 36	3.00	57.0	86.0	12.00



G125



HSS 180° kopverzinkboor

Kopverzinkboor met een hoek van 180°, ontworpen om gaten te maken voor standaard inbus- en dopschroeven. Heeft een niet borende voorgeleiding. Beschikbaar voor verschillende maatvoeringen van de geboorde gaten. Hierdoor wordt het mogelijk de verzinking zuiver concentrisch met het geboorde gat te maken. Geschikt voor toepassing in vele materialen.

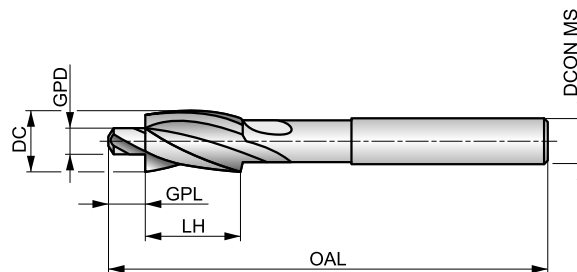

HSS	Bright	DIN 373
R	180°	

De tabel geeft de geschiktheid aan voor de materiaalgroep en de startwaarden voor de snijsnelheid (m/min) en de letter verwijst naar de toe te passen voeding (fn), zie vanaf pagina 251.

P1.1 ■ 20 E	P1.2 ■ 22 E	P1.3 ■ 23 E	P2.1 ■ 17 E	P2.2 ■ 15 D	P2.3 ■ 13 C	P3.1 ■ 12 D	P3.2 ■ 9 D	P3.3 ■ 8 C	P4.1 ■ 7 D	P4.2 ■ 6 C	M1.1 ■ 8 D	M1.2 ■ 6 D	M2.1 ■ 7 D
M2.2 ■ 6 D	M2.3 ■ 5 C	K1.1 ■ 17 E	K1.2 ■ 12 E	K1.3 ■ 11 E	K2.1 ■ 15 D	K2.2 ■ 12 D	K2.3 ■ 10 C	K3.1 ■ 13 D	K3.2 ■ 10 D	K4.1 ■ 12 D	K4.2 ■ 9 D	K5.1 ■ 14 D	K5.2 ■ 10 D
N1.1 ■ 30 G	N1.2 ■ 23 G	N1.3 ■ 15 G	N2.1 ■ 31 G	N2.2 ■ 28 G	N2.3 ■ 20 G	N3.1 ■ 34 C	N3.2 ■ 20 C	N3.3 ■ 10 C	N4.1 ■ 30 C	N4.2 ■ 20 C			

DCON MS passing h9.

Product	DC (mm)	GPD (mm)	CZC MS	GPL (mm)	OAL (mm)	LH (mm)	DCON MS (mm)	NOF
G1256.5X2.5 ³⁾	6.50	2.50	M 3 t	4.50	71.0	14.0	5.00	3
G1256.5X3.2 ¹⁾	6.50	3.20	M 3 f	4.50	71.0	14.0	5.00	3
G1256.5X3.4 ²⁾	6.50	3.40	M 3 m	4.50	71.0	14.0	5.00	3
G1258.0X3.3 ³⁾	8.00	3.30	M 4 t	5.00	71.0	14.0	5.00	3
G1258.0X4.3 ¹⁾	8.00	4.30	M 4 f	5.00	71.0	14.0	5.00	3
G1258.0X4.5 ²⁾	8.00	4.50	M 4 m	5.00	71.0	14.0	5.00	3
G12510.0X4.2 ³⁾	10.00	4.20	M 5 t	5.50	80.0	18.0	8.00	3
G12510.0X5.3 ¹⁾	10.00	5.30	M 5 f	5.50	80.0	18.0	8.00	3
G12510.0X5.5 ²⁾	10.00	5.50	M 5 m	5.50	80.0	18.0	8.00	3
G12511.0X5.0 ³⁾	11.00	5.00	M 6 t	6.00	80.0	18.0	8.00	3
G12511.0X6.4 ¹⁾	11.00	6.40	M 6 f	6.00	80.0	18.0	8.00	3
G12511.0X6.6 ²⁾	11.00	6.60	M 6 m	6.00	80.0	18.0	8.00	3
G12515.0X6.8 ³⁾	15.00	6.80	M 8 t	8.00	100.0	22.0	12.50	3
G12515.0X8.4 ¹⁾	15.00	8.40	M 8 f	8.00	100.0	22.0	12.50	3
G12515.0X9.0 ²⁾	15.00	9.00	M 8 m	8.00	100.0	22.0	12.50	3
G12518.0X8.5 ³⁾	18.00	8.50	M 10 t	10.00	100.0	22.0	12.50	3
G12518.0X10.5 ¹⁾	18.00	10.50	M 10 f	10.00	100.0	22.0	12.50	3
G12518.0X11.0 ²⁾	18.00	11.00	M 10 m	10.00	100.0	22.0	12.50	3
G12520.0X10.2 ³⁾	20.00	10.20	M 12 t	10.00	100.0	22.0	12.50	3
G12520.0X13.0 ¹⁾	20.00	13.00	M 12 f	10.00	100.0	22.0	12.50	3
G12520.0X13.5 ²⁾	20.00	13.50	M 12 m	10.00	100.0	22.0	12.50	3

¹⁾ f= voor een doorlopend gat, fijn.

²⁾ m= voor een doorlopend gat, medium.

³⁾ t= voor tapgat.



G236



HSS verzinkboren set in een ronde kunststof cassette

Sets met verschillende maten 90° verzinkboren. Er zijn 5 verschillende sets gevuld met G106, G136 of G560 verkrijgbaar. Geschikt voor vele materialen.

A=type, B=aantal, C=diameters.

Product	Nr.	A	B	C
G2361	1	G136	6	6.30 mm, 8.30 mm, 10.40 mm, 12.40 mm, 16.50 mm, 20.50 mm
G2362	2	G136	4	6.30 mm, 10.40 mm, 16.50 mm, 20.50 mm
G2363	3	G560	6	6.30 mm, 8.30 mm, 10.40 mm, 12.40 mm, 16.50 mm, 20.50 mm
G2364	4	G106	6	6.30 mm, 8.30 mm, 10.40 mm, 12.40 mm, 16.50 mm, 20.50 mm
G2365	5	G506	6	6.30 mm, 8.30 mm, 10.40 mm, 12.40 mm, 16.50 mm, 20.50 mm



VOEDINGSTABEL VOOR RUIMERS

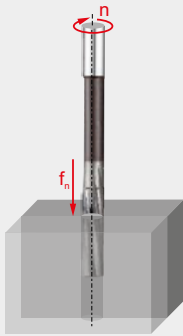

Voeding per omwenteling (f_n in mm/omw)
Afhankelijk van de werkomstandigheden
kan het nodig zijn om deze
aan te passen met $\pm 15\%$.

Hoe gebruik je deze tabel om de voeding per omwenteling (f_n) te bepalen:

1. Zoek uw Alpha Code op de productpagina (voorbeeld: 21C,,C" is de Alpha Code).
2. Zoek de dichtstbijzijnde diameter voor uw snijtoepassing in de bovenste rij van de tabel.
3. Zoek uw Alpha Code in de linker kolom van de tabel.
4. Het snijpunt (cel) van de Diameter en Alpha Code is de voeding per omwenteling (f_n).

		ø DC (mm)																		
		1.00	1.50	2.00	3.00	4.00	5.00	6.00	7.00	8.00	10.00	12.00	15.00	16.00	20.00	25.00	30.00	40.00	50.00	80.00
Voedingssnelheden	A	0.030	0.045	0.055	0.078	0.090	0.100	0.125	0.137	0.150	0.170	0.185	0.210	0.220	0.250	0.280	0.320	0.390	0.440	0.500
	B	0.035	0.055	0.072	0.110	0.130	0.150	0.165	0.172	0.180	0.210	0.240	0.270	0.280	0.310	0.360	0.400	0.500	0.550	0.600
	C	0.040	0.065	0.085	0.135	0.160	0.185	0.200	0.210	0.220	0.260	0.285	0.325	0.335	0.390	0.440	0.480	0.600	0.680	0.750
	D	0.050	0.080	0.110	0.160	0.180	0.200	0.235	0.253	0.270	0.320	0.360	0.400	0.410	0.470	0.540	0.600	0.730	0.850	0.950
	E	0.065	0.100	0.140	0.180	0.215	0.250	0.300	0.325	0.350	0.390	0.430	0.485	0.500	0.530	0.640	0.750	0.910	1.100	1.200
	F	0.090	0.140	0.180	0.260	0.305	0.350	0.395	0.417	0.440	0.500	0.550	0.610	0.630	0.700	0.800	0.930	1.200	1.500	1.650

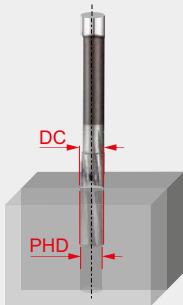

Bewerkingstoeslag (MA in mm)
voor machineruimers. Voor te boren
gat PHD=DC-MA

Hoe gebruik je deze tabel om tot het juiste diameter van het voor te boren gat (PHD) te komen:

1. Zoek het diameterbereik voor uw toepassing in de bovenste rij van de tabel.
2. Zoek uw ISO Groep Code in de linker kolom van de tabel (voorbeeld: Voor roestvast staal is de ISO-groepscode: „M“).
3. Het snijpunt (cel) van de Diameter Range en ISO Group Code is de bewerkingstoeslag (MA).
4. Trek de bewerkingstoeslag af van de ruimdiameter om te komen tot de diameter van het voor te boren gat (PHD).

(voorbeeld: voor een 6 mm gat in staal (P) is de PHD 5.85 mm)

		ø DC (mm)											
		1.00	5.00	5.00	8.00	8.00	12.00	12.00	16.00	16.00	30.00	30.00	80.00
ISO groep	P	0.10			0.15		0.20		0.20		0.30		0.30
	M	0.08			0.10		0.10		0.20		0.20		0.30
	K	0.10			0.15		0.20		0.20		0.30		0.30
	N	0.10			0.15		0.20		0.20		0.30		0.30
	S	0.05			0.10		0.10		0.15		0.20		0.20
	H	0.05			0.05		0.10		0.10		0.15		0.20

Pas op met de bewerkingstoleranties van boren, de diameter van het gereedschap is niet gelijk aan de geproduceerde gatdiameter!

Opmerking: De aanbevolen tolerantie bij gebruik van een handruimer is 0,05 tot 0,10 mm.



VOEDINGSTABEL VOOR VERZINKBOREN

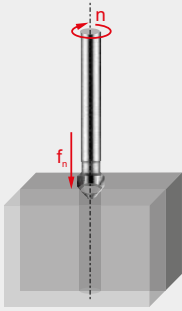

Voeding per omwenteling (f_n in mm/omw)
Afhankelijk van de werkomstandigheden
kan het nodig zijn om deze
aan te passen met $\pm 15\%$.

Hoe gebruik je deze tabel om de voeding per omwenteling (f_n) te vinden:

1. Zoek uw Alpha Code op de productpagina (voorbeeld: 23E, „E“ is de Alpha Code).
2. Zoek de dichtstbijzijnde diameter voor uw snijtoepassing in de bovenste rij van de tabel.
3. Zoek uw Alpha Code in de linker kolom van de tabel.
4. Het snijpunt (cel) van de diameter en Alpha Code is de voeding per omwenteling (f_n).

		$\varnothing DC$ (mm)									
		6.00	8.00	10.00	16.00	20.00	25.00	32.00	40.00	60.00	80.00
Voedingsnelheden	A	0.030	0.040	0.050	0.060	0.080	0.090	0.100	0.120	0.140	0.160
	B	0.040	0.050	0.060	0.080	0.100	0.120	0.140	0.160	0.180	0.200
	C	0.050	0.060	0.080	0.100	0.120	0.140	0.160	0.180	0.200	0.220
	D	0.060	0.080	0.100	0.120	0.150	0.180	0.200	0.220	0.250	0.280
	E	0.080	0.100	0.120	0.150	0.180	0.200	0.250	0.270	0.300	0.320
	F	0.090	0.110	0.130	0.160	0.190	0.210	0.260	0.290	0.330	0.360
	G	0.100	0.120	0.150	0.180	0.200	0.220	0.280	0.320	0.360	0.400
	H	0.120	0.150	0.180	0.200	0.220	0.250	0.300	0.350	0.400	0.450

Ruimer definities / benamingen

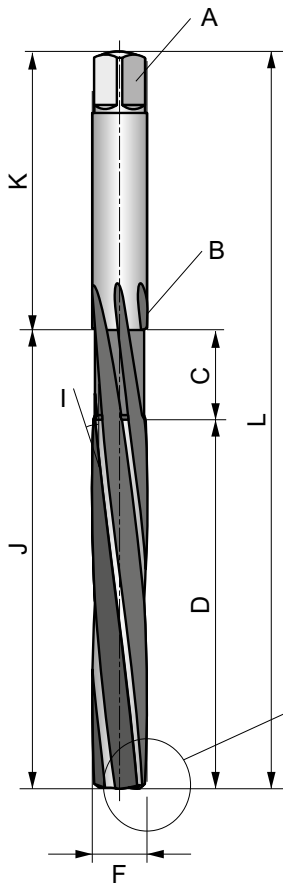

A	Lip of aandrijfvierkant
B	Diameter hals
C	Lengte hals
D	Snijlengte
E	Lengte aansnijding
F	Diameter

G	Aansnijding
H	Aansnijdingshoek
I	Spiraalhoek
J	Lengte ruimerlichaam
K	Lengte schacht
L	Totale lengte

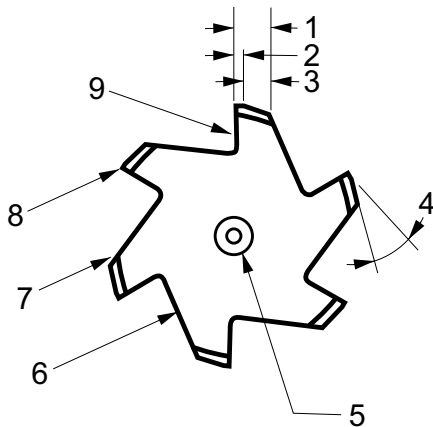
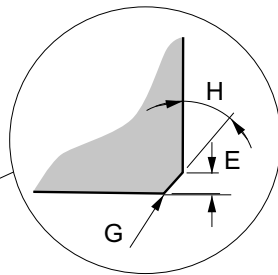

1	Breedte van de tand
2	Geleidingsrand
3	Vrijlooprugvlak
4	Hoek vrijlooprugvlak
5	Centergat
6	Spaangroef
7	Hiel
8	Snijkant
9	Spaanvlak

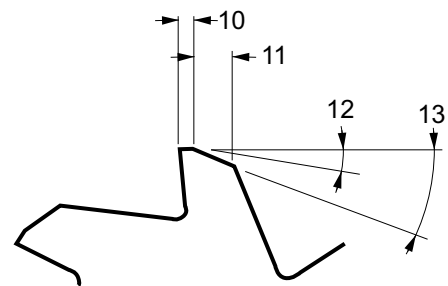

10	Breedte van de geleiderand
11	Breedte van het vrijlooprugvlak
12	Primaire vrijloophoek
13	Secondaire vrijloophoek



RUIMEN - TECHNISCHE INFORMATIE

Ruimen

Om de beste resultaten te bereiken met ruimen is het essentieel om ze te laten "werken". Het is een veel voorkomende fout dat bij de voorbereiding van ruimen te weinig materiaal voor het ruimen wordt overgelaten. Daardoor zal de ruimer meer gaan wrijven of schrapen in plaats van snijden, waardoor er veel onnodige slijtage en afwijking van de gewenste diameter optreedt. Het is zeker zo belangrijk om niet teveel materiaal te laten staan, omdat dit ook de prestaties van de ruimer nadelig beïnvloed. (Zie "Verspaand Volume" op de volgende pagina).

1. Selecteer het juiste type ruimer en de optimale voeding en snijnelheid voor het te bewerken werkstuk. Zorg dat de voorgeboorde gaten de juiste diameter hebben.
2. Het werkstuk moet stabiel opgespannen zijn en de machine spil mag geen speling vertonen.
3. De opname waarin een ruimer met cilindrische schacht is opgespannen moet van goede kwaliteit zijn. Als de ruimer meedraait of slijpt in de spantang tijdens een automatische voeding kan breuk van de ruimer het gevolg zijn.

4. Wanneer men een ruimer met een morseconus opspant in de bus, huls of de machinespil, gebruik dan altijd een hamer met een zachte kop. Zorg ervoor dat de morseconus en de bus, huls of machinespil schoon zijn en goed in elkaar passen, anders staat de ruimer uit het midden zodat overmaat een gevolg kan zijn.
5. Houd de uitsteeklengte van de ruimer ten opzichte van de machinespil zo kort mogelijk.
6. Gebruik aanbevolen smeermiddelen om de standtijd van de ruimer te bevorderen, en zorg dat het smeermiddel de snijkanten bereikt. Bij grijs gietijzer wordt, indien droogverspaand, perslucht aanbevolen.
7. Voorkom spaanophopingen in de spaangroeven van de ruimer.
8. Voordat de ruimer nageslepen wordt, moet men de rondlooppauwkeurigheid van de ruimer tussen de centers controleren. In veel voorkomende gevallen behoeft alleen de aansnijding geslepen te worden.

Bewerkingstoeslag

De aanbevolen bewerkingstoeslag voor het ruimen is afhankelijk van het werkstuk-materiaal en de oppervlakte gesteldheid van het voorgeboorde gat. Algemene richtwaarden voor bewerkingstoeslag zijn in de volgende tabellen weergegeven:

Diam. van het te ruimen gat (mm)	Toeslag	Toeslag bij 4-lippenboor
Minder dan 4	0.1	0.1
Van 4 t/m 11	0.2	0.15
Van 11 t/m 39	0.3	0.2
Van 39 t/m 50	0.4	0.3

Diam. van het te ruimen gat (inches)	Toeslag	Toeslag bij 4-lippenboor
Minder dan 3/16"	0.004"	0.004"
3/16" t/m 1/2"	0.008"	0.006"
1/2" t/m 1 1/2"	0.010"	0.008"
1 1/2" t/m 2"	0.016"	0.010"

Hand/Machine ruimen

Hoewel zowel handruimers als machineruimers dezelfde mogelijkheden bieden wat betreft de uiteindelijke grootte van de gaten, moet het gebruik van elk van beide worden overwogen naar gelang van de toepassing. Een handruimer heeft, omwille van de uitlijning, een lange conische aansnijding, terwijl een machineruimer slechts een schuine aansnijding van 45 graden heeft. Een machineruimer snijdt alleen op de schuine aansnijding, terwijl een handruimer zowel op de schuine als op de conische aansnijding snijdt.

RUIMEN - GRENSMATEN - TECHNISCHE INFORMATIE

Tolerantie

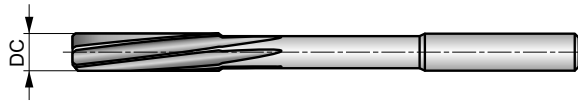

1. De snijdende diameter van standaard ruimers

De diameter (DC) wordt gemeten over het cilindrische deel vlak achter de aansnijding. De tolerantie is in overeenstemming met DIN 1420 en is bedoeld voor het produceren van gaten met een tolerantie van H7.

Ruimer tolerantie			
Diameter (mm)		Tolerantie (mm)	
Van	t/m	Hoog +	Laag +
–	3	0.008	0.004
3	6	0.010	0.005
6	10	0.012	0.006
10	18	0.015	0.008

Ruimer tolerantie			
Diameter (mm)		Tolerantie (mm)	
Van	t/m	Hoog +	Laag +
18	30	0.017	0.009
30	50	0.021	0.012
50	80	0.025	0.014

2. Gattolerantie H7

De meest voorkomende tolerantie voor een geruimd gat is H7 (zie tabel hieronder). Voor elke andere tolerantie kan de tabel en de figuur onder punt 3 gebruikt worden om de ruimer tolerantie en diameter te berekenen.

Ruimer tolerantie			
Diameter (mm)		Tolerantie (mm)	
Van	t/m	Hoog +	Laag +
–	3	0.010	0
3	6	0.012	0
6	10	0.015	0
10	18	0.018	0

Ruimer tolerantie			
Diameter (mm)		Tolerantie (mm)	
Van	t/m	Hoog +	Laag +
18	30	0.021	0
30	50	0.025	0
50	80	0.030	0

3. Andere passingen

Om de afmeting van een ruimer te bepalen voor een afwijkende tolerantie of passing kan de volgende tabel en figuur gebruikt worden.

Diameter tolerantie bereik (µm)								
Tolerantie bereik	van 1 t/m 3	van 3 t/m 6	van 6 t/m 10	van 10 t/m 18	van 18 t/m 30	van 30 t/m 50	van 50 t/m 80	van 80 t/m 120
IT5	4	5	6	8	9	11	13	15
IT6	6	8	9	11	13	16	19	22
IT7	10	12	15	18	21	25	30	35
IT8	14	18	22	27	33	39	46	54
IT9	25	30	36	43	52	62	74	87
IT10	40	48	58	70	84	100	120	140
IT11	60	75	90	110	130	160	190	220
IT12	100	120	150	180	210	250	300	350

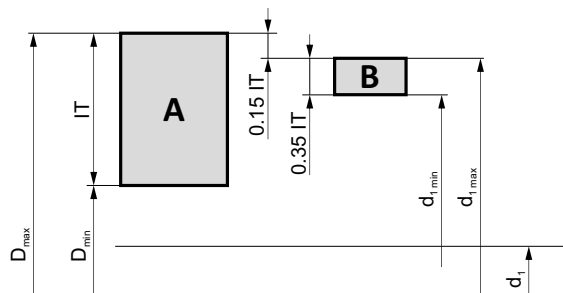

- A** = Gat tolerantie
- B** = Ruimer tolerantie
- IT** = Tolerantie bereik
- D_{max} = Max. diameter van het gat
- D_{min} = Min. diameter van het gat
- d_i = Nominale diameter
- d_{1max} = Max. diameter van de ruimer
- d_{1min} = Min. diameter van de ruimer

Voorbeeld van een 10 mm gat met een D8 tolerantie,
 Maximum diameter van het gat = 10,062, Minimum diameter van het gat = 10,040, Gat tolerantie (IT8) = 0,022
 Maximale tolerantie: 0,15 x gat tolerantie (IT8) = 0,0033, afgerond op 0,004
 Minimale tolerantie: 0,35 x gat tolerantie (IT8) = 0,0077, afgerond op 0,008
 Maximale tolerantie voor de ruimer = 10,062 – 0,004 = 10,058
 Minimale tolerantie voor de ruimer = 10,058 – 0,008 = 10,050

Toepassing - Ruimer selectie

De meest gebruikte ruimertypes hebben een linkse spiraal omdat de belangrijkste toepassingen doorlopende gaten zijn waarbij het wenselijk is dat de spanen vooruit worden geduwd. Voor blinde gaten worden ruimers met rechte spaangroeven aanbevolen.

De meest efficiënte ruimcondities hangen af van de toepassing, het materiaal, kwaliteit van het vereiste gat, materiaalafname, smering en andere factoren. Een algemene richtlijn voor snijsnelheden en voedingen voor machineruimers wordt getoond in de WMG snijsnelheid en voedingstabellen voor ruimen.

Zeer ongelijke tandsteek bij ruimers betekent dat de ruimte tussen de tanden niet voor elke tand hetzelfde is. Omdat er geen twee tanden diametraal tegenover elkaar staan tegenover elkaar staan, produceert de ruimer een gat met een rondheidsvariatie van slechts 1 - 2 μm . Dit in vergelijking met een afwijking tot 10 μm met conventionele ongelijke tandafstanden.

Hardmetaal ruimers - Vergelijk ongelijke en extreem ongelijke tandsteek

Ongelijke tandsteek
Onrondheid tot 10 μm

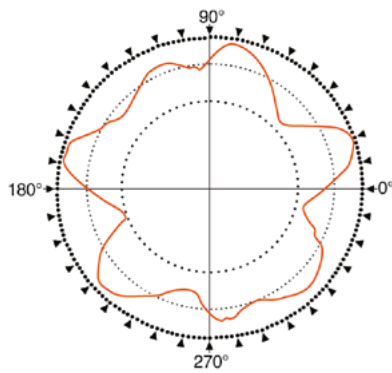

Rondheid

Extreem ongelijke tandsteek
Onrondheid tot 1 - 2 μm

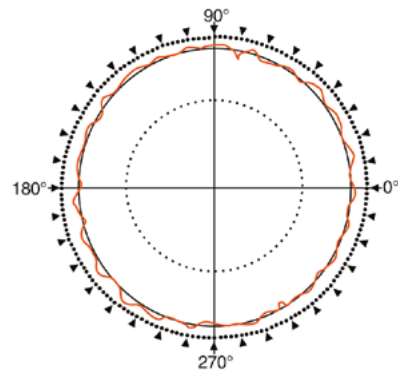

Rondheid



RUIMEN - ALGEMENE TIPS - TECHNISCHE INFORMATIE

Problemen / oorzaken / oplossingen bij het ruimen

Probleem	Oorzaak	Oplossing
Gebroken of verdraaide lip	Onjuiste passing tussen schacht en opname	Zorg ervoor dat de schacht en de opname schoon en vrij van beschadigingen zijn.
Snelle slijtage	Te weinig bewerkingstoeslag	Verhoog de bewerkingstoeslag.
Overmaats gat	Extreem hoogteverschil in snijkantshoogte	Herslijp naar de juiste specificatie.
	Foutieve positie van de machinespindel	Corrigeer en herpositioneer de machine spindel.
	Beschadigingen aan de gereedschaphouder	Vervang de gereedschaphouder.
	Schacht van het gereedschap is beschadigd	Vervang het gereedschap of slijp de schacht.
	Onrondheid van het gereedschap	Vervang of herslijp het gereedschap.
	Asymmetrische aansnijding	Herslijpen naar de correcte specificatie.
	Te hoge voeding in verhouding tot de snijsnelheid.	Pas de snijwaarden aan volgens de snijgegevens in de catalogus of de Product Selector.
Ondermaats gat	Onvoldoende hoeveelheid bewerkingstoeslag	Verhoog de materiaaltoeslag.
	Er wordt te veel hitte ontwikkeld tijdens het ruimen. Het gat krimpt en zet uit.	Vermeerder de koeling.
	De ruimer is versleten en ondermaats	Vervang de ruimer.
	Te lage voeding of snijsnelheid	Pas de snijwaarden aan volgens de snijgegevens in de Dormer Product Selector.
	Het voorgeboorde gat is te klein	Verminder de bewerkingstoeslag.
Ovale en conische gaten	Foutieve positie van de machine spindel	Controleer en herpositioneer de machine spindel.
	Het gereedschap en het gat liggen niet in een lijn	Gebruik een opruimboor.
	Asymmetrische aansnijding	Herslijp naar correcte specificatie.
Slechte oppervlakte-gesteldheid van het gat	Overmatige bewerkingstoeslag	Verminder de bewerkingstoeslag.
	Versleten ruimer	Herslijp volgens specificatie.
	Te kleine aansnijding	Herslijp volgens specificatie.
	Te schrale emulsie of snijolie	Verhoog de concentratie.
	Snijsnelheid en/of voeding te laag	Pas de waarden aan volgens de gegevens in de catalogus.
	Snijsnelheid te hoog	Pas de waarden aan volgens de gegevens in de catalogus.
Het gereedschap klemt en breekt af	Versleten ruimer	Herslijp volgens specificatie.
	De vrijloop van de ruimer is te klein	Controleer en vervang de ruimer, of pas deze aan.
	De breedte van de fase is te groot	Controleer en vervang de ruimer, of pas deze aan.
	Het materiaal neigt tot klemmen	Gebruik een verstelbare ruimer om de tolerantie te compenseren.
	Het voorgeboorde gat is te klein	Verminder de bewerkingstoeslag.
	Harde plekken in het te bewerken materiaal	Gebruik een volhardmetaal ruimer.



ALGEMEEN - TECHNISCHE INFORMATIE

	Soort	Hardheid (HV10)	C %	W %	Mo %	Cr %	V %	Co %	Basismateriaal
	M2	810 – 850	0.9	6.4	5.0	4.2	1.8	–	HSS
	M35	830 – 870	0.93	6.4	5.0	4.2	1.8	4.8	HSCO
	M42	870 – 960	1.08	1.5	9.4	3.9	1.2	8.0	

Kenmerken	HSS materialen	Hardmetaal	K10/30F (meest toegepast bij VHM gereedschap)
Hardheid (HV30)	800-950	1300 – 1800	1600
Dichtheid (g/cm ³)	8.0 – 9.0	7.2 – 15	14.45
Drukvastheid (N/mm ²)	3000 – 4000	3000 – 8000	6250
Buigvastheid (N/mm ²)	2500 – 4000	1000 – 4700	4300
Hittebestendigheid (°C)	550	1000	900
E-module (KN/mm ²)	260 – 300	460 – 630	580
Korrelgrootte (µm)	–	0.2 – 10	0.8

De verhouding van harde delen (WC) en het bindmetaal (Co) geeft de volgende veranderingen in de eigenschappen.

Karakteristiek	Hoger WC gehalte geeft	Hoger Co gehalte geeft
Hardheid	Hogere hardheid	Minder hardheid
Drukvastheid (CS)	Hoger CS	Lager CS
Buigvastheid (BS)	Lager BS	Hoger BS

Ook de korrelgrootte beïnvloedt de materiaaleigenschappen. Kleine korrelgroottes betekenen een hogere hardheid en grove korrels geven meer taaierheid.

Kenmerken van Oppervlaktebehandelingen en Coatings

Oppervlakte behandeling	Kleur	Coating materiaal	Hardheid (HV)	Dikte (µm)	Coating structuur	Wrijvings coëfficiënt t.o.v. staal	Max. inzet tot °C
	Goud	TiN	2300	1-4	Enkellaags	0.4	600
	Donker grijs	TiAlN	3300	3	Nano structuur	0.3-0.35	900



ALGEMEEN - TECHNISCHE INFORMATIE

Industrienormen voor de passing van schachten en gaten

Tolerantiewaarden worden getoond in microns (μm)

Formule voor microns ...1 $\mu\text{m} = 0.001 \text{ mm} / 0.000039''$

Tolerantie	Diameter (mm)							
	> 1 ≤ 3	> 3 ≤ 6	> 6 ≤ 10	> 10 ≤ 18	> 18 ≤ 30	> 30 ≤ 50	> 50 ≤ 80	> 80 ≤ 120
	Diameter (inch)							
	> 0.039'' ≤ 0.118''	> 0.118'' ≤ 0.236''	> 0.236'' ≤ 0.394''	> 0.394'' ≤ 0.709''	> 0.709'' ≤ 1.181''	> 1.181'' ≤ 1.968''	> 1.968'' ≤ 3.149''	> 3.149'' ≤ 4.724''
	Tolerantiewaarden (μm)							
e8	-14 / -28	-20 / -38	-25 / -47	-32 / -59	-40 / -73	-50 / -89	-60 / -106	-72 / -126
f6	-6 / -12	-10 / -18	-13 / -22	-16 / -27	-20 / -33	-25 / -41	-30 / -49	-36 / -58
f7	-6 / -16	-10 / -22	-13 / -28	-16 / -34	-20 / -41	-25 / -50	-30 / -60	-36 / -71
h6	0 / -6	0 / -8	0 / -9	0 / -11	0 / -13	0 / -16	0 / -19	0 / -22
h7	0 / -10	0 / -12	0 / -15	0 / -18	0 / -21	0 / -25	0 / -30	0 / -35
h8	0 / -14	0 / -18	0 / -22	0 / -27	0 / -33	0 / -39	0 / -46	0 / -54
h9	0 / -25	0 / -30	0 / -36	0 / -43	0 / -52	0 / -62	0 / -74	0 / -87
h10	0 / -40	0 / -48	0 / -58	0 / -70	0 / -84	0 / -100	0 / -120	0 / -140
h11	0 / -60	0 / -75	0 / -90	0 / -110	0 / -130	0 / -160	0 / -190	0 / -220
h12	0 / -100	0 / -120	0 / -150	0 / -180	0 / -210	0 / -250	0 / -300	0 / -350
k10	+ 40 / 0	+ 48 / 0	+ 58 / 0	+ 70 / 0	+ 84 / 0	+ 100 / 0	+ 120 / 0	+ 140 / 0
k12	+ 100 / 0	+ 120 / 0	+ 150 / 0	+ 180 / 0	+ 210 / 0	+ 250 / 0	+ 300 / 0	+ 350 / 0
m7	+ 2 / + 12	+ 4 / + 16	+ 6 / + 21	+ 7 / + 25	+ 8 / + 29	+ 9 / + 34	+ 11 / + 41	+ 13 / + 48
js14	+ / -125	+ / -150	+ / -180	+ / -215	+ / -260	+ / -310	+ / -370	+ / -435
js16	+ / -300	+ / -375	+ / -450	+ / -550	+ / -650	+ / -800	+ / -950	+ / -1100
H7	+ 10 / 0	+ 12 / 0	+ 15 / 0	+ 18 / 0	+ 21 / 0	+ 25 / 0	+ 30 / 0	+ 35 / 0
H8	+ 14 / 0	+ 18 / 0	+ 22 / 0	+ 27 / 0	+ 33 / 0	+ 39 / 0	+ 46 / 0	+ 54 / 0
H9	+ 25 / 0	+ 30 / 0	+ 36 / 0	+ 43 / 0	+ 52 / 0	+ 62 / 0	+ 74 / 0	+ 87 / 0
H12	+ 100 / 0	+ 120 / 0	+ 150 / 0	+ 180 / 0	+ 210 / 0	+ 250 / 0	+ 300 / 0	+ 350 / 0
P9	-6 / -31	-12 / -42	-15 / -51	-18 / -61	-22 / -74	-26 / -86	-32 / -106	-37 / -124
S7	-13 / -22	-15 / -27	-17 / -32	-21 / -39	-27 / -48	-34 / -59	-42 / -72	-58 / -93



ALGEMEEN - TECHNISCHE INFORMATIE

Snijsnelheidstabel

		Vc															
m/min.		5	8	10	15	20	25	30	40	50	60	70	80	90	100	110	150
SFM (feet/min.)		16	26	32	50	66	82	98	130	165	197	230	262	296	330	362	495
Ø		Toerental															
mm	inch																
1.00	–	1592	2546	3183	4775	6366	7958	9549	12732	15916	19099	22282	25465	28648	31831	35014	47747
1.50	–	1061	1698	2122	3183	4244	5305	6366	8488	10610	12732	14854	16977	19099	21221	23343	31831
2.00	–	796	1273	1592	2387	3183	3979	4775	6366	7958	9549	11141	12732	14324	15916	17507	23873
2.50	–	637	1019	1273	1910	2546	3183	3820	5093	6366	7639	8913	10186	11459	12732	14006	19099
3.00	–	531	849	1061	1592	2122	2653	3183	4244	5305	6366	7427	8488	9549	10610	11671	15916
3.18	1/8	500	801	1001	1501	2002	2502	3003	4004	5005	6006	7007	8008	9009	10010	11011	15015
3.50	–	455	728	909	1364	1819	2274	2728	3638	4547	5457	6366	7276	8185	9095	10004	13642
4.00	–	398	637	796	1194	1592	1989	2387	3183	3979	4775	5570	6366	7162	7958	8754	11937
4.50	–	354	566	707	1061	1415	1768	2122	2829	3537	4244	4951	5659	6366	7074	7781	10610
4.76	3/16	334	535	669	1003	1337	1672	2006	2675	3344	4012	4681	5350	6018	6687	7356	10031
5.00	–	318	509	637	955	1273	1592	1910	2546	3183	3820	4456	5093	5730	6366	7003	9549
6.00	–	265	424	531	796	1061	1326	1592	2122	2653	3183	3714	4244	4775	5305	5836	7958
6.35	1/4	251	401	501	752	1003	1253	1504	2005	2506	3008	3509	4010	4511	5013	5514	7519
7.00	–	227	364	455	682	909	1137	1364	1819	2274	2728	3183	3638	4093	4547	5002	6821
7.94	5/16	200	321	401	601	802	1002	1203	1604	2004	2405	2806	3207	3608	4009	4410	6013
8.00	–	199	318	398	597	796	995	1194	1592	1989	2387	2785	3183	3581	3979	4377	5968
9.00	–	177	283	354	531	707	884	1061	1415	1768	2122	2476	2829	3183	3537	3890	5305
9.53	3/8	167	267	334	501	668	835	1002	1336	1670	2004	2338	2672	3006	3340	3674	5010
10.00	–	159	255	318	477	637	796	955	1273	1592	1910	2228	2546	2865	3183	3501	4775
11.11	7/16	143	229	287	430	573	716	860	1146	1433	1719	2006	2292	2579	2865	3152	4298
12.00	–	133	212	265	398	531	663	796	1061	1326	1592	1857	2122	2387	2653	2918	3979
12.70	1/2	125	201	251	376	501	627	752	1003	1253	1504	1754	2005	2256	2506	2757	3760
14.00	–	114	182	227	341	455	568	682	909	1137	1364	1592	1819	2046	2274	2501	3410
14.29	9/16	111	178	223	334	446	557	668	891	1114	1337	1559	1782	2005	2228	2450	3341
15.00	–	106	170	212	318	424	531	637	849	1061	1273	1485	1698	1910	2122	2334	3183
15.88	5/8	100	160	200	301	401	501	601	802	1002	1203	1403	1604	1804	2004	2205	3007
16.00	–	99	159	199	298	398	497	597	796	995	1194	1393	1592	1790	1989	2188	2984
17.46	11/16	91	146	182	273	365	456	547	729	912	1094	1276	1458	1641	1823	2005	2735
18.00	–	88	141	177	265	354	442	531	707	884	1061	1238	1415	1592	1768	1945	2653
19.05	3/4	84	134	167	251	334	418	501	668	835	1003	1170	1337	1504	1671	1838	2506
20.00	–	80	127	159	239	318	398	477	637	796	955	1114	1273	1432	1592	1751	2387
24.00	–	66	106	133	199	265	332	398	531	663	796	928	1061	1194	1326	1459	1989
25.00	–	64	102	127	191	255	318	382	509	637	764	891	1019	1146	1273	1401	1910
27.00	–	59	94	118	177	236	295	354	472	589	707	825	943	1061	1179	1297	1768
30.00	–	53	85	106	159	212	265	318	424	531	637	743	849	955	1061	1167	1592
32.00	–	50	80	99	149	199	249	298	398	497	597	696	796	895	995	1094	1492
36.00	–	44	71	88	133	177	221	265	354	442	531	619	707	796	884	973	1326
40.00	–	40	64	80	119	159	199	239	318	398	477	557	637	716	796	875	1194
50.00	–	32	51	64	95	127	159	191	255	318	382	446	509	573	637	700	955



ALGEMEEN - TECHNISCHE INFORMATIE

Hardheid en Treksterkte

HV	HRC	HB	Treksterkte	
			(N/mm ²)	(Tons/sq. in.)
940	68	–	–	–
900	67	–	–	–
864	66	–	–	–
829	65	–	–	–
800	64	–	–	–
773	63	–	–	–
745	62	–	–	–
720	61	–	–	–
698	60	–	–	–
675	59	–	–	–
655	58	–	2200	142
650	–	618	2180	141
640	–	608	2145	139
639	57	607	2140	138
630	–	599	2105	136
620	–	589	2070	134
615	56	584	2050	133
610	–	580	2030	131
600	–	570	1995	129
596	55	567	1980	128
590	–	561	1955	126
580	–	551	1920	124
578	54	549	1910	124
570	–	542	1880	122
560	53	532	1845	119
550	–	523	1810	117
544	52	517	1790	116
540	–	513	1775	115
530	–	504	1740	113
527	51	501	1730	112
520	–	494	1700	110
514	50	488	1680	109
510	–	485	1665	108
500	–	475	1630	105
497	49	472	1620	105
490	–	466	1595	103
484	48	460	1570	102
480	–	456	1555	101
473	47	449	1530	99
470	–	447	1520	98
460	–	437	1485	96
458	46	435	1480	96
450	–	428	1455	94
446	45	424	1440	93
440	–	418	1420	92

HV	HRC	HB	Treksterkte	
			(N/mm ²)	(Tons/sq. in.)
434	44	413	1400	91
423	43	402	1360	88
413	42	393	1330	86
403	41	383	1300	84
392	40	372	1260	82
382	39	363	1230	80
373	38	354	1200	78
364	37	346	1170	76
355	36	337	1140	74
350	–	333	1125	73
345	35	328	1110	72
340	–	323	1095	71
336	34	319	1080	70
330	–	314	1060	69
327	33	311	1050	68
320	–	304	1030	67
317	32	301	1020	66
310	31	295	995	64
302	30	287	970	63
300	–	285	965	62
295	–	280	950	61
293	29	278	940	61
290	–	276	930	60
287	28	273	920	60
285	–	271	915	59
280	27	266	900	58
275	–	261	880	57
272	26	258	870	56
270	–	257	865	56
268	25	255	860	56
265	–	252	850	55
260	24	247	835	54
255	23	242	820	53
250	22	238	800	52
245	–	233	785	51
243	21	231	780	50
240	–	228	770	50
235	–	223	755	49
230	–	219	740	48
225	–	214	720	47
220	–	209	705	46
215	–	204	690	45
210	–	199	675	44
205	–	195	660	43
200	–	190	640	41



MODULAIRE- EN WISSELPLAATBOREN





GATBEWERKING - ALGEMENE INHOUD

6		WMG & ISO 13399
12	BOREN	INSTRUCTIES
15		VOLHARDMETAAL BOREN
66		HSS BOREN
176		TECHNISCHE INFORMATIE
186		SNIJOLIE
190		RUIMERS EN VERZINKBOREN
264	WISSELPLAATBOREN	INSTRUCTIES
271		HYDRA BOREN
297		TECHNISCHE INFORMATIE
307		WISSELPLAATBOREN
327		TECHNISCHE INFORMATIE
350	KOTTERSYSTEMEN	INSTRUCTIES
359		KOTTERKOPPEN
376		KOTTER ACCESSOIRES
381		WISSELPLATEN
404		OPNAMES
418		KOTTERSETS
429		TECHNISCHE INFORMATIE



WISSELPLATEN - UITLEG PRODUCTPAGINA



1 SCET

	IC	D1	L	S
	[mm]	[mm]	[mm]	[mm]
0502	5.556	2.40	5.56	2.38
0602	6.350	2.90	6.35	2.38
0703	7.937	3.50	7.94	3.18
09T3	9.525	4.50	9.53	3.97
1204	12.700	5.60	12.70	4.76
1505	15.875	5.60	15.88	5.56

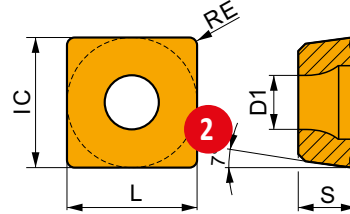

De geschiktheid en startwaarden voor de snijsnelheid (vc), voeding (f) en snediedpte (ap). Raadpleeg onze verspaningscalculator app voor meer berekeningen.

Product	RE	P			M			K			N			S			H		
		vc	f	ap	vc	f	ap	vc	f	ap	vc	f	ap	vc	f	ap			
	(mm)	[m/min]	[mm/rev]	[mm]	[m/min]	[mm/rev]	[mm]	[m/min]	[mm/rev]	[mm]	[m/min]	[mm/rev]	[mm]	[m/min]	[mm/rev]	[mm]	[m/min]	[mm/rev]	[mm]

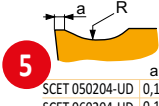

UD universele geometrie voor omtrek-wisselplaten.

SCET 050204-UD	0,12
SCET 060204-UD	0,15
SCET 070308-UD	0,15
SCET 09T308-UD	0,15
SCET 120408-UD	0,20
SCET 150512-UD	0,20

Product	RE	vc	f	ap	vc	f	ap	vc	f	ap	vc	f	ap	vc	f	ap
SCET 050204-UD	D8330	0.4	165	0.08	-	-	-	155	0.08	-	-	-	-	-	-	-
	D9335	0.4	240	0.08	-	-	-	225	0.08	-	-	-	-	-	-	-
SCET 060204-UD	D8330	0.4	165	0.11	-	-	-	155	0.11	-	-	-	-	-	-	-
	D9335	0.4	240	0.11	-	-	-	225	0.11	-	-	-	-	-	-	-
SCET 070308-UD	D8330	0.8	165	0.13	-	-	-	155	0.13	-	-	-	-	-	-	-
	D9335	0.8	240	0.13	-	-	-	225	0.13	-	-	-	-	-	-	-
SCET 09T308-UD	D8330	0.8	165	0.14	-	-	-	155	0.14	-	-	-	-	-	-	-
	D9335	0.8	240	0.14	-	-	-	225	0.14	-	-	-	-	-	-	-
SCET 120408-UD	D8330	0.8	165	0.16	-	-	-	155	0.16	-	-	-	-	-	-	-
	D9335	0.8	240	0.16	-	-	-	225	0.16	-	-	-	-	-	-	-
SCET 150512-UD	D8330	1.2	165	0.18	-	-	-	155	0.18	-	-	-	-	-	-	-
	D9335	1.2	240	0.18	-	-	-	225	0.18	-	-	-	-	-	-	-

SCET120408-UD:D9335 Gebruik bij bestellen de volledige bestelcode!

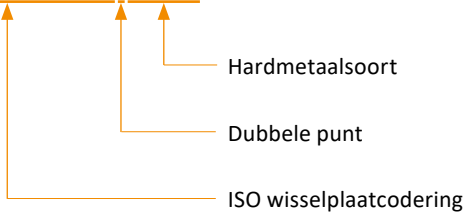



WISSELPLATEN - UITLEG PRODUCTPAGINA

Pos.	Omschrijving	Pos.	Omschrijving
1	Productfamiliecode	7	ISO code van de wisselplaat
2	Schematische afbeelding	8	Hardmetaalsoort
3	Tabel met wisselplaat afmetingen (mm)	9	Ingeschreven cirkel (mm)
4	Afbeelding	10	Omschrijving geometrie
5	Spaangroefvorm	11	Aanbevelingen materiaalgroep incl. snijsnelheid en voeding
6	Productkenmerken		



WISSELPLAATBOREN - UITLEG PRODUCTPAGINA

1 **802D** **P M K N S** **2** **PRAMET** **3** **S**



Wisselplaatboor, 2xD, koelkanalen
 Hoogproductieve wisselplaatboor voor het boren van blinde en doorlopende gaten. Ook geschikt voor kruisgaten, excentrisch boren en pakket boren, circulaire interpolatie, verzinken, boren op holle of schuine oppervlakken, boren met onderbroken sneden, afkantboren en kotten. Verkrijgbaar van Ø15 t/m Ø40 mm in 2xD.

4

5

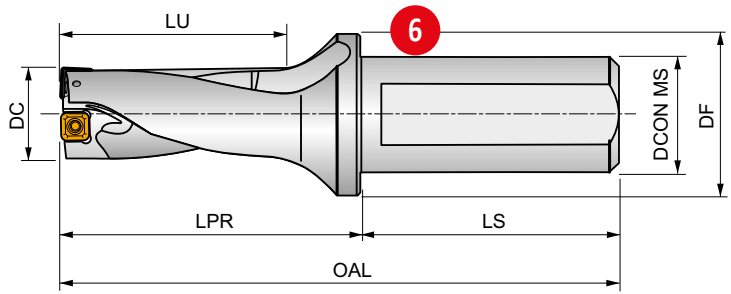

2xD **1** **ISO 9766**

7

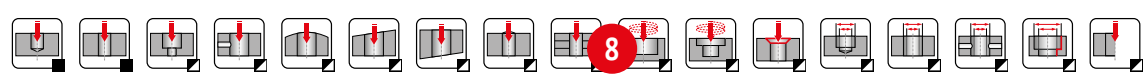

8

Product	DC	APMX	OAL	LPR	LS	LU	DCON MS	DF	\bar{D}	D^+						
	[mm]	[mm]	[mm]	[mm]	[mm]	[mm]	[mm]	[mm]	[mm]	[mm]						
802D-15-30-S25	15	30.00	121	65	56	34.5	25	35	0.25	0.35	EP253253	GI300	GI313	0.30	HM001	
802D-16-32-S25	16	32.00	123	67	56	37	25	35	0.45	0.45	EP253253	GI300	GI313	0.30	HM001	
802D-17-34-S25	17	34.00	125	69	56	39.5	25	35	0.50	0.50	EP253253	GI301	GI314	0.31	HM002	
802D-18-36-S25	18	36.00	127	71	56	42	25	35	0.35	0.25	EP253253	GI301	GI314	0.31	HM002	
802D-19-38-S25	19	38.00	129	73	56	44.5	25	35	0.15	0.45	EP253253	GI301	GI314	0.32	HM002	

9

10

11

12

13

14

15

16

GI300	XPET 0502AP	SCET 050204-UD
GI301	XPET 0602AP	SCET 050204-UD
GI302	XPET 0602AP	SCET 060204-UD
GI303	XPET 0703AP	SCET 060204-UD
GI304	XPET 0703AP	SCET 070308-UD
GI305	XPET 0903AP	SCET 070308-UD
GI306	XPET 0903AP	SCET 09T308-UD
GI307	XPET 11T3AP	SCET 09T308-UD
GI308	XPET 11T3AP	SCET 120408-UD
GI309	XPET 12T3AP	SCET 120408-UD
GI313	XPET 0502AP-SD	SCET 050204-SD
GI314	XPET 0602AP-SD	SCET 050204-SD
GI315	XPET 0602AP-SD	SCET 060204-SD
GI316	XPET 0703AP-SD	SCET 060204-SD
GI317	XPET 0703AP-SD	SCET 070308-SD
GI318	XPET 0903AP-SD	SCET 070308-SD
GI319	XPET 0903AP-SD	SCET 09T308-SD
GI320	XPET 11T3AP-SD	SCET 09T308-SD
GI321	XPET 11T3AP-SD	SCET 120408-SD
GI322	XPET 12T3AP-SD	SCET 120408-SD

17

18

GI300	XPET 0502AP	SCET 050204-UD
GI301	XPET 0602AP	SCET 050204-UD
GI302	XPET 0602AP	SCET 060204-UD
GI303	XPET 0703AP	SCET 060204-UD

19



WISSELPLAATBOREN - UITLEG PRODUCTPAGINA

Pos.	Omschrijving	Pos.	Omschrijving
1	Productfamiliecode	11	Radiale verstelbaarheid (mm)
2	Materiaalgroep aanbevelingen	12	Verstelhuls
3	Klemsysteem wisselplaat	13	Groep van passende wisselplaten met spaanbreker UD ^{1),2)}
4	Productomschrijving	14	Groep van passende wisselplaten met spaanbreker SD ^{1),2)}
5	Afbeelding	15	Gewicht (kg)
6	Schematische afbeelding	16	Onderdelengroep ¹⁾
7	Productkenmerken	17	Passende wisselplaten met spaanbreker UD
8	Product toepassingen	18	Passende wisselplaten met spaanbreker SD
9	Productcode	19	Onderdelen
10	Productafmetingen		

¹⁾ Groepcodering van passende wisselplaten en onderdelen is alleen bedoeld voor deze catalogus. Kan niet als bestelcode worden gebruikt.

²⁾ Omtrek- (SCET) en centrumsnijdende (XPET) wisselplaten dienen altijd dezelfde spaanbreker te hebben (let op: UD spaanbreker is niet zichtbaar in de omschrijving van XPET wisselplaten, bijvoorbeeld XPET 0502AP); Info over de juiste keuze van de spaanbreker (UD of SD) kan worden gevonden op de wisselplaatverpakking.



HYDRA BOREN - UITLEG PRODUCTPAGINA

1 H851



HYDRA modulair boorsysteem 1.5XD, met koelkanalen

Te gebruiken met Hydra wisselkop R590, R960 of R970. Op deze modulaire koelkanaalboor kunnen binnen een bepaalde range wisselkoppen van verschillende diameter worden gemonteerd. Ideaal voor het boren van startgaten bij de 8xD en 12xD boren. Voorzien van universele eenheidschacht voor eenvoudige opname in diverse systemen.

2

HYDRA

HSS	DORMER	1.5xD
Bright Ni	ISO 9766	R

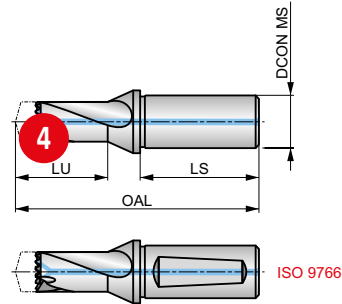

Hydra boor is inclusief 4 schroeven en 1 schroevendraaier. DCON MS passing h6.

Product	DCONMS	DCON MS	LU	OAL	LS	ADINTMS
	[inch]	[mm]	[mm]	[mm]	[mm]	
H85131/64	5/8	15.88	25.50	88.5	47.6	Cylindrical
H85111/2	5/8	15.88	25.80	88.8	47.6	Cylindrical
H85117/32	5/8	15.88	30.90	93.9	47.6	Cylindrical
H85112.0	-	16.00	25.50	88.5	48.0	ISO 9766
H85112.5	-	16.00	25.80	88.8	48.0	ISO 9766
H85113.0	-	16.00	27.00	90.0	48.0	ISO 9766
H85114.0	-	16.00	30.90	93.9	48.0	ISO 9766
H8519/16	3/4	19.05	30.30	93.9	50.8	Cylindrical
H85139/64	3/4	19.05	32.30	97.3	50.8	Cylindrical
H85111/64	3/4	19.05	39.00	99.9	50.8	Cylindrical
H85117/16	3/4	19.05	40.40	101.4	50.8	Cylindrical
H85123/32	3/4	19.05	39.00	104.0	50.8	Cylindrical
H85115.0	-	20.00	32.30	97.3	50.0	ISO 9766
H85116.0	-	20.00	34.90	99.9	50.0	ISO 9766
H85117.0	-	20.00	36.40	101.4	50.0	ISO 9766
H85118.0	-	20.00	39.00	104.0	50.0	ISO 9766
H85119.0	-	25.00	40.40	111.4	56.0	ISO 9766
H85120.0	-	25.00	43.00	114.0	56.0	ISO 9766
H85121.0	-	25.00	44.50	115.5	56.0	ISO 9766

Pos.	Omschrijving
1	Productfamiliecode
2	Productomschrijving
3	Afbeelding
4	Schematische afbeelding

Pos.	Omschrijving
5	Productkenmerken
6	Productcode
7	Productafmetingen



MODULAIRE- & WISSELPLAATBOREN - UITLEG PICTOGRAMMEN

ALGEMENE PICTOGRAMMEN

 Eerste keus gebruik

 Beperkte inzetbaarheid

TOPHOEK

 Tophoek 140°

PRODUCTIENORM (BSG)

 Dormer Norm

SOORT KLEMMING

 S – schroefklemming

COATING

 Vernikkeld oppervlak

 Speciale TiAlN Coating (+ Silicon + Chromium)

KOELMIDDELTOEVOER (CSP)

 Inwendig koelkanaal

DIAMETER TOLERANTIE AANWIJZING (TCDC)

 h7 – Industriestandaard voor tolerantieklasse van de gatdiameter

SNIJRICHTING

 Rechts

ALGEMENE KENMERKEN

 1 effectieve tand per omwenteling

 Monoblock design

 Te gebruiken voor excentrisch boren

 Universele schacht

SNIJKANT VAN DE WISSELPLAAT

 Snijkant met afgeronde fase

WISSELPLAAT KENMERKEN

 Voor taaiere materiaalsoorten (langspanig)

 Zware omstandigheden

 Breed inzetbaar

BASISMATERIAAL (BMC)

 Hardmetaal

 Snelstaal

BOORBEWERKINGEN

 Blind gat opboren / kotteren

 Blind gat boren

 Opboren / kotteren

 Kruisgat boren

 Trap boren

 Uittrede van hellend vlak

 Passeren van een dwarsgat

 Pakketboren

 Boren van een gebogen vlak

 Boren in een hellend vlak

 Opboren door circulaire interpolatie

 Boren door circulaire interpolatie

 Verzinken (afschuiven)

 Onderbroken snede

 Opboren van doorlopend gat

 Boren van doorlopend gat

 Puntlas uitboren



MODULAIRE- & WISSELPLAATBOREN - UITLEG PICTOGRAMMEN

ANDERE PICTOGRAMMEN



Aanhaalmoment spanschroef (Nm)

SCHACHT



Cilindrische schacht met borst



ISO 9766 Cilindrische schacht (met of zonder spanvlak)



DIN 6535 – HB (Weldon) of HE (Whistle Notch) schacht

TECHNISCH GEDEELTE



Voeding (mm/omw)



ISO 01-05: Zeer hoge snijsnelheid, uitstekende stabiliteit van machine en opspanning



ISO 05-10: Hoge snijsnelheid, goede stabiliteit van machine en opspanning



ISO 10-20: Gemiddelde snijsnelheid, licht beperkte stabiliteit (wisselende snedediepte)



ISO 20-30: Lage snijsnelheid, beperkte stabiliteit (licht onderbroken snede)



ISO 30-40: Lage snijsnelheid, instabiliteit (onder-broken snede)



ISO 40-50: Zeer lage snijsnelheid, grote instabiliteit (zeer ongunstige bewerkingsomstandigheden)

BOORDIEPTE ZONDER LOSSEN (ULDR)

1.5xD

1.5xD (factor x diameter)

5xD

5xD (factor x diameter)

2xD

2xD (factor x diameter)

12xD

12xD (factor x diameter)

8xD

8xD (factor x diameter)

4xD

4xD (factor x diameter)

3xD

3xD (factor x diameter)



HYDRA BOREN



HYDRA

MODULAIRE BOREN MET VERWISSELBARE KOP

Het Hydra modulaire boorsysteem staat garant voor hoge prestaties en efficiëntie. Doordat de boorpunt verwisseld kan worden is het met name in de grotere diameters een economische keuze ten opzichte van volhardmetaal boren. Het assortiment bestaat uit 5 boorlengtes: 1,5xD, 3xD, 5xD, 8xD en 12xD. Daarbij zijn er 3 verschillende wisselkop geometrieën: grofweg voor boren in staal, roestvast staal en gietijzer.

KENMERKEN EN VOORDELEN

- **Consistente hoge prestaties**, ook na vele keren vernieuwen van de kop.
- **Verlaging van de voorraadkosten** – een boor is geschikt voor meerdere diameters volhardmetalen koppen.
- **Breed inzetbaar** – cilindrische schacht met spanvlak voor verschillende gereedschap opname systemen.
- Snel en eenvoudig wisselen van de koppen met minimale onderbreking van de productie. De kop kan namelijk worden gewisseld zonder de boor uit de machine te halen.
- Nauwkeurige verbinding van de kop op de boor voor optimale stijfheid om zo precieze gaten te kunnen boren.

MATERIAAL

PREMIUM FIJNKORRELIG HARDMETAAL (koppen)

- Fijnkorrelig hardmetaal biedt een excellente combinatie van hardheid en taaiheid en is daardoor slijtvaster.

GEHARD STAAL (boor)

- Gehard staal, vernikkeld voor hoge bestendigheid tegen slijtage en corrosie.

COATING

TITANIUM ALUMINIUM NITRIDE COATING BIEDT:

- Hoge taaiheid en oxidatiebestendigheid.
- Hoge slijtvastheid in abrasieve materialen zoals gietijzer.
- Behoud de hardheid ook bij hoge temperaturen die ontstaan bij boren van bv. gietijzer.
- Hogere productiviteit en standtijd.

TYPE KOP



R950

STAAL



R960

ROESTVAST STAAL



R970

GIETIJZER

GEOMETRIE

SNIJHOEKONTWERP

- Een sterke snijhoek verhoogt de stabiliteit tijdens het boren en verlaagt de krachten die optreden bij het doorkomen.
- Hierdoor wordt de gatqualiteit met name bij de uittreding verbeterd en is er minder braamvorming bij kortspanige, brosse materialen.

PUNTGEOMETRIE

- 140 graden split point geometrie biedt betere centrering en dringt makkelijker in het materiaal.

EEN COMPLEET PROGRAMMA

- Leverbaar in 1,5×D, 3×D, 5×D, 8×D en 12×D lengte.
- Metrische maten van 12,00 mm tot 42,00 mm.
- Inch maten van 15/32" tot 1.5/8".
- U verkrijgt het beste resultaat wanneer hydraulische opspanhouders worden gebruikt. Ook geschikt voor ER-spantanghouders en Weldon-houders.

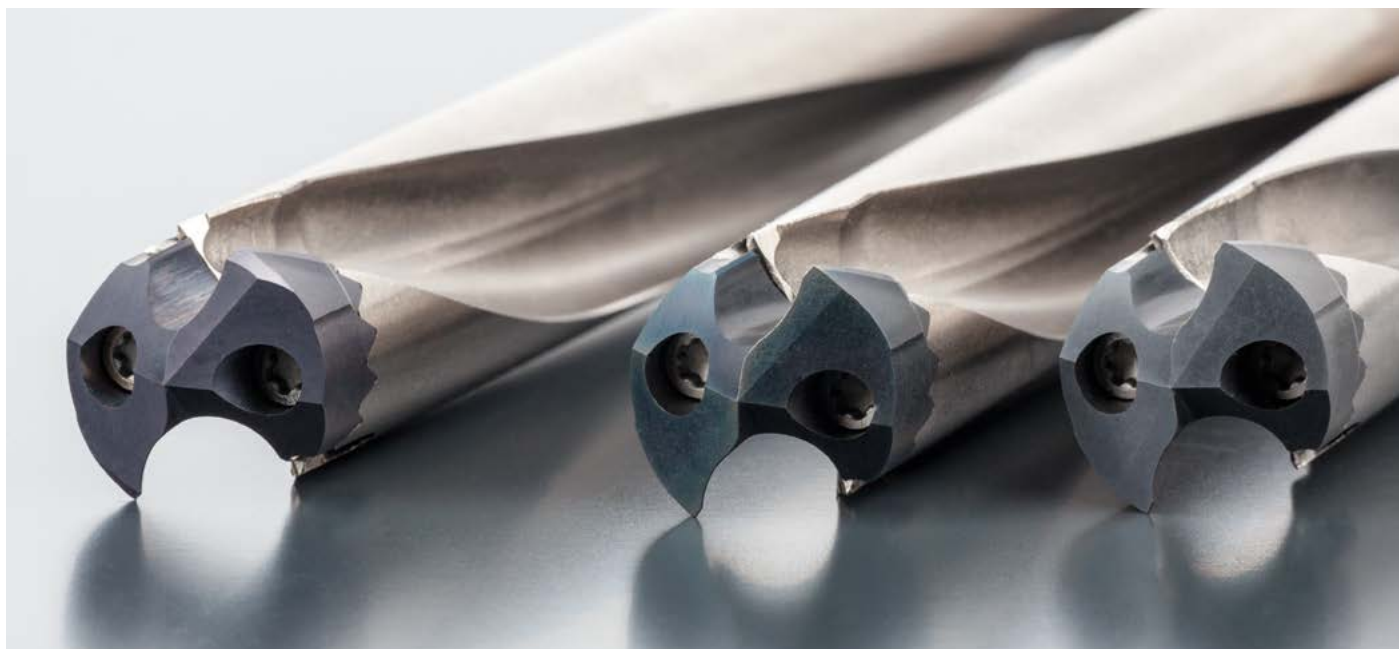

BOORLENGTES

1.5×D



3×D



5×D



8×D



12×D





HYDRA BOREN - NAVIGATOR BASISMATERIAAL

Basismaterialen

Snelstaal		Medium gelegeerd snelstaal wat een goede bewerkbaarheid heeft en goede prestaties levert. HSS biedt een goed balans in hardheid en taaiheid en is daardoor aantrekkelijk voor het produceren van bijvoorbeeld boren en tappen.
------------------	---	--

Hardmetaal

Hardmetaal		<p>Een gesinterd poedermetallurgisch substraat, bestaande uit een metalen volhardmetalen composiet met bindmiddelmetaal. Het meest centrale ruwe materiaal is wolfram carbide (WC). Wolfram carbide draagt bij aan de hardheid van het materiaal. Tantaal carbide (TaC), titaan carbide (TiC) en niobium carbide (NbC) vullen WC aan en passen de eigenschap aan de gewenste eigenschappen aan. Deze drie materialen worden kubische carbides genoemd. Kobalt (Co) fungeert als een bindmiddel en houdt het materiaal bij elkaar.</p> <p>Carbidematerialen worden vaak gekenmerkt door hoge compressiesterkte, hoge hardheid en daardoor hoge slijtvastheid, maar ook door beperkte buigsterkte en taaiheid. Carbide wordt gebruikt in tappen, ruimers, frezen, boren en draadfren.</p>
-------------------	---	---

Oppervlakte coatings

Vernikkeld		Helder vernikkeld oppervlak beschermt de gehard stalen body tegen corrosie en verbetert ook de afvoer van spanen.
Ti-phon (TiAlCrSiN)		Ti-phon Coating is een coating vergelijkbaar met TiAlN maar met de toevoeging van Chroom (Cr) en Silicium (Si) en is speciaal ontwikkeld voor de Hydra wisselkoppen om snijkantsopbouw te voorkomen en de spaanafvoer sterk te verbeteren. Deze coating heeft een hoge warmvastheid, een hoge weerstand tegen oxidatie en een zeer lage wrijvingscoëfficiënt bij zware mechanische en thermische belastingen, hoge snijsnelheden en voedingen. Deze coatingeigenschappen vertalen zich in uitstekende slijtvastheid en snijkantsterkte.



DORMER PRAMET



ALLE GEREEDSCHAPPEN BIJ ELKAAR

Ons gehele assortiment van volmateriaal- en wisselplaatgereedschappen is toegevoegd aan de bewerkingscalculator-app. Dat zijn meer dan **40.000** artikelen! Wat je ook bewerkt, wij hebben waarschijnlijk het gereedschap hiervoor. **Simply Reliable.**

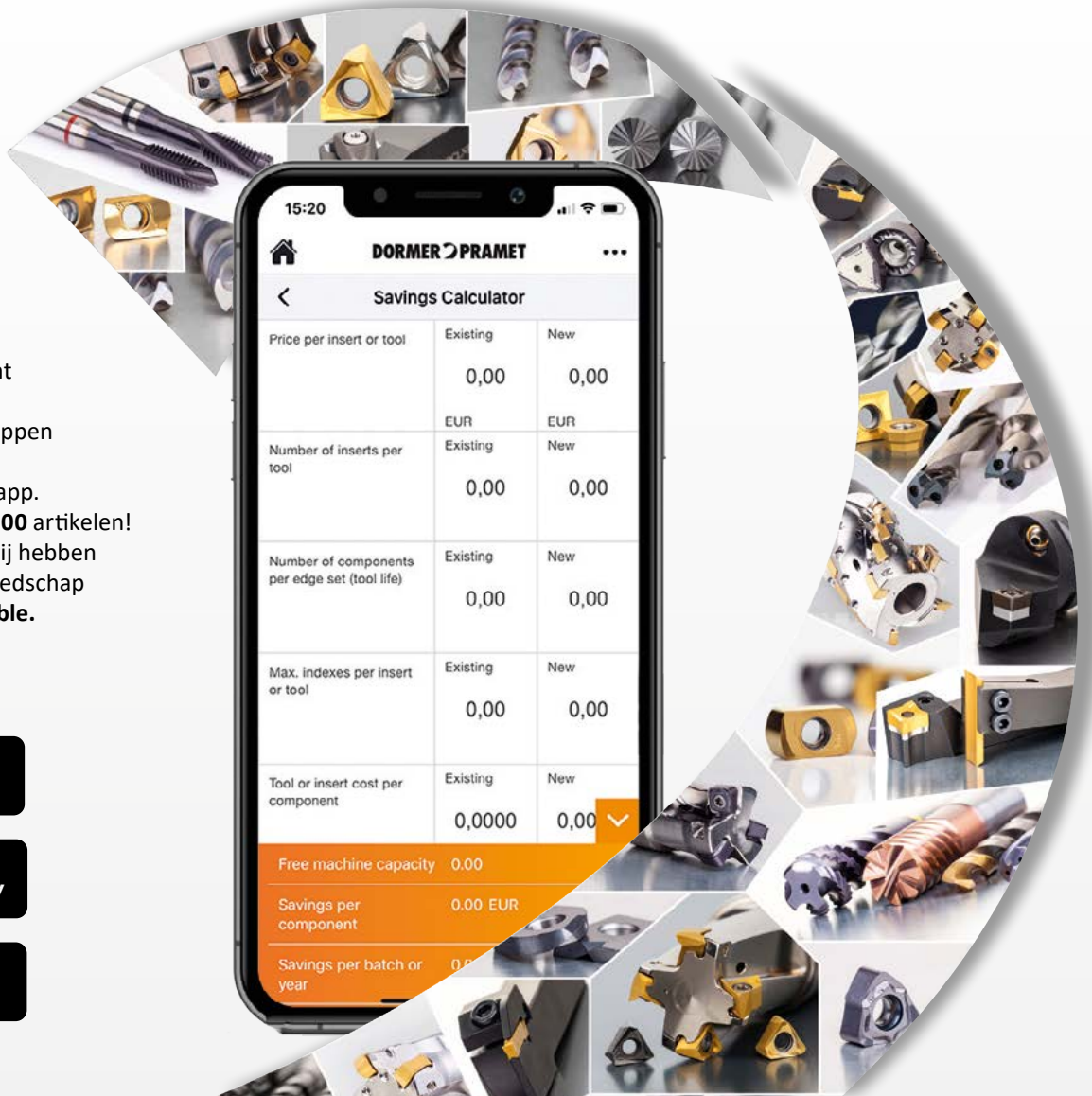

DORMER PRAMET		
Savings Calculator		
Price per insert or tool	Existing	New
	0,00	0,00
	EUR	EUR
Number of inserts per tool	Existing	New
	0,00	0,00
Number of components per edge set (tool life)	Existing	New
	0,00	0,00
Max. indexes per insert or tool	Existing	New
	0,00	0,00
Tool or insert cost per component	Existing	New
	0,0000	0,00
Free machine capacity	0.00	
Savings per component	0.00 EUR	
Savings per batch or year	0.00	



Productfamiliecode	R950		R960		R970		H851		H853		H855		H858		H8512		H860		H861	
	12.00 - 42.00, 15/32 - 1.5/8	12.00 - 30.50, 15/32 - 1.3/16	12.00 - 42.00, 15/32 - 1.5/8	12.00 - 30.50, 15/32 - 1.3/16	12.00 - 42.00, 15/32 - 1.5/8	12.00 - 30.50, 15/32 - 1.3/16	12.00 - 42.50, 15/32 - 1.5/8	12.00 - 42.50, 15/32 - 1.5/8	12.00 - 42.50, 15/32 - 1.5/8	13.50 - 42.50, 35/64 - 1.5/8	13.50 - 25.65, 35/64 - 1.1/64	N1 - N7		N1 - N6						
	281	283	285	287	287	289	291	293	294	295	296									
P	P1	■	■																	
	P2	■	■																	
	P3	■	■																	
	P4	■	■																	
M	M1		■																	
	M2		■																	
	M3		■																	
	M4		■																	
K	K1		■	■																
	K2	■	■	■																
	K3	■	■	■																
	K4	■	■	■																
	K5	■	■	■																
N	N1																			
	N2																			
	N3																			
	N4																			
	N5																			
S	S1		■																	
	S2		■																	
	S3		■																	
	S4		■																	
H	H1																			
	H2																			
	H3																			
	H4																			

■ Geschikt ■ Beperkt geschikt



HOOGPRODUCTIEVE MODULAIRE BOREN

Samenstelling										
	DC	H851 1.5xD	H853 3xD	H855 5xD	H858 8xD	H8512 12xD	R950	R960	R970	H860
Range	12.00 – 30.50 15/32" – 1.3/16"	12.00 – 42.50 15/32" – 1.5/8"	12.00 – 42.50 15/32" – 1.5/8"	13.50 – 42.50 35/64" – 1.5/8"	13.50 – 25.65 35/64" – 1.1/64"	12.00 – 42.00 15/32" – 1.5/8"	12.00 – 30.50 15/32" – 1.3/16"	12.00 – 42.00 15/32" – 1.5/8"	N1 – N7	N1 – N6
Blz.	287	289	291	293	294	281	283	285	295	296

DC	H851 1.5xD	H853 3xD	H855 5xD	H858 8xD	H8512 12xD	R950	R960	R970	H860	H861
15/32"						R95015/32	R96015/32	R97015/32		
12.0						R95012.0	R96012.0	R97012.0		
12.1	H85112.0	H85312.0	H85512.0	–	–	R95012.1	R96012.1	R97012.1		
12.2	H85131/64	H85331/64	H85531/64			R95012.2	R96012.2	R97012.2		
31/64"						R95031/64	R96031/64	R97031/64		
12.5						R95012.5	R96012.5	R97012.5		
12.6						R95012.6	R96012.6	R97012.6		
1/2"	H85112.5	H85312.5	H85512.5	–	–	R9501/2	R9601/2	R9701/2		
12.8	H8511/2	H8531/2	H8551/2			R95012.8	R96012.8	R97012.8		
12.9						R95012.9	R96012.9	R97012.9		
13.0						R95013.0	R96013.0	R97013.0		
33/64"						R95033/64	R96033/64	R97033/64		
13.2	H85113.0	H85313.0	H85513.0	–	–	R95013.2	R96013.2	R97013.2		
17/32"	H85117/32	H85317/32	H85517/32			R95017/32	R96017/32	R97017/32		
13.5						R95013.5	R96013.5	R97013.5		
13.6						R95013.6	R96013.6	R97013.6		
13.7						R95013.7	R96013.7	R97013.7		
13.8						R95013.8	R96013.8	R97013.8		
35/64"	H85114.0	H85314.0	H85514.0	H85814.0	H851214.0	R95035/64	R96035/64	R97035/64	H860N1	H861N1
14.0	H8519/16	H8539/16	H8559/16			R95014.0	R96014.0	R97014.0		
14.1						R95014.1	R96014.1	R97014.1		
14.2						R95014.2	R96014.2	R97014.2		
9/16"						R9509/16	R9609/16	R9709/16		
14.5						R95014.5	R96014.5	R97014.5		
14.6						R95014.6	R96014.6	R97014.6		
37/64"						R95037/64	R96037/64	R97037/64		
14.7						R95014.7	R96014.7	R97014.7		
14.8						R95014.8	R96014.8	R97014.8		
15.0						R95015.0	R96015.0	R97015.0		
19/32"	H85115.0	H85315.0	H85515.0	H85815.0	H851215.0	R95019/32	R96019/32	R97019/32		
15.1	H85139/64	H85339/64	H85539/64			R95015.1	R96015.1	R97015.1		
15.2						R95015.2	R96015.2	R97015.2		
15.24						R95015.24	R96015.24	R97015.24		
39/64"						R95039/64	R96039/64	R97039/64		
15.5						R95015.5	R96015.5	R97015.5		



HOOGPRODUCTIEVE MODULAIRE BOREN

DC	H851 1.5xD	H853 3xD	H855 5xD	H858 8xD	H8512 12xD	R950	R960	R970	H860	H861							
15.6	H85116.0 H85141/64	H85316.0 H85341/64	H85516.0 H85541/64	H85816.0	H851216.0	R95015.6	R96015.6	R97015.6	H860N2	H861N2							
15.7						R95015.7	R96015.7	R97015.7									
5/8"						R9505/8	R9605/8	R9705/8									
16.0						R95016.0	R96016.0	R97016.0									
16.08						R95016.08	R96016.08	R97016.08									
16.1						R95016.1	R96016.1	R97016.1									
16.2						R95016.2	R96016.2	R97016.2									
16.3						R95016.3	R96016.3	R97016.3									
41/64"						R95041/64	R96041/64	R97041/64									
16.5						R95016.5	R96016.5	R97016.5									
16.6	H85117.0 H85111/16	H85317.0 H85311/16	H85517.0 H85511/16	H85817.0	H851217.0	R95016.6	R96016.6	R97016.6	H860N2	H861N2							
21/32"						R95021/32	R96021/32	R97021/32									
16.7						R95016.7	R96016.7	R97016.7									
17.0						R95017.0	R96017.0	R97017.0									
43/64"						R95043/64	R96043/64	R97043/64									
17.1						R95017.1	R96017.1	R97017.1									
17.2						R95017.2	R96017.2	R97017.2									
11/16"						R95011/16	R96011/16	R97011/16									
17.5						R95017.5	R96017.5	R97017.5									
17.6						H85118.0 H85123/32	H85318.0 H85323/32	H85518.0 H85523/32			H85818.0	H851218.0	R95017.6	R96017.6	R97017.6	H860N3	H861N3
17.7	R95017.7	R96017.7	R97017.7														
45/64"	R95045/64	R96045/64	R97045/64														
18.0	R95018.0	R96018.0	R97018.0														
18.1	R95018.1	R96018.1	R97018.1														
18.2	R95018.2	R96018.2	R97018.2														
23/32"	R95023/32	R96023/32	R97023/32														
18.5	R95018.5	R96018.5	R97018.5														
18.6	H85119.0 H85149/64	H85319.0 H85349/64	H85519.0 H85549/64	H85819.0	H851219.0				R95018.6	R96018.6			R97018.6	H860N3	H861N3		
47/64"									R95047/64	R96047/64			R97047/64				
18.7						R95018.7	R96018.7	R97018.7									
18.9						R95018.9	R96018.9	R97018.9									
19.0						R95019.0	R96019.0	R97019.0									
3/4"						R9503/4	R9603/4	R9703/4									
19.1						R95019.1	R96019.1	R97019.1									
19.2						R95019.2	R96019.2	R97019.2									
19.25						R95019.25	R96019.25	R97019.25									
19.3						R95019.3	R96019.3	R97019.3									
19.35	R95019.35	R96019.35	R97019.35														
49/64"	R95049/64	R96049/64	R97049/64														
19.5	R95019.5	R96019.5	R97019.5														
19.6	H85120.0 H85151/64	H85320.0 H85351/64	H85520.0 H85551/64	H85820.0	H851220.0	R95019.6	R96019.6	R97019.6	H860N4	H861N3							
19.7						R95019.7	R96019.7	R97019.7									
25/32"						R95025/32	R96025/32	R97025/32									
20.0						R95020.0	R96020.0	R97020.0									
51/64"						R95051/64	R96051/64	R97051/64									
20.5						R95020.5	R96020.5	R97020.5									
13/16"						R95013/16	R96013/16	R97013/16									
21.0						R95021.0	R96021.0	R97021.0									
53/64"						R95053/64	R96053/64	R97053/64									
27/32"						R95027/32	R96027/32	R97027/32									
21.5	R95021.5	R96021.5	R97021.5														
55/64"	H85122.0 H85157/64	H85322.0 H85357/64	H85522.0 H85557/64	H85822.0	H851222.0	R95055/64	R96055/64	R97055/64	H860N4	H861N3							
22.0						R95022.0	R96022.0	R97022.0									
7/8"						R9507/8	R9607/8	R9707/8									
22.5						R95022.5	R96022.5	R97022.5									
57/64"						R95057/64	R96057/64	R97057/64									
22.7						R95022.7	R96022.7	R97022.7									
23.0	H85123.0 H85159/64	H85323.0 H85359/64	H85523.0 H85559/64	H85823.0	H851223.0	R95023.0	R96023.0	R97023.0	H860N4	H861N3							
29/32"						R95029/32	R96029/32	R97029/32									
59/64"						R95059/64	R96059/64	R97059/64									
23.5						R95023.5	R96023.5	R97023.5									



HOOGPRODUCTIEVE MODULAIRE BOREN

DC	H851 1.5xD	H853 3xD	H855 5xD	H858 8xD	H8512 12xD	R950	R960	R970	H860	H861
15/16	H85124.0 H85131/32	H85324.0 H85331/32	H85524.0 H85531/32	H85824.0	H851224.0	R95015/16	R96015/16	R97015/16	H860N4	H861N3
24.0						R95024.0	R96024.0	R97024.0		
61/64						R95061/64	R96061/64	R97061/64		
24.5						R95024.5	R96024.5	R97024.5		
31/32"						R95031/32	R96031/32	R97031/32		
25.0	H85125.0 H8511.1/64	H85325.0 H8531.1/64	H85525.0 H8551.1/64	H85825.0	H851225.0	R95025.0	R96025.0	R97025.0	H860N5	H861N4
63/64"						R95063/64	R96063/64	R97063/64		
1"						R9501	R9601	R9701		
25.5						R95025.5	R96025.5	R97025.5		
25.6						R95025.6	–	–		
25.65						R95025.65	R96025.65	R97025.65		
1.1/64"						R9501.1/64	R9601.1/64	R9701.1/64		
26.0						R95026.0	R96026.0	R97026.0		
1.1/32"						R9501.1/32	R9601.1/32	R9701.1/32		
26.5						R95026.5	R96026.5	R97026.5		
1.3/64	R9501.3/64	R9601.3/64	R9701.3/64							
1.1/16"	H85127.0 H8511.3/32	H85327.0 H8531.3/32	H85527.0 H8551.3/32	H85827.0	–	R9501.1/16	R9601.1/16	R9701.1/16	H860N6	H861N5
27.0						R95027.0	R96027.0	R97027.0		
1.5/64"						R9501.5/64	R9601.5/64	R9701.5/64		
27.5						R95027.5	R96027.5	R97027.5		
1.3/32"						R9501.3/32	R9601.3/32	R9701.3/32		
28.0	H85128.0 H8511.1/8	H85328.0 H8531.1/8	H85528.0 H8551.1/8	H85828.0	–	R95028.0	R96028.0	R97028.0	H860N7	H861N6
1.7/64"						R9501.7/64	R9601.7/64	R9701.7/64		
28.5						R95028.5	R96028.5	R97028.5		
1.1/8"						R9501.1/8	R9601.1/8	R9701.1/8		
1.9/64"						R9501.9/64	R9601.9/64	R9701.9/64		
29.0	H85129.0 H8511.11/64	H85329.0 H8531.11/64	H85529.0 H8551.11/64	H85829.0	–	R95029.0	R96029.0	R97029.0	H860N8	H861N7
1.5/32"						R9501.5/32	R9601.5/32	R9701.5/32		
29.5						R95029.5	R96029.5	R97029.5		
1.11/64"						R9501.11/64	R9601.11/64	R9701.11/64		
30.0						R95030.0	R96030.0	R97030.0		
1.3/16"	H85130.0 H8511.3/16	H85330.0 H8531.3/16	H85530.0 H8551.3/16	H85830.0	–	R9501.3/16	R9601.3/16	R9701.3/16	H860N9	H861N8
30.5						R95030.5	R96030.5	R97030.5		
1.7/32"						R9501.7/32	–	R9701.7/32		
31.0						R95031.0	–	R97031.0		
1.1/4"						R9501.1/4	–	R9701.1/4		
32.0	–	H85332.0	H85532.0	H85832.0	–	R95032.0	–	R97032.0	H860N10	H861N9
32.5						R95032.5	–	R97032.5		
1.19/64"						R9501.19/64	–	R9701.19/64		
33.0						R95033.0	–	R97033.0		
33.5						R95033.5	–	R97033.5		
34.0	–	H85333.5	H85533.5	H85833.5	–	R95034.0	–	R97034.0	H860N11	H861N10
1.11/32"						R9501.11/32	–	R9701.11/32		
34.5						R95034.5	–	R97034.5		
1.3/8"						R9501.3/8	–	R9701.3/8		
35.0						R95035.0	–	R97035.0		
36.0	–	H85334.0	H85534.0	H85834.0	–	R95036.0	–	R97036.0	H860N12	H861N11
1.27/64"						R9501.27/64	–	R9701.27/64		
36.5						R95036.5	–	R97036.5		
37.0						R95037.0	–	R97037.0		
1.15/32"						R9501.15/32	–	R9701.15/32		
37.5	–	H85335.0	H85535.0	H85835.0	–	R95037.5	–	R97037.5	H860N13	H861N12
38.0						R95038.0	–	R97038.0		
1.1/2"						R9501.1/2	–	R9701.1/2		
38.5						R95038.5	–	R97038.5		
1.17/32"						R9501.17/32	–	R9701.17/32		
39.0	–	H85336.5	H85536.5	H85836.5	–	R95039.0	–	R97039.0	H860N14	H861N13
39.5						R95039.5	–	R97039.5		
1.9/16"						R9501.9/16	–	R9701.9/16		
40.0						R95040.0	–	R97040.0		
41.0						R95041.0	–	R97041.0		



HOOGPRODUCTIEVE MODULAIRE BOREN

DC	H851 1.5×D	H853 3×D	H855 5×D	H858 8×D	H8512 12×D	R950	R960	R970	H860	H861
1.5/8"	–	H85342.5	H85542.5	H85842.5	–	R9501.5/8	–	R9701.5/8	H860N7	H861N6
42.0						R95042.0	–	R97042.0		

Accessories

H860	H861	Hydra Wisselkop DC range			Sleutelmaat / Bit
		Metrisch (min. – max.)	Fractional (min. – max.)	Decimal (min. – max.)	
H860N1	H861N1	12.0 mm – 15.5 mm	15/32" – 39/64"	0.4688" – 0.6102"	8IP
H860N2	H861N2	15.6 mm – 18.5 mm	5/8" – 23/32"	0.6142" – 0.7283"	10IP
H860N3	H861N3	18.6 mm – 21.5 mm	47/64" – 27/32"	0.7323" – 0.8465"	15IP
H860N4	H861N3	22.0 mm – 24.5 mm	55/64" – 31/32"	0.8594" – 0.9688"	15IP
H860N5	H861N4	25.0 mm – 27.5 mm	63/64" – 1-3/32"	0.9843" – 1.0938"	20IP
H860N6	H861N5	28.0 mm – 33.5 mm	1-7/64" – 1-19/64"	1.1024" – 1.3189"	25IP
H860N7	H861N6	34.0 mm – 42.0 mm	1-11/32" – 1-5/8"	1.3386" – 1.6535"	4 mm



R950

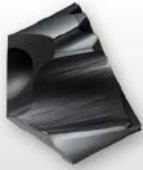

HYDRA wisselkop, standaard geometrie, Ti-phon gecoat

Zeer economisch en nauwkeurig ontwerp wisselkop voor hoge prestaties in staal en hardere materialen. Een split point van 140° helpt bij de zelfcentrerend en vermindert de snijkrachten. De Ti-phon coating voorkomt kantopbouw en verbetert de spaanafvoer aanzienlijk, met uitstekende slijtvastheid en slijkantsterkte.

HYDRA

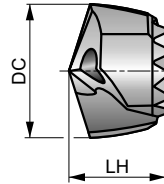

HM	DORMER	140°
Ti-phon	R	
DC h7		

H851	Pas startwaarden voor toerental en voeding toe met een correctiefactor van 1.10
H853	Pas startwaarden voor toerental en voeding toe met een correctiefactor van 1.00
H855	Pas startwaarden voor toerental en voeding toe met een correctiefactor van 0.95
H858	Pas startwaarden voor toerental en voeding toe met een correctiefactor van 0.90
H8512	Pas startwaarden voor toerental en voeding toe met een correctiefactor van 0.80

De tabel geeft de geschiktheid aan voor de materiaalgroep en de startwaarden voor de snijsnelheid (m/min) en de letter verwijst naar de toe te passen voeding (fn),

P1.1 ■ 133 W	P1.2 ■ 148 W	P1.3 ■ 154 W	P2.1 ■ 114 W	P2.2 ■ 100 W	P2.3 ■ 88 W	P3.1 ■ 125 W	P3.2 ■ 101 W	P3.3 ■ 85 W	P4.1 ■ 75 W	P4.2 ■ 63 W	P4.3 ■ 52 T	M2.3 ■ 41 T	M4.2 ■ 35 T
K2.1 ■ 108 V	K2.2 ■ 88 V	K2.3 ■ 70 V	K3.1 ■ 96 V	K3.2 ■ 73 V	K3.3 ■ 59 V	K4.1 ■ 89 V	K4.2 ■ 67 V	K4.3 ■ 49 V	K4.4 ■ 42 V	K4.5 ■ 35 V	K5.1 ■ 100 V	K5.2 ■ 76 V	K5.3 ■ 58 V

Product	DC	DC	DC	LH
	(inch)	(mm)	(inch)	(mm)
R95015/32	15/32	11.91	0.4688	9.1
R95012.0	–	12.00	0.4724	9.1
R95012.1	–	12.10	0.4764	9.1
R95012.2	–	12.20	0.4803	9.1
R95031/64	31/64	12.30	0.4844	9.1
R95012.5	–	12.50	0.4921	9.4
R95012.6	–	12.60	0.4961	9.4
R9501/2	1/2	12.70	0.5000	9.4
R95012.8	–	12.80	0.5039	9.4
R95012.9	–	12.90	0.5079	9.4
R95013.0	–	13.00	0.5118	9.7
R95033/64	33/64	13.10	0.5156	9.7
R95013.2	–	13.20	0.5197	9.7
R95017/32	17/32	13.49	0.5313	9.7
R95013.5	–	13.50	0.5315	10.3
R95013.6	–	13.60	0.5354	10.3
R95013.7	–	13.70	0.5394	10.3
R95013.8	–	13.80	0.5433	10.3
R95035/64	35/64	13.89	0.5469	10.3
R95014.0	–	14.00	0.5512	10.3
R95014.1	–	14.10	0.5551	10.3
R95014.2	–	14.20	0.5591	10.3
R9509/16	9/16	14.29	0.5625	10.3
R95014.5	–	14.50	0.5709	10.3
R95014.6	–	14.60	0.5748	11.0
R95037/64	37/64	14.68	0.5781	11.0
R95014.7	–	14.70	0.5787	11.0
R95014.8	–	14.80	0.5827	11.0
R95015.0	–	15.00	0.5906	11.0
R95019/32	19/32	15.08	0.5938	11.0

Product	DC	DC	DC	LH
	(inch)	(mm)	(inch)	(mm)
R95015.1	–	15.10	0.5945	11.0
R95015.2	–	15.20	0.5984	11.0
R95015.24	–	15.24	0.6000	11.0
R95039/64	39/64	15.48	0.6094	11.0
R95015.5	–	15.50	0.6102	11.0
R95015.6	–	15.60	0.6142	11.6
R95015.7	–	15.70	0.6181	11.6
R9505/8	5/8	15.88	0.6250	11.6
R95016.0	–	16.00	0.6299	11.6
R95016.08	–	16.08	0.6331	11.6
R95016.1	–	16.10	0.6339	11.6
R95016.2	–	16.20	0.6378	11.6
R95041/64	41/64	16.27	0.6406	11.6
R95016.3	–	16.30	0.6417	11.6
R95016.5	–	16.50	0.6496	11.6
R95016.6	–	16.60	0.6535	12.2
R95021/32	21/32	16.67	0.6563	12.2
R95016.7	–	16.70	0.6575	12.2
R95017.0	–	17.00	0.6693	12.2
R95043/64	43/64	17.07	0.6719	12.2
R95017.1	–	17.10	0.6732	12.2
R95017.2	–	17.20	0.6772	12.2
R95011/16	11/16	17.46	0.6875	12.2
R95017.5	–	17.50	0.6890	12.2
R95017.6	–	17.60	0.6929	12.9
R95017.7	–	17.70	0.6969	12.9
R95045/64	45/64	17.86	0.7031	12.9
R95018.0	–	18.00	0.7087	12.9
R95018.1	–	18.10	0.7126	12.9
R95018.2	–	18.20	0.7165	12.9



Product	DC	DC	DC	LH
	(inch)	(mm)	(inch)	(mm)
R95023/32	23/32	18.26	0.7188	12.9
R95018.5	–	18.50	0.7283	12.9
R95018.6	–	18.60	0.7323	13.5
R95047/64	47/64	18.65	0.7344	13.5
R95018.7	–	18.70	0.7362	13.5
R95018.9	–	18.90	0.7441	13.5
R95019.0	–	19.00	0.7480	13.5
R9503/4	3/4	19.05	0.7500	13.5
R95019.1	–	19.10	0.7520	13.5
R95019.2	–	19.20	0.7559	13.5
R95019.25	–	19.25	0.7579	13.5
R95019.3	–	19.30	0.7598	13.5
R95019.35	–	19.35	0.7618	13.5
R95049/64	49/64	19.45	0.7656	13.5
R95019.5	–	19.50	0.7677	13.5
R95019.6	–	19.60	0.7717	14.1
R95019.7	–	19.70	0.7756	14.1
R95025/32	25/32	19.84	0.7813	14.1
R95020.0	–	20.00	0.7874	14.1
R95051/64	51/64	20.24	0.7969	14.1
R95020.5	–	20.50	0.8071	14.1
R95013/16	13/16	20.64	0.8125	14.8
R95021.0	–	21.00	0.8268	14.8
R95053/64	53/64	21.03	0.8281	14.8
R95027/32	27/32	21.43	0.8438	14.8
R95021.5	–	21.50	0.8465	14.8
R95055/64	55/64	21.83	0.8594	15.0
R95022.0	–	22.00	0.8661	15.0
R9507/8	7/8	22.22	0.8750	15.0
R95022.5	–	22.50	0.8858	15.0
R95057/64	57/64	22.62	0.8906	15.0
R95022.7	–	22.70	0.8937	15.0
R95023.0	–	23.00	0.9055	15.1
R95029/32	29/32	23.02	0.9063	15.1
R95059/64	59/64	23.42	0.9219	15.1
R95023.5	–	23.50	0.9252	15.1
R95015/16	15/16	23.81	0.9375	15.4
R95024.0	–	24.00	0.9449	15.4
R95061/64	61/64	24.21	0.9531	15.4
R95024.5	–	24.50	0.9646	15.4
R95031/32	31/32	24.61	0.9688	15.4
R95025.0	–	25.00	0.9844	15.8
R95063/64	63/64	25.00	0.9844	15.8
R9501	1"	25.40	1.0000	15.8
R95025.5	–	25.50	1.0039	15.8
R95025.6	–	25.60	1.0079	15.8
R95025.65	–	25.65	1.0098	15.8
R9501.1/64	1.1/64	25.80	1.0156	15.8
R95026.0	–	26.00	1.0236	16.4
R9501.1/32	1.1/32	26.19	1.0313	16.4

Product	DC	DC	DC	LH
	(inch)	(mm)	(inch)	(mm)
R95026.5	–	26.50	1.0433	16.4
R9501.3/64	1.3/64	26.59	1.0469	16.4
R9501.1/16	1.1/16	26.99	1.0625	17.1
R95027.0	–	27.00	1.0630	17.1
R9501.5/64	1.5/64	27.38	1.0781	17.1
R95027.5	–	27.50	1.0827	17.1
R9501.3/32	1.3/32	27.78	1.0938	17.1
R95028.0	–	28.00	1.1024	17.7
R9501.7/64	1.7/64	28.18	1.1094	17.7
R95028.5	–	28.50	1.1220	17.7
R9501.1/8	1.1/8	28.58	1.1250	17.7
R9501.9/64	1.9/64	28.97	1.1406	18.3
R95029.0	–	29.00	1.1417	18.3
R9501.5/32	1.5/32	29.37	1.1563	18.3
R95029.5	–	29.50	1.1614	18.3
R9501.11/64	1.11/64	29.77	1.1719	18.3
R95030.0	–	30.00	1.1811	19.0
R9501.3/16	1.3/16	30.16	1.1875	19.0
R95030.5	–	30.50	1.2008	19.0
R9501.7/32	1.7/32	30.96	1.2188	21.0
R95031.0	–	31.00	1.2205	21.0
R9501.1/4	1.1/4	31.75	1.2500	21.0
R95032.0	–	32.00	1.2598	21.0
R95032.5	–	32.50	1.2795	21.0
R9501.19/64	1.19/64	32.94	1.2969	21.0
R95033.0	–	33.00	1.2992	21.0
R95033.5	–	33.50	1.3189	21.0
R95034.0	–	34.00	1.3386	23.0
R9501.11/32	1.11/32	34.13	1.3438	23.0
R95034.5	–	34.50	1.3583	23.0
R9501.3/8	1.3/8	34.93	1.3750	23.0
R95035.0	–	35.00	1.3780	23.0
R95036.0	–	36.00	1.4173	23.0
R9501.27/64	1.27/64	36.12	1.4219	23.0
R95036.5	–	36.50	1.4370	23.0
R95037.0	–	37.00	1.4567	25.0
R9501.15/32	1.15/32	37.31	1.4688	25.0
R95037.5	–	37.50	1.4764	25.0
R95038.0	–	38.00	1.4961	25.0
R9501.1/2	1.1/2	38.10	1.5000	25.0
R95038.5	–	38.50	1.5157	25.0
R9501.17/32	1.17/32	38.89	1.5313	25.0
R95039.0	–	39.00	1.5354	25.0
R95039.5	–	39.50	1.5551	25.0
R9501.9/16	1.9/16	39.69	1.5625	27.0
R95040.0	–	40.00	1.5748	27.0
R95041.0	–	41.00	1.6142	27.0
R9501.5/8	1.5/8	41.28	1.6250	27.0
R95042.0	–	42.00	1.6535	27.0



R960



HYDRA wisselkop, geometrie voor langspanige materialen, Ti-phon gecoat

Zeer economisch en nauwkeurig ontwerp wisselkop voor hoge prestaties in langspanige staalsoorten waaronder roestvast staal. Een split point van 140° helpt bij de zelfcentrerend en vermindert de snijkrachten. De Ti-phon coating voorkomt kantopbouw en verbetert de spaanafvoer aanzienlijk, met uitstekende slijtvastheid en snijkantsterkte.

HYDRA

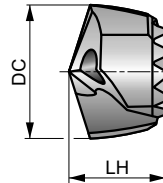

HM	DORMER	140°
Ti-phon	R	
DC h7		

H851	Pas startwaarden voor toerental en voeding toe met een correctiefactor van 1.10
H853	Pas startwaarden voor toerental en voeding toe met een correctiefactor van 1.00
H855	Pas startwaarden voor toerental en voeding toe met een correctiefactor van 0.95
H858	Pas startwaarden voor toerental en voeding toe met een correctiefactor van 0.90
H8512	Pas startwaarden voor toerental en voeding toe met een correctiefactor van 0.80

De tabel geeft de geschiktheid aan voor de materiaalgroep en de startwaarden voor de snijsnelheid (m/min) en de letter verwijst naar de toe te passen voeding (fn).

P1.1 ■ 133 W	P1.2 ■ 148 W	P1.3 ■ 154 W	P2.1 ■ 114 W	M1.1 ■ 82 V	M1.2 ■ 70 V	M2.1 ■ 73 V	M2.2 ■ 60 V	M2.3 ▣ 50 T	M3.1 ■ 58 T	M3.2 ■ 50 T	M3.3 ■ 45 T	M4.1 ■ 40 T	M4.2 ▣ 34 T
K1.1 ■ 120 V	K1.2 ■ 89 V	K1.3 ■ 67 V	K2.1 ▣ 108 V	K2.2 ▣ 88 V	K2.3 ▣ 70 V	K3.1 ▣ 96 V	K3.2 ▣ 73 V	K3.3 ▣ 59 V	K4.1 ▣ 89 V	K4.2 ▣ 67 V	K4.3 ▣ 49 V	K4.4 ▣ 42 V	K4.5 ▣ 35 V
K5.1 ▣ 100 V	K5.2 ▣ 76 V	K5.3 ▣ 58 V	S1.1 ▣ 45 T	S1.2 ▣ 35 T	S1.3 ▣ 30 S	S2.1 ▣ 40 S	S2.2 ▣ 35 S	S3.1 ▣ 30 S	S3.2 ▣ 25 S	S4.1 ▣ 23 S	S4.2 ▣ 20 S		

Product	DC	DC	DC	LH
	(inch)	(mm)	(inch)	(mm)
R96015/32	15/32	11.91	0.4688	9.1
R96012.0	–	12.00	0.4724	9.1
R96012.1	–	12.10	0.4764	9.1
R96012.2	–	12.20	0.4803	9.1
R96031/64	31/64	12.30	0.4844	9.1
R96012.5	–	12.50	0.4921	9.4
R96012.6	–	12.60	0.4961	9.4
R9601/2	1/2	12.70	0.5000	9.4
R96012.8	–	12.80	0.5039	9.4
R96012.9	–	12.90	0.5079	9.4
R96013.0	–	13.00	0.5118	9.7
R96033/64	33/64	13.10	0.5156	9.7
R96013.2	–	13.20	0.5197	9.7
R96017/32	17/32	13.49	0.5313	9.7
R96013.5	–	13.50	0.5315	10.3
R96013.6	–	13.60	0.5354	10.3
R96013.7	–	13.70	0.5394	10.3
R96013.8	–	13.80	0.5433	10.3
R96035/64	35/64	13.89	0.5469	10.3
R96014.0	–	14.00	0.5512	10.3
R96014.1	–	14.10	0.5551	10.3
R96014.2	–	14.20	0.5591	10.3
R9609/16	9/16	14.29	0.5625	10.3
R96014.5	–	14.50	0.5709	10.3
R96014.6	–	14.60	0.5748	11.0
R96037/64	37/64	14.68	0.5781	11.0
R96014.7	–	14.70	0.5787	11.0
R96014.8	–	14.80	0.5827	11.0

Product	DC	DC	DC	LH
	(inch)	(mm)	(inch)	(mm)
R96015.0	–	15.00	0.5906	11.0
R96019/32	19/32	15.08	0.5938	11.0
R96015.1	–	15.10	0.5945	11.0
R96015.2	–	15.20	0.5984	11.0
R96015.24	–	15.24	0.6000	11.0
R96039/64	39/64	15.48	0.6094	11.0
R96015.5	–	15.50	0.6102	11.0
R96015.6	–	15.60	0.6142	11.6
R96015.7	–	15.70	0.6181	11.6
R9605/8	5/8	15.88	0.6250	11.6
R96016.0	–	16.00	0.6299	11.6
R96016.08	–	16.08	0.6331	11.6
R96016.1	–	16.10	0.6339	11.6
R96016.2	–	16.20	0.6378	11.6
R96041/64	41/64	16.27	0.6406	11.6
R96016.3	–	16.30	0.6417	11.6
R96016.5	–	16.50	0.6496	11.6
R96016.6	–	16.60	0.6535	12.2
R96021/32	21/32	16.67	0.6563	12.2
R96016.7	–	16.70	0.6575	12.2
R96017.0	–	17.00	0.6693	12.2
R96043/64	43/64	17.07	0.6719	12.2
R96017.1	–	17.10	0.6732	12.2
R96017.2	–	17.20	0.6772	12.2
R96011/16	11/16	17.46	0.6875	12.2
R96017.5	–	17.50	0.6890	12.2
R96017.6	–	17.60	0.6929	12.9
R96017.7	–	17.70	0.6969	12.9



Product	DC	DC	DC	LH
	(inch)	(mm)	(inch)	(mm)
R96045/64	45/64	17.86	0.7031	12.9
R96018.0	–	18.00	0.7087	12.9
R96018.1	–	18.10	0.7126	12.9
R96018.2	–	18.20	0.7165	12.9
R96023/32	23/32	18.26	0.7188	12.9
R96018.5	–	18.50	0.7283	12.9
R96018.6	–	18.60	0.7323	13.5
R96047/64	47/64	18.65	0.7344	13.5
R96018.7	–	18.70	0.7362	13.5
R96018.9	–	18.90	0.7441	13.5
R96019.0	–	19.00	0.7480	13.5
R9603/4	3/4	19.05	0.7500	13.5
R96019.1	–	19.10	0.7520	13.5
R96019.2	–	19.20	0.7559	13.5
R96019.25	–	19.25	0.7579	13.5
R96019.3	–	19.30	0.7598	13.5
R96019.35	–	19.35	0.7618	13.5
R96049/64	49/64	19.45	0.7656	13.5
R96019.5	–	19.50	0.7677	13.5
R96019.6	–	19.60	0.7717	14.1
R96019.7	–	19.70	0.7756	14.1
R96025/32	25/32	19.84	0.7813	14.1
R96020.0	–	20.00	0.7874	14.1
R96051/64	51/64	20.24	0.7969	14.1
R96020.5	–	20.50	0.8071	14.1
R96013/16	13/16	20.64	0.8125	14.8
R96021.0	–	21.00	0.8268	14.8
R96053/64	53/64	21.03	0.8281	14.8
R96027/32	27/32	21.43	0.8438	14.8
R96021.5	–	21.50	0.8465	14.8
R96055/64	55/64	21.83	0.8594	15.0
R96022.0	–	22.00	0.8661	15.0
R9607/8	7/8	22.22	0.8750	15.0
R96022.5	–	22.50	0.8858	15.0
R96057/64	57/64	22.62	0.8906	15.0
R96022.7	–	22.70	0.8937	15.0

Product	DC	DC	DC	LH
	(inch)	(mm)	(inch)	(mm)
R96023.0	–	23.00	0.9055	15.1
R96029/32	29/32	23.02	0.9063	15.1
R96059/64	59/64	23.42	0.9219	15.1
R96023.5	–	23.50	0.9252	15.1
R96015/16	15/16	23.81	0.9375	15.4
R96024.0	–	24.00	0.9449	15.4
R96061/64	61/64	24.21	0.9531	15.4
R96024.5	–	24.50	0.9646	15.4
R96031/32	31/32	24.61	0.9688	15.4
R96025.0	–	25.00	0.9844	15.8
R96063/64	63/64	25.00	0.9844	15.8
R9601	1"	25.40	1.0000	15.8
R96025.5	–	25.50	1.0039	15.8
R96025.65	–	25.65	1.0098	15.8
R9601.1/64	1.1/64	25.80	1.0156	15.8
R96026.0	–	26.00	1.0236	16.4
R9601.1/32	1.1/32	26.19	1.0313	16.4
R96026.5	–	26.50	1.0433	16.4
R9601.3/64	1.3/64	26.59	1.0469	16.4
R9601.1/16	1.1/16	26.99	1.0625	17.1
R96027.0	–	27.00	1.0630	17.1
R9601.5/64	1.5/64	27.38	1.0781	17.1
R96027.5	–	27.50	1.0827	17.1
R9601.3/32	1.3/32	27.78	1.0938	17.1
R96028.0	–	28.00	1.1024	17.7
R9601.7/64	1.7/64	28.18	1.1094	17.7
R96028.5	–	28.50	1.1220	17.7
R9601.1/8	1.1/8	28.58	1.1250	17.7
R9601.9/64	1.9/64	28.97	1.1406	18.3
R96029.0	–	29.00	1.1417	18.3
R9601.5/32	1.5/32	29.37	1.1563	18.3
R96029.5	–	29.50	1.1614	18.3
R9601.11/64	1.11/64	29.77	1.1719	18.3
R96030.0	–	30.00	1.1811	19.0
R9601.3/16	1.3/16	30.16	1.1875	19.0
R96030.5	–	30.50	1.2008	19.0



R970



HYDRA wisselkop, geometrie voor kortspanige materialen, Ti-phon gecoat

Zeer economisch en nauwkeurig ontwerp wisselkop voor hoge prestaties in kortspanige materialen zoals gierijzer. Een split point van 140° helpt bij de zelfcentering en vermindert de snijkrachten. De Ti-phon coating voorkomt kantopbouw en verbetert de spaanafvoer aanzienlijk, met uitstekende slijtvastheid en slijkantsterkte.

HYDRA

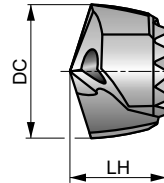

HM	DORMER	140°
Ti-phon	R	
DC h7		

H851	Pas startwaarden voor toerental en voeding toe met een correctiefactor van 1.10
H853	Pas startwaarden voor toerental en voeding toe met een correctiefactor van 1.00
H855	Pas startwaarden voor toerental en voeding toe met een correctiefactor van 0.95
H858	Pas startwaarden voor toerental en voeding toe met een correctiefactor van 0.90
H8512	Pas startwaarden voor toerental en voeding toe met een correctiefactor van 0.80

De tabel geeft de geschiktheid aan voor de materiaalgroep en de startwaarden voor de snijsnelheid (m/min) en de letter verwijst naar de toe te passen voeding (fn).

K1.1 ■ 120 V	K1.2 ■ 89 V	K1.3 ■ 67 V	K2.1 ■ 98 V	K2.2 ■ 80 V	K2.3 ■ 64 V	K3.1 ■ 97 V	K3.2 ■ 67 V	K3.3 ■ 54 V	K4.1 ■ 81 V	K4.2 ■ 61 V	K4.3 ■ 45 V	K4.4 ■ 38 V	K4.5 ■ 32 V
K5.1 ■ 91 V	K5.2 ■ 69 V	K5.3 ■ 53 V											

Product	DC	DC	DC	LH
	(inch)	(mm)	(inch)	(mm)
R97015/32	15/32	11.91	0.4688	9.1
R97012.0	–	12.00	0.4724	9.1
R97012.1	–	12.10	0.4764	9.1
R97012.2	–	12.20	0.4803	9.1
R97031/64	31/64	12.30	0.4844	9.1
R97012.5	–	12.50	0.4921	9.4
R97012.6	–	12.60	0.4961	9.4
R9701/2	1/2	12.70	0.5000	9.4
R97012.8	–	12.80	0.5039	9.4
R97012.9	–	12.90	0.5079	9.4
R97013.0	–	13.00	0.5118	9.7
R97033/64	33/64	13.10	0.5156	9.7
R97013.2	–	13.20	0.5197	9.7
R97017/32	17/32	13.49	0.5313	9.7
R97013.5	–	13.50	0.5315	10.3
R97013.6	–	13.60	0.5354	10.3
R97013.7	–	13.70	0.5394	10.3
R97013.8	–	13.80	0.5433	10.3
R97035/64	35/64	13.89	0.5469	10.3
R97014.0	–	14.00	0.5512	10.3
R97014.1	–	14.10	0.5551	10.3
R97014.2	–	14.20	0.5591	10.3
R9709/16	9/16	14.29	0.5625	10.3
R97014.5	–	14.50	0.5709	10.3
R97014.6	–	14.60	0.5748	11.0
R97037/64	37/64	14.68	0.5781	11.0
R97014.7	–	14.70	0.5787	11.0
R97014.8	–	14.80	0.5827	11.0
R97015.0	–	15.00	0.5906	11.0
R97019/32	19/32	15.08	0.5938	11.0

Product	DC	DC	DC	LH
	(inch)	(mm)	(inch)	(mm)
R97015.1	–	15.10	0.5945	11.0
R97015.2	–	15.20	0.5984	11.0
R97015.24	–	15.24	0.6000	11.0
R97039/64	39/64	15.48	0.6094	11.0
R97015.5	–	15.50	0.6102	11.0
R97015.6	–	15.60	0.6142	11.6
R97015.7	–	15.70	0.6181	11.6
R9705/8	5/8	15.88	0.6250	11.6
R97016.0	–	16.00	0.6299	11.6
R97016.08	–	16.08	0.6331	11.6
R97016.1	–	16.10	0.6339	11.6
R97016.2	–	16.20	0.6378	11.6
R97041/64	41/64	16.27	0.6406	11.6
R97016.3	–	16.30	0.6417	11.6
R97016.5	–	16.50	0.6496	11.6
R97016.6	–	16.60	0.6535	12.2
R97021/32	21/32	16.67	0.6563	12.2
R97016.7	–	16.70	0.6575	12.2
R97017.0	–	17.00	0.6693	12.2
R97043/64	43/64	17.07	0.6719	12.2
R97017.1	–	17.10	0.6732	12.2
R97017.2	–	17.20	0.6772	12.2
R97011/16	11/16	17.46	0.6875	12.2
R97017.5	–	17.50	0.6890	12.2
R97017.6	–	17.60	0.6929	12.9
R97017.7	–	17.70	0.6969	12.9
R97045/64	45/64	17.86	0.7031	12.9
R97018.0	–	18.00	0.7087	12.9
R97018.1	–	18.10	0.7126	12.9
R97018.2	–	18.20	0.7165	12.9



Product	DC	DC	DC	LH
	(inch)	(mm)	(inch)	(mm)
R97023/32	23/32	18.26	0.7188	12.9
R97018.5	–	18.50	0.7283	12.9
R97018.6	–	18.60	0.7323	13.5
R97047/64	47/64	18.65	0.7344	13.5
R97018.7	–	18.70	0.7362	13.5
R97018.9	–	18.90	0.7441	13.5
R97019.0	–	19.00	0.7480	13.5
R9703/4	3/4	19.05	0.7500	13.5
R97019.1	–	19.10	0.7520	13.5
R97019.2	–	19.20	0.7559	13.5
R97019.25	–	19.25	0.7579	13.5
R97019.3	–	19.30	0.7598	13.5
R97019.35	–	19.35	0.7618	13.5
R97049/64	49/64	19.45	0.7656	13.5
R97019.5	–	19.50	0.7677	13.5
R97019.6	–	19.60	0.7717	14.1
R97019.7	–	19.70	0.7756	14.1
R97025/32	25/32	19.84	0.7813	14.1
R97020.0	–	20.00	0.7874	14.1
R97051/64	51/64	20.24	0.7969	14.1
R97020.5	–	20.50	0.8071	14.1
R97013/16	13/16	20.64	0.8125	14.8
R97021.0	–	21.00	0.8268	14.8
R97053/64	53/64	21.03	0.8281	14.8
R97027/32	27/32	21.43	0.8438	14.8
R97021.5	–	21.50	0.8465	14.8
R97055/64	55/64	21.83	0.8594	15.0
R97022.0	–	22.00	0.8661	15.0
R9707/8	7/8	22.22	0.8750	15.0
R97022.5	–	22.50	0.8858	15.0
R97057/64	57/64	22.62	0.8906	15.0
R97022.7	–	22.70	0.8937	15.0
R97023.0	–	23.00	0.9055	15.1
R97029/32	29/32	23.02	0.9063	15.1
R97059/64	59/64	23.42	0.9219	15.1
R97023.5	–	23.50	0.9252	15.1
R97015/16	15/16	23.81	0.9375	15.4
R97024.0	–	24.00	0.9449	15.4
R97061/64	61/64	24.21	0.9531	15.4
R97024.5	–	24.50	0.9646	15.4
R97031/32	31/32	24.61	0.9688	15.4
R97025.0	–	25.00	0.9844	15.8
R97063/64	63/64	25.00	0.9844	15.8
R9701	1"	25.40	1.0000	15.8
R97025.5	–	25.50	1.0039	15.8
R97025.65	–	25.65	1.0098	15.8
R9701.1/64	1.1/64	25.80	1.0156	15.8
R97026.0	–	26.00	1.0236	16.4
R9701.1/32	1.1/32	26.19	1.0313	16.4

Product	DC	DC	DC	LH
	(inch)	(mm)	(inch)	(mm)
R97026.5	–	26.50	1.0433	16.4
R9701.3/64	1.3/64	26.59	1.0469	16.4
R9701.1/16	1.1/16	26.99	1.0625	17.1
R97027.0	–	27.00	1.0630	17.1
R9701.5/64	1.5/64	27.38	1.0781	17.1
R97027.5	–	27.50	1.0827	17.1
R9701.3/32	1.3/32	27.78	1.0938	17.1
R97028.0	–	28.00	1.1024	17.7
R9701.7/64	1.7/64	28.18	1.1094	17.7
R97028.5	–	28.50	1.1220	17.7
R9701.1/8	1.1/8	28.58	1.1250	17.7
R9701.9/64	1.9/64	28.97	1.1406	18.3
R97029.0	–	29.00	1.1417	18.3
R9701.5/32	1.5/32	29.37	1.1563	18.3
R97029.5	–	29.50	1.1614	18.3
R9701.11/64	1.11/64	29.77	1.1719	18.3
R97030.0	–	30.00	1.1811	19.0
R9701.3/16	1.3/16	30.16	1.1875	19.0
R97030.5	–	30.50	1.2008	19.0
R9701.7/32	1.7/32	30.96	1.2188	21.0
R97031.0	–	31.00	1.2205	21.0
R9701.1/4	1.1/4	31.75	1.2500	21.0
R97032.0	–	32.00	1.2598	21.0
R97032.5	–	32.50	1.2795	21.0
R9701.19/64	1.19/64	32.94	1.2969	21.0
R97033.0	–	33.00	1.2992	21.0
R97033.5	–	33.50	1.3189	21.0
R97034.0	–	34.00	1.3386	23.0
R9701.11/32	1.11/32	34.13	1.3438	23.0
R97034.5	–	34.50	1.3583	23.0
R9701.3/8	1.3/8	34.93	1.3750	23.0
R97035.0	–	35.00	1.3780	23.0
R97036.0	–	36.00	1.4173	23.0
R9701.27/64	1.27/64	36.12	1.4219	23.0
R97036.5	–	36.50	1.4370	23.0
R97037.0	–	37.00	1.4567	25.0
R9701.15/32	1.15/32	37.31	1.4688	25.0
R97037.5	–	37.50	1.4764	25.0
R97038.0	–	38.00	1.4961	25.0
R9701.1/2	1.1/2	38.10	1.5000	25.0
R97038.5	–	38.50	1.5157	25.0
R9701.17/32	1.17/32	38.89	1.5313	25.0
R97039.0	–	39.00	1.5354	25.0
R97039.5	–	39.50	1.5551	25.0
R9701.9/16	1.9/16	39.69	1.5625	27.0
R97040.0	–	40.00	1.5748	27.0
R97041.0	–	41.00	1.6142	27.0
R9701.5/8	1.5/8	41.28	1.6250	27.0
R97042.0	–	42.00	1.6535	27.0

NEW**H851****DORMER****HYDRA modulair boorsysteem 1.5XD, met koelkanalen**

Te gebruiken met Hydra wisselkop R590, R960 of R970. Op deze modulaire koelkanaalboor kunnen binnen een bepaalde range wisselkoppen van verschillende diameter worden gemonteerd. Ideaal voor het boren van startgaten bij de 8xD en 12xD boren. Voorzien van universele eenheidsschacht voor eenvoudige opname in diverse systemen.

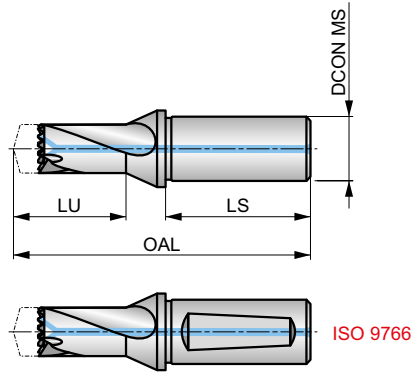
HYDRA

HSS	DORMER	1.5xD
Bright Ni	ISO 9766	R

Hydra boor is inclusief 4 schroeven en 1 schroevendraaier. DCON MS passing h6.

Product	DCONMS	DCON MS	LU	OAL	LS	ADINTMS
	(inch)	(mm)	(mm)	(mm)	(mm)	
H85131/64	5/8	15.88	25.50	88.5	47.6	Cylindrical
H8511/2	5/8	15.88	25.80	88.8	47.6	Cylindrical
H85117/32	5/8	15.88	30.90	93.9	47.6	Cylindrical
H85112.0	–	16.00	25.50	88.5	48.0	ISO 9766
H85112.5	–	16.00	25.80	88.8	48.0	ISO 9766
H85113.0	–	16.00	27.00	90.0	48.0	ISO 9766
H85114.0	–	16.00	30.90	93.9	48.0	ISO 9766
H8519/16	3/4	19.05	30.30	93.9	50.8	Cylindrical
H85139/64	3/4	19.05	32.30	97.3	50.8	Cylindrical
H85141/64	3/4	19.05	34.90	99.9	50.8	Cylindrical
H85111/16	3/4	19.05	36.40	101.4	50.8	Cylindrical
H85123/32	3/4	19.05	39.00	104.0	50.8	Cylindrical
H85115.0	–	20.00	32.30	97.3	50.0	ISO 9766
H85116.0	–	20.00	34.90	99.9	50.0	ISO 9766
H85117.0	–	20.00	36.40	101.4	50.0	ISO 9766
H85118.0	–	20.00	39.00	104.0	50.0	ISO 9766
H85119.0	–	25.00	40.40	111.4	56.0	ISO 9766
H85120.0	–	25.00	43.00	114.0	56.0	ISO 9766
H85121.0	–	25.00	44.50	115.5	56.0	ISO 9766
H85122.0	–	25.00	46.10	117.1	56.0	ISO 9766
H85123.0	–	25.00	47.00	118.0	56.0	ISO 9766
H85149/64	1"	25.40	40.40	111.4	57.1	Cylindrical
H85151/64	1"	25.40	43.00	114.0	57.1	Cylindrical
H85127/32	1"	25.40	44.50	115.5	57.1	Cylindrical
H85157/64	1"	25.40	46.10	117.1	57.1	Cylindrical
H85159/64	1"	25.40	47.00	118.0	57.1	Cylindrical
H85131/32	1"	25.40	49.30	124.3	57.1	Cylindrical
H8511.1/64	1.1/4	31.75	49.70	124.7	60.3	Cylindrical
H8511.3/64	1.1/4	31.75	52.30	127.3	60.3	Cylindrical
H8511.3/32	1.1/4	31.75	52.80	127.8	60.3	Cylindrical
H8511.1/8	1.1/4	31.75	54.40	129.4	60.3	Cylindrical
H8511.11/64	1.1/4	31.75	55.80	130.8	60.3	Cylindrical
H8511.3/16	1.1/4	31.75	58.40	133.4	60.3	Cylindrical
H85124.0	–	32.00	49.30	124.3	60.0	ISO 9766



Product	DCONMS	DCON MS	LU	OAL	LS	ADINTMS
	(inch)	(mm)	(mm)	(mm)	(mm)	
H85125.0	—	32.00	49.70	124.7	60.0	ISO 9766
H85126.0	—	32.00	52.30	127.3	60.0	ISO 9766
H85127.0	—	32.00	52.80	127.8	60.0	ISO 9766
H85128.0	—	32.00	54.40	129.4	60.0	ISO 9766
H85129.0	—	32.00	55.80	130.8	60.0	ISO 9766
H85130.0	—	32.00	58.40	133.4	60.0	ISO 9766



H853



HYDRA modulair boorsysteem 3XD, met koelkanalen

Te gebruiken met Hydra wisselkop R590, R960 of R970. Op deze modulaire koelkanaalboor kunnen binnen een bepaalde range wisselkoppen van verschillende diameter worden gemonteerd. Het wisselen van de kop kan in de machine geschieden. Nauwkeurig gepositioneerde koelkanalen zorgen voor een efficiënte koeling en spaanafvoer. Voorzien van universele eenheidsschacht voor eenvoudige opname in diverse systemen.

HYDRA

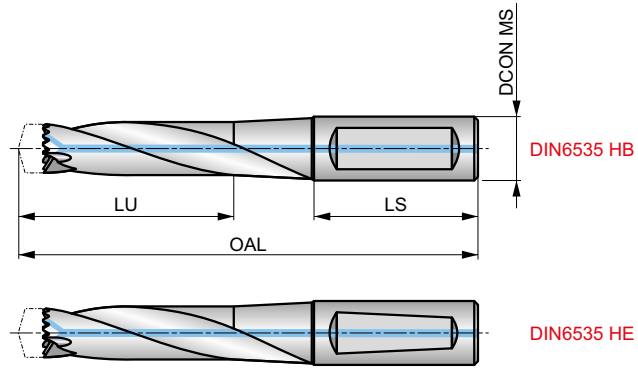

HSS	DORMER	3xD
Bright Ni	DIN 6535HB DIN 6535HE	R

Hydra boor is inclusief 4 schroeven en 1 schroevendraaier. DCON MS passing h6.

Product	DCONMS	DCON MS	LU	OAL	LS	ADINTMS
	(inch)	(mm)	(mm)	(mm)	(mm)	
H85312.0	–	16.00	44.00	105.0	48.0	DIN6535HE
H85331/64	5/8	15.88	44.00	105.0	48.0	DIN6535HB
H85312.5	–	16.00	44.00	105.0	48.0	DIN6535HE
H8531/2	5/8	15.88	44.00	105.0	48.0	DIN6535HB
H85313.0	–	16.00	47.00	110.0	48.0	DIN6535HE
H85317/32	5/8	15.88	47.00	110.0	48.0	DIN6535HB
H85314.0	–	16.00	52.50	116.5	48.0	DIN6535HE
H8539/16	3/4	19.05	52.50	116.5	48.0	DIN6535HB
H85315.0	–	20.00	55.50	126.5	50.0	DIN6535HE
H85339/64	3/4	19.05	55.50	126.5	50.0	DIN6535HB
H85316.0	–	20.00	59.50	131.5	50.0	DIN6535HE
H85341/64	3/4	19.05	59.50	131.5	50.0	DIN6535HB
H85317.0	–	20.00	62.50	136.5	50.0	DIN6535HE
H85311/16	3/4	19.05	62.50	136.5	50.0	DIN6535HB
H85318.0	–	20.00	66.50	141.5	50.0	DIN6535HE
H85323/32	3/4	19.05	66.50	141.5	50.0	DIN6535HB
H85319.0	–	25.00	69.50	156.5	56.0	DIN6535HE
H85349/64	1"	25.40	69.50	156.5	56.0	DIN6535HB
H85320.0	–	25.00	73.50	156.5	56.0	DIN6535HE
H85351/64	1"	25.40	73.50	156.5	56.0	DIN6535HB
H85321.0	–	25.00	76.50	156.5	56.0	DIN6535HE
H85327/32	1"	25.40	76.50	156.5	56.0	DIN6535HB
H85322.0	–	25.00	80.10	161.5	56.0	DIN6535HE
H85357/64	1"	25.40	80.10	161.5	56.0	DIN6535HB
H85323.0	–	25.00	82.50	160.5	56.0	DIN6535HE
H85359/64	1"	25.40	82.50	160.5	56.0	DIN6535HB
H85324.0	–	32.00	86.20	170.2	60.0	DIN6535HE
H85331/32	1"	25.40	86.20	170.2	60.0	DIN6535HB
H85325.0	–	32.00	88.00	170.0	60.0	DIN6535HE
H8531.1/64	1.1/4	31.75	88.00	170.0	60.0	DIN6535HB
H85326.0	–	32.00	92.00	175.0	60.0	DIN6535HE
H8531.3/64	1.1/4	31.75	92.00	175.0	60.0	DIN6535HB
H85327.0	–	32.00	94.00	175.0	60.0	DIN6535HE
H8531.3/32	1.1/4	31.75	94.00	175.0	60.0	DIN6535HB



Product	DCONMS	DCON MS	LU	OAL	LS	ADINTMS
	(inch)	(mm)	(mm)	(mm)	(mm)	
H85328.0	–	32.00	97.00	180.0	60.0	DIN6535HE
H8531.1/8	1.1/4	31.75	97.00	180.0	60.0	DIN6535HB
H85329.0	–	32.00	100.00	185.0	60.0	DIN6535HE
H8531.11/64	1.1/4	31.75	100.00	185.0	60.0	DIN6535HB
H85330.0	–	32.00	104.00	185.0	60.0	DIN6535HE
H8531.3/16	1.1/4	31.75	104.00	185.0	60.0	DIN6535HB
H85332.0	–	32.00	111.50	196.5	60.0	DIN6535HE
H85333.5	–	32.00	116.50	201.5	60.0	DIN6535HE
H85335.0	–	40.00	121.50	216.5	70.0	DIN6535HB
H85336.5	–	40.00	125.50	221.5	70.0	DIN6535HB
H85338.0	–	40.00	131.50	226.5	70.0	DIN6535HB
H85339.5	–	40.00	136.50	231.5	70.0	DIN6535HB
H85341.0	–	40.00	146.50	246.5	70.0	DIN6535HB
H85342.5	–	40.00	151.60	251.6	70.0	DIN6535HB



H855



HYDRA modulair boorsysteem 5XD, met koelkanalen

Te gebruiken met Hydra wisselkop R590, R960 of R970. Op deze modulaire koelkanaalboor kunnen binnen een bepaalde range wisselkoppen van verschillende diameter worden gemonteerd. Het wisselen van de kop kan in de machine geschieden. Nauwkeurig gepositioneerde koelkanalen zorgen voor een efficiënte koeling en spaanafvoer. Voorzien van universele eenheidsschacht voor eenvoudige opname in diverse systemen.

HYDRA

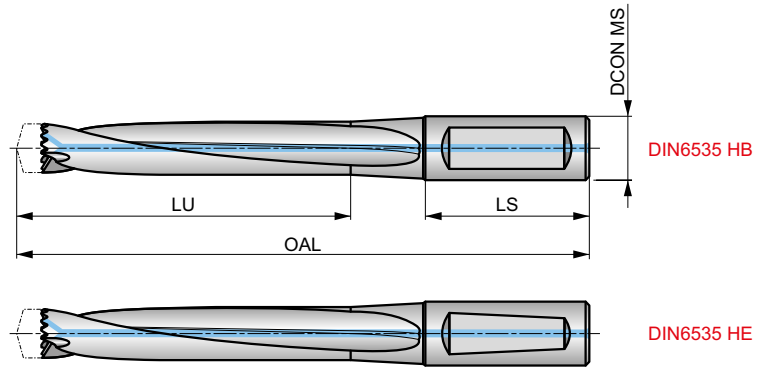

HSS	DORMER	5xD
Bright Ni	DIN 6535HB DIN 6535HE	R

Hydra boor is inclusief 4 schroeven en 1 schroevendraaier. DCON MS passing h6.

Product	DCONMS	DCON MS	LU	OAL	LS	ADINTMS
	(inch)	(mm)	(mm)	(mm)	(mm)	
H85512.0	–	16.00	69.00	130.0	48.0	DIN6535HE
H85531/64	5/8	15.88	69.00	130.0	48.0	DIN6535HB
H85512.5	–	16.00	69.00	130.0	48.0	DIN6535HE
H8551/2	5/8	15.88	69.00	130.0	48.0	DIN6535HB
H85513.0	–	16.00	74.00	140.0	48.0	DIN6535HE
H85517/32	5/8	15.88	74.00	140.0	48.0	DIN6535HB
H85514.0	–	16.00	81.50	146.5	48.0	DIN6535HE
H8559/16	3/4	19.05	81.50	146.5	48.0	DIN6535HB
H85515.0	–	20.00	86.50	156.5	50.0	DIN6535HE
H85539/64	3/4	19.05	86.50	156.5	50.0	DIN6535HB
H85516.0	–	20.00	92.50	166.5	50.0	DIN6535HE
H85541/64	3/4	19.05	92.50	166.5	50.0	DIN6535HB
H85517.0	–	20.00	97.50	171.5	50.0	DIN6535HE
H85511/16	3/4	19.05	97.50	171.5	50.0	DIN6535HB
H85518.0	–	20.00	103.50	176.5	50.0	DIN6535HE
H85523/32	3/4	19.05	103.50	176.5	50.0	DIN6535HB
H85519.0	–	25.00	108.50	191.5	56.0	DIN6535HE
H85549/64	1"	25.40	108.50	191.5	56.0	DIN6535HB
H85520.0	–	25.00	114.50	196.5	56.0	DIN6535HE
H85551/64	1"	25.40	114.50	196.5	56.0	DIN6535HB
H85521.0	–	25.00	119.50	196.5	56.0	DIN6535HE
H85527/32	1"	25.40	119.50	196.5	56.0	DIN6535HB
H85522.0	–	25.00	125.10	201.1	56.0	DIN6535HE
H85557/64	1"	25.40	125.10	201.1	56.0	DIN6535HB
H85523.0	–	25.00	129.50	210.5	56.0	DIN6535HE
H85559/64	1"	25.40	129.50	210.5	56.0	DIN6535HB
H85524.0	–	32.00	135.20	220.2	60.0	DIN6535HE
H85531/32	1"	25.40	135.20	220.2	60.0	DIN6535HB
H85525.0	–	32.00	140.00	225.0	60.0	DIN6535HE
H8551.1/64	1.1/4	31.75	140.00	225.0	60.0	DIN6535HB
H85526.0	–	32.00	146.00	230.0	60.0	DIN6535HE
H8551.3/64	1.1/4	31.75	146.00	230.0	60.0	DIN6535HB
H85527.0	–	32.00	151.00	235.0	60.0	DIN6535HE
H8551.3/32	1.1/4	31.75	151.00	235.0	60.0	DIN6535HB



Product	DCONMS	DCON MS	LU	OAL	LS	ADINTMS
	(inch)	(mm)	(mm)	(mm)	(mm)	
H85528.0	–	32.00	157.00	240.0	60.0	DIN6535HE
H8551.1/8	1.1/4	31.75	157.00	240.0	60.0	DIN6535HB
H85529.0	–	32.00	162.00	245.0	60.0	DIN6535HE
H8551.11/64	1.1/4	31.75	162.00	245.0	60.0	DIN6535HB
H85530.0	–	32.00	167.00	255.0	60.0	DIN6535HE
H8551.3/16	1.1/4	31.75	167.00	255.0	60.0	DIN6535HB
H85532.0	–	32.00	176.50	261.5	60.0	DIN6535HE
H85533.5	–	32.00	186.50	271.5	60.0	DIN6535HE
H85535.0	–	40.00	196.50	291.5	70.0	DIN6535HB
H85536.5	–	40.00	201.50	296.5	70.0	DIN6535HB
H85538.0	–	40.00	211.50	306.5	70.0	DIN6535HB
H85539.5	–	40.00	221.50	316.5	70.0	DIN6535HB
H85541.0	–	40.00	226.50	325.6	70.0	DIN6535HB
H85542.5	–	40.00	236.50	336.5	70.0	DIN6535HB



H858



HYDRA modulair boorsysteem 8XD, met koelkanalen

Te gebruiken met Hydra wisselkop R590, R960 of R970. Op deze modulaire koelkanaalboor kunnen binnen een bepaalde range wisselkoppen van verschillende diameter worden gemonteerd. Het wisselen van de kop kan in de machine geschieden. Nauwkeurig gepositioneerde koelkanalen zorgen voor een efficiënte koeling en spaanafvoer. Voorzien van universele eenheidsschacht voor eenvoudige opname in diverse systemen.

HYDRA

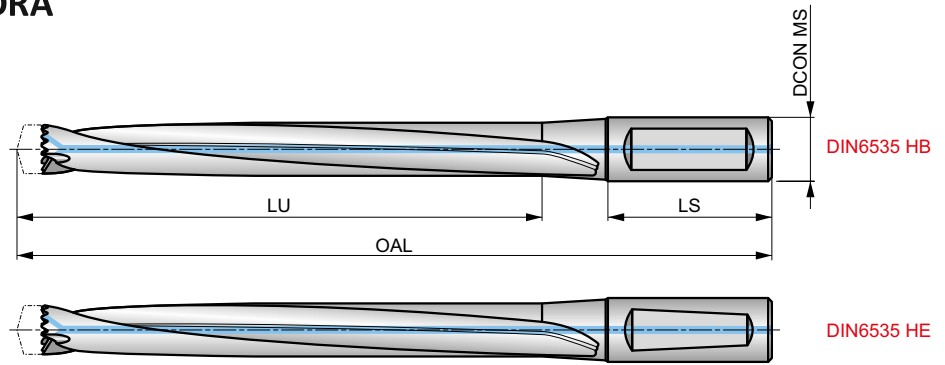

HSS	DORMER	8xD
Bright Ni	DIN 6535HB DIN 6535HE	R

Hydra boor is inclusief 4 schroeven en 1 schroevendraaier. DCON MS passing h6.

Product	DCON MS (mm)	LU (mm)	OAL (mm)	LS (mm)	ADINTMS
H85814.0	16.00	124.50	191.5	48.0	DIN6535HE
H85815.0	20.00	133.50	201.5	50.0	DIN6535HE
H85816.0	20.00	141.50	211.5	50.0	DIN6535HE
H85817.0	20.00	150.50	221.5	50.0	DIN6535HE
H85818.0	20.00	158.50	226.5	50.0	DIN6535HE
H85819.0	25.00	167.50	251.5	56.0	DIN6535HE
H85820.0	25.00	175.50	264.5	56.0	DIN6535HE
H85821.0	25.00	184.50	266.5	56.0	DIN6535HE
H85822.0	25.00	192.10	271.1	56.0	DIN6535HE
H85823.0	25.00	200.50	280.5	56.0	DIN6535HE
H85824.0	32.00	208.20	295.2	60.0	DIN6535HE
H85825.0	32.00	217.00	300.0	60.0	DIN6535HE
H85826.0	32.00	225.00	310.0	60.0	DIN6535HE
H85827.0	32.00	234.00	320.0	60.0	DIN6535HE
H85828.0	32.00	242.00	325.0	60.0	DIN6535HE
H85829.0	32.00	251.00	335.0	60.0	DIN6535HE
H85830.0	32.00	259.00	345.0	60.0	DIN6535HE
H85832.0	32.00	271.50	356.5	60.0	DIN6535HE
H85833.5	32.00	286.50	371.5	60.0	DIN6535HE
H85835.0	40.00	301.50	396.5	70.0	DIN6535HB
H85836.5	40.00	311.50	406.5	70.0	DIN6535HB
H85838.0	40.00	326.50	421.5	70.0	DIN6535HB
H85839.5	40.00	336.50	431.5	70.0	DIN6535HB
H85841.0	40.00	351.50	451.5	70.0	DIN6535HB
H85842.5	40.00	361.50	461.5	70.0	DIN6535HB

**NEW****H8512****DORMER****HYDRA modulair boorsysteem 12XD, met koelkanalen**

Te gebruiken met Hydra wisselkop R590, R960 of R970. Op deze modulaire koelkanaalboor kunnen binnen een bepaalde range wisselkoppen van verschillende diameter worden gemonteerd. Extra diepe en gepolijste spaangroeven en grotere spiraalhoek voor efficiënt afvoeren van de spanen. Voorzien van universele eenheidsschacht voor eenvoudige opname in diverse systemen.

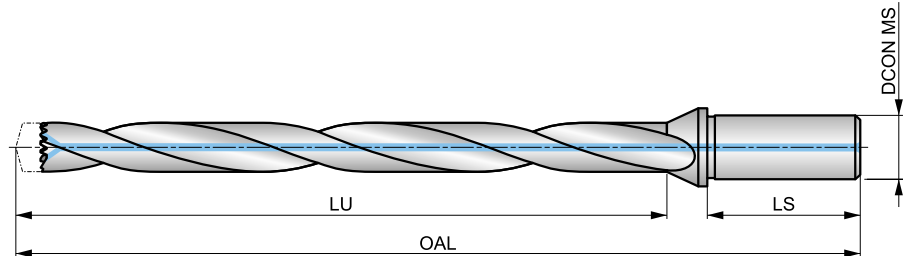
HYDRA

HSS	DORMER	12xD
Bright Ni		R

Hydra boor is inclusief 4 schroeven en 1 schroevendraaier. DCON MS passing h6.

Product	DCON MS	LU	OAL	LS
	(mm)	(mm)	(mm)	(mm)
H851214.0	16.00	168.00	236.0	48.0
H851215.0	20.00	180.00	250.3	50.0
H851216.0	20.00	192.00	262.6	50.0
H851217.0	20.00	204.00	275.0	50.0
H851218.0	20.00	216.00	287.2	50.0
H851219.0	25.00	228.00	305.6	56.0
H851220.0	25.00	240.00	317.8	56.0
H851221.0	25.00	252.00	330.1	56.0
H851222.0	25.00	264.00	343.0	56.0
H851223.0	25.00	276.00	354.8	56.0
H851224.0	32.00	288.00	371.7	60.0
H851225.0	32.00	300.00	383.8	60.0



H860



Hydra schroeven

Reserve schroeven om de HYDRA wisselkoppen te bevestigen.

HYDRA

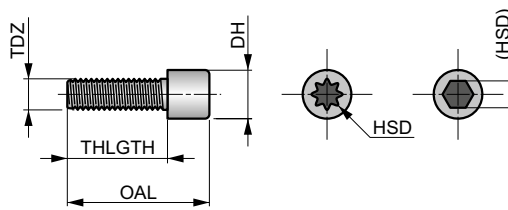

Product	Nr.	TDZ	OAL	THLGTH	DH	HSD
			(mm)	(mm)	(mm)	
H860N1	1	M2.2	7.5	5.70	3.5	8IP
H860N2	2	M2.5	9.0	7.00	4.1	10IP
H860N3	3	M3.0	10.5	8.00	4.9	15IP
H860N4	4	M3.5	11.5	8.80	5.5	15IP
H860N5	5	M4.0	12.5	9.50	6.0	20IP
H860N6	6	M4.5	14.3	10.80	6.8	25IP
H860N7	7	M5.0	20.0	15.00	8.5	4



H861



Hydra schroevendraaier

Schroevendraaiers voor het vastdraaien van de HYDRA schroeven.

HYDRA

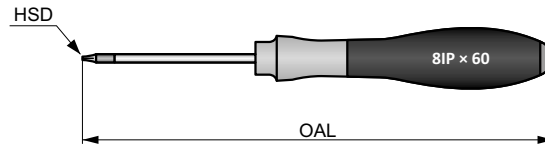

Product	Nr.	HSD	OAL
			(mm)
H861N1	N1	8IP	164.0
H861N2	N2	10IP	191.0
H861N3	N3	15IP	191.0
H861N4	N4	20IP	218.0
H861N5	N5	25IP	218.0
H861N6	N6	4	186.0



CORRECTIEFACTOREN (AFHANKELIJK VAN HYDRA LENGTE)

H851	Pas startwaarden voor toerental en voeding toe met een correctiefactor van 1.10
H853	Pas startwaarden voor toerental en voeding toe met een correctiefactor van 1.00
H855	Pas startwaarden voor toerental en voeding toe met een correctiefactor van 0.95
H858	Pas startwaarden voor toerental en voeding toe met een correctiefactor van 0.90
H8512	Pas startwaarden voor toerental en voeding toe met een correctiefactor van 0.80



HYDRA
TECHNISCHE INFORMATIE



HYDRA – TECHNISCHE INFORMATIE

Tabel aanhaalmomenten

H860	H861	Wisselkop \varnothing Metrische reeks	Wisselkop \varnothing Inch reeks	Wisselkop \varnothing Decimale inch reeks (min. / max.)	Aanhaalmoment Nm (Metrisch Systeem)	Aanhaalmoment in/lbs (Inch Systeem)
H860N1	H861N1	12.0 mm – 15.5 mm	15/32" – 39/64"	0.4688" – 0.6102"	0.75 – 0.99	6.6 – 8.8
H860N2	H861N2	15.6 mm – 18.5 mm	5/8" – 23/32"	0.6142" – 0.7283"	0.93 – 1.24	8.2 – 11.0
H860N3	H861N3	18.6 mm – 21.5 mm	47/64" – 27/32"	0.7323" – 0.8465"	1.84 – 2.44	16.3 – 21.6
H860N4	H861N3	22.0 mm – 24.5 mm	55/64" – 31/32"	0.8594" – 0.9688"	2.73 – 3.72	24.2 – 32.9
H860N5	H861N4	25.0 mm – 27.5 mm	63/64" – 1-3/32"	0.9843" – 1.0938"	4.14 – 5.52	36.6 – 48.8
H860N6	H861N5	28.0 mm – 33.5 mm	1-7/64" – 1-19/64"	1.1024" – 1.3189"	4.97 – 6.63	44.0 – 58.7
H860N7	H861N6	34.0 mm – 42.0 mm	1-11/32" – 1-5/8"	1.3386" – 1.6535"	7.2	63.7

Schroeven en schroevendraaier gegevens

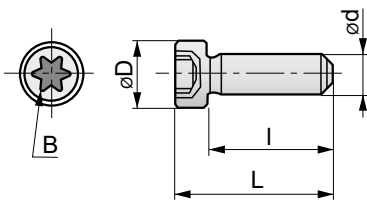

e-code	d	Spoed	L (mm)	I (mm)	D (mm)	B
H860N1	M2.2	0.45	7.5	5.7	3.5	8IP
H860N2	M2.5	0.45	9.0	7.0	4.1	10IP
H860N3	M3.0	0.50	10.5	8.0	4.9	15IP
H860N4	M3.5	0.60	11.5	8.8	5.5	15IP
H860N5	M4.0	0.70	12.5	9.5	6.0	20IP
H860N6	M4.5	0.75	14.3	10.8	6.8	25IP

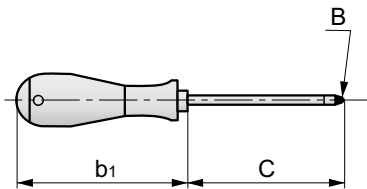

e-code	B	C	b ₁
H861N1	8IP	60	104
H861N2	10IP	80	111
H861N3	15IP	80	111
H861N4	20IP	100	118
H861N5	25IP	100	118

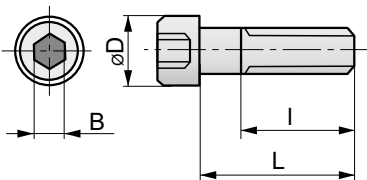

e-code	d	Spoed	L (mm)	I (mm)	D (mm)	B
H860N7	M5.0	0.8	15	full	8.5	4

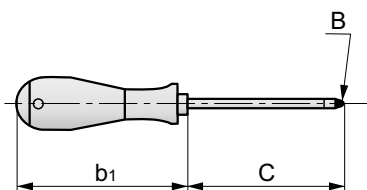

e-code	B	C	b ₁
H861N6	4	75	111



Aanbevelingen bij het boren met de Hydra 8xD en 12xD

Gebruik de Hydra boor altijd in combinatie met een nauwkeurige gereedschapopname

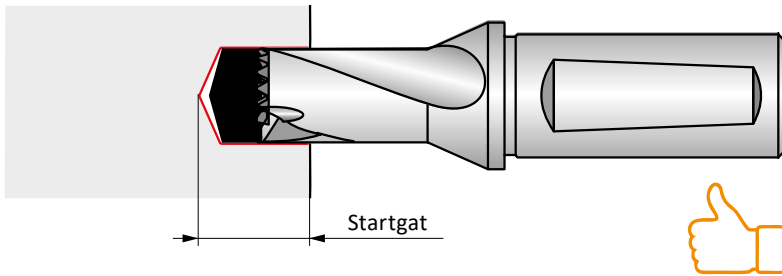

Boor een startgat (1,5xD tot 3xD diepte) met een korte Hydra boor en dezelfde HYDRA wisselkop (controleer indien nodig de rondloop van de boor, max +/- 0,05mm).

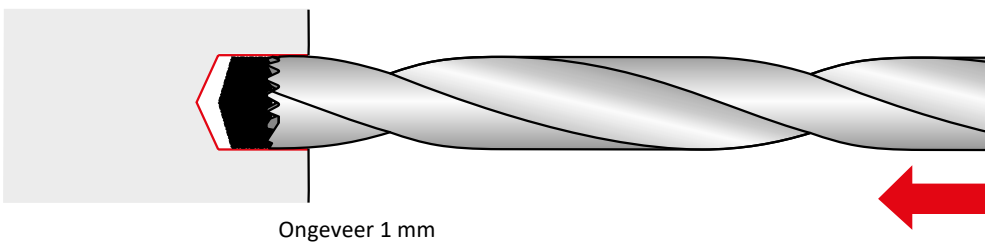

Voer de 8xD of 12xD Hydra boor met een max. toerental van 500 omw/min in het startgat met normale voeding, tot ongeveer 1 mm van de bodem van het ervan.

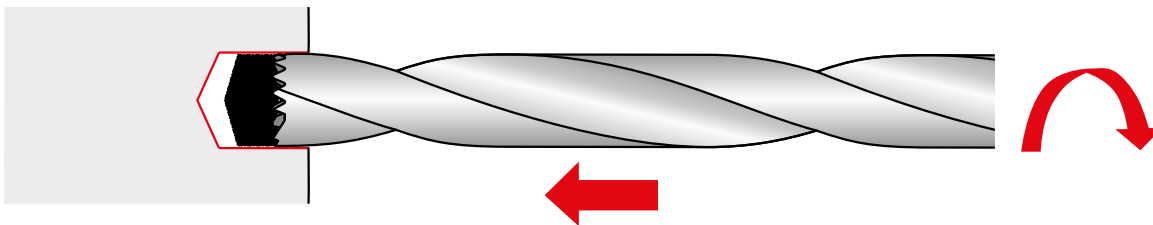

Start de koelvloeistofstroom en verhoog het toerental tot het aanbevolen toerental.
Opmerking: Pas een korte pauze toe, start de voeding niet voordat het aanbevolen toerental is bereikt.

Boor zonder lossen tot de vereiste diepte.

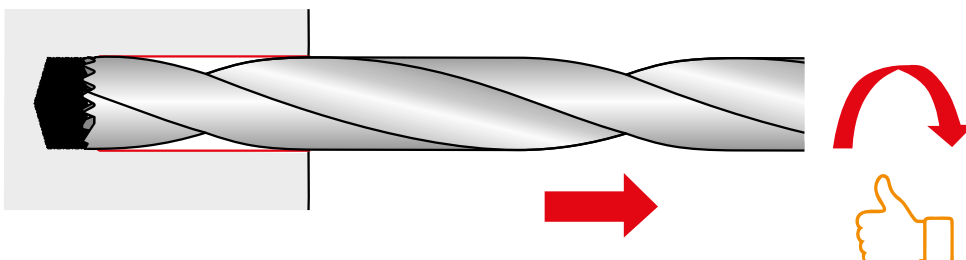

Wanneer de gewenste diepte is bereikt, trekt u de boor met ongeveer 0,1 mm tot 0,5 mm terug en verlaagt u het toerental tot 500 omw/min, gevolgd door een volledige terugtrekking met normale voeding.

Opmerking: Terugtrekken van de boor met een hoger toerental kan leiden beschadiging van de gatwand en van de wisselkop of het en heeft maatafwijkingen als gevolg.

Aanbevelingen voor het werken met de HYDRA boor.

Koelmiddelen

Voor maximale spaanafvoer en prestaties van het gereedschap is het gebruik van koelvloeistof aanbevolen. Een emulsieconcentraat van 6 - 8% wordt aanbevolen voor de meeste toepassingen, bij een koelmiddeldruk van minimaal 20 bar (290 PSI). Voor staalsoorten met hoge treksterkte, roestvast staal en zwaardere boortoepassingen, gebruik een hogere concentratie van 10-12%. Bij deze toepassingen, vooral in roestvast staal, wordt aanbevolen om de maximale koelmiddeldruk op de machine te gebruiken. De Hydra koelkanalen zorgen voor een verbeterde stabiliteit van de boor en ze verminderen de hitte bij de snijkanten voor een hogere productiviteit en langere standtijd van het gereedschap.

Houders

Gebruik altijd gereedschapshouders en spantangen die een goede

rondloopnauwkeurigheid garanderen. Gebruik een axiale aanslag om te voorkomen dat de boor in de houder gedrukt wordt. Slingering van het gereedschap moet nauwkeurig worden gecontroleerd en gehandhaafd worden.

Werkstuk

Een stabiel werkstuk beperkt de doorbuiging tot een minimum en maakt een hogere nauwkeurigheid en een zuivere positionering van het gat mogelijk.

Voeding

Het is belangrijk dat de boor niet te weinig voeding krijgt, waardoor hij gaat wrijven en bot wordt. Dit is vooral het geval bij werkhardende materialen. De voeding moet hoog genoeg zijn voor een goede spaanvorming.

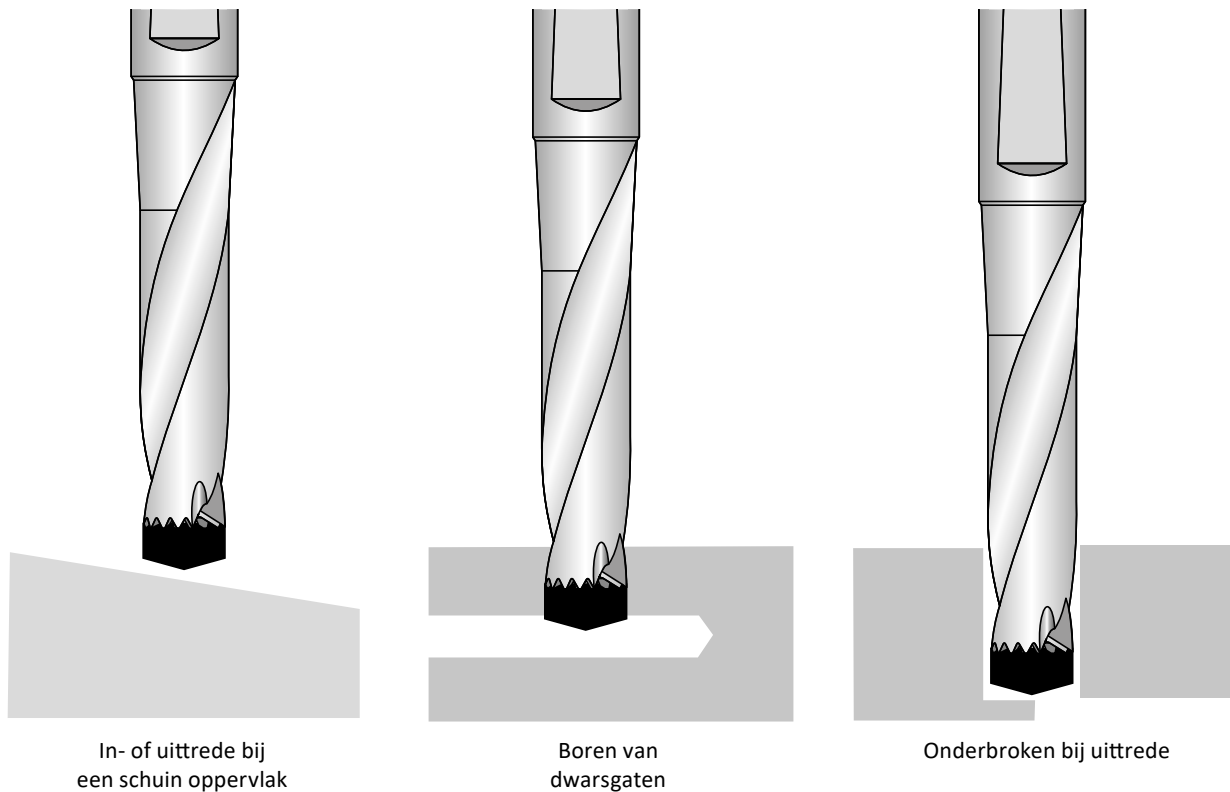

In deze boorscenario's wordt over het algemeen aanbevolen de voedingssnelheid te verlagen tot 1/3 (33%). Boren in hellend vlak van meer dan 10° wordt NIET aanbevolen - het oppervlak moet eerst vlak gefreesd worden.



ALGEMEEN - TECHNISCHE INFORMATIE

	Soort	Hardheid (HV10)	C %	W %	Mo %	Cr %	V %	Co %	Basismateriaal
HSS	M2	810 – 850	0.9	6.4	5.0	4.2	1.8	–	HSS

Kenmerken	HSS materialen	Hardmetaal	K10/30F (veel toegepast voor VHM gereedschap)
Hardheid (HV30)	800 – 950	1300 – 1800	1600
Dichtheid (g/cm ³)	8.0 – 9.0	7.2 – 15	14.45
Drukvastheid (N/mm ²)	3000 – 4000	3000 – 8000	6250
Buigvastheid (N/mm ²)	2500 – 4000	1000 – 4700	4300
Hittebestendigheid (°C)	550	1000	900
E-module (KN/mm ²)	260 – 300	460 – 630	580
Korrelgrootte (µm)	–	0.2 – 10	0.8

De verhouding van harde delen (WC) en het bindmetaal (Co) geeft de volgende veranderingen in de eigenschappen.

Karakteristiek	Hoger WC gehalte geeft	Hoger Co gehalte geeft
Hardheid	Hogere hardheid	Minder hardheid
Drukvastheid (CS)	Hoger CS	Lager CS
Buigvastheid (BS)	Lager BS	Hoger BS

Ook de korrelgrootte beïnvloedt de materiaaleigenschappen. Kleine korrelgroottes betekenen een hogere hardheid en grove korrels geven meer taaierheid.



ALGEMEEN - TECHNISCHE INFORMATIE

Industrienormen voor de passing van schachten en gaten

Tolerantiewaarden worden getoond in microns (μm)

Formule voor microns ...1 $\mu\text{m} = 0.001 \text{ mm} / 0.000039''$

Tolerantie	Diameter (mm)							
	> 1 ≤ 3	> 3 ≤ 6	> 6 ≤ 10	> 10 ≤ 18	> 18 ≤ 30	> 30 ≤ 50	> 50 ≤ 80	> 80 ≤ 120
	Diameter (inch)							
	> 0.039" ≤ 0.118"	> 0.118" ≤ 0.236"	> 0.236" ≤ 0.394"	> 0.394" ≤ 0.709"	> 0.709" ≤ 1.181"	> 1.181" ≤ 1.968"	> 1.968" ≤ 3.149"	> 3.149" ≤ 4.724"
	Tolerantiewaarden (μm)							
e8	-14 / -28	-20 / -38	-25 / -47	-32 / -59	-40 / -73	-50 / -89	-60 / -106	-72 / -126
f6	-6 / -12	-10 / -18	-13 / -22	-16 / -27	-20 / -33	-25 / -41	-30 / -49	-36 / -58
f7	-6 / -16	-10 / -22	-13 / -28	-16 / -34	-20 / -41	-25 / -50	-30 / -60	-36 / -71
h6	0 / -6	0 / -8	0 / -9	0 / -11	0 / -13	0 / -16	0 / -19	0 / -22
h7	0 / -10	0 / -12	0 / -15	0 / -18	0 / -21	0 / -25	0 / -30	0 / -35
h8	0 / -14	0 / -18	0 / -22	0 / -27	0 / -33	0 / -39	0 / -46	0 / -54
h9	0 / -25	0 / -30	0 / -36	0 / -43	0 / -52	0 / -62	0 / -74	0 / -87
h10	0 / -40	0 / -48	0 / -58	0 / -70	0 / -84	0 / -100	0 / -120	0 / -140
h11	0 / -60	0 / -75	0 / -90	0 / -110	0 / -130	0 / -160	0 / -190	0 / -220
h12	0 / -100	0 / -120	0 / -150	0 / -180	0 / -210	0 / -250	0 / -300	0 / -350
k10	+ 40 / 0	+ 48 / 0	+ 58 / 0	+ 70 / 0	+ 84 / 0	+ 100 / 0	+ 120 / 0	+ 140 / 0
k12	+ 100 / 0	+ 120 / 0	+ 150 / 0	+ 180 / 0	+ 210 / 0	+ 250 / 0	+ 300 / 0	+ 350 / 0
m7	+ 2 / + 12	+ 4 / + 16	+ 6 / + 21	+ 7 / + 25	+ 8 / + 29	+ 9 / + 34	+ 11 / + 41	+ 13 / + 48
js14	+ / -125	+ / -150	+ / -180	+ / -215	+ / -260	+ / -310	+ / -370	+ / -435
js16	+ / -300	+ / -375	+ / -450	+ / -550	+ / -650	+ / -800	+ / -950	+ / -1100
H7	+ 10 / 0	+ 12 / 0	+ 15 / 0	+ 18 / 0	+ 21 / 0	+ 25 / 0	+ 30 / 0	+ 35 / 0
H8	+ 14 / 0	+ 18 / 0	+ 22 / 0	+ 27 / 0	+ 33 / 0	+ 39 / 0	+ 46 / 0	+ 54 / 0
H9	+ 25 / 0	+ 30 / 0	+ 36 / 0	+ 43 / 0	+ 52 / 0	+ 62 / 0	+ 74 / 0	+ 87 / 0
H12	+ 100 / 0	+ 120 / 0	+ 150 / 0	+ 180 / 0	+ 210 / 0	+ 250 / 0	+ 300 / 0	+ 350 / 0
P9	-6 / -31	-12 / -42	-15 / -51	-18 / -61	-22 / -74	-26 / -86	-32 / -106	-37 / -124
S7	-13 / -22	-15 / -27	-17 / -32	-21 / -39	-27 / -48	-34 / -59	-42 / -72	-58 / -93



ALGEMEEN - TECHNISCHE INFORMATIE

Snijsnelheidstabel

		Vc															
m/min.		5	8	10	15	20	25	30	40	50	60	70	80	90	100	110	150
SFM (feet/min.)		16	26	32	50	66	82	98	130	165	197	230	262	296	330	362	495
Ø		Toerental															
mm	inch																
1.00	–	1592	2546	3183	4775	6366	7958	9549	12732	15916	19099	22282	25465	28648	31831	35014	47747
1.50	–	1061	1698	2122	3183	4244	5305	6366	8488	10610	12732	14854	16977	19099	21221	23343	31831
2.00	–	796	1273	1592	2387	3183	3979	4775	6366	7958	9549	11141	12732	14324	15916	17507	23873
2.50	–	637	1019	1273	1910	2546	3183	3820	5093	6366	7639	8913	10186	11459	12732	14006	19099
3.00	–	531	849	1061	1592	2122	2653	3183	4244	5305	6366	7427	8488	9549	10610	11671	15916
3.18	1/8	500	801	1001	1501	2002	2502	3003	4004	5005	6006	7007	8008	9009	10010	11011	15015
3.50	–	455	728	909	1364	1819	2274	2728	3638	4547	5457	6366	7276	8185	9095	10004	13642
4.00	–	398	637	796	1194	1592	1989	2387	3183	3979	4775	5570	6366	7162	7958	8754	11937
4.50	–	354	566	707	1061	1415	1768	2122	2829	3537	4244	4951	5659	6366	7074	7781	10610
4.76	3/16	334	535	669	1003	1337	1672	2006	2675	3344	4012	4681	5350	6018	6687	7356	10031
5.00	–	318	509	637	955	1273	1592	1910	2546	3183	3820	4456	5093	5730	6366	7003	9549
6.00	–	265	424	531	796	1061	1326	1592	2122	2653	3183	3714	4244	4775	5305	5836	7958
6.35	1/4	251	401	501	752	1003	1253	1504	2005	2506	3008	3509	4010	4511	5013	5514	7519
7.00	–	227	364	455	682	909	1137	1364	1819	2274	2728	3183	3638	4093	4547	5002	6821
7.94	5/16	200	321	401	601	802	1002	1203	1604	2004	2405	2806	3207	3608	4009	4410	6013
8.00	–	199	318	398	597	796	995	1194	1592	1989	2387	2785	3183	3581	3979	4377	5968
9.00	–	177	283	354	531	707	884	1061	1415	1768	2122	2476	2829	3183	3537	3890	5305
9.53	3/8	167	267	334	501	668	835	1002	1336	1670	2004	2338	2672	3006	3340	3674	5010
10.00		159	255	318	477	637	796	955	1273	1592	1910	2228	2546	2865	3183	3501	4775
11.11	7/16	143	229	287	430	573	716	860	1146	1433	1719	2006	2292	2579	2865	3152	4298
12.00		133	212	265	398	531	663	796	1061	1326	1592	1857	2122	2387	2653	2918	3979
12.70	1/2	125	201	251	376	501	627	752	1003	1253	1504	1754	2005	2256	2506	2757	3760
14.00		114	182	227	341	455	568	682	909	1137	1364	1592	1819	2046	2274	2501	3410
14.29	9/16	111	178	223	334	446	557	668	891	1114	1337	1559	1782	2005	2228	2450	3341
15.00	–	106	170	212	318	424	531	637	849	1061	1273	1485	1698	1910	2122	2334	3183
15.88	5/8	100	160	200	301	401	501	601	802	1002	1203	1403	1604	1804	2004	2205	3007
16.00	–	99	159	199	298	398	497	597	796	995	1194	1393	1592	1790	1989	2188	2984
17.46	11/16	91	146	182	273	365	456	547	729	912	1094	1276	1458	1641	1823	2005	2735
18.00	–	88	141	177	265	354	442	531	707	884	1061	1238	1415	1592	1768	1945	2653
19.05	3/4	84	134	167	251	334	418	501	668	835	1003	1170	1337	1504	1671	1838	2506
20.00	–	80	127	159	239	318	398	477	637	796	955	1114	1273	1432	1592	1751	2387
24.00	–	66	106	133	199	265	332	398	531	663	796	928	1061	1194	1326	1459	1989
25.00	–	64	102	127	191	255	318	382	509	637	764	891	1019	1146	1273	1401	1910
27.00	–	59	94	118	177	236	295	354	472	589	707	825	943	1061	1179	1297	1768
30.00	–	53	85	106	159	212	265	318	424	531	637	743	849	955	1061	1167	1592
32.00	–	50	80	99	149	199	249	298	398	497	597	696	796	895	995	1094	1492
36.00	–	44	71	88	133	177	221	265	354	442	531	619	707	796	884	973	1326
40.00	–	40	64	80	119	159	199	239	318	398	477	557	637	716	796	875	1194
50.00	–	32	51	64	95	127	159	191	255	318	382	446	509	573	637	700	955



ALGEMEEN - TECHNISCHE INFORMATIE

Hardheid en Treksterkte

HV	HRC	HB	Treksterkte	
			(N/mm ²)	(Tons/sq. in.)
940	68	–	–	–
900	67	–	–	–
864	66	–	–	–
829	65	–	–	–
800	64	–	–	–
773	63	–	–	–
745	62	–	–	–
720	61	–	–	–
698	60	–	–	–
675	59	–	–	–
655	58	–	2200	142
650	–	618	2180	141
640	–	608	2145	139
639	57	607	2140	138
630	–	599	2105	136
620	–	589	2070	134
615	56	584	2050	133
610	–	580	2030	131
600	–	570	1995	129
596	55	567	1980	128
590	–	561	1955	126
580	–	551	1920	124
578	54	549	1910	124
570	–	542	1880	122
560	53	532	1845	119
550	–	523	1810	117
544	52	517	1790	116
540	–	513	1775	115
530	–	504	1740	113
527	51	501	1730	112
520	–	494	1700	110
514	50	488	1680	109
510	–	485	1665	108
500	–	475	1630	105
497	49	472	1620	105
490	–	466	1595	103
484	48	460	1570	102
480	–	456	1555	101
473	47	449	1530	99
470	–	447	1520	98
460	–	437	1485	96
458	46	435	1480	96
450	–	428	1455	94
446	45	424	1440	93
440	–	418	1420	92

HV	HRC	HB	Treksterkte	
			(N/mm ²)	(Tons/sq. in.)
434	44	413	1400	91
423	43	402	1360	88
413	42	393	1330	86
403	41	383	1300	84
392	40	372	1260	82
382	39	363	1230	80
373	38	354	1200	78
364	37	346	1170	76
355	36	337	1140	74
350	–	333	1125	73
345	35	328	1110	72
340	–	323	1095	71
336	34	319	1080	70
330	–	314	1060	69
327	33	311	1050	68
320	–	304	1030	67
317	32	301	1020	66
310	31	295	995	64
302	30	287	970	63
300	–	285	965	62
295	–	280	950	61
293	29	278	940	61
290	–	276	930	60
287	28	273	920	60
285	–	271	915	59
280	27	266	900	58
275	–	261	880	57
272	26	258	870	56
270	–	257	865	56
268	25	255	860	56
265	–	252	850	55
260	24	247	835	54
255	23	242	820	53
250	22	238	800	52
245	–	233	785	51
243	21	231	780	50
240	–	228	770	50
235	–	223	755	49
230	–	219	740	48
225	–	214	720	47
220	–	209	705	46
215	–	204	690	45
210	–	199	675	44
205	–	195	660	43
200	–	190	640	41



DORMER PRAMET



SNEL ZOEKEN

Snel en eenvoudig een tekstzoekopdracht uitvoeren in alle recente publicaties van Dormer Pramet via onze bibliotheek-app. Download deze nu in uw app store. **Simply Reliable.**

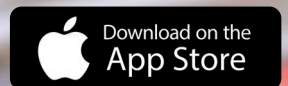





WISSELPLAAT BOREN



OVERZICHT VAN WISSELPLAATBOREN

Werkende boorlengte	2×D	3×D	4×D	5×D	XPET..AP	SCET..-UD	XPET..AP-SD	SCET..-SD
Afbeelding								
Koelkanalen					-	-	-	-
	313	315	318	320	324	323	324	323
Type boor	802D	803D	804D	805D	-	-	-	-
Tolerantie van de boor	± 0.05	± 0.05	± 0.05	± 0.05	-	-	-	-
Gat tolerantie *	0/+0.2	0/+0.3	0/+0.4	0/+0.5	-	-	-	-
Oppervlaktekwaliteit *	R _a 2–6 μm	R _a 2–6 μm	R _a 2–6 μm	R _a 2–6 μm	-	-	-	-
Diameter range	15.0–40.0	15.0–58.0	17.0–58.0	19.0–31.0	-	-	-	-
Inzetgebied	P1				■	■	■	■
	P2				■	■	■	■
	P3				■	■	■	■
	P4				■	■	■	■
	M1						■	■
	M2						■	■
	M3						■	■
	M4						■	■
	K1				▣	■	▣	▣
	K2				▣	■	▣	▣
	K3				▣	■	▣	▣
	K4				▣	■	▣	▣
	K5				▣	■	▣	▣
S1						▣	▣	
S2						▣	▣	
S3						▣	▣	
S4						▣	▣	

* De tolerantie van het geboorde gat en de oppervlaktekwaliteit zijn sterk afhankelijk van de bewerkingsomstandigheden.



WISSELPLAATBOREN - NAVIGATOR BASISMATERIAAL

Hardmetaal­soort	Inzet­gebied	Geschiktheid	Voeding	Snij­snel­heid	Geschiktheid voor moeilijke om­stan­digheden	Coating	Kleur	Sub­straat	Koeling	Beschrijving hardmetaal­soort
D9335	P20 - P35	■				MT-CVD		FGM	+++	Deze hardmetaal­soort is aanbevolen voor de omtreksnij­dende wissel­plaat en meer bestand tegen hoge snij­snel­heden en voedingen.
	M15 - M30	■								
	K15 - K35	■								
	S10 - S20	■								
D8330	P20 - P35	■				PVD		submicron H	+++	Deze hardmetaal­soort is universeel en voor de omtreksnij­dende wissel­plaat, geschikt voor de meeste materialen en blinkt uit door de hoge betrouw­baar­heid.
	M15 - M30	■								
	K15 - K35	■								
	S10 - S20	■								
D8345	P30 - P50	■				PVD		submicron H	+++	Deze hardmetaal­soort is universeel en voor de centrumsnij­dende wissel­plaat, het is een extreem taai en geschikt voor de meeste materialen.
	M20 - M40	■								
	K30 - K40	■								
	S20 - S30	■								

Sub­straat

submicron H	Op WC-Co gebaseerd fijnkorrelig sub­straat
FGM	Sub­straat waarin de eigenschappen van de elementen elkaar versterken

Coating

MT-CVD	Chemische coatingsmethode bij middel hoge temperatuur.
PVD	Fysische coatingsmethode bij lage temperatuur.

Voordeel van koeling

+++	Gebruik van koelvloeistof is noodzakelijk
-----	---

WISSELPLATEN – ISO CODERING

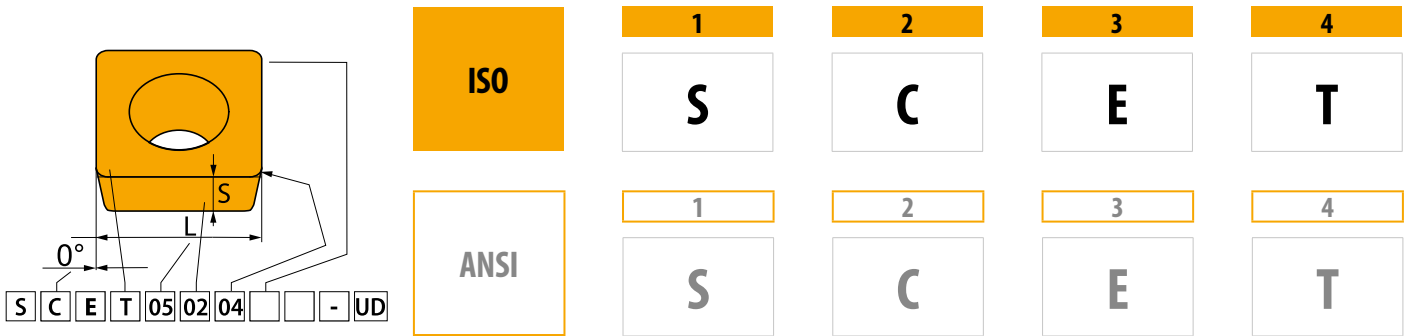

1				2				4			
Wisselplaatvorm				Vrijloophoek wisselplaat				Type wisselplaat			
H	O	P	R	A	B	N		N			
S	T	C	D								
E	M	V	W								
					Speciaal						
L	A	B	K								

3 3

Toleranties

	(mm)			(")		
	M(±)	S(±)	IC(±)	M(±)	S(±)	IC(±)
A	0.005	0.025	0.025	.0002"	.001"	.0010"
F	0.005	0.025	0.013	.0002"	.001"	.0005"
C	0.013	0.025	0.025	.0005"	.001"	.0010"
H	0.013	0.025	0.013	.0005"	.001"	.0005"
E	0.025	0.025	0.025	.0010"	.001"	.0010"
G	0.025	0.130	0.025	.0010"	.005"	.0010"
J	0.005	0.025	0.05 – 0.13	.0002"	.001"	.002 – 0.005"
K	0.013	0.025	0.05 – 0.13	.0005"	.001"	.002 – 0.005"
L	0.025	0.025	0.05 – 0.13	.0010"	.001"	.002 – 0.005"
M	0.08 – 0.18	0.130	0.05 – 0.13	.003 – 0.007"	.005"	.002 – 0.005"
N	0.08 – 0.18	0.025	0.05 – 0.13	.003 – 0.007"	.001"	.002 – 0.005"
U	0.05 – 0.38	0.130	0.05 – 0.13	.005 – 0.015"	.005"	.003 – 0.010"

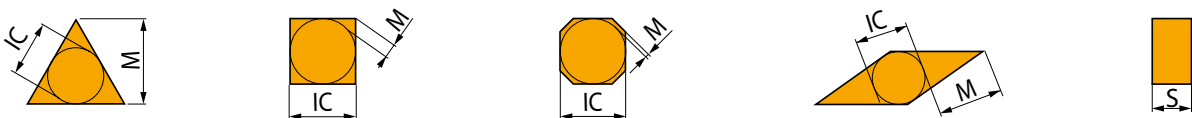

WISSELPLATEN – ISO CODERING

5	6	7	8	9	10
05	02	04			UD
5	6	7	8	9	10
1.8	1.5	1			UD

5		5												
Snijkantlengte (grootte wisselplaat)														
d=IC		H	O	P	S	T	C	D	E	M	V	W	R	K
(mm)	(in)													
3.97	5/32"				03	06		04			06	02		
4.76	3/16"				04	08	04	05	04	04	08	L3		
5.56	7/32"				05	09	05	06	05	05	09	03		
6.35	1/4"	03	02	04	08	11	06	07	08	08	11	04	06	
7.94	5/16"	04	03	05	07	13	08	09	06	07	13	05	07	
9.525	3/8"	05	04	07	09	16	09	11	09	09	16	06	09	16
12.7	1/2"	07	05	09	12	22	12	15	13	12	22	08	12	
15.875	5/8"	09	06	11	15	27	16	19	16	15	27	10	15	
19.05	3/4"	11	07	13	19	33	19	23	19	19	33	13	19	
25.40	1"	14	10	18	25	44	25	31	26	25	44	17	25	
31.75	1 1/4"	18	13	23	31	54	32	38	32	31	54	21	31	

6		7	
Wisselplaatdikte		Wisselplaat neusradius	
		RE	
		(mm)	(")
01	1.59	0	0"
T1	1.98	0.2	1/128"
02	2.38	0.4	1/64"
03	3.18	0.8	1/32"
T3	3.97	1.2	3/64"
04	4.76	1.6	1/16"
05	5.56	2.4	3/32"
06	6.35	3.2	1/8"
07	7.94	Ronde wisselplaat	
09	9.52		
		d=I.C.	
		(")	00
		(mm)	M0

ANSI		
5	6	7
Ingeschreven cirkel	Wisselplaatdikte	Wisselplaat neusradius
Symbol	Symbol	Symbol
		RE
		(mm)
		(")
1	1	0
1.2	1.2	0.2
1.5	1.5	0.5
1.8	2	1
2	2.5	2
2.5	3	3
3	3.5	4
4	4	5
5	5	6
6	6	7
7	7	8
8	8	10
10	9	12
12	10	14
		16

8		8	
Uitvoering van de snijkant			
	Scherpe snijkant		Afgeronde snijkant
	Snijkant met fase		Snijkant met afgeronde fase
	Snijkant met dubbele fase		Snijkant met dubbele afgeronde snijkant

9		9	
Voedingsrichting			
R		N	
L			
10		10	
Soort spaanbreker			



CODERING VAN BOREN

1	2	3	-	4	-	5	-	6	7
8	05	D	-	19	-	95	-	S	25

*Markering is geldend voor types geproduceerd na 2011/



Wisselplaatboren*

1		2		3		4	
Soort gereedschap		Boordiepte		Uitvoering		Boordiameter	
8	Wisselplaatboor	02	2 × DC	D	Boor	15.5	DC = 15.5 mm
		03	3 × DC			19	DC = 19 mm
		04	4 × DC				
		05	5 × DC				
5		6		7			
Max. boordiepte		Type schacht		Schachtdiameter			
35	35 mm	E	Whistle Notch	25	DCON MS = 25 mm		
95	95 mm			32	DCON MS = 32 mm		
140	140 mm	S	ISO 9766	40	DCON MS = 40 mm		



802D

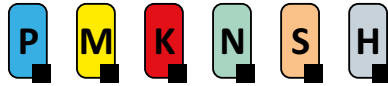

PRAMET

S



Wisselplaatboor, 2xD, koelkanalen

Hoogproductieve wisselplaatboor voor het boren van blinde en doorlopende gaten. Ook geschikt voor kruisgaten, excentrisch boren en pakket boren, circulaire interpolatie, verzinken, boren op holle of schuine oppervlakken, boren met onderbroken sneden, afkantboren en kotten.

Verkrijgbaar van Ø15 t/m Ø40 mm in 2xD.

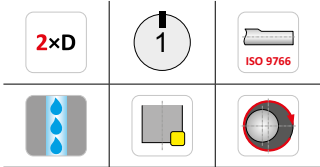
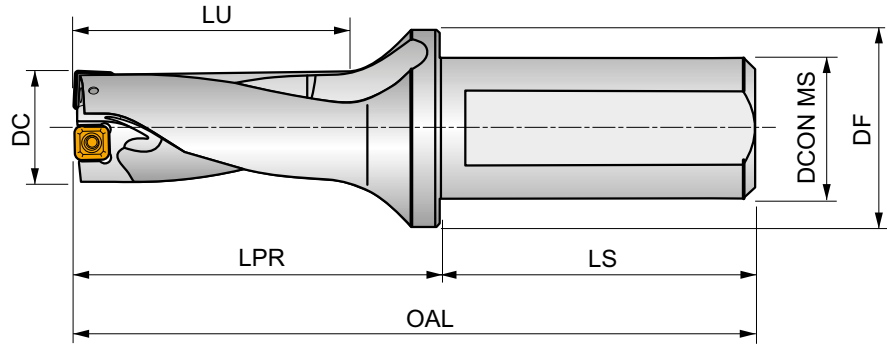

Product	DC	APMX	OAL	LPR	LS	LU	DCON MS	DF	$\overset{-}{D}$	$\overset{+}{D}$				kg	
	(mm)	(mm)	(mm)	(mm)	(mm)	(mm)	(mm)	(mm)	(mm)	(mm)					
802D-15-30-S25	15	30.00	121	65	56	34.5	25	35	0.25	0.35	EP253253	GI300	GI313	0.30	HM001
802D-16-32-S25	16	32.00	123	67	56	37	25	35	0.15	0.45	EP253253	GI300	GI313	0.30	HM001
802D-17-34-S25	17	34.00	125	69	56	39.5	25	35	0.10	0.50	EP253253	GI300	GI313	0.31	HM001
802D-18-36-S25	18	36.00	127	71	56	42	25	35	0.35	0.25	EP253253	GI301	GI314	0.31	HM002
802D-19-38-S25	19	38.00	129	73	56	44.5	25	35	0.15	0.45	EP253253	GI301	GI314	0.32	HM002
802D-20-40-S25	20	40.00	131	75	56	47	25	35	0.10	0.45	EP253253	GI302	GI315	0.33	HM003
802D-21-42-S25	21	42.00	133	77	56	49.5	25	35	0.10	0.50	EP253253	GI302	GI315	0.34	HM003
802D-22-44-S25	22	44.00	135	79	56	52	25	35	0.45	0.50	EP253253	GI303	GI316	0.35	HM004
802D-23-46-S25	23	46.00	137	81	56	54.5	25	35	0.35	0.50	EP253253	GI304	GI317	0.36	HM005
802D-24-48-S25	24	48.00	139	83	56	57	25	35	0.15	0.50	EP253253	GI304	GI317	0.37	HM005
802D-25-50-S32	25	50.00	145	85	60	57	32	42	0.15	0.50	EP324058	GI304	GI317	0.57	HM005
802D-26-52-S32	26	52.00	147	87	60	59.5	32	42	0.10	0.50	EP324058	GI304	GI317	0.58	HM005
802D-27-54-S32	27	54.00	149	89	60	62	32	42	0.50	0.30	EP324058	GI305	GI318	0.59	HM006
802D-28-56-S32	28	56.00	151	91	60	64.5	32	42	0.30	0.50	EP324058	GI306	GI319	0.61	HM007
802D-29-58-S32	29	58.00	153	93	60	67	32	42	0.20	0.50	EP324058	GI306	GI319	0.62	HM007
802D-30-60-S32	30	60.00	155	95	60	69.5	32	42	0.15	0.50	EP324058	GI306	GI319	0.67	HM007
802D-32-64-S32	32	64.00	159	99	60	70	32	42	0.50	0.35	EP324058	GI307	GI320	0.68	HM008
802D-32-64-S40	32	64.00	167	99	68	70	40	50	0.50	0.35	-	GI307	GI320	1.03	HM008
802D-34-68-S32	34	68.00	163	103	60	75	32	42	0.25	0.50	EP324058	GI307	GI320	0.73	HM008
802D-34-68-S40	34	68.00	171	103	68	75	40	50	0.25	0.50	-	GI307	GI320	1.07	HM008
802D-36-72-S32	36	72.00	167	107	60	80	32	42	0.10	0.50	EP324058	GI308	GI321	0.76	HM009
802D-36-72-S40	36	72.00	173	105	68	77.5	40	50	0.10	0.50	-	GI308	GI321	1.11	HM009
802D-38-76-S32	38	76.00	171	111	60	85	32	42	0.50	0.50	EP324058	GI308	GI321	0.83	HM009
802D-38-76-S40	38	76.00	179	111	68	85	40	50	0.50	0.50	-	GI308	GI321	1.17	HM009
802D-40-80-S32	40	80.00	175	115	60	90	32	42	0.20	0.50	EP324058	GI309	GI322	0.91	HM009
802D-40-80-S40	40	80.00	183	115	68	90	40	50	0.20	0.50	-	GI309	GI322	1.25	HM009



GI300	XPET 0502AP	SCET 050204-UD
GI301	XPET 0602AP	SCET 050204-UD
GI302	XPET 0602AP	SCET 060204-UD
GI303	XPET 0703AP	SCET 060204-UD
GI304	XPET 0703AP	SCET 070308-UD
GI305	XPET 0903AP	SCET 070308-UD
GI306	XPET 0903AP	SCET 09T308-UD
GI307	XPET 11T3AP	SCET 09T308-UD
GI308	XPET 11T3AP	SCET 120408-UD
GI309	XPET 12T3AP	SCET 120408-UD
GI313	XPET 0502AP-SD	SCET 050204-SD
GI314	XPET 0602AP-SD	SCET 050204-SD
GI315	XPET 0602AP-SD	SCET 060204-SD
GI316	XPET 0703AP-SD	SCET 060204-SD
GI317	XPET 0703AP-SD	SCET 070308-SD
GI318	XPET 0903AP-SD	SCET 070308-SD
GI319	XPET 0903AP-SD	SCET 09T308-SD
GI320	XPET 11T3AP-SD	SCET 09T308-SD
GI321	XPET 11T3AP-SD	SCET 120408-SD
GI322	XPET 12T3AP-SD	SCET 120408-SD

HM001	US 2245-T07P	0.9	US 2245-T07P	0.9	FLAG T07P
HM002	US 2205-T07P	0.9	US 2245-T07P	0.9	FLAG T07P
HM003	US 2205-T07P	0.9	US 2205-T07P	0.9	FLAG T07P
HM004	US 2506-T07P	1.2	US 2506-T07P	1.2	FLAG T07P
HM005	US 2507-T08P	1.2	US 3007-T08P	2.0	FLAG T08P
HM006	US 3007-T09P	2.0	US 3007-T09P	2.0	FLAG T09P
HM007	US 3007-T09P	2.0	US 3009-T09P	2.0	FLAG T09P
HM008	US 3510-T15P	3.0	US 3508-T15P	3.0	FLAG T15P
HM009	US 3510-T15P	3.0	US 5012-T15P	5.0	FLAG T15P



803D

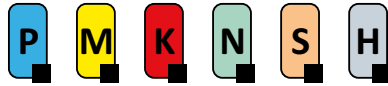

PRAMET



Wisselplaatboor, 3xD, koelkanalen

Hoogproductieve wisselplaatboor voor het boren van blinde en doorlopende gaten. Ook geschikt voor kruisgaten, excentrisch boren en pakket boren, circulaire interpolatie, verzinken, boren op holle of schuine oppervlakken, boren met onderbroken sneden, afkantboren en kotten.

Verkrijgbaar van Ø15 t/m Ø58 mm in 3xD.

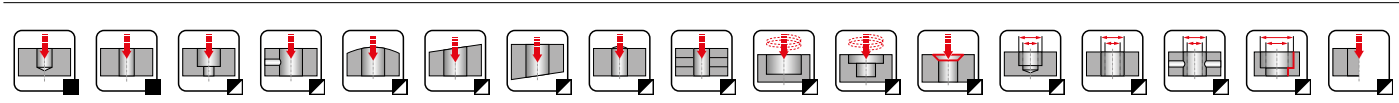
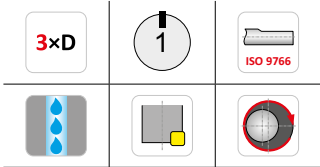
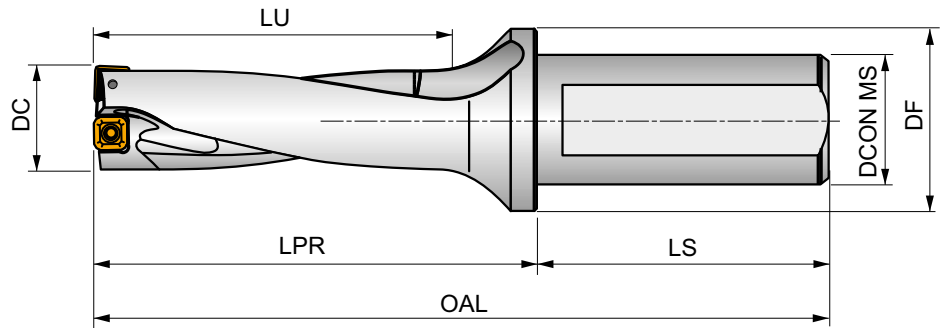

Product	DC	APMX	OAL	LPR	LS	LU	DCON MS	DF	\bar{D}	\bar{D}^+				kg	
	(mm)	(mm)	(mm)	(mm)	(mm)	(mm)	(mm)	(mm)	(mm)	(mm)					
803D-15-45-S25	15	45.00	136	80	56	49.5	25	35	0.25	0.35	EP253253	GI300	GI313	0.31	HM001
803D-15,5-46,5-S25	15.5	47.00	137.5	81.5	56	51.2	25	35	0.30	0.35	EP253253	GI300	GI313	0.31	HM001
803D-16-48-S25	16	48.00	139	83	56	53	25	35	0.15	0.45	EP253253	GI300	GI313	0.32	HM001
803D-16,5-49,5-S25	16.5	50.00	140.5	84.5	56	54.7	25	35	0.15	0.40	EP253253	GI300	GI313	0.32	HM001
803D-17-51-S25	17	51.00	142	86	56	56.5	25	35	0.10	0.50	EP253253	GI300	GI313	0.32	HM001
803D-17,5-52,5-S25	17.5	53.00	143.5	87.5	56	58.2	25	35	0.50	0.50	EP253253	GI301	GI314	0.32	HM002
803D-18-54-S25	18	54.00	145	89	56	60	25	35	0.35	0.25	EP253253	GI301	GI314	0.33	HM002
803D-18,5-55,5-S25	18.5	56.00	146.5	90.5	56	61.2	25	35	0.35	0.25	EP253253	GI301	GI314	0.34	HM002
803D-19-57-S25	19	57.00	148	92	56	63.5	25	35	0.15	0.45	EP253253	GI301	GI314	0.34	HM002
803D-19,5-58,5-S25	19.5	59.00	149.5	93.5	56	63.7	25	35	0.25	0.40	EP253253	GI302	GI315	0.34	HM003
803D-20-60-S25	20	60.00	151	95	56	67	25	35	0.10	0.45	EP253253	GI302	GI315	0.35	HM003
803D-20,5-61,5-S25	20.5	62.00	152.5	96.5	56	67.2	25	35	0.10	0.50	EP253253	GI302	GI315	0.36	HM003
803D-21-63-S25	21	63.00	154	98	56	70.5	25	35	0.10	0.50	EP253253	GI302	GI315	0.36	HM003
803D-21,5-64,5-S25	21.5	65.00	155.5	99.5	56	70.8	25	35	0.35	0.50	EP253253	GI303	GI316	0.37	HM004
803D-22-66-S25	22	66.00	157	101	56	74	25	35	0.45	0.50	EP253253	GI303	GI316	0.38	HM004
803D-22,5-67,5-S25	22.5	68.00	158.5	102.5	56	74.3	25	35	0.35	0.50	EP253253	GI304	GI317	0.39	HM005
803D-23-69-S25	23	69.00	160	104	56	77.5	25	35	0.35	0.50	EP253253	GI304	GI317	0.40	HM005
803D-23,5-70,5-S25	23.5	71.00	161.5	105.5	56	77.6	25	35	0.10	0.50	EP253253	GI304	GI317	0.40	HM005
803D-24-72-S25	24	72.00	163	107	56	81	25	35	0.15	0.50	EP253253	GI304	GI317	0.41	HM005
803D-24,5-73,5-S25	24.5	74.00	168.5	108.5	60	78.7	25	35	0.10	0.50	EP253253	GI304	GI317	0.42	HM005
803D-25-75-S32	25	75.00	170	110	60	82	32	42	0.15	0.50	EP324058	GI304	GI317	0.62	HM005
803D-25,5-76,5-S32	25.5	77.00	171.5	111.5	60	82.2	32	42	0.50	0.10	EP324058	GI304	GI317	0.63	HM005
803D-26-78-S32	26	78.00	173	113	60	85.5	32	42	0.10	0.50	EP324058	GI304	GI317	0.64	HM005
803D-26,5-79,5-S32	26.5	80.00	174.5	114.5	60	85.7	32	42	0.50	0.10	EP324058	GI305	GI318	0.65	HM006
803D-27-81-S32	27	81.00	176	116	60	89	32	42	0.50	0.30	EP324058	GI305	GI318	0.65	HM006
803D-28-84-S32	28	84.00	179	119	60	92.5	32	42	0.30	0.50	EP324058	GI306	GI319	0.68	HM007
803D-29-87-S32	29	87.00	182	122	60	96	32	42	0.20	0.50	EP324058	GI306	GI319	0.70	HM007



Product	DC	APMX	OAL	LPR	LS	LU	DCONIMS	DF	\bar{D}	D^+					
	(mm)	(mm)	(mm)	(mm)	(mm)	(mm)	(mm)	(mm)	(mm)	(mm)					
803D-30-90-S32	30	90.00	185	125	60	99.5	32	42	0.15	0.50	EP324058	GI306	GI319	0.73	HM007
803D-31-93-S32	31	93.00	188	128	60	103	32	42	0.15	0.50	EP324058	GI306	GI319	0.76	HM007
803D-32-96-S32	32	96.00	191	131	60	102	32	42	0.50	0.30	EP324058	GI307	GI320	0.79	HM008
803D-32-96-S40	32	96.00	199	131	68	102	40	50	0.50	0.30	–	GI307	GI320	1.14	HM008
803D-33-99-S32	33	99.00	194	134	60	105.5	32	42	0.50	0.50	EP324058	GI307	GI320	0.83	HM008
803D-33-99-S40	33	99.00	202	134	68	105.5	40	50	0.50	0.50	–	GI307	GI320	1.18	HM008
803D-34-102-S32	34	102.00	197	137	60	109	32	42	0.25	0.50	EP324058	GI307	GI320	0.86	HM008
803D-34-102-S40	34	102.00	205	137	68	109	40	50	0.25	0.50	–	GI307	GI320	1.12	HM008
803D-35-105-S32	35	105.00	200	140	60	112.5	32	42	0.25	0.50	EP324058	GI308	GI321	0.90	HM009
803D-35-105-S40	35	105.00	208	140	68	112.5	40	50	0.25	0.50	–	GI308	GI321	1.24	HM009
803D-36-108-S32	36	108.00	203	143	60	116	32	42	0.10	0.50	EP324058	GI308	GI321	0.91	HM009
803D-36-108-S40	36	108.00	211	143	68	116	40	50	0.10	0.50	–	GI308	GI321	1.25	HM009
803D-37-111-S32	37	111.00	206	146	60	119.5	32	42	0.10	0.50	EP324058	GI308	GI321	0.95	HM009
803D-37-111-S40	37	111.00	214	146	68	119.5	40	50	0.10	0.50	–	GI308	GI321	1.29	HM009
803D-38-114-S32	38	114.00	199	139	60	124.5	32	42	0.50	0.50	EP324058	GI308	GI321	1.00	HM009
803D-38-114-S40	38	114.00	217	149	68	123	40	50	0.50	0.50	–	GI308	GI321	1.34	HM009
803D-39-117-S32	38	114.00	209	149	60	123	32	42	0.40	0.50	EP324058	GI309	GI322	1.06	HM009
803D-39-117-S40	39	117.00	220	152	68	126.5	40	50	0.40	0.50	–	GI309	GI322	1.40	HM009
803D-40-120-S32	40	120.00	215	155	60	130	32	42	0.20	0.50	EP324058	GI309	GI322	1.12	HM009
803D-40-120-S40	40	120.00	223	155	68	130	40	50	0.20	0.50	–	GI309	GI322	1.46	HM009
803D-41-123-S40	41	123.00	219	149	70	133	40	50	0.20	0.50	–	GI309	GI322	1.48	HM009
803D-42-126-S40	42	126.00	221.5	152	70	136	40	50	0.15	0.50	–	GI309	GI322	1.52	HM009
803D-43-129-S40	43	129.00	224	154	70	139	40	50	0.10	0.50	–	GI309	GI322	1.58	HM009
803D-44-132-S40	44	132.00	226.5	157	70	142	40	50	0.50	0.50	–	GI310	GI323	1.63	HM010
803D-45-135-S40	45	135.00	230.5	161	70	144	40	55	0.50	0.50	–	GI311	GI324	1.73	HM010
803D-46-138-S40	46	138.00	235	165	70	148	40	55	0.50	0.50	–	GI311	GI324	1.82	HM010
803D-47-141-S40	47	141.00	237.5	168	70	151	40	55	0.50	0.50	–	GI311	GI324	1.90	HM010
803D-48-144-S40	48	144.00	240	170	70	154	40	55	0.50	0.50	–	GI311	GI324	1.98	HM010
803D-49-147-S40	49	147.00	242.5	173	70	157	40	55	0.30	0.50	–	GI311	GI324	2.06	HM010
803D-50-150-S40	50	150.00	246.5	177	70	160	40	58	0.15	0.50	–	GI311	GI324	2.18	HM010
803D-51-153-S40	51	153.00	249	179	70	163	40	58	0.15	0.50	–	GI311	GI324	2.24	HM010
803D-52-156-S40	52	156.00	251.5	182	70	166	40	58	0.50	0.50	–	GI312	GI325	2.20	HM010
803D-53-159-S40	53	159.00	254	184	70	169	40	58	0.50	0.50	–	GI312	GI325	2.29	HM010
803D-54-162-S40	54	162.00	257.5	188	70	173	40	58	0.50	0.50	–	GI312	GI325	2.39	HM010
803D-55-165-S40	55	165.00	260	190	70	176	40	58	0.50	0.50	–	GI312	GI325	2.46	HM010
803D-56-168-S40	56	168.00	264	194	70	179	40	58	0.50	0.50	–	GI312	GI325	2.59	HM010
803D-57-171-S40	57	171.00	266.5	197	70	182	40	58	0.35	0.50	–	GI312	GI325	2.70	HM010
803D-58-174-S40	58	174.00	270	200	70	186	40	58	0.15	0.50	–	GI312	GI325	2.83	HM010

GI300	XPET 0502AP	SCET 050204-UD
GI301	XPET 0602AP	SCET 050204-UD
GI302	XPET 0602AP	SCET 060204-UD
GI303	XPET 0703AP	SCET 060204-UD
GI304	XPET 0703AP	SCET 070308-UD
GI305	XPET 0903AP	SCET 070308-UD
GI306	XPET 0903AP	SCET 09T308-UD
GI307	XPET 11T3AP	SCET 09T308-UD
GI308	XPET 11T3AP	SCET 120408-UD
GI309	XPET 12T3AP	SCET 120408-UD
GI310	XPET 1504AP	SCET 120408-UD
GI311	XPET 1504AP	SCET 150512-UD
GI312	XPET 1904AP	SCET 150512-UD
GI313	XPET 0502AP-SD	SCET 050204-SD
GI314	XPET 0602AP-SD	SCET 050204-SD
GI315	XPET 0602AP-SD	SCET 060204-SD
GI316	XPET 0703AP-SD	SCET 060204-SD
GI317	XPET 0703AP-SD	SCET 070308-SD
GI318	XPET 0903AP-SD	SCET 070308-SD
GI319	XPET 0903AP-SD	SCET 09T308-SD



GI320	XPET 11T3AP-SD	SCET 09T308-SD
GI321	XPET 11T3AP-SD	SCET 120408-SD
GI322	XPET 12T3AP-SD	SCET 120408-SD
GI323	XPET 1504AP-SD	SCET 120408-SD
GI324	XPET 1504AP-SD	SCET 150512-SD
GI325	XPET 1904AP-SD	SCET 150512-SD

HM001	US 2245-T07P	0.9	US 2245-T07P	0.9	FLAG T07P
HM002	US 2205-T07P	0.9	US 2245-T07P	0.9	FLAG T07P
HM003	US 2205-T07P	0.9	US 2205-T07P	0.9	FLAG T07P
HM004	US 2506-T07P	1.2	US 2506-T07P	1.2	FLAG T07P
HM005	US 2507-T08P	1.2	US 3007-T08P	2.0	FLAG T08P
HM006	US 3007-T09P	2.0	US 3007-T09P	2.0	FLAG T09P
HM007	US 3007-T09P	2.0	US 3009-T09P	2.0	FLAG T09P
HM008	US 3510-T15P	3.0	US 3508-T15P	3.0	FLAG T15P
HM009	US 3510-T15P	3.0	US 5012-T15P	5.0	FLAG T15P
HM010	US 4011-T15P	3.5	US 5012-T15P	5.0	FLAG T15P



804D

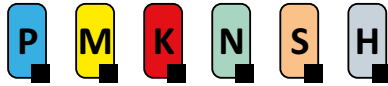

PRAMET

S



Wisselplaatboor, 4xD, koelkanalen

Hoogproductieve wisselplaatboor voor het boren van blinde en doorlopende gaten. Ook geschikt voor kruisgaten, excentrisch boren en pakket boren, circulaire interpolatie, verzinken, boren op holle of schuine oppervlakken, boren met onderbroken sneden, afkantboren en kotten. Verkrijgbaar van Ø17 t/m Ø58 mm in 4xD.

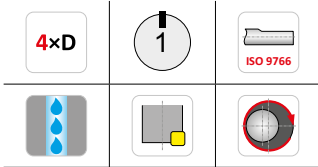
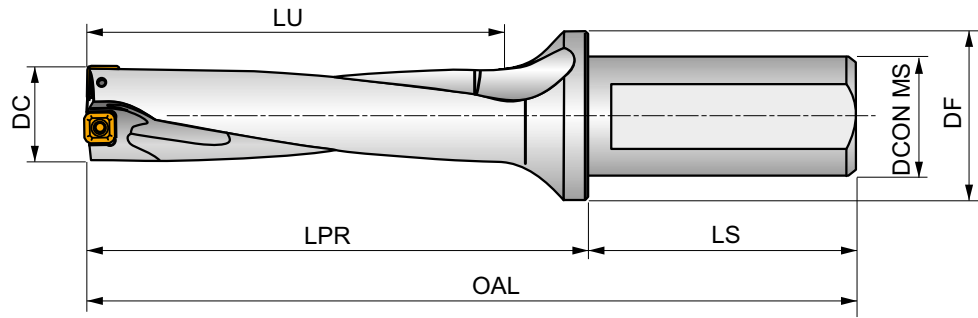

Product	DC	APMX	OAL	LPR	LS	LU	DCON MS	DF	D ⁻	D ⁺														
	(mm)	(mm)	(mm)	(mm)	(mm)	(mm)	(mm)	(mm)	(mm)	(mm)														
804D-17-68-S25	17	68.00	149	93	56	73	25	35	0.10	0.50	–	G1300	G1313	0.34	HM001									
804D-18-72-S25	18	72.00	153	97	56	77	25	35	0.35	0.25	–	G1301	G1314	0.35	HM002									
804D-19-76-S25	19	76.00	157	101	56	81.5	25	35	0.15	0.45	–	G1301	G1314	0.36	HM002									
804D-20-80-S25	20	80.00	161	105	56	85	25	35	0.10	0.45	–	G1302	G1315	0.37	HM003									
804D-21-84-S25	21	84.00	165	109	56	89.5	25	35	0.10	0.50	–	G1302	G1315	0.39	HM003									
804D-22-88-S25	22	88.00	169	113	56	94	25	35	0.45	0.50	–	G1303	G1316	0.41	HM004									
804D-23-92-S25	23	92.00	173	117	56	98.5	25	35	0.35	0.50	–	G1304	G1317	0.44	HM005									
804D-24-96-S25	24	96.00	177	121	56	103	25	35	0.15	0.50	–	G1304	G1317	0.45	HM005									
804D-25-100-S32	25	100.00	185	125	60	105	32	42	0.15	0.50	–	G1304	G1317	0.67	HM005									
804D-26-104-S32	26	104.00	189	129	60	109.5	32	42	0.10	0.50	–	G1304	G1317	0.70	HM005									
804D-27-108-S32	27	108.00	193	133	60	114	32	42	0.50	0.30	–	G1305	G1318	0.71	HM006									
804D-28-112-S32	28	112.00	197	137	60	118.5	32	42	0.30	0.50	–	G1306	G1319	0.75	HM007									
804D-29-116-S32	29	116.00	201	141	60	123	32	42	0.20	0.50	–	G1306	G1319	0.78	HM007									
804D-30-120-S32	30	120.00	205	145	60	127.5	32	42	0.15	0.50	–	G1306	G1319	0.82	HM007									
804D-31-124-S32	31	124.00	209	149	60	132	32	42	0.15	0.50	–	G1306	G1319	0.85	HM007									
804D-32-128-S32	32	128.00	213	153	60	136.5	32	42	0.50	0.30	–	G1307	G1320	0.90	HM008									
804D-33-132-S32	33	132.00	217	157	60	141	32	42	0.50	0.50	–	G1307	G1320	0.95	HM008									
804D-34-136-S32	34	136.00	221	161	60	145.5	32	42	0.25	0.50	–	G1307	G1320	0.99	HM008									
804D-35-140-S32	35	140.00	225	165	60	149	32	42	0.25	0.50	–	G1308	G1321	1.04	HM009									
804D-36-144-S32	36	144.00	229	169	60	153.5	32	42	0.10	0.50	–	G1308	G1321	1.05	HM009									
804D-37-148-S32	37	148.00	233	173	60	158	32	42	0.10	0.50	–	G1308	G1321	1.11	HM009									
804D-38-152-S32	38	152.00	237	177	60	162.5	32	42	0.50	0.50	–	G1308	G1321	1.18	HM009									
804D-39-156-S32	39	156.00	241	181	60	167	32	42	0.40	0.50	–	G1309	G1322	1.25	HM009									
804D-40-160-S32	40	160.00	245	185	60	171.5	32	42	0.20	0.50	–	G1309	G1322	1.33	HM009									
804D-41-164-S40	41	164.00	259	189	70	172	40	50	0.20	0.50	–	G1309	G1322	1.68	HM009									
804D-42-168-S40	42	168.00	263	193	70	176.5	40	50	0.15	0.50	–	G1309	G1322	1.76	HM009									
804D-43-172-S40	43	172.00	267	197	70	181	40	50	0.10	0.50	–	G1309	G1322	1.83	HM009									



Product	DC	APMX	OAL	LPR	LS	LU	DCON/MS	DF	$\overset{\uparrow}{\downarrow}D$	D^{\uparrow}					
	(mm)	(mm)	(mm)	(mm)	(mm)	(mm)	(mm)	(mm)	(mm)	(mm)				kg	
804D-44-176-S40	44	176.00	271	201	70	185.5	40	50	0.50	0.50	–	GI310	GI323	1.91	HM010
804D-45-180-S40	45	180.00	275	205	70	187.5	40	55	0.50	0.50	–	GI311	GI324	2.02	HM010
804D-46-184-S40	46	184.00	279	209	70	192	40	55	0.50	0.50	–	GI311	GI324	2.12	HM010
804D-47-188-S40	47	188.00	283	213	70	196.5	40	55	0.50	0.50	–	GI311	GI324	2.22	HM010
804D-48-192-S40	48	192.00	287	217	70	201	40	55	0.50	0.50	–	GI311	GI324	2.33	HM010
804D-49-196-S40	49	196.00	291	221	70	205.5	40	55	0.30	0.50	–	GI311	GI324	2.45	HM010
804D-50-200-S40	50	200.00	295	225	70	208.5	40	58	0.15	0.50	–	GI311	GI324	2.58	HM010
804D-51-204-S40	51	204.00	299	229	70	213	40	58	0.15	0.50	–	GI311	GI324	2.68	HM010
804D-52-208-S40	52	208.00	303	233	70	217.5	40	58	0.50	0.50	–	GI312	GI325	2.64	HM010
804D-53-212-S40	53	212.00	307	237	70	222	40	58	0.50	0.50	–	GI312	GI325	2.76	HM010
804D-54-216-S40	54	216.00	311	241	70	226.5	40	58	0.50	0.50	–	GI312	GI325	2.90	HM010
804D-55-220-S40	55	220.00	315	245	70	231	40	58	0.50	0.50	–	GI312	GI325	3.00	HM010
804D-56-224-S40	56	224.00	319	249	70	235.5	40	58	0.50	0.50	–	GI312	GI325	3.15	HM010
804D-57-228-S40	57	228.00	323	253	70	240	40	58	0.35	0.50	–	GI312	GI325	3.30	HM010
804D-58-232-S40	58	232.00	327	257	70	244.5	40	58	0.15	0.50	–	GI312	GI325	3.46	HM010

GI300	XPET 0502AP	SCET 050204-UD
GI301	XPET 0602AP	SCET 050204-UD
GI302	XPET 0602AP	SCET 060204-UD
GI303	XPET 0703AP	SCET 060204-UD
GI304	XPET 0703AP	SCET 070308-UD
GI305	XPET 0903AP	SCET 070308-UD
GI306	XPET 0903AP	SCET 09T308-UD
GI307	XPET 11T3AP	SCET 09T308-UD
GI308	XPET 11T3AP	SCET 120408-UD
GI309	XPET 12T3AP	SCET 120408-UD
GI310	XPET 1504AP	SCET 120408-UD
GI311	XPET 1504AP	SCET 150512-UD
GI312	XPET 1904AP	SCET 150512-UD
GI313	XPET 0502AP-SD	SCET 050204-SD
GI314	XPET 0602AP-SD	SCET 050204-SD
GI315	XPET 0602AP-SD	SCET 060204-SD
GI316	XPET 0703AP-SD	SCET 060204-SD
GI317	XPET 0703AP-SD	SCET 070308-SD
GI318	XPET 0903AP-SD	SCET 070308-SD
GI319	XPET 0903AP-SD	SCET 09T308-SD
GI320	XPET 11T3AP-SD	SCET 09T308-SD
GI321	XPET 11T3AP-SD	SCET 120408-SD
GI322	XPET 12T3AP-SD	SCET 120408-SD
GI323	XPET 1504AP-SD	SCET 120408-SD
GI324	XPET 1504AP-SD	SCET 150512-SD
GI325	XPET 1904AP-SD	SCET 150512-SD

HM001	US 2245-T07P	0.9	US 2245-T07P	0.9	FLAG T07P
HM002	US 2205-T07P	0.9	US 2245-T07P	0.9	FLAG T07P
HM003	US 2205-T07P	0.9	US 2205-T07P	0.9	FLAG T07P
HM004	US 2506-T07P	1.2	US 2506-T07P	1.2	FLAG T07P
HM005	US 2507-T08P	1.2	US 3007-T08P	2.0	FLAG T08P
HM006	US 3007-T09P	2.0	US 3007-T09P	2.0	FLAG T09P
HM007	US 3007-T09P	2.0	US 3009-T09P	2.0	FLAG T09P
HM008	US 3510-T15P	3.0	US 3508-T15P	3.0	FLAG T15P
HM009	US 3510-T15P	3.0	US 5012-T15P	5.0	FLAG T15P
HM010	US 4011-T15P	3.5	US 5012-T15P	5.0	FLAG T15P



805D

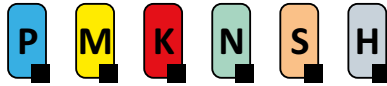

PRAMET

S



Wisselplaatboor, 5xD, koelkanalen

Hoogproductieve wisselplaatboor voor het boren van blinde en doorlopende gaten. Ook geschikt voor kruisgaten, excentrisch boren en pakket boren, circulaire interpolatie, verzinken, boren op holle of schuine oppervlakken, boren met onderbroken sneden, afkantboren en kotteren. Verkrijgbaar van Ø19 t/m Ø31 mm in 5xD.

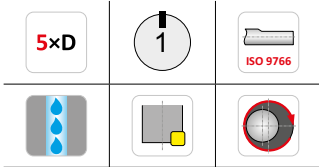
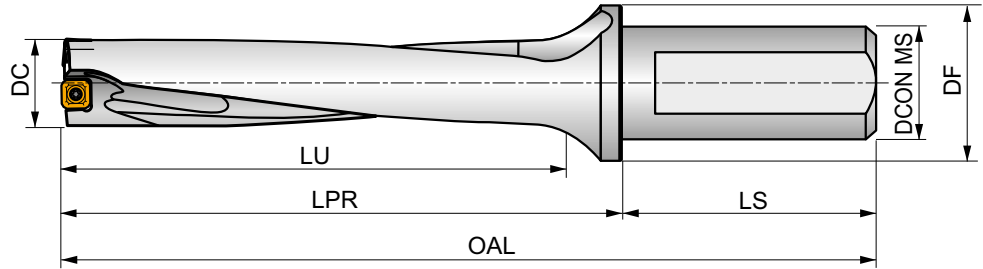

Product	DC	APMX	OAL	LPR	LS	LU	DCON MS	DF	\bar{D}	D^+					kg	
	(mm)	(mm)	(mm)	(mm)	(mm)	(mm)	(mm)	(mm)	(mm)	(mm)						
805D-19-95-S25	19	95.00	176	120	56	100.5	25	35	0.15	0.45	–	GI301	GI314	0.38	HM002	
805D-20-100-S25	20	100.00	181	125	56	105	25	35	0.10	0.45	–	GI302	GI315	0.40	HM003	
805D-21-105-S25	21	105.00	186	130	56	110.5	25	35	0.10	0.50	–	GI302	GI315	0.42	HM003	
805D-22-110-S25	22	110.00	191	135	56	116	25	35	0.45	0.50	–	GI303	GI316	0.45	HM004	
805D-23-115-S25	23	115.00	196	140	56	121.5	25	35	0.35	0.50	–	GI304	GI317	0.48	HM005	
805D-24-120-S25	24	120.00	201	145	56	127	25	35	0.15	0.50	–	GI304	GI317	0.49	HM005	
805D-25-125-S32	25	125.00	210	150	60	130	32	42	0.15	0.50	–	GI304	GI317	0.72	HM005	
805D-26-130-S32	26	130.00	215	155	60	135.5	32	42	0.10	0.50	–	GI304	GI317	0.75	HM005	
805D-27-135-S32	27	135.00	220	160	60	141	32	42	0.50	0.30	–	GI305	GI318	0.78	HM006	
805D-28-140-S32	28	140.00	225	165	60	146.5	32	42	0.30	0.50	–	GI306	GI319	0.82	HM007	
805D-29-145-S32	29	145.00	230	170	60	152	32	42	0.20	0.50	–	GI306	GI319	0.86	HM007	
805D-30-150-S32	30	150.00	235	175	60	157.5	32	42	0.15	0.50	–	GI306	GI319	0.90	HM007	
805D-31-155-S32	31	155.00	240	180	60	163	32	42	0.15	0.50	–	GI306	GI319	0.95	HM007	

GI301	XPET 0602AP	SCET 050204-UD
GI302	XPET 0602AP	SCET 060204-UD
GI303	XPET 0703AP	SCET 060204-UD
GI304	XPET 0703AP	SCET 070308-UD
GI305	XPET 0903AP	SCET 070308-UD
GI306	XPET 0903AP	SCET 09T308-UD
GI314	XPET 0602AP-SD	SCET 050204-SD
GI315	XPET 0602AP-SD	SCET 060204-SD
GI316	XPET 0703AP-SD	SCET 060204-SD
GI317	XPET 0703AP-SD	SCET 070308-SD
GI318	XPET 0903AP-SD	SCET 070308-SD



GI319	XPET 0903AP-SD	SCET 09T308-SD

HM002	US 2205-T07P	0.9	US 2245-T07P	0.9	FLAG T07P
HM003	US 2205-T07P	0.9	US 2205-T07P	0.9	FLAG T07P
HM004	US 2506-T07P	1.2	US 2506-T07P	1.2	FLAG T07P
HM005	US 2507-T08P	1.2	US 3007-T08P	2.0	FLAG T08P
HM006	US 3007-T09P	2.0	US 3007-T09P	2.0	FLAG T09P
HM007	US 3007-T09P	2.0	US 3009-T09P	2.0	FLAG T09P

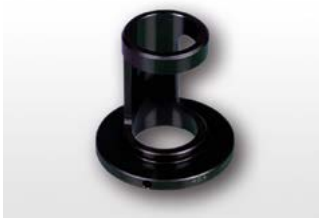

EP

**Instelbare ring voor wisselplaatboor**

Huls om de diameter van de indexeerbare wisselplaatboor aan te passen. Kan gebruikt worden in Ø32 of Ø40 mm Weldon gereedschapshouders. De boorgatdiameter wordt aangepast door de huls te draaien.

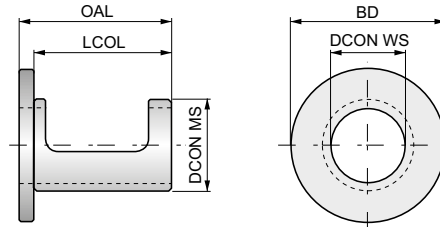

Diameter instelbereik is 0.4 – -0.2; centerhoogte instelbereik is 0.2 – -0.15.

Product	DCON WS	DCON MS	BD	OAL	LCOL	
	(mm)	(mm)	(mm)	(mm)	(mm)	
EP253253	25.00	32.00	53.00	53.0	48	0.15
EP324058	32.00	40.00	58.00	58.0	53	0.20



SCET



	IC (mm)	D1 (mm)	L (mm)	S (mm)
0502	5.556	2.40	5.56	2.38
0602	6.350	2.90	6.35	2.38
0703	7.937	3.50	7.94	3.18
09T3	9.525	4.50	9.53	3.97
1204	12.700	5.60	12.70	4.76
1505	15.875	5.60	15.88	5.56

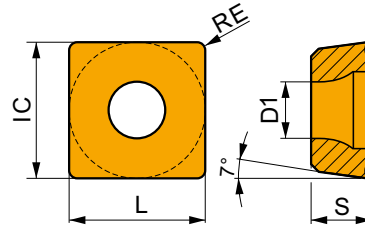

De geschiktheid en startwaarden voor de snij snelheid (vc), voeding (f) en snediepte (ap). Raadpleeg onze verspaningscalculator app voor meer berekeningen.

Product	RE (mm)	P			M			K			N			S			H		
		vc (m/min)	f (mm/rev)	ap (mm)	vc (m/min)	f (mm/rev)	ap (mm)	vc (m/min)	f (mm/rev)	ap (mm)	vc (m/min)	f (mm/rev)	ap (mm)	vc (m/min)	f (mm/rev)	ap (mm)	vc (m/min)	f (mm/rev)	ap (mm)

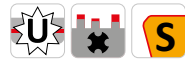
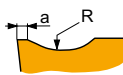

UD universele geometrie voor omtrek-wisselplaten.

SCET 050204-UD 0,12
 SCET 060204-UD 0,15
 SCET 070308-UD 0,15
 SCET 09T308-UD 0,15
 SCET 120408-UD 0,20
 SCET 150512-UD 0,20

SCET 050204-UD	D8330	0.4	165	0.08	-	-	-	-	155	0.08	-	-	-	-	-	-	-	-	-
	D9335	0.4	240	0.08	-	-	-	-	225	0.08	-	-	-	-	-	-	-	-	-
SCET 060204-UD	D8330	0.4	165	0.11	-	-	-	-	155	0.11	-	-	-	-	-	-	-	-	-
	D9335	0.4	240	0.11	-	-	-	-	225	0.11	-	-	-	-	-	-	-	-	-
SCET 070308-UD	D8330	0.8	165	0.13	-	-	-	-	155	0.13	-	-	-	-	-	-	-	-	-
	D9335	0.8	240	0.13	-	-	-	-	225	0.13	-	-	-	-	-	-	-	-	-
SCET 09T308-UD	D8330	0.8	165	0.14	-	-	-	-	155	0.14	-	-	-	-	-	-	-	-	-
	D9335	0.8	240	0.14	-	-	-	-	225	0.14	-	-	-	-	-	-	-	-	-
SCET 120408-UD	D8330	0.8	165	0.16	-	-	-	-	155	0.16	-	-	-	-	-	-	-	-	-
	D9335	0.8	240	0.16	-	-	-	-	225	0.16	-	-	-	-	-	-	-	-	-
SCET 150512-UD	D8330	1.2	165	0.18	-	-	-	-	155	0.18	-	-	-	-	-	-	-	-	-
	D9335	1.2	240	0.18	-	-	-	-	225	0.18	-	-	-	-	-	-	-	-	-

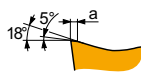

SD positieve geometrie voor omtrek-wisselplaten.

SCET 050204-SD 0,04
 SCET 060204-SD 0,06
 SCET 070308-SD 0,08
 SCET 09T308-SD 0,10
 SCET 120408-SD 0,10
 SCET 150512-SD 0,10

SCET 050204-SD	D8330	0.4	165	0.08	-	95	0.07	-	155	0.08	-	-	-	-	40	0.06	-	-	-
	D9335	0.4	240	0.08	-	140	0.07	-	225	0.08	-	-	-	-	60	0.06	-	-	-
SCET 060204-SD	D8330	0.4	165	0.11	-	95	0.09	-	155	0.11	-	-	-	-	40	0.07	-	-	-
	D9335	0.4	240	0.11	-	140	0.09	-	225	0.11	-	-	-	-	60	0.07	-	-	-
SCET 070308-SD	D8330	0.8	165	0.13	-	95	0.11	-	155	0.13	-	-	-	-	40	0.09	-	-	-
	D9335	0.8	240	0.13	-	140	0.11	-	225	0.13	-	-	-	-	60	0.09	-	-	-
SCET 09T308-SD	D8330	0.8	165	0.14	-	95	0.13	-	155	0.14	-	-	-	-	40	0.10	-	-	-
	D9335	0.8	240	0.14	-	140	0.13	-	225	0.14	-	-	-	-	60	0.10	-	-	-
SCET 120408-SD	D8330	0.8	165	0.16	-	95	0.14	-	155	0.16	-	-	-	-	40	0.11	-	-	-
	D9335	0.8	240	0.16	-	140	0.14	-	225	0.16	-	-	-	-	60	0.11	-	-	-
SCET 150512-SD	D8330	1.2	165	0.18	-	95	0.16	-	155	0.18	-	-	-	-	40	0.12	-	-	-
	D9335	1.2	240	0.18	-	140	0.16	-	225	0.18	-	-	-	-	60	0.12	-	-	-



XPET



	IC	D1	L	S
	(mm)	(mm)	(mm)	(mm)
0502	5.556	2.40	5.56	2.38
0602	6.350	2.60	6.35	2.38
0703	7.937	2.90	7.94	3.18
0903	9.525	3.50	9.53	3.18
11T3	11.509	3.90	11.50	3.97
12T3	12.700	3.90	12.70	3.97
1504	15.875	4.50	15.88	4.76
1904	19.050	4.50	19.05	4.76

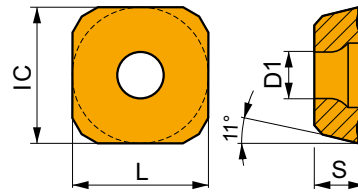

De geschiktheid en startwaarden voor de snij snelheid (vc), voeding (f) en snediedpte (ap). Raadpleeg onze verspaningscalculator app voor meer berekeningen.

Product	RE (mm)	P			M			K			N			S			H		
		vc (m/min)	f (mm/rev)	ap (mm)	vc (m/min)	f (mm/rev)	ap (mm)	vc (m/min)	f (mm/rev)	ap (mm)	vc (m/min)	f (mm/rev)	ap (mm)	vc (m/min)	f (mm/rev)	ap (mm)	vc (m/min)	f (mm/rev)	ap (mm)

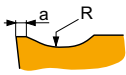

Universele geometrie voor centrum-wisselplaten.

Product	a
XPET 0502AP	0,10
XPET 0602AP	0,10
XPET 0703AP	0,15
XPET 0903AP	0,25
XPET 11T3AP	0,25
XPET 12T3AP	0,25
XPET 1504AP	0,25
XPET 1904AP	0,25

XPET 0502AP	D8345	—	■	165	0.08	—	—	—	—	■	155	0.08	—	—	—	—	—	—	—
XPET 0602AP	D8345	—	■	165	0.11	—	—	—	—	■	155	0.11	—	—	—	—	—	—	—
XPET 0703AP	D8345	—	■	165	0.13	—	—	—	—	■	155	0.13	—	—	—	—	—	—	—
XPET 0903AP	D8345	—	■	165	0.14	—	—	—	—	■	155	0.14	—	—	—	—	—	—	—
XPET 11T3AP	D8345	—	■	165	0.16	—	—	—	—	■	155	0.16	—	—	—	—	—	—	—
XPET 12T3AP	D8345	—	■	165	0.16	—	—	—	—	■	155	0.16	—	—	—	—	—	—	—
XPET 1504AP	D8345	—	■	165	0.18	—	—	—	—	■	155	0.18	—	—	—	—	—	—	—
XPET 1904AP	D8345	—	■	165	0.18	—	—	—	—	■	155	0.18	—	—	—	—	—	—	—

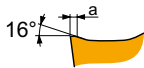

SD positieve geometrie voor centrum-wisselplaten.

Product	a
XPET 0502AP-SD	0,04
XPET 0602AP-SD	0,05
XPET 0703AP-SD	0,08
XPET 0903AP-SD	0,10
XPET 11T3AP-SD	0,10
XPET 12T3AP-SD	0,10
XPET 1504AP-SD	0,10
XPET 1904AP-SD	0,12

XPET 0502AP-SD	D8345	—	■	165	0.08	—	■	95	0.07	—	■	155	0.08	—	—	—	■	40	0.06	—	—	—	—
XPET 0602AP-SD	D8345	—	■	165	0.11	—	■	95	0.09	—	■	155	0.11	—	—	—	■	40	0.07	—	—	—	—
XPET 0703AP-SD	D8345	—	■	165	0.13	—	■	95	0.11	—	■	155	0.13	—	—	—	■	40	0.09	—	—	—	—
XPET 0903AP-SD	D8345	—	■	165	0.14	—	■	95	0.13	—	■	155	0.14	—	—	—	■	40	0.10	—	—	—	—
XPET 11T3AP-SD	D8345	—	■	165	0.16	—	■	95	0.14	—	■	155	0.16	—	—	—	■	40	0.11	—	—	—	—
XPET 12T3AP-SD	D8345	—	■	165	0.16	—	■	95	0.14	—	■	155	0.16	—	—	—	■	40	0.11	—	—	—	—
XPET 1504AP-SD	D8345	—	■	165	0.18	—	■	95	0.16	—	■	155	0.18	—	—	—	■	40	0.12	—	—	—	—
XPET 1904AP-SD	D8345	—	■	165	0.18	—	■	95	0.16	—	■	155	0.18	—	—	—	■	40	0.12	—	—	—	—







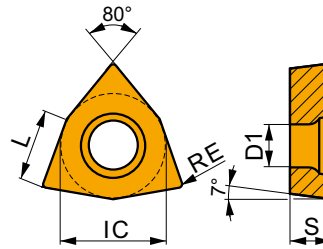



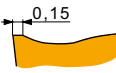

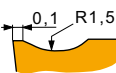

WCMT-ID

	IC	D1	L	S
	(mm)	(mm)	(mm)	(mm)
0402	6.350	2.90	4.30	2.38
0503	7.938	3.50	5.40	3.18
06T3	9.525	4.40	6.50	3.97
0804	12.700	5.50	8.70	4.76

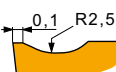

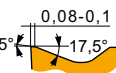
De geschiktheid en startwaarden voor de snijsnelheid (vc), voeding (f) en sneddiepte (ap). Raadpleeg onze verspaningscalculator app voor meer berekeningen.

Product	RE	P			M			K			N			S			H				
		vc	f	ap	vc	f	ap	vc	f	ap	vc	f	ap	vc	f	ap	vc	f	ap		
	(mm)	(m/min)	(mm/rev)	(mm)	(m/min)	(mm/rev)	(mm)	(m/min)	(mm/rev)	(mm)	(m/min)	(mm/rev)	(mm)	(m/min)	(mm/rev)	(mm)	(m/min)	(mm/rev)	(mm)		
   <p>Geometrie 45 voor nabewerken tot voorbereken, en ononderbroken tot onderbroken snedes.</p>	D8330	0.8	█ 165	0.15	–	█ 95	0.14	–	█ 155	0.15	–	–	–	–	–	–	–	–	–	–	
   <p>Geometrie 46 voor fijn nabewerken tot nabewerken, en ononderbroken tot onderbroken snedes.</p>	D8330	0.8	█ 165	0.15	–	█ 95	0.14	–	█ 155	0.15	–	–	–	–	–	–	–	–	–	–	
   <p>Geometrie 47 voor nabewerken tot semi voorbereken, en ononderbroken tot onderbroken snedes.</p>	D8330	0.8	█ 165	0.20	–	█ 95	0.18	–	█ 155	0.20	–	–	–	–	–	–	–	–	–	–	
   <p>Geometrie 48 voor nabewerken tot semi voorbereken, en ononderbroken tot onderbroken snedes.</p>	D8330	1.2	█ 165	0.22	–	█ 95	0.22	–	█ 155	0.22	–	–	–	–	–	–	–	–	–	–	
   <p>Geometrie UM voor nabewerken tot semi voorbereken, en ononderbroken tot licht onderbroken snedes.</p>	D8330	0.8	█ 165	0.20	–	█ 95	0.18	–	█ 155	0.20	–	–	–	–	–	–	–	–	–	–	
WCMT 050308E-UM	D8330	0.8	█ 165	0.20	–	█ 95	0.18	–	█ 155	0.20	–	–	–	–	–	–	–	–	–	–	–



WCMX



	IC	D1	L	S
	(mm)	(mm)	(mm)	(mm)
0302	5.556	2.85	3.80	2.38
0402	6.350	3.15	4.30	2.38
0503	7.938	3.20	5.40	3.18
06T3	9.525	3.72	6.50	3.97
0804	12.700	4.30	8.70	4.76

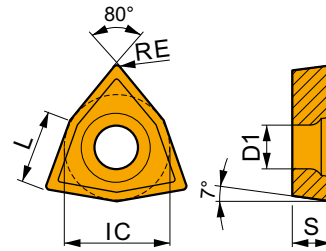

De geschiktheid en startwaarden voor de snijsnelheid (vc), voeding (f) en snediediepte (ap). Raadpleeg onze verspaningscalculator app voor meer berekeningen.

Product	RE (mm)	P			M			K			N			S			H						
		vc (m/min)	f (mm/rev)	ap (mm)	vc (m/min)	f (mm/rev)	ap (mm)	vc (m/min)	f (mm/rev)	ap (mm)	vc (m/min)	f (mm/rev)	ap (mm)	vc (m/min)	f (mm/rev)	ap (mm)	vc (m/min)	f (mm/rev)	ap (mm)				
		U		S		Geometrie 45 voor nabewerken tot voorbereken, en ononderbroken tot onderbroken snedes.																	
WCMX 06T308E-15	D8330 0.8	165	0.15	-	95	0.14	-	155	0.15	-	-	-	-	-	-	-	-	-	-				
		U		S		Geometrie 46 voor fijn nabewerken tot nabewerken, en ononderbroken tot onderbroken snedes.																	
WCMX 030208E-16	D8330 0.8	165	0.15	-	95	0.14	-	155	0.15	-	-	-	-	-	-	-	-	-	-				
WCMX 040208E-16	D8330 0.8	165	0.15	-	95	0.14	-	155	0.15	-	-	-	-	-	-	-	-	-	-				
		U		S		Geometrie 47 voor nabewerken tot semi voorbereken, en ononderbroken tot onderbroken snedes.																	
WCMX 050308E-17	D8330 0.8	165	0.20	-	95	0.18	-	155	0.20	-	-	-	-	-	-	-	-	-	-				
		U		S		Geometrie 48 voor nabewerken tot semi voorbereken, en ononderbroken tot onderbroken snedes.																	
WCMX 080412E-18	D8330 1.2	165	0.22	-	95	0.20	-	155	0.22	-	-	-	-	-	-	-	-	-	-				



BOREN
TECHNISCHE INFORMATIE



WERKSTUKMATERIAALGROEPEN (WMG)

ISO Voor het selecteren van een basismateriaal en geometrie voor een breed scala aan werkstukmaterialen

Algemene definitie
d.w.z. staal, roestvast staal...

P **M** **K** **N** **S** **H**

Subgroep Om te navigeren en een gereedschap te selecteren op basis van geschiktheid voor een specifiek assortiment werkstukmaterialen

Definitie op basis van structuur/samenstelling
d.w.z. gewoon koolstofstaal, gelegeerd staal...

P **M** **K** **N** **S** **H**

P1

P2

P3

P4

WMG Het selecteren en bieden van snijcondities binnen een bandbreedte van $\pm 10\%$

Definitie op basis van hardheid/treksterkte
d.w.z. $160 < 220 \text{ HB}$, $620 < 900 \text{ n/mm}^2 \dots$

P

P1 **P1.1** **P1.2** **P1.3**

P2 **P2.1** **P2.2** **P2.3**

P3 **P3.1** **P3.2** **P3.3**

P4 **P4.1** **P4.2** **P4.3**

INFORMATIE OVER WERKSTUKMATERIAALCLASSIFICATIE VAN DORMER PRAMET

Werkstukmateriaalgroepen ("WMG") zijn bedoeld om een eenvoudige en betrouwbare keuze van het juiste snijgereedschap en startwaarden voor de verspaningscondities in bepaalde toepassingen te kunnen maken.

Dormer Pramet deelt werkstukmaterialen in zes verschillend gekleurde groepen in;

- **Blauw:** Staal en gietstaal (groep P)
- **Geel:** Roestvast staal (groep M)
- **Rood:** Gietijzer (groep K)
- **Groen:** Non-ferro metalen (groep N)
- **Bruin:** Hittebestendige legeringen (groep S)
- **Grijs:** Geharde materialen (groep H)

Al deze materialen zijn afzonderlijk onderverdeeld in subgroepen op basis van structuur en/of samenstelling. Staal en gietstaal uit groep P zijn bijvoorbeeld onderverdeeld in vier subgroepen, te weten;

- P1 – **Automatenstaal**
- P2 – **Koolstofstaal/ongelegeerd staal**
- P3 – **Gelegeerd staal**
- P4 – **Gereedschapstaal**

Een uiteindelijke verdeling omvat materiaaleigenschappen, zoals hardheid en treksterkte. Dit is bedoeld om onze klanten volledig advies te geven over het gereedschap, inclusief startwaarden voor snij snelheid en voeding.

De tabel op de volgende pagina bevat een beschrijving van elke werkstukmateriaalgroep en voorbeelden van veelgebruikte benamingen.

WERKSTUKMATERIAALGROEPEN (WMG)

ISO groep	Subgroep	WMG (Werkstuk Materiaal Groep)	k_{wg}	Voorbeelden van materialen (AISI, EN, DIN, ČSN, GB, SS, STN, BS, UNE, AFNOR, ASTM, GOST, UNS, UNI, ...)	
P	P1	P1.1	zwavelhoudend < 240 HB	1.33	AISI 1108, EN 1552, DIN 1.0723, SS 1922, ČSN 11120, BS 210A15, UNE F.210F, GB Y15, AFNOR 10F1, GOST A30, UNI CF10S20
		P1.2	zwavel- en fosforhoudend < 180 HB	1.49	AISI 1211, EN 115Mn30, DIN 1.0715, SS 1912, ČSN 11109, BS 230M7, UNE F.2111, GB Y15, AFNOR S250, GOST A40G, UNI CF95Mn28
		P1.3	zwavel-, fosfor-, en loodhoudend < 180 HB	1.53	AISI 12L13, EN 115MnPb30, DIN 1.0718, SS 1914, ČSN 12110, BS 210M16, UNE F.2114, GB Y15Pb, AFNOR S250Pb, GOST AS35G2, UNI CF10SPb20
	P2	P2.1	gehalte < 0.25 % C met een hardheid van < 180 HB	1.14	AISI 1015, EN C15, DIN 1.0401, SS 1350, ČSN 11301, BS 080A15, UNE F.111, GB 15, AFNOR C18RR, GOST S22ps, UNI Fe360
		P2.2	gehalte < 0.55 % C met een hardheid van < 240 HB	1.00	AISI 1030, EN C30, DIN 1.0528, SS 1550, ČSN 12031, BS 080M32, UNE F.1130, GB 30, AFNOR AF50C30, GOST 30G, UNI Fe590
		P2.3	gehalte > 0.55 % C, met een hardheid van < 300 HB	0.89	AISI 1060, EN C60, DIN 1.0601, SS 1655, ČSN 12061, BS 080A62, UNE F513, GB 60, AFNOR 1C60, GOST 60G, UNI C60
	P3	P3.1	gegljooid < 180 HB	0.92	AISI 5015, EN 16Mo3, DIN 1.5415, SS 2912, ČSN 15020, BS 1501-240, UNE F.2601, GB 16Mo, AFNOR 15D3, GOST 15M, UNI 16Mo3KW
		P3.2	gehard en getempereerd 180 – 260 HB	0.74	AISI 4140, EN 42CrMo4, DIN 1.7225, SS 2244, ČSN 15142, BS 708M40, UNE F.8232, GB 42CrMo, AFNOR 42CD4, GOST 40ChFA, UNI 42CrMo4
		P3.3	gelegerd staal 260 – 360 HB	0.63	AISI 4140, EN 42CrMo4, DIN 1.7225, SS 2244, ČSN 15142, BS 708M40, UNE F.8232, GB 42CrMo, AFNOR 42CD4, GOST 40ChFA, UNI 42CrMo4
	P4	P4.1	gegljooid < 26 HRC	0.55	AISI D2, EN X155CrVMo12-1, DIN 1.2370, SS 2736, ČSN 19573, BS BD2, UNE F.520A, GB Cr12Mo1V1, AFNOR Z160CDV12, GOST Ch12MF, UNI X155CrVMo121KU
		P4.2	gehard en getempereerd 26 – 39 HRC	0.47	AISI D2, EN X155CrVMo12-1, DIN 1.2370, SS 2736, ČSN 19573, BS BD2, UNE F.520A, GB Cr12Mo1V1, AFNOR Z160CDV12, GOST Ch12MF, UNI X155CrVMo121KU
		P4.3	39 – 45 HRC	0.38	AISI D2, EN X155CrVMo12-1, DIN 1.2370, SS 2736, ČSN 19573, BS BD2, UNE F.520A, GB Cr12Mo1V1, AFNOR Z160CDV12, GOST Ch12MF, UNI X155CrVMo121KU



WERKSTUKMATERIAALGROEPEN (WMG)

ISO groep	Subgroep	WMG (Werkstuk Materiaal Groep)	k_{vg}	Voorbeelden van materiaal (AISI, EN, DIN, ČSN, GB, SS, STN, BS, UNE, AFNOR, ASTM, GOST, UNS, UNI, ...)
M Roestvast staal (corrosiebestendige staalsoorten met $\geq 11\%$ chroomgehalte)	M1 Ferritisch roestvaststaal (chroomhoudende niet hardbare legering)	M1.1 roestvast staal, ferritisch met een hardheid van < 160 HB	1.22	AISI 5429, EN X7Cr14, DIN 1.4001, SS 2326, BS 434517, UNE F.3401, AFNOR Z8C12, GOST 08Ch13, UNI X6CrTi12
		M1.2 gegloeid 160 – 220 HB	1.03	AISI 446, EN X10CrAl24, DIN 1.4762, SS 2322, ČSN 17113, BS 430517, UNE F.3154, GB 10Cr17, AFNOR Z10CA524, GOST 12Ch17, UNI X16Cr26
	M2 Martensitisch roestvaststaal(chroomhoudende hardbare legeringen)	M2.1 roestvast staal, martensitisch met een hardheid van < 200 HB	1.08	AISI 430F, EN X14CrMo517, DIN 1.4104, SS 2383, ČSN 17140, BS 410S21, UNE F.3117, AFNOR Z10CF17, UNI X10Cr517
		M2.2 roestvast staal, martensitisch met een hardheid van 200 – 280 HB	0.89	AISI 440C, EN X105CrMo17, DIN 1.4125, SS 2385, ČSN 17023, BS 425C11, UNE F.3402, GB 102Cr17Mo, AFNOR Z100CD17, GOST 95Ch18, UNI GX6CrNi 13 04
	M3 Austenitisch roestvaststaal(chroomhoudende en nikkel chroom magnesium legeringen)	M2.3 precipitatie gehard 280 – 380 HB	0.75	AISI 420, EN X45Cr13, DIN 1.4034, ČSN 17029, BS 425C11, UNE F.3405, AFNOR Z44C14, GOST 20X17H12, UNI X30Cr13
		M3.1 roestvast staal, austenitisch met een hardheid van < 200 HB	1.00	AISI 304, EN X5CrNi18-12, DIN 1.4303, SS 2352, ČSN 17249, BS 305S17, UNE F.3513, GB 10Cr18Ni12, AFNOR Z8CN18.12, UNI X7CrNi18 10
		M3.2 roestvast staal, austenitisch met een hardheid van 200 – 260 HB	0.86	AISI 309, EN X15CrNiSi20-12, DIN 1.4828, ČSN 17251, BS 309S24, UNE F.3312, GB 1G23Ni13, AFNOR Z15CNS20.12, GOST 20Ch20Ni452, UNI 16CrNi23 14
	M4 Austenitisch ferritisch (DUPLEX) of super austenitisch roestvaststaal en precipitatie hardend austenitisch roestvaststaal	M3.3 roestvast staal, austenitisch met een hardheid van 260 – 300 HB	0.77	AISI 5848, EN X45CrNiW18-9, DIN 1.4873, BS 331540, UNE F.3211, AFNOR Z35CNW514-4, UNI X45CrNiW 18 9
		M4.1 roestvast staal, austenitisch, ferritisch of super austenitisch met een hardheid van < 300 HB	0.75	AISI 329, EN X1-NiCrMoCu25-20-5, DIN 1.4539, SS 2562, ČSN 17265, BS 318513, UNE F.3552, GB 022Cr25NiMo2N, AFNOR Z1NCUDU25.20
		M4.2 roestvast staal, precipitatie hardend austenitisch met een hardheid van 300 – 380 HB	0.64	AISI 631 (17-7PH), EN X7CrNiAl17-7, DIN 1.4568, SS 2388, ČSN 17465, BS 301S13, UNE F.3217, GB 07Cr17Ni7Al, AFNOR Z9CNAl17-07, GOST 09Ch17N7Jut, UNI X53CrMnNi21 9



WERKSTUKMATERIAALGROEPEN (WMG)

ISO groep	Subgroep	WMG (Werkstuk Materiaal Groep)	k_{wc}	Gereedschapstaal (AISI, EN, DIN, ČSN, GB, SS, STN, BS, UNE, AFNOR, ASTM, GOST, UNS, UNI, ...)	
K Gietijzer (gietstukken van ijzer en koolstoflegeringen met >koolstofgehalte)	K1 Grijs gietijzer (GG) (ijzer-koolstof gietstukken met een lamellaire grafiet microstructuur)	K1.1 ferritisch of ferritisch perlitisch < 180 HB	1.35	ASTM A48 Grade 20 (F11401), EN-JL-100, DIN GG-10 (0.6010), SS 0110, STN 422410, BS Grade 150, UNE FG10, GB HAT 100, AFNOR Fc10D, GOST SC 10, UNI G10	
		K1.2 ferritisch perlitisch of perlitisch 180 – 240 HB	1.00	ASTM A48 Grade 30 (F12101), EN-JL-1030, DIN GG-20 (0.6020), SS 0120, STN 422420, BS Grade 220, UNE FG20, GB HT200, AFNOR Fc20D, GOST C420, UNI G20	
		K1.3 perlitisch 240 – 280 HB	0.75	ASTM A48 Grade 50 (F13501), EN-JL-1060, DIN GG-35 (0.6035), SS 0135, STN 422435, BS Grade 350, UNE FG35, GB HAT300, AFNOR Fc35D, GOST SC35, UNI G35	
	K2 Smeedbaar gietijzer (GTS-GTW) (ijzer-koolstof gietstukken met grafietvrije microstructuur)	K2.1 ferritisch of < 160 HB		1.39	ASTM A602 Grade M3210 (F20000), EN-JM-1130, DIN GTS-35 (0.8135), SS 0815, BS B340/12, UNE Type A, AFNOR MN 35-10, GOST K435-10
		K2.2 ferritisch of perlitisch 160 – 200 HB		1.13	ASTM A602 Grade M4504 (F20001), EN-JM-1040, DIN GTS-50-05 (0.8045), BS P50-05, AFNOR MB 45-7
		K2.3 perlitisch 200 – 240 HB		0.90	ASTM A602 Grade M7002 (F20004), EN-JM-1140, DIN GTS-45 (0.8145), SS 0854, STN 422540, BS P 45-06, UNE Typ B, AFNOR MP 50-5, GOST K445-7, UNI GMN 45
	K3 Taai gietijzer (GGG) (ijzer-koolstof gietstukken met een nodulaire grafiet microstructuur)	K3.1 ferritisch < 180 HB		1.23	ASTM A536 Grade 60-40-18 (F32800), EN-JS-1030, DIN GGG-40 (0.7040), SS 0717, STN 422304, BS 420/12, UNE FGE 42-12, GB QT 400, AFNOR FGS 400-12, GOST B440
		K3.2 ferritisch of perlitisch 180 – 220 HB		0.94	ASTM A536 Grade 80-55-06 (F33800), EN-JS-1050, DIN GGG-50 (0.7050), SS 0727, STN 422305, BS 500/7, UNE FGE 50-7, GB QT 500-7, AFNOR FGS 500-7, GOST B450
		K3.3 perlitisch 220 – 260 HB		0.76	ASTM A536 Grade 100-70-03 (F34800), EN-JS-1060, DIN GGG-60 (0.7060), SS 0732, STN 422306, BS 600/3, UNE FG70-2, GB QT 600-3, AFNOR FGS 600-3, GOST B460
	K4 Austenitisch of austempered nodulair gietijzer (Ni-Resist/ADI) (gietstukken van ijzer-koolstoflegeringen met een austenitische of ausferritische microstructuur)	K4.1 Austenitisch gietijzer < 180 HB		1.14	ASTM A436 Type 1 (L-NiCuCr 15 6 2, F41000), EN-JL-3011, DIN GGL-NiMn 13 7 (0.6652), SS 0523, BS Grade F1, AFNOR FGL-Ni13Mn7, GOST S-NiMn 13 7
		K4.2 Austenitisch taai gietijzer 180 – 240 HB		0.86	ASTM A439 Type D-2B (S-NiCr 20 3, F43001), EN-JS-3021, DIN GGG-NiMn 23 4, SS 0776, BS Grade S2M, AFNOR FGS Ni23 Mn4, GOST CH19X3U
		K4.3 Austempered nodulair gietijzer 240 – 280 HB		0.63	ASTM A897 Grade 110-70-11
	K5 Verdicht gietijzer CGI (ijzer-koolstof gietstukken met een vermiculaire grafiet microstructuur)	K4.4 Austempered nodulair gietijzer 280 – 320 HB		0.54	ASTM A897 Grade 125-80-10, EN-JS-1100, DIN GGG-90 (5.3400)
		K4.5 Austempered nodulair gietijzer 320 – 360 HB		0.45	ASTM A897 Grade 2 (150-110-07), EN-JS-1110, DIN GGG-100 (5.3403)
		K5.1 ferritisch < 180 HB		1.29	ASTM A842 Grade 300, EN-GJV-300, DIN GGV 30, GOST 4BT30,
K5	K5.2 ferritisch/perlitisch 180 – 220 HB		0.97	ASTM A842 Grade 350, EN-GJV-350, DIN GGV 35 (5.2200), GOST 4BT30,	
	K5.3 perlitisch 220 – 260 HB		0.75	ASTM A842 Grade 450, EN-GJV-450, DIN GGV 45, GOST 4BT45,	



WERKSTUKMATERIAALGROEPEN (WMG)

ISO groep	Subgroep	WMG (Werkstuk Materiaal Groep)	k _{vg}	Voorbeelden van materiaal (AISI, EN, DIN, ČSN, GB, SS, STN, BS, UNE, AFNOR, ASTM, GOST, UNS, UNI, ...)
N Non-ferrometalen (metalen met daarbij legeringen zonder een aanzienlijke hoeveelheid ijzer)	N1 Gesmeed Aluminium legeringen	N1.1 Zuiver aluminium < 60 HB	1.33	UNS A91200, EN AL99.6, DIN 3.0205, SS 4010, STN 424009, BS 1C, UNE L-3001, GB L5, AFNOR A4, GOST AĐC, UNI 3567
		N1.2 half hard getemperd 60 – 100 HB	1.00	UNS A93004, EN A1Mn0.5Mg0.5, DIN 3.0505, SS 4054, STN 424432, BS N31, UNE L-3831, GB LF2, AFNOR A-M1, GOST AMu, UNI 3568
		N1.3 doorgehard getemperd 100 – 150 HB	0.67	UNS A95083, EN A1Mg4.5Mn0.7, DIN 3.3547, SS 4140, STN 424415, BS N8, UNE L-3321, GB A1Mg4.5Mn, AFNOR A-G4.5Mn, GOST A1Mg 4.5, UNI P-A1Mg4.4
	N2 Gietaluminium legeringen	N2.1 Gietaluminium legeringen < 75 HB	0.67	UNS A02080, EN A1Cu45, BS LM11, STN 424331, UNE A1Si1Cu, GOST AMg5K, UNI G-A1Si7Mg
		N2.2 Gietaluminium legeringen 75 – 90 HB	0.60	UNS A02420, EN A1Cu41Ni2Mg2, SS A1Si7MgFe, BS LM6, STN 424519, UNE A1-7SiMg, AFNOR A-S7G, GOST AK7, UNI G-A1Si7Mg
		N2.3 Gietaluminium legeringen 90 < 140 HB	0.43	UNS A03360, EN G-ALCu4NiMg2, SS A1Si10Mg, STN 424336, BS LM 30, AFNOR A-S10G, UNI G-A1Si9Mg
	N3 Koper of koperlegering	N3.1 Automaten messing en koperlegeringen met uitstekende verspanningseigenschappen	0.70	UNS C14700, EN CuPb1P, DIN 2.1498, STN 423214, BS C111, AFNOR CuZn35Pb2, GOST L63-3, UNI CuS(P0.01)
		N3.2 Kortsparig messing en koperlegeringen met goede tot middelmatige verspanningseigenschappen	0.41	UNS C81540, EN CuNi25Cr, DIN 2.0857, STN 423220, BS NS113, UNE CuSn12, AFNOR CuZn40, GOST L60, UNI P-CuZn-40
		N3.3 Electrolitisch koper en langspanige koperlegeringen met middelmatige tot slechte verspanningseigenschappen	0.21	UNS C10100, EN CuAg0.1, DIN 2.1203, SS 5010, UNE CUSi3Mn1, AFNOR Cu-C2, GOST M1f, UNI Cu-0F
	N4 Kunststoffen (synthetische of half synthetische materialen)	N4.1 Thermoplastische kunststoffen	0.70	ABS, Acryl, Duraplast, Elastomer, EP, Epoxid, FEP, Fluor, Gummi, Kautschuk, Latex, ME, MPF, PA, PAI, PC, PE, PEEK, PEI, PES, PET, PF, Phenolharze, PI, PMMA, Polyamide, Polyester, Polyolefine, Polysulfon, POM, PP, PPE, PPS, PS, PSU, PTFE, PU, PUR, PVDF, SAN, SI, Styrol, UF, Ureol
		N4.2 Thermohardende kunststoffen	0.27	Aramid, Epoxy, Fluoropolymer, Meacrylate, Melamine, Phenolic, Polyester, Polyimide, Polymethacrylimide, Polyurethane
		N4.3 Versterkte kunststoffen of composieten	0.29	CFK, GFK, GMT, Honeycomb, Kevlar, LFT, Organo, SMC
	N5 Grafiet	N5.1	1.0	CGM-1, CM-00, GM-10, GM-11, GR030, GR030PI, GR060, GR060PI, GR125, MC-01, MC-01R0, MC-03, MC-03M, IG11, IG-15, IG-32, IG-43, IG-45, IG-70, ISEM-1, ISEM-2, ISEM-3, R8340, R8500X, Technograph 15, Technograph 30, ISO-63, EDM C-3, EDM1, EDM3, ISO-90, ISO-93, ISO-95, R8510, R8650, R8650

ISO groep	Subgroep	WMG (Werkstuk Materiaal Groep)	k _{wg}	Voorbeelden van materiaal (AISI, EN, DIN, ČSN, GB, SS, STN, BS, UNE, AFNOR, ASTM, GOST, UNS, UNI, ...)	
S Hittebestendige legeringen (superlegeringen met een hogere temperatuur- en roestbestendigheid dan roestvast staal)	S1 Titanium of titanium legeringen	S1.1 Titanium of titanium legeringen <200 HB	1.94	UNS R50250 (Grade 1), EN Ti 99.6, DIN 3.7035, BS TA.2, UNE Ti-Po2, AFNOR T-40, GOST BT1-00, AISI R50250, 3.7025, T35, 2TA1, R50400, 3.7035, 2TAZ,	
		S1.2 Titanium of titanium legering 200 – 280 HB	1.72	UNS R56404 (Grade 29), EN Ti2Cu, DIN 3.7124, BS TA.21, UNE Ti-Pt11, AFNOR T-U2, AISI TA6V, Ti-6Al-4V, Ti 10.2.3, Ti5553	
		S1.3 Titanium of titanium legeringen 280 – 360 HB	1.44	UNS R54250 (Grade 38), EN TiAl6V4, DIN 3.7165, ČSN TiAl6VELI, BS TA. 13, UNE Ti-P63, AFNOR T-A6V, GOST BT6, AISI TA6V, Ti-6Al-4V, Ti 10.2.3, Ti5553	
	S2 Fe-houdende warmvaste legeringen	S2.1 Fe-houdende warmvaste legeringen <200 HB		1.33	UNS N08801 (Incoloy 801), EN X8 NiCrAlTi31-21, DIN 1.4959, BS NA 15, AFNOR Z8NC33-21, AISI A-286, Discaloy, Haynes 556, Inconel 909, Greek Ascology
		S2.2 Fe-houdende warmvaste legeringen 200 – 280 HB		1.17	UNS N19907, EN X6NiCrTiMoVB25-15-2, DIN 1.4980, SS 2570, BS HR52, AFNOR Z6NCTDV25.15B, GOST 36HXT10, AISI A-286, Discaloy, Haynes 556, Inconel 909, Greek Ascology
	S3 Ni-houdende warmvaste legeringen	S3.1 Ni-houdende warmvaste legeringen <280 HB		1.00	UNS A09706 (Inconel 706), EN NiCr25FeAl, DIN 2.4856, BS HR 6, ČSN Inconel 625, UNE F.3313, GB 1Cr16Ni35, AFNOR NC22FeDNB, GOST XH38BT, AISI Inconel 718, 706 Waspalloy, Udimet 720, Inconel 625
		S3.2 Ni-houdende warmvaste legeringen 280 – 360 HB		0.83	UNS N07001, EN NiCr20Co13Mo4Ti3Al, DIN 2.4654, BS HR 2, ČSN Waspalloy, AFNOR NCKD 20ATV, GOST XH80T5K0, AISI Inconel 718, 706 Waspalloy, Udimet 720, Inconel 625
	S4 Co-houdende warmvaste legeringen	S4.1 Co-houdende warmvaste legeringen <240 HB		0.78	UNS R30016 (Stellite 6b), EN CoCr20W15Ni, DIN 2.4964, AFNOR KC 20 WN, GOST ЛК52, AISI Haynes 25, Stellite 21, 31
		S4.2 Co-houdende warmvaste legeringen 240 – 320 HB		0.67	UNS R30016 (Stellite 6b), EN CoCr20W15Ni, DIN 2.4964, AFNOR KC 20 WN, GOST ЛК52, AISI Haynes 25, Stellite 21, 31



WERKSTUKMATERIAALGROEPEN (WMG)

ISO groep	Subgroep	WMG (Werkstuk Materiaal Groep)	k_{vg}	Voorbeelden van materiaal (AISI, EN, DIN, ČSN, GB, SS, STN, BS, UNE, AFNOR, ASTM, GOST, UNS, UNI, ...)
H Geharde materialen (staalsoorten met een hardheid > 45 HRC)	H1 Afgeschrikt gietijzer	H1.1 Afgeschrikt gietijzer < 440 HB	1.52	UNS F45001, EN-GJS-1050-6, DIN 5.3406, SS 0512, BS Grade 2A
		H2.1 Gehard gietijzer < 55 HRC	0.90	UNS F45003, EN-GJS-1400-1, DIN 5.3405, SS 0457, BS Grade 3D
	H2 Gehard gietijzer	H2.2 Gehard gietijzer > 55 HRC	0.77	UNS F45003, EN G-X260NiCr4-2, DIN 0.9620, SS 0466, BS Grade S
		H3.1 Gehard staal < 51 HRC	1.00	AISI 4135, EN 34CrMo4, DIN 1.7220, SS 2234, STN 415131, BS 198, UNE F.1250, GB 35CrMo, AFNOR 35CD4, GOST AC38XTM, UNI 35CrMo4KB
	H3 Gehard staal < 55 HRC	H3.2 Gehard staal < 51 – 55 HRC	0.82	AISI 4135, EN 34CrMo4, DIN 1.7220, SS 2234, STN 415131, BS 198, UNE F.1250, GB 35CrMo, AFNOR 35CD4, GOST AC38XTM, UNI 35CrMo4KB
		H4.1 Gehard staal < 55 – 59 HRC	0.64	UNS T31501, EN 100MnCrW4, DIN 1.2510, SS 2140, STN 419413, BS B01, UNE F.5220, GB 9CrWMn, AFNOR 90MnWCrV5, GOST 9XBТ, UNI 95MnWCr5KU
	H4 Gehard staal > 55 HRC	H4.2 Gehard staal > 59 HRC	0.54	UNS T31501, EN 100MnCrW4, DIN 1.2510, SS 2140, STN 419413, BS B01, UNE F.5220, GB 9CrWMn, AFNOR 90MnWCrV5, GOST 9XBТ, UNI 95MnWCr5KU

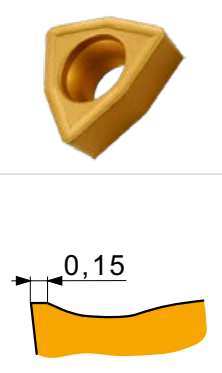
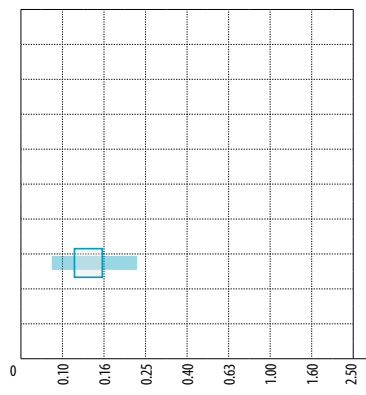

GEOMETRIE VAN DE WISSELPLATEN

45

P	M	K	N	S	H
■	▣	■	■	■	■

f → Zie diagram



? WCMT 06, WCMX 06

46

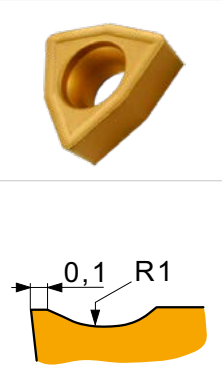
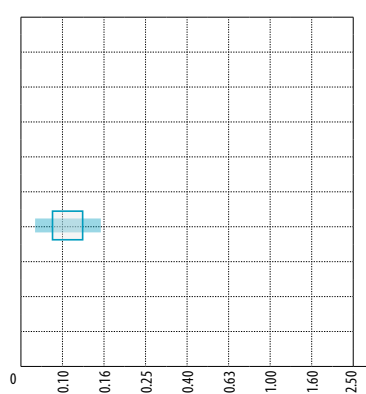
P	M	K	N	S	H
■	▣	■	■	■	■

f → Zie diagram



? WCMT 04, WCMX 03, WCMX 04

47

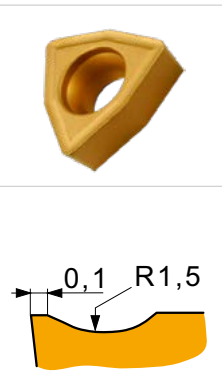
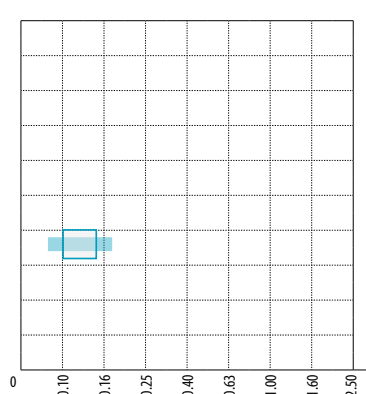
P	M	K	N	S	H
■	▣	■	■	■	■

f → Zie diagram



? WCMT 05, WCMX 05

48

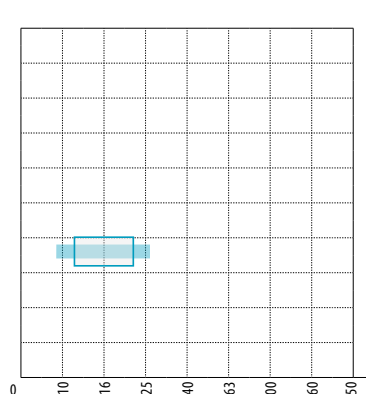
P	M	K	N	S	H
■	▣	■	■	■	■

f → Zie diagram

? WCMT 08, WCMX 08

GEOMETRIE VAN DE WISSELPLATEN

UM



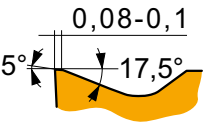
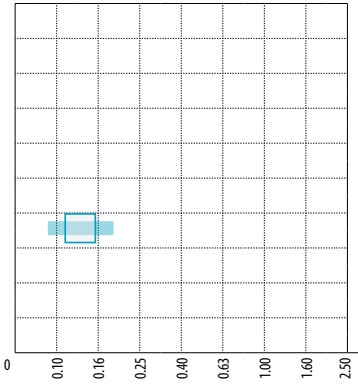



0 0,10 0,16 0,25 0,40 0,63 1,00 1,60 2,50

P **M** **K** **N** **S** **H**

☐ ◻ ◼ ◽ ◾ ◿

f → Zie diagram



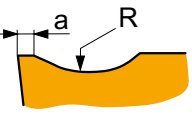

? WCMT 04, WCMT 05

SCET.....-UD

	a
SCET 050204-UD	0,12
SCET 060204-UD	0,15
SCET 070308-UD	0,15
SCET 09T308-UD	0,15
SCET 120408-UD	0,20
SCET 150512-UD	0,20

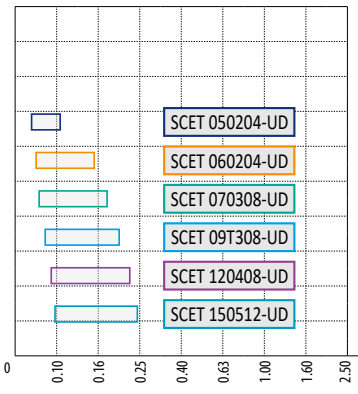



0 0,10 0,16 0,25 0,40 0,63 1,00 1,60 2,50

P **M** **K** **N** **S** **H**

☐ ◻ ◼ ◽ ◾ ◿

f → Zie diagram



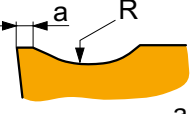

? SCET.....-UD

XPET.....AP

	a
XPET 0502AP	0,10
XPET 0602AP	0,10
XPET 0703AP	0,15
XPET 0903AP	0,25
XPET 11T3AP	0,25
XPET 12T3AP	0,25
XPET 1504AP	0,25
XPET 1904AP	0,25

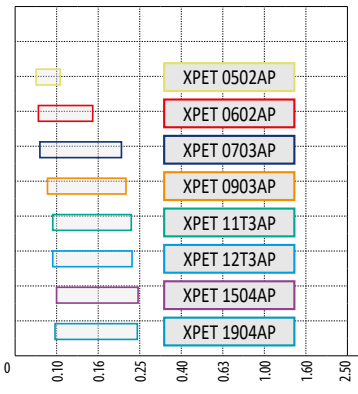



0 0,10 0,16 0,25 0,40 0,63 1,00 1,60 2,50

P **M** **K** **N** **S** **H**

☐ ◻ ◼ ◽ ◾ ◿

f → Zie diagram

? XPET.....AP

GEOMETRIE VAN DE WISSELPLATEN

SCET-SD

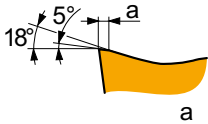

SCET 050204-SD	0,04
SCET 060204-SD	0,06
SCET 070308-SD	0,08
SCET 09T308-SD	0,10
SCET 120408-SD	0,10
SCET 150512-SD	0,10

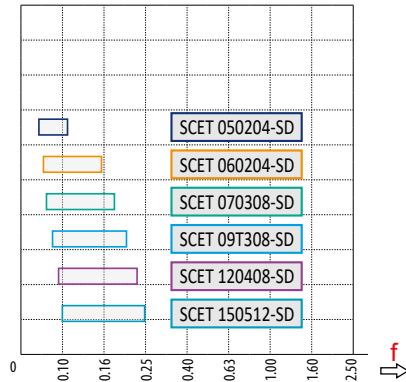

P	M	K	N	S	H
■	■	▣	■	▣	■
f Zie diagram					
SCET-SD					

XPETAP-SD

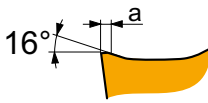



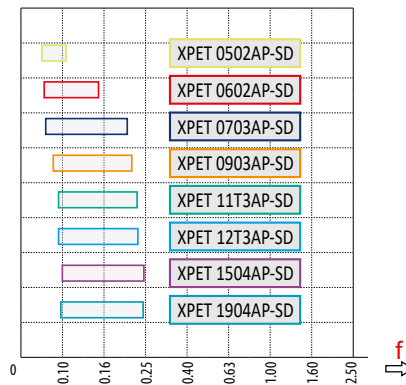

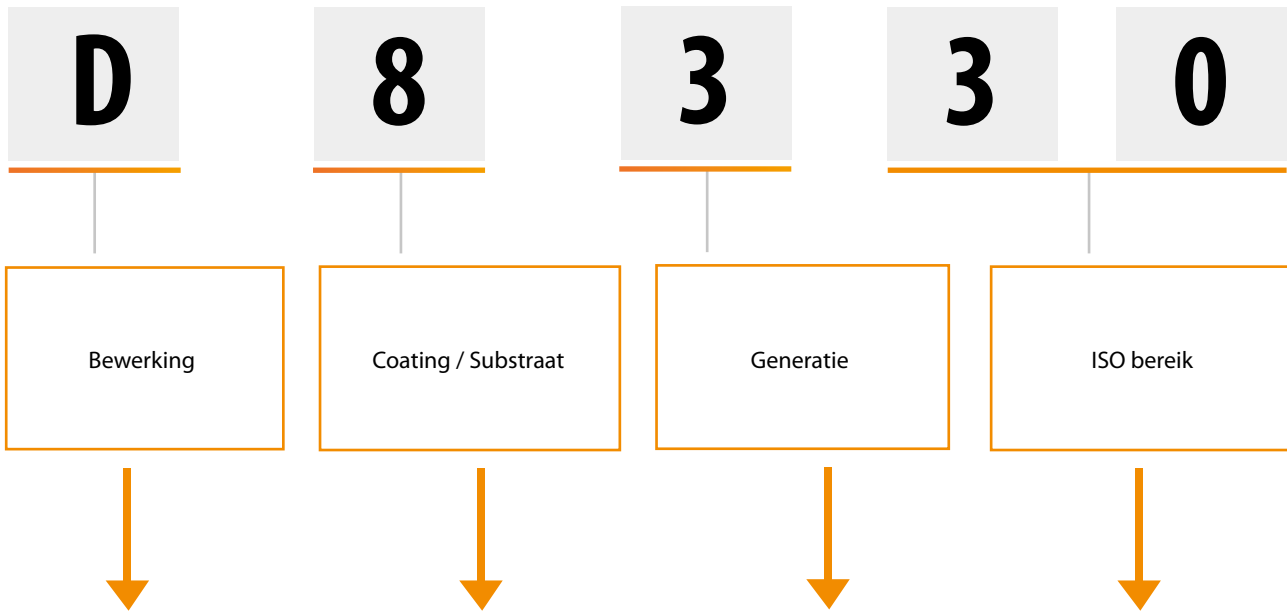

XPET 0502AP-SD	0,04
XPET 0602AP-SD	0,05
XPET 0703AP-SD	0,08
XPET 0903AP-SD	0,10
XPET 11T3AP-SD	0,10
XPET 12T3AP-SD	0,10
XPET 1504AP-SD	0,10
XPET 1904AP-SD	0,12



P	M	K	N	S	H
■	■	▣	■	▣	■
f Zie diagram					
XPETAP-SD					



D	Boren	0 PVD 1 CVD	Speciale toepassing	1 - 9	01 - 50	
M	Frezen	2 PVD 3 CVD	Vrij			01 - 05
T	Draaien	4 PVD 5 CVD	Groep K, H			05 - 10
G	In- en afsteken	6 PVD 7 CVD	Groep M, S			10 - 20
		8 PVD 9 CVD	Universeel		20 - 30	
		B	CBN		30 - 40	
		C	Ceramisch		40 - 50	
		D	PCD			
		T	Cermet			



HARDMETAALSOORTEN - BOREN

Hardmetaalsoort	Inzetgebied	Geschiktheid	Voeding	Snij snelheid	Geschiktheid voor moeilijke omstandigheden	Coating	Kleur	Substraat	Koeling	Beschrijving hardmetaalsoort
D9335	P20 - P35	■				MT-CVD	■	FGM	+++	Deze hardmetaalsoort is aanbevolen voor de omtreksnijdende wisselplaat en meer bestand tegen hoge snij snelheden en voedingen.
	M15 - M30	■								
	K15 - K35	■								
	S10 - S20	▣								
D8330	P20 - P35	■				PVD	■	submicron H	+++	Deze hardmetaalsoort is universeel en voor de omtreksnijdende wisselplaat, geschikt voor de meeste materialen en blinkt uit door de hoge betrouwbaarheid.
	M15 - M30	■								
	K15 - K35	■								
	S10 - S20	▣								
D8345	P30 - P50	■				PVD	■	submicron H	+++	Deze hardmetaalsoort is universeel en voor de centrumsnijdende wisselplaat, het is een extreem taai en geschikt voor de meeste materialen.
	M20 - M40	■								
	K30 - K40	■								
	S20 - S30	▣								

Substraat

submicron H	Op WC-Co gebaseerd fijnkorrelig substraat
FGM	Substraat waarin de eigenschappen van de elementen elkaar versterken

Coating

MT-CVD	Chemische coatingsmethode bij middel hoge temperatuur.
PVD	Physische coatingsmethode bij lage temperatuur.

Voordeel van koeling

+++	Gebruik van koelvloestof is noodzakelijk
-----	--



WISSELPLAATBOREN - AANBEVOLEN VERSPANINGSCONDITIES

802D, 803D (XPET..AP, SCET..-UD)



	D9335	D8330	D8345	∅ 15	∅ 20	∅ 25	∅ 30	∅ 40	∅ 58
P1	■	■	■	0.07	0.08	0.09	0.10	0.12	0.16
P2	■	■	■	0.11	0.13	0.15	0.17	0.21	0.28
P3	■	■	■	0.13	0.15	0.18	0.20	0.24	0.32
P4	■	■	■	0.12	0.14	0.16	0.18	0.22	0.30
K1	■	■	■	0.14	0.16	0.19	0.21	0.26	0.34
K2	■	■	■	0.14	0.16	0.19	0.21	0.26	0.34
K3	■	■	■	0.14	0.16	0.19	0.21	0.26	0.34
K4	■	■	■	0.14	0.16	0.19	0.21	0.26	0.34
K5	■	■	■	0.14	0.16	0.19	0.21	0.26	0.34

802D, 803D (XPET..AP-SD, SCET..-SD)



	D9335	D8330	D8345	∅ 15	∅ 20	∅ 25	∅ 30	∅ 40	∅ 58
P1	■	■	■	0.08	0.09	0.10	0.11	0.14	0.18
P2	■	■	■	0.11	0.13	0.15	0.17	0.21	0.28
P3	■	■	■	0.13	0.15	0.18	0.20	0.24	0.32
P4	■	■	■	-	-	-	-	-	-
K1	▣	▣	▣	0.08	0.09	0.10	0.11	0.14	0.18
K2	▣	▣	▣	0.11	0.13	0.15	0.17	0.21	0.28
K3	▣	▣	▣	0.12	0.14	0.16	0.18	0.22	0.24
K4	▣	▣	▣	0.13	0.15	0.18	0.20	0.24	0.32
K5	▣	▣	▣	0.14	0.16	0.19	0.21	0.25	0.33
M1	■	■	■	0.12	0.14	0.16	0.18	0.22	0.30
M2	■	■	■	0.11	0.13	0.15	0.17	0.21	0.28
M3	■	■	■	0.07	0.08	0.09	0.10	0.12	0.16
M4	■	■	■	0.07	0.08	0.09	0.10	0.12	0.16
S1	▣	▣	▣	0.08	0.09	0.10	0.11	0.14	0.18
S2	▣	▣	▣	0.08	0.09	0.10	0.11	0.14	0.18
S3	▣	▣	▣	0.07	0.08	0.09	0.10	0.12	0.16
S4	▣	▣	▣	0.07	0.08	0.09	0.10	0.12	0.16

804D (XPET..AP, SCET..-UD)



	D9335	D8330	D8345	∅ 15	∅ 20	∅ 25	∅ 30	∅ 40	∅ 58
P1	■	■	■	0.06	0.07	0.08	0.09	0.10	0.14
P2	■	■	■	0.10	0.12	0.14	0.16	0.19	0.25
P3	■	■	■	0.12	0.14	0.16	0.18	0.22	0.30
P4	■	■	■	0.11	0.13	0.15	0.17	0.21	0.28
K1	■	■	■	0.13	0.15	0.18	0.20	0.24	0.32
K2	■	■	■	0.13	0.15	0.18	0.20	0.24	0.32
K3	■	■	■	0.13	0.15	0.18	0.20	0.24	0.32
K4	■	■	■	0.13	0.15	0.18	0.20	0.24	0.32
K5	■	■	■	0.13	0.15	0.18	0.20	0.24	0.32



WISSELPLAATBOREN - AANBEVOLEN VERSPANINGSCONDITIES

804D (XPET..AP-SD, SCET..-SD)



	D9335	D8330	D8345	ø 15	ø 20	ø 25	ø 30	ø 40	ø 58
P1	■	■	■	0.07	0.08	0.09	0.10	0.12	0.16
P2	■	■	■	0.10	0.12	0.14	0.16	0.19	0.25
P3	■	■	■	0.12	0.14	0.16	0.18	0.22	0.30
P4	■	■	■	-	-	-	-	-	-
K1	☑	☑	☑	0.07	0.08	0.09	0.10	0.12	0.16
K2	☑	☑	☑	0.10	0.12	0.14	0.16	0.19	0.25
K3	☑	☑	☑	0.11	0.13	0.15	0.17	0.20	0.27
K4	☑	☑	☑	0.12	0.14	0.16	0.18	0.22	0.30
K5	☑	☑	☑	0.14	0.16	0.19	0.21	0.25	0.33
M1	■	■	■	0.11	0.13	0.15	0.17	0.21	0.28
M2	■	■	■	0.10	0.12	0.14	0.16	0.19	0.25
M3	■	■	■	0.06	0.07	0.08	0.09	0.10	0.14
M4	■	■	■	0.06	0.07	0.08	0.09	0.10	0.14
S1	☑	☑	☑	0.07	0.08	0.09	0.10	0.12	0.16
S2	☑	☑	☑	0.07	0.08	0.09	0.10	0.12	0.16
S3	☑	☑	☑	0.06	0.07	0.08	0.09	0.10	0.14
S4	☑	☑	☑	0.06	0.07	0.08	0.09	0.10	0.14

805D (XPET..AP, SCET..-UD)



	D9335	D8330	D8345	ø 15	ø 20	ø 25	ø 30	ø 40	ø 58
P1	■	■	■	0.06	0.07	0.08	0.09	0.10	0.14
P2	■	■	■	0.10	0.12	0.14	0.16	0.19	0.25
P3	■	■	■	0.12	0.14	0.16	0.18	0.22	0.30
P4	■	■	■	0.11	0.13	0.15	0.17	0.21	0.28
K1	■	■	■	0.13	0.15	0.18	0.20	0.24	0.32
K2	■	■	■	0.13	0.15	0.18	0.20	0.24	0.32
K3	■	■	■	0.13	0.15	0.18	0.20	0.24	0.32
K4	■	■	■	0.13	0.15	0.18	0.20	0.24	0.32
K5	■	■	■	0.13	0.15	0.18	0.20	0.24	0.32

805D (XPET..AP-SD, SCET..-SD)



	D9335	D8330	D8345	ø 15	ø 20	ø 25	ø 30	ø 40	ø 58
P1	■	■	■	0.07	0.08	0.09	0.10	0.12	0.16
P2	■	■	■	0.10	0.12	0.14	0.16	0.19	0.25
P3	■	■	■	0.12	0.14	0.16	0.18	0.22	0.30
P4	■	■	■	-	-	-	-	-	-
K1	☑	☑	☑	0.07	0.08	0.09	0.10	0.12	0.16
K2	☑	☑	☑	0.10	0.12	0.14	0.16	0.19	0.25
K3	☑	☑	☑	0.11	0.13	0.15	0.17	0.20	0.27
K4	☑	☑	☑	0.12	0.14	0.16	0.18	0.22	0.30
K5	☑	☑	☑	0.12	0.14	0.16	0.18	0.22	0.30
M1	■	■	■	0.11	0.13	0.15	0.17	0.21	0.28
M2	■	■	■	0.10	0.12	0.14	0.16	0.19	0.25
M3	■	■	■	0.06	0.07	0.08	0.09	0.10	0.14
M4	■	■	■	0.06	0.07	0.08	0.09	0.10	0.14
S1	☑	☑	☑	0.07	0.08	0.09	0.10	0.12	0.16
S2	☑	☑	☑	0.07	0.08	0.09	0.10	0.12	0.16
S3	☑	☑	☑	0.06	0.07	0.08	0.09	0.10	0.14
S4	☑	☑	☑	0.06	0.07	0.08	0.09	0.10	0.14



FORMULES OM DE VERSPANINGSCONDITIES TE BEREKENEN

BENAMINGEN EN FORMULES

Parameter	Formule	Eenheid
Toerental	$n = \frac{v_c \cdot 1000}{DC \cdot \pi}$	(omw/min)
Snij snelheid	$v_c = \frac{\pi \cdot DC \cdot n}{1000}$	(m/min)
Tafelvoeding	$v_f = n \cdot f$	(mm/min)
Oppervlakte van geboorde gat	$A = \frac{\pi \cdot DC^2}{4}$	(mm ²)
Verspaand volume	$Q = \frac{v_f \cdot A}{1000}$	(cm ³ /min)
Bewerkingstijd	$T_c = \frac{L + h}{v_f}$	(min/st)

DC Diameter van de boor

(mm)

h Afstand vanaf boorpunt tot werkstuk voor inschakelen van de voeding

(mm)







f Voeding per omwenteling

(mm/omw)

L Gatdiepte

(mm)

AANBEVOLEN AANHAALMOMENT VAN DE SCHROEVEN

	 Nm					
US 2245-T07P	0.9	FLAG T07P	M 2.2	5.3	D-T7P	MR-0.8-2.0 vario
US 2205-T07P	0.9	FLAG T07P	M2.2	5.4	D-T7P	MR-0.8-2.0 vario
US 2506-T07P	1.2	FLAG T07P	M 2.5	6	D-T7P	MR-0.8-2.0 vario
US 2507-T08P	1.2	FLAG T08P	M 2.5	7	D-T8P	MR-0.8-2.0 vario
US 3007-T08P	2.0	FLAG T08P	M 3	7	D-T8P	MR-1.0-5.0 vario
US 3007-T09P	2.0	FLAG T09P	M 3	7.4	D-T9P	MR-1.0-5.0 vario
US 3009-T09P	2.0	FLAG T09P	M 3	8.7	D-T9P	MR-1.0-5.0 vario
US 3508-T15P	3.0	FLAG T15P	M 3.5	8.3	D-T15P	MR-1.0-5.0 vario
US 3510-T15P	3.0	FLAG T15P	M 3.5	10.6	D-T15P	MR-1.0-5.0 vario
US 4011-T15P	3.5	FLAG T15P	M 4	10.7	D-T15P	MR-1.0-5.0 vario
US 5012-T15P	5.0	FLAG T15P	M 5	12.2	D-T15P	MR-1.0-5.0 vario



BEWERKINGSDATA VOOR WISSELPLAATBOREN

Radiale verstelling

Gatdiameter verstelling en instel aanbevelingen

Radiale verstelling is mogelijk met wisselplaatboren indien een grotere of kleinere gatdiameter gewenst is dan de diameter van de boor. Radiale verstellingswaarden worden vermeld in de hoofdtabelen voor de boren.

Roterende gereedschappen

Voor het boren van gaten met een nauwkeurigheid van IT10 en hoger

worden de verstelbare houders aanbevolen bij gebruik van de 802D, 803D, 804D en 805D boor.

Stationaire gereedschappen

Bij het opspannen van de boor dient gecheckt te worden of het hart van de boor in lijn is met de hartlijn van het werkstuk. Om een groter gat te maken kan de boor uit het hart worden geplaatst zodat de omtrek wisselplaat in de + richting verplaatst vanaf de werkstukhartlijn.

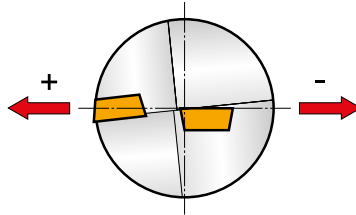

Standtijd

Wisselplaten dienen vervangen (of geïndexeerd) te worden wanneer de flankslijtage 0,2-0,4 mm bedraagt aan de langste zijde (hoofdsnijkant). Bij de verspaningscondities die in deze catalogus worden genoemd is uitgegaan van een standtijd van 7 meter boorweg van de omtrek wisselplaat. (20-30 min. contact)

EP

VERSTELBARE HULZEN

Schachtdiameter	Boordiameter	Bereik
25	15 – 24	+0.4 – -0.2
32	24.5 – 40	+0.4 – -0.2

Voor freesmachines

Diameter instelbereik

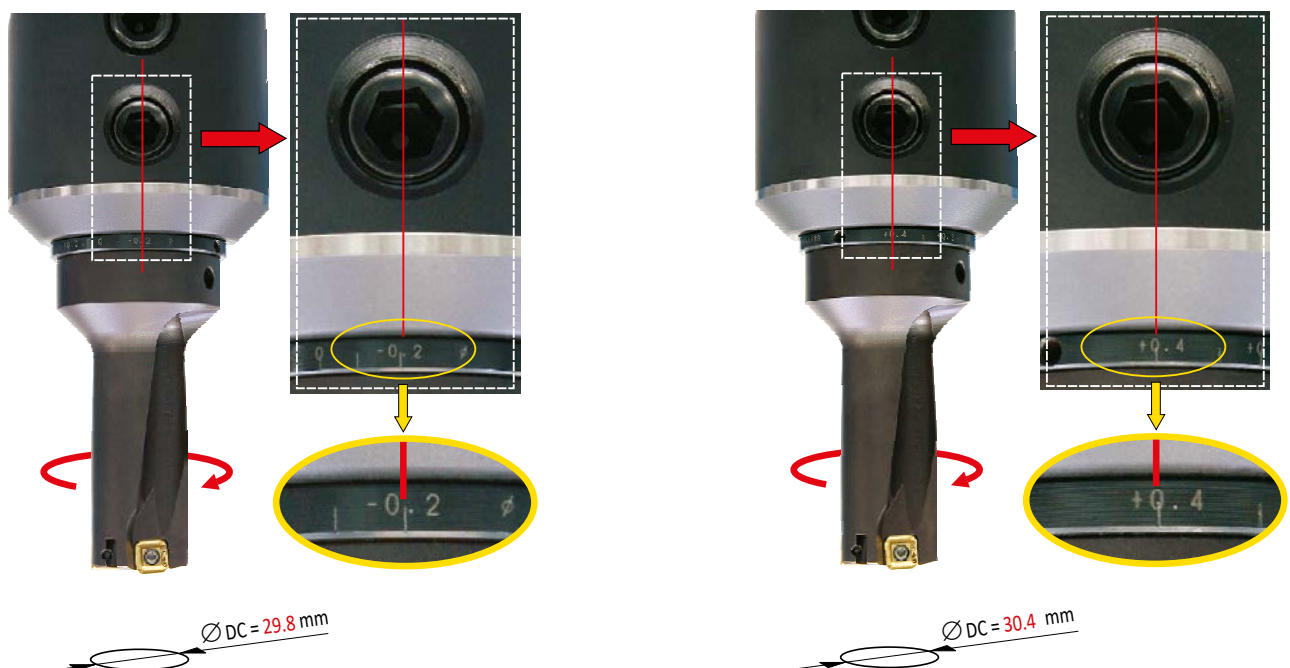



EP

VERSTELBARE HULZEN

Schachtdiameter	Boordiameter	Bereik
25	15 – 24	+0.2 – -0.15
32	24.5 – 40	+0.2 – -0.15

Harthoogte verstelling
– voor draaibewerkingen

Harthoogte verstelbereik

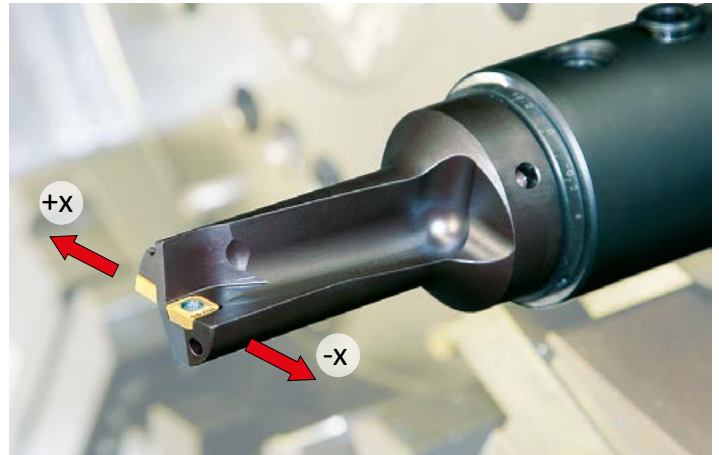

BEWERKINGSDATA VOOR WISSELPLAATBOREN

Aanbevolen druk van het koelmiddel

Boordiameter DC (mm)	Koelmiddeldruk	
	Boorlengte	
	2.0 – 2.5 DC	3.0 – 5.0 DC
15 – 25	6 bar	12 bar
26 – 40	4.5 bar	9 bar
> 40	3 bar	6 bar

Benodigde volume koelmiddel

DROOG BOREN

Perslucht door de koelkanalen wordt aanbevolen bij boren in gietijzer.

Netto benodigd vermogen

■ $f \Rightarrow = 0.18$
 ■ $f \Rightarrow = 0.12$
 ■ $f \Rightarrow = 0.08$

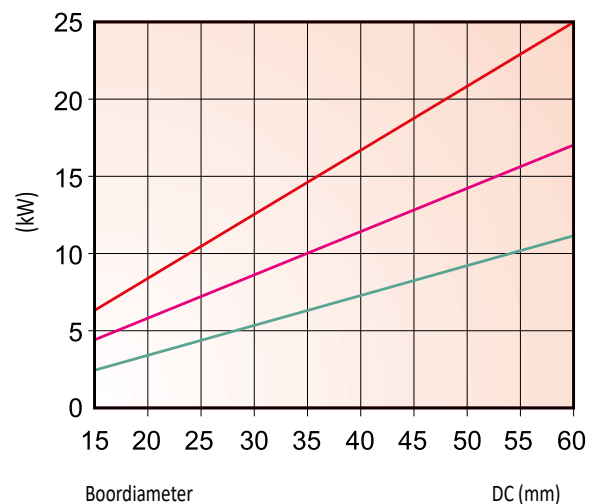
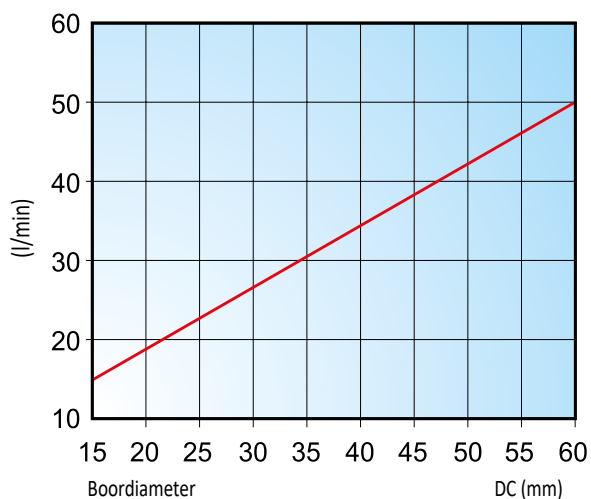

	<p>BOREN VAN BLINDE GATEN Voor het boren van blinde gaten dieper dan 1xD is koeling noodzakelijk.</p>
	<p>BOREN VAN DOORLOPENDE GATEN Er kan een schijf ontstaan bij het doorkomen van de boor. Deze schijf kan met hoge snelheid wegvliegen bij een roterend werkstuk (bv op draaibank). Daarom dient de machine altijd adequaat te zijn afgesloten voor de veiligheid van de operator.</p>
	<p>UIT HET HART BOREN Verlaag de voeding. Zie de aanbevelingen voor de wisselplaatboren. Overschrijdt het radiale verstelbereik niet.</p>
	<p>INLOPEN IN ONEFFEN EN GEGOTEN VLAKKEN Verlaag de voeding met 50% bij het intreden bij wisselplaatboren, totdat beide platen in aansnijding zijn.</p>
	<p>OPBOREN VAN VOORGEBOORDE GATEN Bij een voorgeboord gat groter dan 1/4 van de boordiameter dient de voeding gereduceerd te worden.</p>
	<p>BOREN VAN KRUISGATEN Verlaag de voeding met 50% bij het doorboren van een kruisgat. De diameter van het te kruisen gat dient niet groter te zijn dan 0.25 x D.</p>
	<p>ONDERBROKEN SNEDE EN INSTEKEN Verlaag de voeding. Zie de waarden op de pagina's voor boorwisselplaten.</p>
	<p>BOREN IN EEN GEBOGEN VLAK Boren op de hartlijn is mogelijk bij een gereduceerde voeding van 50% bij in- en uitlopen.</p>
	<p>BOREN IN EEN HELLEND VLAK Verlaag de voeding met 50% bij het inlopen totdat de beide wisselplaten in aansnijding zijn. De hellingshoek mag niet meer zijn dan 5°.</p>
	<p>DOORKOMEN UIT EEN SCHUIN VLAK Verlaag de voeding met 50% bij een hellingshoek van maximaal 5°.</p>
	<p>BOREN DOOR EEN LASNAAD Vlakken is aanbevolen voordat er geboord gaat worden. Verlaag de voeding met 50% zolang de boor in de las boort.</p>
	<p>PAKKETBOREN Vermijd ruimtes groter dan 0,2 mm tussen de lagen. Het werkstuk moet goed vastzitten. Verminder de voeding indien nodig.</p>



PROBLEMEN OPLOSSEN BIJ WISSELPLAATBOREN

ONVOLDOENDE VERMOGEN VAN DE AANDRIJFMOTOR (LAAG SPINDELVERMOGEN)	<ul style="list-style-type: none">a) verlaag de snijsnelheid = reduceer het spindel toerentalb) verlaag de voedingsnelheid
GROTE SLIJTAGE VAN DE OMTREK WISSELPLAAT	<ul style="list-style-type: none">a) verlaag de snijsnelheid = reduceer spindeltoerentalb) selecteer een slijtvastere hardmetaalsoortc) verhoog de koeldruk en -volume
UITBROKKELEN VAN DE OMTREKWISSELPLAAT	<ul style="list-style-type: none">a) verlaag de voeding tot de omtrekwisselplaat volledig snijdtb) selecteer een taaiere hardmetaalsoortc) verlaag de snijsnelheid
UITBROKKELEN VAN DE CENTRUM WISSELPLAAT	<ul style="list-style-type: none">a) verlaag de voeding bij het inlopenb) controleer boor- en werkstukopspanning
AANHOUDEND SLECHTE SPAANVORMING	<ul style="list-style-type: none">a) pas de voeding aanb) verhoog de snijsnelheid en verlaag gelijktijdig de voeding
OPHOPEN VAN KORTE SPANEN IN DE SPAANGROEVEN	<ul style="list-style-type: none">a) verhoog koelvolumen en -drukb) verlaag snijsnelheidc) verhoog de voeding



AANBEVOLEN VOORBOORMATEN VOOR TAPPEN

Metrische ISO draad		Aanbevolen boordiameter voor	
Draad	Spoed	Snijdende tap	Roltap
M16 × 1.0	1.00	15.0	15.5
M16 × 0.75	0.75	15.3	–
M17 × 1.0	1.00	16.0	–
M18	2.50	15.5	16.8
M18 × 2.0	2.00	16.0	–
M18 × 1.5	1.50	16.5	17.3
M18 × 1.0	1.00	17.0	–
M20	2.50	17.5	18.8
M20 × 2.0	2.00	18.0	–
M20 × 1.5	1.50	18.5	19.3
M20 × 1.0	1.00	19.0	–
M22	2.50	19.5	20.8
M22 × 2.0	2.00	20.0	–
M22 × 1.5	1.50	20.5	21.3
M22 × 1.0	1.00	21.0	–
M24	3.00	21.0	22.5
M24 × 2.0	2.00	22.0	–
M24 × 1.5	1.50	22.5	23.3
M27	3.00	24.0	–
M27 × 2.0	2.00	25.0	–
M30	3.50	26.5	–
M30 × 2.0	2.00	28.0	–
M33	3.50	29.5	–
M36	4.00	32.0	–
M36 × 3.0	3.00	33.0	–
M39	4.00	35.0	–
M42	4.50	37.5	–
M42 × 3.0	3.00	39.0	–
M45	4.50	40.5	–
M48	5.00	43.0	–
M48 × 3.0	3.00	45.0	–
M52	5.00	47.0	–
M52 × 3.0	3.00	48.0	–

UNC Inch schroefdraad		Aanbevolen boordiameter voor	
Draad	Spoed	Snijdende tap	Roltap
3/4"	10	16.7	17.8
7/8"	9	19.5	20.8
1"	8	22.2	23.8
1 1/8"	7	25.0	–
1 1/4"	7	28.2	–
1 3/8"	6	31.0	–
1 1/2"	6	34.0	–
1 3/4"	5	39.5	–
2"	4 1/2	45.2	–
2 1/4"	4 1/2	51.6	–
2 1/2"	4	57.2	–

Whitworth schroefdraad		Aanbevolen boordiameter voor	
Draad	Spoed	Snijdende tap	Roltap
G 3/8"	19	15.3	16.0
G 1/2"	14	19.0	20.0
G 5/8"	14	21.0	22.0
G 3/4"	14	24.5	25.5
G 7/8"	14	28.3	29.3
G 1"	11	30.8	32.0
G 1 1/8"	11	35.5	–
G 1 1/4"	11	39.5	–
G 1 3/8"	11	41.8	–
G 1 1/2"	11	45.3	–
G 1 3/4"	11	51.0	–
G 2"	11	57.0	–

UNF Inch schroefdraad		Aanbevolen boordiameter voor	
Draad	Spoed	Snijdende tap	Roltap
3/4"	16	17.5	18.3
7/8"	14	20.5	21.3
1"	12	23.4	24.3
1 1/8"	12	26.5	–
1 1/4"	12	29.8	–
1 3/8"	12	33.0	–
1 1/2"	12	36.0	–



KOTTERSYSTEMEN





GATBEWERKING - ALGEMENE INHOUD

6		WMG & ISO 13399
12	BOREN	INSTRUCTIES
15		VOLHARDMETAAL BOREN
66		HSS BOREN
176		TECHNISCHE INFORMATIE
186		SNIJOLIE
190		RUIMERS EN VERZINKBOREN
264	WISSELPLAATBOREN	INSTRUCTIES
271		HYDRA BOREN
297		TECHNISCHE INFORMATIE
307		WISSELPLAATBOREN
327		TECHNISCHE INFORMATIE
350	KOTTERSYSTEMEN	INSTRUCTIES
359		KOTTERKOPPEN
376		KOTTER ACCESSOIRES
381		WISSELPLATEN
404		OPNAMES
418		KOTTERSETS
429		TECHNISCHE INFORMATIE



WISSELPLATEN - UITLEG PRODUCTPAGINA



1 CCGT

	IC (mm)	D1 (mm)	L (mm)	S (mm)
0602	6.350	2.80	6.40	2.38
0602-SF3	6.350	2.80	6.40	2.58
0803-AL	7.940	3.40	8.10	3.43
0803-SF3	7.940	3.40	8.10	3.43
09T3	9.525	4.40	9.70	3.97
09T3-SF3	9.525	4.40	9.70	4.22
1204	12.700	5.50	12.90	4.76
1204-SF3	12.700	5.50	12.90	5.01

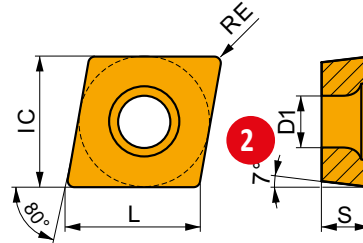

De geschiktheid en startwaarden voor de snijnsnelheid (vc), voeding (f) en sneddiepte (ap). Raadpleeg onze verspaningscalculator app voor meer berekeningen.

Product	RE (mm)	P			M			K			N			S			H		
		vc (m/min)	f (mm/rev)	ap (mm)	vc (m/min)	f (mm/rev)	ap (mm)	vc (m/min)	f (mm/rev)	ap (mm)	vc (m/min)	f (mm/rev)	ap (mm)	vc (m/min)	f (mm/rev)	ap (mm)			

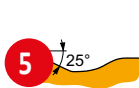

10 AL geometrie, zeer positieve uitvoering voor fijn nabewerken tot voorbereiden en voor ononderbroken tot licht onderbroken snedes.

CCGT 060202F-AL	HF7	0.2	-	-	-	-	-	-	-	-	-	360	0.12	1.0	-	-	-	-	-	-
CCGT 060204F-AL	T0315	0.4	-	-	-	-	-	-	-	-	-	300	0.24	1.0	-	-	-	-	-	-
CCGT 080302F-AL	T0315	0.2	-	-	-	-	-	-	-	-	-	360	0.12	1.0	-	-	-	-	-	-
CCGT 080304F-AL	HF7	0.4	-	-	-	-	-	-	-	-	-	300	0.24	1.0	-	-	-	-	-	-
	T0315	0.4	-	-	-	-	-	-	-	-	-	300	0.24	1.0	-	-	-	-	-	-
CCGT 09T302F-AL	HF7	0.2	-	-	-	-	-	-	-	-	-	360	0.12	1.0	-	-	-	-	-	-
	T0315	0.2	-	-	-	-	-	-	-	-	-	360	0.12	1.0	-	-	-	-	-	-
CCGT 09T304F-AL	HF7	0.4	-	-	-	-	-	-	-	-	-	300	0.24	1.5	-	-	-	-	-	-
	T0315	0.4	-	-	-	-	-	-	-	-	-	300	0.24	1.5	-	-	-	-	-	-
CCGT 09T308F-AL	HF7	0.8	-	-	-	-	-	-	-	-	-	200	0.48	1.5	-	-	-	-	-	-
	T0315	0.8	-	-	-	-	-	-	-	-	-	200	0.48	1.5	-	-	-	-	-	-
CCGT 120404F-AL	HF7	0.4	-	-	-	-	-	-	-	-	-	300	0.24	2.4	-	-	-	-	-	-
	T0315	0.4	-	-	-	-	-	-	-	-	-	300	0.24	2.4	-	-	-	-	-	-
CCGT 120408F-AL	HF7	0.8	-	-	-	-	-	-	-	-	-	200	0.48	2.4	-	-	-	-	-	-
	T0315	0.8	-	-	-	-	-	-	-	-	-	200	0.48	2.4	-	-	-	-	-	-

CCGT120404F-AL:T0315 Gebruik bij bestellen de volledige bestelcode!

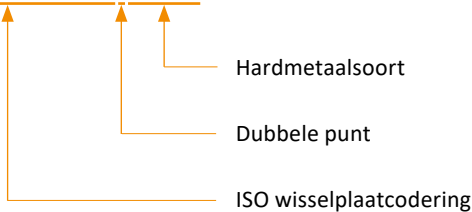



WISSELPLATEN - UITLEG PRODUCTPAGINA

Pos.	Omschrijving	Pos.	Omschrijving
1	Productfamiliecode	7	ISO code van de wisselplaat
2	Schematische afbeelding	8	Hardmetaalsoort
3	Tabel met wisselplaat afmetingen (mm)	9	Ingeschreven cirkel (mm)
4	Afbeelding	10	Omschrijving geometrie
5	Spaangroefvorm	11	Aanbevelingen materiaalgroep incl. snijsnelheid en voeding
6	Productkenmerken		

KOTTERKOPPEN EN BASISHOUDERS – PAGINA OVERZICHT

1 D75-BB

P M K N S H 2

PRAMET 3 S(P)



75° voorruw kotterkop, groot - Ø220 t/m Ø500mm

Hoogproductieve 75° grote kotterkop voor voorbereiden. Geschikt voor doorlopende-, blinde- en kruisgaten en afschuiven. Voor gebruik met wisselplaten van het CC-, TC- of CN-type en voor gatdiameters van Ø220 t/m Ø500 mm afhankelijk van de systeemgrootte (300 t/m 500 mm). Hoge nauwkeurigheid en reproduceerbaarheid.

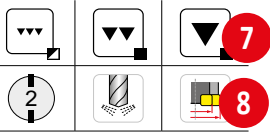
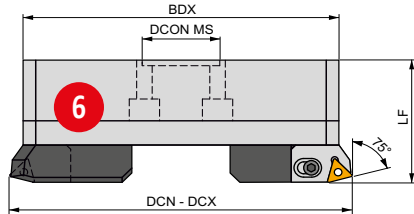

Product	CZC MS	DCN	DCX	BDX	DCON MS	LF													
	(mm)	(mm)	(mm)	(mm)	(mm)	(mm)													
D 30075 300	300	220.00	320.00	202	60.00	90.00	3CT 75 300	US 0625	HXK 5	TC.. 16T3..	US 0415-T15P	SDR T15P	HXK 5	HXK 4	9.40				
D 30075 402	300	220.00	320.00	202	60.00	90.00	3CT 75 402	US 0625	HXK 5	CC.. 1204..	US 0513-T20P	SDR T20P	HXK 5	HXK 4	9.37				
D 30075 402N	300	220.00	320.00	202	60.00	90.00	3CT 75 402 N	US 0625	HXK 5	CN.. 1204..	US 0613-H25	HXK 2.5	HXK 5	HXK 4	9.37				
D 40075 300	400	290.00	400.00	272	60.00	90.00	3CT 75 300	US 0625	HXK 5	TC.. 16T3..	US 0415-T15P	SDR T15P	HXK 5	HXK 4	9.40				
D 40075 402	400	290.00	400.00	272	60.00	90.00	3CT 75 402	US 0625	HXK 5	CC.. 1204..	US 0513-T20P	SDR T20P	HXK 5	HXK 4	9.37				
D 40075 402N	400	290.00	400.00	272	60.00	90.00	3CT 75 402 N	US 0625	HXK 5	CN.. 1204..	US 0613-H25	HXK 2.5	HXK 5	HXK 4	9.37				

1 69871-BS

PRAMET



Basishouder voor kotterkop, DIN 69871

DIN 69871 zeer stabiele gereedschapshouder (voor MTC) voor kotterkoppen in SK40 en SK50. Verschillende lengte gereedschapshouders beschikbaar. Koppelmaten 22 - 160 mm kunnen worden gebruikt in combinatie met EXT-BS verlengstukken, RED-BS reduceerstukken en LA-BS verloopstukken. Interne koelvloeistof beschikbaar. Voor toepassingen die een hoge nauwkeurigheid en herhaalbaarheid vereisen.

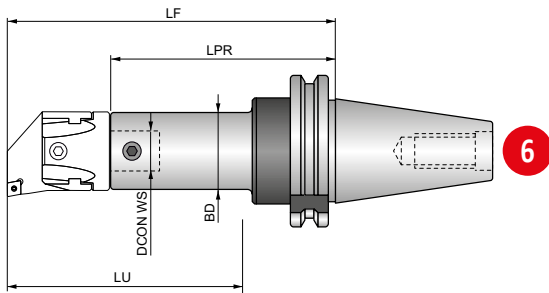

Product		CZC MS	BD	DCON WS	LF	LPR	LU				
		(mm)	(mm)	(mm)	(mm)	(mm)	(mm)				
AS 330 022 100 R		30	22	22.00	12.00	138.00	104	100.00	✓	US 0608	0.72
AS 330 027 055 R		30	27	27.00	15.00	90.00	48	55.00	✓	US 0609	0.56
AS 330 027 100 R		30	27	27.00	15.00	138.00	96	100.00	✓	US 0609	0.68
AS 330 060 R		30	27	32.00	20.00	138.00	96	100.00	✓	US 0609	0.68
AS 330 100 R		30	27	32.00	20.00	138.00	93	100.00	✓	US 0609	0.68
AS 340 022 080 R		40	22	22.00	12.00	118.00	84	80.00	✓	US 0608	1.14

Voorbeeldpagina met kotterkop en basishouder – de specifieke pagina kan enigszins afwijken



KOTTERKOPPEN EN BASISHOUDERS – PAGINA OVERZICHT

Pos.	Benaming	Pos.	Benaming
1	Codering van de kotterkop/basishouder	13	Cassette
2	Materiaalgroep waarvoor het gereedschap inzetbaar is	14	Klemschroef cassette
3	Klemsysteem van de wisselplaat	15	Sleutel voor spanschroef
4	Afbeelding	16	Wisselplaat groepen
5	Productomschrijving	17	Wisselplaatschroef
6	Schematische afbeelding	18	Sleutel voor wisselplaatschroef
7	Haalbare oppervlaktekwaliteit	19	Instelsleutel voor kotterkop
8	Productkenmerken	20	Blokkersleutel voor kotterkop
9	Product toepassingen	21	Gewicht (kg)
10	Gereedschapcodering ¹⁾	22	Interne koeling
11	Grootte aanduiding van de kotterkop/baar ²⁾	23	Klemschroef voor de kotterkop
12	Afmetingen gereedschap (mm)	24	Afmeting baar ³⁾

¹⁾ Gereedschapcodering is opgenomen in het technisch gedeelte

²⁾ Kotterkop en basishouder dienen dezelfde grootte aanduiding te hebben om op elkaar te passen

³⁾ Zie schematische afbeelding voor type baar



DORMER PRAMET



ELK MATERIAAL

Automatenstaal, roestvast staal, gietijzer, superlegeringen of non-ferro materialen: ze zitten allemaal in onze calculator-app. Download deze nu in uw app store.
Simply Reliable.

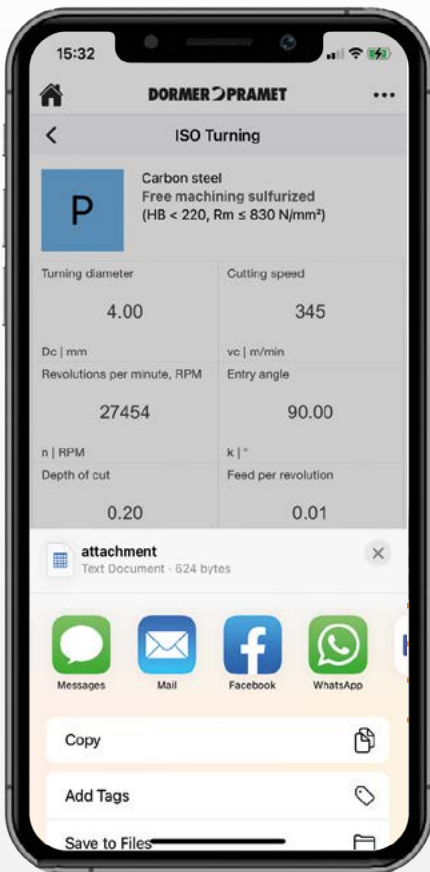



KOTTEREN – UITLEG PICTOGRAMMEN

ALGEMENE PICTOGRAMMEN

	Eerste keus gebruik		Nabewerken - zeer goede oppervlaktekwaliteit		Voorbewerken - onbepaalde oppervlaktekwaliteit
	Beperkte inzetbaarheid		Medium bewerking - goede oppervlaktekwaliteit		

ALGEMENE KENMERKEN

	1 effectieve tand per omwenteling		Verstelbare diameter
	2 effectieve tanden per omwenteling		

KOTTER BEWERKINGEN

	Blind gat boren / kotten		Trap boren		Afschuinen in een gat
	Kruisgat boren		Verzinken (afschuinen)		Opboren van doorlopend gat

KENMERKEN

	Eerste keus		Hogesnelheidsverspaning		Snikkant met fase
	Voor kortspanig materiaal		Lange uitsteeklengte		Afgeronde snijkant
	Voor moeilijk bewerkbare materialen (langspaning)		Dunnen wanden en slanke werkstukken		Afgeronde snijkant met dubbele fase
	Zware omstandigheden		Universele toepassing		Afgeronde snijkant met fase
					Scherpe snijkant

ANDERE





	Steilconus
--	------------

TECHNISCH GEDEELTE

	Voeding (mm/omw)		ISO 20-30: Lage snijsnelheid, beperkte stabiliteit (licht onderbroken snede)
	ISO 01-05: Zeer hoge snijsnelheid, uitstekende stabiliteit van machine en opspanning		ISO 30-40: Lage snijsnelheid, instabiliteit (onder-broken snede)
	ISO 05-10: Hoge snijsnelheid, goede stabiliteit van machine en opspanning		ISO 40-50: Zeer lage snijsnelheid, grote instabiliteit (zeer ongunstige bewerkingsomstandigheden)
	ISO 10-20: Gemiddelde snijsnelheid, licht beperkte stabiliteit (wisselende snedediepte)		



KOTTER SYSTEMEM



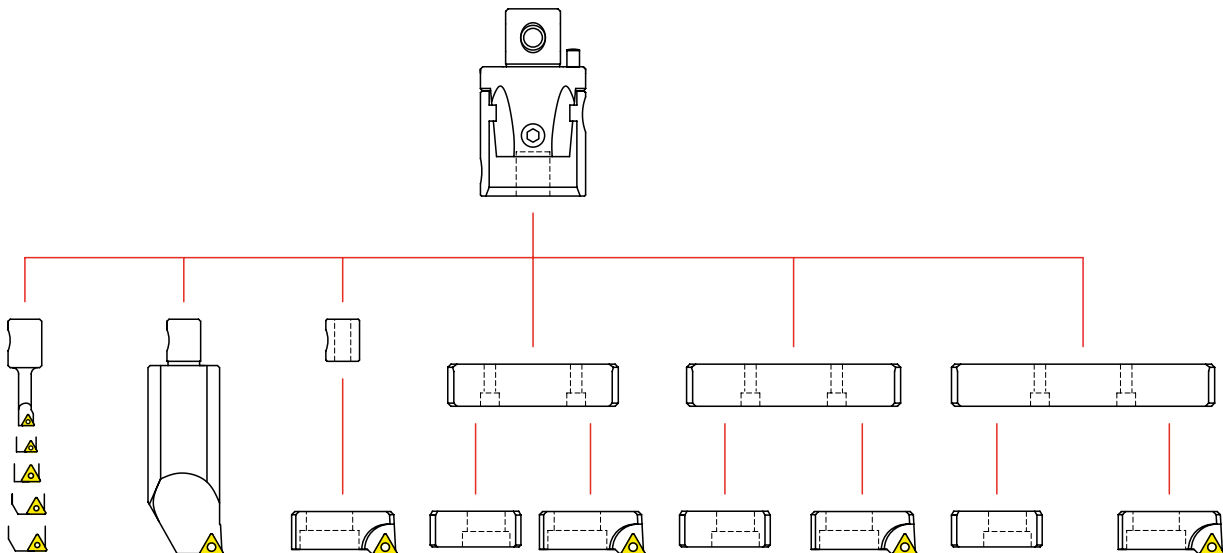

	VOORBEWERKINGS KOPPEN		
			
Omschrijving	D75 / D90	D75-C/D90-C	D75-BB/D90-BB
Kotter diameter	24 – 82	80 – 220	220 – 500
Gat tolerantie	IT9	IT9	IT9
Max. kotterdiepte	5×D	4×D	360 mm
Instelhoek	75° / 90°	75° / 90°	75° / 90°
Verstelnauwkeurigheid (mm/Ø)	–	–	–
	361, 364	362, 365	363, 366

KOTTERSETS – 420 – 427















KOTTER SYSTEEM

FIJN KOTTERKOPPEN			MICRO KOTTERKOPPEN	
				
F75/F90	F75-C/F90-C	F75-BB/F90-BB	MB-H	
24 – 82	80 – 220	220 – 500	8 – 38	
IT7	IT7	IT7	IT6	
5×D	4×D	–	104 mm	
75° / 90°	75° / 90°	75° / 90°	–	
0.002	0.002	0.002	0.002	
367, 370	368, 371	369, 372	373	

KOTTERBEITELS

ISO BARS	ISO BARS A042	CHAM-BS	CART-BS	INSERTI
				
 374	 375	 380	 378	 388



BASISHOUDERS

69871-BS ISO 30, 40, 50	BT-BS ISO 30, 40, 50	HSK-BS 50A, 63A, 100A	2080-BS ISO 40, 50	MOR-BS MORSE	WEL-BS WELDON
406	408	410	411	413	414

ACCESSORIES

EXT-BS	RED-BS	LA-BS
415	416	417

KOTTERSETS – 420 – 427





KOTTERKOPPEN

**KOTTERKOP CODERING**

1	2	3	4
D	042	75	402N

1		2	3	4	
Type gereedschap		Grootte	Instelhoek	Code van de wisselplaatzitting	
D	Vorbewerken	022	75	300	TC..16T3.
		027	90	400	CC..0602..
		032		401	CC..0803..
		042		402	CC..1204..
A	Nabewerken	054		409	CC..09T3..
		068		402N	CN..1204..
		085			
		100			
		200			
		300			
		400			
		500			



D75

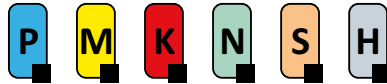

PRAMET

S(P)



75° voorruw kotterkop, klein - Ø24 t/m Ø82mm

Hoogproductieve 75° kleine kotterkop voor voorbereiden. Geschikt voor doorlopende-, blinde- en kruisgaten en afschuiven. Voor gebruik met wisselplaten van het CC-, TC- of CN-type en voor gatdiameters van Ø24 t/m Ø82 mm afhankelijk van de systeemgrootte (22 t/m 54 mm). Hoge nauwkeurigheid en reproduceerbaarheid.

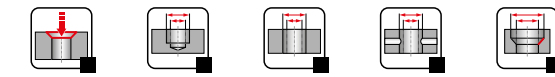
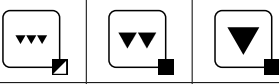
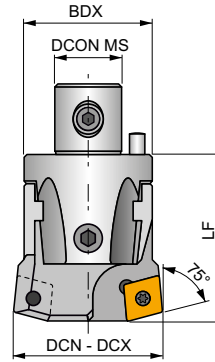

Product	CZC MS	DCN	DCX	BDX	DCON MS	LF									
D 02275 400	22	24.00	30.00	22	12.00	34.00	CC.. 0602..	US 0206-T08P	SDR T08P	HXK 2	HXK 3				0.10
D 02775 401	27	29.00	40.00	27	15.00	42.00	CC.. 0803..	US 0307-T10P	SDR T10P	HXK 2	HXK 4				0.17
D 02775 409	27	29.00	40.00	27	15.00	42.00	CC.. 09T3..	US 0408-T15P	SDR T15P	HXK 2	HXK 4				0.17
D 03275 401	32	39.00	50.00	32	20.00	45.00	CC.. 0803..	US 0307-T10P	SDR T10P	HXK 2.5	HXK 4				0.27
D 03275 409	32	39.00	50.00	32	20.00	45.00	CC.. 09T3..	US 0408-T15P	SDR T15P	HXK 2.5	HXK 4				0.27
D 04275 300	42	49.00	65.00	42	24.00	56.00	TC.. 16T3..	US 0415-T15P	SDR T15P	HXK 3	HXK 5				0.54
D 04275 402	42	49.00	65.00	42	24.00	56.00	CC.. 1204..	US 0513-T20P	SDR T20P	HXK 3	HXK 5				0.54
D 04275 402N	42	53.00	65.00	42	24.00	56.00	CN.. 1204..	US 0613-H25	HXK 2.5	HXK 3	HXK 5				0.53
D 05475 300	54	63.00	82.00	54	28.00	66.00	TC.. 16T3..	US 0415-T15P	SDR T15P	HXK 3	HXK 6				1.07
D 05475 402	54	63.00	82.00	54	28.00	66.00	CC.. 1204..	US 0513-T20P	SDR T20P	HXK 3	HXK 6				1.07
D 05475 402N	54	63.00	82.00	54	28.00	66.00	CN.. 1204..	US 0613-H25	HXK 2.5	HXK 3	HXK 6				1.03



D75-C

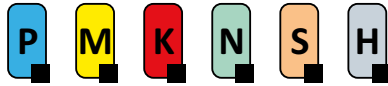

PRAMET

S(P)



75° voorruw kotterkop, medium - Ø80 t/m Ø220mm

Hoogproductieve 75° middelgrote kotterkop voor voorbereiden. Geschikt voor doorlopende-, blinde- en kruisgaten en afschuiven. Voor gebruik met wisselplaten van het CC-, TC- of CN-type en voor gatdiameters van Ø80 t/m Ø220 mm afhankelijk van de systeemgrootte (68 t/m 200 mm). Hoge nauwkeurigheid en reproduceerbaarheid.

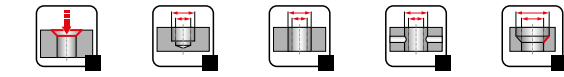
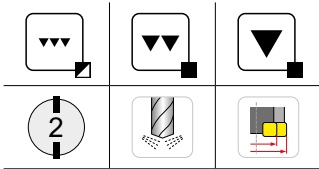
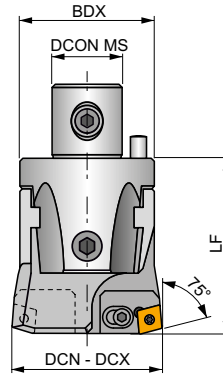

Product	CZC MS	DCN	DCX	BDX	DCON MS	LF										
		(mm)	(mm)	(mm)	(mm)	(mm)										
D 06875 300	68	80.00	102.00	68	36.00	86.00	2CT 75 300	US 0616	HXK 5	TC.. 16T3..	US 0408-T15P	SDR T15P	HXK 4	HXK 8	2.16	
D 06875 402	68	80.00	102.00	68	36.00	86.00	2CT 75 402	US 0616	HXK 5	CC.. 1204..	US 0509-T20P	SDR T20P	HXK 4	HXK 8	2.15	
D 06875 402N	68	80.00	102.00	68	36.00	86.00	2CT 75 402 N	US 0616	HXK 5	CN.. 1204..	US 0613-H25	HXK 2.5	HXK 4	HXK 8	2.21	
D 08575 300	85	100.00	125.00	85	50.00	100.00	3CT 75 300	US 0625	HXK 5	TC.. 16T3..	US 0415-T15P	SDR T15P	HXK 5	HXK 8	4.16	
D 08575 402	85	100.00	125.00	85	50.00	100.00	3CT 75 402	US 0625	HXK 5	CC.. 1204..	US 0513-T20P	SDR T20P	HXK 5	HXK 8	4.13	
D 08575 402N	85	100.00	125.00	85	50.00	100.00	3CT 75 402 N	US 0625	HXK 5	CN.. 1204..	US 0613-H25	HXK 2.5	HXK 5	HXK 8	4.23	
D 10075 300	100	125.00	160.00	110	60.00	100.00	3CT 75 300	US 0625	HXK 5	TC.. 16T3..	US 0415-T15P	SDR T15P	HXK 5	HXK 8	6.57	
D 10075 402	100	125.00	160.00	110	60.00	100.00	3CT 75 402	US 0625	HXK 5	CC.. 1204..	US 0513-T20P	SDR T20P	HXK 5	HXK 8	6.55	
D 10075 402N	100	125.00	160.00	110	60.00	100.00	3CT 75 402 N	US 0625	HXK 5	CN.. 1204..	US 0613-H25	HXK 2.5	HXK 5	HXK 8	6.57	
D 20075 300	200	160.00	220.00	145	60.00	100.00	3CT 75 300	US 0625	HXK 5	TC.. 16T3..	US 0415-T15P	SDR T15P	HXK 5	HXK 8	8.87	
D 20075 402	200	160.00	220.00	145	60.00	100.00	3CT 75 402	US 0625	HXK 5	CC.. 1204..	US 0513-T20P	SDR T20P	HXK 5	HXK 8	8.88	
D 20075 402N	200	160.00	220.00	145	60.00	100.00	3CT 75 402 N	US 0625	HXK 5	CN.. 1204..	US 0613-H25	HXK 2.5	HXK 5	HXK 8	8.95	



D75-BB

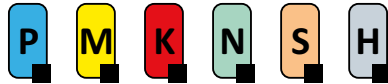

PRAMET

S(P)



75° voorruw kotterkop, groot - Ø220 t/m Ø500mm

Hoogproductieve 75° grote kotterkop voor voorbereiden. Geschikt voor doorlopende-, blinde- en kruisgaten en afschuiven. Voor gebruik met wisselplaten van het CC-, TC- of CN-type en voor gatdiameters van Ø220 t/m Ø500 mm afhankelijk van de systeemgrootte (300 t/m 500 mm). Hoge nauwkeurigheid en reproduceerbaarheid.

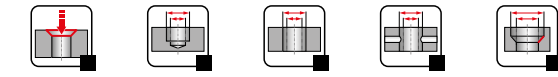
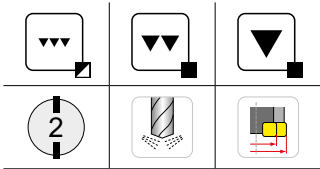
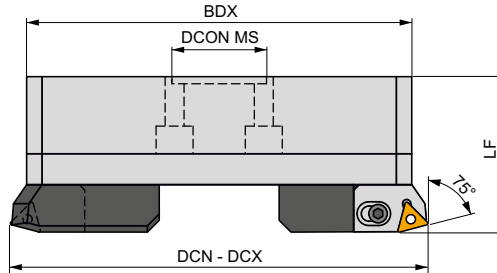

Product	CZC MS	DCN	DCX	BDX	DCON MS	LF									
		(mm)	(mm)	(mm)	(mm)	(mm)									
D 30075 300	300	220.00	320.00	202	60.00	90.00	3CT 75 300	US 0625	HXK 5	TC.. 16T3..	US 0415-T15P	SDRT15P	HXK 5	HXK 4	9.40
D 30075 402	300	220.00	320.00	202	60.00	90.00	3CT 75 402	US 0625	HXK 5	CC.. 1204..	US 0513-T20P	SDRT20P	HXK 5	HXK 4	9.37
D 30075 402N	300	220.00	320.00	202	60.00	90.00	3CT 75 402 N	US 0625	HXK 5	CN.. 1204..	US 0613-H25	HXK 2.5	HXK 5	HXK 4	9.37
D 40075 300	400	290.00	400.00	272	60.00	90.00	3CT 75 300	US 0625	HXK 5	TC.. 16T3..	US 0415-T15P	SDRT15P	HXK 5	HXK 4	12.92
D 40075 402	400	290.00	400.00	272	60.00	90.00	3CT 75 402	US 0625	HXK 5	CC.. 1204..	US 0513-T20P	SDRT20P	HXK 5	HXK 4	12.95
D 40075 402N	400	290.00	400.00	272	60.00	90.00	3CT 75 402 N	US 0625	HXK 5	CN.. 1204..	US 0613-H25	HXK 2.5	HXK 5	HXK 4	12.98
D 50075 300	500	370.00	500.00	352	60.00	90.00	3CT 75 300	US 0625	HXK 5	TC.. 16T3..	US 0415-T15P	SDRT15P	HXK 5	HXK 4	16.74
D 50075 402	500	370.00	500.00	352	60.00	90.00	3CT 75 402	US 0625	HXK 5	CC.. 1204..	US 0513-T20P	SDRT20P	HXK 5	HXK 4	16.74
D 50075 402N	500	370.00	500.00	352	60.00	90.00	3CT 75 402 N	US 0625	HXK 5	CN.. 1204..	US 0613-H25	HXK 2.5	HXK 5	HXK 4	16.74



D90



PRAMET

S(P)



90° voorruw kotterkop, klein - Ø24 t/m Ø82mm

Hoogproductieve 90° kleine kotterkop voor voorbereiden. Geschikt voor doorlopende-, blinde- en kruisgaten en afschuiven. Voor gebruik met wisselplaten van het CC-, TC- of CN-type en voor gatdiameters van Ø24 t/m Ø82 mm afhankelijk van de systeemgrootte (22 t/m 54 mm). Hoge nauwkeurigheid en reproduceerbaarheid.

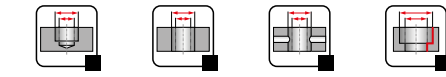
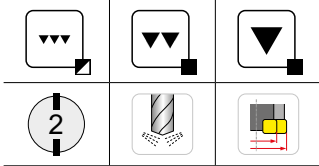
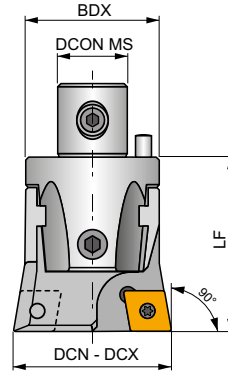

Product	CZC MS	DCN	DCX	BDX	DCON MS	LF						
D 02290 400	22	24.00	30.00	22	12.00	34.00	CC.. 0602..	US 0206-T08P	SDT T08P	HXX 2	HXX 3	0.10
D 02790 401	27	29.00	40.00	27	15.00	42.00	CC.. 0803..	US 0307-T10P	SDR T10P	HXX 2	HXX 4	0.17
D 02790 409	27	29.00	40.00	27	15.00	42.00	CC.. 09T3..	US 0408-T15P	SDR T15P	HXX 2	HXX 4	0.17
D 03290 401	32	39.00	50.00	32	20.00	45.00	CC.. 0803..	US 0307-T10P	SDR T10P	HXX 2.5	HXX 4	0.03
D 03290 409	32	39.00	50.00	32	20.00	45.00	CC.. 09T3..	US 0408-T15P	SDR T15P	HXX 2.5	HXX 4	0.27
D 04290 300	42	49.00	65.00	42	24.00	56.00	TC.. 16T3..	US 0415-T15P	SDR T15P	HXX 3	HXX 5	0.54
D 04290 402	42	49.00	65.00	42	24.00	56.00	CC.. 1204..	US 0513-T20P	SDR T20P	HXX 3	HXX 5	0.54
D 04290 402N	42	53.00	65.00	42	24.00	56.00	CN.. 1204..	US 0613-H25	HXX 2.5	HXX 3	HXX 5	0.53
D 05490 300	54	63.00	82.00	54	28.00	66.00	TC.. 16T3..	US 0415-T15P	SDR T15P	HXX 3	HXX 6	1.06
D 05490 402	54	63.00	82.00	54	28.00	66.00	CC.. 1204..	US 0513-T20P	SDR T20P	HXX 3	HXX 6	1.06
D 05490 402N	54	63.00	82.00	54	28.00	66.00	CN.. 1204..	US 0613-H25	HXX 2.5	HXX 3	HXX 6	1.06



D90-C

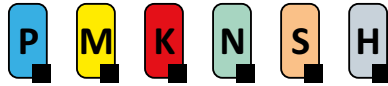

PRAMET

S(P)



90° voorruw kotterkop, medium - Ø80 t/m Ø220mm

Hoogproductieve 90° middelgrote kotterkop voor voorbereiden. Geschikt voor doorlopende-, blinde- en kruisgaten en afschuiven. Voor gebruik met wisselplaten van het CC-, TC- of CN-type en voor gatdiameters van Ø80 t/m Ø220 mm afhankelijk van de systeemgrootte (68 t/m 200 mm). Hoge nauwkeurigheid en reproduceerbaarheid.

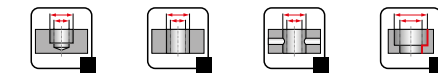
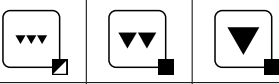
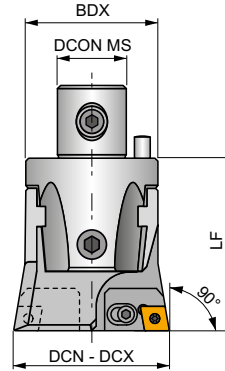

Product	CZC MS	DCN	DCX	BDX	DCON MS	LF										
		(mm)	(mm)	(mm)	(mm)	(mm)										kg
D 06890 300	68	80.00	102.00	68	36.00	86.00	2CT 90 300	US 0616	HXK 5	TC.. 16T3..	US 0408-T15P	SDR T15P	HXK 4	HXK 8		2.17
D 06890 402	68	80.00	102.00	68	36.00	86.00	2CT 90 402	US 0616	HXK 5	CC.. 1204..	US 0509-T20P	SDR T20P	HXK 4	HXK 8		2.15
D 06890 402N	68	80.00	102.00	68	36.00	86.00	2CT 90 402 N	US 0616	HXK 5	CN.. 1204..	US 0613-H25	HXK 2.5	HXK 4	HXK 8		2.18
D 08590 300	85	100.00	125.00	85	50.00	100.00	3CT 90 300	US 0625	HXK 5	TC.. 16T3..	US 0415-T15P	SDR T15P	HXK 5	HXK 8		4.52
D 08590 402	85	100.00	125.00	85	50.00	100.00	3CT 90 402	US 0625	HXK 5	CC.. 1204..	US 0513-T20P	SDR T20P	HXK 5	HXK 8		4.12
D 08590 402 N	85	100.00	125.00	85	50.00	100.00	3CT 90 402 N	US 0625	HXK 5	CN.. 1204..	US 0613-H25	HXK 2.5	HXK 5	HXK 8		4.17
D 10090 300	100	125.00	160.00	110	60.00	100.00	3CT 90 300	US 0625	HXK 5	TC.. 16T3..	US 0415-T15P	SDR T15P	HXK 5	HXK 8		6.54
D 10090 402	100	125.00	160.00	110	60.00	100.00	3CT 90 402	US 0625	HXK 5	CC.. 1204..	US 0513-T20P	SDR T20P	HXK 5	HXK 8		6.56
D 10090 402 N	100	125.00	160.00	110	60.00	100.00	3CT 90 402 N	US 0625	HXK 5	CN.. 1204..	US 0613-H25	HXK 2.5	HXK 5	HXK 8		6.40
D 20090 300	200	160.00	220.00	145	60.00	100.00	3CT 90 300	US 0625	HXK 5	TC.. 16T3..	US 0415-T15P	SDR T15P	HXK 5	HXK 8		8.90
D 20090 402	200	160.00	220.00	145	60.00	100.00	3CT 90 402	US 0625	HXK 5	CC.. 1204..	US 0513-T20P	SDR T20P	HXK 5	HXK 8		8.89
D 20090 402 N	200	160.00	220.00	145	60.00	100.00	3CT 90 402 N	US 0625	HXK 5	CN.. 1204..	US 0613-H25	HXK 2.5	HXK 5	HXK 8		8.91



D90-BB

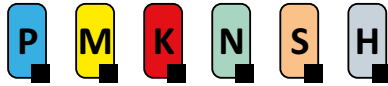

PRAMET

S(P)



90° voorruw kotterkop, groot - Ø220 t/m Ø500mm

Hoogproductieve 90° grote kotterkop voor voorbereiden. Geschikt voor doorlopende-, blinde- en kruisgaten en afschuiven. Voor gebruik met wisselplaten van het CC-, TC- of CN-type en voor gatdiameters van Ø220 t/m Ø500 mm afhankelijk van de systeemgrootte (300 t/m 500 mm). Hoge nauwkeurigheid en reproduceerbaarheid.

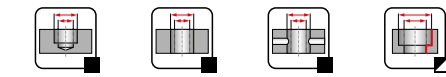
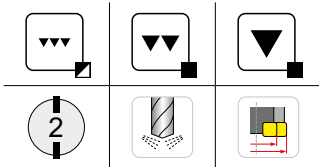
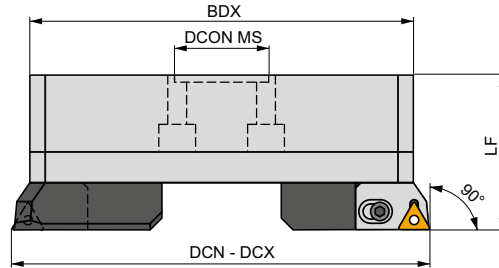

Product	CZC MS	DCN	DCX	BDX	DCON MS	LF										
		(mm)	(mm)	(mm)	(mm)	(mm)										
D 30090 300	300	220.00	320.00	202	60.00	90.00	3CT 90 300	US 0625	HXX 5	TC.. 16T3..	US 0415-T15P	SDRT15P	HXX 5	HXX 4	9.45	
D 30090 402	300	220.00	320.00	202	60.00	90.00	3CT 90 402	US 0625	HXX 5	CC.. 1204..	US 0513-T20P	SDRT20P	HXX 5	HXX 4	9.47	
D 30090 402 N	300	220.00	320.00	202	60.00	90.00	3CT 90 402 N	US 0625	HXX 5	CN.. 1204..	US 0613-H25	HXX 2.5	HXX 5	HXX 4	9.56	
D 40090 300	400	290.00	400.00	272	60.00	90.00	3CT 90 300	US 0625	HXX 5	TC.. 16T3..	US 0415-T15P	SDRT15P	HXX 5	HXX 4	12.98	
D 40090 402	400	290.00	400.00	272	60.00	90.00	3CT 90 402	US 0625	HXX 5	CC.. 1204..	US 0513-T20P	SDRT20P	HXX 5	HXX 4	12.98	
D 40090 402 N	400	290.00	400.00	272	60.00	90.00	3CT 90 402 N	US 0625	HXX 5	CN.. 1204..	US 0613-H25	HXX 2.5	HXX 5	HXX 4	12.98	
D 50090 300	500	370.00	500.00	352	60.00	90.00	3CT 90 300	US 0625	HXX 5	TC.. 16T3..	US 0415-T15P	SDRT15P	HXX 5	HXX 4	16.58	
D 50090 402	500	370.00	500.00	352	60.00	90.00	3CT 90 402	US 0625	HXX 5	CC.. 1204..	US 0513-T20P	SDRT20P	HXX 5	HXX 4	16.74	
D 50090 402 N	500	370.00	500.00	352	60.00	90.00	3CT 90 402 N	US 0625	HXX 5	CN.. 1204..	US 0613-H25	HXX 2.5	HXX 5	HXX 4	16.63	



F75

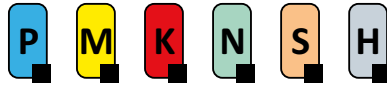

PRAMET

S



75° nabewerkings koterkop, klein - Ø24 t/m Ø82mm

Hoogproductieve 75° kleine koterkop voor nabewerken. Geschikt voor doorlopende-, blinde- en kruisgaten en afschuinen d.m.v. circulaire interpolatie. Voor gebruik met wisselplaten van het CC-, of TC-type en voor gatdiameters van Ø24 t/m Ø82 mm afhankelijk van de systeemgrootte (22 t/m 54mm). Hoge nauwkeurigheid en reproduceerbaarheid.

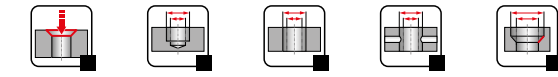
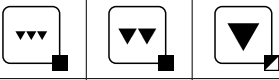
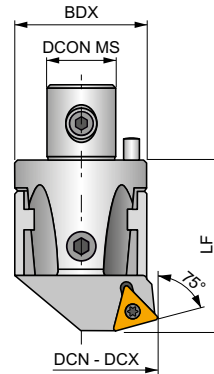

Product	CZC MS	DCN	DCX	BDX	DCON MS	LF									
		(mm)	(mm)	(mm)	(mm)	(mm)									
A 02275 400	22	24.00	30.00	22	12.00	34.00	CC.. 0602..	US 0206-T08P	SDR T08P	HXK 2	HXK 3				0.10
A 02775 401	27	29.00	40.00	27	15.00	42.00	CC.. 0803..	US 0307-T10P	SDR T10P	HXK 2	HXK 4				0.17
A 02775 409	27	29.00	40.00	27	15.00	42.00	CC.. 09T3..	US 0408-T15P	SDR T15P	HXK 2	HXK 4				0.17
A 03275 401	32	39.00	50.00	32	20.00	45.00	CC.. 0803..	US 0307-T10P	SDR T10P	HXK 2.5	HXK 4				0.26
A 03275 409	32	39.00	50.00	32	20.00	45.00	CC.. 09T3..	US 0408-T15P	SDR T15P	HXK 2.5	HXK 4				0.26
A 04275 300	42	49.00	65.00	42	24.00	56.00	TC.. 16T3..	US 0307-T10P	SDR T10P	HXK 3	HXK 5				0.51
A 05475 300	54	63.00	82.00	54	28.00	66.00	TC.. 16T3..	US 0415-T15P	SDR T15P	HXK 3	HXK 6				1.01



F75-C

P M K N S H

PRAMET

S(P)



75° nabewerkings kotterkop, medium - Ø80 t/m Ø220mm

Hoogproductieve 75° middelgrote kotterkop voor nabewerken. Geschikt voor doorlopende-, blinde- en kruisgaten en afschuinen d.m.v. circulaire interpolatie. Voor gebruik met wisselplaten van het CC-, TC- of CN-type en voor gatdiameters van Ø80 t/m Ø220 mm afhankelijk van de systeemgrootte (68 t/m 200mm). Hoge nauwkeurigheid en reproduceerbaarheid.

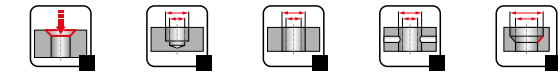
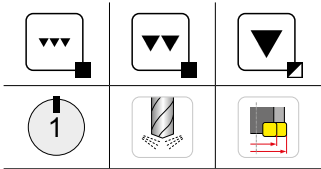
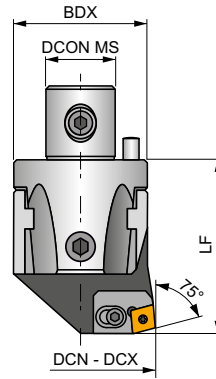

Product	CZC MS	DCN	DCX	BDX	DCON MS	LF									
A 06875 300	68	80.00	102.00	68	36.00	86.00	2CT 75 300	US 0616	HXK 5	TC.. 16T3..	US 0408-T15P	SDRT15P	HXK 5	HXK 8	2.02
A 06875 402	68	80.00	102.00	68	36.00	86.00	2CT 75 402	US 0616	HXK 5	CC.. 1204..	US 0509-T20P	SDRT20P	HXK 5	HXK 8	2.03
A 06875 402 N	68	80.00	102.00	68	36.00	86.00	2CT 75 402 N	US 0616	HXK 5	CN.. 1204..	US 0613-H25	HXK 2.5	HXK 5	HXK 8	2.04
A 08575 300	85	100.00	125.00	85	50.00	100.00	3CT 75 300	US 0625	HXK 5	TC.. 16T3..	US 0415-T15P	SDRT15P	HXK 6	HXK 8	3.89
A 08575 402	85	100.00	125.00	85	50.00	100.00	3CT 75 402	US 0625	HXK 5	CC.. 1204..	US 0513-T20P	SDRT20P	HXK 6	HXK 8	3.88
A 08575 402 N	85	100.00	125.00	85	50.00	100.00	3CT 75 402 N	US 0625	HXK 5	CN.. 1204..	US 0613-H25	HXK 2.5	HXK 6	HXK 8	3.90
A 10075 300	100	125.00	160.00	110	60.00	100.00	3CT 75 300	US 0625	HXK 5	TC.. 16T3..	US 0415-T15P	SDRT15P	HXK 6	HXK 8	6.22
A 10075 402	100	125.00	160.00	110	60.00	100.00	3CT 75 402	US 0625	HXK 5	CC.. 1204..	US 0513-T20P	SDRT20P	HXK 6	HXK 8	6.24
A 10075 402 N	100	125.00	160.00	110	60.00	100.00	3CT 75 402 N	US 0625	HXK 5	CN.. 1204..	US 0613-H25	HXK 2.5	HXK 6	HXK 8	6.25
A 20075 300	200	160.00	220.00	145	60.00	100.00	3CT 75 300	US 0625	HXK 5	TC.. 16T3..	US 0415-T15P	SDRT15P	HXK 6	HXK 8	8.30
A 20075 402	200	160.00	220.00	145	60.00	100.00	3CT 75 402	US 0625	HXK 5	CC.. 1204..	US 0513-T20P	SDRT20P	HXK 6	HXK 8	8.33
A 20075 402 N	200	160.00	220.00	145	60.00	100.00	3CT 75 402 N	US 0625	HXK 5	CN.. 1204..	US 0613-H25	HXK 2.5	HXK 6	HXK 8	8.33



F75-BB

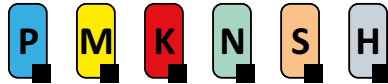

PRAMET

S(P)



75° nabewerkings kotterkop, groot - Ø220 t/m Ø500mm

Hoogproductieve 75° grote kotterkop voor nabewerken. Geschikt voor doorlopende-, blinde- en kruisgaten en afkanten d.m.v. circulaire interpolatie. Voor gebruik met wisselplaten van het CC-, TC- of CN-type en voor gatdiameters van Ø220 t/m Ø500 mm afhankelijk van de systeemgrootte (300 t/m 500mm). Hoge nauwkeurigheid en reproduceerbaarheid.

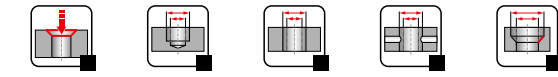
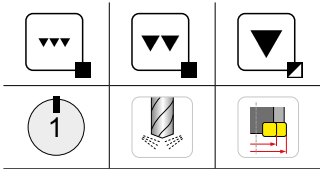
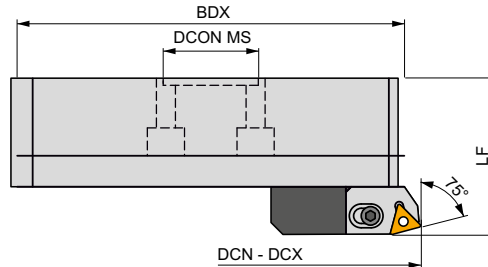

Product	CZC MS	DCN	DCX	BDX	DCON MS	LF									kg
		(mm)	(mm)	(mm)	(mm)	(mm)									
A 30075 300	300	220.00	320.00	202	60.00	90.00	3CT 75 300	US 0625	HXK 5	TC.. 16T3..	US 0415-T15P	SDR T15P	HXK 5	HXK 4	8.75
A 30075 402	300	220.00	320.00	202	60.00	90.00	3CT 75 402	US 0625	HXK 5	CC.. 1204..	US 0513-T20P	SDR T20P	HXK 5	HXK 4	8.75
A 30075 402 N	300	220.00	320.00	202	60.00	90.00	3CT 75 402 N	US 0625	HXK 5	CN.. 1204..	US 0613-H25	HXK 2.5	HXK 5	HXK 4	8.30
A 40075 300	400	290.00	400.00	272	60.00	90.00	3CT 75 300	US 0625	HXK 5	TC.. 16T3..	US 0415-T15P	SDR T15P	HXK 5	HXK 4	12.20
A 40075 402	400	290.00	400.00	272	60.00	90.00	3CT 75 402	US 0625	HXK 5	CC.. 1204..	US 0513-T20P	SDR T20P	HXK 5	HXK 4	12.20
A 40075 402 N	400	290.00	400.00	272	60.00	90.00	3CT 75 402 N	US 0625	HXK 5	CN.. 1204..	US 0613-H25	HXK 2.5	HXK 5	HXK 4	12.15
A 50075 300	500	370.00	500.00	352	60.00	90.00	3CT 75 300	US 0625	HXK 5	TC.. 16T3..	US 0415-T15P	SDR T15P	HXK 5	HXK 4	16.31
A 50075 402	500	370.00	500.00	352	60.00	90.00	3CT 75 402	US 0625	HXK 5	CC.. 1204..	US 0513-T20P	SDR T20P	HXK 5	HXK 4	16.31
A 50075 402 N	500	370.00	500.00	352	60.00	90.00	3CT 75 402 N	US 0625	HXK 5	CN.. 1204..	US 0613-H25	HXK 2.5	HXK 5	HXK 4	16.00

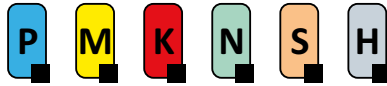
**F90**

PRAMET

S(P)

**90° nabewerkings kotterkop, klein - Ø24 t/m Ø82mm**

Hoogproductieve 90° kleine kotterkop voor voorbereiden. Geschikt voor doorlopende-, blinde- en kruisgaten en afschuiven. Voor gebruik met wisselplaten van het CC-, TC- of CN-type en voor gatdiameters van Ø24 t/m Ø82 mm afhankelijk van de systeemgrootte (22 t/m 54mm). Hoge nauwkeurigheid en reproduceerbaarheid.

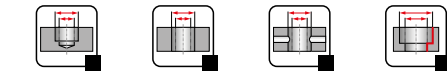
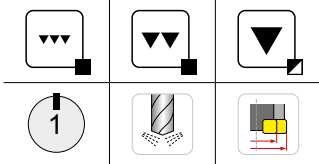
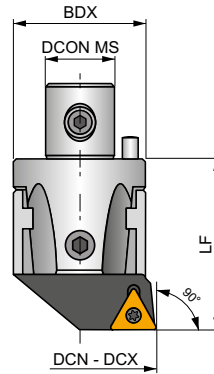

Product	CZC MS	DCN	DCX	BDX	DCON MS	LF						
		(mm)	(mm)	(mm)	(mm)	(mm)						
A 02290 400	22	24.00	30.00	22	12.00	34.00	CC.. 0602..	US 0206-T08P	SDR T08P	HXK 2	HXK 3	0.10
A 02790 401	27	29.00	40.00	27	15.00	42.00	CC.. 0803..	US 0307-T10P	SDR T10P	HXK 2	HXK 4	0.17
A 02790 409	27	29.00	40.00	27	15.00	42.00	CC.. 09T3..	US 0408-T15P	SDR T15P	HXK 2	HXK 4	0.16
A 03290 300	32	39.00	50.00	32	20.00	45.00	TC.. 16T3..	US 0408-T15P	SDR T15P	HXK 2.5	HXK 4	0.26
A 03290 401	32	39.00	50.00	32	20.00	45.00	CC.. 0803..	US 0206-T08P	SDR T08P	HXK 2.5	HXK 4	0.26
A 03290 409	32	39.00	50.00	32	20.00	45.00	CC.. 09T3..	US 0408-T15P	SDR T15P	HXK 2.5	HXK 4	0.26
A 04290 300	42	49.00	65.00	42	24.00	56.00	TC.. 16T3..	US 0415-T15P	SDR T15P	HXK 3	HXK 5	0.51
A 04290 402	42	49.00	65.00	42	24.00	56.00	CC.. 1204..	US 0513-T20P	SDR T20P	HXK 3	HXK 5	0.51
A 04290 402 N	42	49.00	65.00	42	24.00	56.00	CN.. 1204..	US 0613-H25	HXK 2.5	HXK 3	HXK 5	0.50
A 05490 300	54	63.00	82.00	54	28.00	66.00	TC.. 16T3..	US 0415-T15P	SDR T15P	HXK 3	HXK 6	1.01
A 05490 402	54	63.00	82.00	54	28.00	66.00	CC.. 1204..	US 0513-T20P	SDR T20P	HXK 3	HXK 6	1.03
A 05490 402 N	54	63.00	82.00	54	28.00	66.00	CN.. 1204..	US 0613-H25	HXK 2.5	HXK 3	HXK 6	1.01



F90-C



PRAMET

S(P)



90° nabewerkings koterkop, medium - Ø80 t/m Ø220mm

Hoogproductieve 90° middelgrote koterkop voor nabewerken. Geschikt voor doorlopende-, blinde- en kruisgaten en afschuinen. Voor gebruik met wisselplaten van het CC-, TC- of CN-type en voor gatdiameters van Ø80 t/m Ø220 mm afhankelijk van de systeemgrootte (68 t/m 145 mm). Hoge nauwkeurigheid en reproduceerbaarheid.

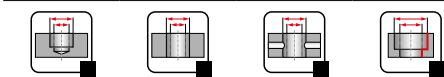
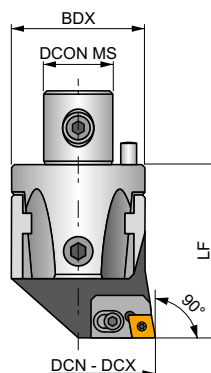

Product	CZC MS	DCN	DCX	BDX	DCON MS	LF									
		(mm)	(mm)	(mm)	(mm)	(mm)								kg	
A 06890 300	68	80.00	102.00	68	36.00	86.00	2CT 90 300	US 0616	HXX 5	TC.. 16T3..	US 0408-T15P	SDR T15P	HXX 5	HXX 8	2.03
A 06890 402	68	80.00	102.00	68	36.00	86.00	2CT 90 402	US 0616	HXX 5	CC.. 1204..	US 0509-T15P	SDR T15P	HXX 5	HXX 8	2.03
A 06890 402 N	68	80.00	102.00	68	36.00	86.00	2CT 90 402 N	US 0616	HXX 5	CN.. 1204..	US 0613-H25	HXX 2.5	HXX 5	HXX 8	2.60
A 08590 300	85	100.00	125.00	85	50.00	100.00	3CT 90 300	US 0625	HXX 5	TC.. 16T3..	US 0415-T15P	SDR T15P	HXX 6	HXX 8	3.90
A 08590 402	85	100.00	125.00	85	50.00	100.00	3CT 90 402	US 0625	HXX 5	CC.. 1204..	US 0513-T20P	SDR T20P	HXX 6	HXX 8	3.88
A 08590 402 N	85	100.00	125.00	85	50.00	100.00	3CT 90 402 N	US 0625	HXX 5	CN.. 1204..	US 0613-H25	HXX 2.5	HXX 6	HXX 8	4.04
A 10090 300	100	125.00	160.00	100	60.00	100.00	3CT 90 300	US 0625	HXX 5	TC.. 16T3..	US 0415-T15P	SDR T15P	HXX 6	HXX 8	6.24
A 10090 402	100	125.00	160.00	100	60.00	100.00	3CT 90 402	US 0625	HXX 5	CC.. 1204..	US 0513-T20P	SDR T20P	HXX 6	HXX 8	6.24
A 10090 402 N	100	125.00	160.00	100	60.00	100.00	3CT 90 402 N	US 0625	HXX 5	CN.. 1204..	US 0613-H25	HXX 2.5	HXX 6	HXX 8	6.26
A 20090 300	200	160.00	220.00	145	60.00	100.00	3CT 90 300	US 0625	HXX 5	TC.. 16T3..	US 0415-T15P	SDR T15P	HXX 6	HXX 8	8.30
A 20090 402	200	160.00	220.00	145	60.00	100.00	3CT 90 402	US 0625	HXX 5	CC.. 1204..	US 0513-T20P	SDR T20P	HXX 6	HXX 8	8.29
A 20090 402 N	200	160.00	220.00	145	60.00	100.00	3CT 90 402 N	US 0625	HXX 5	CN.. 1204..	US 0613-H25	HXX 2.5	HXX 6	HXX 8	8.33



F90-BB



PRAMET

S(P)



90° nabewerkings kotterkop, groot - Ø220 t/m Ø500mm

Hoogproductieve 90° grote kotterkop voor nabewerken. Geschikt voor doorlopende-, blinde- en kruisgaten en afschuinen. Voor gebruik met wisselplaten van het CC-, TC- of CN-type en voor gatdiameters van Ø220 t/m Ø500 mm afhankelijk van de systeemgrootte (202 t/m 352mm). Hoge nauwkeurigheid en reproduceerbaarheid.

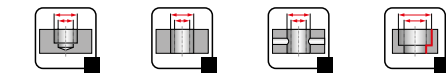
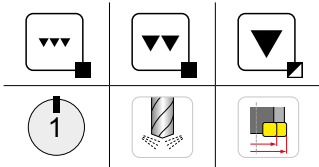
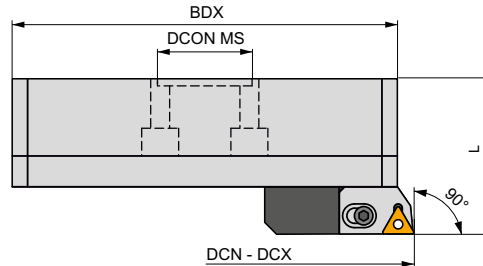

Product	CZC MS	DCN	DCX	BDX	DCON MS	LF									
		(mm)	(mm)	(mm)	(mm)	(mm)									
A 30090 300	300	220.00	320.00	202	60.00	90.00	3CT 90 300	US 0625	HXK 5	TC.. 16T3..	US 0415-T15P	SDRT15P	HXK 5	HXK 4	8.74
A 30090 402	300	220.00	320.00	202	60.00	90.00	3CT 90 402	US 0625	HXK 5	CC.. 1204..	US 0513-T20P	SDRT20P	HXK 5	HXK 4	8.82
A 30090 402 N	300	220.00	320.00	202	60.00	90.00	3CT 90 402 N	US 0625	HXK 5	CN.. 1204..	US 0613-H25	HXK 2.5	HXK 5	HXK 4	8.75
A 40090 300	400	290.00	400.00	272	60.00	90.00	3CT 90 300	US 0625	HXK 5	TC.. 16T3..	US 0415-T15P	SDRT15P	HXK 5	HXK 4	12.19
A 40090 402	400	290.00	400.00	272	60.00	90.00	3CT 90 402	US 0625	HXK 5	CC.. 1204..	US 0513-T20P	SDRT20P	HXK 5	HXK 4	12.50
A 40090 402 N	400	290.00	400.00	272	60.00	90.00	3CT 90 402 N	US 0625	HXK 5	CN.. 1204..	US 0613-H25	HXK 2.5	HXK 5	HXK 4	12.20
A 50090 300	500	370.00	500.00	352	60.00	90.00	3CT 90 300	US 0625	HXK 5	TC.. 16T3..	US 0415-T15P	SDRT15P	HXK 5	HXK 4	16.08
A 50090 402	500	370.00	500.00	352	60.00	90.00	3CT 90 402	US 0625	HXK 5	CC.. 1204..	US 0513-T20P	SDRT20P	HXK 5	HXK 4	16.20
A 50090 402 N	500	370.00	500.00	352	60.00	90.00	3CT 90 402 N	US 0625	HXK 5	CN.. 1204..	US 0613-H25	HXK 2.5	HXK 5	HXK 4	16.00



MB-H

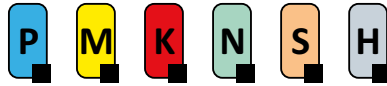

PRAMET

S



Fijnkotterkop, Ø8 tot Ø38mm

Hoogwaardige, zeer nauwkeurige micro kotterkop met hoge reproduceerbaarheid. Geschikt voor het kotteren van doorlopende, blinde, verdiepte- en kruisgaten. De kotterkop is geschikt voor kottergereedschap van Ø6.0 t/m Ø16.0 mm. Verkrijgbaar in maten van 27 t/m 42 mm.

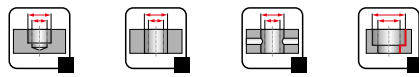
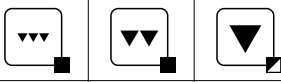
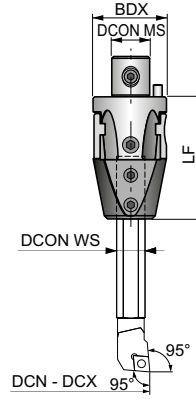

Product	CZC MS	DCN	DCX	BDX	DCON MS	DCON WS	LB			
		(mm)	(mm)	(mm)	(mm)	(mm)				
A 027 006	27	8.00	20.00	27	15.00	6.00	50.00	HXK 2	HXK 4	0.20
A 027 008	27	10.00	21.00	27	15.00	8.00	50.00	HXK 2	HXK 4	0.19
A 032 008	32	10.00	21.00	32	20.00	8.00	58.00	HXK 2.5	HXK 4	0.32
A 032 010	32	13.00	25.00	32	20.00	10.00	58.00	HXK 2.5	HXK 4	0.32
A 042 010	42	13.00	29.00	42	24.00	10.00	70.00	HXK 3	HXK 5	0.64
A 042 012	42	16.00	34.00	42	24.00	12.00	70.00	HXK 3	HXK 5	0.64
A 042 016	42	20.00	38.00	42	24.00	16.00	70.00	HXK 3	HXK 5	0.62



ISO BARS





PRAMET

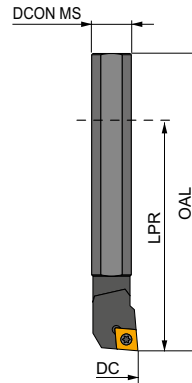

Kotterbeitels voor micro kotterkop met schachtdiameter $\varnothing 6$ t/m $\varnothing 16$ mm

Geschikt voor kotteren van blinde-, doorlopende-, verdiepte- en kruisgaten. Verkrijgbaar met wisselplaten van het type EP., TC.. en CC..



Product	DCON MS	DC	OAL	LPR				Carbide	
	(mm)	(mm)	(mm)	(mm)					
S06E SELPR 05-B	6.00	8.00	70.0	46	EP.. 0502..	US 0205-T07P	SDR T07P	–	0.04
S08F SCLCR 06-B	8.00	10.00	80.0	50	CC.. 0602..	US 0205-T08P	SDR T08P	–	0.04
S10G SCLCR 06-B	10.00	13.00	90.0	54	CC.. 0602..	US 0206-T08P	SDR T08P	–	0.06
S12H SCLCR 06-B	12.00	16.00	100.0	64	CC.. 0602..	US 0206-T08P	SDR T08P	–	0.11
S16J SCLCR 09-B	16.00	20.00	110.0	74	CC.. 09T3..	US 0408-T15P	SDR T15P	–	0.18
S16J STFCR 09-B	16.00	20.00	110.0	74	TC.. 0902..	US 0206-T07P	SDR T07P	–	0.18
S16J STFCR 16-B	16.00	20.00	110.0	74	TC.. 16T3..	US 0408-T15P	SDR T15P	–	0.18
C08G SCLCR 06	8.00	10.00	90.0	60	CC.. 0602..	US 0205-T08P	SDR T08P	✓	1.00
C10J SCLCR 06	10.00	13.00	110.0	74	CC.. 0602..	US 0206-T08P	SDR T08P	✓	0.13
C12K SCLCR 06	12.00	16.00	125.0	89	CC.. 0602..	US 0206-T08P	SDR T08P	✓	0.20
C16L SCLCR 09	16.00	20.00	140.0	104	CC.. 09T3..	US 0408-T15P	SDR T15P	✓	0.38



ISO BARS A042



Kotterbeitels voor de A042 micro kotterkop

Kotterbaren met overmaatse schacht $\varnothing 16$ mm. Geschikt voor het kotteren van blinde, doorlopende, verdiepte- en kruisgaten. Verkrijgbaar voor wisselplaten van het type EP., TC.. en CC..

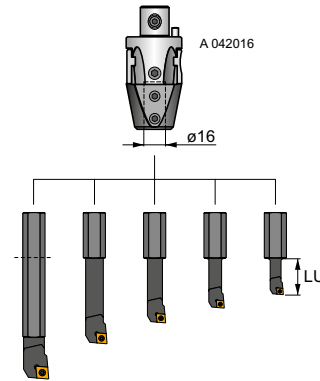

Product	DCN	DCX	LU				
	(mm)	(mm)	(mm)				
S06/16 SELPR 05	8.00	26.00	25.00	EP.. 0502..	US 0205-T07P	SDR T07P	0.08
S06/16 STFCR 06	8.00	26.00	25.00	TC.. 06T1..	US 0405-T06P	SDR T06P	0.08
S08/16 SCLCR 06	10.00	28.00	35.00	CC.. 0602..	US 0205-T08P	SDR T08P	0.09
S08/16 STFCR 06	10.00	28.00	35.00	TC.. 06T1..	US 0405-T06P	SDR T06P	0.07
S10/16 SCLCR 06	13.00	31.00	45.00	CC.. 0602..	US 0206-T08P	SDR T08P	0.10
S10/16 STFCR 09	13.00	31.00	45.00	TC.. 0902..	US 0206-T07P	SDR T07P	0.10
S12/16 SCLCR 06	16.00	34.00	57.00	CC.. 0602..	US 0206-T08P	SDR T08P	0.13
S12/16 STFCR 09	16.00	34.00	57.00	TC.. 0902..	US 0206-T07P	SDR T07P	0.13
S16/16 SCLCR 09	20.00	38.00	73.00	CC.. 09T3..	US 0408-T15P	SDR T15P	0.18
S16/16 STFCR 09	20.00	38.00	73.00	TC.. 0902..	US 0206-T07P	SDR T07P	0.18
S16/16 STFCR 16	20.00	38.00	73.00	TC.. 0902..	US 0408-T15P	SDR T15P	0.18



ACCESSOIRES



CODERING VAN DE CASSETTES

1	2	3	4
2CT	90	402 N	S

1	2	3	4
Type gereedschap	Instelhoek	Code wisselplaat	Variant
2CT	30	300 TC..16T3.	S Stapgewijs
3CT	45	402 CC..1204..	
	75	402N CN..1204..	
	90		



Symetrisch kottenen

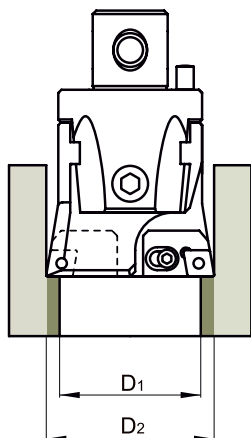

2CT □□ □□□ + 2CT □□ □□□
 3CT □□ □□□ + 3CT □□ □□□

Stapgewijs kottenen

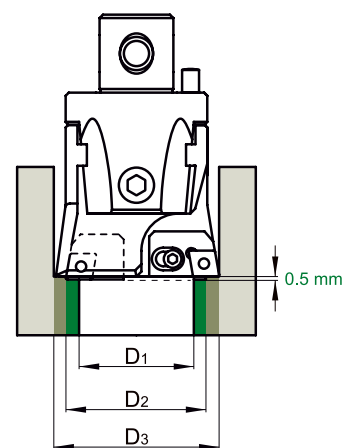

2CT □□ □□□ S + 2CT □□ □□□
 3CT □□ □□□ S + 3CT □□ □□□



CART-BS-SPC

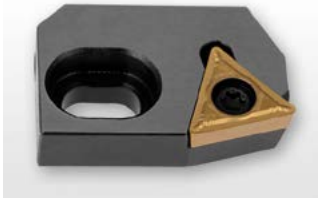
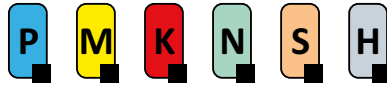

Speciale cassettes voor kotterkop, 2CT en 3CT

Speciale kottercassettes, maten 2CT en 3CT verkrijgbaar in verschillende naderingshoeken 30° of 45°. Geschikt voor wisselplaten TC., CC., CN., t.b.v. voor- en nakotteren.

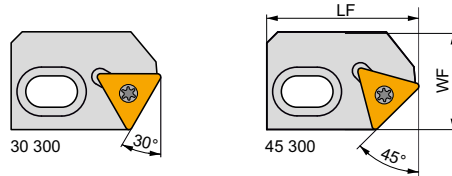

Product	WF	LF								kg
	(mm)	(mm)								
2CT 30 300	22.5	35.00	US 0616	HXK 5	US 0430	HXK 2	TC.. 16T3..	US 0408-T15P	SDR T15P	0.59
2CT 45 300	22.5	35.00	US 0616	HXK 5	US 0430	HXK 2	TC.. 16T3..	US 0408-T15P	SDR T15P	0.05
2CT 90 300 S	23	33.00	US 0616	HXK 5	US 0430	HXK 2	TC.. 16T3..	US 0408-T15P	SDR T15P	0.05
2CT 90 402 N S	23	33.00	US 0616	HXK 5	US 0430	HXK 2	CN.. 1204.. L	US 0613-H25	HXK 2.5	0.07
2CT 90 402 S	23	33.00	US 0616	HXK 5	US 0430	HXK 2	CC.. 1204..	US 0509-T20P	SDR T20P	0.05
3CT 30 300	28	39.00	US 0625	HXK 5	US 0635	HXK 3	TC.. 16T3..	US 0415-T15P	SDR T15P	0.10
3CT 45 300	28	39.00	US 0625	HXK 5	US 0635	HXK 3	TC.. 16T3..	US 0415-T15P	SDR T15P	0.10
3CT 90 300 S	28.5	37.00	US 0625	HXK 5	US 0635	HXK 3	TC.. 16T3..	US 0415-T15P	SDR T15P	0.10
3CT 90 402 N S	28.5	37.00	US 0625	HXK 5	US 0635	HXK 3	CN.. 1204.. L	US 0613-H25	HXK 2.5	0.11
3CT 90 402 S	28.5	37.00	US 0625	HXK 5	US 0635	HXK 3	CC.. 1204..	US 0513-T20P	SDR T20P	0.09



CART-BS-STD

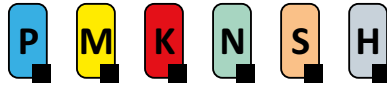

Standaard cassettes voor kotterkop, 2CT en 3CT

Standaard kottercassettes, maten 2CT en 3CT verkrijgbaar in verschillende naderingshoeken 75° of 90°. Geschikt voor wisselplaten TC., CC., CN., t.b.v. voor- en nakotteren.

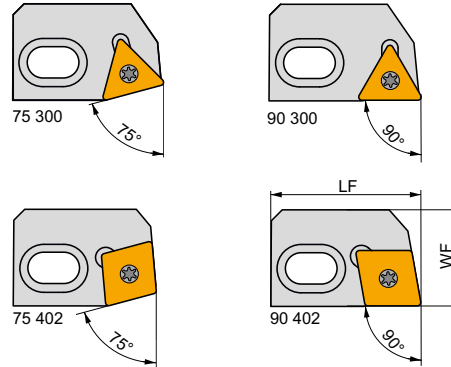

Product	WF	LF									
	(mm)	(mm)									
2CT 75 300	22.5	35.00	US 0616	HXK 5	US 0430	HXK 2	TC.. 16T3..	US 0408-T15P	SDR T15P	0.06	
2CT 75 402	22.5	35.00	US 0616	HXK 5	US 0430	HXK 2	CC.. 1204..	US 0509-T20P	SDR T20P	0.06	
2CT 75 402 N	22.5	35.00	US 0616	HXK 5	US 0430	HXK 2	CN.. 1204.. R	US 0613-H25	HXK 2.5	0.07	
2CT 90 300	22.5	35.00	US 0616	HXK 5	US 0430	HXK 2	TC.. 16T3..	US 0408-T15P	SDR T15P	0.05	
2CT 90 402	22.5	35.00	US 0616	HXK 5	US 0430	HXK 2	CC.. 1204..	US 0509-T20P	SDR T20P	0.05	
2CT 90 402 N	22.5	35.00	US 0616	HXK 5	US 0430	HXK 2	CN.. 1204.. L	US 0613-H25	HXK 2.5	0.07	
3CT 75 300	28	39.00	US 0625	HXK 5	US 0635	HXK 3	TC.. 16T3..	US 0415-T15P	SDR T15P	0.10	
3CT 75 402	28	39.00	US 0625	HXK 5	US 0635	HXK 3	CC.. 1204..	US 0509-T20P	SDR T20P	0.10	
3CT 75 402 N	28	39.00	US 0625	HXK 5	US 0635	HXK 3	CN.. 1204.. R	US 0613-H25	HXK 2.5	0.12	
3CT 90 300	28	39.00	US 0625	HXK 5	US 0635	HXK 3	TC.. 16T3..	US 0415-T15P	SDR T15P	0.11	
3CT 90 402	28	39.00	US 0625	HXK 5	US 0635	HXK 3	CC.. 1204..	US 0509-T20P	SDR T20P	0.10	
3CT 90 402 N	28	39.00	US 0625	HXK 5	US 0635	HXK 3	CN.. 1204.. L	US 0613-H25	HXK 2.5	0.12	



CHAM-BS



PRAMET

S



Afkantring voor kotterkoppen

45° afkantring voor kotterboorkopstelsysteem, maten van 22 tot 42 mm voor DC.. 11T3.. en maten van 54 t/m 200 mm voor DC.. 1504.. wisselplaten.

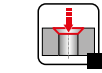
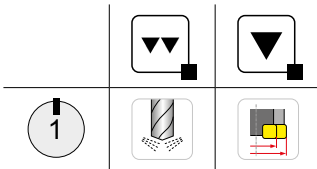
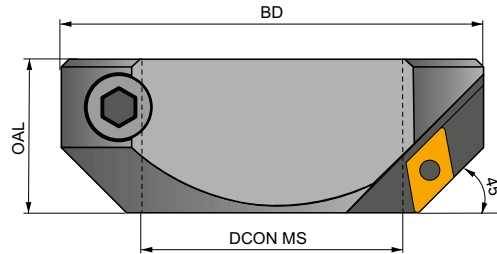

















Product	CZC MS	DCON MS (mm)	BD (mm)	OAL (mm)	DC.. 11T3..	US 0408-T15P	SDRT15P	HXK 4	kg
CH 022	22	22.00	43.00	24.0	DC.. 11T3..	US 0408-T15P	SDRT15P	HXX 4	0.11
CH 027	27	27.00	48.00	24.0	DC.. 11T3..	US 0408-T15P	SDRT15P	HXX 4	0.13
CH 032	32	32.00	62.00	30.0	DC.. 11T3..	US 0408-T15P	SDRT15P	HXX 5	0.29
CH 042	42	42.00	72.00	30.0	DC.. 11T3..	US 0408-T15P	SDRT15P	HXX 5	0.38
CH 054	54	54.00	94.00	40.0	DC.. 1504..	US 0513-T20P	SDRT20P	HXX 6	0.89
CH 068	68	68.00	110.00	40.0	DC.. 1504..	US 0513-T20P	SDRT20P	HXX 8	1.23
CH 085	85	85.00	145.00	55.0	DC.. 1504..	US 0513-T20P	SDRT20P	HXX 10	2.70
CH 100	100	100.00	170.00	60.0	DC.. 1504..	US 0513-T20P	SDRT20P	HXX 14	4.14
CH 200	200	100.00	200.00	60.0	DC.. 1504..	US 0513-T20P	SDRT20P	HXX 14	5.80



WISSELPLATEN KOTTEREN







KOTTER WISSELPLATEN - NAVIGATOR

CCGT  388	CCGW CBN  390	CCMT  390	CCMW  393
CNGA CBN  394	CNGG  395	CNMA  395	CNMG  396
DCMT  398	DCMW  399	DCMW PCD  399	
EPGX  400	EPMT  400		
TCGT  401	TCMT  402	TCMW  403	

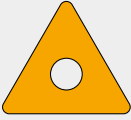

WISSELPLATEN

Vorm	Codering van de plaatszitting	ISO code
	300	TC..16T3..
	400 401 402 409	CC..0602.. CC..0803.. CC..1204.. CC..09T3..
	402N	CN..1204..
		EP..0502..
		DC..11T3.. DC..1504..

Meer gedetailleerde informatie over wisselplaten kan gevonden worden in het hoofdstuk draaien, waaronder details over de geometriën.



HARDMETAALSOORTEN – NAVIGATOR

Hardmetaal-soort	Inzetgebied	Toepasbaarheid	Voeding	Snijsnelheid	Bestendigheid tegen ongunstige omstandigheden	Coating	Kleur	Substraat	Voordeel koeling	Omschrijving hardmetaal
T9315	P05 - P25	■				MT-CVD		FGM	++	Een veelzijdige kwaliteit met uitstekende slijtvaste eigenschappen, zelfs onder intensieve snijomstandigheden. Hij kan ook worden gebruikt voor bewerkingen met onderbroken sneden. Met zijn uitgebalanceerde eigenschappen kan deze soort de eerste keuze zijn voor een brede reeks draaibewerkingen bewerkingen. Niet geschikt voor lage snijsnelheden.
	K05 - K25	■	▴	▴	▴					
	H10 - H20	■								
T9325	P15 - P35	■				MT-CVD		FGM	++	Vanuit technologisch oogpunt is dit een uiterst veelzijdige kwaliteit met een hoge weerstand tegen mechanische beschadiging in ongunstige snijomstandigheden en behoudt een uitstekende slijtvastheid. De juiste toepassing van deze soort vereist hoge snelheden.
	M10 - M30	■	▴	▴	▴					
	K15 - K35	■	▴	▴	▴					
	S10 - S20	■								
T9335	P20 - P45	■				MT-CVD		FGM	+++	Een van de taaieste kwaliteiten die bijzonder geschikt is voor ongunstige snijomstandigheden voor gemiddelde tot hoge voedingsnelheden en gemiddelde snijsnelheden. Vergeleken met zijn voorgangers, M15 - M40 is hij niet alleen taai, maar ook slijtvaster wat nuttig is bij intensieve snijomstandigheden.
	M15 - M40	■	▴	▴	▴					
	S15 - S25	■								
T7325	P15 - P35	■				MT-CVD		FGM	+++	Een van de meest universele draaikwaliteiten. Speciaal ontworpen voor het bewerken van roestvast staal. Optimaal evenwicht tussen slijtvastheid en betrouwbaarheid. Geschikt voor een breed toepassingsgebied bij draaibewerkingen.
	M10 - M25	■	▴	▴	▴					
	S10 - S25	■								
T7335	P20 - P40	■				MT-CVD		FGM	+++	Kwaliteit met functioneel geklasseerd substraat, met zeer hoge bedrijfszekerheid en zeer goede slijtvastheid. Het is het meest geschikt voor gebruik bij de bewerking van zeer taai M20 - M40 materialen.
	M20 - M40	■	▴	▴	▴					
	S15 - S25	■								
T5305	P05 - P15	■				MT-CVD		H	+	Kwaliteit met zeer hoge weerstand tegen chemische slijtage; geschikt voor nabewerkingen met hoge snijsnelheden. Door zijn hoge slijtvastheid is hij ook geschikt voor de productieve bewerking van geharde en behandelde materialen (K01 - K15).
	K01 - K15	■	▴	▴	▴					
	H05 - H15	■								
T5315	P10 - P25	■				MT-CVD		H	+	Kwaliteit vooral bestemd voor productieve bewerkingen met hoge slijtvastheid en goede bedrijfszekerheid. Door zijn eigenschappen is dit materiaal bijzonder geschikt voor voorbewerking en nabewerking bij goede of licht ongunstige verspaningscondities.
	K10 - K25	■	▴	▴	▴					
	H15 - H25	■								
T8315	P05 - P20	■				PVD		submicron H	++	De kwaliteit, die uitstekend bestand is tegen schuren en toch een bovengemiddelde bedrijfszekerheid biedt, is geschikt voor het bewerken met gemiddelde tot hoge snijsnelheden in kortspanige hardere materialen.
	M05 - M20	■	▴	▴	▴					
	K05 - K25	■	▴	▴	▴					
	N05 - N25	■								
	S05 - S15	■								
T8330	P25 - P40	■				PVD		submicron H	+++	Ongetwijfeld het meest veelzijdige snijmateriaal, dat bruikbaar is voor de bewerking van alle soorten materialen en praktisch toepasbaar is bij vrijwel alle soorten draaibewerkingen. De belangrijkste voordelen zijn de hoge bedrijfszekerheid en de zeer goede wrijvingscoëfficiënt; het is dan ook geschikt voor toepassingen bij gemiddelde en lagere snijsnelheden.
	M20 - M35	■	▴	▴	▴					
	K20 - K40	■	▴	▴	▴					
	N15 - N30	■								
	S15 - S25	■								
T6310	P01 - P15	■				PVD		ultra submicron H	+++	Zeer slijtvaste draaisoort met top PVD coating. Geschikt voor nabewerkingen en toepassingen waarbij een scherpe snijkant in combinatie met een hoge slijtvastheid van de flanken van groot belang is.
	M01 - M15	■	▴	▴	▴					
	K05 - K20	■	▴	▴	▴					
	N05 - N20	■								
	S01 - S15	■								
H01 - H15	■									



HARDMETAALSOORTEN – NAVIGATOR

Hardmetaalsoort	Inzetgebied	Toepasbaarheid	Voeding	Snij snelheid	Bestendigheid tegen ongunstige omstandigheden	Coating	Kleur	Substraat	Voordeel koeling	Omschrijving hardmetaal
T0315	N05 - N20	■				PVD			++	Submicron kwaliteit voor het draaien van non-ferrometalen en hun legeringen met een evenwicht tussen slijtvastheid en taaheid. Het is voorzien van een unieke coating met uitstekende wrijvingscoëfficiënt
HF7	M10 - M20	■				×		submicron H	++	Onbeklede kwaliteit die hoofdzakelijk bestemd is voor de bewerking van non-ferrometalen, maar ook kan worden gebruikt voor andere te bewerken materialen (behalve staal). Dit materiaal kan worden gebruikt voor draaien, frezen en kotten.
	K10 - K25	■								
	N10 - N25	■								
H07	M05 - M15	■				×		submicron H	++	Niet gecoate draaisoort geschikt voor bewerkingstoepassingen waarbij oxidatiebestendigheid niet het belangrijkste criterium is voor de levensduur van het gereedschap. Ontworpen voor het bewerken van Ti-gebaseerde legeringen. De kwaliteit vertoont een hoge sterkte van de snijkant samen met een goede slijtvastheid.
	K10 - K25	■								
	N10 - N30	■								
	S01 - S20	■								
TT310	P10 - P25	■				PVD		cermet	+ / -	Gecoate cermet gebruikt voor fijn- en nadraaien van koolstof- en gelegeerd staal (inclusief roestvrij staal). Zijn uitstekende wrijvingscoëfficiënt wordt nog verbeterd door de coating die met de PVD-techniek wordt aangebracht.
	M15 - M25	■								
TT010	P01 - P10	■				×		cermet	+ / -	Ongecoate cermet, die geschikt is voor het fijn verspanen van alle staalsoorten (ook roestvast staal) bij zeer lage voedingssnelheden. Het belangrijkste voordeel is de minimale radius van de snijkant en de hoge weerstand tegen fysische en chemische slijtagemechanismen.
	M01 - M10	■								
PD1	N05 - N25	■				×		PCD	-	PKD kwaliteit voor het draaien van non-ferro materialen. Ideale keuze voor het werken met hoge snij snelheden en kleine voedingen onder stabiele omstandigheden.
TB310	K01 - K10	■				×		CBN	--	CBN kwaliteit voor het bewerken van geharde materialen. Geschikt voor het bewerken met hoge snij snelheid en kleine voedingen onder stabiele omstandigheden.
	S05 - S10	■								
	H01 - H10	■								

Substraat	
H	Op WC-Co gebaseerd substraat (WC=Wolframcarbide)
submicron H	Op WC-Co gebaseerd fijnkorrelig substraat
ultra submicron H	Op WC-Co gebaseerd zeer fijnkorrelig substraat
FGM	Substraat waarin de eigenschappen van de elementen elkaar versterken
Cermet	Gesinterd hardmetaal zonder WC
PCD	Polykristallijne Diamant
CBN	Kubisch Borium Nitride

Coating	
MT-CVD	Chemische coatingsmethode bij middel hoge temperatuur.
PVD	Fysische coatingsmethode bij lage temperatuur.
×	Ongecoate soort

Gebruik van koelvloeistof	
+++	Koeling is noodzakelijk
++	Koeling wordt aanbevolen
+ / -	Koeling is optioneel
--	Geen koeling toepassen

WISSELPLATEN – ISO CODERING

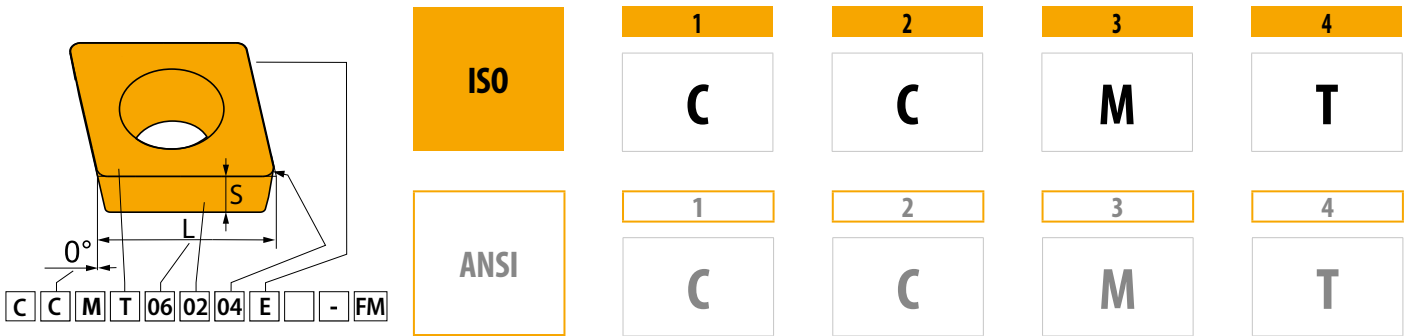

1				2				4														
Wisselplaatvorm				Vrijloophoek wisselplaat				Type wisselplaat														
H	O	P	R	A	B	C	D	N	R	F	A	M	G	W	T	Q	U	B	H	C	J	X
S	T	C	D	E	F	G	N															
E	M	V	W																			
L	A	B	K	P	O		Speciaal															

3 3

Toleranties

	(mm)			(")		
	M(±)	S(±)	IC(±)	M(±)	S(±)	IC(±)
A	0.005	0.025	0.025	.0002"	.001"	.0010"
F	0.005	0.025	0.013	.0002"	.001"	.0005"
C	0.013	0.025	0.025	.0005"	.001"	.0010"
H	0.013	0.025	0.013	.0005"	.001"	.0005"
E	0.025	0.025	0.025	.0010"	.001"	.0010"
G	0.025	0.130	0.025	.0010"	.005"	.0010"
J	0.005	0.025	0.05 – 0.13	.0002"	.001"	.002 – 0.005"
K	0.013	0.025	0.05 – 0.13	.0005"	.001"	.002 – 0.005"
L	0.025	0.025	0.05 – 0.13	.0010"	.001"	.002 – 0.005"
M	0.08 – 0.18	0.130	0.05 – 0.13	.003 – 0.007"	.005"	.002 – 0.005"
N	0.08 – 0.18	0.025	0.05 – 0.13	.003 – 0.007"	.001"	.002 – 0.005"
U	0.05 – 0.38	0.130	0.05 – 0.13	.005 – 0.015"	.005"	.003 – 0.010"

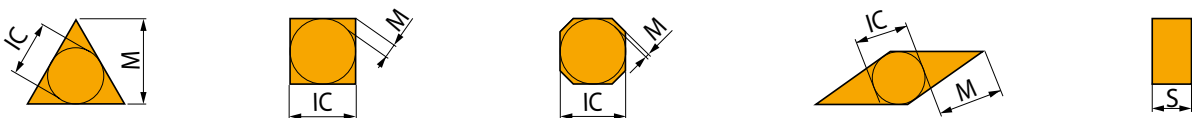

WISSELPLATEN – ISO CODERING

5	6	7	8	9	10
06	02	04	E	-	FM
5	6	7	8	9	10
2	1.5	1	E	-	FM

5		5												
Snijskantlengte (grootte wisselplaat)														
d = IC		H	O	P	S	T	C	D	E	M	V	W	R	K
(mm)	(in)													
3.97	5/32"				03	06		04			06	02		
4.76	3/16"				04	08	04	05	04	04	08	L3		
5.56	7/32"				05	09	05	06	05	05	09	03		
6.35	1/4"	03	02	04	08	11	06	07	08	08	11	04	06	
7.94	5/16"	04	03	05	07	13	08	09	06	07	13	05	07	
9.525	3/8"	05	04	07	09	16	09	11	09	09	16	06	09	16
12.7	1/2"	07	05	09	12	22	12	15	13	12	22	08	12	
15.875	5/8"	09	06	11	15	27	16	19	16	15	27	10	15	
19.05	3/4"	11	07	13	19	33	19	23	19	19	33	13	19	
25.40	1"	14	10	18	25	44	25	31	26	25	44	17	25	
31.75	1 1/4"	18	13	23	31	54	32	38	32	31	54	21	31	

6		7	
Wisselplaatdikte		Wisselplaat neusradius	
S		RE	
		(mm)	(")
01	1.59	0	0"
T1	1.98	0.2	1/128"
02	2.38	0.4	1/64"
03	3.18	0.8	1/32"
T3	3.97	1.2	3/64"
04	4.76	1.6	1/16"
05	5.56	2.4	3/32"
06	6.35	3.2	1/8"
07	7.94	Ronde wisselplaat	
09	9.52		
		d = I.C.	
		(")	00
		(mm)	M0

ANSI		
5	6	7
Ingeschreven cirkel	Wisselplaatdikte	Wisselplaat neusradius
Symbol	Symbol	Symbol
		RE
	(mm)	(mm)
	(")	(")
1	1.588	0
1.2	1.984	0.099
1.5	2.381	0.198
1.8	3.175	0.397
2	3.969	0.794
2.5	4.763	1.191
3	5.556	1.588
3.5	6.350	1.984
4	7.938	2.381
5	9.525	2.778
6	11.113	3.175
7	12.700	3.969
8	14.288	4.763
10	15.875	5.556
12		6.350

8		8	
Uitvoering van de snijkant			
	Scherpe snijkant		Afgeronde snijkant
	Snijkant met fase		Snijkant met afgeronde fase
	Snijkant met dubbele fase		Snijkant met dubbele afgeronde snijkant

9		9	
Voedingsrichting			
	Voeding		Voeding
	Voeding		Voeding
10		10	
Soort spaanbreker			



CCGT

	IC	D1	L	S
	(mm)	(mm)	(mm)	(mm)
0602	6.350	2.80	6.40	2.38
0602-SF3	6.350	2.80	6.40	2.58
0803-AL	7.940	3.40	8.10	3.43
0803-SF3	7.940	3.40	8.10	3.43
09T3	9.525	4.40	9.70	3.97
09T3-SF3	9.525	4.40	9.70	4.22
1204	12.700	5.50	12.90	4.76
1204-SF3	12.700	5.50	12.90	5.01

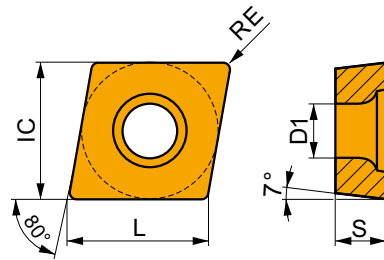

De geschiktheid en startwaarden voor de snijsnelheid (vc), voeding (f) en snediedpte (ap). Raadpleeg onze verspaningscalculator app voor meer berekeningen.

Product	RE	P			M			K			N			S			H		
		vc	f	ap	vc	f	ap	vc	f	ap	vc	f	ap	vc	f	ap	vc	f	ap
	(mm)	(m/min)	(mm/rev)	(mm)	(m/min)	(mm/rev)	(mm)	(m/min)	(mm/rev)	(mm)	(m/min)	(mm/rev)	(mm)	(m/min)	(mm/rev)	(mm)	(m/min)	(mm/rev)	(mm)



AL geometrie, zeer positieve uitvoering voor fijn nabewerken tot voorbereiden en voor ononderbroken tot licht onderbroken snedes.

CCGT 060202F-AL	HF7	0.2	-	-	-	-	-	-	-	-	-	360	0.12	1.0	-	-	-	-	-	-
	T0315	0.2	-	-	-	-	-	-	-	-	-	360	0.12	1.0	-	-	-	-	-	-
CCGT 060204F-AL	HF7	0.4	-	-	-	-	-	-	-	-	-	300	0.24	1.0	-	-	-	-	-	-
	T0315	0.4	-	-	-	-	-	-	-	-	-	300	0.24	1.0	-	-	-	-	-	-
CCGT 080302F-AL	T0315	0.2	-	-	-	-	-	-	-	-	-	360	0.12	1.0	-	-	-	-	-	-
CCGT 080304F-AL	HF7	0.4	-	-	-	-	-	-	-	-	-	300	0.24	1.0	-	-	-	-	-	-
	T0315	0.4	-	-	-	-	-	-	-	-	-	300	0.24	1.0	-	-	-	-	-	-
CCGT 09T302F-AL	HF7	0.2	-	-	-	-	-	-	-	-	-	360	0.12	1.0	-	-	-	-	-	-
	T0315	0.2	-	-	-	-	-	-	-	-	-	360	0.12	1.0	-	-	-	-	-	-
CCGT 09T304F-AL	HF7	0.4	-	-	-	-	-	-	-	-	-	300	0.24	1.5	-	-	-	-	-	-
	T0315	0.4	-	-	-	-	-	-	-	-	-	300	0.24	1.5	-	-	-	-	-	-
CCGT 09T308F-AL	HF7	0.8	-	-	-	-	-	-	-	-	-	200	0.48	1.5	-	-	-	-	-	-
	T0315	0.8	-	-	-	-	-	-	-	-	-	200	0.48	1.5	-	-	-	-	-	-
CCGT 120404F-AL	HF7	0.4	-	-	-	-	-	-	-	-	-	300	0.24	2.4	-	-	-	-	-	-
	T0315	0.4	-	-	-	-	-	-	-	-	-	300	0.24	2.4	-	-	-	-	-	-
CCGT 120408F-AL	HF7	0.8	-	-	-	-	-	-	-	-	-	200	0.48	2.4	-	-	-	-	-	-
	T0315	0.8	-	-	-	-	-	-	-	-	-	200	0.48	2.4	-	-	-	-	-	-

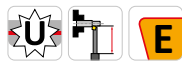
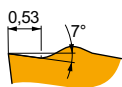

FF2 geometrie, positieve uitvoering voor fijn nabewerken tot nabewerken, ononderbroken tot licht onderbroken snedes.

CCGT 09T302E-FF2	T7325	0.2	150	0.05	1.0	-	-	-	-	-	-	-	-	-	-	-	-	-	-	-
	T9325	0.2	150	0.05	1.0	-	-	-	115	0.05	1.0	-	-	-	-	-	-	-	-	-

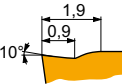

NF1 geometrie, positief, voor fijn nabewerken tot medium bewerken en ononderbroken tot onderbroken snedes.

CCGT 060204E-NF1	T6310	0.4	140	0.10	0.8	110	0.09	0.8	-	-	-	360	0.12	0.8	38	0.07	0.6	25	0.15	1.0
	T7325	0.4	140	0.10	0.8	110	0.09	0.8	-	-	-	-	-	-	45	0.07	0.6	-	-	-
CCGT 060208E-NF1	T6310	0.8	140	0.12	0.8	110	0.11	0.8	-	-	-	360	0.14	0.8	45	0.11	0.6	30	0.15	1.0
	T7325	0.8	140	0.12	0.8	110	0.11	0.8	-	-	-	-	-	-	45	0.11	0.6	-	-	-
CCGT 09T304E-NF1	T6310	0.4	140	0.10	1.2	110	0.09	1.2	-	-	-	360	0.12	1.2	38	0.07	1.0	25	0.15	1.0
	T7325	0.4	140	0.10	1.2	110	0.09	1.2	-	-	-	-	-	-	45	0.07	1.0	-	-	-
CCGT 09T308E-NF1	T6310	0.8	140	0.14	1.2	100	0.13	1.2	-	-	-	330	0.17	1.2	41	0.13	1.0	25	0.15	1.0
	T7325	0.8	140	0.14	1.2	100	0.13	1.2	-	-	-	-	-	-	45	0.13	1.0	-	-	-



De geschiktheid en startwaarden voor de snijsnelheid (vc), voeding (f) en sneddiepte (ap). Raadpleeg onze verspaningscalculator app voor meer berekeningen.

Product	RE (mm)	P			M			K			N			S			H		
		vc (m/min)	f (mm/rev)	ap (mm)	vc (m/min)	f (mm/rev)	ap (mm)	vc (m/min)	f (mm/rev)	ap (mm)	vc (m/min)	f (mm/rev)	ap (mm)	vc (m/min)	f (mm/rev)	ap (mm)	vc (m/min)	f (mm/rev)	ap (mm)

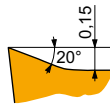

SF3 geometrie, zeer positief, voor fijn nabewerken tot nabewerken, en ononderbroken snedes.

CCGT 060202E-SF3	H07	0.2	–	–	–	█	110	0.05	0.8	█	115	0.05	0.8	█	360	0.06	0.8	█	45	0.04	0.6	–	–	–		
	T6310	0.2	█	150	0.05	0.8	█	110	0.05	0.8	█	115	0.05	0.8	█	360	0.06	0.8	█	45	0.04	0.6	█	30	0.15	1.0
	T8315	0.2	█	150	0.05	0.8	█	110	0.05	0.8	█	115	0.05	0.8	█	360	0.06	0.8	█	38	0.04	0.6	█	30	0.15	1.0
CCGT 060204E-SF3	H07	0.4	–	–	–	█	95	0.09	0.8	█	115	0.10	0.8	█	360	0.12	0.8	█	34	0.07	0.6	–	–	–		
	T6310	0.4	█	140	0.10	0.8	█	110	0.09	0.8	█	115	0.10	0.8	█	360	0.12	0.8	█	38	0.07	0.6	█	26	0.15	1.0
	T8315	0.4	█	140	0.10	0.8	█	110	0.09	0.8	█	115	0.10	0.8	█	360	0.12	0.8	█	34	0.07	0.6	█	26	0.15	1.0
CCGT 080302E-SF3	T6310	0.2	█	150	0.05	0.8	█	110	0.05	0.8	█	115	0.05	0.8	█	360	0.06	0.8	█	45	0.04	0.6	█	30	0.15	1.0
	T8315	0.2	█	150	0.05	0.8	█	110	0.05	0.8	█	115	0.05	0.8	█	360	0.06	0.8	█	38	0.04	0.6	█	30	0.15	1.0
	T8315	0.2	█	150	0.05	0.8	█	110	0.05	0.8	█	115	0.05	0.8	█	360	0.06	0.8	█	38	0.04	0.6	█	30	0.15	1.0
CCGT 080304E-SF3	H07	0.4	–	–	–	█	95	0.09	1.0	█	115	0.10	1.0	█	360	0.12	1.0	█	34	0.07	0.8	–	–	–		
	T6310	0.4	█	140	0.10	1.0	█	110	0.09	1.0	█	115	0.10	1.0	█	360	0.12	1.0	█	38	0.07	0.8	█	26	0.15	1.0
	T8315	0.4	█	140	0.10	1.0	█	110	0.09	1.0	█	115	0.10	1.0	█	360	0.12	1.0	█	34	0.07	0.8	█	26	0.15	1.0
CCGT 09T302E-SF3	H07	0.2	–	–	–	█	110	0.05	0.8	█	115	0.05	0.8	█	360	0.06	0.8	█	45	0.04	0.6	–	–	–		
	T6310	0.2	█	150	0.05	0.8	█	110	0.05	0.8	█	115	0.05	0.8	█	360	0.06	0.8	█	45	0.04	0.6	█	30	0.15	1.0
	T8315	0.2	█	150	0.05	0.8	█	110	0.05	0.8	█	115	0.05	0.8	█	360	0.06	0.8	█	38	0.04	0.6	█	30	0.15	1.0
CCGT 09T304E-SF3	H07	0.4	–	–	–	█	95	0.09	1.0	█	115	0.10	1.0	█	360	0.12	1.0	█	34	0.07	0.8	–	–	–		
	T6310	0.4	█	140	0.10	1.0	█	110	0.09	1.0	█	115	0.10	1.0	█	360	0.12	1.0	█	38	0.07	0.8	█	26	0.15	1.0
	T8315	0.4	█	140	0.10	1.0	█	110	0.09	1.0	█	115	0.10	1.0	█	360	0.12	1.0	█	34	0.07	0.8	█	26	0.15	1.0
CCGT 09T308E-SF3	H07	0.8	–	–	–	█	110	0.09	1.0	█	115	0.10	1.0	█	360	0.12	1.0	█	41	0.08	0.8	–	–	–		
	T6310	0.8	█	140	0.10	1.0	█	110	0.09	1.0	█	115	0.10	1.0	█	360	0.12	1.0	█	45	0.08	0.8	█	30	0.15	1.0
	T8315	0.8	█	140	0.10	1.0	█	110	0.09	1.0	█	115	0.10	1.0	█	360	0.12	1.0	█	41	0.08	0.8	█	34	0.15	1.0
CCGT 120408E-SF3	H07	0.8	–	–	–	█	105	0.12	1.0	█	110	0.12	1.0	█	360	0.14	1.0	█	38	0.11	0.8	–	–	–		
	T6310	0.8	█	140	0.12	1.0	█	110	0.12	1.0	█	110	0.12	1.0	█	360	0.14	1.0	█	45	0.11	0.8	█	30	0.15	1.0
	T8315	0.8	█	140	0.12	1.0	█	110	0.12	1.0	█	110	0.12	1.0	█	360	0.14	1.0	█	38	0.11	0.8	█	30	0.15	1.0

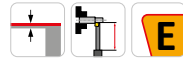

EL-SI geometrie, linkse positieve uitvoering voor fijn nabewerken en ononderbroken snedes.

CCGT 060202EL-SI	T8330	0.2	█	140	0.10	0.8	█	110	0.09	0.8	█	115	0.10	0.8	–	–	–	█	38	0.08	0.6	–	–	–
	T8430	0.2	█	140	0.10	0.8	█	110	0.09	0.8	█	115	0.10	0.8	–	–	–	█	38	0.08	0.6	–	–	–
CCGT 060204EL-SI	T8315	0.4	█	140	0.12	0.8	█	110	0.11	0.8	█	110	0.12	0.8	–	–	–	█	41	0.10	0.6	–	–	–
	T8330	0.4	█	140	0.12	0.8	█	110	0.11	0.8	█	110	0.12	0.8	–	–	–	█	38	0.10	0.6	–	–	–
CCGT 09T304EL-SI	T8430	0.4	█	140	0.12	0.8	█	110	0.11	0.8	█	110	0.12	0.8	–	–	–	█	38	0.10	0.6	–	–	–
	T8315	0.4	█	130	0.17	0.8	█	100	0.15	0.8	█	105	0.17	0.8	–	–	–	█	38	0.15	0.6	–	–	–
CCGT 120408EL-SI	T8330	0.8	█	130	0.23	1.0	█	95	0.21	1.0	█	95	0.23	1.0	–	–	–	█	38	0.21	0.8	–	–	–
	T8430	0.8	█	130	0.24	1.0	█	95	0.22	1.0	█	95	0.24	1.0	–	–	–	█	34	0.22	0.8	–	–	–



CCGW CBN

PRAMET

	IC (mm)	D1 (mm)	L (mm)	S (mm)
0602	6.350	2.80	6.50	2.38
09T3	9.525	4.50	9.70	3.97

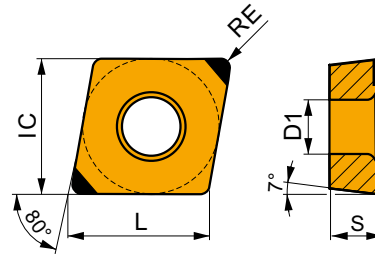

De geschiktheid en startwaarden voor de snijsnelheid (vc), voeding (f) en snediedpte (ap). Raadpleeg onze verspaningscalculator app voor meer berekeningen.

Product	RE	P			M			K			N			S			H		
		vc (m/min)	f (mm/rev)	ap (mm)	vc (m/min)	f (mm/rev)	ap (mm)	vc (m/min)	f (mm/rev)	ap (mm)	vc (m/min)	f (mm/rev)	ap (mm)	vc (m/min)	f (mm/rev)	ap (mm)	vc (m/min)	f (mm/rev)	ap (mm)

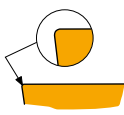

Voor nabewerken.

CCGW 060204E-B	TB310	0.4	-	-	-	-	-	-	115	0.10	0.4	-	-	-	90	0.07	0.3	70	0.15	1.0
CCGW 09T304E-B	TB310	0.4	-	-	-	-	-	-	115	0.10	0.4	-	-	-	90	0.07	0.3	70	0.15	1.0

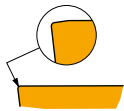

Voor nabewerken.

CCGW 060204S01020B	TB310	0.4	-	-	-	-	-	-	115	0.10	0.4	-	-	-	90	0.07	0.3	70	0.15	1.0
CCGW 09T304S01020B	TB310	0.4	-	-	-	-	-	-	115	0.10	0.4	-	-	-	90	0.07	0.3	70	0.15	1.0

CCMT

PRAMET

	IC (mm)	D1 (mm)	L (mm)	S (mm)
0602	6.350	2.80	6.40	2.38
0803	7.940	3.40	8.10	3.18
09T3	9.525	4.40	9.70	3.97
1204	12.700	5.50	12.90	4.76

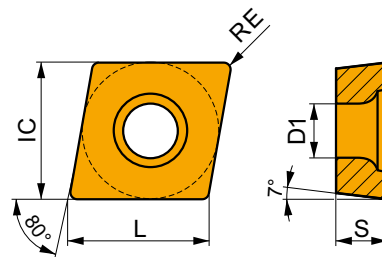

De geschiktheid en startwaarden voor de snijsnelheid (vc), voeding (f) en snediedpte (ap). Raadpleeg onze verspaningscalculator app voor meer berekeningen.

Product	RE	P			M			K			N			S			H		
		vc (m/min)	f (mm/rev)	ap (mm)	vc (m/min)	f (mm/rev)	ap (mm)	vc (m/min)	f (mm/rev)	ap (mm)	vc (m/min)	f (mm/rev)	ap (mm)	vc (m/min)	f (mm/rev)	ap (mm)	vc (m/min)	f (mm/rev)	ap (mm)

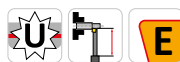
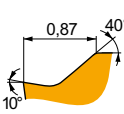

FF geometrie, positieve uitvoering voor fijn nabewerken tot nabewerken, ononderbroken tot licht onderbroken snedes.

CCMT 060202E-FF	T8330	0.2	140	0.10	1.0	110	0.09	1.0	-	-	-	-	-	-	-	-	-	-	-	-
	T8430	0.2	140	0.10	1.0	110	0.09	1.0	-	-	-	-	-	-	-	-	-	-	-	-
CCMT 060204E-FF	T8330	0.4	140	0.12	1.0	110	0.11	1.0	-	-	-	-	-	-	-	-	-	-	-	-
	T8430	0.4	140	0.12	1.0	110	0.11	1.0	-	-	-	-	-	-	-	-	-	-	-	-
CCMT 09T304E-FF	T8330	0.4	140	0.12	1.2	110	0.11	1.2	-	-	-	-	-	-	-	-	-	-	-	-
	T8430	0.4	140	0.12	1.2	110	0.11	1.2	-	-	-	-	-	-	-	-	-	-	-	-



De geschiktheid en startwaarden voor de snij snelheid (vc), voeding (f) en snediepte (ap). Raadpleeg onze verspaningscalculator app voor meer berekeningen.

Product	RE (mm)	P			M			K			N			S			H		
		vc (m/min)	f (mm/rev)	ap (mm)	vc (m/min)	f (mm/rev)	ap (mm)	vc (m/min)	f (mm/rev)	ap (mm)	vc (m/min)	f (mm/rev)	ap (mm)	vc (m/min)	f (mm/rev)	ap (mm)	vc (m/min)	f (mm/rev)	ap (mm)

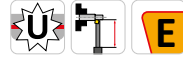
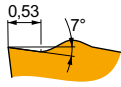

FF2 geometrie, positieve uitvoering voor fijn nabewerken tot nabewerken en ononderbroken tot licht onderbroken snedes.

CCMT 060202E-FF2	T8330	0.2	150	0.05	0.8	-	-	-	115	0.05	0.8	-	-	-	-	-	-	-
	T8430	0.2	150	0.05	0.8	-	-	-	115	0.05	0.8	-	-	-	-	-	-	-
	T9325	0.2	150	0.05	0.8	-	-	-	115	0.05	0.8	-	-	-	-	-	-	-
	TT010	0.2	150	0.05	0.5	-	-	-	-	-	-	-	-	-	-	-	-	-
CCMT 060204E-FF2	T8330	0.4	140	0.12	1.0	-	-	-	110	0.12	1.0	-	-	-	-	-	-	-
	T8430	0.4	140	0.12	1.0	-	-	-	110	0.12	1.0	-	-	-	-	-	-	-
	T9325	0.4	140	0.12	1.0	-	-	-	110	0.12	1.0	-	-	-	-	-	-	-
	TT010	0.4	140	0.12	0.5	-	-	-	-	-	-	-	-	-	-	-	-	-
CCMT 080302E-FF2	T8330	0.2	150	0.05	0.8	-	-	-	115	0.05	0.8	-	-	-	-	-	-	-
	T8430	0.2	150	0.05	0.8	-	-	-	115	0.05	0.8	-	-	-	-	-	-	-
	T9325	0.2	150	0.05	0.8	-	-	-	115	0.05	0.8	-	-	-	-	-	-	-
	TT010	0.2	150	0.05	0.5	-	-	-	-	-	-	-	-	-	-	-	-	-
CCMT 080304E-FF2	T8330	0.4	140	0.12	1.0	-	-	-	110	0.12	1.0	-	-	-	-	-	-	-
	T8430	0.4	140	0.12	1.0	-	-	-	110	0.12	1.0	-	-	-	-	-	-	-
	T9325	0.4	140	0.12	1.0	-	-	-	110	0.12	1.0	-	-	-	-	-	-	-
	TT010	0.4	150	0.06	0.5	-	-	-	-	-	-	-	-	-	-	-	-	-
CCMT 080308E-FF2	T8330	0.8	130	0.17	1.0	-	-	-	105	0.17	1.0	-	-	-	-	-	-	-
	T8430	0.8	130	0.17	1.0	-	-	-	105	0.17	1.0	-	-	-	-	-	-	-
	T9325	0.8	130	0.17	1.0	-	-	-	105	0.17	1.0	-	-	-	-	-	-	-
CCMT 09T304E-FF2	T8330	0.4	140	0.12	1.2	-	-	-	110	0.12	1.2	-	-	-	-	-	-	-
	T8430	0.4	140	0.12	1.2	-	-	-	110	0.12	1.2	-	-	-	-	-	-	-
	T9325	0.4	140	0.12	1.2	-	-	-	110	0.12	1.2	-	-	-	-	-	-	-
	TT010	0.4	150	0.06	0.5	-	-	-	-	-	-	-	-	-	-	-	-	-
CCMT 09T308E-FF2	T8330	0.8	130	0.17	1.2	-	-	-	105	0.17	1.2	-	-	-	-	-	-	-
	T8430	0.8	130	0.17	1.2	-	-	-	105	0.17	1.2	-	-	-	-	-	-	-
	T9325	0.8	130	0.17	1.2	-	-	-	105	0.17	1.2	-	-	-	-	-	-	-
	TT010	0.8	140	0.10	0.8	-	-	-	-	-	-	-	-	-	-	-	-	-

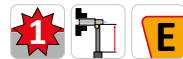

FM geometrie voor nabewerken tot semi voorbereken en ononderbroken tot licht onderbroken snedes.

CCMT 060202E-FM	T8330	0.2	140	0.10	1.0	110	0.09	1.0	115	0.10	1.0	360	0.12	1.0	-	-	-	-
	T8430	0.2	140	0.10	1.0	110	0.09	1.0	115	0.10	1.0	360	0.12	1.0	-	-	-	-
	T9325	0.2	140	0.10	1.0	110	0.09	1.0	115	0.10	1.0	-	-	-	-	-	-	-
CCMT 060204E-FM	T8330	0.4	140	0.15	1.0	100	0.14	1.0	110	0.15	1.0	330	0.18	1.0	-	-	-	-
	T8430	0.4	140	0.15	1.0	100	0.14	1.0	110	0.15	1.0	330	0.18	1.0	-	-	-	-
	T9325	0.4	140	0.15	1.0	100	0.15	1.0	110	0.15	1.0	-	-	-	-	-	-	-
CCMT 060208E-FM	T8330	0.8	130	0.20	1.0	100	0.18	1.0	100	0.20	1.0	300	0.24	1.0	-	-	-	-
	T8430	0.8	130	0.20	1.0	100	0.18	1.0	100	0.20	1.0	300	0.24	1.0	-	-	-	-
	T9325	0.8	130	0.20	1.0	100	0.18	1.0	100	0.20	1.0	-	-	-	-	-	-	-
CCMT 09T302E-FM	T8330	0.2	140	0.10	1.2	105	0.09	1.2	115	0.10	1.2	360	0.12	1.2	-	-	-	-
	T8430	0.2	140	0.10	1.2	110	0.09	1.2	115	0.10	1.2	360	0.12	1.2	-	-	-	-
	T9325	0.2	140	0.10	1.2	110	0.09	1.2	115	0.10	1.2	-	-	-	-	-	-	-
CCMT 09T304E-FM	T8330	0.4	140	0.15	1.2	100	0.14	1.2	110	0.15	1.2	330	0.18	1.2	-	-	-	-
	T8430	0.4	140	0.15	1.2	100	0.14	1.2	110	0.15	1.2	330	0.18	1.2	-	-	-	-
	T9325	0.4	140	0.15	1.2	100	0.15	1.2	110	0.15	1.2	-	-	-	-	-	-	-
CCMT 09T308E-FM	T8330	0.8	130	0.20	1.2	100	0.18	1.2	100	0.20	1.2	300	0.24	1.2	-	-	-	-
	T8430	0.8	130	0.20	1.2	100	0.18	1.2	100	0.20	1.2	300	0.24	1.2	-	-	-	-
	T9325	0.8	130	0.20	1.2	100	0.18	1.2	100	0.20	1.2	-	-	-	-	-	-	-
CCMT 120404E-FM	T8330	0.4	140	0.15	1.7	95	0.14	1.7	110	0.15	1.7	330	0.18	1.7	-	-	-	-
	T8430	0.4	140	0.15	1.7	100	0.14	1.7	110	0.15	1.7	330	0.18	1.7	-	-	-	-
	T9325	0.4	140	0.15	1.7	100	0.15	1.7	110	0.15	1.7	-	-	-	-	-	-	-
CCMT 120408E-FM	T8330	0.8	130	0.20	1.7	100	0.18	1.7	100	0.20	1.7	300	0.24	1.7	-	-	-	-
	T8430	0.8	130	0.20	1.7	100	0.18	1.7	100	0.20	1.7	300	0.24	1.7	-	-	-	-
	T9325	0.8	130	0.20	1.7	100	0.18	1.7	100	0.20	1.7	-	-	-	-	-	-	-



De geschiktheid en startwaarden voor de snijsnelheid (vc), voeding (f) en sneddiepte (ap). Raadpleeg onze verspaningscalculator app voor meer berekeningen.

Product	RE (mm)	P			M			K			N			S			H		
		vc (m/min)	f (mm/rev)	ap (mm)	vc (m/min)	f (mm/rev)	ap (mm)	vc (m/min)	f (mm/rev)	ap (mm)	vc (m/min)	f (mm/rev)	ap (mm)	vc (m/min)	f (mm/rev)	ap (mm)	vc (m/min)	f (mm/rev)	ap (mm)

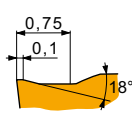

FM2 geometrie voor nabewerken tot medium bewerken en ononderbroken tot onderbroken snedes.

CCMT 080304E-FM2	T8330	0.4	140	0.12	1.0	95	0.11	1.0	110	0.12	1.0	-	-	-	-	-	-	-
	T8430	0.4	140	0.12	1.0	105	0.11	1.0	110	0.12	1.0	-	-	-	-	-	-	-
	T9325	0.4	140	0.12	1.0	110	0.11	1.0	110	0.12	1.0	-	-	-	-	-	-	-
CCMT 080308E-FM2	T8330	0.8	130	0.17	1.0	100	0.15	1.0	105	0.17	1.0	-	-	-	-	-	-	-
	T8430	0.8	130	0.17	1.0	100	0.15	1.0	105	0.17	1.0	-	-	-	-	-	-	-
	T9325	0.8	130	0.17	1.0	100	0.15	1.0	105	0.17	1.0	-	-	-	-	-	-	-
CCMT 09T304E-FM2	T8330	0.4	140	0.12	1.0	95	0.11	1.0	110	0.12	1.0	-	-	-	-	-	-	-
	T8430	0.4	140	0.12	1.0	105	0.11	1.0	110	0.12	1.0	-	-	-	-	-	-	-
	T9325	0.4	140	0.12	1.0	110	0.11	1.0	110	0.12	1.0	-	-	-	-	-	-	-
CCMT 09T308E-FM2	T8330	0.8	130	0.17	1.0	100	0.15	1.0	105	0.17	1.0	-	-	-	-	-	-	-
	T8430	0.8	130	0.17	1.0	100	0.15	1.0	105	0.17	1.0	-	-	-	-	-	-	-
	T9325	0.8	130	0.17	1.0	100	0.15	1.0	105	0.17	1.0	-	-	-	-	-	-	-
CCMT 120408E-FM2	T8330	0.8	130	0.20	1.5	95	0.18	1.5	100	0.20	1.5	-	-	-	-	-	-	-
	T8430	0.8	130	0.20	1.5	95	0.18	1.5	100	0.20	1.5	-	-	-	-	-	-	-
	T9325	0.8	130	0.20	1.5	100	0.18	1.5	100	0.20	1.5	-	-	-	-	-	-	-

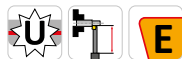

NF2 geometrie, positief, voor fijn nabewerken tot semi voorbereken en ononderbroken snedes.

CCMT 060202E-NF2	T6310	0.2	140	0.10	0.8	110	0.09	0.8	115	0.10	0.8	360	0.12	0.8	38	0.08	0.6	-	-	-
	T9325	0.2	140	0.10	0.8	110	0.09	0.8	115	0.10	0.8	-	-	-	41	0.08	0.6	-	-	-
CCMT 060204E-NF2	H07	0.4	-	-	-	85	0.11	0.8	110	0.12	0.8	360	0.14	0.8	34	0.11	0.6	-	-	-
	T6310	0.4	140	0.12	0.8	110	0.11	0.8	110	0.12	0.8	360	0.14	0.8	38	0.11	0.6	-	-	-
CCMT 080304E-NF2	T9325	0.4	140	0.12	1.0	110	0.11	1.0	110	0.12	1.0	-	-	-	41	0.11	0.8	-	-	-
	T9325	0.8	130	0.17	1.0	100	0.15	1.0	105	0.17	1.0	-	-	-	41	0.14	0.8	-	-	-
CCMT 09T304E-NF2	H07	0.4	-	-	-	85	0.11	1.2	110	0.12	1.2	360	0.14	1.2	30	0.11	1.0	-	-	-
	T6310	0.4	140	0.12	1.2	110	0.11	1.2	110	0.12	1.2	360	0.14	1.2	34	0.11	1.0	-	-	-
	T9325	0.4	140	0.12	1.2	110	0.11	1.2	110	0.12	1.2	-	-	-	41	0.11	1.0	-	-	-
CCMT 09T308E-NF2	T6310	0.8	140	0.14	1.2	100	0.13	1.2	110	0.14	1.2	330	0.17	1.2	41	0.13	1.0	-	-	-
	T9325	0.8	140	0.14	1.2	100	0.13	1.2	110	0.14	1.2	-	-	-	45	0.13	1.0	-	-	-

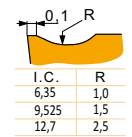

RF geometrie voor semi voorbereken tot voorbereken, en ononderbroken tot onderbroken snedes.

CCMT 060202E-RF	T7335	0.2	140	0.15	1.0	100	0.14	1.0	-	-	-	-	-	-	-	-	-	-	-	
CCMT 060204E-RF	T5315	0.4	140	0.15	1.0	-	-	-	110	0.15	1.0	-	-	-	-	-	-	35	0.15	1.0
	T7335	0.4	140	0.15	1.0	100	0.15	1.0	-	-	-	-	-	-	-	-	-	-	-	
CCMT 09T304E-RF	T7335	0.4	130	0.20	1.5	100	0.18	1.5	-	-	-	-	-	-	-	-	-	-	-	
CCMT 09T308E-RF	T5315	0.8	130	0.20	1.5	-	-	-	100	0.20	1.5	-	-	-	-	-	-	35	0.15	1.0
	T7335	0.8	130	0.20	1.5	100	0.18	1.5	-	-	-	-	-	-	-	-	-	-	-	
CCMT 120408E-RF	T5315	0.8	130	0.22	2.2	-	-	-	100	0.22	2.2	-	-	-	-	-	-	35	0.15	1.0
	T7335	0.8	130	0.22	2.2	95	0.22	2.2	-	-	-	-	-	-	-	-	-	-	-	

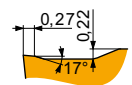
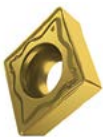

RM geometrie voor semi voorbereken tot voorbereken, en ononderbroken tot onderbroken snedes.

CCMT 09T304E-RM	T8330	0.4	120	0.27	2.2	80	0.24	2.2	95	0.27	2.2	-	-	-	26	0.19	1.8	20	0.15	1.0
	T8430	0.4	120	0.27	2.2	75	0.24	2.2	95	0.27	2.2	-	-	-	23	0.19	1.8	19	0.15	1.0
	T9325	0.4	120	0.27	2.2	95	0.24	2.2	95	0.27	2.2	-	-	-	30	0.19	1.8	-	-	-
CCMT 09T308E-RM	T8330	0.8	120	0.30	2.2	90	0.27	2.2	90	0.30	2.2	-	-	-	30	0.24	1.8	23	0.15	1.0
	T8430	0.8	120	0.30	2.2	90	0.27	2.2	90	0.30	2.2	-	-	-	26	0.24	1.8	23	0.15	1.0
	T9325	0.8	120	0.30	2.2	90	0.27	2.2	90	0.30	2.2	-	-	-	34	0.24	1.8	-	-	-



De geschiktheid en startwaarden voor de snijsnelheid (vc), voeding (f) en sneddiepte (ap). Raadpleeg onze verspaningscalculator app voor meer berekeningen.

Product	RE (mm)	P			M			K			N			S			H		
		vc (m/min)	f (mm/rev)	ap (mm)	vc (m/min)	f (mm/rev)	ap (mm)	vc (m/min)	f (mm/rev)	ap (mm)	vc (m/min)	f (mm/rev)	ap (mm)	vc (m/min)	f (mm/rev)	ap (mm)	vc (m/min)	f (mm/rev)	ap (mm)

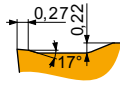
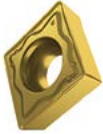

RM geometrie voor semi voorbereken tot voorbereken, en ononderbroken tot onderbroken snedes.

CCMT 120408E-RM	T8330	0.8	■	120	0.30	2.7	■	90	0.27	2.7	■	90	0.30	2.7	■	30	0.24	2.2	■	23	0.15	1.0
	T8430	0.8	■	120	0.30	2.7	■	90	0.27	2.7	■	90	0.30	2.7	■	26	0.24	2.2	■	23	0.15	1.0
	T9325	0.8	■	120	0.30	2.7	■	90	0.27	2.7	■	90	0.30	2.7	■	34	0.24	2.2	■	—	—	—

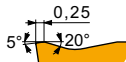

RM3 geometrie voor semi voorbereken tot voorbereken, en ononderbroken tot onderbroken snedes.

CCMT 120404E-RM3	T9325	0.4	■	120	0.25	2.5	■	95	0.25	2.5	■	95	0.25	2.5	■	—	—	—	■	—	—	—
CCMT 120408E-RM3	T6310	0.8	■	120	0.27	2.5	■	90	0.27	2.5	■	95	0.27	2.5	■	—	—	—	■	19	0.15	1.0
	T9325	0.8	■	120	0.27	2.5	■	90	0.27	2.5	■	95	0.27	2.5	■	—	—	—	■	—	—	—

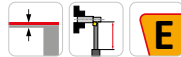
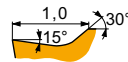

UR geometrie voor fijn nabewerken tot nabewerken, en ononderbroken tot licht onderbroken snedes.

CCMT 060202E-UR	T8330	0.2	■	140	0.10	0.8	■	95	0.09	0.8	■	115	0.10	0.8	■	—	—	—	■	—	—	—
	TT310	0.2	■	140	0.10	0.5	■	110	0.09	0.5	■	—	—	—	■	—	—	—	■	—	—	—
CCMT 060204E-UR	T8330	0.4	■	140	0.15	1.0	■	90	0.14	1.0	■	110	0.15	1.0	■	—	—	—	■	—	—	—
	TT310	0.4	■	140	0.15	0.5	■	100	0.14	0.5	■	—	—	—	■	—	—	—	■	—	—	—
CCMT 060208E-UR	T8330	0.8	■	130	0.20	1.0	■	95	0.18	1.0	■	100	0.20	1.0	■	—	—	—	■	—	—	—
CCMT 09T302E-UR	TT310	0.2	■	140	0.10	1.0	■	110	0.09	1.0	■	—	—	—	■	—	—	—	■	—	—	—
CCMT 09T304E-UR	T8330	0.4	■	140	0.15	1.2	■	90	0.14	1.2	■	110	0.15	1.2	■	—	—	—	■	—	—	—
	TT310	0.4	■	140	0.15	1.2	■	100	0.14	1.2	■	—	—	—	■	—	—	—	■	—	—	—
CCMT 09T308E-UR	T8330	0.8	■	130	0.20	1.2	■	95	0.18	1.2	■	100	0.20	1.2	■	—	—	—	■	—	—	—
	TT310	0.8	■	130	0.20	1.2	■	100	0.18	1.2	■	—	—	—	■	—	—	—	■	—	—	—
CCMT 120404E-UR	T8330	0.4	■	140	0.15	1.7	■	80	0.14	1.7	■	110	0.15	1.7	■	—	—	—	■	—	—	—
CCMT 120408E-UR	T8330	0.8	■	130	0.20	1.7	■	90	0.18	1.7	■	100	0.20	1.7	■	—	—	—	■	—	—	—

CCMW



	IC (mm)	D1 (mm)	L (mm)	S (mm)
0602	6.350	2.80	6.40	2.38
09T3	9.525	4.40	9.70	3.97
1204	12.700	5.50	12.90	4.76

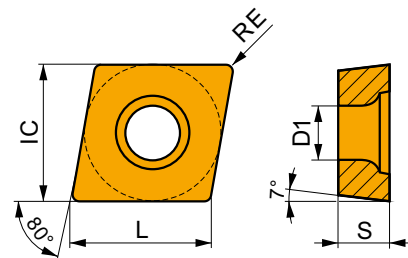

De geschiktheid en startwaarden voor de snijsnelheid (vc), voeding (f) en sneddiepte (ap). Raadpleeg onze verspaningscalculator app voor meer berekeningen.

Product	RE (mm)	P			M			K			N			S			H		
		vc (m/min)	f (mm/rev)	ap (mm)	vc (m/min)	f (mm/rev)	ap (mm)	vc (m/min)	f (mm/rev)	ap (mm)	vc (m/min)	f (mm/rev)	ap (mm)	vc (m/min)	f (mm/rev)	ap (mm)	vc (m/min)	f (mm/rev)	ap (mm)

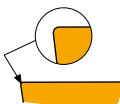

Voor fijn nabewerken tot semi voorbereken en ononderbroken en licht onderbroken snedes.

CCMW 060204	T5315	0.4	■	—	—	—	■	—	—	—	■	115	0.10	2.0	■	—	—	—	■	30	0.15	1.0
CCMW 09T304	T5315	0.4	■	—	—	—	■	—	—	—	■	115	0.10	3.0	■	—	—	—	■	30	0.15	1.0
CCMW 09T308	T5315	0.8	■	—	—	—	■	—	—	—	■	100	0.20	3.0	■	—	—	—	■	26	0.15	1.0



De geschiktheid en startwaarden voor de snijsnelheid (vc), voeding (f) en sneddiepte (ap). Raadpleeg onze verspaningscalculator app voor meer berekeningen.

Product	RE (mm)	P			M			K			N			S			H		
		vc (m/min)	f (mm/rev)	ap (mm)	vc (m/min)	f (mm/rev)	ap (mm)	vc (m/min)	f (mm/rev)	ap (mm)	vc (m/min)	f (mm/rev)	ap (mm)	vc (m/min)	f (mm/rev)	ap (mm)	vc (m/min)	f (mm/rev)	ap (mm)

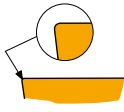

Voor fijn nabewerken tot semi voorbereken en ononderbroken en licht onderbroken snedes.

CCMW 120404	T5315	0.4	-	-	-	-	-	-	115	0.10	4.0	-	-	-	-	-	-	26	0.15	1.0
CCMW 120408	T5315	0.8	-	-	-	-	-	-	100	0.20	4.0	-	-	-	-	-	-	26	0.15	1.0

CNGA CBN

PRAMET

	IC (mm)	D1 (mm)	L (mm)	S (mm)
1204	12.700	5.16	12.90	4.76

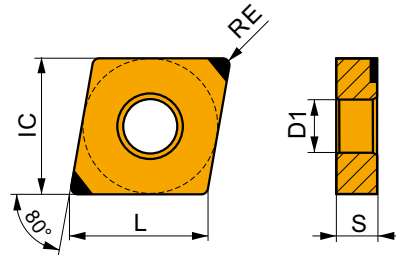

De geschiktheid en startwaarden voor de snijsnelheid (vc), voeding (f) en sneddiepte (ap). Raadpleeg onze verspaningscalculator app voor meer berekeningen.

Product	RE (mm)	P			M			K			N			S			H		
		vc (m/min)	f (mm/rev)	ap (mm)	vc (m/min)	f (mm/rev)	ap (mm)	vc (m/min)	f (mm/rev)	ap (mm)	vc (m/min)	f (mm/rev)	ap (mm)	vc (m/min)	f (mm/rev)	ap (mm)	vc (m/min)	f (mm/rev)	ap (mm)

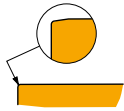

Voor nabewerken en ononderbroken snedes.

CNGA 120404S01020B	TB310	0.4	-	-	-	-	-	-	115	0.10	0.4	-	-	-	100	0.07	0.3	80	0.15	1.0
CNGA 120408S01020B	TB310	0.8	-	-	-	-	-	-	110	0.15	0.6	-	-	-	100	0.11	0.5	85	0.15	1.0



CNGG

	IC (mm)	D1 (mm)	L (mm)	S (mm)
1204	12.700	5.16	12.90	4.76

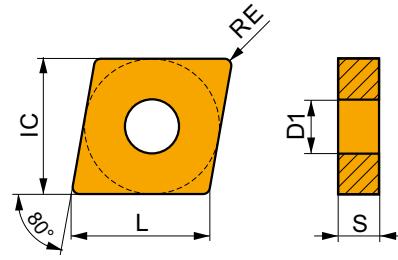

De geschiktheid en startwaarden voor de snijsnelheid (vc), voeding (f) en sneddiepte (ap). Raadpleeg onze verspaningscalculator app voor meer berekeningen.

Product	RE (mm)	P			M			K			N			S			H		
		vc (m/min)	f (mm/rev)	ap (mm)	vc (m/min)	f (mm/rev)	ap (mm)	vc (m/min)	f (mm/rev)	ap (mm)	vc (m/min)	f (mm/rev)	ap (mm)	vc (m/min)	f (mm/rev)	ap (mm)	vc (m/min)	f (mm/rev)	ap (mm)

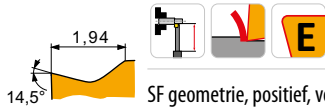

SF geometrie, positief, voor fijn nabewerken van dunne wanden met ononderbroken snedes.

CNGG 120402E-SF	H07	0.2	–	–	–	105	0.09	1.0	115	0.10	1.0	360	0.12	1.0	38	0.08	0.8	–	–	–
	T6310	0.2	140	0.10	1.0	110	0.09	1.0	115	0.10	1.0	360	0.12	1.0	41	0.08	0.8	26	0.15	1.0
	T8330	0.2	140	0.10	1.0	110	0.09	1.0	115	0.10	1.0	360	0.12	1.0	34	0.08	0.8	26	0.15	1.0
	T8430	0.2	140	0.10	1.0	110	0.09	1.0	115	0.10	1.0	360	0.12	1.0	34	0.08	0.8	30	0.15	1.0

CNMA

	IC (mm)	D1 (mm)	L (mm)	S (mm)
1204	12.700	5.16	12.90	4.76

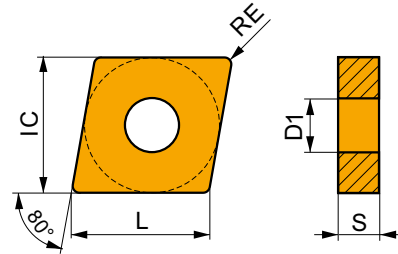

De geschiktheid en startwaarden voor de snijsnelheid (vc), voeding (f) en sneddiepte (ap). Raadpleeg onze verspaningscalculator app voor meer berekeningen.

Product	RE (mm)	P			M			K			N			S			H		
		vc (m/min)	f (mm/rev)	ap (mm)	vc (m/min)	f (mm/rev)	ap (mm)	vc (m/min)	f (mm/rev)	ap (mm)	vc (m/min)	f (mm/rev)	ap (mm)	vc (m/min)	f (mm/rev)	ap (mm)	vc (m/min)	f (mm/rev)	ap (mm)

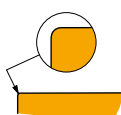

Voor fijn nabewerken tot semi voorbereken en ononderbroken en licht onderbroken snedes.

CNMA 120404	T5315	0.4	–	–	–	–	–	–	115	0.10	4.0	–	–	–	–	–	–	30	0.15	1.0
CNMA 120408	T5315	0.8	–	–	–	–	–	–	100	0.20	4.0	–	–	–	–	–	–	30	0.15	1.0
CNMA 120412	T5315	1.2	–	–	–	–	–	–	90	0.30	4.0	–	–	–	–	–	–	25	0.15	1.0



CNMG

	IC	D1	L	S
	(mm)	(mm)	(mm)	(mm)
1204	12.700	5.16	12.90	4.76

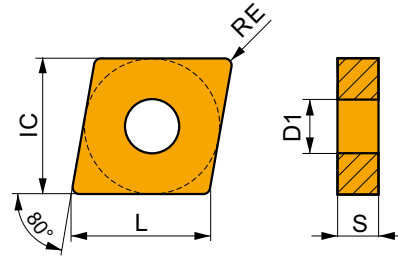

De geschiktheid en startwaarden voor de snijsnelheid (vc), voeding (f) en sneddiepte (ap). Raadpleeg onze verspaningscalculator app voor meer berekeningen.

Product	RE	P			M			K			N			S			H		
		vc	f	ap	vc	f	ap	vc	f	ap	vc	f	ap	vc	f	ap	vc	f	ap
	(mm)	(m/min)	(mm/rev)	(mm)	(m/min)	(mm/rev)	(mm)	(m/min)	(mm/rev)	(mm)	(m/min)	(mm/rev)	(mm)	(m/min)	(mm/rev)	(mm)	(m/min)	(mm/rev)	(mm)

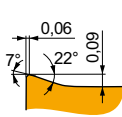

FF geometrie, zeer positieve uitvoering voor fijn nabewerken en ononderbroken tot licht onderbroken snedes.

CNMG 120404E-FF	T7325	0.4	✓	140	0.12	1.0	■	110	0.11	1.0	—	—	—	—	—	—	—	—	—
	T8315	0.4	✓	140	0.12	1.0	■	110	0.11	1.0	✓	110	0.12	1.0	—	—	—	—	—
CNMG 120408E-FF	T7325	0.8	✓	140	0.15	1.0	■	100	0.14	1.0	—	—	—	—	—	—	—	—	—
	T8315	0.8	✓	140	0.15	1.0	■	100	0.14	1.0	✓	110	0.15	1.0	—	—	—	—	—

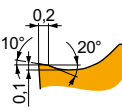

FM geometrie, postieve uitvoering voor nabewerken tot semi voorbereken en ononderbroken tot licht onderbroken snedes.

CNMG 120404E-FM	T9325	0.4	■	130	0.20	2.1	✓	100	0.18	2.1	✓	100	0.20	2.1	—	—	—	✓	38	0.16	1.7	—	—	—
	TT310	0.4	■	130	0.20	2.1	✓	100	0.18	2.1	—	—	—	—	—	—	—	—	—	—	—	—	—	
CNMG 120408E-FM	T9325	0.8	■	130	0.20	2.1	✓	100	0.18	2.1	✓	100	0.20	2.1	—	—	—	✓	45	0.16	1.7	—	—	—
	TT310	0.8	■	130	0.20	2.1	✓	100	0.18	2.1	—	—	—	—	—	—	—	—	—	—	—	—	—	

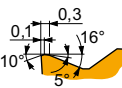

M geometrie voor nabewerken tot semi voorbereken en ononderbroken tot onderbroken snedes.

CNMG 120404E-M	T5315	0.4	✓	130	0.20	2.1	—	—	—	■	100	0.20	2.1	—	—	—	—	—	—	—	✓	35	0.15	1.0	
	T9325	0.4	■	130	0.20	2.1	—	—	—	✓	100	0.20	2.1	—	—	—	—	—	—	—	—	—	—	—	
CNMG 120408E-M	T5315	0.8	✓	120	0.32	2.1	—	—	—	■	90	0.32	2.1	—	—	—	—	—	—	—	—	✓	38	0.15	1.0
	T9325	0.8	■	120	0.32	2.1	—	—	—	✓	90	0.32	2.1	—	—	—	—	—	—	—	—	—	—	—	

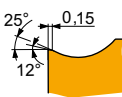

NF geometrie, zeer positief, voor fijn nabewerken tot medium bewerken en ononderbroken tot onderbroken snedes.

CNMG 120404E-NF	T7325	0.4	✓	130	0.18	1.7	■	100	0.16	1.7	—	—	—	—	—	—	—	—	—	—	✓	45	0.16	1.4	
	T8330	0.4	■	130	0.17	1.7	■	100	0.15	1.7	✓	105	0.17	1.7	✓	330	0.20	1.7	✓	34	0.14	1.4	—	—	—
	T8430	0.4	■	130	0.17	1.7	■	100	0.15	1.7	✓	105	0.17	1.7	✓	330	0.20	1.7	✓	30	0.14	1.4	—	—	—
CNMG 120408E-NF	T7325	0.8	✓	130	0.19	1.7	■	100	0.17	1.7	—	—	—	—	—	—	—	—	—	—	—	✓	45	0.15	1.4
	T8330	0.8	■	130	0.19	1.7	■	100	0.17	1.7	✓	100	0.19	1.7	✓	300	0.23	1.7	✓	38	0.15	1.4	—	—	—
	T8430	0.8	■	130	0.19	1.7	■	100	0.17	1.7	✓	100	0.19	1.7	✓	300	0.23	1.7	✓	34	0.15	1.4	—	—	—

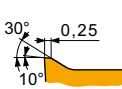









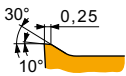

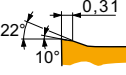

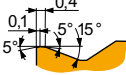
NM geometrie, zeer positief, voor fijn nabewerken, medium bewerken en voorbereken en ononderbroken snedes.

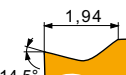
CNMG 120404E-NM	T7325	0.4	✓	130	0.20	2.1	■	100	0.18	2.1	—	—	—	—	—	—	—	—	—	—	—	—	—	—
	T8330	0.4	■	130	0.20	2.1	■	100	0.18	2.1	—	—	—	✓	300	0.24	2.1	✓	30	0.16	1.7	—	—	—
	T8430	0.4	■	130	0.20	2.1	■	100	0.18	2.1	—	—	—	✓	300	0.24	2.1	✓	30	0.16	1.7	—	—	—

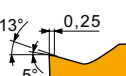

De geschiktheid en startwaarden voor de snijsnelheid (vc), voeding (f) en snediepte (ap). Raadpleeg onze verspaningscalculator app voor meer berekeningen.

Product	RE (mm)	P			M			K			N			S			H						
		vc (m/min)	f (mm/rev)	ap (mm)	vc (m/min)	f (mm/rev)	ap (mm)	vc (m/min)	f (mm/rev)	ap (mm)	vc (m/min)	f (mm/rev)	ap (mm)	vc (m/min)	f (mm/rev)	ap (mm)	vc (m/min)	f (mm/rev)	ap (mm)				
						NM geometrie, zeer positief, voor fijn nabewerken, medium bewerken en voorbereken en ononderbroken snedes.																	
			CNMG 120408E-NM	T7325	0.8	120	0.25	2.1	95	0.23	2.1	-	-	-	-	-	-	45	0.20	1.7	-	-	-
				T8330	0.8	120	0.25	2.1	95	0.23	2.1	-	-	-	270	0.30	2.1	34	0.20	1.7	-	-	-
				T8430	0.8	120	0.25	2.1	95	0.23	2.1	-	-	-	270	0.30	2.1	30	0.20	1.7	-	-	-
						NMR geometrie, zeer positief, voor medium bewerken tot voorbereken en ononderbroken snedes.																	
			CNMG 120404E-NMR	T7325	0.4	120	0.25	2.7	95	0.23	2.7	-	-	-	-	-	38	0.20	2.2	-	-	-	
				T8330	0.4	120	0.25	2.0	80	0.23	2.0	-	-	-	-	-	26	0.20	1.6	-	-	-	
				T8430	0.4	120	0.25	2.7	75	0.23	2.7	-	-	-	-	-	23	0.20	2.2	-	-	-	
CNMG 120408E-NMR	T7325	0.8	120	0.35	2.7	90	0.32	2.7	-	-	-	-	-	41	0.25	2.2	-	-	-				
	T8330	0.8	120	0.35	2.7	90	0.32	2.7	-	-	-	-	-	26	0.25	2.2	-	-	-				
	T8430	0.8	120	0.35	2.7	80	0.32	2.7	-	-	-	-	-	23	0.25	2.2	-	-	-				
						R geometrie voor semi voorbereken tot voorbereken, en ononderbroken tot onderbroken snedes.																	
			CNMG 120408E-R	T5315	0.8	120	0.40	4.0	-	-	-	80	0.40	4.0	-	-	-	-	-	30	0.15	1.0	
				T9325	0.8	120	0.40	4.0	-	-	-	80	0.40	4.0	-	-	-	-	-	-	-	-	-
									SF geometrie, positief, voor fijn nabewerken van dunne wanden en ononderbroken snedes.														
CNMG 120404E-SF	H07	0.4				-	-	-	90	0.14	1.0	110	0.15	1.0	330	0.18	1.0	34	0.12	0.8	-	-	-
	T6310	0.4				140	0.15	1.0	100	0.14	1.0	110	0.15	1.0	330	0.18	1.0	38	0.12	0.8	26	0.15	1.0
CNMG 120408E-SF	H07	0.8				-	-	-	95	0.18	1.0	100	0.20	1.0	300	0.24	1.0	38	0.14	0.8	-	-	-
	T6310	0.8	130	0.20	1.0	100	0.18	1.0	100	0.20	1.0	300	0.24	1.0	45	0.14	0.8	30	0.15	1.0			
						SM geometrie, positief, voor medium bewerken, en ononderbroken snedes tot onderbroken snedes.																	
			CNMG 120404E-SM	T6310	0.4	130	0.22	2.0	95	0.20	2.0	100	0.22	2.0	300	0.26	2.0	34	0.20	1.6	23	0.15	1.0
				T7325	0.4	130	0.22	2.0	95	0.20	2.0	-	-	-	-	-	41	0.20	1.6	-	-	-	
			CNMG 120408E-SM	T6310	0.8	120	0.25	2.0	95	0.23	2.0	95	0.25	2.0	270	0.30	2.0	38	0.20	1.6	26	0.15	1.0
	T7325	0.8	120	0.25	2.0	95	0.23	2.0	-	-	-	-	-	45	0.20	1.6	-	-	-				
						EL-SI geometrie, linkse positieve uitvoering voor fijn nabewerken tot semi voorbereken en ononderbroken snedes.																	
			CNMG 120404EL-SI	T7325	0.4	130	0.20	1.7	100	0.18	1.7	-	-	-	-	-	45	0.18	1.4	-	-	-	
				T8330	0.4	130	0.20	1.7	100	0.18	1.7	-	-	-	300	0.24	1.7	34	0.18	1.4	-	-	-
				T8430	0.4	130	0.20	1.7	100	0.18	1.7	-	-	-	300	0.24	1.7	34	0.18	1.4	-	-	-
CNMG 120408EL-SI	T7325	0.8	120	0.35	1.7	90	0.32	1.7	-	-	-	-	-	45	0.25	1.4	-	-	-				
	T8330	0.8	120	0.35	1.7	90	0.32	1.7	-	-	-	220	0.42	1.7	34	0.25	1.4	-	-	-			
	T8430	0.8	120	0.35	1.7	90	0.32	1.7	-	-	-	220	0.42	1.7	30	0.25	1.4	-	-	-			



DCMT



	IC (mm)	D1 (mm)	L (mm)	S (mm)
11T3	9.525	4.40	11.60	3.97
1504	12.700	5.50	15.50	4.76

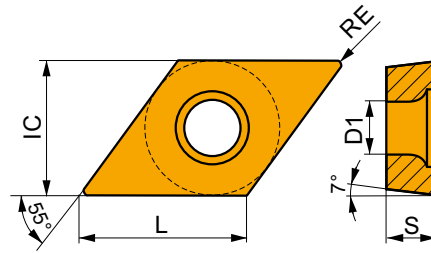

De geschiktheid en startwaarden voor de snij snelheid (vc), voeding (f) en sned diepte (ap). Raadpleeg onze verspaningscalculator app voor meer berekeningen.

Product	RE (mm)	P			M			K			N			S			H		
		vc (m/min)	f (mm/rev)	ap (mm)	vc (m/min)	f (mm/rev)	ap (mm)	vc (m/min)	f (mm/rev)	ap (mm)	vc (m/min)	f (mm/rev)	ap (mm)	vc (m/min)	f (mm/rev)	ap (mm)	vc (m/min)	f (mm/rev)	ap (mm)

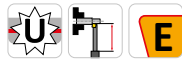
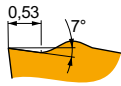

FF2 geometrie, positieve uitvoering voor fijn nabewerken tot nabewerken en ononderbroken tot licht onderbroken snedes.

DCMT 11T308E-FF2	T7325	0.8	130	0.17	0.8	-	-	-	-	-	-	-	-	-	-	-	-	-
	T8330	0.8	130	0.17	0.8	-	-	-	105	0.17	0.8	-	-	-	-	-	-	-
	T8430	0.8	130	0.17	0.8	-	-	-	105	0.17	0.8	-	-	-	-	-	-	-

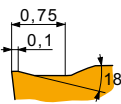

FM2 geometrie voor nabewerken tot medium bewerken en ononderbroken tot onderbroken snedes.

DCMT 150408E-FM2	T9325	0.8	130	0.20	1.5	100	0.18	1.5	100	0.20	1.5	-	-	-	-	-	-	-
	T9335	0.8	130	0.20	1.5	95	0.18	1.5	-	-	-	-	-	-	-	-	-	-

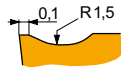

RF geometrie voor semi voorbereken tot voorbereken, en ononderbroken tot onderbroken snedes.

DCMT 11T308E-RF	T5315	0.8	130	0.20	0.8	-	-	-	100	0.20	0.8	-	-	-	-	-	-	30	0.15	1.0
	T7335	0.8	130	0.20	0.8	100	0.18	0.8	-	-	-	-	-	-	-	-	-	-	-	-

DCMW



	IC (mm)	D1 (mm)	L (mm)	S (mm)
11T3	9.525	4.40	11.60	3.97

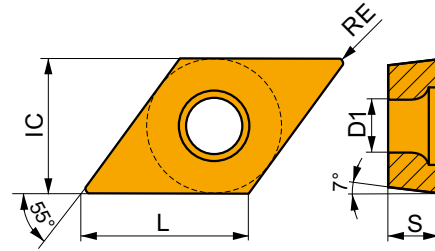

De geschiktheid en startwaarden voor de snijnsnelheid (vc), voeding (f) en sneddiepte (ap). Raadpleeg onze verspaningscalculator app voor meer berekeningen.

Product	RE (mm)	P			M			K			N			S			H		
		vc (m/min)	f (mm/rev)	ap (mm)	vc (m/min)	f (mm/rev)	ap (mm)	vc (m/min)	f (mm/rev)	ap (mm)	vc (m/min)	f (mm/rev)	ap (mm)	vc (m/min)	f (mm/rev)	ap (mm)	vc (m/min)	f (mm/rev)	ap (mm)

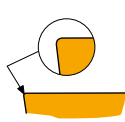

Voor fijn nabewerken tot semi voorbereken en ononderbroken en licht onderbroken snedes.

DCMW 11T304	T5315	0.4	–	–	–	–	–	–	–	115	0.10	1.2	–	–	–	–	–	–	26	0.15	1.0
	T6310	0.4	–	–	–	–	–	–	–	80	0.10	1.2	–	–	–	–	–	–	15	0.15	1.0
DCMW 11T308	T5315	0.8	–	–	–	–	–	–	–	105	0.18	1.2	–	–	–	–	–	–	23	0.15	1.0
	T6310	0.8	–	–	–	–	–	–	–	80	0.18	1.2	–	–	–	–	–	–	15	0.15	1.0

DCMW PCD



	IC (mm)	D1 (mm)	L (mm)	S (mm)
11T3	9.525	4.40	11.60	3.97

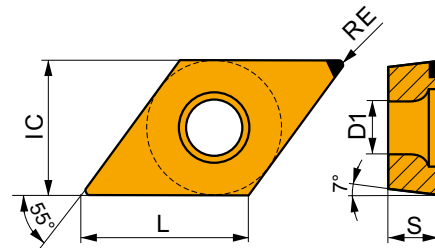

De geschiktheid en startwaarden voor de snijnsnelheid (vc), voeding (f) en sneddiepte (ap). Raadpleeg onze verspaningscalculator app voor meer berekeningen.

Product	RE (mm)	P			M			K			N			S			H		
		vc (m/min)	f (mm/rev)	ap (mm)	vc (m/min)	f (mm/rev)	ap (mm)	vc (m/min)	f (mm/rev)	ap (mm)	vc (m/min)	f (mm/rev)	ap (mm)	vc (m/min)	f (mm/rev)	ap (mm)	vc (m/min)	f (mm/rev)	ap (mm)

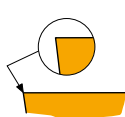

Voor nabewerken, hoge snijgegevens en stabiele snijomstandigheden.

DCMW 11T304FN	PD1	0.4	–	–	–	–	–	–	–	360	0.12	0.5	–	–	–	–	–	–	–	–	–
DCMW 11T308FN	PD1	0.8	–	–	–	–	–	–	–	360	0.12	1.0	–	–	–	–	–	–	–	–	–



EPGX

	IC (mm)	D1 (mm)	L (mm)	S (mm)
0502	5.560	2.50	5.70	2.38

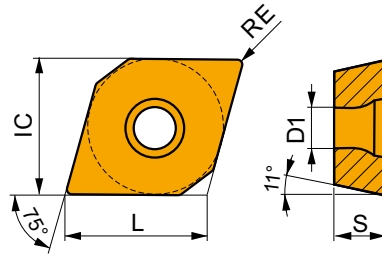

De geschiktheid en startwaarden voor de snijsnelheid (vc), voeding (f) en sneddiepte (ap). Raadpleeg onze verspaningscalculator app voor meer berekeningen.

Product	RE (mm)	P			M			K			N			S			H		
		vc (m/min)	f (mm/rev)	ap (mm)	vc (m/min)	f (mm/rev)	ap (mm)	vc (m/min)	f (mm/rev)	ap (mm)	vc (m/min)	f (mm/rev)	ap (mm)	vc (m/min)	f (mm/rev)	ap (mm)	vc (m/min)	f (mm/rev)	ap (mm)

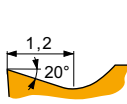

FL-JZ geometrie, linkse positieve uitvoering voor fijn nabewerken en ononderbroken snedes.

EPGX 050202FL-JZ	TT010	0.2	150	0.06	0.5	110	0.05	0.5	-	-	-	-	-	-	-	-	-	-
------------------	-------	-----	-----	------	-----	-----	------	-----	---	---	---	---	---	---	---	---	---	---

EPMT

	IC (mm)	D1 (mm)	L (mm)	S (mm)
0502	5.560	2.50	5.70	2.38

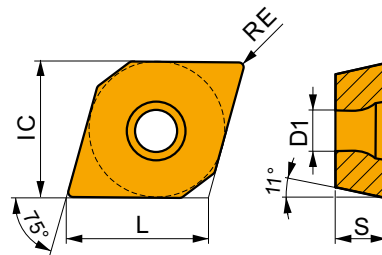

De geschiktheid en startwaarden voor de snijsnelheid (vc), voeding (f) en sneddiepte (ap). Raadpleeg onze verspaningscalculator app voor meer berekeningen.

Product	RE (mm)	P			M			K			N			S			H		
		vc (m/min)	f (mm/rev)	ap (mm)	vc (m/min)	f (mm/rev)	ap (mm)	vc (m/min)	f (mm/rev)	ap (mm)	vc (m/min)	f (mm/rev)	ap (mm)	vc (m/min)	f (mm/rev)	ap (mm)	vc (m/min)	f (mm/rev)	ap (mm)



NF2 geometrie, positief, voor fijn nabewerken tot semi voorbereken en ononderbroken snedes.

EPMT 050202E-NF2	H07	0.2	-	-	-	80	0.09	0.8	115	0.10	0.8	360	0.12	0.8	30	0.07	0.6	-	-	-
	T7325	0.2	150	0.07	0.8	110	0.06	0.8	-	-	-	-	-	-	45	0.06	0.6	-	-	-
	T7335	0.2	150	0.07	0.8	110	0.06	0.8	-	-	-	-	-	-	45	0.06	0.6	-	-	-
	T9315	0.2	150	0.05	0.8	-	-	-	115	0.05	0.8	-	-	-	-	-	-	-	-	-
	T9325	0.2	150	0.07	0.8	110	0.06	0.8	115	0.07	0.8	-	-	-	45	0.06	0.6	-	-	-
	T9335	0.2	140	0.10	0.8	110	0.09	0.8	-	-	-	-	-	-	34	0.07	0.6	-	-	-
	TT010	0.2	150	0.05	0.5	110	0.05	0.5	-	-	-	-	-	-	-	-	-	-	-	-



TCGT



	IC (mm)	D1 (mm)	L (mm)	S (mm)
06T1	3.970	2.20	6.90	1.98
0902	5.560	2.50	9.60	2.38
1102-SF3	6.350	2.80	11.00	2.58
16T3	9.525	4.40	16.50	3.97
16T3-SF3	9.525	4.40	16.50	4.22

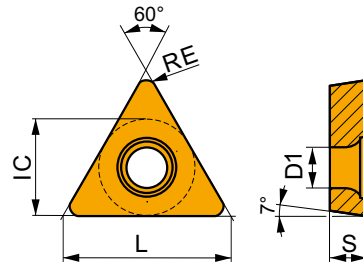

De geschiktheid en startwaarden voor de snij snelheid (vc), voeding (f) en sneddiepte (ap). Raadpleeg onze verspaningscalculator app voor meer berekeningen.

Product	RE (mm)	P			M			K			N			S			H		
		vc (m/min)	f (mm/rev)	ap (mm)	vc (m/min)	f (mm/rev)	ap (mm)	vc (m/min)	f (mm/rev)	ap (mm)	vc (m/min)	f (mm/rev)	ap (mm)	vc (m/min)	f (mm/rev)	ap (mm)	vc (m/min)	f (mm/rev)	ap (mm)



AL geometrie, zeer positieve uitvoering voor fijn nabewerken tot voorbereiden en voor ononderbroken tot onderbroken snedes.

TCGT 090202F-AL	HF7	0.2	-	-	-	-	-	-	-	360	0.12	1.0	-	-	-	-	-	-
	T0315	0.2	-	-	-	-	-	-	-	360	0.12	1.0	-	-	-	-	-	-
TCGT 090204F-AL	HF7	0.4	-	-	-	-	-	-	-	300	0.24	1.0	-	-	-	-	-	-
	T0315	0.4	-	-	-	-	-	-	-	300	0.24	1.0	-	-	-	-	-	-
TCGT 16T304F-AL	HF7	0.4	-	-	-	-	-	-	-	300	0.24	2.4	-	-	-	-	-	-
	T0315	0.4	-	-	-	-	-	-	-	300	0.24	2.4	-	-	-	-	-	-
TCGT 16T308F-AL	HF7	0.8	-	-	-	-	-	-	-	200	0.48	2.4	-	-	-	-	-	-
	T0315	0.8	-	-	-	-	-	-	-	200	0.48	2.4	-	-	-	-	-	-

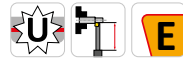
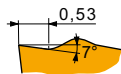

FF2 geometrie, positieve uitvoering voor fijn nabewerken tot nabewerken en ononderbroken tot licht onderbroken snedes.

TCGT 06T102E-FF2	T8330	0.2	150	0.05	0.8	-	-	-	115	0.05	0.8	-	-	-	-	-	-	-
	T8430	0.2	150	0.05	0.8	-	-	-	115	0.05	0.8	-	-	-	-	-	-	-
	TT010	0.2	150	0.05	0.5	-	-	-	-	-	-	-	-	-	-	-	-	-
TCGT 090202E-FF2	TT010	0.2	150	0.05	0.5	-	-	-	-	-	-	-	-	-	-	-	-	-

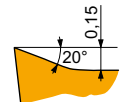

SF3 geometrie, zeer positief, voor fijn nabewerken tot nabewerken, en ononderbroken snedes.

TCGT 110204E-SF3	H07	0.4	-	-	-	80	0.09	0.8	115	0.10	0.8	360	0.12	0.8	30	0.07	0.6	-	-	-
	T6310	0.4	140	0.10	0.8	110	0.09	0.8	115	0.10	0.8	360	0.12	0.8	34	0.07	0.6	23	0.15	1.0
TCGT 16T308E-SF3	H07	0.8	-	-	-	90	0.09	1.2	115	0.10	1.2	360	0.12	1.2	34	0.08	1.0	-	-	-
	T6310	0.8	140	0.10	1.2	110	0.09	1.2	115	0.10	1.2	360	0.12	1.2	38	0.08	1.0	26	0.15	1.0



TCMT

	IC	D1	L	S
	(mm)	(mm)	(mm)	(mm)
06T1	3.970	2.20	6.90	1.98
0902	5.560	2.50	9.60	2.38
16T3	9.525	4.40	16.50	3.97

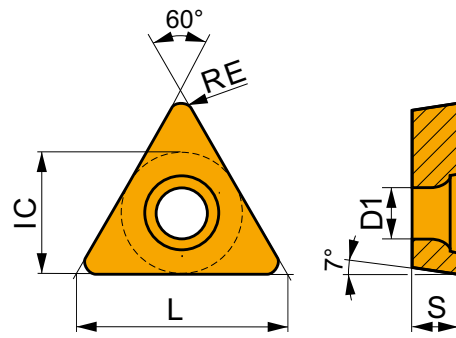

De geschiktheid en startwaarden voor de snijsnelheid (vc), voeding (f) en sneddiepte (ap). Raadpleeg onze verspaningscalculator app voor meer berekeningen.

Product	RE	P			M			K			N			S			H		
		vc	f	ap	vc	f	ap	vc	f	ap	vc	f	ap	vc	f	ap	vc	f	ap
	(mm)	(m/min)	(mm/rev)	(mm)	(m/min)	(mm/rev)	(mm)	(m/min)	(mm/rev)	(mm)	(m/min)	(mm/rev)	(mm)	(m/min)	(mm/rev)	(mm)	(m/min)	(mm/rev)	(mm)

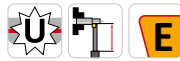
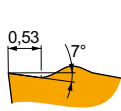

FF2 geometrie, positieve uitvoering voor fijn nabewerken tot nabewerken en ononderbroken tot licht onderbroken snedes.

TCMT 06T102E-FF2	T8330	0.2	█	150	0.05	0.8	█	–	–	–	█	115	0.05	0.8	–	–	–	–	–	–
	T8430	0.2	█	150	0.05	0.8	█	–	–	–	█	115	0.05	0.8	–	–	–	–	–	–
	T9315	0.2	█	150	0.05	0.8	█	–	–	–	█	115	0.05	0.8	–	–	–	–	–	–
TCMT 06T104E-FF2	T8330	0.4	█	140	0.12	0.8	█	–	–	–	█	110	0.12	0.8	–	–	–	–	–	–
	T8430	0.4	█	140	0.12	0.8	█	–	–	–	█	110	0.12	0.8	–	–	–	–	–	–
	T9325	0.4	█	140	0.12	0.8	█	–	–	–	█	110	0.12	0.8	–	–	–	–	–	–
TCMT 090204E-FF2	T8330	0.4	█	140	0.12	1.0	█	–	–	–	█	110	0.12	1.0	–	–	–	–	–	–
	T8430	0.4	█	140	0.12	1.0	█	–	–	–	█	110	0.12	1.0	–	–	–	–	–	–
	T9325	0.4	█	140	0.12	1.0	█	–	–	–	█	110	0.12	1.0	–	–	–	–	–	–
TCMT 16T304E-FF2	T8330	0.4	█	140	0.12	0.8	█	–	–	–	█	110	0.12	0.8	–	–	–	–	–	–
	T8430	0.4	█	140	0.12	0.8	█	–	–	–	█	110	0.12	0.8	–	–	–	–	–	–
	T9325	0.4	█	140	0.12	0.8	█	–	–	–	█	110	0.12	0.8	–	–	–	–	–	–
TCMT 16T308E-FF2	TT010	0.4	█	150	0.06	0.5	█	–	–	–	–	–	–	–	–	–	–	–	–	–
	T8330	0.8	█	130	0.17	0.8	█	–	–	–	█	105	0.17	0.8	–	–	–	–	–	–
	T8430	0.8	█	130	0.17	0.8	█	–	–	–	█	105	0.17	0.8	–	–	–	–	–	–
	T9325	0.8	█	130	0.17	0.8	█	–	–	–	█	105	0.17	0.8	–	–	–	–	–	–

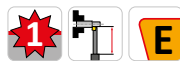

FM geometrie voor nabewerken tot semi voorbereken en ononderbroken tot licht onderbroken snedes.

TCMT 16T304E-FM	T7325	0.4	█	130	0.19	1.7	█	100	0.17	1.7	█	–	–	–	–	–	–	–	–	–	
	T8330	0.4	█	140	0.12	1.7	█	90	0.11	1.7	█	110	0.12	1.7	█	360	0.14	1.7	–	–	–
	T8430	0.4	█	140	0.12	1.7	█	90	0.11	1.7	█	110	0.12	1.7	█	360	0.14	1.7	–	–	–

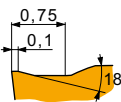

FM2 geometrie voor nabewerken tot medium bewerken en ononderbroken tot onderbroken snedes.

TCMT 16T308E-FM2	T8330	0.8	█	130	0.20	1.0	█	85	0.18	1.0	█	100	0.20	1.0	–	–	–	–	–	–
	T8430	0.8	█	130	0.20	1.0	█	85	0.18	1.0	█	100	0.20	1.0	–	–	–	–	–	–
	T9325	0.8	█	130	0.20	1.0	█	100	0.18	1.0	█	100	0.20	1.0	–	–	–	–	–	–

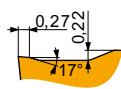

RM geometrie voor semi voorbereken tot voorbereken, en ononderbroken tot onderbroken snedes.

TCMT 16T308E-RM	T5315	0.8	█	120	0.27	1.9	█	–	–	–	█	95	0.27	1.9	–	–	–	–	–	–	
	T8330	0.8	█	120	0.27	1.9	█	85	0.24	1.9	█	95	0.27	1.9	–	–	–	█	26	0.19	1.5
	T8430	0.8	█	120	0.27	1.9	█	85	0.24	1.9	█	95	0.27	1.9	–	–	–	█	23	0.19	1.5



De geschiktheid en startwaarden voor de snijsnelheid (vc), voeding (f) en sneddiepte (ap). Raadpleeg onze verspaningscalculator app voor meer berekeningen.

Product	RE (mm)	P			M			K			N			S			H		
		vc (m/min)	f (mm/rev)	ap (mm)	vc (m/min)	f (mm/rev)	ap (mm)	vc (m/min)	f (mm/rev)	ap (mm)	vc (m/min)	f (mm/rev)	ap (mm)	vc (m/min)	f (mm/rev)	ap (mm)	vc (m/min)	f (mm/rev)	ap (mm)

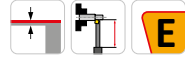
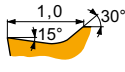

UR geometrie voor fijn nabewerken tot nabewerken, en ononderbroken tot licht onderbroken snedes.

TCMT 16T304E-UR	T8330	0.4	135	0.12	0.8	80	0.11	0.8	110	0.12	0.8	-	-	-	-	-	-	-
	T8430	0.4	140	0.12	0.8	85	0.11	0.8	110	0.12	0.8	-	-	-	-	-	-	-
	T9325	0.4	130	0.18	0.8	100	0.16	0.8	105	0.18	0.8	-	-	-	-	-	-	-
	TT310	0.4	140	0.12	0.8	110	0.11	0.8	-	-	-	-	-	-	-	-	-	-
TCMT 16T308E-UR	T8330	0.8	130	0.17	0.8	90	0.15	0.8	105	0.17	0.8	-	-	-	-	-	-	-
	T8430	0.8	130	0.17	0.8	90	0.15	0.8	105	0.17	0.8	-	-	-	-	-	-	-
	T9325	0.8	130	0.17	0.8	100	0.15	0.8	105	0.17	0.8	-	-	-	-	-	-	-

TCMW



	IC (mm)	D1 (mm)	L (mm)	S (mm)
16T3	9.525	4.40	16.50	3.97

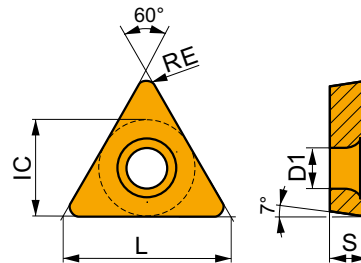

De geschiktheid en startwaarden voor de snijsnelheid (vc), voeding (f) en sneddiepte (ap). Raadpleeg onze verspaningscalculator app voor meer berekeningen.

Product	RE (mm)	P			M			K			N			S			H		
		vc (m/min)	f (mm/rev)	ap (mm)	vc (m/min)	f (mm/rev)	ap (mm)	vc (m/min)	f (mm/rev)	ap (mm)	vc (m/min)	f (mm/rev)	ap (mm)	vc (m/min)	f (mm/rev)	ap (mm)	vc (m/min)	f (mm/rev)	ap (mm)

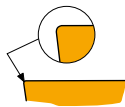

Voor fijn nabewerken tot semi voorbereken en ononderbroken en licht onderbroken snedes.

TCMW 16T304	T5305	0.4	-	-	-	-	-	-	115	0.10	1.5	-	-	-	-	-	-	30	0.15	1.0
	T5315	0.4	-	-	-	-	-	-	115	0.10	1.5	-	-	-	-	-	-	26	0.15	1.0
	T6310	0.4	-	-	-	-	-	-	85	0.10	1.5	-	-	-	-	-	-	15	0.15	1.0
TCMW 16T308	T5305	0.8	-	-	-	-	-	-	105	0.18	1.5	-	-	-	-	-	-	30	0.15	1.0
	T5315	0.8	-	-	-	-	-	-	105	0.18	1.5	-	-	-	-	-	-	26	0.15	1.0
	T6310	0.8	-	-	-	-	-	-	85	0.18	1.5	-	-	-	-	-	-	15	0.15	1.0



BASISHOUDERS



BASISHOUDERS - CODERING

1	2	3	4	5
AS 3	30	022	100	R

1		2	3	4		5	
Type basishouder		Schacht	Grootte	Lengte PM		Uitvoering	
AS 3	DIN 69871	30	022	055	55 mm	R	Interne koelkanalen
BT 3	MAS BT	40	027	100	100 mm		
HSK	HSK	63A	032				
OTT 3	DIN 2080	50	042				
3	MORSE	05	054				
B	WELDON	25	068				
P	VERLENGING		085				
R	REDUCERING		100				
ADT	ADAPTOR		200				
			300				
			400				
			500				



69871-BS



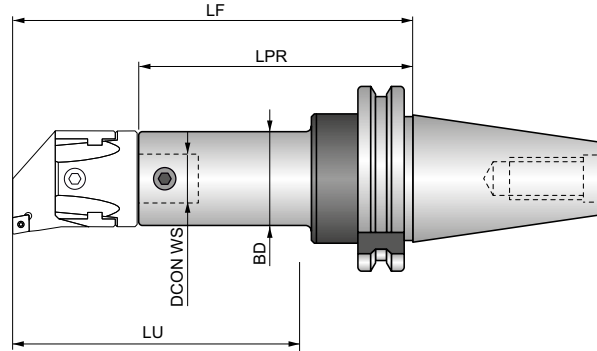

Basishouder voor kotterkop, DIN 69871

DIN 69871 zeer stabiele gereedschapshouder (voor MTC) voor kotterkoppen in SK40 en SK50. Verschillende lengte gereedschapshouders beschikbaar. Koppelmaten 22 - 160 mm kunnen worden gebruikt in combinatie met EXT-BS verlengstukken, RED-BS reduceerstukken en LA-BS verloopstukken. Interne koelvloeistof beschikbaar. Voor toepassingen die een hoge nauwkeurigheid en herhaalbaarheid vereisen.



Product		CZC MS	BD	DCON WS	LF	LPR	LU			
AS 330 022 100 R	30	22	22.00	12.00	138.00	104	100.00	✓	US 0608	0.72
AS 330 027 055 R	30	27	27.00	15.00	90.00	48	55.00	✓	US 0609	0.56
AS 330 027 100 R	30	27	27.00	15.00	138.00	96	100.00	✓	US 0609	0.68
AS 330 032 060 R	30	32	32.00	20.00	96.00	51	60.00	✓	US 0810	0.51
AS 330 032 100 R	30	32	32.00	20.00	138.00	93	100.00	✓	US 0810	0.74
AS 340 022 080 R	40	22	22.00	12.00	118.00	84	80.00	✓	US 0608	1.14
AS 340 022 100 R	40	22	22.00	12.00	138.00	104	100.00	✓	US 0608	1.24
AS 340 027 055 R	40	27	27.00	15.00	90.00	48	55.00	✓	US 0609	1.05
AS 340 027 100 R	40	27	27.00	15.00	138.00	96	100.00	✓	US 0609	1.30
AS 340 027 130 R	40	27	27.00	15.00	168.00	126	130.00	✓	US 0609	1.43
AS 340 032 060 R	40	32	32.00	20.00	96.00	51	60.00	✓	US 0810	1.10
AS 340 032 100 R	40	32	32.00	20.00	138.00	93	100.00	✓	US 0810	1.35
AS 340 032 130 R	40	32	32.00	20.00	168.00	123	130.00	✓	US 0810	1.52
AS 340 042 075 R	40	42	42.00	24.00	112.00	56	75.00	✓	US 1014	1.16
AS 340 042 160 R	40	42	42.00	24.00	182.00	126	160.00	✓	US 1014	1.90
AS 340 042 200 R	40	42	42.00	24.00	222.00	166	200.00	✓	US 1014	2.37
AS 340 054 120 R	40	54	54.00	28.00	142.00	76	120.00	✓	US 1219	1.58
AS 340 054 160 R	40	54	54.00	28.00	182.00	116	160.00	✓	US 1219	2.28
AS 340 054 200 R	40	54	54.00	28.00	222.00	156	200.00	✓	US 1219	2.93
AS 340 068 160 R	40	68	68.00	36.00	183.00	97	160.00	✓	US 1625	2.36
AS 340 068 200 R	40	68	68.00	36.00	223.00	137	200.00	✓	US 1625	3.50
AS 340 085 200 R	40	85	85.00	50.00	224.00	124	200.00	✓	US 1630	3.96
AS 340 100 200 R	40	100, 200	100.00	60.00	224.00	124	200.00	✓	US 2032	5.21
AS 350 022 080 R	50	22	22.00	12.00	118.00	84	80.00	✓	US 0608	3.43
AS 350 022 100 R	50	22	22.00	12.00	138.00	104	100.00	✓	US 0608	3.40
AS 350 027 055 R	50	27	27.00	15.00	90.00	48	55.00	✓	US 0609	3.30
AS 350 027 100 R	50	27	27.00	15.00	138.00	96	100.00	✓	US 0609	3.48
AS 350 027 130 R	50	27	27.00	15.00	168.00	126	130.00	✓	US 0609	3.48
AS 350 032 060 R	50	32	32.00	20.00	96.00	51	60.00	✓	US 0810	2.98
AS 350 032 130 R	50	32	32.00	20.00	168.00	123	130.00	✓	US 0810	3.71
AS 350 032 160 R	50	32	32.00	20.00	198.00	153	160.00	✓	US 0810	3.95
AS 350 042 075 R	50	42	42.00	24.00	112.00	56	75.00	✓	US 1014	3.32
AS 350 042 160 R	50	42	42.00	24.00	198.00	142	160.00	✓	US 1014	4.26
AS 350 042 200 R	50	42	42.00	24.00	238.00	182	200.00	✓	US 1014	4.74



Product		CZC MS	BD	DCON WS	LF	LPR	LU			
			(mm)	(mm)	(mm)	(mm)	(mm)			
AS 350 054 090 R	50	54	54.00	28.00	128.00	62	90.00	✓	US 1219	3.39
AS 350 054 160 R	50	54	54.00	28.00	198.00	132	160.00	✓	US 1219	4.74
AS 350 054 200 R	50	54	54.00	28.00	238.00	172	200.00	✓	US 1219	5.48
AS 350 068 115 R	50	68	68.00	36.00	151.00	65	115.00	✓	US 1625	3.66
AS 350 068 200 R	50	68	68.00	36.00	223.00	137	200.00	✓	US 1625	5.81
AS 350 068 260 R	50	68	68.00	36.00	283.00	197	260.00	✓	US 1625	7.48
AS 350 085 200 R	50	85	85.00	50.00	224.00	124	200.00	✓	US 1630	6.21
AS 350 085 260 R	50	85	85.00	50.00	284.00	184	260.00	✓	US 1630	8.91
AS 350 085 320 R	50	85	85.00	50.00	344.00	244	320.00	✓	US 1630	11.50
AS 350 100 190 R	50	100, 200	100.00	60.00	214.00	114	190.00	✓	US 2032	6.52
AS 350 100 260 R	50	100, 200	100.00	60.00	284.00	184	260.00	✓	US 2032	10.85
AS 350 100 320 R	50	100, 200	100.00	60.00	344.00	244	320.00	✓	US 2032	14.47
AS 550 160	50	300, 400, 500	100.00	60.00	160.00	70	125.00	–	US 1240	5.55



BT-BS





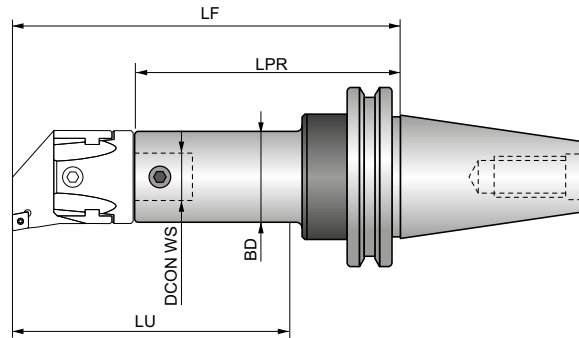

Basishouder voor koperkop, MAS 403-BT

MAS 403-BT zeer stabiele gereedschapshouder (voor ATC) voor kopperkoppen, verkrijgbaar in SK30, SK40 en SK50. Verschillende lengte gereedschapshouders beschikbaar. Aansluitmaten 22-160 mm kunnen worden gebruikt met EXT-BS verlengstukken, RED-BS reduceerstukken LA-BS verloopstukken. Voorzien van interne koelvloeistofdoorvoer. Voor toepassingen die een hoge nauwkeurigheid en repeteerbaarheid vereisen.



Product		CZC MS	BD	DCON WS	LF	LPR	LU			
BT 330 022 100 R	30	22	22.00	12.00	125.00	91	100.00	✓	US 0608	0.56
BT 330 027 055 R	30	27	27.00	15.00	77.00	35	55.00	✓	US 0609	0.41
BT 330 027 100 R	30	27	27.00	15.00	125.00	83	100.00	✓	US 0609	0.69
BT 330 032 060 R	30	32	32.00	20.00	83.00	38	60.00	✓	US 0810	0.47
BT 330 032 100 R	30	32	32.00	20.00	125.00	80	100.00	✓	US 0810	0.70
BT 330 042 075 R	30	42	42.00	24.00	100.00	44	75.00	✓	US 1014	0.56
BT 340 022 050 R	40	22	22.00	12.00	80.00	46	50.00	✓	US 0608	1.02
BT 340 022 080 R	40	22	22.00	12.00	110.00	76	80.00	✓	US 0608	1.16
BT 340 022 100 R	40	22	22.00	12.00	130.00	96	100.00	✓	US 0608	1.14
BT 340 027 055 R	40	27	27.00	15.00	82.00	40	55.00	✓	US 0609	1.06
BT 340 027 100 R	40	27	27.00	15.00	130.00	88	100.00	✓	US 0609	1.26
BT 340 027 130 R	40	27	27.00	15.00	160.00	118	130.00	✓	US 0609	1.39
BT 340 032 060 R	40	32	32.00	20.00	88.00	43	60.00	✓	US 0810	1.00
BT 340 032 100 R	40	32	32.00	20.00	130.00	85	100.00	✓	US 0810	1.31
BT 340 032 130 R	40	32	32.00	20.00	160.00	115	130.00	✓	US 0810	1.50
BT 340 042 075 R	40	42	42.00	24.00	104.00	48	75.00	✓	US 1014	1.14
BT 340 042 160 R	40	42	42.00	24.00	190.00	134	160.00	✓	US 1014	2.05
BT 340 042 200 R	40	42	42.00	24.00	230.00	174	200.00	✓	US 1014	2.39
BT 340 054 090 R	40	54	54.00	28.00	120.00	54	90.00	✓	US 1219	1.13
BT 340 054 160 R	40	54	54.00	28.00	190.00	124	160.00	✓	US 1219	2.55
BT 340 054 200 R	40	54	54.00	28.00	230.00	164	200.00	✓	US 1219	3.10
BT 340 068 160 R	40	68	68.00	36.00	181.00	95	160.00	✓	US 1625	2.46
BT 340 068 200 R	40	68	68.00	36.00	221.00	135	200.00	✓	US 1625	3.64
BT 340 085 200 R	40	85	85.00	50.00	220.00	120	200.00	✓	US 1630	4.04
BT 340 100 200 R	40	100	100.00	60.00	220.00	120	200.00	✓	US 2032	4.95
BT 350 022 080 R	50	22	22.00	12.00	121.00	87	80.00	✓	US 0608	3.95
BT 350 022 100 R	50	22	22.00	12.00	141.00	107	100.00	✓	US 0608	3.50
BT 350 027 055 R	50	27	27.00	15.00	93.00	51	55.00	✓	US 0609	3.68
BT 350 027 100 R	50	27	27.00	15.00	141.00	99	100.00	✓	US 0609	4.00
BT 350 027 130 R	50	27	27.00	15.00	171.00	129	130.00	✓	US 0609	4.14
BT 350 032 060 R	50	32	32.00	20.00	99.00	54	60.00	✓	US 0810	3.67
BT 350 032 130 R	50	32	32.00	20.00	171.00	126	130.00	✓	US 0810	4.24
BT 350 032 160 R	50	32	32.00	20.00	201.00	156	160.00	✓	US 0810	4.56
BT 350 042 075 R	50	42	42.00	24.00	115.00	59	75.00	✓	US 1014	3.84



Product		CZC MS	BD	DCON WS	LF	LPR	LU			
			(mm)	(mm)	(mm)	(mm)	(mm)			
BT 350 042 160 R	50	42	42.00	24.00	201.00	145	160.00	✓	US 1014	4.89
BT 350 042 200 R	50	42	42.00	24.00	241.00	185	200.00	✓	US 1014	5.25
BT 350 054 090 R	50	54	54.00	28.00	131.00	65	90.00	✓	US 1219	3.90
BT 350 054 160 R	50	54	54.00	28.00	201.00	135	160.00	✓	US 1219	5.39
BT 350 054 200 R	50	54	54.00	28.00	241.00	175	200.00	✓	US 1219	5.98
BT 350 068 115 R	50	68	68.00	36.00	154.00	68	115.00	✓	US 1625	4.09
BT 350 068 200 R	50	68	68.00	36.00	242.00	156	200.00	✓	US 1625	6.66
BT 350 068 260 R	50	68	68.00	36.00	302.00	216	260.00	✓	US 1625	8.18
BT 350 085 200 R	50	85	85.00	50.00	242.00	142	200.00	✓	US 1630	7.40
BT 350 085 260 R	50	85	85.00	50.00	302.00	202	260.00	✓	US 1630	9.89
BT 350 085 320 R	50	85	85.00	50.00	362.00	262	320.00	✓	US 1630	12.76
BT 350 100 170 R	50	100, 200	100.00	60.00	195.00	95	170.00	✓	US 2032	5.71
BT 350 100 260 R	50	100, 200	100.00	60.00	302.00	202	260.00	✓	US 2032	12.34
BT 350 100 320 R	50	100, 200	100.00	60.00	362.00	262	320.00	✓	US 2032	14.50
BT 550 160	50	300, 400, 500	100.00	60.00	160.00	70	125.00	–	US 1240	6.05



HSK-BS



Basishouder voor kotterkop, HSK

HSK zeer stabiele gereedschapshouder (voor ATC) voor boorkoppen, leverbaar met 50A, 63A of 100A conus. Koppelmaten 22 tot 160 mm kunnen worden gebruikt in combinatie met EXT-BS verlengstukken, RED-BS reduceerstukken en LA-BS verloopstukken. Interne koelvloeistof doorvoer beschikbaar. Voor toepassingen die een hoge nauwkeurigheid en herhaalbaarheid vereisen.

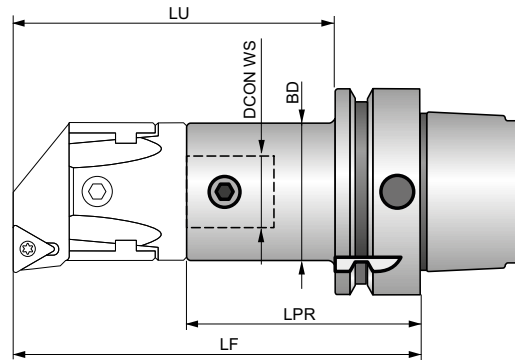

Product		CZC MS	BD	DCON WS	LF	LPR	LU			
HSK 050A 022 055	50	22	22.00	12.00	81.00	47	55.00	–	US 0608	0.49
HSK 050A 027 065	50	27	27.00	15.00	91.00	49	65.00	–	US 0609	0.49
HSK 050A 032 075	50	32	32.00	20.00	101.00	56	75.00	–	US 0810	0.66
HSK 050A 042 090	50	42	42.00	24.00	116.00	60	90.00	–	US 1014	0.71
HSK 063A 022 055	63	22	22.00	12.00	81.00	47	55.00	–	US 0608	0.07
HSK 063A 027 065	63	27	27.00	15.00	91.00	49	65.00	–	US 0609	0.76
HSK 063A 032 075	63	32	32.00	20.00	101.00	56	75.00	–	US 0810	0.82
HSK 063A 042 090	63	42	42.00	24.00	116.00	60	90.00	–	US 1014	0.96
HSK 063A 054 110	63	54	54.00	28.00	136.00	70	110.00	–	US 1219	1.26
HSK 063A 068 145	63	68	68.00	36.00	171.00	85	145.00	–	US 1625	1.81
HSK 100A 022 055	100	22	22.00	12.00	89.00	55	55.00	–	US 0608	2.28
HSK 100A 027 065	100	27	27.00	15.00	99.00	57	65.00	–	US 0609	2.34
HSK 100A 032 075	100	32	32.00	20.00	104.00	59	75.00	–	US 0810	2.73
HSK 100A 042 090	100	42	42.00	24.00	119.00	63	90.00	–	US 1014	2.45
HSK 100A 054 110	100	54	54.00	28.00	139.00	73	110.00	–	US 1219	2.79
HSK 100A 068 145	100	68	68.00	36.00	174.00	88	145.00	–	US 1625	3.52
HSK 100A 085 165	100	85	85.00	50.00	194.00	94	165.00	–	US 1630	4.15
HSK 100A 100 185	100	100, 200	100.00	60.00	214.00	114	185.00	–	US 2032	5.63
HSK 550 160	100	300, 400, 500	100.00	60.00	170.00	80	140.00	–	US 1240	5.24



2080-BS





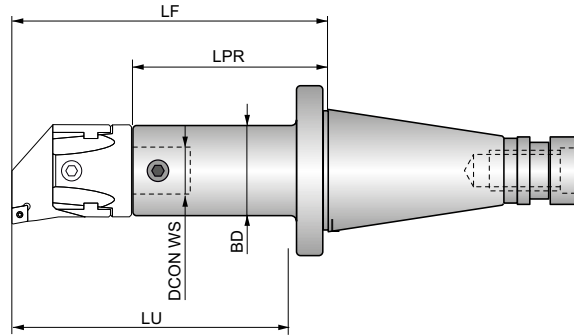

Basishouder voor koterkop, DIN 2080

DIN 2080 zeer stabiele gereedschapshouder (voor MTC) voor koterkoppen in SK40 en SK50. Verschillende lengte gereedschapshouders beschikbaar. Koppelmaten 22 - 160 mm kunnen worden gebruikt in combinatie met EXT-BS verlengstukken, RED-BS reduceerstukken en LA-BS verloopstukken. Interne koelvloeistof beschikbaar. Voor toepassingen die een hoge nauwkeurigheid en herhaalbaarheid vereisen.



Product		CZC MS	BD	DCON WS	LF	LPR	LU			
OTT 340 022 080 R	40	22	22.00	12.00	95.00	61	80.00	✓	US 0608	0.88
OTT 340 022 100 R	40	22	22.00	12.00	115.00	81	100.00	✓	US 0608	0.94
OTT 340 027 055 R	40	27	27.00	15.00	67.00	25	55.00	✓	US 0609	0.86
OTT 340 027 100 R	40	27	27.00	15.00	115.00	73	100.00	✓	US 0609	1.00
OTT 340 027 130 R	40	27	27.00	15.00	145.00	103	130.00	✓	US 0609	1.12
OTT 340 032 060 R	40	32	32.00	20.00	73.00	28	60.00	✓	US 0810	0.90
OTT 340 032 100 R	40	32	32.00	20.00	115.00	70	100.00	✓	US 0810	1.10
OTT 340 032 130 R	40	32	32.00	20.00	145.00	100	130.00	✓	US 0810	1.22
OTT 340 042 075 R	40	42	42.00	24.00	89.00	33	75.00	✓	US 1014	0.89
OTT 340 042 160 R	40	42	42.00	24.00	175.00	119	160.00	✓	US 1014	1.73
OTT 340 042 200 R	40	42	42.00	24.00	215.00	159	200.00	✓	US 1014	2.30
OTT 340 054 090 R	40	54	54.00	28.00	105.00	39	90.00	✓	US 1219	1.08
OTT 340 054 160 R	40	54	54.00	28.00	175.00	109	160.00	✓	US 1219	2.23
OTT 340 054 200 R	40	54	54.00	28.00	215.00	149	200.00	✓	US 1219	3.06
OTT 340 068 160 R	40	68	68.00	36.00	175.00	90	160.00	✓	US 1625	2.40
OTT 340 068 200 R	40	68	68.00	36.00	216.00	130	200.00	✓	US 1625	3.73
OTT 340 085 200 R	40	85	85.00	50.00	211.00	111	200.00	✓	US 1630	4.03
OTT 340 100 200 R	40	100, 200	100.00	60.00	211.00	111	200.00	✓	US 2032	5.05
OTT 350 022 080 R	50	22	22.00	12.00	99.00	65	80.00	✓	US 0608	2.98
OTT 350 022 100 R	50	22	22.00	12.00	119.00	85	100.00	✓	US 0608	2.97
OTT 350 027 055 R	50	27	27.00	15.00	71.00	29	55.00	✓	US 0609	2.93
OTT 350 027 100 R	50	27	27.00	15.00	119.00	77	100.00	✓	US 0609	3.01
OTT 350 027 130 R	50	27	27.00	15.00	149.00	107	130.00	✓	US 0609	3.10
OTT 350 032 060 R	50	32	32.00	20.00	77.00	32	60.00	✓	US 0810	2.81
OTT 350 032 130 R	50	32	32.00	20.00	149.00	104	130.00	✓	US 0810	3.24
OTT 350 032 160 R	50	32	32.00	20.00	179.00	134	160.00	✓	US 0810	3.26
OTT 350 042 075 R	50	42	42.00	24.00	93.00	37	75.00	✓	US 1014	2.74
OTT 350 042 160 R	50	42	42.00	24.00	179.00	123	160.00	✓	US 1014	3.64
OTT 350 042 200 R	50	42	42.00	24.00	219.00	163	200.00	✓	US 1014	4.05
OTT 350 054 090 R	50	54	54.00	28.00	109.00	43	90.00	✓	US 1219	3.02
OTT 350 054 160 R	50	54	54.00	28.00	179.00	113	160.00	✓	US 1219	4.15
OTT 350 054 200 R	50	54	54.00	28.00	219.00	153	200.00	✓	US 1219	5.08
OTT 350 068 115 R	50	68	68.00	36.00	132.00	46	115.00	✓	US 1625	3.20
OTT 350 068 200 R	50	68	68.00	36.00	220.00	134	200.00	✓	US 1625	5.54



Product		CZC MS	BD	DCON WS	LF	LPR	LU			
			(mm)	(mm)	(mm)	(mm)	(mm)			
OTT 350 068 260 R	50	68	68.00	36.00	280.00	194	260.00	✓	US 1625	7.22
OTT 350 085 200 R	50	85	85.00	50.00	221.00	121	200.00	✓	US 1630	6.21
OTT 350 085 260 R	50	85	85.00	50.00	281.00	181	260.00	✓	US 1630	9.07
OTT 350 085 320 R	50	85	85.00	50.00	341.00	241	320.00	✓	US 1630	11.84
OTT 350 100 170 R	50	100, 200	100.00	60.00	193.00	93	170.00	✓	US 2032	5.60
OTT 350 100 260 R	50	100, 200	100.00	60.00	281.00	181	260.00	✓	US 2032	10.78
OTT 350 100 320 R	50	100, 200	100.00	60.00	341.00	241	320.00	✓	US 2032	15.10
OTT 550 160	50	300, 400, 500	100.00	60.00	160.00	70	125.00	–	US 1240	5.90



MOR-BS



Basishouder voor kotterkop, morseconus

Morseconus 5, zeer starre gereedschaphouder voor kotterkoppen. Verschillende lengte gereedschaphouders beschikbaar. Koppelmaten 22 t/m 160 mm kunnen worden gebruikt in combinatie met EXT-BS verlengers, RED-BS verloopstukken en LA-BS verloopstukken. Interne koelkanaal beschikbaar. Voor toepassingen die een hoge nauwkeurigheid en repeteerbaarheid vereisen.

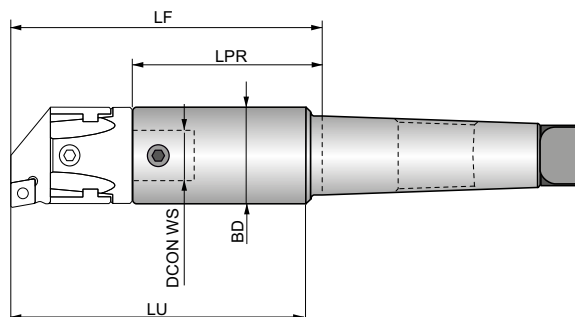

Product	CCTMS	CZC MS	BD	DCON WS	LF	LPR	LU			
			(mm)	(mm)	(mm)	(mm)	(mm)			
305 022 100	5	22	22.00	12.00	112.00	78	100.00	–	US 0608	1.64
305 022 130	5	22	22.00	12.00	142.00	108	130.00	–	US 0608	1.76
305 027 055	5	27	27.00	15.00	65.00	23	55.00	–	US 0609	1.58
305 027 100	5	27	27.00	15.00	113.00	71	100.00	–	US 0609	1.69
305 027 130	5	27	27.00	15.00	143.00	101	130.00	–	US 0609	1.84
305 032 060	5	32	32.00	20.00	70.00	25	60.00	–	US 0810	1.54
305 032 130	5	32	32.00	20.00	143.00	98	130.00	–	US 0810	1.95
305 032 160	5	32	32.00	20.00	173.00	128	160.00	–	US 0810	2.13
305 042 075	5	42	42.00	24.00	83.00	27	75.00	–	US 1014	1.50
305 042 130	5	42	42.00	24.00	188.00	86	130.00	–	US 1014	2.18
305 042 160	5	42	42.00	24.00	218.00	116	160.00	–	US 1014	2.51
305 054 160	5	54	54.00	28.00	172.00	106	160.00	–	US 1219	3.00
305 054 200	5	54	54.00	28.00	212.00	146	200.00	–	US 1219	3.63
305 068 140	5	68	68.00	36.00	146.00	60	140.00	–	US 1625	2.53
305 068 200	5	68	68.00	36.00	212.00	126	200.00	–	US 1625	4.47
305 068 260	5	68	68.00	36.00	272.00	186	260.00	–	US 1625	6.20
305 085 200	5	85	85.00	50.00	216.00	116	200.00	–	US 1630	5.40
305 085 260	5	85	85.00	50.00	276.00	176	260.00	–	US 1630	8.45
305 085 320	5	85	85.00	50.00	336.00	236	320.00	–	US 1630	0.01
305 100 260	5	100, 200	100.00	60.00	276.00	176	260.00	–	US 2032	7.95
305 100 320	5	100, 200	100.00	60.00	336.00	236	320.00	–	US 2032	11.39
505 160	5	300, 400, 500	100.00	60.00	146.00	56	140.00	–	US 2032	4.70



WEL-BS



Basishouder voor koterkop, Weldon

Zeer stabiele Weldon gereedschapshouders voor koterkoppen, schachtdiameters van 20 t/m 40 mm. Verschillende lengte gereedschapshouders beschikbaar. Koppelmaten 22 t/m 42 mm kunnen worden gebruikt in combinatie met EXT-BS verlengstukken en RED-BS reduceerstukken. Interne koelvloeistof beschikbaar. Voor toepassingen die een hoge nauwkeurigheid en herhaalbaarheid vereisen.

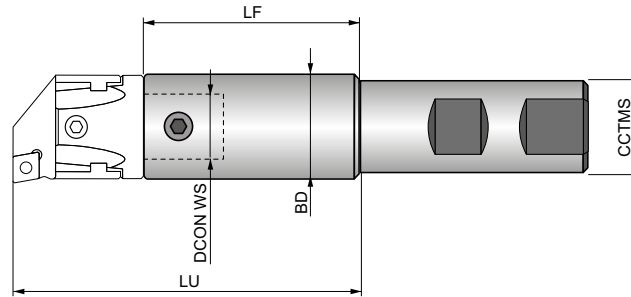

Product	CCTMS	CZC MS	BD	DCON WS	LU			
			(mm)	(mm)	(mm)			kg
B 020 022 050	20	22	22.00	12.00	50.00	–	US 0608	0.17
B 020 022 100	20	22	22.00	12.00	100.00	–	US 0608	0.34
B 025 027 055	25	27	27.00	15.00	55.00	–	US 0609	0.17
B 025 027 100	25	27	27.00	15.00	95.00	–	US 0609	0.46
B 032 032 060	32	32	32.00	20.00	60.00	–	US 0810	0.43
B 032 032 100	32	32	32.00	20.00	100.00	–	US 0810	0.69
B 032 032 160	32	32	32.00	20.00	160.00	–	US 0810	1.11
B 032 042 090	32	32	32.00	24.00	90.00	–	US 0810	0.71
B 040 042 090	40	42	42.00	24.00	90.00	–	US 1014	0.98
B 040 042 160	40	42	42.00	24.00	160.00	–	US 1014	1.79



EXT-BS



Verlengstuk voor koterkop

Verlengstuk voor koterkop. Systeemgrootte van 22 t/m 200 mm en in verschillende lengtes verkrijgbaar. Interne en externe koelvloeistopties beschikbaar. Geschikt voor alle toepassingen die een hoge nauwkeurigheid en herhaalbaarheid vereisen.

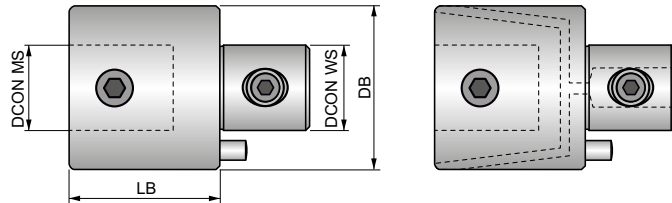

Product	CZC MS	BD	DCON MS	DCON WS	LB			
		(mm)	(mm)	(mm)	(mm)			
P 022 030 R	22	22.00	12.00	12.00	30.00	✓	US 0608	0.09
P 027 030 R	27	27.00	15.00	15.00	30.00	✓	US 0609	0.13
P 032 035 R	32	32.00	20.00	20.00	35.00	✓	US 0810	0.20
P 042 040 R	42	42.00	24.00	24.00	40.00	✓	US 1014	0.40
P 054 050 R	54	54.00	28.00	28.00	50.00	✓	US 1219	0.85
P 068 060 R	68	68.00	36.00	36.00	60.00	✓	US 1625	1.61
P 085 070 R	85	85.00	50.00	50.00	70.00	✓	US 1630	2.88
P 100 080 R	100, 200	100.00	60.00	60.00	80.00	✓	US 2032	4.48
P 022 020	22	22.00	12.00	12.00	20.00	–	US 0608	0.06
P 022 030	22	22.00	12.00	12.00	30.00	–	US 0608	0.09
P 027 030	27	27.00	15.00	15.00	30.00	–	US 0609	0.13
P 027 045	27	27.00	15.00	15.00	45.00	–	US 0609	0.19
P 032 035	32	32.00	20.00	20.00	35.00	–	US 0810	0.20
P 032 052	32	32.00	20.00	20.00	52.00	–	US 0810	0.30
P 042 040	42	42.00	24.00	24.00	40.00	–	US 1014	0.40
P 042 060	42	42.00	24.00	24.00	60.00	–	US 1014	0.60
P 054 050	54	54.00	28.00	28.00	50.00	–	US 1219	0.87
P 054 075	54	54.00	28.00	28.00	75.00	–	US 1219	1.30
P 068 060	68	68.00	36.00	36.00	60.00	–	US 1625	1.63
P 068 090	68	68.00	36.00	36.00	90.00	–	US 1625	2.44
P 085 070	85	85.00	50.00	50.00	70.00	–	US 1630	2.86
P 085 105	85	85.00	50.00	50.00	105.00	–	US 1630	4.46
P 100 080	100, 200	100.00	60.00	60.00	80.00	–	US 2032	4.44
P 100 120	100, 200	100.00	60.00	60.00	120.00	–	US 2032	6.91



RED-BS



Reduceerstuk voor kotterkop

Boorkop reduceerstuk. Koppelmaten van 27 t/m 100 mm en in verschillende lengtes verkrijgbaar. Alleen externe koelvloeistof. Geschikt voor alle toepassingen die een hoge nauwkeurigheid en herhaalbaarheid vereisen.

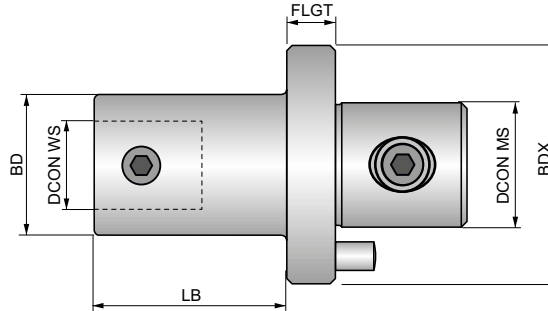

Product	CZC MS	BDX	DCON MS	BD	DCON WS	LB	FLGT			
		(mm)	(mm)	(mm)	(mm)	(mm)	(mm)			
R 027 022 036	22	27.00	15.00	22	12.00	26.00	10	–	US 0608	0.11
R 042 022 058	22	42.00	24.00	22	12.00	48.00	10	–	US 0608	0.31
R 032 022 040	22	32.00	20.00	22	12.00	30.00	10	–	US 0608	0.17
R 054 022 086	22	54.00	28.00	22	12.00	76.00	10	–	US 0608	0.51
R 068 022 102	22	68.00	36.00	22	12.00	90.00	12	–	US 0608	0.90
R 054 027 080	27	54.00	28.00	27	15.00	70.00	10	–	US 0609	0.63
R 032 027 034	27	32.00	20.00	27	15.00	24.00	10	–	US 0609	0.18
R 042 027 050	27	42.00	24.00	27	15.00	40.00	10	–	US 0609	0.33
R 068 027 095	27	68.00	36.00	27	15.00	83.00	12	–	US 0609	0.97
R 042 032 046	32	42.00	24.00	32	20.00	36.00	10	–	US 0810	0.36
R 054 032 076	32	54.00	28.00	32	20.00	66.00	10	–	US 0810	0.63
R 068 032 090	32	68.00	36.00	32	20.00	78.00	12	–	US 0810	1.08
R 054 042 070	42	54.00	28.00	42	24.00	60.00	10	–	US 1014	0.81
R 068 042 082	42	68.00	36.00	42	24.00	70.00	12	–	US 1014	1.26
R 085 042 095	42	85.00	50.00	42	24.00	83.00	12	–	US 1014	2.06
R 068 054 072	54	68.00	36.00	54	28.00	60.00	12	–	US 1219	1.51
R 085 054 090	54	85.00	50.00	54	28.00	78.00	12	–	US 1219	2.44
R 085 068 100	68	85.00	50.00	68	36.00	88.00	12	–	US 1625	3.32
R 100 085 100	85	100.00	60.00	85	50.00	88.00	12	–	US 1630	5.05



LA-BS



Verloopstuk voor kotterkop

Vergroot adapter voor kotterkop. Verkrijgbaar in koppelmaat 100 mm en in verschillende diameters voor een grotere flexibiliteit. Alleen externe koelvloeistof. Geschikt voor alle toepassingen die een hoge nauwkeurigheid en reproduceerbaarheid vereisen.

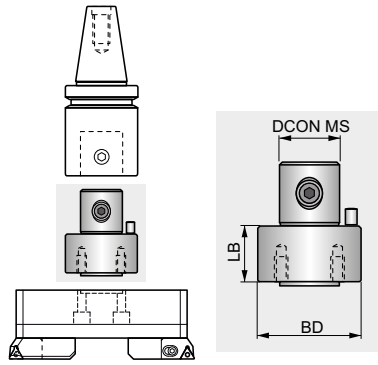

Product	CZC MS	BD (mm)	DCON MS (mm)	LB (mm)			
ADT 100 050	300, 400, 500	100.00	60.00	50.00	–	US 1240	4.35



KOTTERSETS



CODERING VAN DE KOTTERSETS

1	2	3	4	5
BS	54	KIT	RC	8-43

1		2	3		4		5
Type gereedschap		Grootte	Type		ISO boorbeitel		Gat diameterbereik
BS	Kottersysteem	54	KIT	Gereedschapset	RC	Voor wisselplaatvorm C $\kappa = 95^\circ$	8 – 43 (mm)
							8 – 100 (mm)
BS	Kottersysteem	54	KIT	Gereedschapset	TC	Voor wisselplaatvorm T $\kappa = 90^\circ$	8 – 170 (mm)
							8 – 210 (mm)

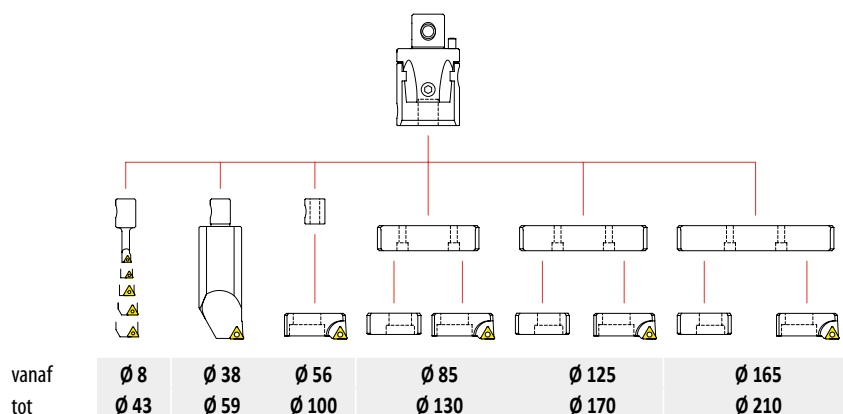

Bereik	Componenten				Bestelnummer	
Ø 8 ~ Ø 43					BS 54 KIT RC 8-043	420
					BS 54 KIT TC 8-043	424
Ø 8 ~ Ø 100					BS 54 KIT RC 8-100	421
					BS 54 KIT TC 8-100	425
Ø 8 ~ Ø 170					BS 54 KIT RC 8-170	422
					BS 54 KIT TC 8-170	426
Ø 8 ~ Ø 210					BS 54 KIT RC 8-210	423
					BS 54 KIT TC 8-210	427



BS 54 KIT RC 8-043

KOTTERSETS

BESTELNUMMER:

Ø 8 – 43



	Omschrijving	Markering	Wisselplaat	Stuks
1	Kop	BS 054 16	-	1
2	Kotterbeitel 6 mm	BS 06 16 R02	EP.. 0502..	1
	Kotterbeitel 8 mm	BS 08 16 R03	CC.. 0602..	1
	Kotterbeitel 10 mm	BS 10 16 R03	CC.. 0602..	1
	Kotterbeitel 12 mm	BS 12 16 R03	CC.. 0602..	1
	Kotterbeitel 16 mm	BS 16 16 R04	CC.. 09T3..	1
3	Zeskantsleutel 3	HK 03	-	1
	Zeskantsleutel 5	HK 05	-	1
	Zeskantsleutel 6	HK 06	-	1
4	Torx sleutel 7	TK07	-	1
	Torx sleutel 8	TK08	-	1
	Torx sleutel 15	TK15	-	1
	-			



BS 54 KIT RC 8-100

KOTTERSETS

Ø 8 – 100

BESTELNUMMER:



	Omschrijving	Markering	Wisselplaat	Stuks
1	Kop	BS 054 16	-	1
2	Kotterbeitel 6 mm	BS 06 16 R02	EP.. 0502..	1
	Kotterbeitel 8 mm	BS 08 16 R03	CC.. 0602..	1
	Kotterbeitel 10 mm	BS 10 16 R03	CC.. 0602..	1
	Kotterbeitel 12 mm	BS 12 16 R03	CC.. 0602..	1
	Kotterbeitel 16 mm	BS 16 16 R04	CC.. 09T3..	1
3	Kotterbeitel 34 mm	BS 34 16 R04	CC.. 09T3..	2
4	Cartridge	BS 2CT R04	CC.. 09T3..	1
5	Positioneerbus	BS 16 M10	-	1
6	Zeskantsleutel 3	HK 03	-	1
	Zeskantsleutel 5	HK 05	-	1
	Zeskantsleutel 6	HK 06	-	1
	Zeskantsleutel 8	HK 08	-	1
7	Torx sleutel 7	TK07	-	1
	Torx sleutel 8	TK08	-	1
	Torx sleutel 15	TK15	-	1
8	Bevestigingsschroef cassette	CS 10 25	-	1



BS 54 KIT RC 8-170

KOTTERSETS

Ø 8 – 170

BESTELNUMMER:

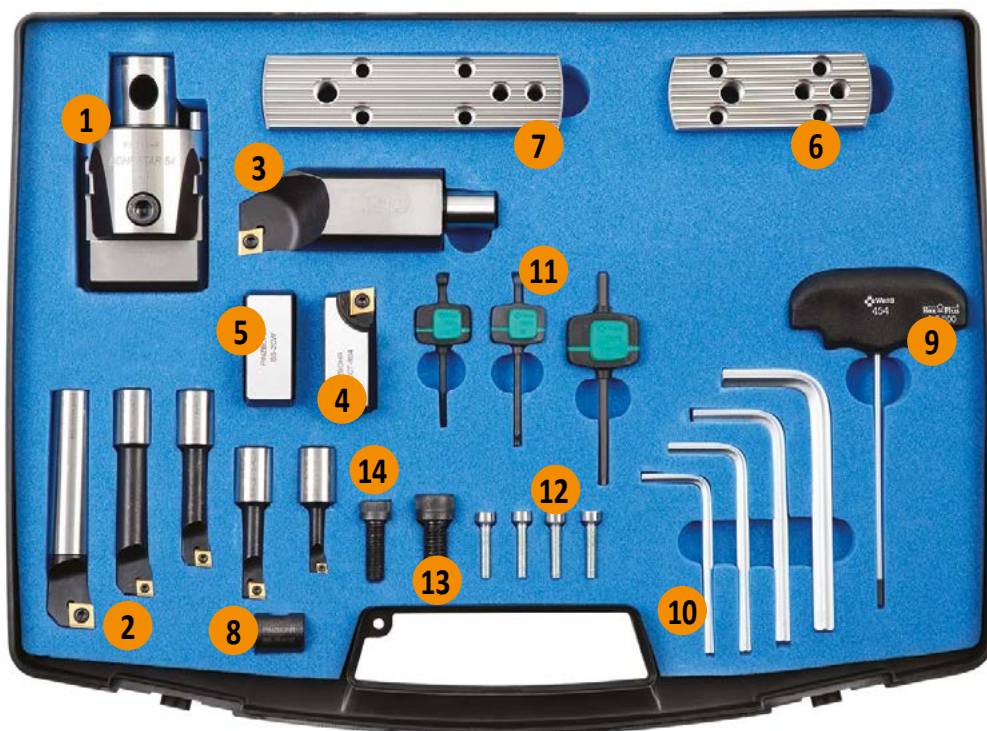

	Omschrijving	Markering	Wisselplaat	Stuks
1	Kop	BS 054 16	-	1
2	Kotterbeitel 6 mm	BS 06 16 R02	EP.. 0502..	1
	Kotterbeitel 8 mm	BS 08 16 R03	CC.. 0602..	1
	Kotterbeitel 10 mm	BS 10 16 R03	CC.. 0602..	1
	Kotterbeitel 12 mm	BS 12 16 R03	CC.. 0602..	1
	Kotterbeitel 16 mm	BS 16 16 R04	CC.. 09T3..	1
3	Kotterbeitel 34 mm	BS 34 16 R04	CC.. 09T3..	2
4	Cartridge	BS 2CT R04	CC.. 09T3..	1
5	Contragewicht	BS 2CW	-	1
6	Korte verlengslede	BS SP 85 130	-	1
7	Medium verlengslede	BS SP 125 170	-	1
8	Positioneerbus	BS 16 M10	-	1
9	Verstelsleutel	AK 03	-	1
10	Zeskantsleutel 4	HK 04	-	1
	Zeskantsleutel 5	HK 05	-	1
	Zeskantsleutel 6	HK 06	-	1
	Zeskantsleutel 8	HK 08	-	1
11	Torx sleutel 7	TK07	-	1
	Torx sleutel 8	TK08	-	1
	Torx sleutel 15	TK15	-	1
12	Bevestigingsschroef wisselplaat	D 27 21	-	4
13	Bevestigingsschroef cassette	CS 10 25	-	1
14	Contragewicht schroef	CS 08 25	-	1

∅ 8 – 210

BESTELNUMMER:

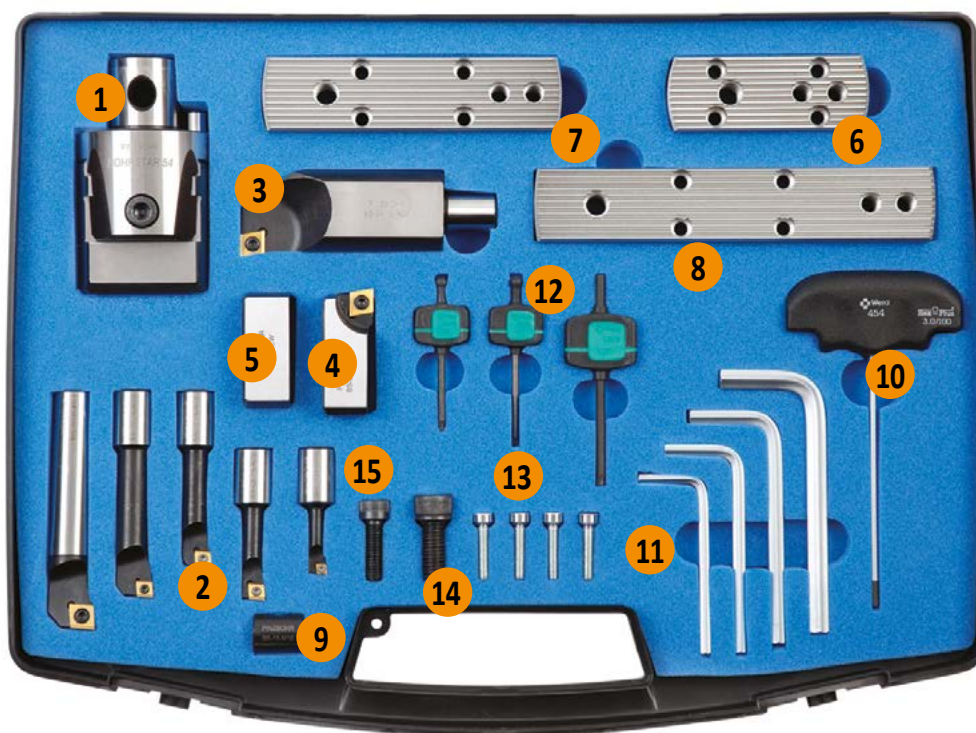

	Omschrijving	Markering	Wisselplaat	Stuks
1	Kop	BS 054 16	–	1
2	Kotterbeitel 6 mm	BS 06 16 R02	EP.. 0502..	1
	Kotterbeitel 8 mm	BS 08 16 R03	CC.. 0602..	1
	Kotterbeitel 10 mm	BS 10 16 R03	CC.. 0602..	1
	Kotterbeitel 12 mm	BS 12 16 R03	CC.. 0602..	1
	Kotterbeitel 16 mm	BS 16 16 R04	CC.. 09T3..	1
3	Kotterbeitel 34 mm	BS 34 16 R04	CC.. 09T3..	2
4	Cassette	BS 2CT R04	CC.. 09T3..	1
5	Contragewicht	BS 2CW	–	1
6	Korte verlengsled	BS SP 85 130	–	1
7	Medium verlengsled	BS SP 125 170	–	1
8	Lange verlengsled	BS SP 165 210	–	1
9	Positioneerbus	BS 16 M10	–	1
10	Verstelsleutel	AK 03	–	1
11	Zeskantsleutel 4	HK 04	–	1
	Zeskantsleutel 5	HK 05	–	1
	Zeskantsleutel 6	HK 06	–	1
	Zeskantsleutel 8	HK 08	–	1
12	Torx sleutel 7	TK07	–	1
	Torx sleutel 8	TK08	–	1
	Torx sleutel 15	TK15	–	1
13	Wisselplaatschroef	D 27 21	–	4
14	Bevestigingsschroef cassette	CS 10 25	–	1
15	Contragewicht schroef	CS 08 25	–	1



BS 54 KIT TC 8-043

KOTTERSETS

Ø 8 – 43

BESTELNUMMER:

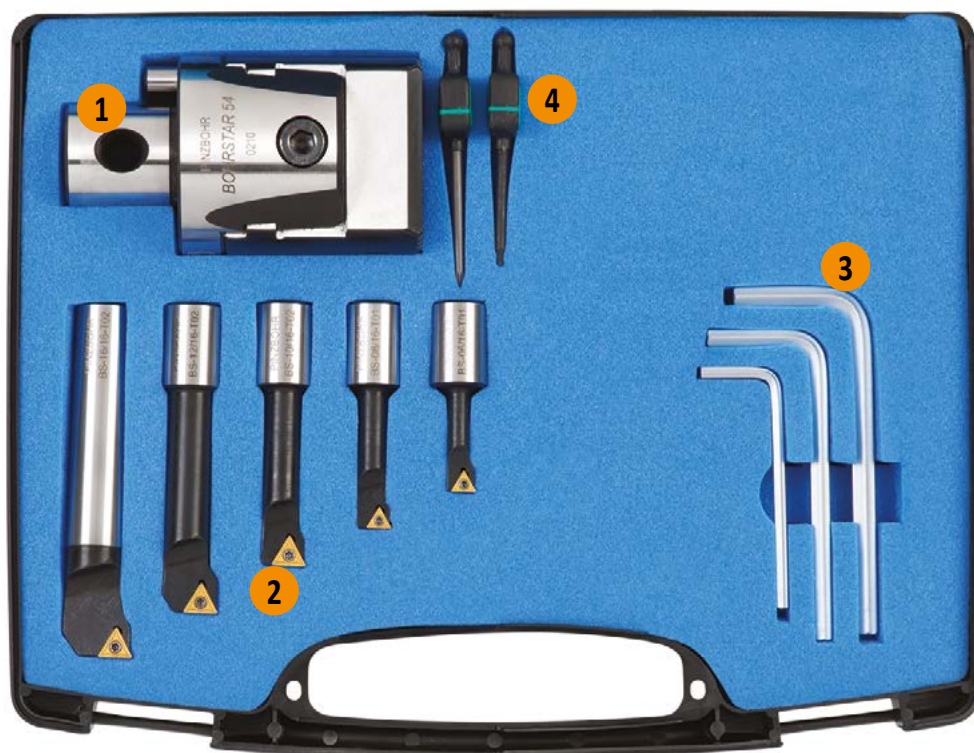

	Omschrijving	Markering	Wisselplaat	Stuks
1	Kop	BS 054 16	-	1
2	Kotterbeitel 6 mm	BS 06 16 T01	TC.. 06T1..	1
	Kotterbeitel 8 mm	BS 08 16 T01	TC.. 06T1..	1
	Kotterbeitel 10 mm	BS 10 16 T02	TC.. 0902..	1
	Kotterbeitel 12 mm	BS 12 16 T02	TC.. 0902..	1
	Kotterbeitel 16 mm	BS 16 16 T02	TC.. 0902..	1
3	Zeskantsleutel 3	HK 03	-	1
	Zeskantsleutel 5	HK 05	-	1
	Zeskantsleutel 6	HK 06	-	1
4	Torx sleutel 6	TK06	-	1
	Torx sleutel 7	TK07	-	1

BS 54 KIT TC 8-100

KOTTERSETS

Ø 8 – 100

BESTELNUMMER:



	Omschrijving	Markering	Wisselplaat	Stuks
1	Kop	BS 054 16	-	1
2	Kotterbeitel 6 mm	BS 06 16 T01	TC.. 06T1..	1
	Kotterbeitel 8 mm	BS 08 16 T01	TC.. 06T1..	1
	Kotterbeitel 10 mm	BS 10 16 T02	TC.. 0902..	1
	Kotterbeitel 12 mm	BS 12 16 T02	TC.. 0902..	1
	Kotterbeitel 16 mm	BS 16 16 T02	TC.. 0902..	1
3	Kotterbeitel 34 mm	BS 34 16 T04	TC.. 16T3..	1
4	Cassette	BS 2CT T04	TC.. 16T3..	1
5	Positioneerbus	BS 16 M10	-	1
6	Zeskantsleutel 3	HK 03	-	1
	Zeskantsleutel 5	HK 05	-	1
	Zeskantsleutel 6	HK 06	-	1
	Zeskantsleutel 8	HK 08	-	1
7	Torx sleutel 6	TK06	-	1
	Torx sleutel 7	TK07	-	1
	Torx sleutel 15	TK15	-	1
8	Bevestigingsschroef cassette	CS 10 25	-	1

BS 54 KIT TC 8-170

KOTTERSETS

∅ 8 – 170

BESTELNUMMER:

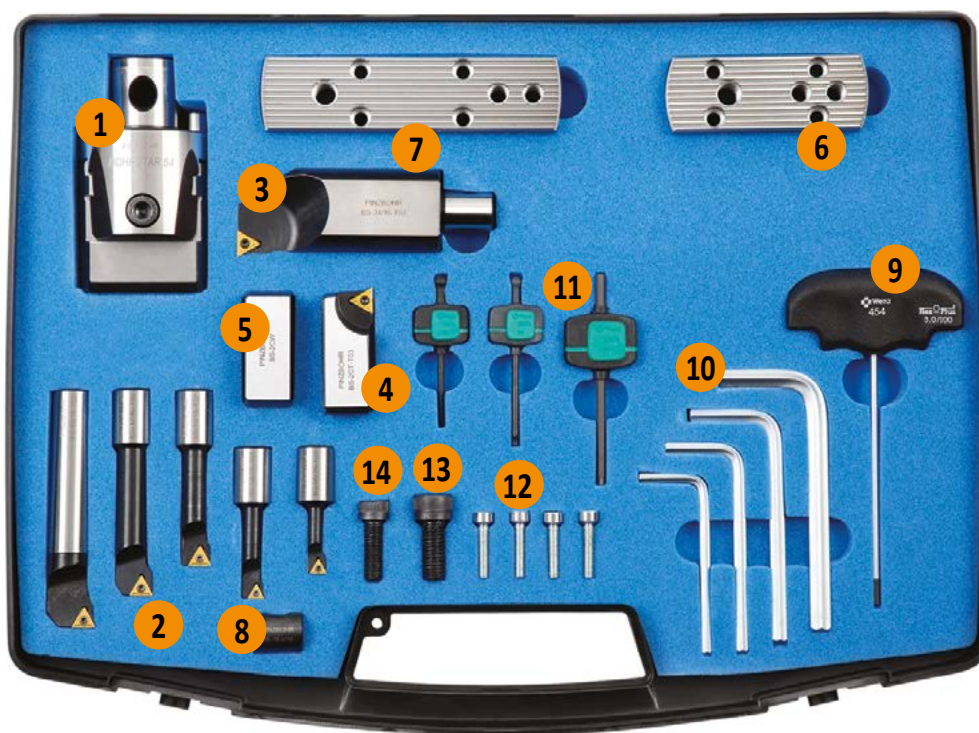

	Omschrijving	Markering	Wisselplaat	Stuks
1	Kop	BS 054 16	-	1
2	Kotterbeitel 6 mm	BS 06 16 T01	TC.. 06T1..	1
	Kotterbeitel 8 mm	BS 08 16 T01	TC.. 06T1..	1
	Kotterbeitel 10 mm	BS 10 16 T02	TC.. 0902..	1
	Kotterbeitelr 12 mm	BS 12 16 T02	TC.. 0902..	1
	Kotterbeitel 16 mm	BS 16 16 T02	TC.. 0902..	1
3	Kotterbeitelr 34 mm	BS 34 16 T04	TC.. 16T3..	1
4	Cassette	BS 2CT T04	TC.. 16T3..	1
5	Contragewicht	BS 2CW	-	1
6	Korte verlengslede	BS SP 85 130	-	1
7	Medium verlengslede	BS SP 125 170	-	1
8	Positioneerbus	BS 16 M10	-	1
9	Verstelsleutel	AK 03	-	1
10	Zeskantsleutel 4	HK 04	-	1
	Zeskantsleutel 5	HK 05	-	1
	Zeskantsleutel 6	HK 06	-	1
	Zeskantsleutel 8	HK 08	-	1
11	Torx sleutel 6	TK06	-	1
	Torx sleutel 7	TK07	-	1
	Torx sleutel 15	TK15	-	1
12	Wisselplaatschroef	D 27 21	-	4
13	Bevestigingsschroef cassette	CS 10 25	-	1
14	Schroef voor contragewicht	CS 08 25	-	1

∅ 8 – 210

BESTELNUMMER:

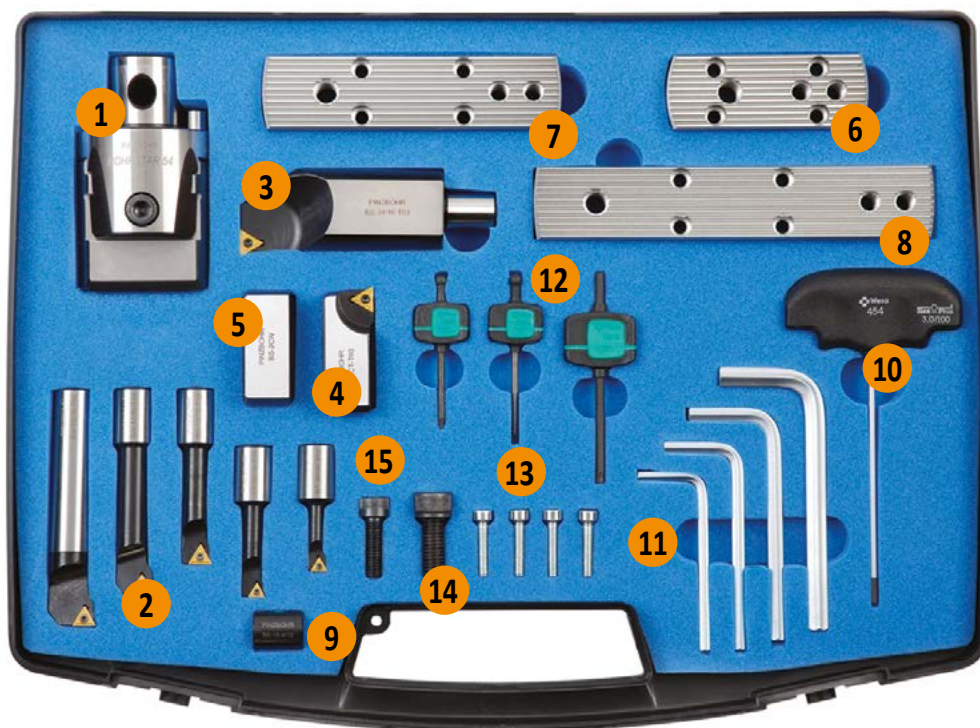

	Omschrijving	Markering	Wisselplaat	Stuks
1	Kop	BS 054 16	–	1
2	Kotterbeitel 6 mm	BS 06 16 T01	TC.. 06T1..	1
	Kotterbeitel 8 mm	BS 08 16 T01	TC.. 06T1..	1
	Kotterbeitel 10 mm	BS 10 16 T02	TC.. 0902..	1
	Kotterbeitel 12 mm	BS 12 16 T02	TC.. 0902..	1
	Kotterbeitel 16 mm	BS 16 16 T02	TC.. 0902..	1
3	Kotterbeitel 34 mm	BS 34 16 T04	TC.. 16T3..	1
4	Cassette	BS 2CT T04	TC.. 16T3..	1
5	Contragewicht	BS 2CW	–	1
6	Korte verlengslede	BS SP 85 130	–	1
7	Medium verlengslede	BS SP 125 170	–	1
8	Lange verlengslede	BS SP 165 210	–	1
9	Positioneerbus	BS 16 M10	–	1
10	Verstelsleutel	AK 03	–	1
11	Zeskantsleutel 4	HK 04	–	1
	Zeskantsleutel 5	HK 05	–	1
	Zeskantsleutel 6	HK 06	–	1
	Zeskantsleutel 8	HK 08	–	1
12	Torx sleutel 6	TK06	–	1
	Torx sleutel 7	TK07	–	1
	Torx sleutel 15	TK15	–	1
13	Wisselplaatschroef	D 27 21	–	4
14	Bevestigingsschroef cassette	CS 10 25	–	1
15	Schroef voor contragewicht	CS 08 25	–	1



DORMER PRAMET



ALTIJD VERBINDING

Geen wifi of internetverbinding? De bewerkingscalculator werkt ook prima als u offline bent, waardoor deze altijd beschikbaar als u de calculator nodig heeft. **Simply Reliable.**

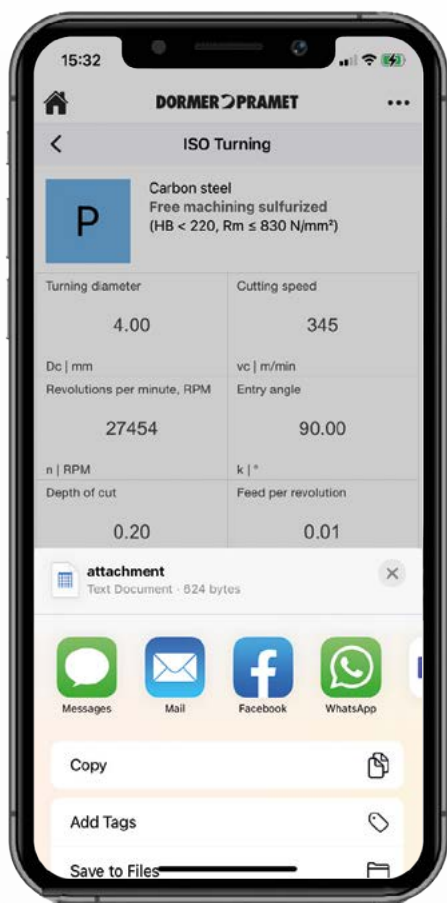



BOREN
TECHNISCHE INFORMATIE



WERKSTUKMATERIAALGROEPEN (WMG)

ISO Voor het selecteren van een basismateriaal en geometrie voor een breed scala aan werkstukmaterialen

Algemene definitie
d.w.z. staal, roestvast staal...

P M K N S H

Subgroep Om te navigeren en een gereedschap te selecteren op basis van geschiktheid voor een specifiek assortiment werkstukmaterialen

Definitie op basis van structuur/samenstelling
d.w.z. gewoon koolstofstaal, gelegeerd staal...

P M K N S H

P1

P2

P3

P4

WMG Het selecteren en bieden van snijcondities binnen een bandbreedte van $\pm 10\%$

Definitie op basis van hardheid/treksterkte
d.w.z. $160 < 220 \text{ HB}$, $620 < 900 \text{ n/mm}^2 \dots$

P

P1 P1.1 P1.2 P1.3

P2 P2.1 P2.2 P2.3

P3 P3.1 P3.2 P3.3

P4 P4.1 P4.2 P4.3

INFORMATIE OVER WERKSTUKMATERIAALCLASSIFICATIE VAN DORMER PRAMET

Werkstukmateriaalgroepen ("WMG") zijn bedoeld om een eenvoudige en betrouwbare keuze van het juiste snijgereedschap en startwaarden voor de verspaningscondities in bepaalde toepassingen te kunnen maken.

Dormer Pramet deelt werkstukmaterialen in zes verschillend gekleurde groepen in;

- **Blauw:** Staal en gietstaal (groep P)
- **Geel:** Roestvast staal (groep M)
- **Rood:** Gietijzer (groep K)
- **Groen:** Non-ferro metalen (groep N)
- **Bruin:** Hittebestendige legeringen (groep S)
- **Grijs:** Geharde materialen (groep H)

Al deze materialen zijn afzonderlijk onderverdeeld in subgroepen op basis van structuur en/of samenstelling. Staal en gietstaal uit groep P zijn bijvoorbeeld onderverdeeld in vier subgroepen, te weten;

- P1 – **Automatenstaal**
- P2 – **Koolstofstaal/ongelegeerd staal**
- P3 – **Gelegeerd staal**
- P4 – **Gereedschapstaal**

Een uiteindelijke verdeling omvat materiaaleigenschappen, zoals hardheid en treksterkte. Dit is bedoeld om onze klanten volledig advies te geven over het gereedschap, inclusief startwaarden voor snij snelheid en voeding.

De tabel op de volgende pagina bevat een beschrijving van elke werkstukmateriaalgroep en voorbeelden van veelgebruikte benamingen.

WERKSTUKMATERIAALGROEPEN (WMG)

ISO groep	Subgroep	WMG (Werkstuk Materiaal Groep)	k_{wg}	Voorbeelden van materialen (AISI, EN, DIN, ČSN, GB, SS, STN, BS, UNE, AFNOR, ASTM, GOST, UNS, UNI, ...)
P Staal en gietstaal (staalsoorten met een legeringsgehalte ≤ 10 % en een hardheid van < 45HRC)	P1 Automatenstaal (koolstofstaal met verhoogde bewerkbaarheid)	P1.1 zwavelhoudend < 240 HB	1.33	AISI 1108, EN 1552, DIN 1.0723, SS 1922, ČSN 11120, BS 210A15, UNE F.210F, GB Y15, AFNOR 10F1, GOST A30, UNI CF10S20
		P1.2 zwavel- en fosforhoudend < 180 HB	1.49	AISI 1211, EN 115Mn30, DIN 1.0715, SS 1912, ČSN 11109, BS 230M7, UNE F.2111, GB Y15, AFNOR S250, GOST A40G, UNI CF95Mn28
		P1.3 zwavel-, fosfor-, en loodhoudend < 180 HB	1.53	AISI 12L13, EN 115MnPb30, DIN 1.0718, SS 1914, ČSN 12110, BS 210M16, UNE F.2114, GB Y15Pb, AFNOR S250Pb, GOST AS35G2, UNI CF10SPb20
	P2 Koolstofstaal (staalsoorten die hoofdzakelijk bestaan uit ijzer en koolstof)	P2.1 gehalte < 0.25 % C met een hardheid van < 180 HB	1.14	AISI 1015, EN C15, DIN 1.0401, SS 1350, ČSN 11301, BS 080A15, UNE F.111, GB 15, AFNOR C18RR, GOST S22ps, UNI Fe360
		P2.2 gehalte < 0.55 % C met een hardheid van < 240 HB	1.00	AISI 1030, EN C30, DIN 1.0528, SS 1550, ČSN 12031, BS 080M32, UNE F.1130, GB 30, AFNOR AF50C30, GOST 30G, UNI Fe590
		P2.3 gehalte > 0.55 % C, met een hardheid van < 300 HB	0.89	AISI 1060, EN C60, DIN 1.0601, SS 1655, ČSN 12061, BS 080A62, UNE F513, GB 60, AFNOR 1C60, GOST 60G, UNI C60
	P3 Gelegeerd staal (koolstofstaal met een legeringsgehalte ≤ 10%)	P3.1 gegljooid < 180 HB	0.92	AISI 5015, EN 16Mo3, DIN 1.5415, SS 2912, ČSN 15020, BS 1501-240, UNE F.2601, GB 16Mo, AFNOR 15D3, GOST 15M, UNI 16Mo3KW
		P3.2 gehard en getempereerd 180 – 260 HB	0.74	AISI 4140, EN 42CrMo4, DIN 1.7225, SS 2244, ČSN 15142, BS 708M40, UNE F.8232, GB 42CrMo, AFNOR 42CD4, GOST 40CHFA, UNI 42CrMo4
		P3.3 gelegeerd staal 260 – 360 HB	0.63	AISI 4140, EN 42CrMo4, DIN 1.7225, SS 2244, ČSN 15142, BS 708M40, UNE F.8232, GB 42CrMo, AFNOR 42CD4, GOST 40CHFA, UNI 42CrMo4
	P4 Gereedschapstaal (speciaal gelegeerd staal voor gereedschappen, matrijzen en mallen)	P4.1 gegljooid < 26 HRC	0.55	AISI D2, EN X155CrVMo12-1, DIN 1.2370, SS 2736, ČSN 19573, BS BD2, UNE F.520A, GB Cr12Mo1V1, AFNOR Z160CDV12, GOST Ch12MF, UNI X155CrVMo121KU
		P4.2 gehard en getempereerd 26 – 39 HRC	0.47	AISI D2, EN X155CrVMo12-1, DIN 1.2370, SS 2736, ČSN 19573, BS BD2, UNE F.520A, GB Cr12Mo1V1, AFNOR Z160CDV12, GOST Ch12MF, UNI X155CrVMo121KU
		P4.3 39 – 45 HRC	0.38	AISI D2, EN X155CrVMo12-1, DIN 1.2370, SS 2736, ČSN 19573, BS BD2, UNE F.520A, GB Cr12Mo1V1, AFNOR Z160CDV12, GOST Ch12MF, UNI X155CrVMo121KU

WERKSTUKMATERIAALGROEPEN (WMG)



ISO groep	Subgroep	WMG (Werkstuk Materiaal Groep)	k _{vg}	Voorbeelden van materiaal (AISI, EN, DIN, ČSN, GB, SS, STN, BS, UNE, AFNOR, ASTM, GOST, UNS, UNI, ...)
M Roestvast staal (corrosiebestendige staalsoorten met ≥ 11% chroomgehalte)	M1 Ferritisch roestvaststaal (chroomhoudende niet hardbare legering)	M1.1 roestvast staal, ferritisch met een hardheid van < 160 HB	1.22	AISI 5429, EN X7Cr14, DIN 1.4001, SS 2326, BS 434517, UNE F.3401, AFNOR Z8C12, GOST 08Ch13, UNI X6CrTi12
		M1.2 gegloeid 160 – 220 HB	1.03	AISI 446, EN X10CrAl24, DIN 1.4762, SS 2322, ČSN 17113, BS 430517, UNE F.3154, GB 10Cr17, AFNOR Z10CA524, GOST 12Ch17, UNI X16Cr26
	M2 Martensitisch roestvaststaal(chroomhoudende hardbare legeringen)	M2.1 roestvast staal, martensitisch met een hardheid van < 200 HB	1.08	AISI 430F, EN X14CrMo517, DIN 1.4104, SS 2383, ČSN 17140, BS 410S21, UNE F.3117, AFNOR Z10CF17, UNI X10CF517
		M2.2 roestvast staal, martensitisch met een hardheid van 200 – 280 HB	0.89	AISI 440C, EN X105CrMo17, DIN 1.4125, SS 2385, ČSN 17023, BS 425C11, UNE F.3402, GB 102Cr17Mo, AFNOR Z100CD17, GOST 95Ch18, UNI GX6CrNi 13 04
	M3 Austenitisch roestvaststaal(chroomhoudende en nikkel chroom magnesium legeringen)	M2.3 precipitatie gehard 280 – 380 HB	0.75	AISI 420, EN X45Cr13, DIN 1.4034, ČSN 17029, BS 425C11, UNE F.3405, AFNOR Z44C14, GOST 20X17H12, UNI X30Cr13
		M3.1 roestvast staal, austenitisch met een hardheid van < 200 HB	1.00	AISI 304, EN X5CrNi18-12, DIN 1.4303, SS 2352, ČSN 17249, BS 305S17, UNE F.3513, GB 10Cr18Ni12, AFNOR Z8CN18.12, UNI X7CrNi18 10
		M3.2 roestvast staal, austenitisch met een hardheid van 200 – 260 HB	0.86	AISI 309, EN X15CrNiSi20-12, DIN 1.4828, ČSN 17251, BS 309S24, UNE F.3312, GB 1G23Ni13, AFNOR Z15CNS20.12, GOST 20Ch20Ni45Z, UNI 16CrNi23 14
	M4 Austenitisch ferritisch (DUPLEX) of super austenitisch roestvaststaal en precipitatie hardend austenitisch roestvaststaal	M3.3 roestvast staal, austenitisch met een hardheid van 260 – 300 HB	0.77	AISI 5848, EN X45CrNiW18-9, DIN 1.4873, BS 331540, UNE F.3211, AFNOR Z35CNW514-4, UNI X45CrNiW 18 9
		M4.1 roestvast staal, austenitisch, ferritisch of super austenitisch met een hardheid van < 300 HB	0.75	AISI 329, EN X1-NiCrMoCu25-20-5, DIN 1.4539, SS 2562, ČSN 17265, BS 318513, UNE F.3552, GB 022Cr25NiMo2N, AFNOR Z1NCUDU25.20
		M4.2 roestvast staal, precipitatie hardend austenitisch met een hardheid van 300 – 380 HB	0.64	AISI 631 (17-7PH), EN X7CrNiAl17-7, DIN 1.4568, SS 2388, ČSN 17465, BS 301S13, UNE F.3217, GB 07Cr17Ni7Al, AFNOR Z9CNAl17-07, GOST 09Ch17N7Jut, UNI X53CrMnNi21 9



WERKSTUKMATERIAALGROEPEN (WMG)

ISO groep	Subgroep	WMG (Werkstuk Materiaal Groep)	k_{wc}	Gereedschapstaal (AISI, EN, DIN, ČSN, GB, SS, STN, BS, UNE, AFNOR, ASTM, GOST, UNS, UNI, ...)
K Gietijzer (gietstukken van ijzer en koolstoflegeringen met >koolstofgehalte)	K1 Grijs gietijzer (GG) (ijzer-koolstof gietstukken met een lamellaire grafiet microstructuur)	K1.1 ferritisch of ferritisch perlitisch < 180 HB	1.35	ASTM A48 Grade 20 (F11401), EN-JL-100, DIN GG-10 (0.6010), SS 0110, STN 422410, BS Grade 150, UNE FG10, GB HAT 100, AFNOR Fc10D, GOST SC 10, UNI G10
		K1.2 ferritisch perlitisch of perlitisch 180 – 240 HB	1.00	ASTM A48 Grade 30 (F12101), EN-JL-1030, DIN GG-20 (0.6020), SS 0120, STN 422420, BS Grade 220, UNE FG20, GB HT200, AFNOR Ft20D, GOST C420, UNI G20
		K1.3 perlitisch 240 – 280 HB	0.75	ASTM A48 Grade 50 (F13501), EN-JL-1060, DIN GG-35 (0.6035), SS 0135, STN 422435, BS Grade 350, UNE FG35, GB HAT300, AFNOR F35D, GOST SC35, UNI G35
	K2 Smeedbaar gietijzer (GTS-GTW) (ijzer-koolstof gietstukken met grafietvrije microstructuur)	K2.1 ferritisch of < 160 HB	1.39	ASTM A602 Grade M3210 (F20000), EN-JM-1130, DIN GTS-35 (0.8135), SS 0815, BS B340/12, UNE Type A, AFNOR MN 35-10, GOST K435-10
		K2.2 ferritisch of perlitisch 160 – 200 HB	1.13	ASTM A602 Grade M4504 (F20001), EN-JM-1040, DIN GTS-50-05 (0.8045), BS P50-05, AFNOR MB 45-7
		K2.3 perlitisch 200 – 240 HB	0.90	ASTM A602 Grade M7002 (F20004), EN-JM-1140, DIN GTS-45 (0.8145), SS 0854, STN 422540, BS P 45-06, UNE Typ B, AFNOR MP 50-5, GOST K445-7, UNI GMM 45
	K3 Taai gietijzer (GG) (ijzer-koolstof gietstukken met een nodulaire grafiet microstructuur)	K3.1 ferritisch < 180 HB	1.23	ASTM A536 Grade 60-40-18 (F32800), EN-JS-1030, DIN GGG-40 (0.7040), SS 0717, STN 422304, BS 420/12, UNE FGE 42-12, GB QT 400, AFNOR FGS 400-12, GOST B440
		K3.2 ferritisch of perlitisch 180 – 220 HB	0.94	ASTM A536 Grade 80-55-06 (F33800), EN-JS-1050, DIN GGG-50 (0.7050), SS 0727, STN 422305, BS 500/7, UNE FGE 50-7, GB QT 500-7, AFNOR FGS 500-7, GOST B450
		K3.3 perlitisch 220 – 260 HB	0.76	ASTM A536 Grade 100-70-03 (F34800), EN-JS-1060, DIN GGG-60 (0.7060), SS 0732, STN 422306, BS 600/3, UNE FG70-2, GB QT 600-3, AFNOR FGS 600-3, GOST B460
	K4 Austenitisch of austempered nodulair gietijzer (Ni-Resist/AD) (gietstukken van ijzer-koolstoflegeringen met een austenitische of ausferritische microstructuur)	K4.1 Austenitisch gietijzer < 180 HB	1.14	ASTM A436 Type 1 (L-NiCuCr 15 6 2, F41000), EN-JL-3011, DIN GGL-NiMn 13 7 (0.6652), SS 0523, BS Grade F1, AFNOR FGL-Ni13Mn7, GOST S-NiMn 13 7
		K4.2 Austenitisch taai gietijzer 180 – 240 HB	0.86	ASTM A439 Type D-2B (S-NiCr 20 3, F43001), EN-JS-3021, DIN GGG-NiMn 23 4, SS 0776, BS Grade S2M, AFNOR FGS Ni23 Mn4, GOST CH19X3U
		K4.3 Austempered nodulair gietijzer 240 – 280 HB	0.63	ASTM A897 Grade 110-70-11
	K5 Verdicht gietijzer CGI (ijzer-koolstof gietstukken met een vermiculaire grafiet microstructuur)	K4.4 Austempered nodulair gietijzer 280 – 320 HB	0.54	ASTM A897 Grade 125-80-10, EN-JS-1100, DIN GGG-90 (5.3400)
		K4.5 Austempered nodulair gietijzer 320 – 360 HB	0.45	ASTM A897 Grade 2 (150-110-07), EN-JS-1110, DIN GGG-100 (5.3403)
		K5.1 ferritisch < 180 HB	1.29	ASTM A842 Grade 300, EN-GJV-300, DIN GGV 30, GOST 4BT30,
K5	K5.2 ferritisch/perlitisch 180 – 220 HB	0.97	ASTM A842 Grade 350, EN-GJV-350, DIN GGV 35 (5.2200), GOST 4BT30,	
	K5.3 perlitisch 220 – 260 HB	0.75	ASTM A842 Grade 450, EN-GJV-450, DIN GGV 45, GOST 4BT45,	



WERKSTUKMATERIAALGROEPEN (WMG)

ISO groep	Subgroep	WMG (Werkstuk Materiaal Groep)	k _{vg}	Voorbeelden van materiaal (AISI, EN, DIN, ČSN, GB, SS, STN, BS, UNE, AFNOR, ASTM, GOST, UNS, UNI, ...)
N Non-ferrometalen (metalen met daarbij legeringen zonder een aanzienlijke hoeveelheid ijzer)	N1 Gesmeed Aluminium legeringen	N1.1 Zuiver aluminium < 60 HB	1.33	UNS A91200, EN AL99.6, DIN 3.0205, SS 4010, STN 424009, BS 1C, UNE L-3001, GB L5, AFNOR A4, GOST AĐC, UNI 3567
		N1.2 half hard getemperd 60 – 100 HB	1.00	UNS A93004, EN AlMn0.5Mg0.5, DIN 3.0505, SS 4054, STN 424432, BS N31, UNE L-3831, GB LF2, AFNOR A-M1, GOST AMu, UNI 3568
		N1.3 doorgehard getemperd 100 – 150 HB	0.67	UNS A95083, EN AlMg4.5Mn0.7, DIN 3.3547, SS 4140, STN 424415, BS N8, UNE L-3321, GB AlMg4.5Mn, AFNOR A-G4.5Mn, GOST Amg 4.5, UNI P-AlMg4.4
	N2 Gietaluminium legeringen	N2.1 Gietaluminium legeringen < 75 HB	0.67	UNS A02080, EN AlCu45, BS LM11, STN 424331, UNE AlSi1Cu, GOST AMg5K, UNI G-ALSi7Mg
		N2.2 Gietaluminium legeringen 75 – 90 HB	0.60	UNS A02420, EN AlCu4Ni2Mg2, SS AlSi7MgFe, BS LM6, STN 424519, UNE Al-7SiMg, AFNOR A-57G, GOST AK7, UNI G-ALSi7Mg
		N2.3 Gietaluminium legeringen 90 < 140 HB	0.43	UNS A03360, EN G-ALCu4NiMg2, SS AlSi10Mg, STN 424336, BS LM 30, AFNOR A-5T0G, UNI G-ALSi9Mg
	N3 Koper of koperlegering	N3.1 Automaten messing en koperlegeringen met uitstekende verspanningseigenschappen	0.70	UNS C14700, EN CuPb1P, DIN 2.1498, STN 423214, BS C111, AFNOR CuZn35Pb2, GOST L63-3, UNI CuS(P0.01)
		N3.2 Kortspanig messing en koperlegeringen met goede tot middelmatige verspanningseigenschappen	0.41	UNS C81540, EN CuNi25Cr, DIN 2.0857, STN 423220, BS NS113, UNE CuSn12, AFNOR CuZn40, GOST L60, UNI P-CuZn-40
		N3.3 Electrolitisch koper en langspanige koperlegeringen met middelmatige tot slechte verspanningseigenschappen	0.21	UNS C10100, EN CuAg0.1, DIN 2.1203, SS 5010, UNE CUSi3Mn1, AFNOR Cu-C2, GOST M1f, UNI Cu-0F
	N4 Kunststoffen (synthetische of half synthetische materialen)	N4.1 Thermoplastische kunststoffen	0.70	ABS, Acryl, Duraplast, Elastomer, EP, Epoxid, FEP, Fluor, Gummi, Kautschuk, Latex, ME, MPF, PA, PAI, PC, PE, PEEK, PEI, PES, PET, PF, Phenolharze, PI, PMMA, Polyamide, Polyester, Polyolefine, Polysulfon, POM, PP, PPE, PPS, PS, PSU, PTFE, PU, PUR, PVDF, SAN, SI, Styrol, UF, Ureol
		N4.2 Thermohardende kunststoffen	0.27	Aramid, Epoxy, Fluoropolymer, Meacrylate, Melamine, Phenolic, Polyester, Polyimide, Polymethacrylimide, Polyurethane
		N4.3 Versterkte kunststoffen of composieten	0.29	CFK, GFK, GMT, Honeycomb, Kevlar, LFT, Organo, SMC
	N5 Grafiet	N5.1	1.0	CGM-1, CM-00, GM-10, GM-11, GR030, GR030PI, GR060, GR060PI, GR125, MC-01, MC-01R0, MC-03, MC-03M, IG11, IG-15, IG-32, IG-43, IG-45, IG-70, ISEM-1, ISEM-2, ISEM-3, R8340, R8500X, Technograph 15, Technograph 30, ISO-63, EDM C-3, EDM1, EDM3, ISO-90, ISO-93, ISO-95, R8510, R8650, R8650



WERKSTUKMATERIAALGROEPEN (WMG)

ISO groep	Subgroep	WMG (Werkstuk Materiaal Groep)	$k_{w,c}$	Voorbeelden van materiaal (AISI, EN, DIN, ČSN, GB, SS, STN, BS, UNE, AFNOR, ASTM, GOST, UNS, UNI, ...)	
S Hittebestendige legeringen (superlegeringen met een hogere temperatuur- en roestbestendigheid dan roestvast staal)	S1 Titanium of titanium legeringen	S1.1 Titanium of titanium legeringen <200 HB	1.94	UNS R50250 (Grade 1), EN Ti 99.6, DIN 3.7035, BS TA.2, UNE Ti-Po2, AFNOR T-40, GOST BT1-00, AISI R50250, 3.7025, T35, 2TA1, R50400, 3.7035, 2TAZ,	
		S1.2 Titanium of titanium legering 200 – 280 HB	1.72	UNS R56404 (Grade 29), EN Ti2Cu, DIN 3.7124, BS TA.21, UNE Ti-Pt11, AFNOR T-U2, AISI TA6V, Ti-6Al-4V, Ti 10.2.3, Ti5553	
		S1.3 Titanium of titanium legeringen 280 – 360 HB	1.44	UNS R54250 (Grade 38), EN TiAl6V4, DIN 3.7165, ČSN TiAl6VELI, BS TA. 13, UNE Ti-P63, AFNOR T-A6V, GOST BT6, AISI TA6V, Ti-6Al-4V, Ti 10.2.3, Ti5553	
	S2 Fe-houdende warmvaste legeringen	S2.1 Fe-houdende warmvaste legeringen <200 HB		1.33	UNS N08801 (Incoloy 801), EN X8 NiCrAlTi31-21, DIN 1.4959, BS NA 15, AFNOR Z8NC33-21, AISI A-286, Discaloy, Haynes 556, Inconel 909, Greek Ascology
		S2.2 Fe-houdende warmvaste legeringen 200 – 280 HB		1.17	UNS N19907, EN X6NiCrTiMoVB25-15-2, DIN 1.4980, SS 2570, BS HR52, AFNOR Z6NCTDV25.15B, GOST 36HXT10, AISI A-286, Discaloy, Haynes 556, Inconel 909, Greek Ascology
		S3.1 Ni-houdende warmvaste legeringen <280 HB		1.00	UNS A09706 (Inconel 706), EN NiCr25FeAl, DIN 2.4856, BS HR 6, ČSN Inconel 625, UNE F.3313, GB 1Cr16Ni35, AFNOR NC22FeDNB, GOST XH38BT, AISI Inconel 718, 706 Waspalloy, Udimet 720, Inconel 625
	S3 Ni-houdende warmvaste legeringen	S3.2 Ni-houdende warmvaste legeringen 280 – 360 HB		0.83	UNS N07001, EN NiCr20Co13Mo4Ti3Al, DIN 2.4654, BS HR 2, ČSN Waspalloy, AFNOR NCKD 20ATV, GOST XH80T5K0, AISI Inconel 718, 706 Waspalloy, Udimet 720, Inconel 625
		S4 Co-houdende warmvaste legeringen	S4.1 Co-houdende warmvaste legeringen <240 HB		0.78
	S4.2 Co-houdende warmvaste legeringen 240 – 320 HB			0.67	UNS R30016 (Stellite 6b), EN CoCr20W15Ni, DIN 2.4964, AFNOR KC 20 WN, GOST ЛК52, AISI Haynes 25, Stellite 21, 31







WERKSTUKMATERIAALGROEPEN (WMG)

ISO groep	Subgroep	WMG (Werkstuk Materiaal Groep)	k_{vg}	Voorbeelden van materiaal (AISI, EN, DIN, ČSN, GB, SS, STN, BS, UNE, AFNOR, ASTM, GOST, UNS, UNI, ...)
H Geharde materialen (staalsoorten met een hardheid > 45 HRC)	H1 Afgeschrikt gietijzer	H1.1 Afgeschrikt gietijzer < 440 HB	1.52	UNS F45001, EN-GJS-1050-6, DIN 5.3406, SS 0512, BS Grade 2A
		H2.1 Gehard gietijzer < 55 HRC	0.90	UNS F45003, EN-GJS-1400-1, DIN 5.3405, SS 0457, BS Grade 3D
	H2 Gehard gietijzer	H2.2 Gehard gietijzer > 55 HRC	0.77	UNS F45003, EN G-X260NiCr4-2, DIN 0.9620, SS 0466, BS Grade S
		H3.1 Gehard staal < 51 HRC	1.00	AISI 4135, EN 34CrMo4, DIN 1.7220, SS 2234, STN 415131, BS 198, UNE F.1250, GB 35CrMo, AFNOR 35CD4, GOST AC38XTM, UNI 35CrMo4KB
	H3 Gehard staal < 55 HRC	H3.2 Gehard staal < 51 – 55 HRC	0.82	AISI 4135, EN 34CrMo4, DIN 1.7220, SS 2234, STN 415131, BS 198, UNE F.1250, GB 35CrMo, AFNOR 35CD4, GOST AC38XTM, UNI 35CrMo4KB
		H4.1 Gehard staal < 55 – 59 HRC	0.64	UNS T31501, EN 100MnCrW4, DIN 1.2510, SS 2140, STN 419413, BS B01, UNE F.5220, GB 9CrWMn, AFNOR 90MnWCrV5, GOST 9XBТ, UNI 95MnWCr5KU
	H4 Gehard staal > 55 HRC	H4.2 Gehard staal > 59 HRC	0.54	UNS T31501, EN 100MnCrW4, DIN 1.2510, SS 2140, STN 419413, BS B01, UNE F.5220, GB 9CrWMn, AFNOR 90MnWCrV5, GOST 9XBТ, UNI 95MnWCr5KU

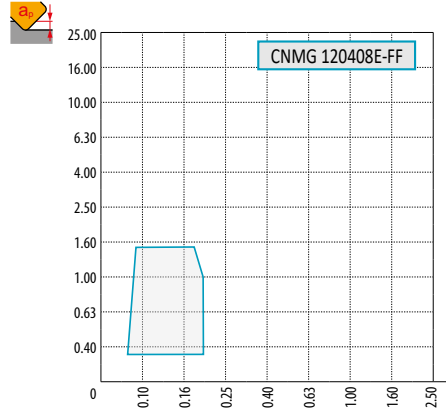
GEOMETRIE VAN NEGATIEVE WISSELPLATEN – KLEMSYSTEEM ISO P, M, D



FF

P	M	K	N	S	H
■	■	▣			
f	0.06 – 0.25				
a_p	0.2 – 1.6				
					
					
 CNMG, DNMG, TNMG, VNMG, WNMG					

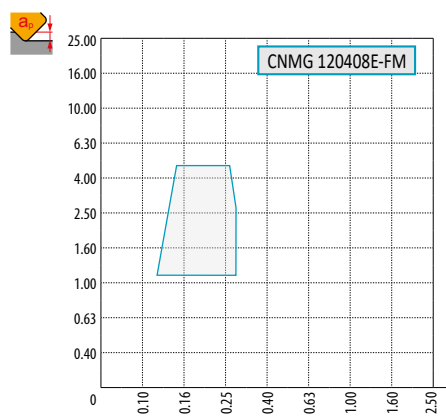

FM

P	M	K	N	S	H
■	▣	■		▣	
f	0.1 – 0.5				
a_p	0.4 – 5.0				
					
					
 CNMG, DNMG, SNMG, TNMG, VNMG, WNMG					

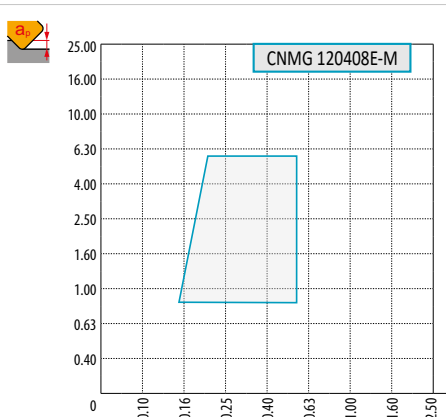

M

P	M	K	N	S	H
■		■			▣
f	0.17 – 0.80				
a_p	0.8 – 8.0				
					
					
 CNMG, DNMG, SNMG, TNMG, VNMG, WNMG					

NF

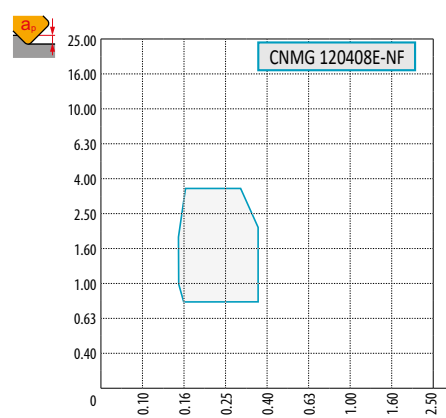



P	M	K	N	S	H
■	■	▣	▣	▣	
f	0.1 – 0.35				
a_p	0.4 – 4.0				
					
					
 CNMG, DNMG, SNMG, TNMG, VNMG, WNMG					



GEOMETRIE VAN NEGATIEVE WISSELPLATEN - KLEMSYSTEEM ISO P, M, D

NM



30° 0,25
10°

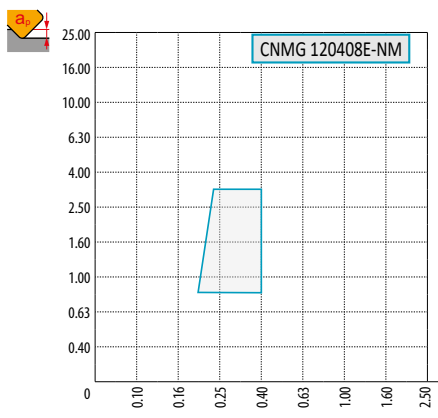

CNMG 120408E-NM

P	M	K	N	S	H
■	■	■	▣	■	■
f		0.15 – 0.55			
a _p		0.5 – 8.0			

?

CNMG, DNMG, TNMG, VNMG, WNMG

NMR



22° 0,31
10°

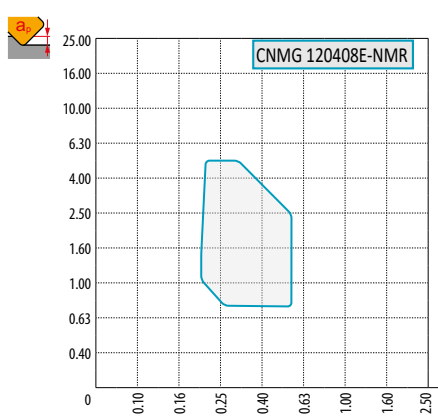

CNMG 120408E-NMR

P	M	K	N	S	H
■	■	■	▣	■	■
f		0.18 – 0.70			
a _p		0.4 – 8.0			

?

CNMG, DNMG, SNMG, TNMG, VNMG, WNMG

R



0,4
0,1 5° 15°
5°

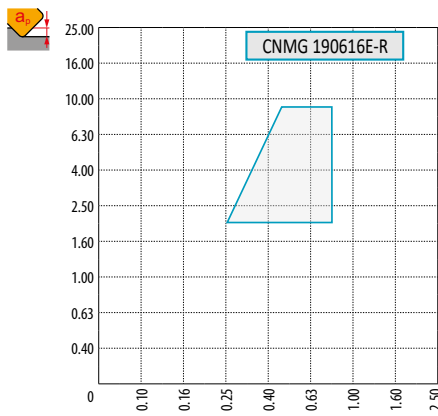

CNMG 190616E-R

P	M	K	N	S	H
■	■	■	▣	■	▣
f		0.25 – 0.80			
a _p		2.0 – 9.0			

?

CNMG, DNMG, SNMG, TNMG, WNMG

SF



1,94
14,5°

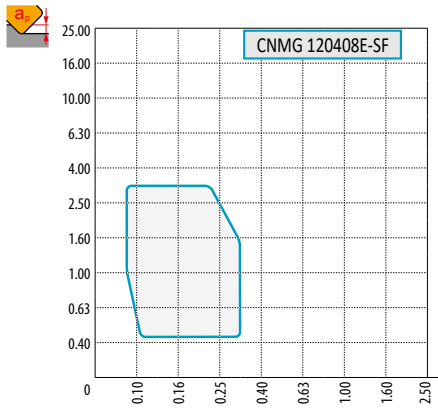

CNMG 120408E-SF

P	M	K	N	S	H
■	■	■	▣	■	■
f		0.08 – 0.35			
a _p		0.2 – 3.5			

?

CNMG, DNMG, SNMG, TNMG, VNMG, WNMG

GEOMETRIE VAN NEGATIEVE WISSELPLATEN - KLEMSYSTEEM ISO P, M, D

SI



15°-18°

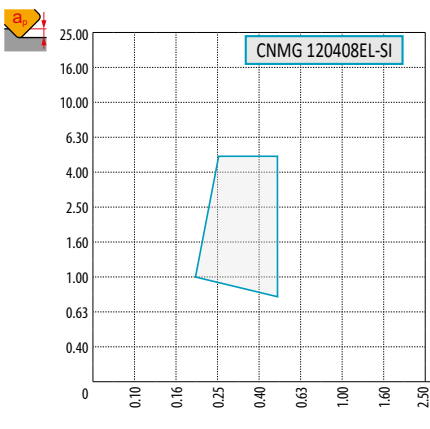

CNMG 120408EL-SI

P	M	K	N	S	H
■	■	■	▣	▣	
f	0.20 – 0.50				
a_p	0.8 – 5.0				



? CNMG, DNMG, TNMG, WNMG

SM



13° 0.25 5°

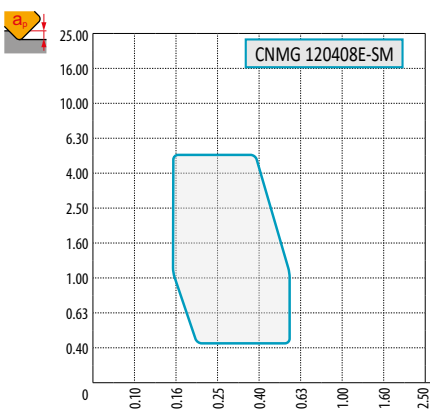

CNMG 120408E-SM

P	M	K	N	S	H
■	■	■	▣	■	▣
f	0.15 – 0.55				
a_p	0.4 – 6.0				





? CNMG, DNMG, SNMG, TNMG, VNMG, WNMG

GEOMETRIE VAN NEGATIEVE WISSELPLATEN - KLEMSYSTEEM ISO P, M, D

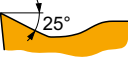
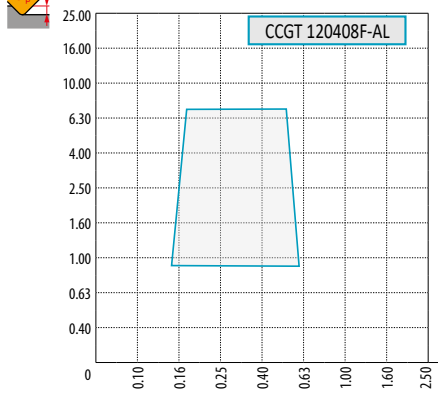

AL

P	M	K	N	S	H
			■	▣	
f → 0.05 – 0.60					
a _p → 0.2 – 7.0					
					
					
 CCGT, DCGT, SCGT, RCGT, TCGT, VCGT, WCGT					

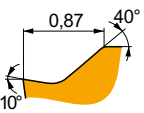
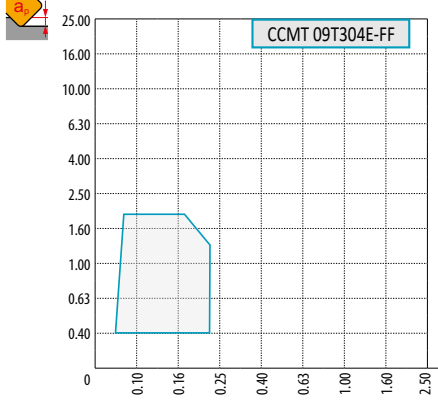

FF



P	M	K	N	S	H
■	▣				
f → 0.05 – 0.23					
a _p → 0.2 – 2.0					
					
					
 CCMT, DCMT					

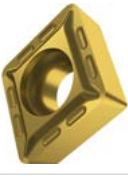
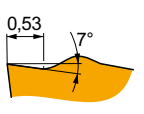
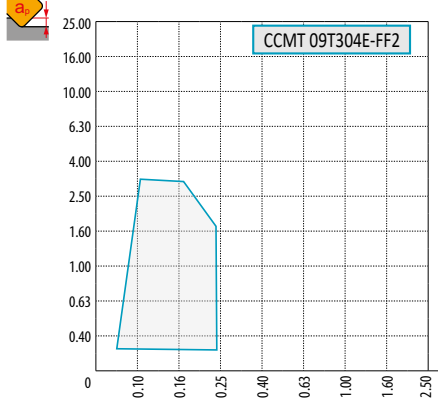

FF2

P	M	K	N	S	H
■		■			
f → 0.02 – 0.28					
a _p → 0.20 – 3.0					
					
					
 CCMT, CCGT, DCGT, DCMT, SCMT, TCGT, TCMT, VBMT, VCGT, VCGX, WCGT					

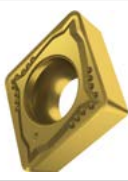
FM

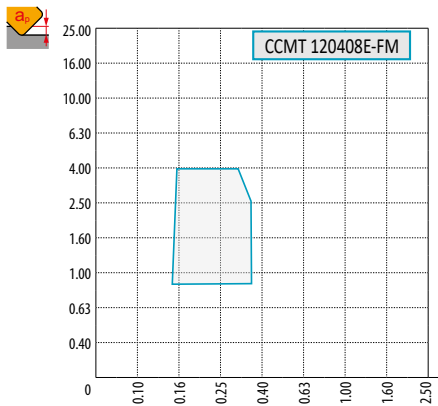



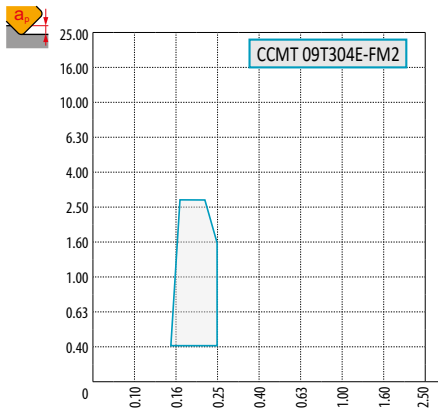

P	M	K	N	S	H
■	■	▣	▣		
f → 0.05 – 0.45					
a _p → 0.2 – 4.0					
					
					
 CCMT, DCMT, SCMT, TCMT, VBMT, WCMT					

GEOMETRIE VAN NEGATIEVE WISSELPLATEN - KLEMSYSTEEM ISO S



FM2

P	M	K	N	S	H
■	▣	■	■	■	■
f	0.04 – 0.4				
a_p	0.2 – 4.0				
					
					
?	CCMT, DCMT, ECMT, SCMT, TCMT, VBMT, VCGT				

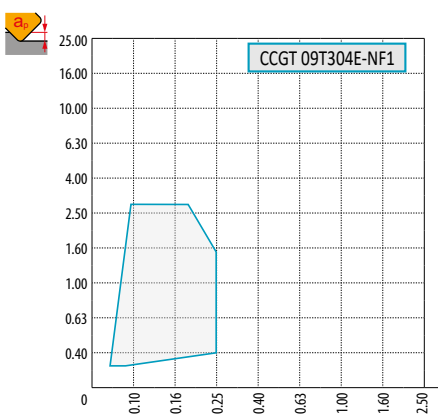

NF1

P	M	K	N	S	H
■	■	■	▣	■	▣
f	0.04 – 0.35				
a_p	0.3 – 3.5				
					
					
?	CCGT, DCGT, SCGT, TCGT				

NF2

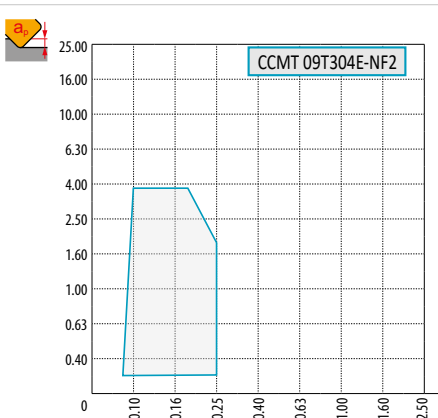



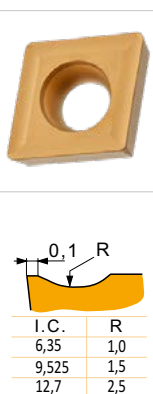

P	M	K	N	S	H
▣	■	▣	▣	■	■
f	0.05 – 0.45				
a_p	0.2 – 4.0				
					
					
?	CCMT, EPMT, SCMT, TCMT, VCGT				

RF

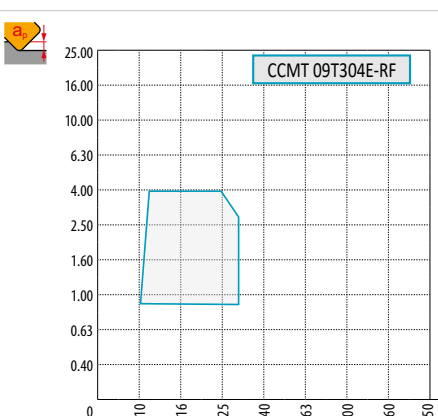

I. C.	R
6,35	1,0
9,525	1,5
12,7	2,5



P	M	K	N	S	H
■	▣	■	■	■	▣
f	0.10 – 0.60				
a_p	0.8 – 8.0				
					
					
?	CCMT, DCMT, SCMT, TCMT, WCMT				



GEOMETRIE VAN NEGATIEVE WISSELPLATEN - KLEMSYSTEEM ISO S

RM

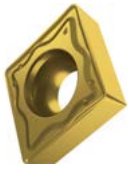
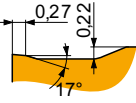
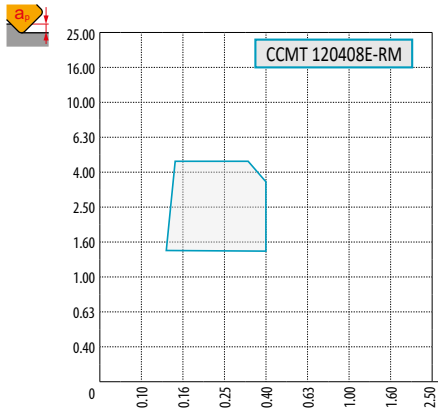



P	M	K	N	S	H
■	■	■	■	■	■
f 0.10 – 0.50					
a _p 0.8 – 4.5					

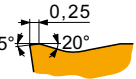
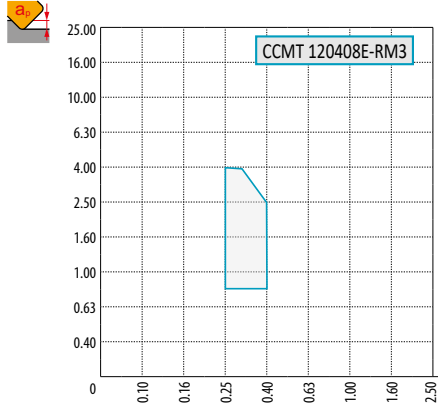

? CCMT, DCMT, SCMT, TCMT, VBMT

RM3





P	M	K	N	S	H
■	■	■	■	■	■
f 0.15 – 0.90					
a _p 0.4 – 6.00					

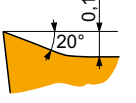
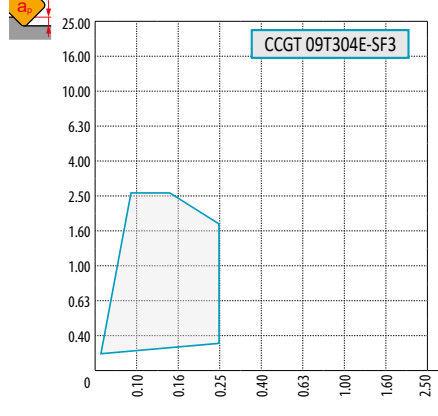

? CCMT, SCMT, TCMT, RCMT

SF3





P	M	K	N	S	H
■	■	■	■	■	■
f 0.02 – 0.35					
a _p 0.2 – 4.00					

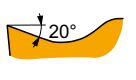
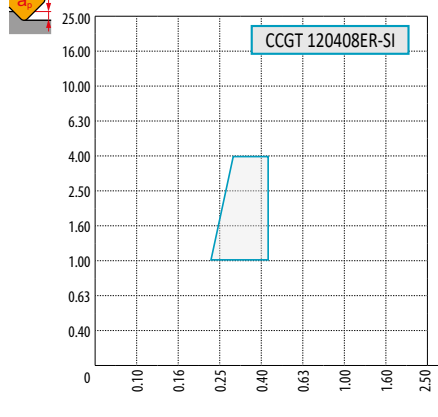

? CCGT, DCGT, ECGT, SCGT, TCGT, VCGT

SI

P	M	K	N	S	H
■	■	■	■	■	■
f 0.08 – 0.45					
a _p 0.4 – 4.0					



? CCGT, TCGT



GEOMETRIE VAN NEGatieve WISSELPLATEN - KLEMSYSTEEM ISO S

UR

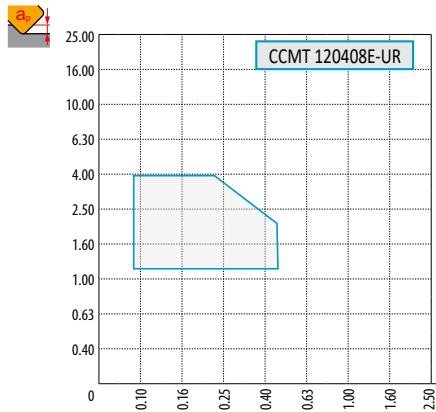
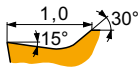

P	M	K	N	S	H
■	▣	■	■	■	■
	0.10 – 0.40				
	1.0 – 4.0				
	CCMT, DCMT, RCMT, SCMT, TCMT, VCMT, VBMT, WCMT				

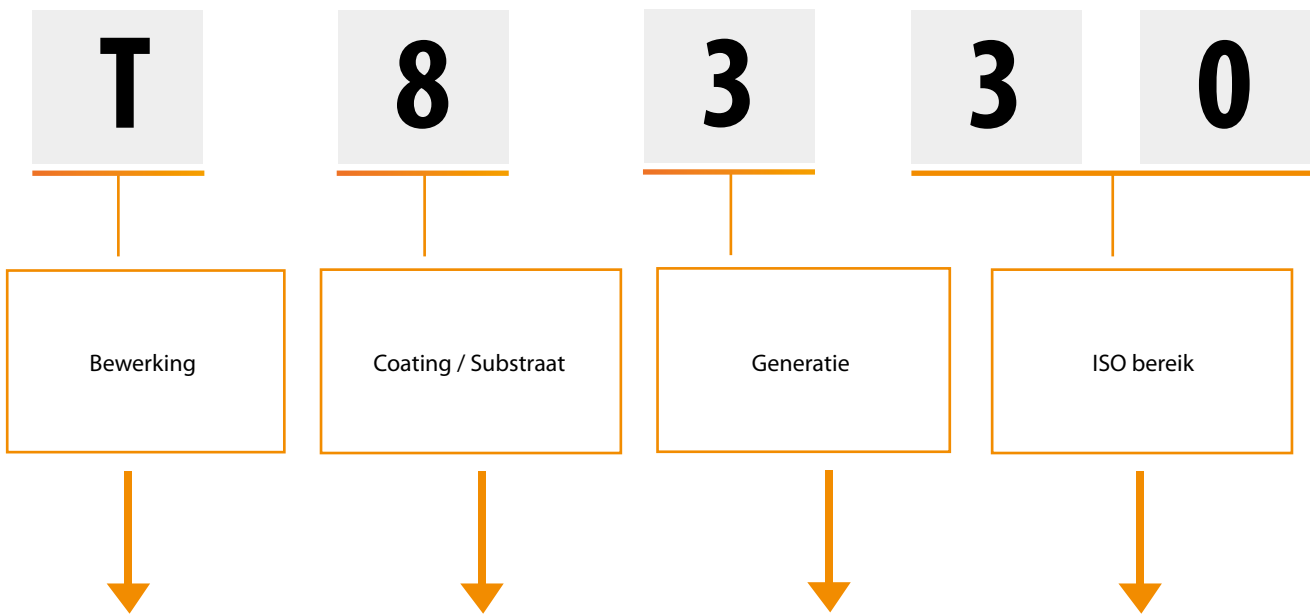

D	Boren
M	Frezen
T	Draaien
G	In- en afsteken

0 PVD 1 CVD	Speciale toepassing
2 PVD 3 CVD	Vrij
4 PVD 5 CVD	Groep K, H
6 PVD 7 CVD	Groep M, S
8 PVD 9 CVD	Universeel
B	CBN
C	Ceramisch
D	PCD
T	Cermet

1 - 9

01 - 50	
	01 - 05
	05 - 10
	10 - 20
	20 - 30
	30 - 40
	40 - 50



HARDMETAALSOORTEN - KOTTEREN

Hardmetaalsoort	Inzetgebied	Geschiktheid	Voeding	Snijnsnelheid	Bestendigheid tegen ongunstige omstandigheden	Coating	Kleur	Substraat	Voordeel koeling	Omschrijving hardmetaalsoort
T9315	P05 - P25	■				MT-CVD		FGM	+ +	Een veelzijdige kwaliteit met uitstekende slijtvaste eigenschappen, zelfs onder intensieve snijomstandigheden. Hij kan ook worden gebruikt voor bewerkingen met onderbroken sneden. Met zijn uitgebalanceerde eigenschappen kan deze soort de eerste keuze zijn voor een brede reeks draaibewerkingen bewerkingen. Niet geschikt voor lage snijnsnelheden.
	K05 - K25	■	▴	▴	▴					
	H10 - H20	■								
T9325	P15 - P35	■				MT-CVD		FGM	+ +	Vanuit technologisch oogpunt is dit een uiterst veelzijdige kwaliteit met een hoge weerstand tegen mechanische beschadiging in ongunstige snijomstandigheden en behoudt een uitstekende slijtvastheid. De juiste toepassing van deze soort vereist hoge snelheden.
	M10 - M30	■	▴	▴	▴					
	K15 - K35	■	▴	▴	▴					
	S10 - S20	■								
T9335	P20 - P45	■				MT-CVD		FGM	+ + +	Een van de taaieste kwaliteiten die bijzonder geschikt is voor ongunstige snijomstandigheden voor gemiddelde tot hoge voedingsnelheden en gemiddelde snijnsnelheden. Vergeleken met zijn voorgangers, M15 - M40 is hij niet alleen taaier, maar ook slijtvaster wat nuttig is bij intensieve snijomstandigheden.
	M15 - M40	■	▴	▴	▴					
	S15 - S25	■								
T7325	P15 - P35	■				MT-CVD		FGM	+ + +	Een van de meest universele draaikwaliteiten. Speciaal ontworpen voor het bewerken van roestvast staal. Optimaal evenwicht tussen slijtvastheid en betrouwbaarheid. Geschikt voor een breed toepassingsgebied bij draaibewerkingen.
	M10 - M25	■	▴	▴	▴					
	S10 - S25	■								
T7335	P20 - P40	■				MT-CVD		FGM	+ + +	Kwaliteit met functioneel geklasseerd substraat, met zeer hoge bedrijfszekerheid en zeer goede slijtvastheid. Het is het meest geschikt voor gebruik bij de bewerking van zeer taai M20 - M40 materialen.
	M20 - M40	■	▴	▴	▴					
	S15 - S25	■								
T5305	P05 - P15	■				MT-CVD		H	+	Kwaliteit met zeer hoge weerstand tegen chemische slijtage; geschikt voor nabewerkingen met hoge snijnsnelheden. Door zijn hoge slijtvastheid is hij ook geschikt voor de productieve bewerking van geharde en behandelde materialen (K01 - K15).
	K01 - K15	■	▴	▴	▴					
	H05 - H15	■								
T5315	P10 - P25	■				MT-CVD		H	+	Kwaliteit vooral bestemd voor productieve bewerkingen met hoge slijtvastheid en goede bedrijfszekerheid. Door zijn eigenschappen is dit materiaal bijzonder geschikt voor voorbewerking en nabewerking bij goede of licht ongunstige verspaningscondities.
	K10 - K25	■	▴	▴	▴					
	H15 - H25	■								
T0315	N05 - N20	■				PVD			+	Submicron kwaliteit voor het draaien van non-ferrometalen en hun legeringen met een evenwicht tussen slijtvastheid en taaierheid. Het is voorzien van een unieke coating met uitstekende wrijvingscoëfficiënt
T6310	P01 - P15	■				PVD		ultra submicron H	+ + +	Zeer slijtvaste draaisoort met top PVD coating. Geschikt voor nabewerkingen en toepassingen waarbij een scherpe snijkant in combinatie met een hoge slijtvastheid van de flanken van groot belang is.
	M01 - M15	■	▴	▴	▴					
	K05 - K20	■	▴	▴	▴					
	N05 - N20	■								
	S01 - S15	■								
T8315	P05 - P20	■				PVD		submicron H	+	De kwaliteit, die uitstekend bestand is tegen schuren en toch een bovengemiddelde bedrijfszekerheid biedt, is geschikt voor het bewerken met gemiddelde tot hoge snijnsnelheden in kortspanige hardere materialen.
	M05 - M20	■	▴	▴	▴					
	K05 - K25	■	▴	▴	▴					
	N05 - N25	■								
	S05 - S15	■								



HARDMETAALSOORTEN - KOTTEREN

Hardmetaalsoort	Inzetgebied	Toepasbaarheid	Voeding	Snijsnelheid	Bestendigheid tegen ongunstige omstandigheden	Coating	Kleur	Substraat	Voordeel koeling	Omschrijving hardmetaalsoort
T8330	P25 - P40	■				PVD	■	submicron H	+++	Ongetwijfeld het meest veelzijdige snijmateriaal, dat bruikbaar is voor de bewerking van alle soorten materialen en praktisch toepasbaar is bij vrijwel alle soorten draai bewerkingen. De belangrijkste voordelen zijn de hoge bedrijfszekerheid en de zeer goede wrijvingscoëfficiënt; het is dan ook geschikt voor toepassingen bij gemiddelde en lagere snijsnelheden.
	M20 - M35	■								
	K20 - K40	■								
	N15 - N30	■								
	S15 - S25	■								
	H15 - H25	■								
T8430	P20 - P40	■				PVD	■	submicron H	+++	Ongetwijfeld het meest veelzijdige snijmateriaal, dat bruikbaar is voor de bewerking van alle soorten materialen en praktisch toepasbaar is bij vrijwel alle soorten draai bewerkingen. De belangrijkste voordelen zijn de hoge bedrijfszekerheid en de zeer goede wrijvingscoëfficiënt; het is dan ook geschikt voor toepassingen bij gemiddelde en lagere snijsnelheden. De T8430 is de volgende generatie van de T8330.
	M20 - M35	■								
	K25 - K40	■								
	N15 - N30	■								
	S15 - S25	■								
	H15 - H25	■								
HF7	M10 - M20	■				×	■	submicron H	++	Onbekte kwaliteit die hoofdzakelijk bestemd is voor de bewerking van non-ferrometalen, maar ook kan worden gebruikt voor andere te bewerken materialen (behalve staal). Dit materiaal kan worden gebruikt voor draaien, frezen en kotten.
	K10 - K25	■								
	N10 - N25	■								
H07	M05 - M15	■				×	■	submicron H	++	Niet gecoate draaisoort geschikt voor bewerkingstoepassingen waarbij oxidatiebestendigheid niet het belangrijkste criterium is voor de levensduur van het gereedschap. Ontworpen voor het bewerken van Ti-gebaseerde legeringen. De kwaliteit vertoont een hoge sterkte van de snijkant samen met een goede slijtvastheid.
	K10 - K25	■								
	N10 - N30	■								
	S01 - S20	■								
TT310	P10 - P25	■				PVD	■	Cermet	+ / -	Gecoate cermet gebruikt voor fijn- en nadraaien van koolstof- en gelegeerd staal (inclusief roestvast staal). Zijn uitstekende wrijvingscoëfficiënt wordt nog verbeterd door de coating die met de PVD-techniek wordt aangebracht.
	M15 - M25	■								
TT010	P01 - P10	■				×	■	Cermet	+ / -	Ongecoate cermet, die geschikt is voor het fijn verspanen van alle staalsoorten (ook roestvast staal) bij zeer lage voedingsnelheden. Het belangrijkste voordeel is de minimale radius van de snijkant en de hoge weerstand tegen fysische en chemische slijtagemechanismen.
	M01 - M10	■								
PD1	N05 - N25	■				×	■	PCD	--	PKD kwaliteit voor het draaien van non-ferro materialen. Ideale keuze voor het werken met hoge snijsnelheden en kleine voedingen onder stabiele omstandigheden.
TB310	K01 - K10	■				×	■	CBN	--	CBN kwaliteit voor het bewerken van geharde materialen. Geschikt voor het bewerken met hoge snijsnelheid en kleine voedingen onder stabiele omstandigheden.
	S05 - S10	■								
	H01 - H10	■								

Substraat

H	Op WC-Co gebaseerd substraat (WC=Wolframcarbide)
submicron H	Op WC-Co gebaseerd fijnkorrelig substraat
ultra submicron H	Op WC-Co gebaseerd zeer fijnkorrelig substraat
FGM	Substraat waarin de eigenschappen van de elementen elkaar versterken
Cermet	Gesinterd hardmetaal zonder WC
PCD	Polykristallijne Diamant
CBN	Kubisch Borium Nitride

Coating

MT-CVD	Chemische coatingsmethode bij middel hoge temperatuur.
PVD	Fysische coatingsmethode bij lage temperatuur.
×	Ongecoate soort

Gebruik van koelvloeistof

+++	Koeling is noodzakelijk
++	Koeling wordt aanbevolen
+/-	Koeling is optioneel
--	Geen koeling toepassen



TABEL VOOR SNIJSNELHEDEN BIJ KOTTEREN

De standaard wisselplaten voor draaien worden in de kottergereedschappen gebruikt, maar de voor het draaien aanbevolen snijcondities zijn hier niet van toepassing (gegevens in de vakjes), dus kies de snijcondities volgens de volgende tabel.

Materiaal	Vorbewerken met wisselplaat				Nabewerken met wisselplaat									
	Diameter	Snijnsnelheid v_c	Voeding f_z	Snedediepte a_p	Diameter	Snijnsnelheid v_c	Voeding f_z	Max. snedediepte $a_{p \max}$						
P	24 – 30	110 – 140	0.05 – 0.15	0.05 – 0.30	24 – 30	110 – 140	0.15 – 0.25	4.2						
	29 – 40	115 – 150			0.10 – 0.20	0.06 – 0.35	29 – 40	105 – 140	0.15 – 0.30	5.7				
	39 – 50		0.07 – 0.50	0.30 – 0.40			39 – 50	105 – 150	0.20 – 0.30	6.3				
	49 – 102				0.07 – 0.50	0.25 – 0.35	49 – 102		105 – 150		0.30 – 0.40			
	100 – 220						0.07 – 0.50					0.30 – 0.40	100 – 220	105 – 150
	220 – 500		0.07 – 0.50	0.30 – 0.40	220 – 500	105 – 150		0.30 – 0.40						
M	24 – 30	70 – 110			0.07 – 0.15		0.12 – 0.35		24 – 30	69 – 90	0.12 – 0.20	4.2		
	29 – 40	80 – 110	0.20 – 0.50	0.12 – 0.35		29 – 40		70 – 100	0.15 – 0.25	5.7				
	39 – 50				0.10 – 0.20	0.25 – 0.75	39 – 50		70 – 100	0.20 – 0.30	6.3			
	49 – 102		0.10 – 0.20	0.25 – 0.75			49 – 102					70 – 100	0.20 – 0.30	
	100 – 220						0.12 – 0.20							0.25 – 0.75
	220 – 500		0.12 – 0.20	0.25 – 0.75	220 – 500	70 – 100			0.25 – 0.35					
K	24 – 30	70 – 110			0.07 – 0.15		0.12 – 0.35	24 – 30		60 – 110	0.20 – 0.30	4.2		
	29 – 40	80 – 115	0.20 – 0.50	0.12 – 0.35		29 – 40		60 – 110	0.25 – 0.35		5.7			
	39 – 50				0.12 – 0.20	0.25 – 0.75	39 – 50		60 – 110		0.30 – 0.40	6.3		
	49 – 102		0.12 – 0.20	0.25 – 0.75			49 – 102						60 – 110	0.30 – 0.40
	100 – 220						0.12 – 0.20							
	220 – 500		0.12 – 0.20	0.25 – 0.75	220 – 500	60 – 110					0.30 – 0.45			
N	24 – 30	150 – 300			0.05 – 0.15		0.12 – 0.35			24 – 30		120 – 300		0.20 – 0.30
	29 – 40	150 – 360	0.10 – 0.20	0.20 – 0.50				29 – 40		150 – 370	0.25 – 0.35	5.7		
	39 – 50				0.10 – 0.25		0.25 – 0.75	39 – 50	150 – 370		0.30 – 0.40	6.3		
	49 – 102		0.10 – 0.25	0.25 – 0.75				49 – 102					150 – 370	0.30 – 0.45
	100 – 220							0.10 – 0.25						
	220 – 500		0.10 – 0.25	0.25 – 0.75	220 – 500	150 – 370	0.30 – 0.40							
S	24 – 30	30 – 40			0.07 – 0.15			0.12 – 0.35			24 – 30	25 – 35		0.12 – 0.20
	29 – 40	30 – 45	0.20 – 0.50	0.12 – 0.35			29 – 40			30 – 40	0.15 – 0.25	5.7		
	39 – 50				0.10 – 0.20		0.25 – 0.75	39 – 50	30 – 40		0.20 – 0.30	6.3		
	49 – 102		0.10 – 0.20	0.25 – 0.75				49 – 102					30 – 40	0.20 – 0.30
	100 – 220							0.10 – 0.20						
	220 – 500		0.10 – 0.20	0.25 – 0.75	220 – 500	30 – 40	0.20 – 0.35							
H	24 – 30	30 – 40			0.07 – 0.15			0.12 – 0.35			24 – 30	25 – 35		0.12 – 0.20
	29 – 40	30 – 45	0.20 – 0.50	0.12 – 0.35			29 – 40			30 – 40	0.15 – 0.25	5.7		
	39 – 50				0.30 – 45		0.25 – 0.75	39 – 50	30 – 40		0.20 – 0.30	6.3		
	49 – 102		0.30 – 45	0.25 – 0.75				49 – 102					30 – 40	0.20 – 0.30
	100 – 220							0.30 – 45						
	220 – 500		0.30 – 45	0.25 – 0.75	220 – 500	30 – 40	0.20 – 0.35							

Instelinstructies - voorberekings koppen

- Monteer de wisselplaten in de zittingen.
- Los de blokkeringschroeven en haal deze daarna licht aan.
- Verdraai de instelschroef om de slede(s) in te stellen onder de gewenste diameter.
- Draai de instelschroef nu verder om de slede(s) naar de gewenste diameter te draaien.
- Instellen kan op de machine of buiten de machine geschieden maar ook op een voorinstelapparaat.
- Draai blokkeringschroeven nadien goed vast.



Voor kotterkoppen vanaf 68 (cassette uitvoering)

- Cassettes hebben individuele radiale verstelschroeven.
- Maak de blokkeringschroeven van de cassettes los.
- Door de instelschroef te verstellen van de cassettes kunnen deze in een gecentreerde positie worden gezet. ($R1 = R2$)

Instelinstructies – fijn kotterkoppen

- Alle fijn en micro kotterkoppen hebben een micrometer verstelling met 0.002mm verdeling.
- Monteer nieuwe wisselplaten in de zittingen.
- Instellen dient bij voorkeur te geschieden op een voorinstelapparaat.
- Maak de blokkeringschroeven los en haal ze dan heel licht aan.
- Verdraai de instelschroef van de slede onder de gewenste diameter.
- Draai instelschroef nu in omgekeerde richting de gewenste diameter door de wisselplaat neushoek tegen de kruislijn te stellen.
- Draai blokkeringschroeven goed vast.
- De praktijk kan uitwijzen dat om een specifieke gattolerantie te bereiken het beter is om eerst een kleinere diameter te kotten en deze na te meten. Aansluitend kan de kotterkop dan middels de microverstelling een correctie worden gedaan waarna de uiteindelijke diameter wordt bereikt.



Keuze instelhoek

75°



90°



- Doorlopende gaten
- Zwaar voorbereken met verhoogde voeding
- Neigen het bestaande gat te volgen (boring onnauwkeurig gepositioneerd)
- Diepe gaten - lange kottergereedschappen (startgat voor centering is aanbevolen!)

- Blinde gaten
- Getrapte gaten met 90° borst
- Ondiepe gaten - korte kottergereedschappen (om dispositionering te corrigeren)
- Stapsgewijs kotters met cartridges (vanaf 68)

Deze types kotters kunnen worden uitgevoerd met een cassette voor stapsgewijs kotters. Let op dat deze cartridges gemarkeerd worden met een „S“ aan het eind van de codering.

Bijvoorbeeld: 2CT 90 402 N S; 2CT 90 300 S; 2CT 90 402 S.

Symmetrisch kotters

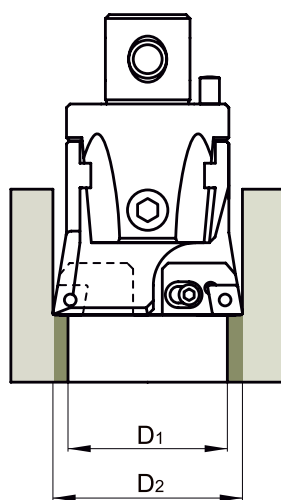

Stapsgewijs kotters

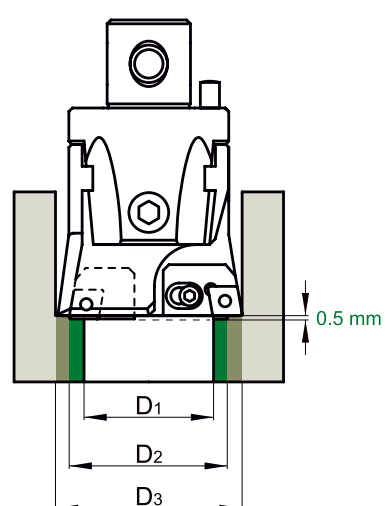

2CT □□ □□□ + 2CT □□ □□□
3CT □□ □□□ + 3CT □□ □□□

2CT □□ □□□ S + 2CT □□ □□□
3CT □□ □□□ S + 3CT □□ □□□

Stapsgewijs kotters biedt de mogelijkheid tot grotere spaanvolumes tussen D1 en D3 per gang. Ongeveer 4 tot 6 mm in vergelijking met symmetrisch kotters.

Let op dat bij stapsgewijs kotters de voeding per minuut berekend moet worden zoals bij een 1-snijder..



SAMESTELLING VAN GROTE KOTTERKOPPEN

Let op: Tijdens het montageproces dient de klemschroef (pos.2) los zijn.

Monteren van een kotterkop voor grote diameters op de conische opname

Verwijder de positioneerschroeven (pos.1) en verschuif de sledes zodat de 4 bevestigingsschroefgaten zichtbaar worden. Plaats de kotterkop over de conische opname met de schroefgaten in lijn met elkaar. Plaats dan de schroeven en draai deze goed vast.

Monteer de sledes aan de kotterkop

Plaats de sledes in de V-groef vertanding en druk deze over de schroefgaten. Plaats de schroeven (pos.1) en draai deze licht aan. Deze schroeven hebben een dubbele functie, het fixeren van de slede in de V-groefvertanding en het koppelen van de 2 sledes middels de bronzen moer. Controleer tenslotte of de sledes soepel verschuiven.

FIJN KOTTEREN

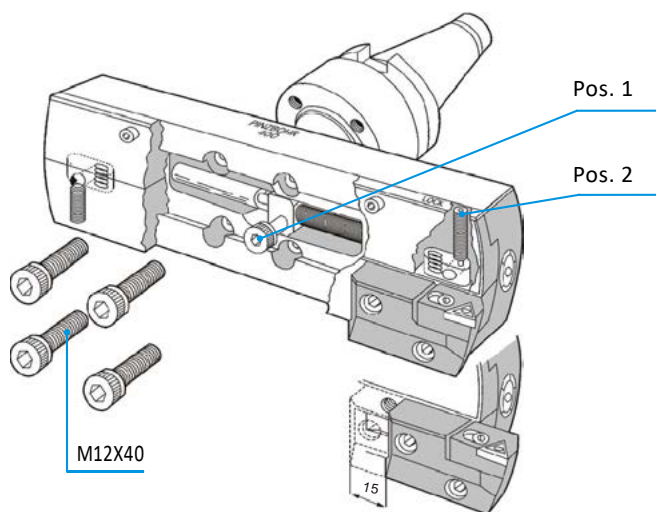

Bewerkingstoeslag is afhankelijk van het te bewerken materiaal, machine- en opspanningsconditie en de uitsteeklengte.

Kotterdiepte - uitsteeklengte bij voor- en nabewerken

Met inachtneming van de passende condities bij het werken met hardmetaal gereedschap, zijn dieptes van 5xD bij voorbewerken en 3xD bij fijn kotten haalbaar.

Met het stijgen van de uitsteeklengte vermindert de stabiliteit van het gereedschap. Gereedschappen met een lange uitsteeklengte hebben de neiging om af te buigen en kadanstrillingen te veroorzaken. Deze kadanstrillingen kunnen verspringen van de instellingen veroorzaken waardoor buitenmaatse of conische gaten ontstaan. Vaak kan de kadanstrilling worden verminderd door het verhogen van de voeding en (of) het verlagen van de snijsnelheid.

Denk erom dat het verspaningsgedrag ook verandert door het naar buiten verstellen van de kotterkop sledes. Ook daardoor kan het nodig zijn om de verspaningscondities aan te passen.

Kotterdiepte - uitsteeklengte voor micro kotterkoppen

De maximale kotterdiepte met stalen boorbaren mag niet groter zijn dan 5xD van de baar en bij hardmetalen baren max 7xD. Probeer steeds met een zo kort mogelijke baar te werken die nodig is om de kotterdiepte te bereiken.

Voor zware voorbewerkingen dient de grootst mogelijke neusradius te worden gekozen tenzij er anders wordt voorgeschreven.

Voor fijn nabewerken met een minimale bewerkingstoeslag bewerkingstoeslag dient de kleinste neusradius gekozen te worden om de zijdelingse doorbuiging van het gereedschap te minimaliseren. Dit is zeker belangrijk bij het werken met grotere uitsteeklengtes.

VOORBEBERKEN

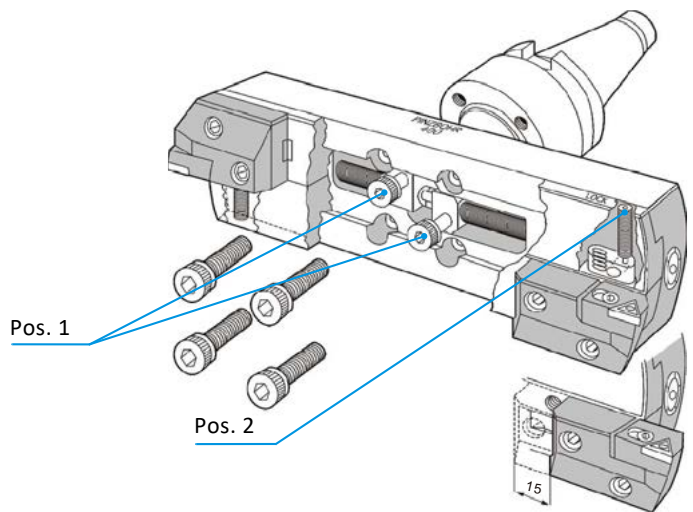

Voorkotteren met 75° of 90°

De 75° kotterkop dient gebruikt te worden bij grote bewerkingstoeslag en wanneer er niet tegen een borst in blinde of getrapte gaten wordt gewerkt. De 75° kop heeft de neiging om zichzelf te centreren naar het bestaande gat waardoor hij stabielers verspaand. Wanneer dit bestaande gat naast de hartlijn licht of onder een hoek staat dan is het beter om de 90° kop te kiezen omdat deze minder de neiging heeft om het bestaande gat te volgen.

Verspaand volume

De maximale bewerkingstoeslag dient bij voorkotteren gereduceerd te worden indien er in harde materialen wordt gewerkt. Dit geldt ook bij grote uitsteeklengtes en ver uitgeschoven sledes.

Neusradius van de wisselplaat

Voor zware voorbewerkingen dient de grootst mogelijke neusradius te worden gekozen tenzij er anders wordt voorgeschreven.

Voor fijn nabewerken met weinig spaanafname dient de kleinste neusradius gekozen te worden om de zijdelingse doorbuiging van het gereedschap te minimaliseren. Dit is zeker belangrijk bij het werken met grotere uitsteeklengtes.

4 snijkanten per wisselplaat

De 80° ruitvormige wisselplaten hebben normaliter 2 snijkanten. Hoewel alle 4 de snijkanten gebruikt kunnen worden in de 75° en 90° kotterkoppen van dezelfde grootte.





SIMPLY RELIABLE

De spaan is een duidelijke en ongecompliceerde vorm met een verhaal. Als professional kunt u de kwaliteit van het werk beoordelen door alleen te kijken naar de spaan. Het geeft een duidelijk en consistent signaal en dat is waarom we het gebruiken als een symbool voor het zijn van 'Simply Reliable'.

DORMER PRAMET

Austria

T: +31 10 2080 240
info.at@dormerpramet.com

Belgium & Luxembourg

T: +32 3 440 59 01
info.be@dormerpramet.com

Brazil

T: +55 11 5660 3000
info.br@dormerpramet.com

Canada

T: (888) 336 7637
En Français: (888) 368 8457
cs.canada@dormerpramet.com

China

T: +86 21 2416 0508
info.cn@dormerpramet.com

Croatia

T: +385 98 407 489
info.hr@dormerpramet.com

Czech Republic

T: +420 583 381 111
info.cz@dormerpramet.com

Denmark

T: 808 82106
info.se@dormerpramet.com

Finland

T: 0205 44 7003
info.fi@dormerpramet.com

France

T: +33 (0)2 47 62 57 01
info.fr@dormerpramet.com

Germany

T: +49 9131 933 08 70
info.de@dormerpramet.com

Hungary

T: +36-96 / 522-846
info.hu@dormerpramet.com

India

T: +91 11 4601 5686
info.in@dormerpramet.com

Italy

T: +39 02 30 70 54 44
info.it@dormerpramet.com

Kazakhstan

T: +7 771 305 11 45
info.kz@dormerpramet.com

Mexico

T: +52 (555) 7293981
cs.mexico@dormerpramet.com

Netherlands

T: +31 10 2080 240
info.nl@dormerpramet.com

Norway

T: 800 10 113
info.se@dormerpramet.com

Poland

T: +48 32 78-15-890
info.pl@dormerpramet.com

Portugal

T: +351 21 424 54 21
info.pt@dormerpramet.com

Romania

T: +4(0)730 015 885
info.ro@dormerpramet.com

Russia

T: +7 (495) 775 10 28
info.ru@dormerpramet.com

Slovakia

T: +421 (41) 764 54 60
info.sk@dormerpramet.com

Slovenia

T: +385 98 407 489
info.si@dormerpramet.com

Spain

T: +34 935717722
info.es@dormerpramet.com

Sweden

responsible for Iceland
T: +46 35 16 52 96
info.se@dormerpramet.com

Switzerland

T: +31 10 2080 240
info.ch@dormerpramet.com

Turkey

T: +90 533 212 45 47
info.tr@dormerpramet.com

Ukraine

T: +38 067 566 38 80
T: +38 067 566 81 51
info.ua@dormerpramet.com

United Kingdom

responsible for Ireland
T: 0870 850 4466
info.uk@dormerpramet.com

United States of America

T: (800) 877-3745
cs@dormerpramet.com

Other countries

South America

T: +55 11 5660 3000
info.br@dormerpramet.com

Adria

T: +420 583 381 527
info.rcee@dormerpramet.com

Rest of the World

Dormer Pramet International UK
T: +44 1246 571338
info.int@dormerpramet.com

Dormer Pramet International CZ
T: +420 583 381 520
info.int.cz@dormerpramet.com

DP-CAT-HOLEMAKING-2021-NL

FOLLOW US...



www.dormerpramet.com



[youtube.com/dormerpramet](https://www.youtube.com/dormerpramet)



[facebook.com/dormerprametsocial](https://www.facebook.com/dormerprametsocial)



[linkedin.com/company/dormerpramet](https://www.linkedin.com/company/dormerpramet)



[instagram.com/dormerprametsocial](https://www.instagram.com/dormerprametsocial)



[twitter.com/dormerpramet](https://www.twitter.com/dormerpramet)