

DORMER PRAMET

BORRNING

2024



DORMER

PRAMET









HÅLTAGNING ALLMÄNT INNEHÅLL

HÅLTAGNING

Verktyg för allmän tillverkning, konstruktion, underhåll, reparation. Används vanligtvis med elverktyg och konventionella maskiner.
Lämpliga för låga skärdata.

	Extrakorta – och NC borrar	< 2.5 x D	 7
	Borr Standard längd	< 4 x D	17
	Långa och extra långa borrar	< 10 x D	35
	Borrar för flyg – och rymdindustrin	NAS 907	41
	Försänkare		59
	Brotchar		73
	Borrsatser och tillbehör		90

Verktyg för blandad tillverkning. Används vanligtvis med konventionella maskiner med maskinmatning och CNC. Lämplig för måttliga skärdata.

	Extra korta borrar	< 3 x D	103
	Borr Standard längd	< 5 x D	115
	Långa och extra långa borrar	< 25 x D	125
	Stegborrar och försänkare		135
	Centrumborr		147
	Försänkare		157
	Brotchar		167

Verktyg för processsäkerhet och produktivitet. Används vanligtvis vid CNC och automatiserad tillverkning.
Lämpliga för höga skärdata.

	NC borrar i solid hårdmetall		181
	Borr i solid hårdmetall	< 8 x D	187
	Hydraborr (utbytbar borrarspets)	1.5 – 12 x D	217
	Korthålsborr (U-borrar)	2 – 5 x D	235
	Brotchar i hårdmetall		249

ANVISNINGAR

Hur läser man katalogdata? (ISO 13399, ikoner, navigering)			258
Översikt över material, beläggningar och sorter			270
Borr – Teknisk information	274	Diagram över matningshastighet	272
Brotchar – teknisk information	279	Diagram över matningshastighet	276
Korthålsborrar – Teknisk information	288	Diagram över matningshastighet	281
Materialgrupper för arbetsstycken (WMG)			291



SOLID ROUND TOOLS – CONTENT (ALPHABETICAL)

PRODUCT FAMILY		PRODUCT FAMILY		PRODUCT FAMILY		PRODUCT FAMILY	
0		A295	95	B660	85	G705	141
2ACO	57	A296	156	B670	86	G706	142
500-6/501-6/502-6	48	A321	18	B680	87	H	
500-12/501-12/502-12	50	A400	143	B690	64	H851	218
A		A402	144	B901	168	H853	219
A002	30	A412	146	B903	82	H855	221
A002S	32	A413	145	B952	83	H858	223
A022	14	A510	120	B953	81	H860	229
A080	99	A520	105	B954	175	H861	229
A087	93	A553	122	C		H8512	224
A088	92	A620	107	CO500-6/CO501-6	55	M	
A089	92	A720	104	CO500-12/CO501-12	56	M900	98
A094	93	A723	8	E		M901	99
A095	94	A777	116	EP	247	M902	99
A099 Drillboy	94	A900	126	E		R	
A100	19	A920	110	G106	67	R003	123
A101	23	A940	128	G107	69	R10A/R15A/R18A	44
A108	33	A952	133	G125	137	R10B/R15B/R18B	46
A110	36	A976	130	G129	62	R10CO/R15CO/R18CO	53
A117	108	A977	131	G132	63	R023	112
A119	10	A978	132	G135	60	R40C/R41C/R42C	42
A120	12	B		G136	66	R88CO/R89CO	52
A122	9	B100	74	G137	164	R122	184
A123	11	B101	174	G138	165	R123	182
A125	38	B121	176	G142	65	R125	185
A130	26	B122	88	G149	159	R200	156
A147	118	B161	173	G154	61	R453	203
A170	24	B170	171	G171	163	R454	199
A188	95	B180	169	G236	71	R457	195
A190	96	B301	80	G314	136	R458	191
A191	97	B400	250	G335	158	R459	207
A191_2	97	B411	254	G338	166	R463	213
A200	148	B441	253	G400	162	R467	210
A201	153	B442	255	G506	68	R510	190
A205	149	B481	251	G560	160	R520	188
A206	150	B610	76	G570	161	R950	225
A210	152	B620	78	G600	70	R960	227
A225	154	B630	84	G702	138	R6011	183
A242	155	B640	177	G703	139	R7131	216
A266	151	B650	79	G704	140		



INDEXABLE TOOLS – CONTENT (ALPHABETICAL)

PRODUCT FAMILY	
0	
802D	236
803D	238
804D	241
805D	243

INDEXABLE INSERTS – CONTENT (ALPHABETICAL)

PRODUCT FAMILY	
S	
SCET	245
XPET	246



**VERKTYG FÖR ALLMÄN TILLVERKNING, KONSTRUKTION,
UNDERHÅLL, REPARATION. ANVÄNDS VANLIGTVIS MED ELVERKTYG
OCH KONVENTIONELLA MASKINER.**

Verktymmaterial (BMC)	HSS-E	HSS	HSS	HSS	HSS	HSS								
Standard (BSG)	DORNER	DIN 1897	DIN 1897	DIN 1897	DIN 1897	DIN ANSI								
Användbar längd (ULDR)	1×D	1×D	1.25×D	1.5×D	2.5×D	2.5×D								
Spetsvinkel	180°	90°/120°	120°	120°	135°	135°								
Beläggning	Bronze	Bright	ST	ST	ST	TiN-Tip								
Skaft														
Spiralform	λ 20-35°	λ 20-35°	λ 20-35°	λ 20-35°	λ 20-35°	λ 20-35°								
Skärriktning	R	R	R	R	R	R								



Produktfamilj		A723	A122	A119	A123	A120	A022							
PSF skärdiametrar		6.00 - 8.00	6.00 - 20.00	3.30 - 5.10	3/32 - 1/4	0.50 - 25.00	0.50 - 16.00							
		8	9	10	11	12	14							
P	P1	■	■	■	■	■	■							
	P2	■	■	■	■	■	■							
	P3	■	■	■	■	■	■							
	P4	■	■	■	■	■	■							
M	M1		■	■	■	■	■							
	M2		■	■	■	■	■							
	M3		■	■	■	■	■							
	M4		■	■	■	■	■							
K	K1		■			■	■							
	K2		■			■	■							
	K3		■			■	■							
	K4		■			■	■							
	K5		■			■	■							
N	N1		■	■	■	■	■							
	N2		■	■	■	■	■							
	N3		■	■	■	■	■							
	N4		■	■	■	■	■							
	N5													
S	S1		■	■	■	■	■							
	S2		■	■	■	■	■							
	S3		■	■	■	■	■							
	S4		■	■	■	■	■							
H	H1													
	H2													
	H3													
	H4													



A723



Punktsvetsborr av HSS-E (5% Kobolt), gulanlöpt

Ett effektivt borr för att borra ur punktsvetsar i plåtförband. Används vanligtvis i samband med bilreparationer. Borrarna har korta spår och en speciell utformning med centrumspets och sidoskår som skär ut en skiva med svetspunkten. Välj en något större diameter än själva svetspunkten för bästa resultat. Ett pålitligt borr med lång livslängd. Gulanlöpningen indikerar att borret är tillverkat av HSS-E stål med koboltinnehåll.

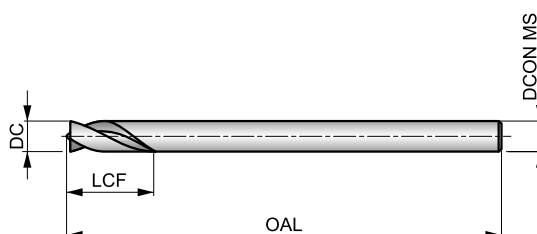

HSS-E	DORMER	1xD
Bronze		λ 20-35°
R	DC h8	

Arbetsmaterialgrupper och startvärden för skärhastighet (m/min) och matningskod. Tabeller med matningar finns med början på sidan 274

P1.1 ■ 33 D	P1.2 ■ 37 D	P1.3 ■ 38 D	P2.1 ■ 28 D	P2.2 ■ 25 C	P3.1 ■ 20 C	P3.2 ■ 20 C	P4.1 ■ 20 C
-----------------------	-----------------------	-----------------------	-----------------------	-----------------------	-----------------------	-----------------------	-----------------------

Product	DC	DC	LCF	OAL	DCON MS
	(mm)	(inch)			
A7236.0X66	6.00	0.2362	18.0	66.0	6.00
A7236.0X93	6.00	0.2362	18.0	93.0	6.00
A7238.0X79	8.00	0.3150	24.0	79.0	8.00
A7238.0X117	8.00	0.3150	24.0	117.0	8.00

A122



Centrerborr av HSS, 90° eller 120° spetsvinkel, blank

Centrerborr av HSS. Används för att göra styrningar för efterkommande borring. Borret är självcentrerande. Finns med antingen 90° eller 120° spetsvinkel. Blank finish.

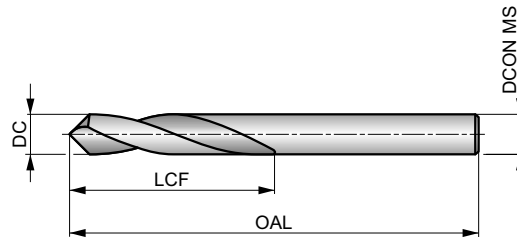

HSS	DIN 1897	1xD
90°/120°	Bright	
λ 20-35°	R	DC h8

Arbetsmaterialgrupper och startvärden för skärhastighet (m/min) och matningskod. Tabeller med matningar finns med början på sidan 274

P1.1 ■ 36 E	P1.2 ■ 40 E	P1.3 ■ 41 E	P2.1 ■ 31 E	P2.2 ■ 27 C	P2.3 ■ 24 C	P3.1 ■ 21 C	P3.2 ■ 17 C	P3.3 ■ 14 C	P4.1 ■ 12 C	P4.2 ■ 10 C	P4.3 ■ 9 B	M1.1 ■ 22 C	M1.2 ■ 19 C
M2.1 ■ 20 C	M2.2 ■ 16 C	M3.1 ■ 10 D	M3.2 ■ 9 D	M3.3 ■ 8 D	M4.1 ■ 10 B	K1.1 ■ 32 E	K1.2 ■ 24 C	K1.3 ■ 18 C	K2.1 ■ 25 C	K2.2 ■ 20 C	K2.3 ■ 16 B	K3.1 ■ 22 C	K3.2 ■ 17 C
K3.3 ■ 13 B	K4.1 ■ 20 C	K4.2 ■ 15 C	K4.3 ■ 11 B	K4.4 ■ 10 B	K4.5 ■ 8 B	K5.1 ■ 23 C	K5.2 ■ 17 C	K5.3 ■ 13 B	N1.1 ■ 33 E	N1.2 ■ 25 E	N1.3 ■ 17 E	N2.1 ■ 46 D	N2.2 ■ 42 D
N2.3 ■ 30 D	N3.1 ■ 56 D	N3.2 ■ 33 E	N3.3 ■ 17 D	N4.1 ■ 30 F	N4.2 ■ 35 E	N4.3 ■ 17 D	S1.1 ■ 27 C	S1.2 ■ 12 B	S1.3 ■ 7 A	S2.1 ■ 11 C	S2.2 ■ 6 A	S3.1 ■ 8 C	S3.2 ■ 4 A
S4.1 ■ 6 C	S4.2 ■ 3 A												

Product	DC	DC	LCF	OAL	DCON MS
	(mm)	(inch)			
A1226.0X90	6.00	0.2362	30.0	66.0	6.00
A1226.0X120	6.00	0.2362	30.0	66.0	6.00
A1228.0X90	8.00	0.3150	33.0	79.0	8.00
A1228.0X120	8.00	0.3150	33.0	79.0	8.00
A12210.0X90	10.00	0.3937	35.0	89.0	10.00
A12210.0X120	10.00	0.3937	35.0	89.0	10.00
A12212.0X90	12.00	0.4724	40.0	102.0	12.00
A12212.0X120	12.00	0.4724	40.0	102.0	12.00
A12216.0X90	16.00	0.6299	40.0	115.0	16.00
A12216.0X120	16.00	0.6299	40.0	115.0	16.00
A12220.0X90	20.00	0.7874	55.0	131.0	20.00

A119



Extrakort HSS-borr, dubbeländat, ånganlöpt

Extra kort borr med skär i båda ändarna. Mycket lämpligt för borrarng av popnithål i tunnplåt. Ånganlöpt.

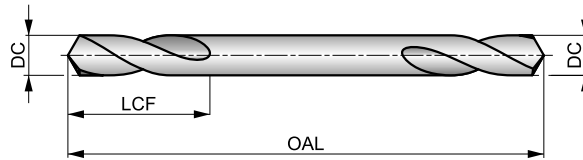

HSS	DIN 1897	1.25xD
120°		
λ 20-35°		DC h8

Arbetsmaterialgrupper och startvärden för skärhastighet (m/min) och matningskod. Tabeller med matningar finns med början på sidan 274

P1.1 ■ 31 C	P1.2 ■ 34 C	P1.3 ■ 35 C	P2.1 ■ 26 C	P2.2 ■ 23 C	P2.3 ■ 20 C	P3.1 ■ 12 C	P3.2 ■ 9 C	P3.3 ■ 8 C	P4.1 ■ 7 C	P4.2 ■ 6 C	P4.3 ■ 5 A	M1.1 ■ 21 A	M1.2 ■ 17 A
M2.1 ■ 18 A	M2.2 ■ 15 A	M3.1 ■ 8 C	M3.2 ■ 7 C	M3.3 ■ 6 C	M4.1 ■ 10 A	N1.1 ■ 33 C	N1.2 ■ 25 C	N1.3 ■ 17 C	N2.1 ■ 46 C	N2.2 ■ 42 C	N2.3 ■ 30 C	N3.1 ■ 56 C	N3.2 ■ 33 C
N3.3 ■ 17 A	N4.1 ■ 30 I	N4.2 ■ 35 C	S1.1 ■ 27 A	S1.2 ■ 12 A	S1.3 ■ 17 A	S2.1 ■ 5 C	S2.2 ■ 4 C	S3.1 ■ 4 C	S3.2 ■ 3 C	S4.1 ■ 3 C	S4.2 ■ 2 C		

Tunnplätsborr

Product	DC	DC	LCF	OAL	DCON MS
	(mm)	(inch)			
A1193.3	3.30	0.1299	11.0	49.0	3.30
A1193.6	3.60	0.1417	12.0	52.0	3.60
A1194.1	4.10	0.1614	14.0	55.0	4.10
A1194.2	4.20	0.1654	14.0	55.0	4.20
A1194.9	4.90	0.1929	17.0	62.0	4.90
A1195.1	5.10	0.2008	17.0	62.0	5.10

A123

DORMER



Extra kort borr av HSS för tunnplåt, ånganlöpt

Tunnplåtsborr speciellt lämpat för borrarng av Pop-nithål i olika material. 120° spets och ånganlöpt.

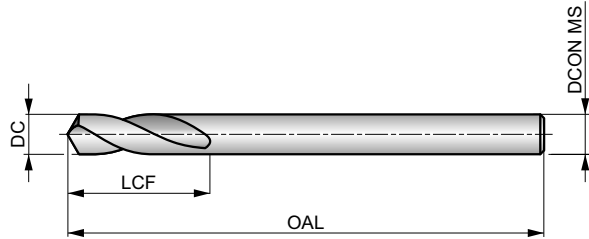

HSS	DIN 1897	1.5×D
120°	ST	
λ 20-35°	R	DC h8

Arbetsmaterialgrupper och startvärden för skärhastighet (m/min) och matningskod. Tabeller med matningar finns med början på sidan 274

P1.1 ■ 36 E	P1.2 ■ 40 E	P1.3 ■ 41 E	P2.1 ■ 31 E	P2.2 ■ 27 C	P2.3 ■ 24 C	P3.1 ■ 21 C	P3.2 ■ 17 C	P3.3 ■ 14 C	P4.1 ■ 12 C	P4.2 ■ 10 C	P4.3 ■ 9 B	M1.1 ■ 22 C	M1.2 ■ 19 C
M2.1 ■ 20 C	M2.2 ■ 16 C	M3.1 ■ 10 D	M3.2 ■ 9 D	M3.3 ■ 8 D	M4.1 ■ 10 B	N1.1 ■ 33 E	N1.2 ■ 25 E	N1.3 ■ 17 E	N2.1 ■ 46 D	N2.2 ■ 42 D	N2.3 ■ 30 D	N3.1 ■ 56 D	N3.2 ■ 33 E
N3.3 ■ 17 D	N4.1 ■ 30 F	N4.2 ■ 35 E	N4.3 ■ 17 D	S1.1 ■ 27 C	S1.2 ■ 12 B	S1.3 ■ 7 A	S2.1 ■ 11 C	S2.2 ■ 6 A	S3.1 ■ 8 C	S3.2 ■ 4 A	S4.1 ■ 6 C	S4.2 ■ 3 A	

Tunnplåtsborr

Product	DC	DC	DC	LCF	OAL	DCON MS
	(inch)	(mm)	(inch)			
A1233/325	3/32	2.38	0.0937	14.0	43.0	2.38
A1232.55	–	2.50	0.0984	14.0	43.0	2.50
A1233.05	–	3.00	0.1181	16.0	46.0	3.00
A1231/85	1/8	3.18	0.1250	18.0	49.0	3.18
A1233.25	–	3.20	0.1260	18.0	49.0	3.20
A1233.35	–	3.30	0.1299	18.0	49.0	3.30
A1233.55	–	3.50	0.1378	18.0	52.0	3.50
A1233.75	–	3.70	0.1457	18.0	52.0	3.70
A1235/325	5/32	3.97	0.1563	18.0	55.0	3.97
A1234.05	–	4.00	0.1575	18.0	55.0	4.00
A1234.15	–	4.10	0.1614	18.0	55.0	4.10
A1234.25	–	4.20	0.1654	18.0	55.0	4.20
A1234.55	–	4.50	0.1772	18.0	58.0	4.50
A1233/165	3/16	4.76	0.1875	18.0	62.0	4.76
A1234.85	–	4.80	0.1890	18.0	62.0	4.80
A1234.95	–	4.90	0.1929	18.0	62.0	4.90
A1235.05	–	5.00	0.1969	18.0	62.0	5.00
A1235.55	–	5.50	0.2165	18.0	66.0	5.50
A1237/325	7/32	5.56	0.2188	18.0	66.0	5.56
A1236.05	–	6.00	0.2362	18.0	66.0	6.00
A1231/45	1/4	6.35	0.2500	19.0	70.0	6.35

A120



Extra kort borr av HSS, ånganlöpt

Vårt populära extrakorta borr med ånganlöpning. Borrarna är användbara i de flesta material och är lättskarande vilket ger dem längre livlängd, samtidigt som de arbetar snabbare än konventionella borr.

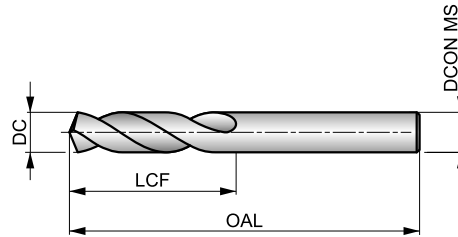

HSS	DIN 1897	2.5xD
135°	ST	
λ 20-35°	R	DC h8

Arbetsmaterialgrupper och startvärden för skärhastighet (m/min) och matningskod. Tabeller med matningar finns med början på sidan 274

P1.1 ■ 36 J	P1.2 ■ 40 J	P1.3 ■ 41 J	P2.1 ■ 31 J	P2.2 ■ 27 G	P2.3 ■ 24 F	P3.1 ■ 21 G	P3.2 ■ 17 G	P3.3 ■ 14 F	P4.1 ■ 12 G	P4.2 ■ 10 F	P4.3 ■ 9 E	M1.1 ■ 22 F	M1.2 ■ 19 F
M2.1 ■ 20 F	M2.2 ■ 16 F	M3.1 ■ 10 H	M3.2 ■ 9 H	M3.3 ■ 8 H	M4.1 ■ 10 D	K1.1 ■ 32 J	K1.2 ■ 24 G	K1.3 ■ 18 G	K2.1 ■ 25 F	K2.2 ■ 20 F	K2.3 ■ 16 F	K3.1 ■ 22 F	K3.2 ■ 17 F
K3.3 ■ 13 F	K4.1 ■ 20 F	K4.2 ■ 15 F	K4.3 ■ 11 F	K4.4 ■ 10 F	K4.5 ■ 8 F	K5.1 ■ 23 F	K5.2 ■ 17 F	K5.3 ■ 13 F	N1.1 ■ 33 K	N1.2 ■ 25 K	N1.3 ■ 17 J	N2.1 ■ 46 I	N2.2 ■ 42 I
N2.3 ■ 30 I	N3.1 ■ 64 I	N3.2 ■ 38 J	N3.3 ■ 19 H	N4.1 ■ 30 K	N4.2 ■ 35 I	N4.3 ■ 17 G	S1.1 ■ 27 G	S1.2 ■ 16 E	S1.3 ■ 8 C	S2.1 ■ 11 F	S2.2 ■ 6 B	S3.1 ■ 8 F	S3.2 ■ 4 B
S4.1 ■ 6 F	S4.2 ■ 3 B												

DC <= 1mm Blank; 2,9mm => DC >= 13,0mm 118° spetsvinkel.

Product	DC (inch)	DC (mm)	DC (inch)	LCF (mm)	OAL (mm)	DCON MS (mm)
A120.5	–	0.50	0.0197	3.0	20.0	0.50
A120.6	–	0.60	0.0236	3.5	21.0	0.60
A120.7	–	0.70	0.0276	4.5	23.0	0.70
A1201/32	1/32	0.79	0.0313	5.0	24.0	0.79
A120.8	–	0.80	0.0315	5.0	24.0	0.80
A120.9	–	0.90	0.0354	5.5	25.0	0.90
A1201.0	–	1.00	0.0394	6.0	26.0	1.00
A1201.1	–	1.10	0.0433	7.0	28.0	1.10
A1201.2	–	1.20	0.0472	8.0	30.0	1.20
A1201.3	–	1.30	0.0512	8.0	30.0	1.30
A1201.4	–	1.40	0.0551	9.0	32.0	1.40
A1201.5	–	1.50	0.0591	9.0	32.0	1.50
A1201/16	1/16	1.59	0.0625	10.0	34.0	1.59
A1201.6	–	1.60	0.0630	10.0	34.0	1.60
A1201.7	–	1.70	0.0669	10.0	34.0	1.70
A1201.8	–	1.80	0.0709	11.0	36.0	1.80
A1201.9	–	1.90	0.0748	11.0	36.0	1.90
A1205/64	5/64	1.98	0.0781	12.0	38.0	1.98
A1202.0	–	2.00	0.0787	12.0	38.0	2.00
A1202.1	–	2.10	0.0827	12.0	38.0	2.10
A1202.2	–	2.20	0.0866	13.0	40.0	2.20
A1202.25	–	2.25	0.0886	13.0	40.0	2.25
A1202.3	–	2.30	0.0906	13.0	40.0	2.30

Product	DC (inch)	DC (mm)	DC (inch)	LCF (mm)	OAL (mm)	DCON MS (mm)
A1203/32	3/32	2.38	0.0938	14.0	43.0	2.38
A1202.4	–	2.40	0.0945	14.0	43.0	2.40
A1202.5	–	2.50	0.0984	14.0	43.0	2.50
A1202.6	–	2.60	0.1024	14.0	43.0	2.60
A1202.7	–	2.70	0.1063	16.0	46.0	2.70
A1207/64	7/64	2.78	0.1094	16.0	46.0	2.78
A1202.8	–	2.80	0.1102	16.0	46.0	2.80
A1202.9	–	2.90	0.1142	16.0	46.0	2.90
A1203.0	–	3.00	0.1181	16.0	46.0	3.00
A1203.1	–	3.10	0.1220	18.0	49.0	3.10
A1201/8	1/8	3.18	0.1250	18.0	49.0	3.18
A1203.2	–	3.20	0.1260	18.0	49.0	3.20
A1203.25	–	3.25	0.1280	18.0	49.0	3.25
A1203.3	–	3.30	0.1299	18.0	49.0	3.30
A1203.4	–	3.40	0.1339	20.0	52.0	3.40
A1203.5	–	3.50	0.1378	20.0	52.0	3.50
A1209/64	9/64	3.57	0.1406	20.0	52.0	3.57
A1203.6	–	3.60	0.1417	20.0	52.0	3.60
A1203.7	–	3.70	0.1457	20.0	52.0	3.70
A1203.8	–	3.80	0.1496	22.0	55.0	3.80
A1203.9	–	3.90	0.1535	22.0	55.0	3.90
A1205/32	5/32	3.97	0.1563	22.0	55.0	3.97
A1204.0	–	4.00	0.1575	22.0	55.0	4.00

Product	DC	DC	DC	LCF	OAL	DCON MS
	(inch)	(mm)	(inch)	(mm)	(mm)	(mm)
A1204.1	–	4.10	0.1614	22.0	55.0	4.10
A1204.2	–	4.20	0.1654	22.0	55.0	4.20
A1204.3	–	4.30	0.1693	24.0	58.0	4.30
A12011/64	11/64	4.37	0.1719	24.0	58.0	4.37
A1204.4	–	4.40	0.1732	24.0	58.0	4.40
A1204.5	–	4.50	0.1772	24.0	58.0	4.50
A1204.6	–	4.60	0.1811	24.0	58.0	4.60
A1204.7	–	4.70	0.1850	24.0	58.0	4.70
A1203/16	3/16	4.76	0.1875	26.0	62.0	4.76
A1204.8	–	4.80	0.1890	26.0	62.0	4.80
A1204.9	–	4.90	0.1929	26.0	62.0	4.90
A1205.0	–	5.00	0.1969	26.0	62.0	5.00
A1205.1	–	5.10	0.2008	26.0	62.0	5.10
A12013/64	13/64	5.16	0.2031	26.0	62.0	5.16
A1205.2	–	5.20	0.2047	26.0	62.0	5.20
A1205.3	–	5.30	0.2087	26.0	62.0	5.30
A1205.4	–	5.40	0.2126	28.0	66.0	5.40
A1205.5	–	5.50	0.2165	28.0	66.0	5.50
A1207/32	7/32	5.56	0.2188	28.0	66.0	5.56
A1205.6	–	5.60	0.2205	28.0	66.0	5.60
A1205.7	–	5.70	0.2244	28.0	66.0	5.70
A1205.8	–	5.80	0.2283	28.0	66.0	5.80
A1205.9	–	5.90	0.2323	28.0	66.0	5.90
A12015/64	15/64	5.95	0.2344	28.0	66.0	5.95
A1206.0	–	6.00	0.2362	28.0	66.0	6.00
A1206.1	–	6.10	0.2402	31.0	70.0	6.10
A1206.2	–	6.20	0.2441	31.0	70.0	6.20
A1206.3	–	6.30	0.2480	31.0	70.0	6.30
A1201/4	1/4	6.35	0.2500	31.0	70.0	6.35
A1206.4	–	6.40	0.2520	31.0	70.0	6.40
A1206.5	–	6.50	0.2559	31.0	70.0	6.50
A1206.6	–	6.60	0.2598	31.0	70.0	6.60
A1206.7	–	6.70	0.2638	31.0	70.0	6.70
A1206.8	–	6.80	0.2677	34.0	74.0	6.80
A1206.9	–	6.90	0.2717	34.0	74.0	6.90
A1207.0	–	7.00	0.2756	34.0	74.0	7.00
A1207.1	–	7.10	0.2795	34.0	74.0	7.10
A1209/32	9/32	7.14	0.2813	34.0	74.0	7.14
A1207.2	–	7.20	0.2835	34.0	74.0	7.20
A1207.3	–	7.30	0.2874	34.0	74.0	7.30
A1207.4	–	7.40	0.2913	34.0	74.0	7.40
A1207.5	–	7.50	0.2953	34.0	74.0	7.50
A1207.6	–	7.60	0.2992	37.0	79.0	7.60
A1207.7	–	7.70	0.3031	37.0	79.0	7.70
A1207.8	–	7.80	0.3071	37.0	79.0	7.80
A1207.9	–	7.90	0.3110	37.0	79.0	7.90
A1205/16	5/16	7.94	0.3125	37.0	79.0	7.94
A1208.0	–	8.00	0.3150	37.0	79.0	8.00
A1208.1	–	8.10	0.3189	37.0	79.0	8.10
A1208.2	–	8.20	0.3228	37.0	79.0	8.20
A1208.3	–	8.30	0.3268	37.0	79.0	8.30
A1208.4	–	8.40	0.3307	37.0	79.0	8.40
A1208.5	–	8.50	0.3346	37.0	79.0	8.50
A1208.6	–	8.60	0.3386	40.0	84.0	8.60

Product	DC	DC	DC	LCF	OAL	DCON MS
	(inch)	(mm)	(inch)	(mm)	(mm)	(mm)
A1208.7	–	8.70	0.3425	40.0	84.0	8.70
A12011/32	11/32	8.73	0.3438	40.0	84.0	8.73
A1208.8	–	8.80	0.3465	40.0	84.0	8.80
A1208.9	–	8.90	0.3504	40.0	84.0	8.90
A1209.0	–	9.00	0.3543	40.0	84.0	9.00
A1209.1	–	9.10	0.3583	40.0	84.0	9.10
A1209.2	–	9.20	0.3622	40.0	84.0	9.20
A1209.3	–	9.30	0.3661	40.0	84.0	9.30
A1209.4	–	9.40	0.3701	40.0	84.0	9.40
A1209.5	–	9.50	0.3740	40.0	84.0	9.50
A1203/8	3/8	9.52	0.3750	43.0	89.0	9.52
A1209.6	–	9.60	0.3780	43.0	89.0	9.60
A1209.7	–	9.70	0.3819	43.0	89.0	9.70
A1209.8	–	9.80	0.3858	43.0	89.0	9.80
A1209.9	–	9.90	0.3898	43.0	89.0	9.90
A12010.0	–	10.00	0.3937	43.0	89.0	10.00
A12010.1	–	10.10	0.3976	43.0	89.0	10.10
A12010.2	–	10.20	0.4016	43.0	89.0	10.20
A12010.3	–	10.30	0.4055	43.0	89.0	10.30
A12010.5	–	10.50	0.4134	43.0	89.0	10.50
A12010.8	–	10.80	0.4252	47.0	95.0	10.80
A12011.0	–	11.00	0.4331	47.0	95.0	11.00
A1207/16	7/16	11.11	0.4375	47.0	95.0	11.11
A12011.3	–	11.30	0.4449	47.0	95.0	11.30
A12011.5	–	11.50	0.4528	47.0	95.0	11.50
A12011.7	–	11.70	0.4606	47.0	95.0	11.70
A12011.8	–	11.80	0.4646	47.0	95.0	11.80
A12012.0	–	12.00	0.4724	51.0	102.0	12.00
A12012.1	–	12.10	0.4764	51.0	102.0	12.10
A12012.2	–	12.20	0.4803	51.0	102.0	12.20
A12012.5	–	12.50	0.4921	51.0	102.0	12.50
A1201/2	1/2	12.70	0.5000	51.0	102.0	12.70
A12013.0	–	13.00	0.5118	51.0	102.0	13.00
A12013.5	–	13.50	0.5315	54.0	107.0	13.50
A12014.0	–	14.00	0.5512	54.0	107.0	14.00
A1209/16	9/16	14.29	0.5625	56.0	111.0	14.29
A12014.5	–	14.50	0.5709	56.0	111.0	14.50
A12015.0	–	15.00	0.5906	56.0	111.0	15.00
A12015.5	–	15.50	0.6102	58.0	115.0	15.50
A1205/8	5/8	15.88	0.6250	58.0	115.0	15.88
A12016.0	–	16.00	0.6299	58.0	115.0	16.00
A12016.5	–	16.50	0.6496	60.0	119.0	16.50
A12017.0	–	17.00	0.6693	60.0	119.0	17.00
A12011/16	11/16	17.46	0.6875	62.0	123.0	17.46
A12017.5	–	17.50	0.6890	62.0	123.0	17.50
A12018.0	–	18.00	0.7087	62.0	123.0	18.00
A12018.5	–	18.50	0.7283	64.0	127.0	18.50
A12019.0	–	19.00	0.7480	64.0	127.0	19.00
A12020.0	–	20.00	0.7874	66.0	131.0	20.00
A12020.5	–	20.50	0.8071	68.0	136.0	20.50
A12013/16	13/16	20.64	0.8125	68.0	136.0	20.64
A12021.0	–	21.00	0.8268	68.0	136.0	21.00
A12022.0	–	22.00	0.8661	70.0	141.0	22.00
A12025.0	–	25.00	0.9843	75.0	151.0	25.00

A022



Extra kort borr av HSS med TiN-belagd spets

Vårt populära extrakorta borr med TiN-belagd spets. Borrarna är användbara i de flesta material och är lättskärande, vilket ger dem längre livlängd, samtidigt som de arbetar snabbare än konventionella borr. Finns även i borsatsar.

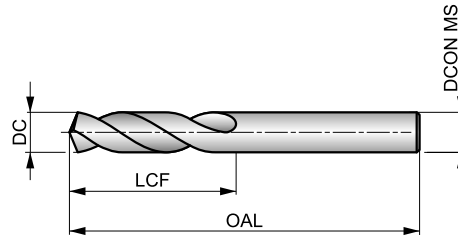

HSS	DIN ANSI	2.5xD
135°	TiN-Tip	
λ 20-35°	R	DC h8

Arbetsmaterialgrupper och startvärden för skärhastighet (m/min) och matningskod. Tabeller med matningar finns med början på sidan 274

P1.1 ■ 33 K	P1.2 ■ 37 K	P1.3 ■ 38 K	P2.1 ■ 28 K	P2.2 ■ 25 I	P2.3 ■ 22 G	P3.1 ■ 24 H	P3.2 ■ 19 H	P3.3 ■ 16 G	P4.1 ■ 14 H	P4.2 ■ 12 G	P4.3 ▣ 10 E	M1.1 ■ 21 G	M1.2 ■ 17 G
M2.1 ■ 18 G	M2.2 ■ 15 G	M3.1 ▣ 9 I	M3.2 ▣ 8 I	M3.3 ▣ 7 I	M4.1 ▣ 9 E	K1.1 ■ 32 K	K1.2 ■ 24 I	K1.3 ■ 18 I	K2.1 ■ 25 G	K2.2 ■ 20 G	K2.3 ▣ 16 G	K3.1 ■ 22 G	K3.2 ■ 17 G
K3.3 ▣ 13 G	K4.1 ■ 20 G	K4.2 ■ 15 G	K4.3 ▣ 11 G	K4.4 ▣ 10 G	K4.5 ▣ 8 G	K5.1 ■ 23 G	K5.2 ■ 17 G	K5.3 ▣ 13 G	N1.1 ■ 40 F	N1.2 ■ 30 F	N1.3 ■ 20 K	N2.1 ■ 49 J	N2.2 ■ 44 J
N2.3 ■ 32 J	N3.1 ▣ 64 I	N3.2 ▣ 38 K	N3.3 ▣ 19 H	N4.1 ▣ 30 K	N4.2 ▣ 35 I	N4.3 ▣ 17 G	S1.1 ■ 25 I	S1.2 ▣ 14 F	S1.3 ▣ 8 C	S2.1 ▣ 11 F	S2.2 ▣ 6 B	S3.1 ▣ 8 F	S3.2 ▣ 4 B
S4.1 ▣ 6 F	S4.2 ▣ 3 B												

DC < 2mm Blank; DC >= 2mm TiN-belagd korsspets.
Produkter från den här serien finns även i set. Se A088

Product	DC (inch)	DC (mm)	DC (inch)	LCF (mm)	OAL (mm)	DCON MS (mm)
A022.5	-	0.50	0.0197	3.0	20.0	0.50
A022.6	-	0.60	0.0236	3.5	21.0	0.60
A022.7	-	0.70	0.0276	4.5	23.0	0.70
A0221/32	1/32	0.79	0.0313	13.0	35.0	0.79
A022.8	-	0.80	0.0315	5.0	24.0	0.80
A022.9	-	0.90	0.0354	5.5	25.0	0.90
A0221.0	-	1.00	0.0394	6.0	26.0	1.00
A0221.1	-	1.10	0.0433	7.0	28.0	1.10
A0223/64	3/64	1.19	0.0469	13.0	35.0	1.19
A0221.2	-	1.20	0.0472	8.0	30.0	1.20
A0221.3	-	1.30	0.0512	8.0	30.0	1.30
A0221.4	-	1.40	0.0551	9.0	32.0	1.40
A0221.5	-	1.50	0.0591	9.0	32.0	1.50
A0221/16	1/16	1.59	0.0625	16.0	41.0	1.59
A0221.6	-	1.60	0.0630	10.0	34.0	1.60
A0221.7	-	1.70	0.0669	10.0	34.0	1.70
A0221.8	-	1.80	0.0709	11.0	36.0	1.80
A0221.9	-	1.90	0.0748	11.0	36.0	1.90
A0225/64	5/64	1.98	0.0781	17.0	43.0	1.98
A0222.0	-	2.00	0.0787	12.0	38.0	2.00
A0222.1	-	2.10	0.0827	12.0	38.0	2.10
A0222.2	-	2.20	0.0866	13.0	40.0	2.20

Product	DC (inch)	DC (mm)	DC (inch)	LCF (mm)	OAL (mm)	DCON MS (mm)
A0222.25	-	2.25	0.0886	13.0	40.0	2.25
A0222.3	-	2.30	0.0906	13.0	40.0	2.30
A0223/32	3/32	2.38	0.0938	20.0	45.0	2.38
A0222.4	-	2.40	0.0945	14.0	43.0	2.40
A0222.5	-	2.50	0.0984	14.0	43.0	2.50
A0222.6	-	2.60	0.1024	14.0	43.0	2.60
A0222.65	-	2.65	0.1043	14.0	43.0	2.65
A0222.7	-	2.70	0.1063	16.0	46.0	2.70
A0227/64	7/64	2.78	0.1094	22.0	47.0	2.78
A0222.8	-	2.80	0.1102	16.0	46.0	2.80
A0222.9	-	2.90	0.1142	16.0	46.0	2.90
A0223.0	-	3.00	0.1181	16.0	46.0	3.00
A0223.1	-	3.10	0.1220	18.0	49.0	3.10
A0221/8	1/8	3.18	0.1250	23.0	49.0	3.18
A0223.2	-	3.20	0.1260	18.0	49.0	3.20
A0223.25	-	3.25	0.1280	18.0	49.0	3.25
A0223.3	-	3.30	0.1299	18.0	49.0	3.30
A0223.4	-	3.40	0.1339	20.0	52.0	3.40
A0223.5	-	3.50	0.1378	20.0	52.0	3.50
A0229/64	9/64	3.57	0.1406	25.0	50.0	3.57
A0223.6	-	3.60	0.1417	20.0	52.0	3.60
A0223.7	-	3.70	0.1457	20.0	52.0	3.70

Product	DC	DC	DC	LCF	OAL	DCON MS
	(inch)	(mm)	(inch)	(mm)	(mm)	(mm)
A0223.8	–	3.80	0.1496	22.0	55.0	3.80
A0223.9	–	3.90	0.1535	22.0	55.0	3.90
A0225/32	5/32	3.97	0.1563	26.0	53.0	3.97
A0224.0	–	4.00	0.1575	22.0	55.0	4.00
A0224.1	–	4.10	0.1614	22.0	55.0	4.10
A0224.2	–	4.20	0.1654	22.0	55.0	4.20
A0224.3	–	4.30	0.1693	24.0	58.0	4.30
A02211/64	11/64	4.37	0.1719	28.0	55.0	4.37
A0224.4	–	4.40	0.1732	24.0	58.0	4.40
A0224.5	–	4.50	0.1772	24.0	58.0	4.50
A0224.6	–	4.60	0.1811	24.0	58.0	4.60
A0224.7	–	4.70	0.1850	24.0	58.0	4.70
A0223/16	3/16	4.76	0.1875	30.0	57.0	4.76
A0224.8	–	4.80	0.1890	26.0	62.0	4.80
A0224.9	–	4.90	0.1929	26.0	62.0	4.90
A0225.0	–	5.00	0.1969	26.0	62.0	5.00
A0225.1	–	5.10	0.2008	26.0	62.0	5.10
A02213/64	13/64	5.16	0.2031	31.0	58.0	5.16
A0225.2	–	5.20	0.2047	26.0	62.0	5.20
A0225.3	–	5.30	0.2087	26.0	62.0	5.30
A0225.4	–	5.40	0.2126	28.0	66.0	5.40
A0225.5	–	5.50	0.2165	28.0	66.0	5.50
A0227/32	7/32	5.56	0.2188	33.0	61.0	5.56
A0225.6	–	5.60	0.2205	28.0	66.0	5.60
A0225.7	–	5.70	0.2244	28.0	66.0	5.70
A0225.8	–	5.80	0.2283	28.0	66.0	5.80
A0225.9	–	5.90	0.2323	28.0	66.0	5.90
A02215/64	15/64	5.95	0.2344	34.0	63.0	5.95
A0226.0	–	6.00	0.2362	28.0	66.0	6.00
A0226.1	–	6.10	0.2402	31.0	70.0	6.10
A0226.2	–	6.20	0.2441	31.0	70.0	6.20
A0226.3	–	6.30	0.2480	31.0	70.0	6.30
A0221/4	1/4	6.35	0.2500	36.0	65.0	6.35
A0226.4	–	6.40	0.2520	31.0	70.0	6.40
A0226.5	–	6.50	0.2559	31.0	70.0	6.50
A0226.6	–	6.60	0.2598	31.0	70.0	6.60
A0226.7	–	6.70	0.2638	31.0	70.0	6.70
A0226.8	–	6.80	0.2677	34.0	74.0	6.80
A0226.9	–	6.90	0.2717	34.0	74.0	6.90
A0227.0	–	7.00	0.2756	34.0	74.0	7.00
A0227.1	–	7.10	0.2795	34.0	74.0	7.10
A0229/32	9/32	7.14	0.2813	40.0	70.0	7.14
A0227.2	–	7.20	0.2835	34.0	74.0	7.20
A0227.3	–	7.30	0.2874	34.0	74.0	7.30
A0227.4	–	7.40	0.2913	34.0	74.0	7.40
A0227.5	–	7.50	0.2953	34.0	74.0	7.50
A0227.6	–	7.60	0.2992	37.0	79.0	7.60
A0227.7	–	7.70	0.3031	37.0	79.0	7.70
A0227.8	–	7.80	0.3071	37.0	79.0	7.80
A0227.9	–	7.90	0.3110	37.0	79.0	7.90
A0225/16	5/16	7.94	0.3125	43.0	73.0	7.94
A0228.0	–	8.00	0.3150	37.0	79.0	8.00
A0228.1	–	8.10	0.3189	37.0	79.0	8.10

Product	DC	DC	DC	LCF	OAL	DCON MS
	(inch)	(mm)	(inch)	(mm)	(mm)	(mm)
A0228.2	–	8.20	0.3228	37.0	79.0	8.20
A0228.3	–	8.30	0.3268	37.0	79.0	8.30
A0228.4	–	8.40	0.3307	37.0	79.0	8.40
A0228.5	–	8.50	0.3346	37.0	79.0	8.50
A0228.6	–	8.60	0.3386	40.0	84.0	8.60
A0228.7	–	8.70	0.3425	40.0	84.0	8.70
A02211/32	11/32	8.73	0.3438	45.0	78.0	8.73
A0228.8	–	8.80	0.3465	40.0	84.0	8.80
A0228.9	–	8.90	0.3504	40.0	84.0	8.90
A0229.0	–	9.00	0.3543	40.0	84.0	9.00
A0229.1	–	9.10	0.3583	40.0	84.0	9.10
A0229.2	–	9.20	0.3622	40.0	84.0	9.20
A0229.3	–	9.30	0.3661	40.0	84.0	9.30
A0229.4	–	9.40	0.3701	40.0	84.0	9.40
A0229.5	–	9.50	0.3740	40.0	84.0	9.50
A0223/8	3/8	9.52	0.3750	48.0	81.0	9.52
A0229.6	–	9.60	0.3780	43.0	89.0	9.60
A0229.7	–	9.70	0.3819	43.0	89.0	9.70
A0229.8	–	9.80	0.3858	43.0	89.0	9.80
A0229.9	–	9.90	0.3898	43.0	89.0	9.90
A02210.0	–	10.00	0.3937	43.0	89.0	10.00
A02210.1	–	10.10	0.3976	43.0	89.0	10.10
A02210.2	–	10.20	0.4016	43.0	89.0	10.20
A02210.3	–	10.30	0.4055	43.0	89.0	10.30
A02213/32	13/32	10.32	0.4063	51.0	86.0	10.32
A02210.4	–	10.40	0.4094	43.0	89.0	10.40
A02210.5	–	10.50	0.4134	43.0	89.0	10.50
A02210.6	–	10.60	0.4173	43.0	89.0	10.60
A02210.8	–	10.80	0.4252	47.0	95.0	10.80
A02211.0	–	11.00	0.4331	47.0	95.0	11.00
A02211.1	–	11.10	0.4370	47.0	95.0	11.10
A0227/16	7/16	11.11	0.4375	54.0	89.0	11.11
A02211.2	–	11.20	0.4409	47.0	95.0	11.20
A02211.3	–	11.30	0.4449	47.0	95.0	11.30
A02211.5	–	11.50	0.4528	47.0	95.0	11.50
A02211.7	–	11.70	0.4606	47.0	95.0	11.70
A02211.8	–	11.80	0.4646	47.0	95.0	11.80
A02211.9	–	11.90	0.4685	51.0	102.0	11.90
A02212.0	–	12.00	0.4724	51.0	102.0	12.00
A02212.1	–	12.10	0.4764	51.0	102.0	12.10
A02212.2	–	12.20	0.4803	51.0	102.0	12.20
A02212.5	–	12.50	0.4921	51.0	102.0	12.50
A0221/2	1/2	12.70	0.5000	60.0	98.0	12.70
A02213.0	–	13.00	0.5118	51.0	102.0	13.00
A02213.5	–	13.50	0.5315	54.0	107.0	13.50
A02214.0	–	14.00	0.5512	54.0	107.0	14.00
A0229/16	9/16	14.29	0.5625	67.0	105.0	14.29
A02214.5	–	14.50	0.5709	56.0	111.0	14.50
A02215.0	–	15.00	0.5906	56.0	111.0	15.00
A02215.5	–	15.50	0.6102	58.0	115.0	15.50
A0225/8	5/8	15.88	0.6250	73.0	111.0	15.88
A02216.0	–	16.00	0.6299	58.0	115.0	16.00

Verktymsmaterial (BMC)	HSS	HSS	HSS	HSS	HSS	HSS	HSS	HSS						
Standard (BSG)	DORMER	DIN 338	DIN 338	DORMER	DIN 345	DIN 338	DIN 338	DIN 338						
Användbar längd (ULDR)	3.5xD	4xD	4xD	4xD	4xD	4xD	4xD	4xD						
Spetsvinkel	135°	118°	118°	118°	118°	118°	118°	118°						
Beläggning	ST Bronze	ST	ST	ST	ST	TIN-Tip	TIN-Tip	ST						
Skaft														
Spiralform		λ20-35°	λ20-35°	λ20-35°	λ20-35°	λ20-35°	λ20-35°	λ>35°						
Skärriktning	R	R	L	R	R	R	R	R						

NEW

Produktfamilj	A321	A100	A101	A170	A130	A002	A002S	A108						
PSF skärdiameter	3.0 - 13.0	0.20 - 20.00	1.00 - 12.00	13.00 - 1.1/4	3.00 - 2"	1.00 - 16.00	2.00 - 13.00	1.00 - 16.00						
	18	19	23	24	26	30	32	33						
P	P1	■	■	■	■	■	■	■						
	P2	■	■	■	■	■	■	■						
	P3	■	■	■	■	■	■	■						
	P4	■	■	■	■	■	■	■	■					
M	M1	■	■	■	■	■	■	■						
	M2	■	■	■	■	■	■	■						
	M3	■	■	■	■	■	■	■						
	M4	■	■	■	■	■	■	■						
K	K1	■	■	■	■	■	■	■						
	K2	■	■	■	■	■	■	■						
	K3	■	■	■	■	■	■	■						
	K4	■	■	■	■	■	■	■						
	K5	■	■	■	■	■	■	■						
N	N1	■	■	■	■	■	■	■						
	N2	■	■	■	■	■	■	■						
	N3	■	■	■	■	■	■	■						
	N4	■	■	■	■	■	■	■						
	N5	■	■	■	■	■	■	■						
S	S1	■	■	■	■	■	■	■						
	S2	■	■	■	■	■	■	■						
	S3	■	■	■	■	■	■	■						
	S4	■	■	■	■	■	■	■						
H	H1													
	H2													
	H3													
	H4													

A321



Medellångt HSS-borr, ång- och gulanlöpt

Kraftig design med tre plattor på skaftet, avsett för medeldjupa hål. I första hand avsett för användning i handhållna el-maskiner och pelarbormaskiner. Spännplattorna på skaftet förhindrar slirning i chucken. Den självcentrerande 135° korsspetsen minskar skärkraften och den ång- och gulanlöpta ytan bidrar till bättre smörjning.

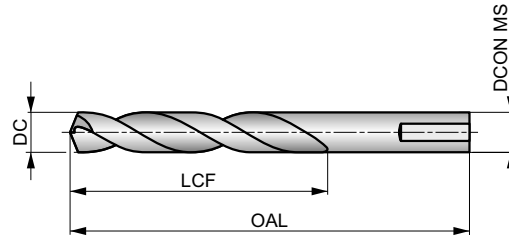

HSS	DORMER	3.5xD
135°	ST Bronze	
R	DC h8	

Arbetsmaterialgrupper och startvärden för skärhastighet (m/min) och matningskod. Tabeller med matningar finns med början på sidan 274

P1.1 ■ 33 H	P1.2 ■ 37 H	P1.3 ■ 38 H	P2.1 ■ 28 H	P2.2 ■ 25 F	P2.3 ■ 22 E	P3.1 ■ 19 F	P3.2 ■ 15 F	P3.3 ■ 13 E	P4.1 ■ 11 F	P4.2 ■ 10 E	P4.3 ■ 8 D	M1.1 ■ 21 E	M1.2 ■ 17 E
M2.1 ■ 18 E	M2.2 ■ 15 E	M3.1 ■ 9 G	M3.2 ■ 8 G	M3.3 ■ 7 G	M4.1 ■ 9 C	K1.1 ■ 30 H	K1.2 ■ 22 F	K1.3 ■ 17 F	K2.1 ■ 25 E	K2.2 ■ 20 E	K2.3 ■ 16 E	K3.1 ■ 22 E	K3.2 ■ 17 E
K3.3 ■ 13 E	K4.1 ■ 20 E	K4.2 ■ 15 E	K4.3 ■ 11 E	K4.4 ■ 10 E	K4.5 ■ 8 E	K5.1 ■ 23 E	K5.2 ■ 17 E	K5.3 ■ 13 E	N1.1 ■ 33 J	N1.2 ■ 25 J	N1.3 ■ 17 I	N2.1 ■ 42 H	N2.2 ■ 37 H
N2.3 ■ 27 H	N3.1 ■ 59 H	N3.2 ■ 35 I	N3.3 ■ 18 G	N4.1 ■ 30 J	N4.2 ■ 28 H	N4.3 ■ 14 F	S1.1 ■ 23 E	S1.2 ■ 12 D	S1.3 ■ 6 B	S2.1 ■ 8 E	S2.2 ■ 4 A	S3.1 ■ 6 E	S3.2 ■ 3 A
S4.1 ■ 5 E	S4.2 ■ 2 A												

Product	DC (mm)	DC (inch)	LCF (mm)	OAL (mm)	DCON MS (mm)
A3213.0	3.00	0.1180	37.0	64.0	3.00
A3213.3	3.30	0.1300	40.0	67.0	3.30
A3213.4	3.40	0.1340	40.0	67.0	3.40
A3213.5	3.50	0.1380	40.0	67.0	3.50
A3214.0	4.00	0.1580	47.0	74.0	4.00
A3214.1	4.10	0.1610	47.0	74.0	4.10
A3214.2	4.20	0.1650	47.0	74.0	4.20
A3214.3	4.30	0.1690	47.0	74.0	4.30
A3214.5	4.50	0.1770	49.0	77.0	4.50
A3214.9	4.90	0.1930	50.0	80.0	4.90
A3215.0	5.00	0.1970	50.0	80.0	5.00
A3215.1	5.10	0.2010	50.0	80.0	5.10
A3215.3	5.30	0.2090	52.0	84.0	5.30
A3215.5	5.50	0.2170	52.0	84.0	5.50
A3216.0	6.00	0.2360	52.0	90.0	6.00
A3216.3	6.30	0.2480	52.0	90.0	6.30
A3216.5	6.50	0.2560	55.0	93.0	6.50

Product	DC (mm)	DC (inch)	LCF (mm)	OAL (mm)	DCON MS (mm)
A3216.8	6.80	0.2680	59.0	97.0	6.80
A3217.0	7.00	0.2760	59.0	97.0	7.00
A3217.3	7.30	0.2870	62.0	100.0	7.30
A3217.5	7.50	0.2950	62.0	100.0	7.50
A3218.0	8.00	0.3150	67.0	105.0	8.00
A3218.5	8.50	0.3350	68.0	107.0	8.50
A3219.0	9.00	0.3540	70.0	108.0	9.00
A3219.5	9.50	0.3740	70.0	110.0	9.50
A32110.0	10.00	0.3940	74.0	113.0	10.00
A32110.3	10.30	0.4060	74.0	113.0	10.30
A32110.5	10.50	0.4130	75.0	115.0	10.50
A32111.0	11.00	0.4330	77.0	117.0	11.00
A32111.5	11.50	0.4530	79.0	120.0	11.50
A32112.0	12.00	0.4720	85.0	126.0	12.00
A32112.5	12.50	0.4920	88.0	130.0	12.50
A32113.0	13.00	0.5120	88.0	130.0	13.00

A100



Kort HSS-borr, ånganlöpt

Ett mycket användbart allround-borr med 118° konventionell spets, som är enkel att slipa om, vilket gör det kostnadseffektivt. Ånganlöpt. Användbart i de flesta material.

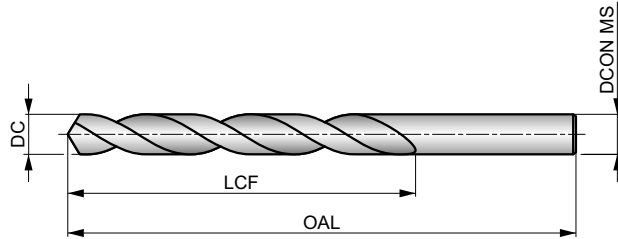

HSS	DIN 338	4×D
118°	ST	
λ20-35°	R	DC h8

Arbetsmaterialgrupper och startvärden för skärhastighet (m/min) och matningskod. Tabeller med matningar finns med början på sidan 274

P1.1 ■ 33 H	P1.2 ■ 37 H	P1.3 ■ 38 H	P2.1 ■ 28 H	P2.2 ■ 25 F	P2.3 ■ 22 E	P3.1 ■ 19 F	P3.2 ■ 15 F	P3.3 ■ 13 E	P4.1 ■ 11 F	P4.2 ■ 10 E	P4.3 ■ 8 D	M1.1 ■ 21 E	M1.2 ■ 17 E
M2.1 ■ 18 E	M2.2 ■ 15 E	M3.1 ■ 9 G	M3.2 ■ 8 G	M3.3 ■ 7 G	M4.1 ■ 9 C	K1.1 ■ 30 H	K1.2 ■ 22 F	K1.3 ■ 17 F	K2.1 ■ 25 E	K2.2 ■ 20 E	K2.3 ■ 16 E	K3.1 ■ 22 E	K3.2 ■ 17 E
K3.3 ■ 13 E	K4.1 ■ 20 E	K4.2 ■ 15 E	K4.3 ■ 11 E	K4.4 ■ 10 E	K4.5 ■ 8 E	K5.1 ■ 23 E	K5.2 ■ 17 E	K5.3 ■ 13 E	N1.1 ■ 33 J	N1.2 ■ 25 J	N1.3 ■ 17 I	N2.1 ■ 42 H	N2.2 ■ 37 H
N2.3 ■ 27 H	N3.1 ■ 59 H	N3.2 ■ 35 I	N3.3 ■ 18 G	N4.1 ■ 30 J	N4.2 ■ 28 H	N4.3 ■ 14 F	S1.1 ■ 23 E	S1.2 ■ 12 D	S1.3 ■ 6 B	S2.1 ■ 8 E	S2.2 ■ 4 A	S3.1 ■ 6 E	S3.2 ■ 3 A
S4.1 ■ 5 E	S4.2 ■ 2 A												

DC <= 1mm; 3/64"; N60. Blank.

Produkter från den här serien finns även i set. Se A190, A191, eller A199

Product	DC (inch)	DC (mm)	DC (inch)	LCF (mm)	OAL (mm)	DCON MS (mm)
A100.2	–	0.20	0.0079	2.5	19.0	0.20
A100.25	–	0.25	0.0098	3.0	19.0	0.25
A100.3	–	0.30	0.0118	3.0	19.0	0.30
A100.32	–	0.32	0.0126	4.0	19.0	0.32
A100N80	N80	0.34	0.0135	4.0	19.0	0.34
A100.35	–	0.35	0.0138	4.0	19.0	0.35
A100N79	N79	0.37	0.0145	4.0	19.0	0.37
A100.38	–	0.38	0.0150	4.0	19.0	0.38
A1001/64	1/64	0.40	0.0156	5.0	20.0	0.40
A100.4	–	0.40	0.0157	5.0	20.0	0.40
A100N78	N78	0.41	0.0160	5.0	20.0	0.41
A100.42	–	0.42	0.0165	5.0	20.0	0.42
A100.45	–	0.45	0.0177	5.0	20.0	0.45
A100N77	N77	0.46	0.0180	5.0	20.0	0.46
A100.48	–	0.48	0.0189	5.0	20.0	0.48
A100.5	–	0.50	0.0197	6.0	22.0	0.50
A100N76	N76	0.51	0.0200	6.0	22.0	0.51
A100.52	–	0.52	0.0205	6.0	22.0	0.52
A100N75	N75	0.53	0.0210	6.0	22.0	0.53
A100.55	–	0.55	0.0217	7.0	24.0	0.55
A100N74	N74	0.57	0.0225	7.0	24.0	0.57
A100.58	–	0.58	0.0228	7.0	24.0	0.58

Product	DC (inch)	DC (mm)	DC (inch)	LCF (mm)	OAL (mm)	DCON MS (mm)
A100.6	–	0.60	0.0236	7.0	24.0	0.60
A100N73	N73	0.61	0.0240	8.0	26.0	0.61
A100.62	–	0.62	0.0244	8.0	26.0	0.62
A100N72	N72	0.64	0.0250	8.0	26.0	0.64
A100.65	–	0.65	0.0256	8.0	26.0	0.65
A100N71	N71	0.66	0.0260	8.0	26.0	0.66
A100.68	–	0.68	0.0268	9.0	28.0	0.68
A100.7	–	0.70	0.0276	9.0	28.0	0.70
A100N70	N70	0.71	0.0280	9.0	28.0	0.71
A100.72	–	0.72	0.0283	9.0	28.0	0.72
A100N69	N69	0.74	0.0292	9.0	28.0	0.74
A100.75	–	0.75	0.0295	9.0	28.0	0.75
A100.78	–	0.78	0.0307	10.0	30.0	0.78
A1001/32	1/32	0.79	0.0313	10.0	30.0	0.79
A100N68	N68	0.79	0.0310	10.0	30.0	0.79
A100.8	–	0.80	0.0315	10.0	30.0	0.80
A100N67	N67	0.81	0.0320	10.0	30.0	0.81
A100.82	–	0.82	0.0323	10.0	30.0	0.82
A100N66	N66	0.84	0.0330	10.0	30.0	0.84
A100.85	–	0.85	0.0335	10.0	30.0	0.85
A100.88	–	0.88	0.0346	11.0	32.0	0.88
A100N65	N65	0.89	0.0350	11.0	32.0	0.89

Product	DC	DC	DC	LCF	OAL	DCON MS
	(inch)	(mm)	(inch)	(mm)	(mm)	(mm)
A100.9	–	0.90	0.0354	11.0	32.0	0.90
A100N64	N64	0.91	0.0360	11.0	32.0	0.91
A100.92	–	0.92	0.0362	11.0	32.0	0.92
A100N63	N63	0.94	0.0370	11.0	32.0	0.94
A100.95	–	0.95	0.0374	11.0	32.0	0.95
A100N62	N62	0.97	0.0380	12.0	34.0	0.97
A100.98	–	0.98	0.0386	12.0	34.0	0.98
A100N61	N61	0.99	0.0390	12.0	34.0	0.99
A1001.0	–	1.00	0.0394	12.0	34.0	1.00
A100N60	N60	1.02	0.0400	12.0	34.0	1.02
A100N59	N59	1.04	0.0410	12.0	34.0	1.04
A1001.05	–	1.05	0.0413	12.0	34.0	1.05
A100N58	N58	1.07	0.0420	14.0	36.0	1.07
A100N57	N57	1.09	0.0430	14.0	36.0	1.09
A1001.1	–	1.10	0.0433	14.0	36.0	1.10
A1001.15	–	1.15	0.0453	14.0	36.0	1.15
A100N56	N56	1.18	0.0465	14.0	36.0	1.18
A1003/64	3/64	1.19	0.0469	16.0	38.0	1.19
A1001.2	–	1.20	0.0472	16.0	38.0	1.20
A1001.25	–	1.25	0.0492	16.0	38.0	1.25
A1001.3	–	1.30	0.0512	16.0	38.0	1.30
A100N55	N55	1.32	0.0520	16.0	38.0	1.32
A1001.35	–	1.35	0.0531	18.0	40.0	1.35
A1001.4	–	1.40	0.0551	18.0	40.0	1.40
A100N54	N54	1.40	0.0550	18.0	40.0	1.40
A1001.45	–	1.45	0.0571	18.0	40.0	1.45
A1001.5	–	1.50	0.0591	18.0	40.0	1.50
A100N53	N53	1.51	0.0595	20.0	43.0	1.51
A1001.55	–	1.55	0.0610	20.0	43.0	1.55
A1001/16	1/16	1.59	0.0625	20.0	43.0	1.59
A1001.6	–	1.60	0.0630	20.0	43.0	1.60
A100N52	N52	1.61	0.0635	20.0	43.0	1.61
A1001.65	–	1.65	0.0650	20.0	43.0	1.65
A1001.7	–	1.70	0.0669	20.0	43.0	1.70
A100N51	N51	1.70	0.0670	22.0	46.0	1.70
A1001.75	–	1.75	0.0689	22.0	46.0	1.75
A100N50	N50	1.78	0.0700	22.0	46.0	1.78
A1001.8	–	1.80	0.0709	22.0	46.0	1.80
A1001.85	–	1.85	0.0728	22.0	46.0	1.85
A100N49	N49	1.85	0.0730	22.0	46.0	1.85
A1001.9	–	1.90	0.0748	22.0	46.0	1.90
A100N48	N48	1.93	0.0760	24.0	49.0	1.93
A1001.95	–	1.95	0.0768	24.0	49.0	1.95
A1005/64	5/64	1.98	0.0781	24.0	49.0	1.98
A100N47	N47	1.99	0.0785	24.0	49.0	1.99
A1002.0	–	2.00	0.0787	24.0	49.0	2.00
A1002.05	–	2.05	0.0807	24.0	49.0	2.05
A100N46	N46	2.06	0.0810	24.0	49.0	2.06
A100N45	N45	2.08	0.0820	24.0	49.0	2.08
A1002.1	–	2.10	0.0827	24.0	49.0	2.10
A1002.15	–	2.15	0.0846	27.0	53.0	2.15
A100N44	N44	2.18	0.0860	27.0	53.0	2.18
A1002.2	–	2.20	0.0866	27.0	53.0	2.20
A1002.25	–	2.25	0.0886	27.0	53.0	2.25
A100N43	N43	2.26	0.0890	27.0	53.0	2.26
A1002.3	–	2.30	0.0906	27.0	53.0	2.30
A1002.35	–	2.35	0.0925	27.0	53.0	2.35
A1003/32	3/32	2.38	0.0938	30.0	57.0	2.38
A100N42	N42	2.38	0.0935	30.0	57.0	2.38
A1002.4	–	2.40	0.0945	30.0	57.0	2.40
A100N41	N41	2.44	0.0960	30.0	57.0	2.44
A1002.45	–	2.45	0.0965	30.0	57.0	2.45

Product	DC	DC	DC	LCF	OAL	DCON MS
	(inch)	(mm)	(inch)	(mm)	(mm)	(mm)
A100N40	N40	2.49	0.0980	30.0	57.0	2.49
A1002.5	–	2.50	0.0984	30.0	57.0	2.50
A100N39	N39	2.53	0.0995	30.0	57.0	2.53
A1002.55	–	2.55	0.1004	30.0	57.0	2.55
A100N38	N38	2.58	0.1015	30.0	57.0	2.58
A1002.6	–	2.60	0.1024	30.0	57.0	2.60
A100N37	N37	2.64	0.1040	30.0	57.0	2.64
A1002.65	–	2.65	0.1043	30.0	57.0	2.65
A1002.7	–	2.70	0.1063	33.0	61.0	2.70
A100N36	N36	2.71	0.1065	33.0	61.0	2.71
A1002.75	–	2.75	0.1083	33.0	61.0	2.75
A1007/64	7/64	2.78	0.1094	33.0	61.0	2.78
A100N35	N35	2.79	0.1100	33.0	61.0	2.79
A1002.8	–	2.80	0.1102	33.0	61.0	2.80
A100N34	N34	2.82	0.1110	33.0	61.0	2.82
A1002.85	–	2.85	0.1122	33.0	61.0	2.85
A100N33	N33	2.87	0.1130	33.0	61.0	2.87
A1002.9	–	2.90	0.1142	33.0	61.0	2.90
A1002.95	–	2.95	0.1161	33.0	61.0	2.95
A100N32	N32	2.95	0.1160	33.0	61.0	2.95
A1003.0	–	3.00	0.1181	33.0	61.0	3.00
A100N31	N31	3.05	0.1200	36.0	65.0	3.05
A1003.1	–	3.10	0.1220	36.0	65.0	3.10
A1003.15	–	3.15	0.1240	36.0	65.0	3.15
A1001/8	1/8	3.18	0.1250	36.0	65.0	3.18
A1003.2	–	3.20	0.1260	36.0	65.0	3.20
A1003.25	–	3.25	0.1280	36.0	65.0	3.25
A100N30	N30	3.26	0.1285	36.0	65.0	3.26
A1003.3	–	3.30	0.1299	36.0	65.0	3.30
A1003.4	–	3.40	0.1339	39.0	70.0	3.40
A100N29	N29	3.45	0.1360	39.0	70.0	3.45
A1003.5	–	3.50	0.1378	39.0	70.0	3.50
A1009/64	9/64	3.57	0.1406	39.0	70.0	3.57
A100N28	N28	3.57	0.1405	39.0	70.0	3.57
A1003.6	–	3.60	0.1417	39.0	70.0	3.60
A100N27	N27	3.66	0.1440	39.0	70.0	3.66
A1003.7	–	3.70	0.1457	39.0	70.0	3.70
A100N26	N26	3.73	0.1470	39.0	70.0	3.73
A1003.75	–	3.75	0.1476	39.0	70.0	3.75
A1003.8	–	3.80	0.1496	43.0	75.0	3.80
A100N25	N25	3.80	0.1495	43.0	75.0	3.80
A100N24	N24	3.86	0.1520	43.0	75.0	3.86
A1003.9	–	3.90	0.1535	43.0	75.0	3.90
A100N23	N23	3.91	0.1540	43.0	75.0	3.91
A1005/32	5/32	3.97	0.1563	43.0	75.0	3.97
A100N22	N22	3.99	0.1570	43.0	75.0	3.99
A1004.0	–	4.00	0.1575	43.0	75.0	4.00
A100N21	N21	4.04	0.1590	43.0	75.0	4.04
A100N20	N20	4.09	0.1610	43.0	75.0	4.09
A1004.1	–	4.10	0.1614	43.0	75.0	4.10
A1004.2	–	4.20	0.1654	43.0	75.0	4.20
A100N19	N19	4.22	0.1660	43.0	75.0	4.22
A1004.25	–	4.25	0.1673	43.0	75.0	4.25
A1004.3	–	4.30	0.1693	47.0	80.0	4.30
A100N18	N18	4.31	0.1695	47.0	80.0	4.31
A10011/64	11/64	4.37	0.1719	47.0	80.0	4.37
A100N17	N17	4.39	0.1730	47.0	80.0	4.39
A1004.4	–	4.40	0.1732	47.0	80.0	4.40
A1004.5	–	4.50	0.1772	47.0	80.0	4.50
A100N16	N16	4.50	0.1770	47.0	80.0	4.50
A100N15	N15	4.57	0.1800	47.0	80.0	4.57
A1004.6	–	4.60	0.1811	47.0	80.0	4.60



Product	DC	DC	DC	LCF	OAL	D CON MS
	(inch)	(mm)	(inch)	(mm)	(mm)	(mm)
A100N14	N14	4.62	0.1820	47.0	80.0	4.62
A1004.7	–	4.70	0.1850	47.0	80.0	4.70
A100N13	N13	4.70	0.1850	47.0	80.0	4.70
A1004.75	–	4.75	0.1870	47.0	80.0	4.75
A1003/16	3/16	4.76	0.1875	52.0	86.0	4.76
A1004.8	–	4.80	0.1890	52.0	86.0	4.80
A100N12	N12	4.80	0.1890	52.0	86.0	4.80
A100N11	N11	4.85	0.1910	52.0	86.0	4.85
A1004.9	–	4.90	0.1929	52.0	86.0	4.90
A100N10	N10	4.92	0.1935	52.0	86.0	4.92
A100N9	N9	4.98	0.1960	52.0	86.0	4.98
A1005.0	–	5.00	0.1969	52.0	86.0	5.00
A100N8	N8	5.06	0.1990	52.0	86.0	5.06
A1005.1	–	5.10	0.2008	52.0	86.0	5.10
A100N7	N7	5.11	0.2010	52.0	86.0	5.11
A10013/64	13/64	5.16	0.2031	52.0	86.0	5.16
A100N6	N6	5.18	0.2040	52.0	86.0	5.18
A1005.2	–	5.20	0.2047	52.0	86.0	5.20
A100N5	N5	5.22	0.2055	52.0	86.0	5.22
A1005.25	–	5.25	0.2067	52.0	86.0	5.25
A1005.3	–	5.30	0.2087	52.0	86.0	5.30
A100N4	N4	5.31	0.2090	57.0	93.0	5.31
A1005.4	–	5.40	0.2126	57.0	93.0	5.40
A100N3	N3	5.41	0.2130	57.0	93.0	5.41
A1005.5	–	5.50	0.2165	57.0	93.0	5.50
A1007/32	7/32	5.56	0.2188	57.0	93.0	5.56
A1005.6	–	5.60	0.2205	57.0	93.0	5.60
A100N2	N2	5.61	0.2210	57.0	93.0	5.61
A1005.7	–	5.70	0.2244	57.0	93.0	5.70
A1005.75	–	5.75	0.2264	57.0	93.0	5.75
A100N1	1	5.79	0.2280	57.0	93.0	5.79
A1005.8	–	5.80	0.2283	57.0	93.0	5.80
A1005.9	–	5.90	0.2323	57.0	93.0	5.90
A100A	A	5.94	0.2340	57.0	93.0	5.94
A10015/64	15/64	5.95	0.2344	57.0	93.0	5.95
A1006.0	–	6.00	0.2362	57.0	93.0	6.00
A100B	B	6.03	0.2380	63.0	101.0	6.03
A1006.1	–	6.10	0.2402	63.0	101.0	6.10
A100C	C	6.15	0.2420	63.0	101.0	6.15
A1006.2	–	6.20	0.2441	63.0	101.0	6.20
A1006.25	–	6.25	0.2461	63.0	101.0	6.25
A100D	D	6.25	0.2460	63.0	101.0	6.25
A1006.3	–	6.30	0.2480	63.0	101.0	6.30
A1001/4	1/4	6.35	0.2500	63.0	101.0	6.35
A100E	E	6.35	0.2500	63.0	101.0	6.35
A1006.4	–	6.40	0.2520	63.0	101.0	6.40
A1006.5	–	6.50	0.2559	63.0	101.0	6.50
A100F	F	6.53	0.2570	63.0	101.0	6.53
A1006.6	–	6.60	0.2598	63.0	101.0	6.60
A100G	G	6.63	0.2610	63.0	101.0	6.63
A1006.7	–	6.70	0.2638	63.0	101.0	6.70
A10017/64	17/64	6.75	0.2656	69.0	109.0	6.75
A1006.75	–	6.75	0.2657	69.0	109.0	6.75
A100H	H	6.76	0.2660	69.0	109.0	6.76
A1006.8	–	6.80	0.2677	69.0	109.0	6.80
A1006.9	–	6.90	0.2717	69.0	109.0	6.90
A100I	I	6.91	0.2720	69.0	109.0	6.91
A1007.0	–	7.00	0.2756	69.0	109.0	7.00
A100J	J	7.04	0.2770	69.0	109.0	7.04
A1007.1	–	7.10	0.2795	69.0	109.0	7.10
A1009/32	9/32	7.14	0.2813	69.0	109.0	7.14
A1007.2	–	7.20	0.2835	69.0	109.0	7.20

Product	DC	DC	DC	LCF	OAL	D CON MS
	(inch)	(mm)	(inch)	(mm)	(mm)	(mm)
A1007.25	–	7.25	0.2854	69.0	109.0	7.25
A1007.3	–	7.30	0.2874	69.0	109.0	7.30
A100L	L	7.37	0.2900	69.0	109.0	7.37
A1007.4	–	7.40	0.2913	69.0	109.0	7.40
A1007.5	–	7.50	0.2953	69.0	109.0	7.50
A10019/64	19/64	7.54	0.2969	75.0	117.0	7.54
A1007.6	–	7.60	0.2992	75.0	117.0	7.60
A100N	N	7.67	0.3020	75.0	117.0	7.67
A1007.7	–	7.70	0.3031	75.0	117.0	7.70
A1007.75	–	7.75	0.3051	75.0	117.0	7.75
A1007.8	–	7.80	0.3071	75.0	117.0	7.80
A1007.9	–	7.90	0.3110	75.0	117.0	7.90
A1005/16	5/16	7.94	0.3125	75.0	117.0	7.94
A1008.0	–	8.00	0.3150	75.0	117.0	8.00
A1000	0	8.03	0.3160	75.0	117.0	8.03
A1008.1	–	8.10	0.3189	75.0	117.0	8.10
A1008.2	–	8.20	0.3228	75.0	117.0	8.20
A1008.25	–	8.25	0.3248	75.0	117.0	8.25
A1008.3	–	8.30	0.3268	75.0	117.0	8.30
A10021/64	21/64	8.33	0.3281	75.0	117.0	8.33
A1008.4	–	8.40	0.3307	75.0	117.0	8.40
A100Q	Q	8.43	0.3320	75.0	117.0	8.43
A1008.5	–	8.50	0.3346	75.0	117.0	8.50
A1008.6	–	8.60	0.3386	81.0	125.0	8.60
A1008.7	–	8.70	0.3425	81.0	125.0	8.70
A10011/32	11/32	8.73	0.3438	81.0	125.0	8.73
A1008.75	–	8.75	0.3445	81.0	125.0	8.75
A1008.8	–	8.80	0.3465	81.0	125.0	8.80
A1008.9	–	8.90	0.3504	81.0	125.0	8.90
A1009.0	–	9.00	0.3543	81.0	125.0	9.00
A1009.1	–	9.10	0.3583	81.0	125.0	9.10
A10023/64	23/64	9.13	0.3594	81.0	125.0	9.13
A1009.2	–	9.20	0.3622	81.0	125.0	9.20
A1009.25	–	9.25	0.3642	81.0	125.0	9.25
A1009.3	–	9.30	0.3661	81.0	125.0	9.30
A100U	U	9.35	0.3680	81.0	125.0	9.35
A1009.4	–	9.40	0.3701	81.0	125.0	9.40
A1009.5	–	9.50	0.3740	81.0	125.0	9.50
A1003/8	3/8	9.52	0.3750	87.0	133.0	9.52
A1009.6	–	9.60	0.3780	87.0	133.0	9.60
A1009.7	–	9.70	0.3819	87.0	133.0	9.70
A1009.75	–	9.75	0.3839	87.0	133.0	9.75
A1009.8	–	9.80	0.3858	87.0	133.0	9.80
A1009.9	–	9.90	0.3898	87.0	133.0	9.90
A10025/64	25/64	9.92	0.3906	87.0	133.0	9.92
A10010.0	–	10.00	0.3937	87.0	133.0	10.00
A10010.1	–	10.10	0.3976	87.0	133.0	10.10
A10010.2	–	10.20	0.4016	87.0	133.0	10.20
A10010.25	–	10.25	0.4035	87.0	133.0	10.25
A10010.3	–	10.30	0.4055	87.0	133.0	10.30
A10013/32	13/32	10.32	0.4063	87.0	133.0	10.32
A10010.4	–	10.40	0.4094	87.0	133.0	10.40
A10010.5	–	10.50	0.4134	87.0	133.0	10.50
A10010.6	–	10.60	0.4173	87.0	133.0	10.60
A10010.7	–	10.70	0.4213	94.0	142.0	10.70
A10027/64	27/64	10.72	0.4219	94.0	142.0	10.72
A10010.75	–	10.75	0.4232	94.0	142.0	10.75
A10010.8	–	10.80	0.4252	94.0	142.0	10.80
A10010.9	–	10.90	0.4291	94.0	142.0	10.90
A10011.0	–	11.00	0.4331	94.0	142.0	11.00
A10011.1	–	11.10	0.4370	94.0	142.0	11.10
A1007/16	7/16	11.11	0.4375	94.0	142.0	11.11



Product	DC	DC	DC	LCF	OAL	DCON MS
	(inch)	(mm)	(inch)	(mm)	(mm)	(mm)
A10011.2	–	11.20	0.4409	94.0	142.0	11.20
A10011.25	–	11.25	0.4429	94.0	142.0	11.25
A10011.3	–	11.30	0.4449	94.0	142.0	11.30
A10011.4	–	11.40	0.4488	94.0	142.0	11.40
A10011.5	–	11.50	0.4528	94.0	142.0	11.50
A10029/64	29/64	11.51	0.4531	94.0	142.0	11.51
A10011.6	–	11.60	0.4567	94.0	142.0	11.60
A10011.7	–	11.70	0.4606	94.0	142.0	11.70
A10011.75	–	11.75	0.4626	94.0	142.0	11.75
A10011.8	–	11.80	0.4646	94.0	142.0	11.80
A10011.9	–	11.90	0.4685	101.0	151.0	11.90
A10015/32	15/32	11.91	0.4688	101.0	151.0	11.91
A10012.0	–	12.00	0.4724	101.0	151.0	12.00
A10012.1	–	12.10	0.4764	101.0	151.0	12.10
A10012.2	–	12.20	0.4803	101.0	151.0	12.20
A10012.25	–	12.25	0.4823	101.0	151.0	12.25
A10012.3	–	12.30	0.4843	101.0	151.0	12.30
A10031/64	31/64	12.30	0.4844	101.0	151.0	12.30
A10012.4	–	12.40	0.4882	101.0	151.0	12.40
A10012.5	–	12.50	0.4921	101.0	151.0	12.50
A10012.6	–	12.60	0.4961	101.0	151.0	12.60
A10012.7	–	12.70	0.5000	101.0	151.0	12.70
A1001/2	1/2	12.70	0.5000	101.0	151.0	12.70
A10012.75	–	12.75	0.5020	101.0	151.0	12.75
A10012.8	–	12.80	0.5039	101.0	151.0	12.80
A10012.9	–	12.90	0.5079	101.0	151.0	12.90
A10013.0	–	13.00	0.5118	101.0	151.0	13.00
A10033/64	33/64	13.10	0.5156	101.0	151.0	13.10
A10013.1	–	13.10	0.5157	101.0	151.0	13.10
A10013.2	–	13.20	0.5197	101.0	151.0	13.20
A10013.25	–	13.25	0.5217	108.0	160.0	13.25
A10013.3	–	13.30	0.5236	108.0	160.0	13.30
A10013.4	–	13.40	0.5276	108.0	160.0	13.40

Product	DC	DC	DC	LCF	OAL	DCON MS
	(inch)	(mm)	(inch)	(mm)	(mm)	(mm)
A10017/32	17/32	13.49	0.5313	108.0	160.0	13.49
A10013.5	–	13.50	0.5315	108.0	160.0	13.50
A10013.6	–	13.60	0.5354	108.0	160.0	13.60
A10013.7	–	13.70	0.5394	108.0	160.0	13.70
A10013.75	–	13.75	0.5413	108.0	160.0	13.75
A10013.8	–	13.80	0.5433	108.0	160.0	13.80
A10035/64	35/64	13.89	0.5469	108.0	160.0	13.89
A10013.9	–	13.90	0.5472	108.0	160.0	13.90
A10014.0	–	14.00	0.5512	108.0	160.0	14.00
A10014.25	–	14.25	0.5610	114.0	169.0	14.25
A1009/16	9/16	14.29	0.5625	114.0	169.0	14.29
A10014.5	–	14.50	0.5709	114.0	169.0	14.50
A10037/64	37/64	14.68	0.5781	114.0	169.0	14.68
A10014.75	–	14.75	0.5807	114.0	169.0	14.75
A10015.0	–	15.00	0.5906	114.0	169.0	15.00
A10019/32	19/32	15.08	0.5938	120.0	178.0	15.08
A10015.25	–	15.25	0.6004	120.0	178.0	15.25
A10015.5	–	15.50	0.6102	120.0	178.0	15.50
A10015.75	–	15.75	0.6201	120.0	178.0	15.75
A1005/8	5/8	15.88	0.6250	120.0	178.0	15.88
A10016.0	–	16.00	0.6299	120.0	178.0	16.00
A10041/64	41/64	16.27	0.6406	125.0	184.0	16.27
A10016.5	–	16.50	0.6496	125.0	184.0	16.50
A10021/32	21/32	16.67	0.6563	125.0	184.0	16.67
A10017.0	–	17.00	0.6693	125.0	184.0	17.00
A10011/16	11/16	17.46	0.6875	130.0	191.0	17.46
A10017.5	–	17.50	0.6890	130.0	191.0	17.50
A10018.0	–	18.00	0.7087	130.0	191.0	18.00
A10018.5	–	18.50	0.7283	135.0	198.0	18.50
A10019.0	–	19.00	0.7480	135.0	198.0	19.00
A10019.5	–	19.50	0.7677	140.0	205.0	19.50
A10020.0	–	20.00	0.7874	140.0	205.0	20.00

A101



Kort HSS-borr, vänster, ånganlöpt

Ett mycket användbart allround-borr med 118° konventionell spets, som är enkel att slipa om, vilket gör det kostnadseffektivt. Ånganlöpt. Vänstergående. Användbart i de flesta material.

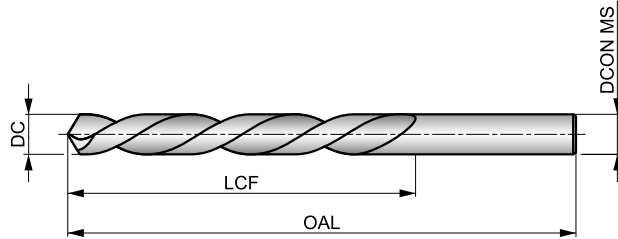

HSS	DIN 338	4×D
118°	ST	
λ 20-35°	L	DC h8

Arbetsmaterialgrupper och startvärden för skärhastighet (m/min) och matningskod. Tabeller med matningar finns med början på sidan 274

P1.1 ■ 33 H	P1.2 ■ 37 H	P1.3 ■ 38 H	P2.1 ■ 28 H	P2.2 ■ 25 F	P2.3 ■ 22 E	P3.1 ■ 19 F	P3.2 ■ 15 F	P3.3 ■ 13 E	P4.1 ■ 11 F	P4.2 ■ 10 E	P4.3 ■ 8 D	M1.1 ■ 21 E	M1.2 ■ 17 E
M2.1 ■ 18 E	M2.2 ■ 15 E	M3.1 ■ 9 G	M3.2 ■ 8 G	M3.3 ■ 7 G	M4.1 ■ 9 C	K1.1 ■ 30 H	K1.2 ■ 22 F	K1.3 ■ 17 F	K2.1 ■ 25 E	K2.2 ■ 20 E	K2.3 ■ 16 E	K3.1 ■ 22 E	K3.2 ■ 17 E
K3.3 ■ 13 E	K4.1 ■ 20 E	K4.2 ■ 15 E	K4.3 ■ 11 E	K4.4 ■ 10 E	K4.5 ■ 8 E	K5.1 ■ 23 E	K5.2 ■ 17 E	K5.3 ■ 13 E	N1.1 ■ 33 J	N1.2 ■ 25 J	N1.3 ■ 17 I	N2.1 ■ 42 H	N2.2 ■ 37 H
N2.3 ■ 27 H	N3.1 ■ 59 H	N3.2 ■ 35 I	N3.3 ■ 18 G	N4.1 ■ 30 J	N4.2 ■ 28 H	N4.3 ■ 14 F	S1.1 ■ 23 E	S1.2 ■ 12 D	S1.3 ■ 6 B	S2.1 ■ 8 E	S2.2 ■ 4 A	S3.1 ■ 6 E	S3.2 ■ 3 A
S4.1 ■ 5 E	S4.2 ■ 2 A												

DC <= 3mm Blank.

Product	DC (mm)	DC (inch)	LCF (mm)	OAL (mm)	DCON MS (mm)
A1011.0	1.00	0.0394	12.0	34.0	1.00
A1011.1	1.10	0.0433	14.0	36.0	1.10
A1011.2	1.20	0.0472	16.0	38.0	1.20
A1011.25	1.25	0.0492	16.0	38.0	1.25
A1011.3	1.30	0.0512	16.0	38.0	1.30
A1011.4	1.40	0.0551	18.0	40.0	1.40
A1011.5	1.50	0.0591	18.0	40.0	1.50
A1011.6	1.60	0.0630	20.0	43.0	1.60
A1011.7	1.70	0.0669	20.0	43.0	1.70
A1011.8	1.80	0.0709	22.0	46.0	1.80
A1011.9	1.90	0.0748	22.0	46.0	1.90
A1012.0	2.00	0.0787	24.0	49.0	2.00
A1012.1	2.10	0.0827	24.0	49.0	2.10
A1012.2	2.20	0.0866	27.0	53.0	2.20
A1012.4	2.40	0.0945	30.0	57.0	2.40
A1012.5	2.50	0.0984	30.0	57.0	2.50
A1012.6	2.60	0.1024	30.0	57.0	2.60
A1012.7	2.70	0.1063	33.0	61.0	2.70
A1012.8	2.80	0.1102	33.0	61.0	2.80
A1012.9	2.90	0.1142	33.0	61.0	2.90
A1013.0	3.00	0.1181	33.0	61.0	3.00
A1013.2	3.20	0.1260	36.0	65.0	3.20

Product	DC (mm)	DC (inch)	LCF (mm)	OAL (mm)	DCON MS (mm)
A1013.3	3.30	0.1299	36.0	65.0	3.30
A1013.5	3.50	0.1378	39.0	70.0	3.50
A1013.8	3.80	0.1496	43.0	75.0	3.80
A1014.0	4.00	0.1575	43.0	75.0	4.00
A1014.2	4.20	0.1654	43.0	75.0	4.20
A1014.5	4.50	0.1772	47.0	80.0	4.50
A1014.8	4.80	0.1890	52.0	86.0	4.80
A1015.0	5.00	0.1969	52.0	86.0	5.00
A1015.1	5.10	0.2008	52.0	86.0	5.10
A1015.2	5.20	0.2047	52.0	86.0	5.20
A1015.5	5.50	0.2165	57.0	93.0	5.50
A1016.0	6.00	0.2362	57.0	93.0	6.00
A1016.5	6.50	0.2559	63.0	101.0	6.50
A1017.0	7.00	0.2756	69.0	109.0	7.00
A1017.5	7.50	0.2953	69.0	109.0	7.50
A1018.0	8.00	0.3150	75.0	117.0	8.00
A1018.5	8.50	0.3346	75.0	117.0	8.50
A1019.0	9.00	0.3543	81.0	125.0	9.00
A10110.0	10.00	0.3937	87.0	133.0	10.00
A10111.0	11.00	0.4331	94.0	142.0	11.00
A10112.0	12.00	0.4724	101.0	151.0	12.00

A170



HSS-borr med nedsvartat skaft, ånganlöpt

Allsidigt HSS-borr med 1/2" skaft för alla diametrar som gör det möjligt att spänna fast i handhållna bormaskiner. Normal spets som är enkel att slipa om. Ånganlöpt

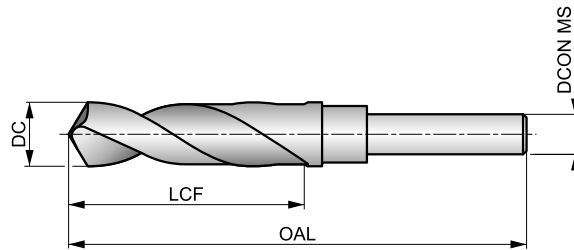

HSS	DORMER	4xD
118°	ST	
λ 20-35°	R	DC h8

Arbetsmaterialgrupper och startvärden för skärhastighet (m/min) och matningskod. Tabeller med matningar finns med början på sidan 274

P1.1 ■ 33 H	P1.2 ■ 37 H	P1.3 ■ 38 H	P2.1 ■ 28 H	P2.2 ■ 25 F	P2.3 ■ 22 D	P3.1 ■ 19 E	P3.2 ■ 15 E	P3.3 ■ 13 D	P4.1 ■ 11 E	P4.2 ■ 10 D	P4.3 ■ 8 C	M1.1 ■ 21 D	M1.2 ■ 17 D
M2.1 ■ 18 D	M2.2 ■ 15 D	M3.1 ■ 8 F	M3.2 ■ 7 F	M3.3 ■ 6 F	M4.1 ■ 7 B	K1.1 ■ 27 H	K1.2 ■ 20 E	K1.3 ■ 15 E	K2.1 ■ 23 D	K2.2 ■ 19 D	K2.3 ■ 15 D	K3.1 ■ 21 D	K3.2 ■ 16 D
K3.3 ■ 13 D	K4.1 ■ 19 D	K4.2 ■ 14 D	K4.3 ■ 11 D	K4.4 ■ 9 D	K4.5 ■ 8 D	K5.1 ■ 22 D	K5.2 ■ 16 D	K5.3 ■ 13 D	N1.1 ■ 33 I	N1.2 ■ 25 I	N1.3 ■ 17 H	N2.1 ■ 42 G	N2.2 ■ 37 G
N2.3 ■ 27 G	N3.1 ■ 56 G	N3.2 ■ 33 H	N3.3 ■ 17 F	N4.1 ■ 30 I	N4.2 ■ 28 G	N4.3 ■ 14 E	S1.1 ■ 17 E	S1.2 ■ 9 C	S1.3 ■ 5 A	S2.1 ■ 5 D	S2.2 ■ 4 A	S3.1 ■ 4 D	S3.2 ■ 3 A
S4.1 ■ 3 D	S4.2 ■ 2 A												

Product	DC	DC	DC	LCF	OAL	LCF	OAL	DCON MS
	(inch)	(mm)	(inch)	(inch)	(inch)	(mm)	(mm)	(mm)
A17013.0	–	13.00	0.5118	–	–	83.0	156.0	12.70
A17033/64	33/64	13.10	0.5156	3.1/8	6"	79.4	152.4	12.70
A17017/32	17/32	13.49	0.5313	3.1/8	6"	79.4	152.4	12.70
A17013.5	–	13.50	0.5315	–	–	83.0	156.0	12.70
A17035/64	35/64	13.89	0.5469	3.1/8	6"	79.4	152.4	12.70
A17014.0	–	14.00	0.5512	–	–	83.0	156.0	12.70
A1709/16	9/16	14.29	0.5625	3.1/8	6"	79.4	152.4	12.70
A17014.5	–	14.50	0.5709	–	–	83.0	156.0	12.70
A17037/64	37/64	14.68	0.5781	3.1/8	6"	79.4	152.4	12.70
A17015.0	–	15.00	0.5906	–	–	83.0	156.0	12.70
A17019/32	19/32	15.08	0.5938	3.1/8	6"	79.4	152.4	12.70
A17039/64	39/64	15.48	0.6094	3.1/8	6"	79.4	152.4	12.70
A17015.5	–	15.50	0.6102	–	–	83.0	156.0	12.70
A1705/8	5/8	15.88	0.6250	3.1/8	6"	79.4	152.4	12.70
A17016.0	–	16.00	0.6299	–	–	84.0	157.0	12.70
A17041/64	41/64	16.27	0.6406	3.1/8	6"	79.4	152.4	12.70
A17016.5	–	16.50	0.6496	–	–	84.0	157.0	12.70
A17021/32	21/32	16.67	0.6563	3.1/8	6"	79.4	152.4	12.70
A17017.0	–	17.00	0.6693	–	–	84.0	157.0	12.70
A17043/64	43/64	17.07	0.6719	3.1/8	6"	79.4	152.4	12.70
A17011/16	11/16	17.46	0.6875	3.1/8	6"	79.4	152.4	12.70
A17017.5	–	17.50	0.6890	–	–	84.0	157.0	12.70
A17045/64	45/64	17.86	0.7031	3.1/8	6"	79.4	152.4	12.70
A17018.0	–	18.00	0.7087	–	–	84.0	157.0	12.70



Product	DC	DC	DC	LCF	OAL	LCF	OAL	DCON MS
	(inch)	(mm)	(inch)	(inch)	(inch)	(mm)	(mm)	(mm)
A17023/32	23/32	18.26	0.7188	3.1/8	6"	79.4	152.4	12.70
A17018.5	–	18.50	0.7283	–	–	84.0	157.0	12.70
A17047/64	47/64	18.65	0.7344	3.1/8	6"	79.4	152.4	12.70
A17019.0	–	19.00	0.7480	–	–	84.0	157.0	12.70
A1703/4	3/4	19.05	0.7500	3.1/8	6"	79.4	152.4	12.70
A17049/64	49/64	19.45	0.7656	3"	6"	76.2	152.4	12.70
A17019.5	–	19.50	0.7677	–	–	81.0	158.0	12.70
A17025/32	25/32	19.84	0.7813	3"	6"	76.2	152.4	12.70
A17020.0	–	20.00	0.7874	–	–	81.0	158.0	12.70
A17051/64	51/64	20.24	0.7969	3"	6"	76.2	152.4	12.70
A17013/16	13/16	20.64	0.8125	3"	6"	76.2	152.4	12.70
A17021.0	–	21.00	0.8268	–	–	82.0	158.0	12.70
A17053/64	53/64	21.03	0.8281	3"	6"	76.2	152.4	12.70
A17027/32	27/32	21.43	0.8437	3"	6"	76.2	152.4	12.70
A17055/64	55/64	21.83	0.8594	3"	6"	76.2	152.4	12.70
A17022.0	–	22.00	0.8661	–	–	82.0	158.0	12.70
A1707/8	7/8	22.22	0.8750	3"	6"	76.2	152.4	12.70
A17023.0	–	23.00	0.9055	–	–	82.0	158.0	12.70
A17029/32	29/32	23.02	0.9063	3"	6"	76.2	152.4	12.70
A17059/64	59/64	23.42	0.9219	3"	6"	76.2	152.4	12.70
A17015/16	15/16	23.81	0.9375	3"	6"	76.2	152.4	12.70
A17024.0	–	24.00	0.9449	–	–	83.0	159.0	12.70
A17031/32	31/32	24.61	0.9688	3"	6"	76.2	152.4	12.70
A17025.0	–	25.00	0.9843	–	–	83.0	159.0	12.70
A1701	1"	25.40	1.0000	3"	6"	76.2	152.4	12.70
A1701.1/32	1.1/32	26.19	1.0313	3"	6"	76.2	152.4	12.70
A1701.1/16	1.1/16	26.99	1.0625	3"	6"	76.2	152.4	12.70
A1701.1/8	1.1/8	28.58	1.1250	3"	6"	76.2	152.4	12.70
A1701.3/16	1.3/16	30.16	1.1875	3"	6"	76.2	152.4	12.70
A1701.1/4	1.1/4	31.75	1.2500	3"	6"	76.2	152.4	12.70

A130



Morse-konborr av HSS, ånganlöpt

Ett mycket användbart allround-borr med 118° konventionell spets, som är enkel att slipa om, vilket gör det kostnadseffektivt. Finns från 3,0 mm tom 50,8 mm. Ånganlöpt. Användbart i de flesta material.

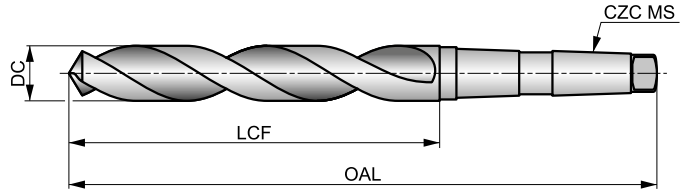

HSS	DIN 345	4xD
118°	ST	
λ 20-35°	R	DC h8

Arbetsmaterialgrupper och startvärden för skärhastighet (m/min) och matningskod. Tabeller med matningar finns med början på sidan 274

P1.1 ■ 33 I	P1.2 ■ 37 I	P1.3 ■ 38 I	P2.1 ■ 28 I	P2.2 ■ 25 F	P2.3 ■ 22 E	P3.1 ■ 18 F	P3.2 ■ 14 F	P3.3 ■ 12 E	P4.1 ■ 11 F	P4.2 ■ 9 E	P4.3 ■ 7 D	M1.1 ■ 21 E	M1.2 ■ 17 E
M2.1 ■ 18 E	M2.2 ■ 15 E	M3.1 ■ 10 G	M3.2 ■ 9 G	M3.3 ■ 8 G	M4.1 ■ 10 C	K1.1 ■ 30 I	K1.2 ■ 22 E	K1.3 ■ 17 E	K2.1 ■ 25 E	K2.2 ■ 20 E	K2.3 ■ 16 E	K3.1 ■ 22 E	K3.2 ■ 17 E
K3.3 ■ 13 E	K4.1 ■ 20 E	K4.2 ■ 15 E	K4.3 ■ 11 E	K4.4 ■ 10 E	K4.5 ■ 8 E	K5.1 ■ 23 E	K5.2 ■ 17 E	K5.3 ■ 13 E	N1.1 ■ 26 J	N1.2 ■ 20 J	N1.3 ■ 13 I	N2.1 ■ 43 H	N2.2 ■ 39 H
N2.3 ■ 28 H	N3.1 ■ 59 H	N3.2 ■ 35 I	N3.3 ■ 18 F	N4.1 ■ 30 K	N4.2 ■ 28 J	N4.3 ■ 14 H	S1.1 ■ 23 F	S1.2 ■ 13 D	S1.3 ■ 7 B	S2.1 ■ 9 E	S2.2 ■ 6 A	S3.1 ■ 7 E	S3.2 ■ 4 A
S4.1 ■ 5 E	S4.2 ■ 3 A												

DC > 14mm Urtunnad kärna.

Product	DC (inch)	DC (mm)	DC (inch)	LCF (mm)	OAL (mm)	CZC MS
A1303.0	–	3.00	0.1181	33.0	114.0	MK 1
A1301/8	1/8	3.18	0.1250	36.0	117.0	MK 1
A1303.3	–	3.30	0.1299	36.0	117.0	MK 1
A1303.5	–	3.50	0.1378	39.0	120.0	MK 1
A1304.0	–	4.00	0.1575	43.0	124.0	MK 1
A1304.2	–	4.20	0.1654	43.0	124.0	MK 1
A1304.25	–	4.25	0.1673	43.0	124.0	MK 1
A1304.5	–	4.50	0.1772	47.0	128.0	MK 1
A1303/16	3/16	4.76	0.1875	52.0	133.0	MK 1
A1305.0	–	5.00	0.1969	52.0	133.0	MK 1
A1305.1	–	5.10	0.2008	52.0	133.0	MK 1
A13013/64	13/64	5.16	0.2031	52.0	133.0	MK 1
A1305.2	–	5.20	0.2047	52.0	133.0	MK 1
A1305.5	–	5.50	0.2165	57.0	138.0	MK 1
A1306.0	–	6.00	0.2362	57.0	138.0	MK 1
A1301/4	1/4	6.35	0.2500	63.0	144.0	MK 1
A1306.5	–	6.50	0.2559	63.0	144.0	MK 1
A1306.7	–	6.70	0.2638	63.0	144.0	MK 1
A13017/64	17/64	6.75	0.2656	69.0	150.0	MK 1
A1306.75	–	6.75	0.2657	69.0	150.0	MK 1
A1306.8	–	6.80	0.2677	69.0	150.0	MK 1
A1307.0	–	7.00	0.2756	69.0	150.0	MK 1
A1309/32	9/32	7.14	0.2813	69.0	150.0	MK 1

Product	DC	DC	DC	LCF	OAL	CZC MS
	(inch)	(mm)	(inch)	(mm)	(mm)	
A1307.5	–	7.50	0.2953	69.0	150.0	MK 1
A1305/16	5/16	7.94	0.3125	75.0	156.0	MK 1
A1308.0	–	8.00	0.3150	75.0	156.0	MK 1
A1308.2	–	8.20	0.3228	75.0	156.0	MK 1
A1308.5	–	8.50	0.3346	75.0	156.0	MK 1
A1308.6	–	8.60	0.3386	81.0	162.0	MK 1
A1308.7	–	8.70	0.3425	81.0	162.0	MK 1
A13011/32	11/32	8.73	0.3438	81.0	162.0	MK 1
A1308.75	–	8.75	0.3445	81.0	162.0	MK 1
A1309.0	–	9.00	0.3543	81.0	162.0	MK 1
A1309.5	–	9.50	0.3740	81.0	162.0	MK 1
A1303/8	3/8	9.52	0.3750	87.0	168.0	MK 1
A13010.0	–	10.00	0.3937	87.0	168.0	MK 1
A13010.2	–	10.20	0.4016	87.0	168.0	MK 1
A13010.25	–	10.25	0.4035	87.0	168.0	MK 1
A13010.3	–	10.30	0.4055	87.0	168.0	MK 1
A13013/32	13/32	10.32	0.4063	87.0	168.0	MK 1
A13010.5	–	10.50	0.4134	87.0	168.0	MK 1
A13027/64	27/64	10.72	0.4219	94.0	175.0	MK 1
A13010.75	–	10.75	0.4232	94.0	175.0	MK 1
A13010.8	–	10.80	0.4252	94.0	175.0	MK 1
A13011.0	–	11.00	0.4331	94.0	175.0	MK 1
A1307/16	7/16	11.11	0.4375	94.0	175.0	MK 1
A13011.2	–	11.20	0.4409	94.0	175.0	MK 1
A13011.5	–	11.50	0.4528	94.0	175.0	MK 1
A13011.75	–	11.75	0.4626	94.0	175.0	MK 1
A13011.8	–	11.80	0.4646	94.0	175.0	MK 1
A13012.0	–	12.00	0.4724	101.0	182.0	MK 1
A13012.2	–	12.20	0.4803	101.0	182.0	MK 1
A13012.25	–	12.25	0.4823	101.0	182.0	MK 1
A13031/64	31/64	12.30	0.4844	101.0	182.0	MK 1
A13012.5	–	12.50	0.4921	101.0	182.0	MK 1
A13012.7	–	12.70	0.5000	101.0	182.0	MK 1
A1301/2	1/2	12.70	0.5000	101.0	182.0	MK 1
A13012.75	–	12.75	0.5020	101.0	182.0	MK 1
A13012.8	–	12.80	0.5039	101.0	182.0	MK 1
A13013.0	–	13.00	0.5118	101.0	182.0	MK 1
A13033/64	33/64	13.10	0.5156	101.0	182.0	MK 1
A13013.2	–	13.20	0.5197	101.0	182.0	MK 1
A13013.25	–	13.25	0.5217	108.0	189.0	MK 1
A13017/32	17/32	13.49	0.5313	108.0	189.0	MK 1
A13013.5	–	13.50	0.5315	108.0	189.0	MK 1
A13013.75	–	13.75	0.5413	108.0	189.0	MK 1
A13013.8	–	13.80	0.5433	108.0	189.0	MK 1
A13013.9	–	13.90	0.5472	108.0	189.0	MK 1
A13014.0	–	14.00	0.5512	108.0	189.0	MK 1
A13014.1	–	14.10	0.5551	114.0	212.0	MK 2
A13014.2	–	14.20	0.5591	114.0	212.0	MK 2
A13014.25	–	14.25	0.5610	114.0	212.0	MK 2
A1309/16	9/16	14.29	0.5625	114.0	212.0	MK 2
A13014.3	–	14.30	0.5630	114.0	212.0	MK 2
A13014.5	–	14.50	0.5709	114.0	212.0	MK 2
A13037/64	37/64	14.68	0.5781	114.0	212.0	MK 2
A13014.75	–	14.75	0.5807	114.0	212.0	MK 2
A13014.8	–	14.80	0.5827	114.0	212.0	MK 2
A13014.9	–	14.90	0.5866	114.0	212.0	MK 2
A13015.0	–	15.00	0.5906	114.0	212.0	MK 2
A13015.1	–	15.10	0.5945	120.0	218.0	MK 2
A13015.2	–	15.20	0.5984	120.0	218.0	MK 2
A13015.25	–	15.25	0.6004	120.0	218.0	MK 2
A13039/64	39/64	15.48	0.6094	120.0	218.0	MK 2
A13015.5	–	15.50	0.6102	120.0	218.0	MK 2

Product	DC	DC	DC	LCF	OAL	CZC MS
	(inch)	(mm)	(inch)	(mm)	(mm)	
A13015.7	–	15.70	0.6181	120.0	218.0	MK 2
A13015.75	–	15.75	0.6201	120.0	218.0	MK 2
A13015.8	–	15.80	0.6220	120.0	218.0	MK 2
A1305/8	5/8	15.88	0.6250	120.0	218.0	MK 2
A13015.9	–	15.90	0.6260	120.0	218.0	MK 2
A13016.0	–	16.00	0.6299	120.0	218.0	MK 2
A13016.1	–	16.10	0.6339	125.0	223.0	MK 2
A13016.2	–	16.20	0.6378	125.0	223.0	MK 2
A13016.25	–	16.25	0.6398	125.0	223.0	MK 2
A13041/64	41/64	16.27	0.6406	125.0	223.0	MK 2
A13016.5	–	16.50	0.6496	125.0	223.0	MK 2
A13021/32	21/32	16.67	0.6563	125.0	223.0	MK 2
A13016.75	–	16.75	0.6594	125.0	223.0	MK 2
A13017.0	–	17.00	0.6693	125.0	223.0	MK 2
A13043/64	43/64	17.07	0.6719	130.0	228.0	MK 2
A13017.25	–	17.25	0.6791	130.0	228.0	MK 2
A13011/16	11/16	17.46	0.6875	130.0	228.0	MK 2
A13017.5	–	17.50	0.6890	130.0	228.0	MK 2
A13017.75	–	17.75	0.6988	130.0	228.0	MK 2
A13045/64	45/64	17.86	0.7031	130.0	228.0	MK 2
A13018.0	–	18.00	0.7087	130.0	228.0	MK 2
A13018.25	–	18.25	0.7185	135.0	233.0	MK 2
A13023/32	23/32	18.26	0.7188	135.0	233.0	MK 2
A13018.5	–	18.50	0.7283	135.0	233.0	MK 2
A13047/64	47/64	18.65	0.7344	135.0	233.0	MK 2
A13018.75	–	18.75	0.7382	135.0	233.0	MK 2
A13019.0	–	19.00	0.7480	135.0	233.0	MK 2
A1303/4	3/4	19.05	0.7500	140.0	238.0	MK 2
A13019.25	–	19.25	0.7579	140.0	238.0	MK 2
A13019.5	–	19.50	0.7677	140.0	238.0	MK 2
A13019.75	–	19.75	0.7776	140.0	238.0	MK 2
A13025/32	25/32	19.84	0.7813	140.0	238.0	MK 2
A13020.0	–	20.00	0.7874	140.0	238.0	MK 2
A13020.25	–	20.25	0.7972	145.0	243.0	MK 2
A13020.5	–	20.50	0.8071	145.0	243.0	MK 2
A13013/16	13/16	20.64	0.8125	145.0	243.0	MK 2
A13020.75	–	20.75	0.8169	145.0	243.0	MK 2
A13021.0	–	21.00	0.8268	145.0	243.0	MK 2
A13021.25	–	21.25	0.8366	150.0	248.0	MK 2
A13021.5	–	21.50	0.8465	150.0	248.0	MK 2
A13021.75	–	21.75	0.8563	150.0	248.0	MK 2
A13022.0	–	22.00	0.8661	150.0	248.0	MK 2
A1307/8	7/8	22.22	0.8750	150.0	248.0	MK 2
A13022.25	–	22.25	0.8760	150.0	248.0	MK 2
A13022.5	–	22.50	0.8858	155.0	253.0	MK 2
A13057/64	57/64	22.62	0.8906	155.0	253.0	MK 2
A13022.75	–	22.75	0.8957	155.0	253.0	MK 2
A13023.0	–	23.00	0.9055	155.0	253.0	MK 2
A13029/32	29/32	23.02	0.9063	155.0	253.0	MK 2
A13023.25	–	23.25	0.9154	155.0	276.0	MK 3
A13023.5	–	23.50	0.9252	155.0	276.0	MK 3
A13023.75	–	23.75	0.9350	160.0	281.0	MK 3
A13015/16	15/16	23.81	0.9375	160.0	281.0	MK 3
A13024.0	–	24.00	0.9449	160.0	281.0	MK 3
A13061/64	61/64	24.21	0.9531	160.0	281.0	MK 3
A13024.5	–	24.50	0.9646	160.0	281.0	MK 3
A13024.75	–	24.75	0.9744	160.0	281.0	MK 3
A13025.0	–	25.00	0.9843	160.0	281.0	MK 3
A13025.25	–	25.25	0.9941	165.0	286.0	MK 3
A1301	1"	25.40	1.0000	165.0	286.0	MK 3
A13025.5	–	25.50	1.0039	165.0	286.0	MK 3
A13025.75	–	25.75	1.0138	165.0	286.0	MK 3

Product	DC	DC	DC	LCF	OAL	CZC MS
	(inch)	(mm)	(inch)	(mm)	(mm)	
A13026.0	–	26.00	1.0236	165.0	286.0	MK 3
A13026.25	–	26.25	1.0335	165.0	286.0	MK 3
A13026.5	–	26.50	1.0433	165.0	286.0	MK 3
A1301.1/16	1.1/16	26.99	1.0625	170.0	291.0	MK 3
A13027.0	–	27.00	1.0630	170.0	291.0	MK 3
A13027.5	–	27.50	1.0827	170.0	291.0	MK 3
A13028.0	–	28.00	1.1024	170.0	291.0	MK 3
A13028.5	–	28.50	1.1220	175.0	296.0	MK 3
A1301.1/8	1.1/8	28.58	1.1250	175.0	296.0	MK 3
A13029.0	–	29.00	1.1417	175.0	296.0	MK 3
A13029.5	–	29.50	1.1614	175.0	296.0	MK 3
A13030.0	–	30.00	1.1811	175.0	296.0	MK 3
A1301.3/16	1.3/16	30.16	1.1875	180.0	301.0	MK 3
A13030.5	–	30.50	1.2008	180.0	301.0	MK 3
A13031.0	–	31.00	1.2205	180.0	301.0	MK 3
A13031.5	–	31.50	1.2402	180.0	301.0	MK 3
A1301.1/4	1.1/4	31.75	1.2500	185.0	306.0	MK 3
A13032.0	–	32.00	1.2598	185.0	334.0	MK 4
A13032.5	–	32.50	1.2795	185.0	334.0	MK 4
A13033.0	–	33.00	1.2992	185.0	334.0	MK 4
A13033.5	–	33.50	1.3189	185.0	334.0	MK 4
A13034.0	–	34.00	1.3386	190.0	339.0	MK 4
A13034.5	–	34.50	1.3583	190.0	339.0	MK 4
A1301.3/8	1.3/8	34.93	1.3750	190.0	339.0	MK 4
A13035.0	–	35.00	1.3780	190.0	339.0	MK 4
A13035.5	–	35.50	1.3976	190.0	339.0	MK 4
A13036.0	–	36.00	1.4173	195.0	344.0	MK 4
A13037.0	–	37.00	1.4567	195.0	344.0	MK 4
A13037.5	–	37.50	1.4764	195.0	344.0	MK 4
A13038.0	–	38.00	1.4961	200.0	349.0	MK 4
A1301.1/2	1.1/2	38.10	1.5000	200.0	349.0	MK 4
A13038.5	–	38.50	1.5157	200.0	349.0	MK 4
A13039.0	–	39.00	1.5354	200.0	349.0	MK 4
A13039.5	–	39.50	1.5551	200.0	349.0	MK 4
A13040.0	–	40.00	1.5748	200.0	349.0	MK 4
A13041.0	–	41.00	1.6142	205.0	354.0	MK 4
A13042.0	–	42.00	1.6535	205.0	354.0	MK 4
A13043.0	–	43.00	1.6929	210.0	359.0	MK 4
A13044.0	–	44.00	1.7323	210.0	359.0	MK 4
A1301.3/4	1.3/4	44.45	1.7500	210.0	359.0	MK 4
A13045.0	–	45.00	1.7717	210.0	359.0	MK 4
A13046.0	–	46.00	1.8110	215.0	364.0	MK 4
A13048.0	–	48.00	1.8898	220.0	369.0	MK 4
A13049.0	–	49.00	1.9291	220.0	369.0	MK 4
A13050.0	–	50.00	1.9685	220.0	369.0	MK 4
A1302	2"	50.80	2.0000	225.0	374.0	MK 4

A002



Kort borr av HSS med TiN-belagd spets

Vårt populära standardborr med TiN-belagd spets. Borrarna är användbara i de flesta material och är lättskärande, vilket ger dem längre livlängd, samtidigt som de arbetar snabbare än konventionella borr. Finns även i olika borrarstorlekar och som 2-pack.

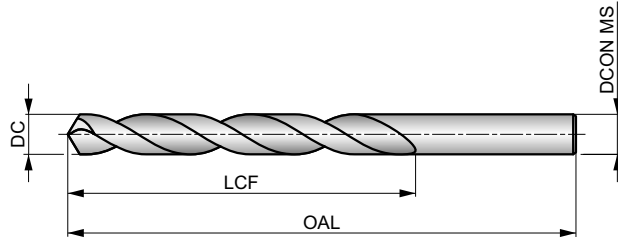

HSS	DIN 338	4×D
118°	TiN-Tip	
λ 20-35°	R	DC h8

Arbetsmaterialgrupper och startvärden för skärhastighet (m/min) och matningskod. Tabeller med matningar finns med början på sidan 274

P1.1 ■ 46 J	P1.2 ■ 52 J	P1.3 ■ 54 J	P2.1 ■ 40 J	P2.2 ■ 35 F	P2.3 ■ 31 F	P3.1 ■ 27 F	P3.2 ■ 21 F	P3.3 ■ 18 F	P4.1 ■ 16 F	P4.2 ■ 13 F	P4.3 ■ 11 E	M1.1 ■ 27 F	M1.2 ■ 23 F
M2.1 ■ 24 F	M2.2 ■ 20 F	M3.1 ■ 14 G	M3.2 ■ 12 G	M3.3 ■ 11 G	M4.1 ■ 16 C	K1.1 ■ 40 J	K1.2 ■ 30 E	K1.3 ■ 22 E	K2.1 ■ 34 E	K2.2 ■ 28 E	K2.3 ■ 22 E	K3.1 ■ 30 E	K3.2 ■ 23 E
K3.3 ■ 19 E	K4.1 ■ 28 E	K4.2 ■ 21 E	K4.3 ■ 16 E	K4.4 ■ 13 E	K4.5 ■ 11 E	K5.1 ■ 32 E	K5.2 ■ 24 E	K5.3 ■ 19 E	N1.1 ■ 41 K	N1.2 ■ 31 K	N1.3 ■ 21 J	N2.1 ■ 51 I	N2.2 ■ 46 I
N2.3 ■ 33 I	N3.1 ■ 56 H	N3.2 ■ 33 I	N3.3 ■ 17 G	N4.1 ■ 30 I	N4.2 ■ 50 H	N4.3 ■ 35 F	S1.1 ■ 23 F	S1.2 ■ 13 D	S1.3 ■ 7 B	S2.1 ■ 9 E	S2.2 ■ 4 A	S3.1 ■ 7 E	S3.2 ■ 3 A
S4.1 ■ 5 E	S4.2 ■ 2 A												

DC < 2mm Blank; DC >= 2mm TiN-belagd korsspets.
 Produkter från den här serien finns även i set. Se A087, A089, A094, A095 eller A099

Product	DC (inch)	DC (mm)	DC (inch)	LCF (mm)	OAL (mm)	DCON MS (mm)
A0021.0	–	1.00	0.0394	12.0	34.0	1.00
A0021.1	–	1.10	0.0433	14.0	36.0	1.10
A0023/64	3/64	1.19	0.0469	16.0	38.0	1.19
A0021.2	–	1.20	0.0472	16.0	38.0	1.20
A0021.3	–	1.30	0.0512	16.0	38.0	1.30
A0021.4	–	1.40	0.0551	18.0	40.0	1.40
A0021.5	–	1.50	0.0591	18.0	40.0	1.50
A0021/16	1/16	1.59	0.0625	20.0	43.0	1.59
A0021.6	–	1.60	0.0630	20.0	43.0	1.60
A0021.7	–	1.70	0.0669	20.0	43.0	1.70
A0021.8	–	1.80	0.0709	22.0	46.0	1.80
A0021.9	–	1.90	0.0748	22.0	46.0	1.90
A0025/64	5/64	1.98	0.0781	24.0	49.0	1.98
A0022.0	–	2.00	0.0787	24.0	49.0	2.00
A0022.1	–	2.10	0.0827	24.0	49.0	2.10
A0022.2	–	2.20	0.0866	27.0	53.0	2.20
A0022.3	–	2.30	0.0906	27.0	53.0	2.30
A0023/32	3/32	2.38	0.0938	30.0	57.0	2.38
A0022.4	–	2.40	0.0945	30.0	57.0	2.40
A0022.5	–	2.50	0.0984	30.0	57.0	2.50
A0022.6	–	2.60	0.1024	30.0	57.0	2.60
A0022.7	–	2.70	0.1063	33.0	61.0	2.70

Product	DC (inch)	DC (mm)	DC (inch)	LCF (mm)	OAL (mm)	DCON MS (mm)
A0027/64	7/64	2.78	0.1094	33.0	61.0	2.78
A0022.8	–	2.80	0.1102	33.0	61.0	2.80
A0022.9	–	2.90	0.1142	33.0	61.0	2.90
A0023.0	–	3.00	0.1181	33.0	61.0	3.00
A0023.1	–	3.10	0.1220	36.0	65.0	3.10
A0021/8	1/8	3.18	0.1250	36.0	65.0	3.18
A0023.2	–	3.20	0.1260	36.0	65.0	3.20
A0023.25	–	3.25	0.1280	36.0	65.0	3.25
A0023.3	–	3.30	0.1299	36.0	65.0	3.30
A0023.4	–	3.40	0.1339	39.0	70.0	3.40
A0023.5	–	3.50	0.1378	39.0	70.0	3.50
A0029/64	9/64	3.57	0.1406	39.0	70.0	3.57
A0023.6	–	3.60	0.1417	39.0	70.0	3.60
A0023.7	–	3.70	0.1457	39.0	70.0	3.70
A0023.8	–	3.80	0.1496	43.0	75.0	3.80
A0023.9	–	3.90	0.1535	43.0	75.0	3.90
A0025/32	5/32	3.97	0.1563	43.0	75.0	3.97
A0024.0	–	4.00	0.1575	43.0	75.0	4.00
A0024.1	–	4.10	0.1614	43.0	75.0	4.10
A0024.2	–	4.20	0.1654	43.0	75.0	4.20
A0024.3	–	4.30	0.1693	47.0	80.0	4.30
A00211/64	11/64	4.37	0.1719	47.0	80.0	4.37



Product	DC	DC	DC	LCF	OAL	DCON MS
	(inch)	(mm)	(inch)	(mm)	(mm)	(mm)
A0024.4	–	4.40	0.1732	47.0	80.0	4.40
A0024.5	–	4.50	0.1772	47.0	80.0	4.50
A0024.6	–	4.60	0.1811	47.0	80.0	4.60
A0024.7	–	4.70	0.1850	47.0	80.0	4.70
A0023/16	3/16	4.76	0.1875	52.0	86.0	4.76
A0024.8	–	4.80	0.1890	52.0	86.0	4.80
A0024.9	–	4.90	0.1929	52.0	86.0	4.90
A0025.0	–	5.00	0.1969	52.0	86.0	5.00
A0025.1	–	5.10	0.2008	52.0	86.0	5.10
A00213/64	13/64	5.16	0.2031	52.0	86.0	5.16
A0025.2	–	5.20	0.2047	52.0	86.0	5.20
A0025.3	–	5.30	0.2087	52.0	86.0	5.30
A0025.4	–	5.40	0.2126	57.0	93.0	5.40
A0025.5	–	5.50	0.2165	57.0	93.0	5.50
A0027/32	7/32	5.56	0.2188	57.0	93.0	5.56
A0025.6	–	5.60	0.2205	57.0	93.0	5.60
A0025.7	–	5.70	0.2244	57.0	93.0	5.70
A0025.8	–	5.80	0.2283	57.0	93.0	5.80
A0025.9	–	5.90	0.2323	57.0	93.0	5.90
A00215/64	15/64	5.95	0.2344	57.0	93.0	5.95
A0026.0	–	6.00	0.2362	57.0	93.0	6.00
A0026.1	–	6.10	0.2402	63.0	101.0	6.10
A0026.2	–	6.20	0.2441	63.0	101.0	6.20
A0026.3	–	6.30	0.2480	63.0	101.0	6.30
A0021/4	1/4	6.35	0.2500	63.0	101.0	6.35
A0026.4	–	6.40	0.2520	63.0	101.0	6.40
A0026.5	–	6.50	0.2559	63.0	101.0	6.50
A0026.6	–	6.60	0.2598	63.0	101.0	6.60
A0026.7	–	6.70	0.2638	63.0	101.0	6.70
A00217/64	17/64	6.75	0.2656	69.0	109.0	6.75
A0026.8	–	6.80	0.2677	69.0	109.0	6.80
A0026.9	–	6.90	0.2717	69.0	109.0	6.90
A0027.0	–	7.00	0.2756	69.0	109.0	7.00
A0027.1	–	7.10	0.2795	69.0	109.0	7.10
A0029/32	9/32	7.14	0.2813	69.0	109.0	7.14
A0027.2	–	7.20	0.2835	69.0	109.0	7.20
A0027.3	–	7.30	0.2874	69.0	109.0	7.30
A0027.4	–	7.40	0.2913	69.0	109.0	7.40
A0027.5	–	7.50	0.2953	69.0	109.0	7.50
A00219/64	19/64	7.54	0.2969	75.0	117.0	7.54
A0027.6	–	7.60	0.2992	75.0	117.0	7.60
A0027.7	–	7.70	0.3031	75.0	117.0	7.70
A0027.8	–	7.80	0.3071	75.0	117.0	7.80
A0027.9	–	7.90	0.3110	75.0	117.0	7.90
A0025/16	5/16	7.94	0.3125	75.0	117.0	7.94
A0028.0	–	8.00	0.3150	75.0	117.0	8.00
A0028.1	–	8.10	0.3189	75.0	117.0	8.10
A0028.2	–	8.20	0.3228	75.0	117.0	8.20
A0028.3	–	8.30	0.3268	75.0	117.0	8.30
A00221/64	21/64	8.33	0.3281	75.0	117.0	8.33
A0028.4	–	8.40	0.3307	75.0	117.0	8.40
A0028.5	–	8.50	0.3346	75.0	117.0	8.50
A0028.6	–	8.60	0.3386	81.0	125.0	8.60
A0028.7	–	8.70	0.3425	81.0	125.0	8.70
A00211/32	11/32	8.73	0.3438	81.0	125.0	8.73
A0028.8	–	8.80	0.3465	81.0	125.0	8.80
A0028.9	–	8.90	0.3504	81.0	125.0	8.90
A0029.0	–	9.00	0.3543	81.0	125.0	9.00
A0029.1	–	9.10	0.3583	81.0	125.0	9.10
A00223/64	23/64	9.13	0.3594	81.0	125.0	9.13
A0029.2	–	9.20	0.3622	81.0	125.0	9.20
A0029.3	–	9.30	0.3661	81.0	125.0	9.30
A0029.4	–	9.40	0.3701	81.0	125.0	9.40
A0029.5	–	9.50	0.3740	81.0	125.0	9.50
A0023/8	3/8	9.52	0.3750	87.0	133.0	9.52
A0029.6	–	9.60	0.3780	87.0	133.0	9.60
A0029.7	–	9.70	0.3819	87.0	133.0	9.70

Product	DC	DC	DC	LCF	OAL	DCON MS
	(inch)	(mm)	(inch)	(mm)	(mm)	(mm)
A0029.8	–	9.80	0.3858	87.0	133.0	9.80
A0029.9	–	9.90	0.3898	87.0	133.0	9.90
A00225/64	25/64	9.92	0.3906	87.0	133.0	9.92
A00210.0	–	10.00	0.3937	87.0	133.0	10.00
A00210.1	–	10.10	0.3976	87.0	133.0	10.10
A00210.2	–	10.20	0.4016	87.0	133.0	10.20
A00210.3	–	10.30	0.4055	87.0	133.0	10.30
A00213/32	13/32	10.32	0.4063	87.0	133.0	10.32
A00210.4	–	10.40	0.4094	87.0	133.0	10.40
A00210.5	–	10.50	0.4134	87.0	133.0	10.50
A00210.6	–	10.60	0.4173	87.0	133.0	10.60
A00210.7	–	10.70	0.4213	94.0	142.0	10.70
A00227/64	27/64	10.72	0.4219	94.0	142.0	10.72
A00210.8	–	10.80	0.4252	94.0	142.0	10.80
A00210.9	–	10.90	0.4291	94.0	142.0	10.90
A00211.0	–	11.00	0.4331	94.0	142.0	11.00
A00211.1	–	11.10	0.4370	94.0	142.0	11.10
A0027/16	7/16	11.11	0.4375	94.0	142.0	11.11
A00211.2	–	11.20	0.4409	94.0	142.0	11.20
A00211.3	–	11.30	0.4449	94.0	142.0	11.30
A00211.4	–	11.40	0.4488	94.0	142.0	11.40
A00211.5	–	11.50	0.4528	94.0	142.0	11.50
A00229/64	29/64	11.51	0.4531	94.0	142.0	11.51
A00211.6	–	11.60	0.4567	94.0	142.0	11.60
A00211.7	–	11.70	0.4606	94.0	142.0	11.70
A00211.8	–	11.80	0.4646	94.0	142.0	11.80
A00211.9	–	11.90	0.4685	101.0	151.0	11.90
A00215/32	15/32	11.91	0.4688	101.0	151.0	11.91
A00212.0	–	12.00	0.4724	101.0	151.0	12.00
A00212.1	–	12.10	0.4764	101.0	151.0	12.10
A00212.2	–	12.20	0.4803	101.0	151.0	12.20
A00212.3	–	12.30	0.4843	101.0	151.0	12.30
A00231/64	31/64	12.30	0.4844	101.0	151.0	12.30
A00212.4	–	12.40	0.4882	101.0	151.0	12.40
A00212.5	–	12.50	0.4921	101.0	151.0	12.50
A00212.6	–	12.60	0.4961	101.0	151.0	12.60
A00212.7	–	12.70	0.5000	101.0	151.0	12.70
A0021/2	1/2	12.70	0.5000	101.0	151.0	12.70
A00212.8	–	12.80	0.5039	101.0	151.0	12.80
A00212.9	–	12.90	0.5079	101.0	151.0	12.90
A00213.0	–	13.00	0.5118	101.0	151.0	13.00
A00233/64	33/64	13.10	0.5156	101.0	151.0	13.10
A00213.1	–	13.10	0.5157	101.0	151.0	13.10
A00213.2	–	13.20	0.5197	101.0	151.0	13.20
A00213.25	–	13.25	0.5217	108.0	160.0	13.25
A00213.3	–	13.30	0.5236	108.0	160.0	13.30
A00213.4	–	13.40	0.5276	108.0	160.0	13.40
A00217/32	17/32	13.49	0.5313	108.0	160.0	13.49
A00213.5	–	13.50	0.5315	108.0	160.0	13.50
A00213.6	–	13.60	0.5354	108.0	160.0	13.60
A00213.7	–	13.70	0.5394	108.0	160.0	13.70
A00213.75	–	13.75	0.5413	108.0	160.0	13.75
A00213.8	–	13.80	0.5433	108.0	160.0	13.80
A00213.9	–	13.90	0.5472	108.0	160.0	13.90
A00214.0	–	14.00	0.5512	108.0	160.0	14.00
A00214.25	–	14.25	0.5610	114.0	169.0	14.25
A0029/16	9/16	14.29	0.5625	114.0	169.0	14.29
A00214.5	–	14.50	0.5709	114.0	169.0	14.50
A00214.75	–	14.75	0.5807	114.0	169.0	14.75
A00215.0	–	15.00	0.5906	114.0	169.0	15.00
A00219/32	19/32	15.08	0.5938	120.0	178.0	15.08
A00215.25	–	15.25	0.6004	120.0	178.0	15.25
A00215.5	–	15.50	0.6102	120.0	178.0	15.50
A00215.75	–	15.75	0.6201	120.0	178.0	15.75
A0025/8	5/8	15.88	0.6250	120.0	178.0	15.88
A00216.0	–	16.00	0.6299	120.0	178.0	16.00

A002S



Kort borr av HSS med TiN-belagd spets, 2-pack

Vårt populära standardborr med TiN-belagd spets finns nu i 2-pack. Borrarna är användbara i de flesta material och är lättskärande, vilket ger dem längre livlängd, samtidigt som de arbetar snabbare än konventionella borr.

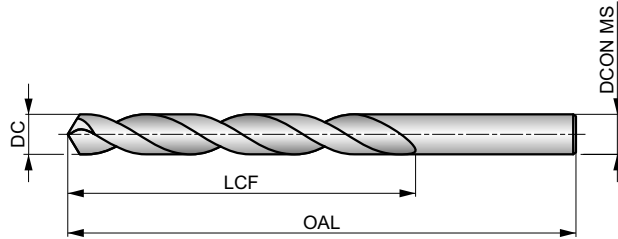

HSS	DIN 338	4×D
118°	TiN-Tip	
λ 20-35°	R	DC h8

Arbetsmaterialgrupper och startvärden för skärhastighet (m/min) och matningskod. Tabeller med matningar finns med början på sidan 274

P1.1 ■ 46 J	P1.2 ■ 52 J	P1.3 ■ 54 J	P2.1 ■ 40 J	P2.2 ■ 35 F	P2.3 ■ 31 F	P3.1 ■ 27 F	P3.2 ■ 21 F	P3.3 ■ 18 F	P4.1 ■ 16 F	P4.2 ■ 13 F	P4.3 ■ 11 E	M1.1 ■ 27 F	M1.2 ■ 23 F
M2.1 ■ 24 F	M2.2 ■ 20 F	M3.1 ■ 14 G	M3.2 ■ 12 G	M3.3 ■ 11 G	M4.1 ■ 16 C	K1.1 ■ 40 J	K1.2 ■ 30 E	K1.3 ■ 22 E	K2.1 ■ 34 E	K2.2 ■ 28 E	K2.3 ■ 22 E	K3.1 ■ 30 E	K3.2 ■ 23 E
K3.3 ■ 19 E	K4.1 ■ 28 E	K4.2 ■ 21 E	K4.3 ■ 16 E	K4.4 ■ 13 E	K4.5 ■ 11 E	K5.1 ■ 32 E	K5.2 ■ 24 E	K5.3 ■ 19 E	N1.1 ■ 41 K	N1.2 ■ 31 K	N1.3 ■ 21 J	N2.1 ■ 51 I	N2.2 ■ 46 I
N2.3 ■ 33 I	N3.1 ■ 56 H	N3.2 ■ 33 I	N3.3 ■ 17 G	N4.1 ■ 30 I	N4.2 ■ 50 H	N4.3 ■ 35 F	S1.1 ■ 23 F	S1.2 ■ 13 D	S1.3 ■ 7 B	S2.1 ■ 9 E	S2.2 ■ 4 A	S3.1 ■ 7 E	S3.2 ■ 3 A
S4.1 ■ 5 E	S4.2 ■ 2 A												

DC <= 5mm Säljs i 2-pack.

Product	DC (inch)	DC (mm)	DC (inch)	LCF (mm)	OAL (mm)	DCON MS (mm)
A002S2.0	–	2.00	0.0787	24.0	49.0	2.00
A002S2.5	–	2.50	0.0984	30.0	57.0	2.50
A002S3.0	–	3.00	0.1181	33.0	61.0	3.00
A002S1/8	1/8	3.18	0.1250	36.0	65.0	3.18
A002S3.2	–	3.20	0.1260	36.0	65.0	3.20
A002S3.3	–	3.30	0.1299	36.0	65.0	3.30
A002S3.5	–	3.50	0.1378	39.0	70.0	3.50
A002S5/32	5/32	3.97	0.1563	43.0	75.0	3.97
A002S4.0	–	4.00	0.1575	43.0	75.0	4.00
A002S4.1	–	4.10	0.1614	43.0	75.0	4.10
A002S4.2	–	4.20	0.1654	43.0	75.0	4.20
A002S4.5	–	4.50	0.1772	47.0	80.0	4.50
A002S3/16	3/16	4.76	0.1875	52.0	86.0	4.76
A002S5.0	–	5.00	0.1969	52.0	86.0	5.00
A002S13/64	13/64	5.16	0.2031	52.0	86.0	5.16
A002S5.5	–	5.50	0.2165	57.0	93.0	5.50
A002S7/32	7/32	5.56	0.2188	57.0	93.0	5.56
A002S6.0	–	6.00	0.2362	57.0	93.0	6.00
A002S1/4	1/4	6.35	0.2500	63.0	101.0	6.35
A002S6.5	–	6.50	0.2559	63.0	101.0	6.50

Product	DC (inch)	DC (mm)	DC (inch)	LCF (mm)	OAL (mm)	DCON MS (mm)
A002S6.8	–	6.80	0.2677	69.0	109.0	6.80
A002S7.0	–	7.00	0.2756	69.0	109.0	7.00
A002S7.5	–	7.50	0.2953	69.0	109.0	7.50
A002S5/16	5/16	7.94	0.3125	75.0	117.0	7.94
A002S8.0	–	8.00	0.3150	75.0	117.0	8.00
A002S8.2	–	8.20	0.3228	75.0	117.0	8.20
A002S8.5	–	8.50	0.3346	75.0	117.0	8.50
A002S9.0	–	9.00	0.3543	81.0	125.0	9.00
A002S9.5	–	9.50	0.3740	81.0	125.0	9.50
A002S3/8	3/8	9.52	0.3750	87.0	133.0	9.52
A002S10.0	–	10.00	0.3937	87.0	133.0	10.00
A002S10.2	–	10.20	0.4016	87.0	133.0	10.20
A002S10.5	–	10.50	0.4134	87.0	133.0	10.50
A002S11.0	–	11.00	0.4331	94.0	142.0	11.00
A002S11.5	–	11.50	0.4528	94.0	142.0	11.50
A002S12.0	–	12.00	0.4724	101.0	151.0	12.00
A002S12.5	–	12.50	0.4921	101.0	151.0	12.50
A002S1/2	1/2	12.70	0.5000	101.0	151.0	12.70
A002S13.0	–	13.00	0.5118	101.0	151.0	13.00

A108



Kort borr av HSS för rostfritt stål, ånganlöpt

Ett pålitligt borr för rostfritt stål. Används i första hand i handhållna maskiner. Kraftigt utförande med snabb spiral och 135° korsspets som är självcenterande. Ånganlöpt.

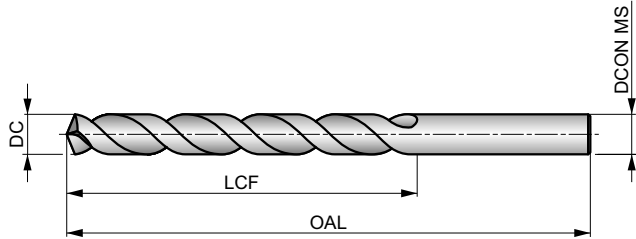

HSS	DIN 338	4×D
135°	ST	
λ>35°	R	DC h8

Arbetsmaterialgrupper och startvärden för skärhastighet (m/min) och matningskod. Tabeller med matningar finns med början på sidan 274

P1.1 □33 I	P1.2 □37 I	P1.3 □38 I	P2.1 □28 I	P2.2 □25 G	P2.3 □22 E	P3.1 □19 F	P3.2 □15 F	P3.3 □13 E	P4.1 □11 F	P4.2 □10 E	P4.3 □8 D	M1.1 □21 E	M1.2 □17 E
M2.1 □18 E	M2.2 □15 E	M3.1 ■10 G	M3.2 ■9 G	M3.3 ■8 G	M4.1 ■10 D	K1.1 □30 H	K1.2 □22 F	K1.3 □17 F	K2.1 □25 E	K2.2 □20 E	K2.3 □16 E	K3.1 □22 E	K3.2 □17 E
K3.3 □13 E	K4.1 □20 E	K4.2 □15 E	K4.3 □11 E	K4.4 □10 E	K4.5 □8 E	K5.1 □23 E	K5.2 □17 E	K5.3 □13 E	N1.1 □33 J	N1.2 □25 J	N1.3 □17 I	N2.1 □42 H	N2.2 □37 H
N2.3 □27 H	N3.1 □59 H	N3.2 □35 I	N3.3 □18 G	N4.1 □30 J	N4.2 □28 H	N4.3 □14 F	S1.1 ■25 G	S1.2 ■16 E	S1.3 □7 B	S2.1 □9 G	S2.2 □8 E	S3.1 □7 G	S3.2 □6 E
S4.1 □5 G	S4.2 □5 E												

DC > 1,5mm (1/16") Korsspets.
Produkter från den här serien finns även i set. Se A188

Product	DC (inch)	DC (mm)	DC (inch)	LCF (mm)	OAL (mm)	DCON MS (mm)
A1081.0	–	1.00	0.0394	12.0	34.0	1.00
A1081.1	–	1.10	0.0433	14.0	36.0	1.10
A1081.2	–	1.20	0.0472	16.0	38.0	1.20
A1081.3	–	1.30	0.0512	16.0	38.0	1.30
A1081.4	–	1.40	0.0551	18.0	40.0	1.40
A1081.5	–	1.50	0.0591	18.0	40.0	1.50
A1081/16	1/16	1.59	0.0625	20.0	43.0	1.59
A1081.6	–	1.60	0.0630	20.0	43.0	1.60
A1081.7	–	1.70	0.0669	20.0	43.0	1.70
A1081.8	–	1.80	0.0709	22.0	46.0	1.80
A1081.9	–	1.90	0.0748	22.0	46.0	1.90
A1085/64	5/64	1.98	0.0781	24.0	49.0	1.98
A1082.0	–	2.00	0.0787	24.0	49.0	2.00
A1082.1	–	2.10	0.0827	24.0	49.0	2.10
A1082.2	–	2.20	0.0866	27.0	53.0	2.20
A1082.3	–	2.30	0.0906	27.0	53.0	2.30
A1083/32	3/32	2.38	0.0938	30.0	57.0	2.38
A1082.4	–	2.40	0.0945	30.0	57.0	2.40
A1082.5	–	2.50	0.0984	30.0	57.0	2.50
A1082.6	–	2.60	0.1024	30.0	57.0	2.60
A1082.7	–	2.70	0.1063	33.0	61.0	2.70
A1087/64	7/64	2.78	0.1094	33.0	61.0	2.78

Product	DC (inch)	DC (mm)	DC (inch)	LCF (mm)	OAL (mm)	DCON MS (mm)
A1082.8	–	2.80	0.1102	33.0	61.0	2.80
A1082.9	–	2.90	0.1142	33.0	61.0	2.90
A1083.0	–	3.00	0.1181	33.0	61.0	3.00
A1083.1	–	3.10	0.1220	36.0	65.0	3.10
A1081/8	1/8	3.18	0.1250	36.0	65.0	3.18
A1083.2	–	3.20	0.1260	36.0	65.0	3.20
A1083.3	–	3.30	0.1299	36.0	65.0	3.30
A1083.4	–	3.40	0.1339	39.0	70.0	3.40
A1083.5	–	3.50	0.1378	39.0	70.0	3.50
A1089/64	9/64	3.57	0.1406	39.0	70.0	3.57
A1083.6	–	3.60	0.1417	39.0	70.0	3.60
A1083.7	–	3.70	0.1457	39.0	70.0	3.70
A1083.8	–	3.80	0.1496	43.0	75.0	3.80
A1083.9	–	3.90	0.1535	43.0	75.0	3.90
A1085/32	5/32	3.97	0.1563	43.0	75.0	3.97
A1084.0	–	4.00	0.1575	43.0	75.0	4.00
A1084.1	–	4.10	0.1614	43.0	75.0	4.10
A1084.2	–	4.20	0.1654	43.0	75.0	4.20
A1084.3	–	4.30	0.1693	47.0	80.0	4.30
A10811/64	11/64	4.37	0.1719	47.0	80.0	4.37
A1084.4	–	4.40	0.1732	47.0	80.0	4.40
A1084.5	–	4.50	0.1772	47.0	80.0	4.50

Product	DC	DC	DC	LCF	OAL	D CON MS
	(inch)	(mm)	(inch)	(mm)	(mm)	(mm)
A1084.6	–	4.60	0.1811	47.0	80.0	4.60
A1084.7	–	4.70	0.1850	47.0	80.0	4.70
A1083/16	3/16	4.76	0.1875	52.0	86.0	4.76
A1084.8	–	4.80	0.1890	52.0	86.0	4.80
A1084.9	–	4.90	0.1929	52.0	86.0	4.90
A108N10	N10	4.92	0.1935	52.0	86.0	4.92
A1085.0	–	5.00	0.1969	52.0	86.0	5.00
A1085.1	–	5.10	0.2008	52.0	86.0	5.10
A10813/64	13/64	5.16	0.2031	52.0	86.0	5.16
A1085.2	–	5.20	0.2047	52.0	86.0	5.20
A1085.3	–	5.30	0.2087	52.0	86.0	5.30
A1085.4	–	5.40	0.2126	57.0	93.0	5.40
A1085.5	–	5.50	0.2165	57.0	93.0	5.50
A1087/32	7/32	5.56	0.2188	57.0	93.0	5.56
A1085.6	–	5.60	0.2205	57.0	93.0	5.60
A1085.7	–	5.70	0.2244	57.0	93.0	5.70
A1085.8	–	5.80	0.2283	57.0	93.0	5.80
A1085.9	–	5.90	0.2323	57.0	93.0	5.90
A10815/64	15/64	5.95	0.2344	57.0	93.0	5.95
A1086.0	–	6.00	0.2362	57.0	93.0	6.00
A1086.1	–	6.10	0.2402	63.0	101.0	6.10
A1086.2	–	6.20	0.2441	63.0	101.0	6.20
A1086.3	–	6.30	0.2480	63.0	101.0	6.30
A1081/4	1/4	6.35	0.2500	63.0	101.0	6.35
A1086.4	–	6.40	0.2520	63.0	101.0	6.40
A1086.5	–	6.50	0.2559	63.0	101.0	6.50
A1086.6	–	6.60	0.2598	63.0	101.0	6.60
A1086.7	–	6.70	0.2638	63.0	101.0	6.70
A10817/64	17/64	6.75	0.2656	69.0	109.0	6.75
A1086.8	–	6.80	0.2677	69.0	109.0	6.80
A1086.9	–	6.90	0.2717	69.0	109.0	6.90
A1087.0	–	7.00	0.2756	69.0	109.0	7.00
A1087.1	–	7.10	0.2795	69.0	109.0	7.10
A1089/32	9/32	7.14	0.2813	69.0	109.0	7.14
A1087.2	–	7.20	0.2835	69.0	109.0	7.20
A1087.3	–	7.30	0.2874	69.0	109.0	7.30
A1087.4	–	7.40	0.2913	69.0	109.0	7.40
A1087.5	–	7.50	0.2953	69.0	109.0	7.50
A10819/64	19/64	7.54	0.2969	75.0	117.0	7.54
A1087.6	–	7.60	0.2992	75.0	117.0	7.60
A1087.7	–	7.70	0.3031	75.0	117.0	7.70
A1087.8	–	7.80	0.3071	75.0	117.0	7.80
A1087.9	–	7.90	0.3110	75.0	117.0	7.90
A1085/16	5/16	7.94	0.3125	75.0	117.0	7.94
A1088.0	–	8.00	0.3150	75.0	117.0	8.00
A1088.1	–	8.10	0.3189	75.0	117.0	8.10
A1088.2	–	8.20	0.3228	75.0	117.0	8.20

Product	DC	DC	DC	LCF	OAL	D CON MS
	(inch)	(mm)	(inch)	(mm)	(mm)	(mm)
A1088.3	–	8.30	0.3268	75.0	117.0	8.30
A10821/64	21/64	8.33	0.3281	75.0	117.0	8.33
A1088.4	–	8.40	0.3307	75.0	117.0	8.40
A1088.5	–	8.50	0.3346	75.0	117.0	8.50
A1088.6	–	8.60	0.3386	81.0	125.0	8.60
A1088.7	–	8.70	0.3425	81.0	125.0	8.70
A10811/32	11/32	8.73	0.3438	81.0	125.0	8.73
A1088.8	–	8.80	0.3465	81.0	125.0	8.80
A1088.9	–	8.90	0.3504	81.0	125.0	8.90
A1089.0	–	9.00	0.3543	81.0	125.0	9.00
A1089.1	–	9.10	0.3583	81.0	125.0	9.10
A10823/64	23/64	9.13	0.3594	81.0	125.0	9.13
A1089.2	–	9.20	0.3622	81.0	125.0	9.20
A1089.3	–	9.30	0.3661	81.0	125.0	9.30
A1089.4	–	9.40	0.3701	81.0	125.0	9.40
A1089.5	–	9.50	0.3740	81.0	125.0	9.50
A1083/8	3/8	9.52	0.3750	87.0	133.0	9.52
A1089.6	–	9.60	0.3780	87.0	133.0	9.60
A1089.7	–	9.70	0.3819	87.0	133.0	9.70
A1089.8	–	9.80	0.3858	87.0	133.0	9.80
A1089.9	–	9.90	0.3898	87.0	133.0	9.90
A10825/64	25/64	9.92	0.3906	87.0	133.0	9.92
A10810.0	–	10.00	0.3937	87.0	133.0	10.00
A10810.2	–	10.20	0.4016	87.0	133.0	10.20
A10813/32	13/32	10.32	0.4063	87.0	133.0	10.32
A10810.5	–	10.50	0.4134	87.0	133.0	10.50
A10827/64	27/64	10.72	0.4219	94.0	142.0	10.72
A10810.8	–	10.80	0.4252	94.0	142.0	10.80
A10811.0	–	11.00	0.4331	94.0	142.0	11.00
A1087/16	7/16	11.11	0.4375	94.0	142.0	11.11
A10811.5	–	11.50	0.4528	94.0	142.0	11.50
A10829/64	29/64	11.51	0.4531	94.0	142.0	11.51
A10811.8	–	11.80	0.4646	94.0	142.0	11.80
A10815/32	15/32	11.91	0.4688	101.0	151.0	11.91
A10812.0	–	12.00	0.4724	101.0	151.0	12.00
A10812.2	–	12.20	0.4803	101.0	151.0	12.20
A10831/64	31/64	12.30	0.4844	101.0	151.0	12.30
A10812.5	–	12.50	0.4921	101.0	151.0	12.50
A1081/2	1/2	12.70	0.5000	101.0	151.0	12.70
A10812.8	–	12.80	0.5039	101.0	151.0	12.80
A10813.0	–	13.00	0.5118	101.0	151.0	13.00
A10813.5	–	13.50	0.5315	108.0	160.0	13.50
A10814.0	–	14.00	0.5512	108.0	160.0	14.00
A10814.5	–	14.50	0.5709	114.0	169.0	14.50
A10815.0	–	15.00	0.5906	114.0	169.0	15.00
A10815.25	–	15.25	0.6004	120.0	178.0	15.25
A10816.0	–	16.00	0.6299	120.0	178.0	16.00

A110



Långt cylindriskt borr av HSS, ånganlöpt

Lång borr för djupa hål. Konventionell spets med 118° spetsvinkel som är enkel att slipa om. Ett universellt verktyg som kan användas i de flesta material. Ånganlöpt.

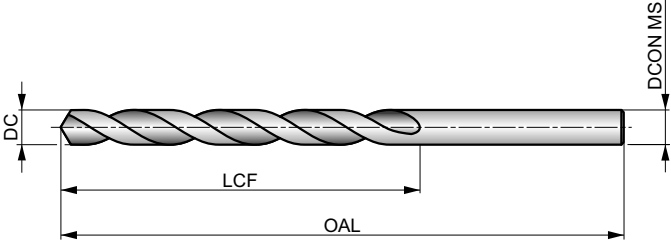

HSS	DIN 340	6×D
118°	ST	
λ 20-35°	R	DC h8

DC <= 1mm; 1/16" Blank.

Product	DC (inch)	DC (mm)	DC (inch)	LCF (mm)	OAL (mm)	DCON MS (mm)
A110.5	–	0.50	0.0197	12.0	32.0	0.50
A110.6	–	0.60	0.0236	15.0	35.0	0.60
A110.7	–	0.70	0.0276	21.0	42.0	0.70
A1101/32	1/32	0.79	0.0313	25.0	46.0	0.79
A110.8	–	0.80	0.0315	25.0	46.0	0.80
A110.9	–	0.90	0.0354	29.0	51.0	0.90
A1101.0	–	1.00	0.0394	33.0	56.0	1.00
A1101.1	–	1.10	0.0433	37.0	60.0	1.10
A1101.2	–	1.20	0.0472	41.0	65.0	1.20
A1101.3	–	1.30	0.0512	41.0	65.0	1.30
A1101.4	–	1.40	0.0551	45.0	70.0	1.40
A1101.5	–	1.50	0.0591	45.0	70.0	1.50
A1101/16	1/16	1.59	0.0625	50.0	76.0	1.59
A1101.6	–	1.60	0.0630	50.0	76.0	1.60
A1101.7	–	1.70	0.0669	50.0	76.0	1.70
A1101.75	–	1.75	0.0689	53.0	80.0	1.75
A1101.8	–	1.80	0.0709	53.0	80.0	1.80
A1101.9	–	1.90	0.0748	53.0	80.0	1.90
A1105/64	5/64	1.98	0.0781	56.0	85.0	1.98
A1102.0	–	2.00	0.0787	56.0	85.0	2.00
A1102.05	–	2.05	0.0807	56.0	85.0	2.05
A1102.1	–	2.10	0.0827	56.0	85.0	2.10
A1102.2	–	2.20	0.0866	59.0	90.0	2.20
A1102.25	–	2.25	0.0886	59.0	90.0	2.25
A1102.3	–	2.30	0.0906	59.0	90.0	2.30
A1103/32	3/32	2.38	0.0938	62.0	95.0	2.38
A1102.4	–	2.40	0.0945	62.0	95.0	2.40
A1102.5	–	2.50	0.0984	62.0	95.0	2.50
A1102.6	–	2.60	0.1024	62.0	95.0	2.60
A1102.7	–	2.70	0.1063	66.0	100.0	2.70
A1107/64	7/64	2.78	0.1094	66.0	100.0	2.78
A1102.8	–	2.80	0.1102	66.0	100.0	2.80
A1102.9	–	2.90	0.1142	66.0	100.0	2.90

Product	DC (inch)	DC (mm)	DC (inch)	LCF (mm)	OAL (mm)	DCON MS (mm)
A1103.0	–	3.00	0.1181	66.0	100.0	3.00
A1103.1	–	3.10	0.1220	69.0	106.0	3.10
A1101/8	1/8	3.18	0.1250	69.0	106.0	3.18
A1103.2	–	3.20	0.1260	69.0	106.0	3.20
A1103.25	–	3.25	0.1280	69.0	106.0	3.25
A1103.3	–	3.30	0.1299	69.0	106.0	3.30
A1103.4	–	3.40	0.1339	73.0	112.0	3.40
A1103.5	–	3.50	0.1378	73.0	112.0	3.50
A1109/64	9/64	3.57	0.1406	73.0	112.0	3.57
A1103.6	–	3.60	0.1417	73.0	112.0	3.60
A1103.7	–	3.70	0.1457	73.0	112.0	3.70
A1103.75	–	3.75	0.1476	73.0	112.0	3.75
A1103.8	–	3.80	0.1496	78.0	119.0	3.80
A1103.9	–	3.90	0.1535	78.0	119.0	3.90
A1105/32	5/32	3.97	0.1563	78.0	119.0	3.97
A1104.0	–	4.00	0.1575	78.0	119.0	4.00
A1104.1	–	4.10	0.1614	78.0	119.0	4.10
A1104.2	–	4.20	0.1654	78.0	119.0	4.20
A1104.25	–	4.25	0.1673	78.0	119.0	4.25
A1104.3	–	4.30	0.1693	82.0	126.0	4.30
A11011/64	11/64	4.37	0.1719	82.0	126.0	4.37
A1104.4	–	4.40	0.1732	82.0	126.0	4.40
A1104.5	–	4.50	0.1772	82.0	126.0	4.50
A1104.6	–	4.60	0.1811	82.0	126.0	4.60
A1104.7	–	4.70	0.1850	82.0	126.0	4.70
A1104.75	–	4.75	0.1870	82.0	126.0	4.75
A1103/16	3/16	4.76	0.1875	87.0	132.0	4.76
A1104.8	–	4.80	0.1890	87.0	132.0	4.80
A1104.9	–	4.90	0.1929	87.0	132.0	4.90
A1105.0	–	5.00	0.1969	87.0	132.0	5.00
A1105.1	–	5.10	0.2008	87.0	132.0	5.10
A11013/64	13/64	5.16	0.2031	87.0	132.0	5.16
A1105.2	–	5.20	0.2047	87.0	132.0	5.20

Product	DC	DC	DC	LCF	OAL	D CON MS
	(inch)	(mm)	(inch)	(mm)	(mm)	(mm)
A1105.25	–	5.25	0.2067	87.0	132.0	5.25
A1105.3	–	5.30	0.2087	87.0	132.0	5.30
A1105.4	–	5.40	0.2126	91.0	139.0	5.40
A1105.5	–	5.50	0.2165	91.0	139.0	5.50
A1107/32	7/32	5.56	0.2188	91.0	139.0	5.56
A1105.6	–	5.60	0.2205	91.0	139.0	5.60
A1105.7	–	5.70	0.2244	91.0	139.0	5.70
A1105.75	–	5.75	0.2264	91.0	139.0	5.75
A1105.8	–	5.80	0.2283	91.0	139.0	5.80
A1105.9	–	5.90	0.2323	91.0	139.0	5.90
A11015/64	15/64	5.95	0.2344	91.0	139.0	5.95
A1106.0	–	6.00	0.2362	91.0	139.0	6.00
A1106.1	–	6.10	0.2402	97.0	148.0	6.10
A1106.2	–	6.20	0.2441	97.0	148.0	6.20
A1106.25	–	6.25	0.2461	97.0	148.0	6.25
A1106.3	–	6.30	0.2480	97.0	148.0	6.30
A1101/4	1/4	6.35	0.2500	97.0	148.0	6.35
A1106.4	–	6.40	0.2520	97.0	148.0	6.40
A1106.5	–	6.50	0.2559	97.0	148.0	6.50
A1106.6	–	6.60	0.2598	97.0	148.0	6.60
A1106.7	–	6.70	0.2638	97.0	148.0	6.70
A11017/64	17/64	6.75	0.2656	102.0	156.0	6.75
A1106.75	–	6.75	0.2657	102.0	156.0	6.75
A1106.8	–	6.80	0.2677	102.0	156.0	6.80
A1106.9	–	6.90	0.2717	102.0	156.0	6.90
A1107.0	–	7.00	0.2756	102.0	156.0	7.00
A1107.1	–	7.10	0.2795	102.0	156.0	7.10
A1109/32	9/32	7.14	0.2813	102.0	156.0	7.14
A1107.2	–	7.20	0.2835	102.0	156.0	7.20
A1107.25	–	7.25	0.2854	102.0	156.0	7.25
A1107.3	–	7.30	0.2874	102.0	156.0	7.30
A1107.4	–	7.40	0.2913	102.0	156.0	7.40
A1107.5	–	7.50	0.2953	102.0	156.0	7.50
A1107.6	–	7.60	0.2992	109.0	165.0	7.60
A1107.7	–	7.70	0.3031	109.0	165.0	7.70
A1107.75	–	7.75	0.3051	109.0	165.0	7.75
A1107.8	–	7.80	0.3071	109.0	165.0	7.80
A1107.9	–	7.90	0.3110	109.0	165.0	7.90
A1105/16	5/16	7.94	0.3125	109.0	165.0	7.94
A1108.0	–	8.00	0.3150	109.0	165.0	8.00
A1108.1	–	8.10	0.3189	109.0	165.0	8.10
A1108.2	–	8.20	0.3228	109.0	165.0	8.20
A1108.25	–	8.25	0.3248	109.0	165.0	8.25
A1108.3	–	8.30	0.3268	109.0	165.0	8.30
A1108.4	–	8.40	0.3307	109.0	165.0	8.40
A1108.5	–	8.50	0.3346	109.0	165.0	8.50
A1108.6	–	8.60	0.3386	115.0	175.0	8.60
A1108.7	–	8.70	0.3425	115.0	175.0	8.70
A11011/32	11/32	8.73	0.3438	115.0	175.0	8.73
A1108.75	–	8.75	0.3445	115.0	175.0	8.75
A1108.8	–	8.80	0.3465	115.0	175.0	8.80

Product	DC	DC	DC	LCF	OAL	D CON MS
	(inch)	(mm)	(inch)	(mm)	(mm)	(mm)
A1109.0	–	9.00	0.3543	115.0	175.0	9.00
A1109.1	–	9.10	0.3583	115.0	175.0	9.10
A1109.2	–	9.20	0.3622	115.0	175.0	9.20
A1109.3	–	9.30	0.3661	115.0	175.0	9.30
A1109.5	–	9.50	0.3740	115.0	175.0	9.50
A1103/8	3/8	9.52	0.3750	121.0	184.0	9.52
A1109.6	–	9.60	0.3780	121.0	184.0	9.60
A1109.7	–	9.70	0.3819	121.0	184.0	9.70
A1109.8	–	9.80	0.3858	121.0	184.0	9.80
A1109.9	–	9.90	0.3898	121.0	184.0	9.90
A11010.0	–	10.00	0.3937	121.0	184.0	10.00
A11010.1	–	10.10	0.3976	121.0	184.0	10.10
A11010.2	–	10.20	0.4016	121.0	184.0	10.20
A11010.25	–	10.25	0.4035	121.0	184.0	10.25
A11010.3	–	10.30	0.4055	121.0	184.0	10.30
A11013/32	13/32	10.32	0.4063	121.0	184.0	10.32
A11010.5	–	10.50	0.4134	121.0	184.0	10.50
A11010.75	–	10.75	0.4232	128.0	195.0	10.75
A11010.8	–	10.80	0.4252	128.0	195.0	10.80
A11011.0	–	11.00	0.4331	128.0	195.0	11.00
A1107/16	7/16	11.11	0.4375	128.0	195.0	11.11
A11011.5	–	11.50	0.4528	128.0	195.0	11.50
A11011.75	–	11.75	0.4626	128.0	195.0	11.75
A11012.0	–	12.00	0.4724	134.0	205.0	12.00
A11012.1	–	12.10	0.4764	134.0	205.0	12.10
A11012.25	–	12.25	0.4823	134.0	205.0	12.25
A11012.5	–	12.50	0.4921	134.0	205.0	12.50
A1101/2	1/2	12.70	0.5000	134.0	205.0	12.70
A11013.0	–	13.00	0.5118	134.0	205.0	13.00
A11017/32	17/32	13.49	0.5313	140.0	214.0	13.49
A11013.5	–	13.50	0.5315	140.0	214.0	13.50
A11014.0	–	14.00	0.5512	140.0	214.0	14.00
A1109/16	9/16	14.29	0.5625	144.0	220.0	14.29
A11014.5	–	14.50	0.5709	144.0	220.0	14.50
A11015.0	–	15.00	0.5906	144.0	220.0	15.00
A11015.5	–	15.50	0.6102	149.0	227.0	15.50
A1105/8	5/8	15.88	0.6250	149.0	227.0	15.88
A11016.0	–	16.00	0.6299	149.0	227.0	16.00
A11016.5	–	16.50	0.6496	154.0	235.0	16.50
A11017.0	–	17.00	0.6693	154.0	235.0	17.00
A11017.5	–	17.50	0.6890	158.0	241.0	17.50
A11018.0	–	18.00	0.7087	158.0	241.0	18.00
A11018.5	–	18.50	0.7283	162.0	247.0	18.50
A11019.0	–	19.00	0.7480	162.0	247.0	19.00
A1103/4	3/4	19.05	0.7500	166.0	254.0	19.05
A11019.5	–	19.50	0.7677	166.0	254.0	19.50
A11020.0	–	20.00	0.7874	166.0	254.0	20.00
A11021.0	–	21.00	0.8268	171.0	261.0	21.00
A11022.0	–	22.00	0.8661	176.0	268.0	22.00
A1107/8	7/8	22.22	0.8750	176.0	268.0	22.22
A1101	1"	25.40	1.0000	190.0	290.0	25.40

A125



Extra lång, cylindrisk borrh, ånganlöpt

Extralång borrh för djupa hål. Vanlig spets med 118° spetsvinkel som är enkel att slipa om. Ett universellt verktyg som kan användas i de flesta material. Ånganlöpt.

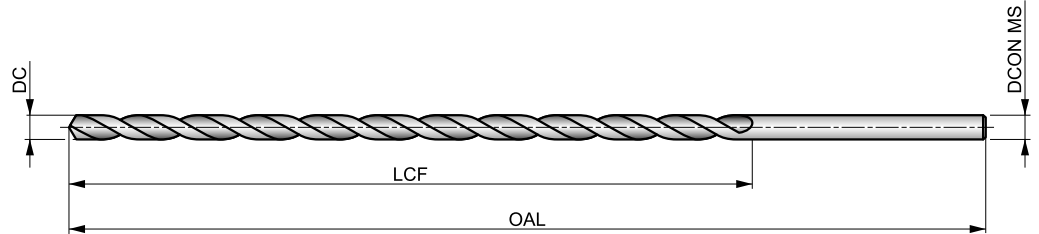

HSS	BS 328	10×D
118°	ST	
λ 20-35°	R	DC h8

DC <= 2,2mm; 5/64" Blank.

Product	DC (inch)	DC (mm)	DC (inch)	LCF (mm)	OAL (mm)	DCON MS (mm)
A1251.4X160	–	1.40	0.0551	100.0	160.0	1.40
A1251.5X125	–	1.50	0.0591	80.0	125.0	1.50
A1251.5X160	–	1.50	0.0591	100.0	160.0	1.50
A1251/16X125	1/16	1.59	0.0625	80.0	125.0	1.59
A1251/16X160	1/16	1.59	0.0625	100.0	160.0	1.59
A1251.8X160	–	1.80	0.0709	100.0	160.0	1.80
A1255/64X125	5/64	1.98	0.0781	80.0	125.0	1.98
A1255/64X160	5/64	1.98	0.0781	100.0	160.0	1.98
A1252.0X125	–	2.00	0.0787	80.0	125.0	2.00
A1252.0X160	–	2.00	0.0787	100.0	160.0	2.00
A1252.2X160	–	2.20	0.0866	100.0	160.0	2.20
A1253/32X125	3/32	2.38	0.0938	80.0	125.0	2.38
A1253/32X160	3/32	2.38	0.0938	100.0	160.0	2.38
A1252.5X125	–	2.50	0.0984	80.0	125.0	2.50
A1252.5X160	–	2.50	0.0984	100.0	160.0	2.50
A1257/64X125	7/64	2.78	0.1094	80.0	125.0	2.78
A1257/64X160	7/64	2.78	0.1094	100.0	160.0	2.78
A1253.0X160	–	3.00	0.1181	100.0	160.0	3.00
A1253.0X200	–	3.00	0.1181	150.0	200.0	3.00
A1253.0X250	–	3.00	0.1181	200.0	250.0	3.00
A1251/8X160	1/8	3.18	0.1250	100.0	160.0	3.18
A1251/8X200	1/8	3.18	0.1250	150.0	200.0	3.18
A1251/8X250	1/8	3.18	0.1250	200.0	250.0	3.18
A1251/8X315	1/8	3.18	0.1250	250.0	310.0	3.18
A1253.3X160	–	3.30	0.1299	100.0	160.0	3.30
A1253.5X160	–	3.50	0.1378	100.0	160.0	3.50
A1253.5X200	–	3.50	0.1378	150.0	200.0	3.50
A1253.5X250	–	3.50	0.1378	200.0	250.0	3.50
A1259/64X160	9/64	3.57	0.1406	100.0	160.0	3.57
A1259/64X200	9/64	3.57	0.1406	150.0	200.0	3.57
A1259/64X315	9/64	3.57	0.1406	250.0	310.0	3.57
A1255/32X160	5/32	3.97	0.1563	100.0	160.0	3.97
A1255/32X200	5/32	3.97	0.1563	150.0	200.0	3.97

Product	DC (inch)	DC (mm)	DC (inch)	LCF (mm)	OAL (mm)	DCON MS (mm)
A1255/32X250	5/32	3.97	0.1563	200.0	250.0	3.97
A1255/32X315	5/32	3.97	0.1563	250.0	310.0	3.97
A1254.0X160	–	4.00	0.1575	100.0	160.0	4.00
A1254.0X200	–	4.00	0.1575	150.0	200.0	4.00
A1254.0X250	–	4.00	0.1575	200.0	250.0	4.00
A1254.0X315	–	4.00	0.1575	250.0	310.0	4.00
A12511/64X160	11/64	4.37	0.1719	100.0	160.0	4.37
A12511/64X200	11/64	4.37	0.1719	150.0	200.0	4.37
A12511/64X315	11/64	4.37	0.1719	250.0	310.0	4.37
A1254.5X160	–	4.50	0.1772	100.0	160.0	4.50
A1254.5X200	–	4.50	0.1772	150.0	200.0	4.50
A1254.5X250	–	4.50	0.1772	200.0	250.0	4.50
A1254.5X315	–	4.50	0.1772	250.0	310.0	4.50
A1253/16X160	3/16	4.76	0.1875	100.0	160.0	4.76
A1253/16X200	3/16	4.76	0.1875	150.0	200.0	4.76
A1253/16X250	3/16	4.76	0.1875	200.0	250.0	4.76
A1253/16X315	3/16	4.76	0.1875	250.0	310.0	4.76
A1253/16X400	3/16	4.76	0.1875	300.0	400.0	4.76
A1255.0X160	–	5.00	0.1969	100.0	160.0	5.00
A1255.0X200	–	5.00	0.1969	150.0	200.0	5.00
A1255.0X250	–	5.00	0.1969	200.0	250.0	5.00
A1255.0X315	–	5.00	0.1969	250.0	310.0	5.00
A1255.0X400	–	5.00	0.1969	300.0	400.0	5.00
A12513/64X200	13/64	5.16	0.2031	150.0	200.0	5.16
A12513/64X250	13/64	5.16	0.2031	200.0	250.0	5.16
A12513/64X315	13/64	5.16	0.2031	250.0	310.0	5.16
A1255.5X200	–	5.50	0.2165	150.0	200.0	5.50
A1255.5X250	–	5.50	0.2165	200.0	250.0	5.50
A1255.5X315	–	5.50	0.2165	250.0	310.0	5.50
A1257/32X200	7/32	5.56	0.2188	150.0	200.0	5.56
A1257/32X250	7/32	5.56	0.2188	200.0	250.0	5.56
A12515/64X200	15/64	5.95	0.2344	150.0	200.0	5.95
A12515/64X315	15/64	5.95	0.2344	250.0	310.0	5.95

Product	DC	DC	DC	LCF	OAL	DCON MS
	(inch)	(mm)	(inch)	(mm)	(mm)	(mm)
A1256.0X200	–	6.00	0.2362	150.0	200.0	6.00
A1256.0X250	–	6.00	0.2362	200.0	250.0	6.00
A1256.0X315	–	6.00	0.2362	250.0	310.0	6.00
A1256.0X400	–	6.00	0.2362	300.0	400.0	6.00
A1251/4X200	1/4	6.35	0.2500	150.0	200.0	6.35
A1251/4X250	1/4	6.35	0.2500	200.0	250.0	6.35
A1251/4X315	1/4	6.35	0.2500	250.0	310.0	6.35
A1251/4X400	1/4	6.35	0.2500	300.0	400.0	6.35
A1251/4X500	1/4	6.35	0.2500	400.0	460.0	6.35
A1256.5X200	–	6.50	0.2559	150.0	200.0	6.50
A1256.5X250	–	6.50	0.2559	200.0	250.0	6.50
A1256.5X315	–	6.50	0.2559	250.0	310.0	6.50
A12517/64X200	17/64	6.75	0.2656	150.0	200.0	6.75
A12517/64X250	17/64	6.75	0.2656	200.0	250.0	6.75
A12517/64X500	17/64	6.75	0.2656	400.0	460.0	6.75
A1257.0X200	–	7.00	0.2756	150.0	200.0	7.00
A1257.0X250	–	7.00	0.2756	200.0	250.0	7.00
A1257.0X315	–	7.00	0.2756	250.0	310.0	7.00
A1257.5X200	–	7.50	0.2953	150.0	200.0	7.50
A1257.5X250	–	7.50	0.2953	200.0	250.0	7.50
A1257.5X315	–	7.50	0.2953	250.0	310.0	7.50
A1255/16X200	5/16	7.94	0.3125	150.0	200.0	7.94
A1255/16X250	5/16	7.94	0.3125	200.0	250.0	7.94
A1255/16X315	5/16	7.94	0.3125	250.0	310.0	7.94
A1255/16X500	5/16	7.94	0.3125	400.0	460.0	7.94
A1258.0X250	–	8.00	0.3150	200.0	250.0	8.00
A1258.0X315	–	8.00	0.3150	250.0	310.0	8.00
A1258.0X400	–	8.00	0.3150	300.0	400.0	8.00
A12521/64X315	21/64	8.33	0.3281	250.0	310.0	8.33
A1258.5X250	–	8.50	0.3346	200.0	250.0	8.50
A1258.5X315	–	8.50	0.3346	250.0	310.0	8.50
A12511/32X250	11/32	8.73	0.3438	200.0	250.0	8.73
A12511/32X315	11/32	8.73	0.3438	250.0	310.0	8.73
A12511/32X400	11/32	8.73	0.3438	300.0	400.0	8.73
A12511/32X500	11/32	8.73	0.3438	400.0	460.0	8.73
A1259.0X250	–	9.00	0.3543	200.0	250.0	9.00
A1259.0X315	–	9.00	0.3543	250.0	310.0	9.00
A1259.0X400	–	9.00	0.3543	300.0	400.0	9.00
A1259.5X250	–	9.50	0.3740	200.0	250.0	9.50
A1259.5X315	–	9.50	0.3740	250.0	310.0	9.50

Product	DC	DC	DC	LCF	OAL	DCON MS
	(inch)	(mm)	(inch)	(mm)	(mm)	(mm)
A1253/8X250	3/8	9.52	0.3750	200.0	250.0	9.52
A1253/8X315	3/8	9.52	0.3750	250.0	310.0	9.52
A1253/8X400	3/8	9.52	0.3750	300.0	400.0	9.52
A1253/8X500	3/8	9.52	0.3750	400.0	460.0	9.52
A12510.0X250	–	10.00	0.3937	200.0	250.0	10.00
A12510.0X315	–	10.00	0.3937	250.0	310.0	10.00
A12510.0X400	–	10.00	0.3937	300.0	400.0	10.00
A12513/32X250	13/32	10.32	0.4063	200.0	250.0	10.32
A12513/32X315	13/32	10.32	0.4063	250.0	310.0	10.32
A12510.5X250	–	10.50	0.4134	200.0	250.0	10.50
A12510.5X315	–	10.50	0.4134	250.0	310.0	10.50
A12510.5X400	–	10.50	0.4134	300.0	400.0	10.50
A12511.0X250	–	11.00	0.4331	200.0	250.0	11.00
A12511.0X315	–	11.00	0.4331	250.0	310.0	11.00
A12511.0X400	–	11.00	0.4331	300.0	400.0	11.00
A1257/16X250	7/16	11.11	0.4375	200.0	250.0	11.11
A1257/16X315	7/16	11.11	0.4375	250.0	310.0	11.11
A1257/16X400	7/16	11.11	0.4375	300.0	400.0	11.11
A12529/64X315	29/64	11.51	0.4531	250.0	310.0	11.51
A12512.0X250	–	12.00	0.4724	200.0	250.0	12.00
A12512.0X315	–	12.00	0.4724	250.0	310.0	12.00
A12512.0X400	–	12.00	0.4724	300.0	400.0	12.00
A12531/64X315	31/64	12.30	0.4844	250.0	310.0	12.30
A1251/2X250	1/2	12.70	0.5000	200.0	250.0	12.70
A1251/2X315	1/2	12.70	0.5000	250.0	310.0	12.70
A1251/2X400	1/2	12.70	0.5000	300.0	400.0	12.70
A12513.0X315	–	13.00	0.5118	250.0	310.0	13.00
A12513.0X400	–	13.00	0.5118	300.0	400.0	13.00
A12517/32X315	17/32	13.49	0.5313	250.0	310.0	13.49
A12514.0X315	–	14.00	0.5512	250.0	310.0	14.00
A12514.0X400	–	14.00	0.5512	300.0	400.0	14.00
A1259/16X315	9/16	14.29	0.5625	250.0	310.0	14.29
A12537/64X315	37/64	14.68	0.5781	250.0	310.0	14.68
A12519/32X315	19/32	15.08	0.5938	250.0	310.0	15.08
A12519/32X500	19/32	15.08	0.5938	400.0	460.0	15.08
A1255/8X315	5/8	15.88	0.6250	250.0	310.0	15.88
A1255/8X500	5/8	15.88	0.6250	400.0	460.0	15.88
A12511/16X315	11/16	17.46	0.6875	250.0	310.0	17.46
A1253/4X315	3/4	19.05	0.7500	250.0	310.0	19.05
A1253/4X500	3/4	19.05	0.7500	400.0	460.0	19.05

R40C/R41C/R42C

PRECISION

NAS 907 Typ C HSS stubborr, ånganlöpt

Kraftig och mångsidig borrar med ånghärdad yta. En 135° självcentrerande spets minskar skärkrafterna och förhindrar att borrar glider när den kommer i kontakt med arbetsstycket. Det tjockare borret och den korta längden gör borrar mycket styv och lämplig för handhållen och maskinell borrar i många material.

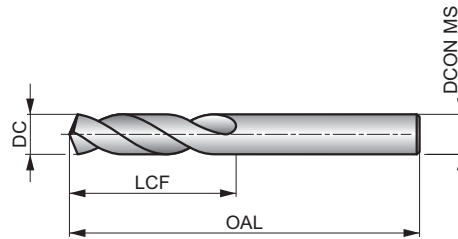

HSS	NAS 907	2.5xD
135°	ST	
λ 20-35°	R	

Arbetsmaterialgrupper och startvärden för skärhastighet (m/min) och matningskod. Tabeller med matningar finns med början på sidan 274

P1.1 ■ 36 J	P1.2 ■ 40 J	P1.3 ■ 41 J	P2.1 ■ 31 J	P2.2 ■ 27 G	P2.3 ■ 24 F	P3.1 ■ 21 G	P3.2 ■ 17 G	P3.3 ■ 14 F	P4.1 ■ 12 G	P4.2 ▣ 10 F	P4.3 ▣ 9 E	M1.1 ■ 22 F	M1.2 ■ 19 F
M2.1 ■ 20 F	M2.2 ■ 16 F	M3.1 ▣ 10 H	M3.2 ▣ 9 H	M3.3 ▣ 8 D	M4.1 ▣ 10 D	K1.1 ■ 32 J	K1.2 ■ 24 G	K1.3 ■ 18 G	K2.1 ■ 25 F	K2.2 ■ 20 F	K2.3 ■ 16 F	K3.1 ■ 22 F	K3.2 ■ 17 F
K3.3 ■ 13 F	K4.1 ■ 20 F	K4.2 ■ 15 F	K4.3 ▣ 11 F	K4.4 ▣ 10 F	K4.5 ▣ 8 F	K5.1 ■ 23 F	K5.2 ■ 17 F	K5.3 ▣ 13 F	N1.1 ▣ 33 K	N1.2 ▣ 25 K	N1.3 ▣ 17 J	N2.1 ▣ 46 I	N2.2 ▣ 42 I
N2.3 ▣ 30 I	N3.1 ▣ 64 I	N3.2 ▣ 38 J	N3.3 ▣ 19 H	N4.1 ▣ 30 K	N4.2 ▣ 35 I	N4.3 ▣ 17 G	S1.1 ■ 27 G	S1.2 ▣ 16 E	S1.3 ▣ 8 C	S2.1 ▣ 11 F	S2.2 ▣ 6 B	S3.1 ▣ 8 F	S3.2 ▣ 4 B
S4.1 ▣ 6 F	S4.2 ▣ 3 B												

Product	DC (inch)	DC (Wire gauge size)	DC (Letter size)	DC (inch)	LCF (inch)	OAL (inch)	DCON MS (inch)
R41CN60 ¹⁾	–	N60	–	0.0400	0.500	1.375	0.040
R41CN59 ¹⁾	–	N59	–	0.0410	0.500	1.375	0.041
R41CN58 ¹⁾	–	N58	–	0.0420	0.500	1.375	0.042
R41CN57 ¹⁾	–	N57	–	0.0430	0.500	1.375	0.043
R41CN56 ¹⁾	–	N56	–	0.0465	0.500	1.375	0.046
R41CN55 ¹⁾	–	N55	–	0.0520	0.625	1.625	0.052
R41CN54 ¹⁾	–	N54	–	0.0550	0.625	1.625	0.055
R41CN53 ¹⁾	–	N53	–	0.0595	0.625	1.625	0.059
R40C1/16	1/16	–	–	0.0625	0.625	1.625	0.063
R41CN52	–	N52	–	0.0635	0.688	1.688	0.064
R41CN51	–	N51	–	0.0670	0.688	1.688	0.067
R41CN50	–	N50	–	0.0700	0.688	1.688	0.070
R41CN49	–	N49	–	0.0730	0.688	1.688	0.073
R41CN48	–	N48	–	0.0760	0.688	1.688	0.076
R40C5/64	5/64	–	–	0.0781	0.688	1.688	0.078
R41CN47	–	N47	–	0.0785	0.688	1.688	0.079
R41CN46	–	N46	–	0.0810	0.750	1.750	0.081
R41CN45	–	N45	–	0.0820	0.750	1.750	0.082
R41CN44	–	N44	–	0.0860	0.750	1.750	0.086
R41CN43	–	N43	–	0.0890	0.750	1.750	0.089
R41CN42	–	N42	–	0.0935	0.750	1.750	0.093
R40C3/32	3/32	–	–	0.0938	0.750	1.750	0.094
R41CN41	–	N41	–	0.0960	0.813	1.813	0.096
R41CN40	–	N40	–	0.0980	0.813	1.813	0.098

Product	DC (inch)	DC (Wire gauge size)	DC (Letter size)	DC (inch)	LCF (inch)	OAL (inch)	DCON MS (inch)
R41CN39	–	N39	–	0.0995	0.813	1.813	0.100
R41CN38	–	N38	–	0.1015	0.813	1.813	0.102
R41CN37	–	N37	–	0.1040	0.813	1.813	0.104
R41CN36	–	N36	–	0.1065	0.813	1.813	0.106
R40C7/64	7/64	–	–	0.1094	0.813	1.813	0.109
R41CN35	–	N35	–	0.1100	0.875	1.875	0.110
R41CN34	–	N34	–	0.1110	0.875	1.875	0.111
R41CN33	–	N33	–	0.1130	0.875	1.875	0.113
R41CN32	–	N32	–	0.1160	0.875	1.875	0.116
R41CN31	–	N31	–	0.1200	0.875	1.875	0.120
R40C1/8	1/8	–	–	0.1250	0.875	1.875	0.125
R41CN30	–	N30	–	0.1285	0.938	1.938	0.129
R41CN29	–	N29	–	0.1360	0.938	1.938	0.136
R41CN28	–	N28	–	0.1405	0.938	1.938	0.141
R40C9/64	9/64	–	–	0.1406	0.938	1.938	0.141
R41CN27	–	N27	–	0.1440	1.000	2.063	0.144
R41CN26	–	N26	–	0.1470	1.000	2.063	0.147
R41CN25	–	N25	–	0.1495	1.000	2.063	0.149
R41CN24	–	N24	–	0.1520	1.000	2.063	0.152
R41CN23	–	N23	–	0.1540	1.000	2.063	0.154
R40C5/32	5/32	–	–	0.1563	1.000	2.063	0.156
R41CN22	–	N22	–	0.1570	1.063	2.125	0.157
R41CN21	–	N21	–	0.1590	1.063	2.125	0.159
R41CN20	–	N20	–	0.1610	1.063	2.125	0.161



Product	DC	DC	DC	DC	LCF	OAL	DCON MS
	(inch)	(Wire gauge size)	(Letter size)	(inch)	(inch)	(inch)	(inch)
R41CN19	–	N19	–	0.1660	1.063	2.125	0.166
R41CN18	–	N18	–	0.1695	1.063	2.125	0.170
R40C11/64	11/64	–	–	0.1719	1.063	2.125	0.172
R41CN17	–	N17	–	0.1730	1.125	2.188	0.173
R41CN16	–	N16	–	0.1770	1.125	2.188	0.177
R41CN15	–	N15	–	0.1800	1.125	2.188	0.180
R41CN14	–	N14	–	0.1820	1.125	2.188	0.182
R41CN13	–	N13	–	0.1850	1.125	2.188	0.185
R40C3/16	3/16	–	–	0.1875	1.125	2.188	0.188
R41CN12	–	N12	–	0.1890	1.188	2.250	0.189
R41CN11	–	N11	–	0.1910	1.188	2.250	0.191
R41CN10	–	N10	–	0.1935	1.188	2.250	0.194
R41CN9	–	N9	–	0.1960	1.188	2.250	0.196
R41CN8	–	N8	–	0.1990	1.188	2.250	0.199
R41CN7	–	N7	–	0.2010	1.188	2.250	0.201
R40C13/64	13/64	–	–	0.2031	1.188	2.250	0.203
R41CN6	–	N6	–	0.2040	1.250	2.375	0.204
R41CN5	–	N5	–	0.2055	1.250	2.375	0.205
R41CN4	–	N4	–	0.2090	1.250	2.375	0.209
R41CN3	–	N3	–	0.2130	1.250	2.375	0.213
R40C7/32	7/32	–	–	0.2188	1.250	2.375	0.219
R41CN2	–	N2	–	0.2210	1.313	2.438	0.221
R41CN1	–	N1	–	0.2280	1.313	2.438	0.228
R42CA	–	–	A	0.2340	1.313	2.438	0.234
R40C15/64	15/64	–	–	0.2344	1.313	2.438	0.234
R42CB	–	–	B	0.2380	1.375	2.500	0.238
R42CC	–	–	C	0.2420	1.375	2.500	0.242
R42CD	–	–	D	0.2460	1.375	2.500	0.246
R40C1/4	1/4	–	–	0.2500	1.375	2.500	0.250
R42CF	–	–	F	0.2570	1.438	2.625	0.257
R42CG	–	–	G	0.2610	1.438	2.625	0.261
R40C17/64	17/64	–	–	0.2656	1.438	2.625	0.266
R42CH	–	–	H	0.2660	1.500	2.688	0.266

¹⁾ Ingen korsspets.

Product	DC	DC	DC	DC	LCF	OAL	DCON MS
	(inch)	(Wire gauge size)	(Letter size)	(inch)	(inch)	(inch)	(inch)
R42CI	–	–	I	0.2720	1.500	2.688	0.272
R42CJ	–	–	J	0.2770	1.500	2.688	0.277
R42CK	–	–	K	0.2810	1.500	2.688	0.281
R40C9/32	9/32	–	–	0.2813	1.500	2.688	0.281
R42CM	–	–	M	0.2950	1.563	2.750	0.295
R40C19/64	19/64	–	–	0.2969	1.563	2.750	0.297
R42CL	–	–	L	0.2990	1.563	2.750	0.299
R42CN	–	–	N	0.3020	1.625	2.813	0.302
R40C5/16	5/16	–	–	0.3125	1.625	2.813	0.313
R42CO	–	–	O	0.3160	1.688	2.938	0.316
R42CP	–	–	P	0.3230	1.688	2.938	0.323
R40C21/64	21/64	–	–	0.3281	1.688	2.938	0.328
R42CQ	–	–	Q	0.3320	1.688	3.000	0.332
R42CR	–	–	R	0.3390	1.688	3.000	0.339
R40C11/32	11/32	–	–	0.3438	1.688	3.000	0.344
R42CS	–	–	S	0.3480	1.750	3.063	0.348
R42CT	–	–	T	0.3580	1.750	3.063	0.358
R40C23/64	23/64	–	–	0.3594	1.750	3.063	0.359
R42CU	–	–	U	0.3680	1.813	3.125	0.368
R40C3/8	3/8	–	–	0.3750	1.813	3.125	0.375
R42CV	–	–	V	0.3770	1.875	3.250	0.377
R42CW	–	–	W	0.3860	1.875	3.250	0.386
R40C25/64	25/64	–	–	0.3906	1.875	3.250	0.391
R42CX	–	–	X	0.3970	1.938	3.313	0.397
R42CY	–	–	Y	0.4040	1.938	3.313	0.404
R40C13/32	13/32	–	–	0.4063	1.938	3.313	0.406
R42CZ	–	–	Z	0.4130	2.000	3.375	0.413
R40C27/64	27/64	–	–	0.4219	2.000	3.375	0.422
R40C7/16	7/16	–	–	0.4375	2.063	3.438	0.438
R40C29/64	29/64	–	–	0.4531	2.125	3.563	0.453
R40C15/32	15/32	–	–	0.4688	2.125	3.625	0.469
R40C31/64	31/64	–	–	0.4844	2.188	3.688	0.484
R40C1/2	1/2	–	–	0.5000	2.250	3.750	0.500

R10A/R15A/R18A

PRECISION

NAS 907 Typ A HSS Joberborr, ånganlöp finish

Ett borr med mycket bra prestanda och 118° självcenterande korslipad spets för lättare penetration och låg tryckkraft. Ånghärdad yta för ökad slitstyrka och smörjförmåga. Tillverkad enligt NAS 907 typ A Aerospace-standard.

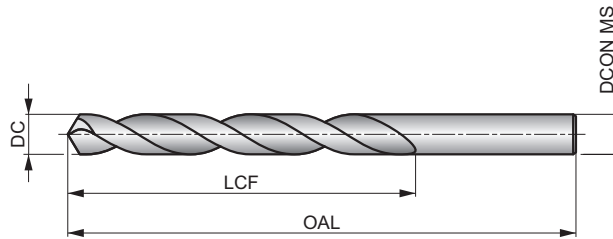

HSS	NAS 907	4×D
118°	ST	
λ 20-35°	R	

Arbetsmaterialgrupper och startvärden för skärhastighet (m/min) och matningskod. Tabeller med matningar finns med början på sidan 274

P1.1 ■ 36 H	P1.2 ■ 40 H	P1.3 ■ 41 H	P2.1 ■ 31 H	P2.2 ■ 27 G	P2.3 ■ 24 E	P3.1 ■ 25 F	P3.2 ■ 20 F	P3.3 ■ 17 E	P4.1 ■ 15 F	P4.2 ■ 13 E	P4.3 ■ 10 D	M1.1 ■ 30 E	M1.2 ■ 26 E
M2.1 ■ 27 E	M2.2 ■ 22 E	M2.3 ■ 18 C	M3.1 ■ 13 G	M3.2 ■ 11 G	M3.3 ■ 10 C	M4.1 ■ 15 C	M4.2 ■ 13 C	K1.1 ■ 35 H	K1.2 ■ 26 D	K1.3 ■ 19 D	K2.1 ■ 27 E	K2.2 ■ 22 E	K2.3 ■ 18 E
K3.1 ■ 24 E	K3.2 ■ 18 E	K3.3 ■ 15 E	K4.1 ■ 22 E	K4.2 ■ 17 E	K4.3 ■ 12 E	K4.4 ■ 11 E	K4.5 ■ 9 E	K5.1 ■ 25 E	K5.2 ■ 19 E	K5.3 ■ 15 E	N1.1 ■ 33 J	N1.2 ■ 25 J	N1.3 ■ 17 I
N2.1 ■ 46 H	N2.2 ■ 42 H	N2.3 ■ 30 H	N3.1 ■ 68 H	N3.2 ■ 40 F	N3.3 ■ 20 H	S1.1 ■ 28 F	S1.2 ■ 20 D	S1.3 ■ 11 C	S2.1 ■ 9 E	S2.2 ■ 8 B	S3.1 ■ 7 E	S3.2 ■ 6 B	S4.1 ■ 5 E
S4.2 ■ 5 B													

Product	DC (inch)	DC (Wire gauge size)	DC (Letter size)	DC (inch)	LCF (inch)	OAL (inch)	DCON MS (inch)
R10A1/16	1/16	—	—	0.0625	7/8	1.7/8	0.063
R18AN52	—	N52	—	0.0635	7/8	1.7/8	0.064
R18AN51	—	N51	—	0.0670	1"	2"	0.067
R18AN50	—	N50	—	0.0700	1"	2"	0.070
R18AN49	—	N49	—	0.0730	1"	2"	0.073
R18AN48	—	N48	—	0.0760	1"	2"	0.076
R10A5/64	5/64	—	—	0.0781	1"	2"	0.078
R18AN47	—	N47	—	0.0785	1"	2"	0.079
R18AN46	—	N46	—	0.0810	1.1/8	2.1/8	0.081
R18AN45	—	N45	—	0.0820	1.1/8	2.1/8	0.082
R18AN44	—	N44	—	0.0860	1.1/8	2.1/8	0.086
R18AN43	—	N43	—	0.0890	1.1/4	2.1/4	0.089
R18AN42	—	N42	—	0.0935	1.1/4	2.1/4	0.093
R10A3/32	3/32	—	—	0.0938	1.1/4	2.1/4	0.094
R18AN41	—	N41	—	0.0960	1.3/8	2.3/8	0.096
R18AN40	—	N40	—	0.0980	1.3/8	2.3/8	0.098
R18AN39	—	N39	—	0.0995	1.3/8	2.3/8	0.100
R18AN38	—	N38	—	0.1015	1.7/16	2.1/2	0.102
R18AN37	—	N37	—	0.1040	1.7/16	2.1/2	0.104
R18AN36	—	N36	—	0.1065	1.7/16	2.1/2	0.106
R10A7/64	7/64	—	—	0.1094	1.1/2	2.5/8	0.109
R18AN35	—	N35	—	0.1100	1.1/2	2.5/8	0.110
R18AN34	—	N34	—	0.1110	1.1/2	2.5/8	0.111
R18AN33	—	N33	—	0.1130	1.1/2	2.5/8	0.113

Product	DC (inch)	DC (Wire gauge size)	DC (Letter size)	DC (inch)	LCF (inch)	OAL (inch)	DCON MS (inch)
R18AN32	—	N32	—	0.1160	1.5/8	2.3/4	0.116
R18AN31	—	N31	—	0.1200	1.5/8	2.3/4	0.120
R10A1/8	1/8	—	—	0.1250	1.5/8	2.3/4	0.125
R18AN30	—	N30	—	0.1285	1.5/8	2.3/4	0.129
R18AN29	—	N29	—	0.1360	1.3/4	2.7/8	0.136
R18AN28	—	N28	—	0.1405	1.3/4	2.7/8	0.141
R10A9/64	9/64	—	—	0.1406	1.3/4	2.7/8	0.141
R18AN27	—	N27	—	0.1440	1.7/8	3"	0.144
R18AN26	—	N26	—	0.1470	1.7/8	3"	0.147
R18AN25	—	N25	—	0.1495	1.7/8	3"	0.149
R18AN24	—	N24	—	0.1520	2"	3.1/8	0.152
R18AN23	—	N23	—	0.1540	2"	3.1/8	0.154
R10A5/32	5/32	—	—	0.1563	2"	3.1/8	0.156
R18AN22	—	N22	—	0.1570	2"	3.1/8	0.157
R18AN21	—	N21	—	0.1590	2.1/8	3.1/4	0.159
R18AN20	—	N20	—	0.1610	2.1/8	3.1/4	0.161
R18AN19	—	N19	—	0.1660	2.1/8	3.1/4	0.166
R18AN18	—	N18	—	0.1695	2.1/8	3.1/4	0.170
R10A11/64	11/64	—	—	0.1719	2.1/8	3.1/4	0.172
R18AN17	—	N17	—	0.1730	2.3/16	3.3/8	0.173
R18AN16	—	N16	—	0.1770	2.3/16	3.3/8	0.177
R18AN15	—	N15	—	0.1800	2.3/16	3.3/8	0.180
R18AN14	—	N14	—	0.1820	2.3/16	3.3/8	0.182
R18AN13	—	N13	—	0.1850	2.5/16	3.1/2	0.185

Product	DC	DC	DC	DC	LCF	OAL	DCON MS
	(inch)	(Wire gauge size)	(Letter size)	(inch)	(inch)	(inch)	(inch)
R10A3/16	3/16	–	–	0.1875	2.5/16	3.1/2	0.188
R18AN12	–	N12	–	0.1890	2.5/16	3.1/2	0.189
R18AN11	–	N11	–	0.1910	2.5/16	3.1/2	0.191
R18AN10	–	N10	–	0.1935	2.7/16	3.5/8	0.194
R18AN9	–	N9	–	0.1960	2.7/16	3.5/8	0.196
R18AN8	–	N8	–	0.1990	2.7/16	3.5/8	0.199
R18AN7	–	N7	–	0.2010	2.7/16	3.5/8	0.201
R10A13/64	13/64	–	–	0.2031	2.7/16	3.5/8	0.203
R18AN6	–	N6	–	0.2040	2.1/2	3.3/4	0.204
R18AN5	–	N5	–	0.2055	2.1/2	3.3/4	0.205
R18AN4	–	N4	–	0.2090	2.1/2	3.3/4	0.209
R18AN3	–	N3	–	0.2130	2.1/2	3.3/4	0.213
R10A7/32	7/32	–	–	0.2188	2.1/2	3.3/4	0.219
R18AN2	–	N2	–	0.2210	2.5/8	3.7/8	0.221
R18AN1	–	N1	–	0.2280	2.5/8	3.7/8	0.228
R15AA	–	–	A	0.2340	2.5/8	3.7/8	0.234
R10A15/64	15/64	–	–	0.2344	2.5/8	3.7/8	0.234
R15AB	–	–	B	0.2380	2.3/4	4"	0.238
R15AC	–	–	C	0.2420	2.3/4	4"	0.242
R15AD	–	–	D	0.2460	2.3/4	4"	0.246
R10A1/4	1/4	–	–	0.2500	2.3/4	4"	0.250
R15AF	–	–	F	0.2570	2.7/8	4.1/8	0.257
R15AG	–	–	G	0.2610	2.7/8	4.1/8	0.261
R10A17/64	17/64	–	–	0.2656	2.7/8	4.1/8	0.266
R15AH	–	–	H	0.2660	2.7/8	4.1/8	0.266
R15AI	–	–	I	0.2720	2.7/8	4.1/8	0.272
R15AJ	–	–	J	0.2770	2.7/8	4.1/8	0.277
R15AK	–	–	K	0.2810	2.15/16	4.1/4	0.281
R10A9/32	9/32	–	–	0.2813	2.15/16	4.1/4	0.281

Product	DC	DC	DC	DC	LCF	OAL	DCON MS
	(inch)	(Wire gauge size)	(Letter size)	(inch)	(inch)	(inch)	(inch)
R15AL	–	–	L	0.2900	2.15/16	4.1/4	0.290
R15AM	–	–	M	0.2950	3.1/16	4.3/8	0.295
R10A19/64	19/64	–	–	0.2969	3.1/16	4.3/8	0.297
R15AN	–	–	N	0.3020	3.1/16	4.3/8	0.302
R10A5/16	5/16	–	–	0.3125	3.3/16	4.1/2	0.313
R15AO	–	–	O	0.3160	3.3/16	4.1/2	0.316
R15AP	–	–	P	0.3230	3.5/16	4.5/8	0.323
R10A21/64	21/64	–	–	0.3281	3.5/16	4.5/8	0.328
R15AQ	–	–	Q	0.3320	3.7/16	4.3/4	0.332
R15AR	–	–	R	0.3390	3.7/16	4.3/4	0.339
R10A11/32	11/32	–	–	0.3438	3.7/16	4.3/4	0.344
R15AS	–	–	S	0.3480	3.1/2	4.7/8	0.348
R15AT	–	–	T	0.3580	3.1/2	4.7/8	0.358
R10A23/64	23/64	–	–	0.3594	3.1/2	4.7/8	0.359
R15AU	–	–	U	0.3680	3.5/8	5"	0.368
R10A3/8	3/8	–	–	0.3750	3.5/8	5"	0.375
R15AV	–	–	V	0.3770	3.5/8	5"	0.377
R15AW	–	–	W	0.3860	3.3/4	5.1/8	0.386
R10A25/64	25/64	–	–	0.3906	3.3/4	5.1/8	0.391
R15AX	–	–	X	0.3970	3.3/4	5.1/8	0.397
R15AY	–	–	Y	0.4040	3.7/8	5.1/4	0.404
R10A13/32	13/32	–	–	0.4063	3.7/8	5.1/4	0.406
R15AZ	–	–	Z	0.4130	3.7/8	5.1/4	0.413
R10A27/64	27/64	–	–	0.4219	3.15/16	5.3/8	0.422
R10A7/16	7/16	–	–	0.4375	4.1/16	5.1/2	0.438
R10A29/64	29/64	–	–	0.4531	4.3/16	5.5/8	0.453
R10A15/32	15/32	–	–	0.4688	4.5/16	5.3/4	0.469
R10A31/64	31/64	–	–	0.4844	4.3/8	5.7/8	0.484
R10A1/2	1/2	–	–	0.5000	4.1/2	6"	0.500

R10B/R15B/R18B

PRECISION



NAS 907 Typ B HSS borrar, ånganlöpt

Kraftig borrar med Low Thrust 135° självcenterande spets för enklare penetration. Ånghärdad yta för ökad slitstyrka och smörjförmåga. Tillverkad enligt NAS 907 typ B standarder för flyg- och rymdindustrin.

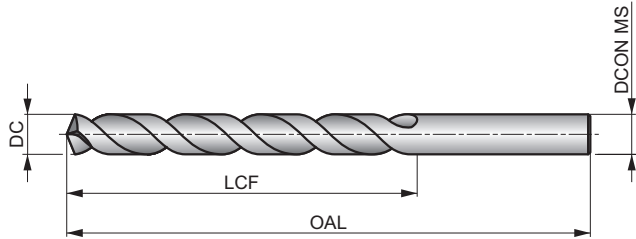

HSS	NAS 907	4×D
135°	ST	
λ 20-35°	R	

Arbetsmaterialgrupper och startvärden för skärhastighet (m/min) och matningskod. Tabeller med matningar finns med början på sidan 274

P1.1 ▣36 H	P1.2 ▣40 H	P1.3 ▣41 H	P2.1 ▣31 H	P2.2 ▣27 G	P2.3 ▣24 E	P3.1 ▣25 F	P3.2 ▣20 F	P3.3 ▣17 E	P4.1 ▣15 F	P4.2 ▣13 E	P4.3 ▣10 D	M1.1 ▣30 E	M1.2 ▣26 E
M2.1 ▣27 E	M2.2 ▣22 E	M2.3 ▣18 C	M3.1 ▣13 G	M3.2 ▣11 G	M3.3 ▣10 C	M4.1 ▣15 C	M4.2 ▣13 C	K1.1 ▣35 H	K1.2 ▣26 D	K1.3 ▣19 D	K2.1 ▣27 E	K2.2 ▣22 E	K2.3 ▣18 E
K3.1 ▣24 E	K3.2 ▣18 E	K3.3 ▣15 E	K4.1 ▣22 E	K4.2 ▣17 E	K4.3 ▣12 E	K4.4 ▣11 E	K4.5 ▣9 E	K5.1 ▣25 E	K5.2 ▣19 E	K5.3 ▣15 E	N1.1 ▣33 J	N1.2 ▣25 J	N1.3 ▣17 I
N2.1 ▣46 H	N2.2 ▣42 H	N2.3 ▣30 H	N3.1 ▣68 H	N3.2 ▣40 F	N3.3 ▣20 H	S1.1 ▣28 F	S1.2 ▣20 D	S1.3 ▣11 C	S2.1 ▣9 E	S2.2 ▣8 B	S3.1 ▣7 E	S3.2 ▣6 B	S4.1 ▣5 E
S4.2 ▣5 B													

Product	DC (inch)	DC (Wire gauge size)	DC (Letter size)	DC (inch)	LCF (inch)	OAL (inch)	DCON MS (inch)
R10B1/16	1/16	—	—	0.0625	7/8	1.7/8	0.063
R18BN52	—	N52	—	0.0635	7/8	1.7/8	0.064
R18BN51	—	N51	—	0.0670	1"	2"	0.067
R18BN50	—	N50	—	0.0700	1"	2"	0.070
R18BN49	—	N49	—	0.0730	1"	2"	0.073
R18BN48	—	N48	—	0.0760	1"	2"	0.076
R10B5/64	5/64	—	—	0.0781	1"	2"	0.078
R18BN47	—	N47	—	0.0785	1"	2"	0.079
R18BN46	—	N46	—	0.0810	1.1/8	2.1/8	0.081
R18BN45	—	N45	—	0.0820	1.1/8	2.1/8	0.082
R18BN44	—	N44	—	0.0860	1.1/8	2.1/8	0.086
R18BN43	—	N43	—	0.0890	1.1/4	2.1/4	0.089
R18BN42	—	N42	—	0.0935	1.1/4	2.1/4	0.093
R10B3/32	3/32	—	—	0.0938	1.1/4	2.1/4	0.094
R18BN41	—	N41	—	0.0960	1.3/8	2.3/8	0.096
R18BN40	—	N40	—	0.0980	1.3/8	2.3/8	0.098
R18BN39	—	N39	—	0.0995	1.3/8	2.3/8	0.100
R18BN38	—	N38	—	0.1015	1.7/16	2.1/2	0.102
R18BN37	—	N37	—	0.1040	1.7/16	2.1/2	0.104
R18BN36	—	N36	—	0.1065	1.7/16	2.1/2	0.106
R10B7/64	7/64	—	—	0.1094	1.1/2	2.5/8	0.109
R18BN35	—	N35	—	0.1100	1.1/2	2.5/8	0.110
R18BN34	—	N34	—	0.1110	1.1/2	2.5/8	0.111
R18BN33	—	N33	—	0.1130	1.1/2	2.5/8	0.113

Product	DC (inch)	DC (Wire gauge size)	DC (Letter size)	DC (inch)	LCF (inch)	OAL (inch)	DCON MS (inch)
R18BN32	—	N32	—	0.1160	1.5/8	2.3/4	0.116
R18BN31	—	N31	—	0.1200	1.5/8	2.3/4	0.120
R10B1/8	1/8	—	—	0.1250	1.5/8	2.3/4	0.125
R18BN30	—	N30	—	0.1285	1.5/8	2.3/4	0.129
R18BN29	—	N29	—	0.1360	1.3/4	2.7/8	0.136
R18BN28	—	N28	—	0.1405	1.3/4	2.7/8	0.141
R10B9/64	9/64	—	—	0.1406	1.3/4	2.7/8	0.141
R18BN27	—	N27	—	0.1440	1.7/8	3"	0.144
R18BN26	—	N26	—	0.1470	1.7/8	3"	0.147
R18BN25	—	N25	—	0.1495	1.7/8	3"	0.149
R18BN24	—	N24	—	0.1520	2"	3.1/8	0.152
R18BN23	—	N23	—	0.1540	2"	3.1/8	0.154
R10B5/32	5/32	—	—	0.1563	2"	3.1/8	0.156
R18BN22	—	N22	—	0.1570	2"	3.1/8	0.157
R18BN21	—	N21	—	0.1590	2.1/8	3.1/4	0.159
R18BN20	—	N20	—	0.1610	2.1/8	3.1/4	0.161
R18BN19	—	N19	—	0.1660	2.1/8	3.1/4	0.166
R18BN18	—	N18	—	0.1695	2.1/8	3.1/4	0.170
R10B11/64	11/64	—	—	0.1719	2.1/8	3.1/4	0.172
R18BN17	—	N17	—	0.1730	2.3/16	3.3/8	0.173
R18BN16	—	N16	—	0.1770	2.3/16	3.3/8	0.177
R18BN15	—	N15	—	0.1800	2.3/16	3.3/8	0.180
R18BN14	—	N14	—	0.1820	2.3/16	3.3/8	0.182
R18BN13	—	N13	—	0.1850	2.5/16	3.1/2	0.185



Product	DC	DC	DC	DC	LCF	OAL	DCON
	(inch)	(Wire gauge size)	(Letter size)	(inch)	(inch)	(inch)	MS (inch)
R10B3/16	3/16	–	–	0.1875	2.5/16	3.1/2	0.188
R18BN12	–	N12	–	0.1890	2.5/16	3.1/2	0.189
R18BN11	–	N11	–	0.1910	2.5/16	3.1/2	0.191
R18BN10	–	N10	–	0.1935	2.7/16	3.5/8	0.194
R18BN9	–	N9	–	0.1960	2.7/16	3.5/8	0.196
R18BN8	–	N8	–	0.1990	2.7/16	3.5/8	0.199
R18BN7	–	N7	–	0.2010	2.7/16	3.5/8	0.201
R10B13/64	13/64	–	–	0.2031	2.7/16	3.5/8	0.203
R18BN6	–	N6	–	0.2040	2.1/2	3.3/4	0.204
R18BN5	–	N5	–	0.2055	2.1/2	3.3/4	0.205
R18BN4	–	N4	–	0.2090	2.1/2	3.3/4	0.209
R18BN3	–	N3	–	0.2130	2.1/2	3.3/4	0.213
R10B7/32	7/32	–	–	0.2188	2.1/2	3.3/4	0.219
R18BN2	–	N2	–	0.2210	2.5/8	3.7/8	0.221
R18BN1	–	N1	–	0.2280	2.5/8	3.7/8	0.228
R15BA	–	–	A	0.2340	2.5/8	3.7/8	0.234
R10B15/64	15/64	–	–	0.2344	2.5/8	3.7/8	0.234
R15BB	–	–	B	0.2380	2.3/4	4"	0.238
R15BC	–	–	C	0.2420	2.3/4	4"	0.242
R15BD	–	–	D	0.2460	2.3/4	4"	0.246
R10B1/4	1/4	–	–	0.2500	2.3/4	4"	0.250
R15BF	–	–	F	0.2570	2.7/8	4.1/8	0.257
R15BG	–	–	G	0.2610	2.7/8	4.1/8	0.261
R10B17/64	17/64	–	–	0.2656	2.7/8	4.1/8	0.266
R15BH	–	–	H	0.2660	2.7/8	4.1/8	0.266
R15BI	–	–	I	0.2720	2.7/8	4.1/8	0.272
R15BJ	–	–	J	0.2770	2.7/8	4.1/8	0.277
R15BK	–	–	K	0.2810	2.15/16	4.1/4	0.281
R10B9/32	9/32	–	–	0.2813	2.15/16	4.1/4	0.281

Product	DC	DC	DC	DC	LCF	OAL	DCON
	(inch)	(Wire gauge size)	(Letter size)	(inch)	(inch)	(inch)	MS (inch)
R15BL	–	–	L	0.2900	2.15/16	4.1/4	0.290
R15BM	–	–	M	0.2950	3.1/16	4.3/8	0.295
R10B19/64	19/64	–	–	0.2969	3.1/16	4.3/8	0.297
R15BN	–	–	N	0.3020	3.1/16	4.3/8	0.302
R10B5/16	5/16	–	–	0.3125	3.3/16	4.1/2	0.313
R15B0	–	–	O	0.3160	3.3/16	4.1/2	0.316
R15BP	–	–	P	0.3230	3.5/16	4.5/8	0.323
R10B21/64	21/64	–	–	0.3281	3.5/16	4.5/8	0.328
R15BQ	–	–	Q	0.3320	3.7/16	4.3/4	0.332
R15BR	–	–	R	0.3390	3.7/16	4.3/4	0.339
R10B11/32	11/32	–	–	0.3438	3.7/16	4.3/4	0.344
R15BS	–	–	S	0.3480	3.1/2	4.7/8	0.348
R15BT	–	–	T	0.3580	3.1/2	4.7/8	0.358
R10B23/64	23/64	–	–	0.3594	3.1/2	4.7/8	0.359
R15BU	–	–	U	0.3680	3.5/8	5"	0.368
R10B3/8	3/8	–	–	0.3750	3.5/8	5"	0.375
R15BV	–	–	V	0.3770	3.5/8	5"	0.377
R15BW	–	–	W	0.3860	3.3/4	5.1/8	0.386
R10B25/64	25/64	–	–	0.3906	3.3/4	5.1/8	0.391
R15BX	–	–	X	0.3970	3.3/4	5.1/8	0.397
R15BY	–	–	Y	0.4040	3.7/8	5.1/4	0.404
R10B13/32	13/32	–	–	0.4063	3.7/8	5.1/4	0.406
R15BZ	–	–	Z	0.4130	3.7/8	5.1/4	0.413
R10B27/64	27/64	–	–	0.4219	3.15/16	5.3/8	0.422
R10B7/16	7/16	–	–	0.4375	4.1/16	5.1/2	0.438
R10B29/64	29/64	–	–	0.4531	4.3/16	5.5/8	0.453
R10B15/32	15/32	–	–	0.4688	4.5/16	5.3/4	0.469
R10B31/64	31/64	–	–	0.4844	4.3/8	5.7/8	0.484
R10B1/2	1/2	–	–	0.5000	4.1/2	6"	0.500

500-6/501-6/502-6

PRECISION



NAS 907 typ B HSS förlängningsborr för flygplan, 6" OAL

Borrar tillverkade enligt National Aerospace Standards med lång totallängd i kombination med kort skärlängd gör den idealisk för borrar i svåråtkomliga områden. Den 135° självcenterande spetsen och ånganlöpta ytfinishen gör den lämplig för borrar i de flesta material.

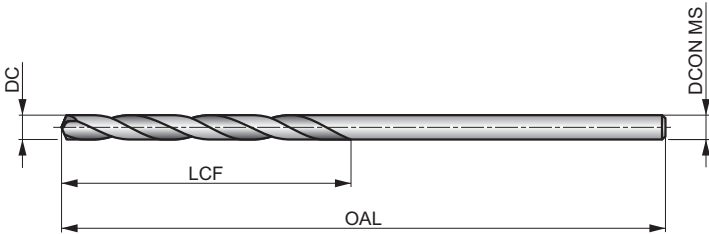

HSS	NAS 907	4xD
135°	ST	
λ 20-35°	R	

Arbetsmaterialgrupper och startvärden för skärhastighet (m/min) och matningskod. Tabeller med matningar finns med början på sidan 274

P2.2 ■ 25 F	P2.3 ■ 22 E	P3.1 ■ 19 F	P3.2 ■ 15 F	P3.3 ■ 13 E	P4.1 ■ 11 F	P4.2 ■ 10 E	P4.3 ■ 8 D	M1.1 ■ 21 E	M1.2 ■ 17 E	M2.1 ■ 18 E	M2.2 ■ 15 E	M3.1 ■ 9 G	M3.2 ■ 8 G
M3.3 ■ 7 C	M4.1 ■ 9 C	K1.1 ■ 30 I	K1.2 ■ 22 F	K1.3 ■ 17 F	K2.1 ■ 25 E	K2.2 ■ 20 E	K2.3 ■ 16 E	K3.1 ■ 22 E	K3.2 ■ 17 E	K3.3 ■ 13 E	K4.1 ■ 20 E	K4.2 ■ 15 E	K4.3 ■ 11 E
K4.4 ■ 10 E	K4.5 ■ 8 E	K5.1 ■ 23 E	K5.2 ■ 17 E	K5.3 ■ 13 E	N2.2 ■ 27 G	N2.3 ■ 24 F	N3.1 ■ 27 H	N3.2 ■ 21 H	N3.3 ■ 16 G	S1.1 ■ 23 F	S1.2 ■ 12 D	S1.3 ■ 6 B	S2.1 ■ 8 E
S2.2 ■ 4 A	S3.1 ■ 6 E	S3.2 ■ 3 A	S4.1 ■ 5 E	S4.2 ■ 2 A									

Product	DC (inch)	DC (Wire gauge size)	DC (Letter size)	DC (inch)	LCF (inch)	OAL (inch)	DCON MS (inch)
501-6N60 ¹⁾	-	N60	-	0.0400	11/16	6"	0.040
501-6N59 ¹⁾	-	N59	-	0.0410	11/16	6"	0.041
501-6N58 ¹⁾	-	N58	-	0.0420	11/16	6"	0.042
501-6N57 ¹⁾	-	N57	-	0.0430	3/4	6"	0.043
501-6N56 ¹⁾	-	N56	-	0.0465	3/4	6"	0.046
500-63/64 ¹⁾	3/64	-	-	0.0469	3/4	6"	0.047
501-6N55 ¹⁾	-	N55	-	0.0520	7/8	6"	0.052
501-6N54 ¹⁾	-	N54	-	0.0550	7/8	6"	0.055
501-6N53 ¹⁾	-	N53	-	0.0595	7/8	6"	0.059
500-61/16	1/16	-	-	0.0625	7/8	6"	0.063
501-6N52	-	N52	-	0.0635	7/8	6"	0.064
501-6N51	-	N51	-	0.0670	1"	6"	0.067
501-6N50	-	N50	-	0.0700	1"	6"	0.070
501-6N49	-	N49	-	0.0730	1"	6"	0.073
501-6N48	-	N48	-	0.0760	1"	6"	0.076
500-65/64	5/64	-	-	0.0781	1"	6"	0.078
501-6N47	-	N47	-	0.0785	1"	6"	0.079
501-6N46	-	N46	-	0.0810	1.1/8	6"	0.081
501-6N45	-	N45	-	0.0820	1.1/8	6"	0.082
501-6N44	-	N44	-	0.0860	1.1/8	6"	0.086
501-6N43	-	N43	-	0.0890	1.1/4	6"	0.089
501-6N42	-	N42	-	0.0935	1.1/4	6"	0.093
500-63/32	3/32	-	-	0.0938	1.1/4	6"	0.094
501-6N41	-	N41	-	0.0960	1.3/8	6"	0.096
501-6N40	-	N40	-	0.0980	1.3/8	6"	0.098
501-6N39	-	N39	-	0.0995	1.3/8	6"	0.100

Product	DC (inch)	DC (Wire gauge size)	DC (Letter size)	DC (inch)	LCF (inch)	OAL (inch)	DCON MS (inch)
501-6N38	-	N38	-	0.1015	1.7/16	6"	0.102
501-6N37	-	N37	-	0.1040	1.7/16	6"	0.104
501-6N36	-	N36	-	0.1065	1.7/16	6"	0.106
500-67/64	7/64	-	-	0.1094	1.1/2	6"	0.109
501-6N35	-	N35	-	0.1100	1.1/2	6"	0.110
501-6N34	-	N34	-	0.1110	1.1/2	6"	0.111
501-6N33	-	N33	-	0.1130	1.1/2	6"	0.113
501-6N32	-	N32	-	0.1160	1.5/8	6"	0.116
501-6N31	-	N31	-	0.1200	1.5/8	6"	0.120
500-61/8	1/8	-	-	0.1250	1.5/8	6"	0.125
501-6N30	-	N30	-	0.1285	1.5/8	6"	0.129
501-6N29	-	N29	-	0.1360	1.3/4	6"	0.136
501-6N28	-	N28	-	0.1405	1.3/4	6"	0.141
500-69/64	9/64	-	-	0.1406	1.3/4	6"	0.141
501-6N27	-	N27	-	0.1440	1.7/8	6"	0.144
501-6N26	-	N26	-	0.1470	1.7/8	6"	0.147
501-6N25	-	N25	-	0.1495	1.7/8	6"	0.149
501-6N24	-	N24	-	0.1520	2"	6"	0.152
501-6N23	-	N23	-	0.1540	2"	6"	0.154
500-65/32	5/32	-	-	0.1563	2"	6"	0.156
501-6N22	-	N22	-	0.1570	2"	6"	0.157
501-6N21	-	N21	-	0.1590	2.1/8	6"	0.159
501-6N20	-	N20	-	0.1610	2.1/8	6"	0.161
501-6N19	-	N19	-	0.1660	2.1/8	6"	0.166
501-6N18	-	N18	-	0.1695	2.1/8	6"	0.170
500-611/64	11/64	-	-	0.1719	2.1/8	6"	0.172



Product	DC	DC	DC	DC	LCF	OAL	DCON
	(inch)	(Wire gauge size)	(Letter size)	(inch)	(inch)	(inch)	MS (inch)
501-6N17	–	N17	–	0.1730	2.3/16	6"	0.173
501-6N16	–	N16	–	0.1770	2.3/16	6"	0.177
501-6N15	–	N15	–	0.1800	2.3/16	6"	0.180
501-6N14	–	N14	–	0.1820	2.3/16	6"	0.182
501-6N13	–	N13	–	0.1850	2.5/16	6"	0.185
500-63/16	3/16	–	–	0.1875	2.5/16	6"	0.188
501-6N12	–	N12	–	0.1890	2.5/16	6"	0.189
501-6N11	–	N11	–	0.1910	2.5/16	6"	0.191
501-6N10	–	N10	–	0.1935	2.7/16	6"	0.194
501-6N9	–	N9	–	0.1960	2.7/16	6"	0.196
501-6N8	–	N8	–	0.1990	2.7/16	6"	0.199
501-6N7	–	N7	–	0.2010	2.7/16	6"	0.201
500-613/64	13/64	–	–	0.2031	2.7/16	6"	0.203
501-6N6	–	N6	–	0.2040	2.1/2	6"	0.204
501-6N5	–	N5	–	0.2055	2.1/2	6"	0.205
501-6N4	–	N4	–	0.2090	2.1/2	6"	0.209
501-6N3	–	N3	–	0.2130	2.1/2	6"	0.213
500-67/32	7/32	–	–	0.2188	2.1/2	6"	0.219
501-6N2	–	N2	–	0.2210	2.5/8	6"	0.221
501-6N1	–	N1	–	0.2280	2.5/8	6"	0.228
502-6A	–	–	A	0.2340	2.5/8	6"	0.234
500-615/64	15/64	–	–	0.2344	2.5/8	6"	0.234
502-6B	–	–	B	0.2380	2.3/4	6"	0.238
502-6C	–	–	C	0.2420	2.3/4	6"	0.242
502-6D	–	–	D	0.2460	2.3/4	6"	0.246
500-61/4	1/4	–	–	0.2500	2.3/4	6"	0.250
502-6F	–	–	F	0.2570	2.7/8	6"	0.257
502-6G	–	–	G	0.2610	2.7/8	6"	0.261
500-617/64	17/64	–	–	0.2656	2.7/8	6"	0.266
502-6H	–	–	H	0.2660	2.7/8	6"	0.266
502-6I	–	–	I	0.2720	2.7/8	6"	0.272
502-6J	–	–	J	0.2770	2.7/8	6"	0.277

¹⁾ Ingen korsspets.

Product	DC	DC	DC	DC	LCF	OAL	DCON
	(inch)	(Wire gauge size)	(Letter size)	(inch)	(inch)	(inch)	MS (inch)
502-6K	–	–	K	0.2810	2.15/16	6"	0.281
500-69/32	9/32	–	–	0.2813	2.15/16	6"	0.281
502-6L	–	–	L	0.2900	2.15/16	6"	0.290
502-6M	–	–	M	0.2950	3.1/16	6"	0.295
500-619/64	19/64	–	–	0.2969	3.1/16	6"	0.297
502-6N	–	–	N	0.3020	3.1/16	6"	0.302
500-65/16	5/16	–	–	0.3125	3.3/16	6"	0.313
502-6O	–	–	O	0.3160	3.3/16	6"	0.316
502-6P	–	–	P	0.3230	3.5/16	6"	0.323
500-621/64	21/64	–	–	0.3281	3.5/16	6"	0.328
502-6Q	–	–	Q	0.3320	3.7/16	6"	0.332
502-6R	–	–	R	0.3390	3.7/16	6"	0.339
500-611/32	11/32	–	–	0.3438	3.7/16	6"	0.344
502-6S	–	–	S	0.3480	3.1/2	6"	0.348
502-6T	–	–	T	0.3580	3.1/2	6"	0.358
500-623/64	23/64	–	–	0.3594	3.1/2	6"	0.359
502-6U	–	–	U	0.3680	3.5/8	6"	0.368
500-63/8	3/8	–	–	0.3750	3.5/8	6"	0.375
502-6V	–	–	V	0.3772	3.5/8	6"	0.377
502-6W	–	–	W	0.3860	3.3/4	6"	0.386
500-625/64	25/64	–	–	0.3906	3.3/4	6"	0.391
502-6X	–	–	X	0.3970	3.3/4	6"	0.397
502-6Y	–	–	Y	0.4040	3.7/8	6"	0.404
500-613/32	13/32	–	–	0.4063	3.7/8	6"	0.406
502-6Z	–	–	Z	0.4130	3.7/8	6"	0.413
500-627/64	27/64	–	–	0.4219	3.15/16	6"	0.422
500-67/16	7/16	–	–	0.4375	4.1/16	6"	0.438
500-629/64	29/64	–	–	0.4531	4.3/16	6"	0.453
500-615/32	15/32	–	–	0.4688	4.5/16	6"	0.469
500-631/64	31/64	–	–	0.4844	4.3/8	6"	0.484
500-61/2	1/2	–	–	0.5000	4.1/2	6"	0.500

500-12/501-12/502-12

PRECISION

NAS 907 typ B HSS förlängningsborr för flygplan, 12" OAL

Extra långa serieborrar tillverkade enligt National Aerospace Standards med extra lång totalängd i kombination med kort skärlängd gör dem idealiska för borring i svåråtkomliga områden. Den 135° självcentrerande korsspetsen och ånghärdade ytfinnisen gör den lämplig för borring i de flesta material.

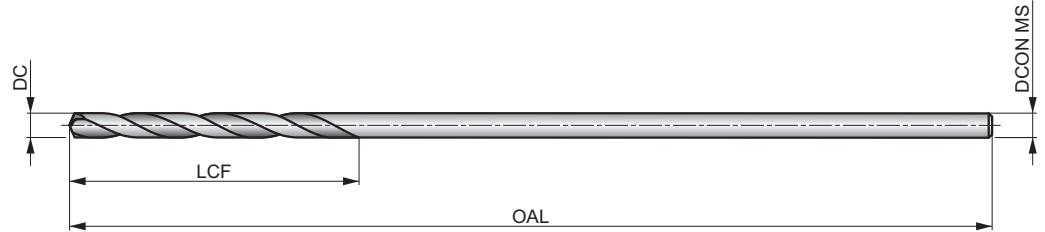

HSS	NAS 907	4xD
135°	ST	
λ 20-35°	R	

Arbetsmaterialgrupper och startvärden för skärhastighet (m/min) och matningskod. Tabeller med matningar finns med början på sidan 274

P2.2 ■ 25 F	P2.3 ■ 22 E	P3.1 ■ 19 F	P3.2 ■ 15 F	P3.3 ■ 13 E	P4.1 ■ 11 F	P4.2 ■ 10 E	P4.3 ■ 8 D	M1.1 ■ 21 E	M1.2 ■ 17 E	M2.1 ■ 18 E	M2.2 ■ 15 E	M3.1 ■ 9 G	M3.2 ■ 8 G
M3.3 ■ 7 C	M4.1 ■ 9 C	K1.1 ■ 30 I	K1.2 ■ 22 F	K1.3 ■ 17 F	K2.1 ■ 25 E	K2.2 ■ 20 E	K2.3 ■ 16 E	K3.1 ■ 22 E	K3.2 ■ 17 E	K3.3 ■ 13 E	K4.1 ■ 20 E	K4.2 ■ 15 E	K4.3 ■ 11 E
K4.4 ■ 10 E	K4.5 ■ 8 E	K5.1 ■ 23 E	K5.2 ■ 17 E	K5.3 ■ 13 E	N2.2 ■ 27 G	N2.3 ■ 24 F	N3.1 ■ 27 H	N3.2 ■ 21 H	N3.3 ■ 16 G	S1.1 ■ 23 F	S1.2 ■ 12 D	S1.3 ■ 6 B	S2.1 ■ 8 E
S2.2 ■ 4 A	S3.1 ■ 6 E	S3.2 ■ 3 A	S4.1 ■ 5 E	S4.2 ■ 2 A									

Product	DC	DC	DC	DC	LCF	OAL	DCON MS
	(inch)	(Wire gauge size)	(Letter size)	(inch)	(inch)	(inch)	(inch)
500-123/64	3/64	-	-	0.0469	3/4	12"	0.047
500-121/16	1/16	-	-	0.0625	7/8	12"	0.063
501-12N50	-	N50	-	0.0700	1"	12"	0.070
501-12N49	-	N49	-	0.0730	1"	12"	0.073
500-125/64	5/64	-	-	0.0781	1"	12"	0.078
501-12N47	-	N47	-	0.0785	1"	12"	0.079
501-12N46	-	N46	-	0.0810	1.1/8	12"	0.081
501-12N45	-	N45	-	0.0820	1.1/8	12"	0.082
501-12N44	-	N44	-	0.0860	1.1/8	12"	0.086
501-12N43	-	N43	-	0.0890	1.1/4	12"	0.089
501-12N42	-	N42	-	0.0935	1.1/4	12"	0.093
500-123/32	3/32	-	-	0.0938	1.1/4	12"	0.094
501-12N41	-	N41	-	0.0960	1.3/8	12"	0.096
501-12N40	-	N40	-	0.0980	1.3/8	12"	0.098
501-12N37	-	N37	-	0.1040	1.7/16	12"	0.104
501-12N36	-	N36	-	0.1065	1.7/16	12"	0.106
500-127/64	7/64	-	-	0.1094	1.1/2	12"	0.109
501-12N31	-	N31	-	0.1200	1.5/8	12"	0.120
500-121/8	1/8	-	-	0.1250	1.5/8	12"	0.125
501-12N30	-	N30	-	0.1285	1.5/8	12"	0.129
501-12N29	-	N29	-	0.1360	1.3/4	12"	0.136
500-129/64	9/64	-	-	0.1406	1.3/4	12"	0.141
501-12N27	-	N27	-	0.1440	1.7/8	12"	0.144
501-12N26	-	N26	-	0.1470	1.7/8	12"	0.147
501-12N25	-	N25	-	0.1495	1.7/8	12"	0.149
501-12N23	-	N23	-	0.1540	2"	12"	0.154

Product	DC	DC	DC	DC	LCF	OAL	DCON MS
	(inch)	(Wire gauge size)	(Letter size)	(inch)	(inch)	(inch)	(inch)
500-125/32	5/32	-	-	0.1563	2"	12"	0.156
501-12N22	-	N22	-	0.1570	2"	12"	0.157
501-12N21	-	N21	-	0.1590	2.1/8	12"	0.159
501-12N20	-	N20	-	0.1610	2.1/8	12"	0.161
501-12N19	-	N19	-	0.1660	2.1/8	12"	0.166
501-12N18	-	N18	-	0.1695	2.1/8	12"	0.170
500-1211/64	11/64	-	-	0.1719	2.1/8	12"	0.172
501-12N17	-	N17	-	0.1730	2.3/16	12"	0.173
501-12N16	-	N16	-	0.1770	2.3/16	12"	0.177
501-12N13	-	N13	-	0.1850	2.5/16	12"	0.185
500-123/16	3/16	-	-	0.1875	2.5/16	12"	0.188
501-12N12	-	N12	-	0.1890	2.5/16	12"	0.189
501-12N11	-	N11	-	0.1910	2.5/16	12"	0.191
501-12N10	-	N10	-	0.1935	2.7/16	12"	0.194
501-12N9	-	N9	-	0.1960	2.7/16	12"	0.196
501-12N7	-	N7	-	0.2010	2.7/16	12"	0.201
500-1213/64	13/64	-	-	0.2031	2.7/16	12"	0.203
501-12N5	-	N5	-	0.2055	2.1/2	12"	0.205
501-12N4	-	N4	-	0.2090	2.1/2	12"	0.209
501-12N3	-	N3	-	0.2130	2.1/2	12"	0.213
500-127/32	7/32	-	-	0.2188	2.1/2	12"	0.219
501-12N1	-	N1	-	0.2280	2.5/8	12"	0.228
502-12A	-	-	A	0.2340	2.5/8	12"	0.234
500-1215/64	15/64	-	-	0.2344	2.5/8	12"	0.234
502-12B	-	-	B	0.2380	2.3/4	12"	0.238
502-12C	-	-	C	0.2420	2.3/4	12"	0.242



Product	DC	DC	DC	DC	LCF	OAL	DCON MS
	(inch)	(Wire gauge size)	(Letter size)	(inch)	(inch)	(inch)	(inch)
502-12D	–	–	D	0.2460	2.3/4	12"	0.246
500-121/4	1/4	–	–	0.2500	2.3/4	12"	0.250
502-12F	–	–	F	0.2570	2.7/8	12"	0.257
502-12G	–	–	G	0.2610	2.7/8	12"	0.261
500-1217/64	17/64	–	–	0.2656	2.7/8	12"	0.266
502-12H	–	–	H	0.2660	2.7/8	12"	0.266
502-12I	–	–	I	0.2720	2.7/8	12"	0.272
502-12J	–	–	J	0.2770	2.7/8	12"	0.277
502-12K	–	–	K	0.2810	2.15/16	12"	0.281
500-129/32	9/32	–	–	0.2813	2.15/16	12"	0.281
502-12L	–	–	L	0.2900	2.15/16	12"	0.290
502-12M	–	–	M	0.2950	3.1/16	12"	0.295
500-1219/64	19/64	–	–	0.2969	3.1/16	12"	0.297
502-12N	–	–	N	0.3020	3.1/16	12"	0.302
500-125/16	5/16	–	–	0.3125	3.3/16	12"	0.313
502-12O	–	–	O	0.3160	3.3/16	12"	0.316
502-12P	–	–	P	0.3230	3.5/16	12"	0.323
500-1221/64	21/64	–	–	0.3281	3.5/16	12"	0.328
502-12Q	–	–	Q	0.3320	3.7/16	12"	0.332
502-12R	–	–	R	0.3390	3.7/16	12"	0.339

Product	DC	DC	DC	DC	LCF	OAL	DCON MS
	(inch)	(Wire gauge size)	(Letter size)	(inch)	(inch)	(inch)	(inch)
500-1211/32	11/32	–	–	0.3438	3.7/16	12"	0.344
502-12S	–	–	S	0.3480	3.1/2	12"	0.348
502-12T	–	–	T	0.3580	3.1/2	12"	0.358
500-1223/64	23/64	–	–	0.3594	3.1/2	12"	0.359
502-12U	–	–	U	0.3680	3.5/8	12"	0.368
500-123/8	3/8	–	–	0.3750	3.5/8	12"	0.375
502-12V	–	–	V	0.3770	3.5/8	12"	0.377
502-12W	–	–	W	0.3860	3.3/4	12"	0.386
500-1225/64	25/64	–	–	0.3906	3.3/4	12"	0.391
502-12X	–	–	X	0.3970	3.3/4	12"	0.397
502-12Y	–	–	Y	0.4040	3.7/8	12"	0.404
500-1213/32	13/32	–	–	0.4063	3.7/8	12"	0.406
502-12Z	–	–	Z	0.4130	3.7/8	12"	0.413
500-1227/64	27/64	–	–	0.4219	3.15/16	12"	0.422
500-127/16	7/16	–	–	0.4375	4.1/16	12"	0.438
500-1229/64	29/64	–	–	0.4531	4.3/16	12"	0.453
500-1215/32	15/32	–	–	0.4688	4.5/16	12"	0.469
500-1231/64	31/64	–	–	0.4844	4.3/8	12"	0.484
500-121/2	1/2	–	–	0.5000	4.1/2	12"	0.500

R88CO/R89CO

PRECISION

NAS 907 typ D HSS-E (8%) kobolt för tung användning

En avverkningsborr med kortare spårlängd och längre skaft för högre styvhet. Utmärkt borrar när mer räckvidd krävs för borrar av grunda hål eller tunnare material. Bronshärdad ytfinish med 135° självcenterande delningsspets med låg dragkraft för enklare penetration. Tillverkad enligt NAS 907 typ D standarder för flyg- och rymdindustrin.



HSS-E	NAS 907	3xD

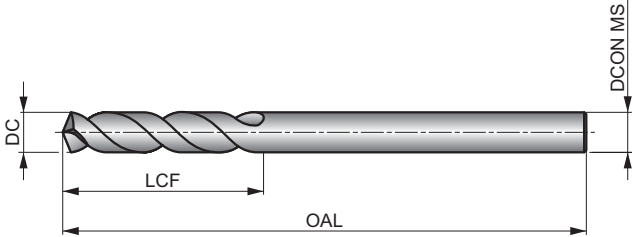

Arbetsmaterialgrupper och startvärden för skärhastighet (m/min) och matningskod. Tabeller med matningar finns med början på sidan 274

P1.1 ■ 36 H	P1.2 ■ 40 H	P1.3 ■ 41 H	P2.1 ■ 31 H	P2.2 ■ 27 G	P2.3 ■ 24 E	P3.1 ■ 25 F	P3.2 ■ 20 F	P3.3 ■ 17 E	P4.1 ■ 15 F	P4.2 ■ 13 E	P4.3 ■ 10 D	M1.1 ■ 30 E	M1.2 ■ 26 E
M2.1 ■ 27 E	M2.2 ■ 22 E	M2.3 ■ 18 C	M3.1 ■ 13 G	M3.2 ■ 11 G	M3.3 ■ 10 C	M4.1 ■ 15 C	K1.1 ■ 35 H	K1.2 ■ 26 D	K1.3 ■ 19 D	K2.1 ■ 27 E	K2.2 ■ 22 E	K2.3 ■ 18 E	K3.1 ■ 24 E
K3.2 ■ 18 E	K3.3 ■ 15 E	K4.1 ■ 22 E	K4.2 ■ 17 E	K4.3 ■ 12 E	K4.4 ■ 11 E	K4.5 ■ 9 E	K5.1 ■ 25 E	K5.2 ■ 19 E	K5.3 ■ 15 E	N1.1 ■ 33 J	N1.2 ■ 25 J	N1.3 ■ 17 I	N2.1 ■ 46 H
N2.2 ■ 42 H	N2.3 ■ 30 H	N3.1 ■ 68 H	N3.2 ■ 40 F	N3.3 ■ 20 H	S1.1 ■ 28 F	S1.2 ■ 20 D	S1.3 ■ 11 C	S2.1 ■ 9 E	S2.2 ■ 8 B	S3.1 ■ 7 E	S3.2 ■ 6 B	S4.1 ■ 5 E	S4.2 ■ 5 B

Product	DC	DC	DC	LCF	OAL	DCON MS
	(inch)	(Wire gauge size)	(inch)			
R88C01/16	1/16	—	0.0625	7/16	1.7/8	0.063
R89CON52	—	N52	0.0635	7/16	1.7/8	0.064
R89CON51	—	N51	0.0670	1/2	2"	0.067
R89CON50	—	N50	0.0700	1/2	2"	0.070
R89CON49	—	N49	0.0730	1/2	2"	0.073
R88C05/64	5/64	—	0.0781	1/2	2"	0.078
R89CON46	—	N46	0.0810	9/16	2.1/8	0.081
R89CON45	—	N45	0.0820	9/16	2.1/8	0.082
R89CON44	—	N44	0.0860	9/16	2.1/8	0.086
R89CON43	—	N43	0.0890	5/8	2.1/4	0.089
R89CON42	—	N42	0.0935	5/8	2.1/4	0.093
R88C03/32	3/32	—	0.0938	5/8	2.1/4	0.094
R89CON41	—	N41	0.0960	5/8	2.3/8	0.096
R89CON40	—	N40	0.0980	13/16	2.3/8	0.098
R89CON39	—	N39	0.0995	13/16	2.3/8	0.100
R89CON36	—	N36	0.1065	13/16	2.1/2	0.106
R88C07/64	7/64	—	0.1094	13/16	2.5/8	0.109
R89CON31	—	N31	0.1200	7/8	2.3/4	0.120
R88C01/8	1/8	—	0.1250	7/8	2.3/4	0.125
R89CON30	—	N30	0.1285	15/16	2.3/4	0.129
R89CON29	—	N29	0.1360	15/16	2.7/8	0.136
R88C09/64	9/64	—	0.1406	15/16	2.7/8	0.141
R89CON27	—	N27	0.1440	1"	3"	0.144
R89CON26	—	N26	0.1470	1"	3"	0.147
R89CON25	—	N25	0.1495	1"	3"	0.149
R89CON24	—	N24	0.1520	1"	3.1/8	0.152
R88C05/32	5/32	—	0.1563	1"	3.1/8	0.156
R89CON22	—	N22	0.1570	1.1/16	3.1/8	0.157
R89CON21	—	N21	0.1590	1.1/16	3.1/4	0.159
R89CON20	—	N20	0.1610	1.1/16	3.1/4	0.161
R88C011/64	11/64	—	0.1719	1.1/16	3.1/4	0.172
R89CON16	—	N16	0.1770	1.1/8	3.3/8	0.177

Product	DC	DC	DC	LCF	OAL	DCON MS
	(inch)	(Wire gauge size)	(inch)			
R89CON13	—	N13	0.1850	1.1/8	3.1/2	0.185
R88C03/16	3/16	—	0.1875	1.1/8	3.1/2	0.188
R89CON12	—	N12	0.1890	1.1/8	3.1/2	0.189
R89CON11	—	N11	0.1910	1.3/16	3.1/2	0.191
R89CON10	—	N10	0.1935	1.3/16	3.5/8	0.194
R89CON9	—	N9	0.1960	1.3/16	3.5/8	0.196
R89CON8	—	N8	0.1990	1.3/16	3.5/8	0.199
R89CON7	—	N7	0.2010	1.3/16	3.5/8	0.201
R88C013/64	13/64	—	0.2031	1.3/16	3.5/8	0.203
R89CON6	—	N6	0.2040	1.1/4	3.3/4	0.204
R89CON5	—	N5	0.2055	1.1/4	3.3/4	0.205
R89CON3	—	N3	0.2130	1.1/4	3.3/4	0.213
R88C07/32	7/32	—	0.2188	1.1/4	3.3/4	0.219
R88C015/64	15/64	—	0.2344	1.5/16	3.7/8	0.234
R88C01/4	1/4	—	0.2500	1.3/8	4"	0.250
R88C017/64	17/64	—	0.2656	1.7/16	4.1/8	0.266
R88C09/32	9/32	—	0.2813	1.1/2	4.1/4	0.281
R88C019/64	19/64	—	0.2969	1.9/16	4.3/8	0.297
R88C05/16	5/16	—	0.3125	1.5/8	4.1/2	0.313
R88C021/64	21/64	—	0.3281	1.11/16	4.5/8	0.328
R88C011/32	11/32	—	0.3438	1.11/16	4.3/4	0.344
R88C023/64	23/64	—	0.3594	1.3/4	4.7/8	0.359
R88C03/8	3/8	—	0.3750	1.13/16	5"	0.375
R88C025/64	25/64	—	0.3906	1.7/8	5.1/8	0.391
R88C013/32	13/32	—	0.4063	1.15/16	5.1/4	0.406
R88C027/64	27/64	—	0.4219	2"	5.3/8	0.422
R88C07/16	7/16	—	0.4375	2.1/16	5.1/2	0.438
R88C029/64	29/64	—	0.4531	2.1/8	5.5/8	0.453
R88C015/32	15/32	—	0.4688	2.1/8	5.3/4	0.469
R88C031/64	31/64	—	0.4844	2.3/16	5.7/8	0.484
R88C01/2	1/2	—	0.5000	2.1/4	6"	0.500

R10CO/R15CO/R18CO

PRECISION

NAS 907 typ J HSS-E (8%) kobolt för tung användning

En riktigt bra prestanda som ger hål med exakt storlek och en bättre finish. 135° självcentrerande korslipad spets med låg tryckkraft för lättare penetration. Bronshärdad ytfinish förhindrar att material från arbetsstycket fastnar på borens skäreppor. Tillverkad enligt NAS 907 typ J standarder för flyg- och rymdindustrin.

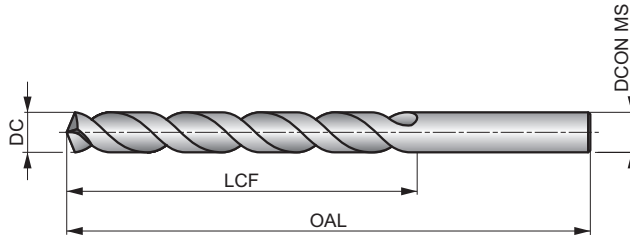

HSS-E	NAS 907	4×D
135°	Bronze	
λ20-35°	R	

Arbetsmaterialgrupper och startvärden för skärhastighet (m/min) och matningskod. Tabeller med matningar finns med början på sidan 274

P1.1 ▣36 H	P1.2 ▣40 H	P1.3 ▣41 H	P2.1 ▣31 H	P2.2 ▣27 G	P2.3 ▣24 E	P3.1 ▣25 F	P3.2 ▣20 F	P3.3 ▣17 E	P4.1 ▣15 F	P4.2 ▣13 E	P4.3 ▣10 D	M1.1 ▣30 E	M1.2 ▣26 E
M2.1 ▣27 E	M2.2 ▣22 E	M2.3 ▣18 C	M3.1 ▣13 G	M3.2 ▣11 G	M3.3 ▣10 C	M4.1 ▣15 C	K1.1 ▣35 H	K1.2 ▣26 D	K1.3 ▣19 D	K2.1 ▣27 E	K2.2 ▣22 E	K2.3 ▣18 E	K3.1 ▣24 E
K3.2 ▣18 E	K3.3 ▣15 E	K4.1 ▣22 E	K4.2 ▣17 E	K4.3 ▣12 E	K4.4 ▣11 E	K4.5 ▣9 E	K5.1 ▣25 E	K5.2 ▣19 E	K5.3 ▣15 E	N1.1 ▣33 J	N1.2 ▣25 J	N1.3 ▣17 I	N2.1 ▣46 H
N2.2 ▣42 H	N2.3 ▣30 H	N3.1 ▣68 H	N3.2 ▣40 F	N3.3 ▣20 H	S1.1 ▣28 F	S1.2 ▣20 D	S1.3 ▣11 C	S2.1 ▣9 E	S2.2 ▣8 B	S3.1 ▣7 E	S3.2 ▣6 B	S4.1 ▣5 E	S4.2 ▣5 B

Product	DC (inch)	DC (Wire gauge size)	DC (Letter size)	DC (inch)	LCF (inch)	OAL (inch)	DCON MS (inch)
R18CON80 ¹⁾	–	N80	–	0.0135	1/8	3/4	0.013
R18CON79 ¹⁾	–	N79	–	0.0145	1/8	3/4	0.015
R10C01/64 ¹⁾	1/64	–	–	0.0156	3/16	3/4	0.016
R18CON78 ¹⁾	–	N78	–	0.0160	3/16	7/8	0.016
R18CON77 ¹⁾	–	N77	–	0.0180	3/16	7/8	0.018
R18CON76 ¹⁾	–	N76	–	0.0200	3/16	7/8	0.020
R18CON75 ¹⁾	–	N75	–	0.0210	1/4	1"	0.021
R18CON74 ¹⁾	–	N74	–	0.0225	1/4	1"	0.022
R18CON73 ¹⁾	–	N73	–	0.0240	5/16	1.1/8	0.024
R18CON72 ¹⁾	–	N72	–	0.0250	5/16	1.1/8	0.025
R18CON71 ¹⁾	–	N71	–	0.0260	3/8	1.1/4	0.026
R18CON70 ¹⁾	–	N70	–	0.0280	3/8	1.1/4	0.028
R18CON69 ¹⁾	–	N69	–	0.0292	1/2	1.3/8	0.029
R18CON68 ¹⁾	–	N68	–	0.0310	1/2	1.3/8	0.031
R10C01/32 ¹⁾	1/32	–	–	0.0313	1/2	1.3/8	0.031
R18CON67 ¹⁾	–	N67	–	0.0320	1/2	1.3/8	0.032
R18CON66 ¹⁾	–	N66	–	0.0330	1/2	1.3/8	0.033
R18CON65 ¹⁾	–	N65	–	0.0350	5/8	1.1/2	0.035
R18CON64 ¹⁾	–	N64	–	0.0360	5/8	1.1/2	0.036
R18CON63 ¹⁾	–	N63	–	0.0370	5/8	1.1/2	0.037
R18CON62 ¹⁾	–	N62	–	0.0380	5/8	1.1/2	0.038
R18CON61 ¹⁾	–	N61	–	0.0390	11/16	1.5/8	0.039
R18CON60	–	N60	–	0.0400	11/16	1.5/8	0.040
R18CON59	–	N59	–	0.0410	11/16	1.5/8	0.041
R18CON58	–	N58	–	0.0420	11/16	1.5/8	0.042
R18CON57	–	N57	–	0.0430	3/4	1.3/4	0.043

Product	DC (inch)	DC (Wire gauge size)	DC (Letter size)	DC (inch)	LCF (inch)	OAL (inch)	DCON MS (inch)
R18CON56	–	N56	–	0.0465	3/4	1.3/4	0.046
R10C03/64	3/64	–	–	0.0469	3/4	1.3/4	0.047
R18CON55	–	N55	–	0.0520	7/8	1.7/8	0.052
R18CON54	–	N54	–	0.0550	7/8	1.7/8	0.055
R18CON53	–	N53	–	0.0595	7/8	1.7/8	0.059
R10C01/16	1/16	–	–	0.0625	7/8	1.7/8	0.063
R18CON52	–	N52	–	0.0635	7/8	1.7/8	0.064
R18CON51	–	N51	–	0.0670	1"	2"	0.067
R18CON50	–	N50	–	0.0700	1"	2"	0.070
R18CON49	–	N49	–	0.0730	1"	2"	0.073
R18CON48	–	N48	–	0.0760	1"	2"	0.076
R10C05/64	5/64	–	–	0.0781	1"	2"	0.078
R18CON47	–	N47	–	0.0785	1"	2"	0.079
R18CON46	–	N46	–	0.0810	1.1/8	2.1/8	0.081
R18CON45	–	N45	–	0.0820	1.1/8	2.1/8	0.082
R18CON44	–	N44	–	0.0860	1.1/8	2.1/8	0.086
R18CON43	–	N43	–	0.0890	1.1/4	2.1/4	0.089
R18CON42	–	N42	–	0.0935	1.1/4	2.1/4	0.093
R10C03/32	3/32	–	–	0.0938	1.1/4	2.1/4	0.094
R18CON41	–	N41	–	0.0960	1.3/8	2.3/8	0.096
R18CON40	–	N40	–	0.0980	1.3/8	2.3/8	0.098
R18CON39	–	N39	–	0.0995	1.3/8	2.3/8	0.100
R18CON38	–	N38	–	0.1015	1.7/16	2.1/2	0.102
R18CON37	–	N37	–	0.1040	1.7/16	2.1/2	0.104
R18CON36	–	N36	–	0.1065	1.7/16	2.1/2	0.106
R10C07/64	7/64	–	–	0.1094	1.1/2	2.5/8	0.109



Product	DC	DC	DC	DC	LCF	OAL	DCON MS
	(inch)	(Wire gauge size)	(Letter size)	(inch)	(inch)	(inch)	(inch)
R18CON35	–	N35	–	0.1100	1.1/2	2.5/8	0.110
R18CON34	–	N34	–	0.1110	1.1/2	2.5/8	0.111
R18CON33	–	N33	–	0.1130	1.1/2	2.5/8	0.113
R18CON32	–	N32	–	0.1160	1.5/8	2.3/4	0.116
R18CON31	–	N31	–	0.1200	1.5/8	2.3/4	0.120
R10C01/8	1/8	–	–	0.1250	1.5/8	2.3/4	0.125
R18CON30	–	N30	–	0.1285	1.5/8	2.3/4	0.129
R18CON29	–	N29	–	0.1360	1.3/4	2.7/8	0.136
R18CON28	–	N28	–	0.1405	1.3/4	2.7/8	0.141
R10C09/64	9/64	–	–	0.1406	1.3/4	2.7/8	0.141
R18CON27	–	N27	–	0.1440	1.7/8	3"	0.144
R18CON26	–	N26	–	0.1470	1.7/8	3"	0.147
R18CON25	–	N25	–	0.1495	1.7/8	3"	0.149
R18CON24	–	N24	–	0.1520	2"	3.1/8	0.152
R18CON23	–	N23	–	0.1540	2"	3.1/8	0.154
R10C05/32	5/32	–	–	0.1563	2"	3.1/8	0.156
R18CON22	–	N22	–	0.1570	2"	3.1/8	0.157
R18CON21	–	N21	–	0.1590	2.1/8	3.1/4	0.159
R18CON20	–	N20	–	0.1610	2.1/8	3.1/4	0.161
R18CON19	–	N19	–	0.1660	2.1/8	3.1/4	0.166
R18CON18	–	N18	–	0.1695	2.1/8	3.1/4	0.170
R10C011/64	11/64	–	–	0.1719	2.1/8	3.1/4	0.172
R18CON17	–	N17	–	0.1730	2.3/16	3.3/8	0.173
R18CON16	–	N16	–	0.1770	2.3/16	3.3/8	0.177
R18CON15	–	N15	–	0.1800	2.3/16	3.3/8	0.180
R18CON14	–	N14	–	0.1820	2.3/16	3.3/8	0.182
R18CON13	–	N13	–	0.1850	2.5/16	3.1/2	0.185
R10C03/16	3/16	–	–	0.1875	2.5/16	3.1/2	0.188
R18CON12	–	N12	–	0.1890	2.5/16	3.1/2	0.189
R18CON11	–	N11	–	0.1910	2.5/16	3.1/2	0.191
R18CON10	–	N10	–	0.1935	2.7/16	3.5/8	0.194
R18CON9	–	N9	–	0.1960	2.7/16	3.5/8	0.196
R18CON8	–	N8	–	0.1990	2.7/16	3.5/8	0.199
R18CON7	–	N7	–	0.2010	2.7/16	3.5/8	0.201
R10C013/64	13/64	–	–	0.2031	2.7/16	3.5/8	0.203
R18CON6	–	N6	–	0.2040	2.1/2	3.3/4	0.204
R18CON5	–	N5	–	0.2055	2.1/2	3.3/4	0.205
R18CON4	–	N4	–	0.2090	2.1/2	3.3/4	0.209
R18CON3	–	N3	–	0.2130	2.1/2	3.3/4	0.213
R10C07/32	7/32	–	–	0.2188	2.1/2	3.3/4	0.219
R18CON2	–	N2	–	0.2210	2.5/8	3.7/8	0.221
R18CON1	–	N1	–	0.2280	2.5/8	3.7/8	0.228
R15COA	–	–	A	0.2340	2.5/8	3.7/8	0.234
R10C015/64	15/64	–	–	0.2344	2.5/8	3.7/8	0.234
R15COB	–	–	B	0.2380	2.3/4	4"	0.238
R15COC	–	–	C	0.2420	2.3/4	4"	0.242
R15COD	–	–	D	0.2460	2.3/4	4"	0.246
R10C01/4	1/4	–	–	0.2500	2.3/4	4"	0.250
R15COF	–	–	F	0.2570	2.7/8	4.1/8	0.257

¹⁾ Ingen korsspets.

Product	DC	DC	DC	DC	LCF	OAL	DCON MS
	(inch)	(Wire gauge size)	(Letter size)	(inch)	(inch)	(inch)	(inch)
R15COG	–	–	G	0.2610	2.7/8	4.1/8	0.261
R10C017/64	17/64	–	–	0.2656	2.7/8	4.1/8	0.266
R15COH	–	–	H	0.2660	2.7/8	4.1/8	0.266
R15COI	–	–	I	0.2720	2.7/8	4.1/8	0.272
R15COJ	–	–	J	0.2770	2.7/8	4.1/8	0.277
R15COK	–	–	K	0.2810	2.15/16	4.1/4	0.281
R10C09/32	9/32	–	–	0.2813	2.15/16	4.1/4	0.281
R15COL	–	–	L	0.2900	2.15/16	4.1/4	0.290
R15COM	–	–	M	0.2950	3.1/16	4.3/8	0.295
R10C019/64	19/64	–	–	0.2969	3.1/16	4.3/8	0.297
R15CON	–	–	N	0.3020	3.1/16	4.3/8	0.302
R10C05/16	5/16	–	–	0.3125	3.3/16	4.1/2	0.313
R15COO	–	–	O	0.3160	3.3/16	4.1/2	0.316
R15COP	–	–	P	0.3230	3.5/16	4.5/8	0.323
R10C021/64	21/64	–	–	0.3281	3.5/16	4.5/8	0.328
R15COQ	–	–	Q	0.3320	3.7/16	4.3/4	0.332
R15COR	–	–	R	0.3390	3.7/16	4.3/4	0.339
R10C011/32	11/32	–	–	0.3438	3.7/16	4.3/4	0.344
R15COS	–	–	S	0.3480	3.1/2	4.7/8	0.348
R15COT	–	–	T	0.3580	3.1/2	4.7/8	0.358
R10C023/64	23/64	–	–	0.3594	3.1/2	4.7/8	0.359
R15COU	–	–	U	0.3680	3.5/8	5"	0.368
R10C03/8	3/8	–	–	0.3750	3.5/8	5"	0.375
R15COV	–	–	V	0.3770	3.5/8	5"	0.377
R15COW	–	–	W	0.3860	3.3/4	5.1/8	0.386
R10C025/64	25/64	–	–	0.3906	3.3/4	5.1/8	0.391
R15COX	–	–	X	0.3970	3.3/4	5.1/8	0.397
R15COY	–	–	Y	0.4040	3.7/8	5.1/4	0.404
R10C013/32	13/32	–	–	0.4063	3.7/8	5.1/4	0.406
R15COZ	–	–	Z	0.4130	3.7/8	5.1/4	0.413
R10C027/64	27/64	–	–	0.4219	3.15/16	5.3/8	0.422
R10C07/16	7/16	–	–	0.4375	4.1/16	5.1/2	0.438
R10C029/64	29/64	–	–	0.4531	4.3/16	5.5/8	0.453
R10C015/32	15/32	–	–	0.4688	4.5/16	5.3/4	0.469
R10C031/64	31/64	–	–	0.4844	4.3/8	5.7/8	0.484
R10C01/2	1/2	–	–	0.5000	4.1/2	6"	0.500
R10C033/64	33/64	–	–	0.5156	4.13/16	6.5/8	0.516
R10C017/32	17/32	–	–	0.5313	4.13/16	6.5/8	0.531
R10C035/64	35/64	–	–	0.5469	4.13/16	6.5/8	0.547
R10C09/16	9/16	–	–	0.5625	4.13/16	6.5/8	0.563
R10C037/64	37/64	–	–	0.5781	4.13/16	6.5/8	0.578
R10C019/32	19/32	–	–	0.5938	5.3/16	7.1/8	0.594
R10C039/64	39/64	–	–	0.6094	5.3/16	7.1/8	0.609
R10C05/8	5/8	–	–	0.6250	5.3/16	7.1/8	0.625
R10C041/64	41/64	–	–	0.6406	5.3/16	7.1/8	0.641
R10C021/32	21/32	–	–	0.6563	5.3/16	7.1/8	0.656
R10C043/64	43/64	–	–	0.6719	5.5/8	7.5/8	0.672
R10C011/16	11/16	–	–	0.6875	5.5/8	7.5/8	0.688

CO500-6/CO501-6

PRECISION

NAS 907 typ B HSS-E förlängningsborr för flygplan, 6" OAL



Borrar tillverkade enligt National Aerospace Standards med lång totalängd i kombination med kort skärlängd gör dem idealiska för borring i svåråtkomliga områden. Koboltmaterialet, 135° korsspets och bronsfärdad ytfinish förbättrar verktygets livslängd vid borring i de flesta material.

HSS-E	NAS 907	4xD

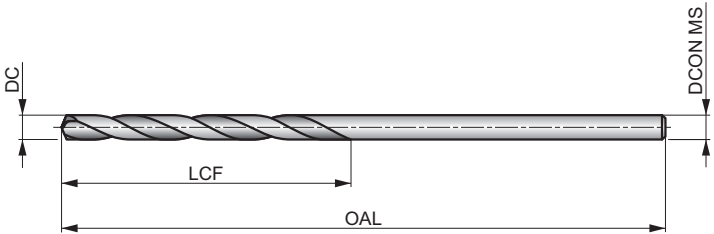

Arbetsmaterialgrupper och startvärden för skärhastighet (m/min) och matningskod. Tabeller med matningar finns med början på sidan 274

P1.1 ■ 36 G	P1.2 ■ 40 G	P1.3 ■ 41 G	P2.1 ■ 31 G	P2.2 ■ 27 E	P2.3 ■ 24 D	P3.1 ■ 25 E	P3.2 ■ 20 E	P3.3 ■ 17 D	P4.1 ■ 15 E	P4.2 ■ 13 D	P4.3 ■ 10 B	M1.1 ■ 30 H	M1.2 ■ 26 H
M2.1 ■ 27 H	M2.2 ■ 22 H	M2.3 ■ 18 D	M3.1 ■ 13 F	M3.2 ■ 11 F	M3.3 ■ 10 D	M4.1 ■ 15 D	M4.2 ■ 13 D	K1.1 ■ 35 H	K1.2 ■ 26 H	K1.3 ■ 19 H	K2.1 ■ 27 F	K2.2 ■ 22 F	K2.3 ■ 18 D
K3.1 ■ 24 F	K3.2 ■ 18 F	K3.3 ■ 15 D	K4.1 ■ 22 F	K4.2 ■ 17 F	K4.3 ■ 12 D	K4.4 ■ 11 D	K4.5 ■ 9 D	K5.1 ■ 25 F	K5.2 ■ 19 F	K5.3 ■ 15 D	N1.1 ■ 32 I	N1.2 ■ 24 I	N1.3 ■ 16 H
N2.1 ■ 42 G	N2.2 ■ 37 G	N2.3 ■ 27 G	N3.1 ■ 54 G	N3.2 ■ 32 H	N3.3 ■ 16 E	N4.1 ■ 35 I	N4.2 ■ 26 G	N4.3 ■ 12 E	S1.3 ■ 6 D	S2.1 ■ 8 B	S2.2 ■ 7 B	S3.1 ■ 6 B	S3.2 ■ 5 B
S4.1 ■ 5 B	S4.2 ■ 4 B												

Product	DC	DC	DC	LCF	OAL	DCON MS
	(inch)	(Wire gauge size)	(inch)	(inch)	(inch)	(inch)
CO500-61/16	1/16	—	0.0625	7/8	6"	0.063
CO501-6N52	—	N52	0.0635	7/8	6"	0.064
CO501-6N51	—	N51	0.0670	1"	6"	0.067
CO501-6N50	—	N50	0.0700	1"	6"	0.070
CO501-6N49	—	N49	0.0730	1"	6"	0.073
CO501-6N48	—	N48	0.0760	1"	6"	0.076
CO500-65/64	5/64	—	0.0781	1"	6"	0.078
CO501-6N47	—	N47	0.0785	1"	6"	0.079
CO501-6N46	—	N46	0.0810	1.1/8	6"	0.081
CO501-6N45	—	N45	0.0820	1.1/8	6"	0.082
CO501-6N44	—	N44	0.0860	1.1/8	6"	0.086
CO501-6N43	—	N43	0.0890	1.1/4	6"	0.089
CO501-6N42	—	N42	0.0935	1.1/4	6"	0.093
CO500-63/32	3/32	—	0.0938	1.1/4	6"	0.094
CO501-6N41	—	N41	0.0960	1.3/8	6"	0.096
CO501-6N40	—	N40	0.0980	1.3/8	6"	0.098
CO501-6N39	—	N39	0.0995	1.3/8	6"	0.100
CO501-6N38	—	N38	0.1015	1.7/16	6"	0.102
CO501-6N37	—	N37	0.1040	1.7/16	6"	0.104
CO501-6N36	—	N36	0.1065	1.7/16	6"	0.106
CO500-67/64	7/64	—	0.1094	1.1/2	6"	0.109
CO501-6N35	—	N35	0.1100	1.1/2	6"	0.110
CO501-6N34	—	N34	0.1110	1.1/2	6"	0.111
CO501-6N33	—	N33	0.1130	1.1/2	6"	0.113
CO501-6N32	—	N32	0.1160	1.5/8	6"	0.116
CO501-6N31	—	N31	0.1200	1.5/8	6"	0.120
CO500-61/8	1/8	—	0.1250	1.5/8	6"	0.125
CO501-6N30	—	N30	0.1285	1.5/8	6"	0.129
CO501-6N29	—	N29	0.1360	1.3/4	6"	0.136
CO501-6N28	—	N28	0.1405	1.3/4	6"	0.141
CO500-69/64	9/64	—	0.1406	1.3/4	6"	0.141
CO501-6N27	—	N27	0.1440	1.7/8	6"	0.144
CO501-6N26	—	N26	0.1470	1.7/8	6"	0.147

Product	DC	DC	DC	LCF	OAL	DCON MS
	(inch)	(Wire gauge size)	(inch)	(inch)	(inch)	(inch)
CO501-6N25	—	N25	0.1495	1.7/8	6"	0.149
CO501-6N24	—	N24	0.1520	2"	6"	0.152
CO501-6N23	—	N23	0.1540	2"	6"	0.154
CO500-65/32	5/32	—	0.1563	2"	6"	0.156
CO501-6N22	—	N22	0.1570	2"	6"	0.157
CO501-6N21	—	N21	0.1590	2.1/8	6"	0.159
CO501-6N20	—	N20	0.1610	2.1/8	6"	0.161
CO501-6N19	—	N19	0.1660	2.1/8	6"	0.166
CO501-6N18	—	N18	0.1695	2.1/8	6"	0.170
CO500-611/64	11/64	—	0.1719	2.1/8	6"	0.172
CO501-6N17	—	N17	0.1730	2.3/16	6"	0.173
CO501-6N16	—	N16	0.1770	2.3/16	6"	0.177
CO501-6N15	—	N15	0.1800	2.3/16	6"	0.180
CO501-6N14	—	N14	0.1820	2.3/16	6"	0.182
CO501-6N13	—	N13	0.1850	2.5/16	6"	0.185
CO500-63/16	3/16	—	0.1875	2.5/16	6"	0.188
CO501-6N12	—	N12	0.1890	2.5/16	6"	0.189
CO501-6N11	—	N11	0.1910	2.5/16	6"	0.191
CO501-6N10	—	N10	0.1935	2.7/16	6"	0.194
CO501-6N9	—	N9	0.1960	2.7/16	6"	0.196
CO501-6N8	—	N8	0.1990	2.7/16	6"	0.199
CO501-6N7	—	N7	0.2010	2.7/16	6"	0.201
CO500-613/64	13/64	—	0.2031	2.7/16	6"	0.203
CO501-6N6	—	N6	0.2040	2.1/2	6"	0.204
CO501-6N5	—	N5	0.2055	2.1/2	6"	0.205
CO501-6N4	—	N4	0.2090	2.1/2	6"	0.209
CO501-6N3	—	N3	0.2130	2.1/2	6"	0.213
CO500-67/32	7/32	—	0.2188	2.1/2	6"	0.219
CO501-6N2	—	N2	0.2210	2.5/8	6"	0.221
CO501-6N1	—	N1	0.2280	2.5/8	6"	0.228
CO500-615/64	15/64	—	0.2344	2.5/8	6"	0.234
CO500-61/4	1/4	—	0.2500	2.3/4	6"	0.250

CO500-12/CO501-12

PRECISION



NAS 907 typ B HSS-E förlängningsborr för flygplan, 12" OAL

Extra långa borrar tillverkade enligt National Aerospace Standards med extra lång totalängd i kombination med kort spånlängd gör dem idealiska för borrar i svåråtkomliga områden. Koboltmaterialet, 135° korsspets och bronsärad ytfinish förbättrar verktygets livslängd vid borrar i de flesta material.

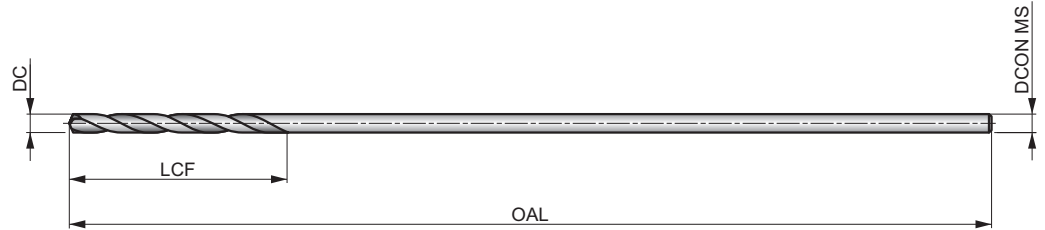

HSS-E	NAS 907	4xD
135°	Bronze	
λ 20-35°		

Arbetsmaterialgrupper och startvärden för skärhastighet (m/min) och matningskod. Tabeller med matningar finns med början på sidan 274

P1.1 ■ 36 G	P1.2 ■ 40 G	P1.3 ■ 41 G	P2.1 ■ 31 G	P2.2 ■ 27 E	P2.3 ■ 24 D	P3.1 ■ 25 E	P3.2 ■ 20 E	P3.3 ■ 17 D	P4.1 ■ 15 E	P4.2 ■ 13 D	P4.3 ■ 10 B	M1.1 ■ 30 H	M1.2 ■ 26 H
M2.1 ■ 27 H	M2.2 ■ 22 H	M2.3 ■ 18 D	M3.1 ■ 13 F	M3.2 ■ 11 F	M3.3 ■ 10 D	M4.1 ■ 15 D	M4.2 ■ 13 D	K1.1 ■ 35 H	K1.2 ■ 26 H	K1.3 ■ 19 H	K2.1 ■ 27 F	K2.2 ■ 22 F	K2.3 ■ 18 D
K3.1 ■ 24 F	K3.2 ■ 18 F	K3.3 ■ 15 D	K4.1 ■ 22 F	K4.2 ■ 17 F	K4.3 ■ 12 D	K4.4 ■ 11 D	K4.5 ■ 9 D	K5.1 ■ 25 F	K5.2 ■ 19 F	K5.3 ■ 15 D	N1.1 ■ 32 I	N1.2 ■ 24 I	N1.3 ■ 16 H
N2.1 ■ 42 G	N2.2 ■ 37 G	N2.3 ■ 27 G	N3.1 ■ 54 G	N3.2 ■ 32 H	N3.3 ■ 16 E	N4.1 ■ 35 I	N4.2 ■ 26 G	N4.3 ■ 12 E	S1.3 ■ 6 D	S2.1 ■ 8 B	S2.2 ■ 7 B	S3.1 ■ 6 B	S3.2 ■ 5 B
S4.1 ■ 5 B	S4.2 ■ 4 B												

Product	DC (inch)	DC (Wire gauge size)	DC (inch)	LCF (inch)	OAL (inch)	D CON MS (inch)
CO500-121/16	1/16	—	0.0625	7/8	12"	0.063
CO500-125/64	5/64	—	0.0781	1"	12"	0.078
CO500-123/32	3/32	—	0.0938	1.1/4	12"	0.094
CO501-12N40	—	N40	0.0980	1.3/8	12"	0.098
CO500-127/64	7/64	—	0.1094	1.1/2	12"	0.109
CO500-121/8	1/8	—	0.1250	1.5/8	12"	0.125
CO501-12N30	—	N30	0.1285	1.5/8	12"	0.129
CO501-12N29	—	N29	0.1360	1.3/4	12"	0.136
CO500-129/64	9/64	—	0.1406	1.3/4	12"	0.141
CO500-125/32	5/32	—	0.1563	2"	12"	0.156
CO501-12N21	—	N21	0.1590	2.1/8	12"	0.159

Product	DC (inch)	DC (Wire gauge size)	DC (inch)	LCF (inch)	OAL (inch)	D CON MS (inch)
CO501-12N20	—	N20	0.1610	2.1/8	12"	0.161
CO500-1211/64	11/64	—	0.1719	2.1/8	12"	0.172
CO501-12N16	—	N16	0.1770	2.3/16	12"	0.177
CO500-123/16	3/16	—	0.1875	2.5/16	12"	0.188
CO501-12N11	—	N11	0.1910	2.5/16	12"	0.191
CO501-12N10	—	N10	0.1935	2.7/16	12"	0.194
CO500-1213/64	13/64	—	0.2031	2.7/16	12"	0.203
CO500-127/32	7/32	—	0.2188	2.1/2	12"	0.219
CO501-12N2	—	N2	0.2210	2.5/8	12"	0.221
CO500-1215/64	15/64	—	0.2344	2.5/8	12"	0.234
CO500-121/4	1/4	—	0.2500	2.3/4	12"	0.250

2ACO

PRECISION



NAS 907 Typ J HSS-E kraftig borr, bronshärdad ytfinish, metrisk mått

En riktigt bra prestanda som ger hål med exakt storlek och en bättre finish. 135° självcenterande korslipad spets med låg tryckkraft för lättare penetration. Bronshärdad ytfinish förhindrar att material från arbetsstycket fastnar på borens skäreggar. Tillverkad enligt NAS 907 typ J standarder för flyg- och rymdindustrin.

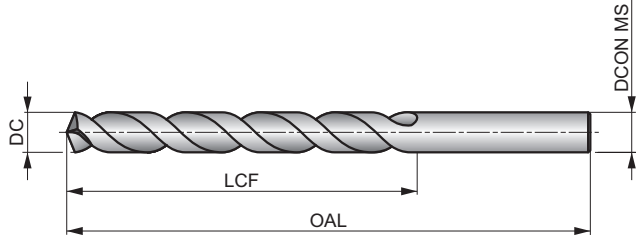

HSS-E	DIN 338	4×D
135°	Bronze	
λ 20-35°	R	

Arbetsmaterialgrupper och startvärden för skärhastighet (m/min) och matningskod. Tabeller med matningar finns med början på sidan 274

P1.1 ■ 36 H	P1.2 ■ 40 H	P1.3 ■ 41 H	P2.1 ■ 31 H	P2.2 ■ 27 G	P2.3 ■ 24 E	P3.1 ■ 25 F	P3.2 ■ 20 F	P3.3 ■ 17 E	P4.1 ■ 15 F	P4.2 ■ 13 E	P4.3 ■ 10 D	M1.1 ■ 30 E	M1.2 ■ 26 E
M2.1 ■ 27 E	M2.2 ■ 22 E	M2.3 ■ 18 C	M3.1 ■ 13 G	M3.2 ■ 11 G	M3.3 ■ 10 C	M4.1 ■ 15 C	K1.1 ■ 35 H	K1.2 ■ 26 D	K1.3 ■ 19 D	K2.1 ■ 27 E	K2.2 ■ 22 E	K2.3 ■ 18 E	K3.1 ■ 24 E
K3.2 ■ 18 E	K3.3 ■ 15 E	K4.1 ■ 22 E	K4.2 ■ 17 E	K4.3 ■ 12 E	K4.4 ■ 11 E	K4.5 ■ 9 E	K5.1 ■ 25 E	K5.2 ■ 19 E	K5.3 ■ 15 E	N1.1 ■ 33 J	N1.2 ■ 25 J	N1.3 ■ 17 I	N2.1 ■ 46 H
N2.2 ■ 42 H	N2.3 ■ 30 H	N3.1 ■ 68 H	N3.2 ■ 40 F	N3.3 ■ 20 H	S1.1 ■ 28 F	S1.2 ■ 20 D	S1.3 ■ 11 C	S2.1 ■ 9 E	S2.2 ■ 8 B	S3.1 ■ 7 E	S3.2 ■ 6 B	S4.1 ■ 5 E	S4.2 ■ 5 B

Product	DC (mm)	DC (inch)	LCF (mm)	OAL (mm)	DCON MS (mm)
2AC01.0	1.00	0.0394	12.0	34.0	1.00
2AC01.05	1.05	0.0413	12.0	34.0	1.05
2AC01.1	1.10	0.0433	14.0	36.0	1.10
2AC01.15	1.15	0.0453	14.0	36.0	1.15
2AC01.2	1.20	0.0472	16.0	38.0	1.20
2AC01.25	1.25	0.0492	16.0	38.0	1.25
2AC01.3	1.30	0.0512	16.0	38.0	1.30
2AC01.35	1.35	0.0531	18.0	40.0	1.35
2AC01.4	1.40	0.0551	18.0	40.0	1.40
2AC01.45	1.45	0.0571	18.0	40.0	1.45
2AC01.5	1.50	0.0591	18.0	40.0	1.50
2AC01.55	1.55	0.0610	20.0	43.0	1.55
2AC01.6	1.60	0.0630	20.0	43.0	1.60
2AC01.65	1.65	0.0650	20.0	43.0	1.65
2AC01.7	1.70	0.0669	20.0	43.0	1.70
2AC01.75	1.75	0.0689	22.0	46.0	1.75
2AC01.8	1.80	0.0709	22.0	46.0	1.80
2AC01.85	1.85	0.0728	22.0	46.0	1.85
2AC01.9	1.90	0.0748	22.0	46.0	1.90
2AC01.95	1.95	0.0768	24.0	49.0	1.95
2AC02.0	2.00	0.0787	24.0	49.0	2.00
2AC02.05	2.05	0.0807	24.0	49.0	2.05
2AC02.1	2.10	0.0827	24.0	49.0	2.10
2AC02.2	2.20	0.0866	27.0	53.0	2.20
2AC02.3	2.30	0.0906	27.0	53.0	2.30
2AC02.35	2.35	0.0925	27.0	53.0	2.35

Product	DC (mm)	DC (inch)	LCF (mm)	OAL (mm)	DCON MS (mm)
2AC02.4	2.40	0.0945	30.0	57.0	2.40
2AC02.5	2.50	0.0984	30.0	57.0	2.50
2AC02.6	2.60	0.1024	30.0	57.0	2.60
2AC02.7	2.70	0.1063	33.0	61.0	2.70
2AC02.8	2.80	0.1102	33.0	61.0	2.80
2AC02.9	2.90	0.1142	33.0	61.0	2.90
2AC03.0	3.00	0.1181	33.0	61.0	3.00
2AC03.1	3.10	0.1220	36.0	65.0	3.10
2AC03.2	3.20	0.1260	36.0	65.0	3.20
2AC03.25	3.25	0.1280	36.0	65.0	3.25
2AC03.3	3.30	0.1299	36.0	65.0	3.30
2AC03.4	3.40	0.1339	39.0	70.0	3.40
2AC03.5	3.50	0.1378	39.0	70.0	3.50
2AC03.6	3.60	0.1417	39.0	70.0	3.60
2AC03.7	3.70	0.1457	39.0	70.0	3.70
2AC03.75	3.75	0.1476	39.0	70.0	3.75
2AC03.8	3.80	0.1496	43.0	75.0	3.80
2AC04.0	4.00	0.1575	43.0	75.0	4.00
2AC04.1	4.10	0.1614	43.0	75.0	4.10
2AC04.2	4.20	0.1654	43.0	75.0	4.20
2AC04.25	4.25	0.1673	43.0	75.0	4.25
2AC04.3	4.30	0.1693	47.0	80.0	4.30
2AC04.4	4.40	0.1732	47.0	80.0	4.40
2AC04.5	4.50	0.1772	47.0	80.0	4.50
2AC04.7	4.70	0.1850	47.0	80.0	4.70
2AC04.8	4.80	0.1890	52.0	86.0	4.80



Product	DC	DC	LCF	OAL	DCON MS
	(mm)	(inch)	(mm)	(mm)	(mm)
2AC05.0	5.00	0.1969	52.0	86.0	5.00
2AC05.1	5.10	0.2008	52.0	86.0	5.10
2AC05.2	5.20	0.2047	52.0	86.0	5.20
2AC05.25	5.25	0.2067	52.0	86.0	5.25
2AC05.3	5.30	0.2087	52.0	86.0	5.30
2AC05.5	5.50	0.2165	57.0	93.0	5.50
2AC05.6	5.60	0.2205	57.0	93.0	5.60
2AC05.7	5.70	0.2244	57.0	93.0	5.70
2AC05.9	5.90	0.2323	57.0	93.0	5.90
2AC06.0	6.00	0.2362	57.0	93.0	6.00
2AC06.1	6.10	0.2402	63.0	101.0	6.10
2AC06.2	6.20	0.2441	63.0	101.0	6.20
2AC06.3	6.30	0.2480	63.0	101.0	6.30
2AC06.4	6.40	0.2520	63.0	101.0	6.40
2AC06.5	6.50	0.2559	63.0	101.0	6.50
2AC06.6	6.60	0.2598	63.0	101.0	6.60
2AC06.7	6.70	0.2638	63.0	101.0	6.70
2AC06.8	6.80	0.2677	69.0	109.0	6.80
2AC06.9	6.90	0.2717	69.0	109.0	6.90
2AC07.0	7.00	0.2756	69.0	109.0	7.00
2AC07.1	7.10	0.2795	69.0	109.0	7.10
2AC07.2	7.20	0.2835	69.0	109.0	7.20
2AC07.25	7.25	0.2854	69.0	109.0	7.25
2AC07.3	7.30	0.2874	69.0	109.0	7.30
2AC07.5	7.50	0.2953	69.0	109.0	7.50
2AC07.8	7.80	0.3071	75.0	117.0	7.80
2AC07.9	7.90	0.3110	75.0	117.0	7.90

Product	DC	DC	LCF	OAL	DCON MS
	(mm)	(inch)	(mm)	(mm)	(mm)
2AC08.0	8.00	0.3150	75.0	117.0	8.00
2AC08.2	8.20	0.3228	75.0	117.0	8.20
2AC08.4	8.40	0.3307	75.0	117.0	8.40
2AC08.5	8.50	0.3346	75.0	117.0	8.50
2AC08.8	8.80	0.3465	81.0	125.0	8.80
2AC08.9	8.90	0.3504	81.0	125.0	8.90
2AC09.0	9.00	0.3543	81.0	125.0	9.00
2AC09.1	9.10	0.3583	81.0	125.0	9.10
2AC09.2	9.20	0.3622	81.0	125.0	9.20
2AC09.3	9.30	0.3661	81.0	125.0	9.30
2AC09.4	9.40	0.3701	81.0	125.0	9.40
2AC09.5	9.50	0.3740	81.0	125.0	9.50
2AC09.6	9.60	0.3780	87.0	133.0	9.60
2AC09.7	9.70	0.3819	87.0	133.0	9.70
2AC09.8	9.80	0.3858	87.0	133.0	9.80
2AC010.0	10.00	0.3937	87.0	133.0	10.00
2AC010.2	10.20	0.4016	87.0	133.0	10.20
2AC010.5	10.50	0.4134	87.0	133.0	10.50
2AC010.8	10.80	0.4252	94.0	142.0	10.80
2AC011.0	11.00	0.4331	94.0	142.0	11.00
2AC011.2	11.20	0.4409	94.0	142.0	11.20
2AC011.5	11.50	0.4528	94.0	142.0	11.50
2AC011.8	11.80	0.4646	94.0	142.0	11.80
2AC012.0	12.00	0.4724	101.0	151.0	12.00
2AC012.2	12.20	0.4803	101.0	151.0	12.20
2AC012.5	12.50	0.4921	101.0	151.0	12.50
2AC013.0	13.00	0.5118	101.0	151.0	13.00

Verktygsmaterial (BMC)		HSS	HSS	HSS	HSS	HSS	HSS	HSS	HSS	HSS-E	HSS		
Beläggning		Bright	Bright	Bright	Bright	Bright	Bright	Bright	TiAlN	Bright	Bright		
Standard (BSG)		DIN 334C	DIN 335C	DORMER	DIN 335A	ANSI	DIN 335C	DIN 335C	DIN 335C	DORMER	DORMER		
Skärriktning													
Skافت													
Spetsvinkel		60°	82°	90°	90°		90°	90°	90°	90°	90°		
Produktfamilj		G135	G154	G129	G132	B690	G142	G136	G106	G506	G107	G600	G236
PSF skärdiameterar		6.30 - 25.00	6.30 - 25.00	6.00 - 31.50	8.00 - 20.00	1/4 - 1"	5.00 - 31.00	4.30 - 31.00	6.30 - 50.00	6.30 - 50.00	6.30 - 20.50	6.30 - 25.00	Set
		60	61	62	63	64	65	66	67	68	69	70	71
P	P1	■	■	■	■	■	■	■	■	■	■	■	
	P2	■	■	■	■	■	■	■	■	■	■	■	
	P3	■	■	■	■	■	■	■	■	■	■	■	
	P4	■	■	■	■	■	■	■	■	■	■	■	
M	M1	■	■	■	■	■	■	■	■	■	■	■	
	M2	■	■	■	■	■	■	■	■	■	■	■	
	M3				■	■	■	■	■	■	■	■	
	M4				■	■	■	■	■	■	■	■	
K	K1	■	■	■	■	■	■	■	■	■	■	■	
	K2	■	■	■	■	■	■	■	■	■	■	■	
	K3	■	■	■	■	■	■	■	■	■	■	■	
	K4				■	■	■	■	■	■	■	■	
	K5	■	■	■	■	■	■	■	■	■	■	■	
N	N1	■	■	■	■	■	■	■	■	■	■	■	
	N2	■	■	■	■	■	■	■	■	■	■	■	
	N3	■	■	■	■	■	■	■	■	■	■	■	
	N4	■	■	■	■	■	■	■	■	■	■	■	
	N5												
S	S1												
	S2												
	S3												
	S4												
H	H1												
	H2												
	H3												
	H4												



G135

DORMER



Försänkare av HSS, 60° försänkingsvinkel, blank

Blank försänkare med 60° försänkingsvinkel för försänkning och gradning av förborrade hål i de flesta materialtyper.

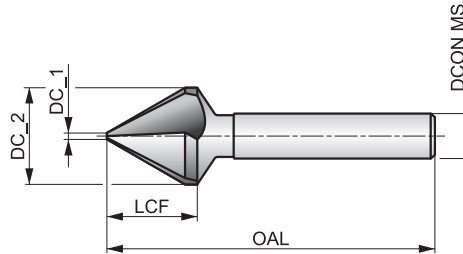

HSS	Bright	DIN 334C
R		60°

Arbetsmaterialgrupper och startvärden för skärhastighet (m/min) och matningskod. Tabeller med matningar finns med början på sidan 280

P1.1 ■ 23 E	P1.2 ■ 26 E	P1.3 ■ 27 E	P2.1 ■ 20 E	P2.2 ■ 18 D	P2.3 ▣ 16 B	P3.1 ■ 16 D	P3.2 ▣ 13 D	P3.3 ▣ 11 B	P4.1 ■ 10 D	P4.2 ▣ 8 B	M1.1 ▣ 8 C	M1.2 ▣ 16 C	M2.1 ▣ 17 C
M2.2 ▣ 16 C	K1.1 ▣ 20 F	K1.2 ▣ 15 D	K2.1 ▣ 21 C	K2.2 ▣ 17 C	K3.1 ▣ 18 C	K3.2 ▣ 14 C	K5.1 ▣ 19 C	K5.2 ▣ 15 C	N1.1 ▣ 40 G	N1.2 ■ 30 G	N1.3 ▣ 20 F	N2.1 ■ 20 F	N2.2 ▣ 18 F
N3.1 ■ 21 F	N3.2 ■ 12 F	N3.3 ▣ 16 D	N4.1 ▣ 40 G	N4.2 ▣ 35 G									

DCON MS tolerans h9.

Product	DC_2 (mm)	DC_1 (mm)	LCF (mm)	OAL (mm)	DCON MS (mm)	NOF
G1356.3	6.30	1.60	6.8	45.0	5.00	3
G1358.0	8.00	2.00	8.5	50.0	6.00	3
G13510.0	10.00	2.50	7.6	50.0	6.00	3
G13512.5	12.50	3.20	11.7	56.0	8.00	3
G13516.0	16.00	4.00	14.5	63.0	10.00	3
G13520.0	20.00	5.00	17.5	67.0	10.00	3
G13525.0	25.00	6.30	20.5	71.0	10.00	3

G154

DORMER



Försänkare av HSS, 82°, cylindriskt skaft, blank

En 82° försänkare för försänkning och gradning av hål. Ett mångsidigt verktyg som är användbart i flertalet material.

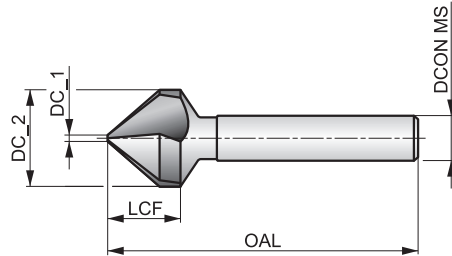

HSS	Bright	DIN 335C
R	Standard	82°

Arbetsmaterialgrupper och startvärden för skärhastighet (m/min) och matningskod. Tabeller med matningar finns med början på sidan 280

P1.1 ■ 23 E	P1.2 ■ 26 E	P1.3 ■ 27 E	P2.1 ■ 20 E	P2.2 ■ 18 D	P2.3 ▣ 16 B	P3.1 ■ 16 D	P3.2 ■ 13 D	P3.3 ▣ 11 B	P4.1 ■ 10 D	P4.2 ▣ 8 B	M1.1 ▣ 8 C	M1.2 ▣ 16 C	M2.1 ▣ 17 C
M2.2 ▣ 16 C	K1.1 ▣ 20 F	K1.2 ▣ 15 D	K2.1 ▣ 21 C	K2.2 ▣ 17 C	K3.1 ▣ 18 C	K3.2 ▣ 14 C	K5.1 ▣ 14 C	K5.2 ▣ 10 C	N1.1 ▣ 40 G	N1.2 ■ 30 G	N1.3 ▣ 20 F	N2.1 ■ 20 F	N2.2 ▣ 18 F
N3.1 ■ 21 F	N3.2 ■ 12 F	N3.3 ▣ 16 D	N4.1 ▣ 40 G	N4.2 ▣ 35 G									

DCON MS tolerans h9.

Product	DC_2 (mm)	DC_1 (mm)	LCF (mm)	OAL (mm)	DCON MS (mm)	NOF
G1546.3	6.30	1.50	5.5	45.0	5.00	3
G1548.3	8.30	2.00	6.5	50.0	6.00	3
G15410.4	10.40	2.50	7.6	50.0	6.00	3
G15412.4	12.40	2.80	8.5	56.0	8.00	3
G15416.5	16.50	3.20	10.5	60.0	10.00	3
G15420.5	20.50	3.50	13.0	63.0	10.00	3
G15425.0	25.00	3.80	15.5	67.0	10.00	3

G129



Försänkare av HSS, 90°, cylindriskt skaft, enskärig, blank

En 90° enskärig försänkare för försänkning och gradning av hål. Blankt, mångsidigt verktyg. Användbar i framför allt mjuka stål och aluminium.

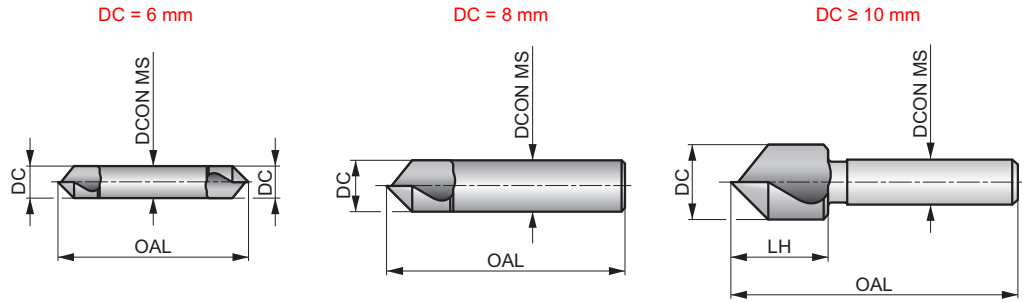

HSS	Bright	DORMER
R	90°	

Arbetsmaterialgrupper och startvärden för skärhastighet (m/min) och matningskod. Tabeller med matningar finns med början på sidan 280

P1.1 ■ 21 D	P1.2 ■ 24 D	P1.3 ■ 25 D	P2.1 ■ 18 D	P2.2 ■ 16 C	P2.3 ▣ 14 A	P3.1 ■ 13 B	P3.2 ▣ 11 B	M1.1 ▣ 8 B	M1.2 ▣ 6 B	M2.1 ▣ 7 B	K1.1 ▣ 18 D	K1.2 ▣ 13 C	K2.1 ▣ 19 A
K2.2 ▣ 15 A	K3.1 ▣ 16 A	K3.2 ▣ 12 A	N1.1 ■ 34 D	N1.2 ■ 25 D	N1.3 ▣ 16 C	N2.1 ▣ 16 C	N2.2 ▣ 14 C	N3.1 ■ 17 C	N3.2 ■ 9 C	N3.3 ▣ 5 B	N4.1 ▣ 35 D	N4.2 ▣ 30 D	

DCON MS tolerans h9.

Product	DC (mm)	LH (mm)	OAL (mm)	DCON MS (mm)	NOF
G1296.0	6.00	–	45.0	6.00	1
G1298.0	8.00	–	50.0	8.00	1
G12910.0	10.00	17.0	49.0	8.00	1
G12912.5	12.50	17.0	49.0	8.00	1
G12916.0	16.00	20.0	56.0	10.00	1
G12920.0	20.00	24.0	60.0	10.00	1
G12925.0	25.00	25.0	75.0	12.00	1
G12931.5	31.50	29.0	80.0	12.00	1

G132

DORMER



Försänkare, flerskärig av HSS, 90°, cylindriskt skaft, blank

En 90° försänkare för försänkning och gradning av hål. Flerskärigt verktyg som ger mindre vibrationer och är användbart i de flesta material.

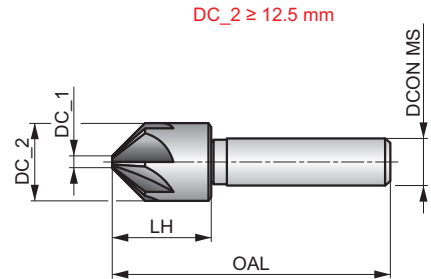
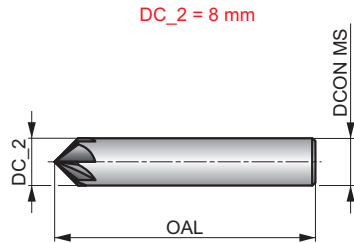

HSS	Bright	DIN 335A
R		90°

Arbetsmaterialgrupper och startvärden för skärhastighet (m/min) och matningskod. Tabeller med matningar finns med början på sidan 280

P2.2 ▣ 18 E	P2.3 ▣ 16 D	P3.2 ▣ 13 D	P3.3 ▣ 11 B	P4.1 ▣ 10 D	P4.2 ▣ 8 C	P4.3 ▣ 7 B	M3.3 ▣ 3 A	M4.1 ▣ 4 A	K1.1 ▣ 20 F	K1.2 ▣ 15 D	K1.3 ▣ 11 D	K2.2 ▣ 17 C	K2.3 ▣ 14 D
K3.1 ▣ 18 E	K3.2 ▣ 14 E	K3.3 ▣ 11 D	K4.1 ▣ 17 C	K4.2 ▣ 13 C	K5.1 ▣ 19	K5.2 ▣ 15	K5.3 ▣ 11 D	N1.3 ▣ 20 F	N2.3 ▣ 13 F	N3.2 ▣ 12 F	N4.3 ▣ 5 G		

DCON MS tolerans h9.

Product	DC_2 (mm)	DC_1 (mm)	LH (mm)	OAL (mm)	DCON MS (mm)	NOF
G1328.0	8.00	–	–	48.0	8.00	5
G13212.5	12.50	2.00	15.5	48.0	8.00	5
G13216.0	16.00	3.20	19.5	56.0	10.00	7
G13220.0	20.00	5.00	23.0	60.0	10.00	7

B690



HSS-fräs med rakt skaft, 60°, 82°, 90° eller 100° försänkingsvinklar

Används främst för brotschning av centrumborrade hål, svarvcentra i axlar och försänkingsvinklar för skruvhuvuden och nitar. Finns i 60°, 82°, 90° eller 100° försänkingsvinklar. Det ojämna antalet skär ger en jämn finish genom att eliminera vibrationer och samtidigt förbättra noggrannheten.

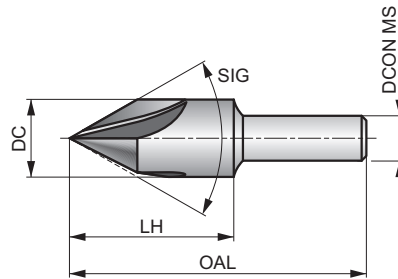

HSS	Bright	ANSI
R		60-100°

Arbetsmaterialgrupper och startvärden för skärhastighet (m/min) och matningskod. Tabeller med matningar finns med början på sidan 280

P1.1 ■ 21 D	P1.2 ■ 24 D	P1.3 ■ 25 D	P2.1 ■ 18 D	P2.2 ■ 16 C	P2.3 ▣ 14 A	P3.1 ■ 13 B	P3.2 ▣ 11 B	M1.1 ▣ 8 B	M1.2 ▣ 6 B	M2.1 ▣ 7 B	K1.1 ▣ 18 D	K1.2 ▣ 13 C	K2.1 ▣ 19 A
K2.2 ▣ 15 A	K3.1 ▣ 16 A	K3.2 ▣ 12 A	N1.1 ■ 34 D	N1.2 ■ 25 D	N1.3 ■ 16 C	N2.1 ▣ 16 C	N2.2 ▣ 14 C	N3.1 ■ 17 C	N3.2 ■ 9 C	N3.3 ▣ 5 B	N4.1 ▣ 35 D	N4.2 ▣ 30 D	

Product	DC (inch)	DC (inch)	SIG (°)	DCON MS (inch)	OAL (inch)	NOF
B6901/4X60	1/4	0.2500	60	3/16	1.1/2	3
B6901/4X82	1/4	0.2500	82	3/16	1.1/2	3
B6901/4X90	1/4	0.2500	90	3/16	1.1/2	3
B6901/4X100	1/4	0.2500	100	3/16	1.1/2	3
B6903/8X60	3/8	0.3750	60	1/4	1.3/4	3
B6903/8X82	3/8	0.3750	82	1/4	1.3/4	3
B6903/8X90	3/8	0.3750	90	1/4	1.3/4	3
B6903/8X100	3/8	0.3750	100	1/4	1.3/4	3
B6901/2X60	1/2	0.5000	60	3/8	2"	3
B6901/2X82	1/2	0.5000	82	3/8	2"	3
B6901/2X90	1/2	0.5000	90	3/8	2"	3
B6901/2X100	1/2	0.5000	100	3/8	2"	3

Product	DC (inch)	DC (inch)	SIG (°)	DCON MS (inch)	OAL (inch)	NOF
B6905/8X60	5/8	0.6250	60	3/8	2.1/4	3
B6905/8X82	5/8	0.6250	82	3/8	2.1/4	3
B6905/8X90	5/8	0.6250	90	3/8	2.1/4	3
B6905/8X100	5/8	0.6250	100	3/8	2.1/4	3
B6903/4X60	3/4	0.7500	60	1/2	2.5/8	3
B6903/4X82	3/4	0.7500	82	1/2	2.5/8	3
B6903/4X90	3/4	0.7500	90	1/2	2.5/8	3
B6903/4X100	3/4	0.7500	100	1/2	2.5/8	3
B6901X60	1"	1.0000	60	1/2	3"	3
B6901X82	1"	1.0000	82	1/2	3"	3
B6901X90	1"	1.0000	90	1/2	3"	3
B6901X100	1"	1.0000	100	1/2	3"	3

G142

DORMER



Försänkare av HSS, 90°, cylindriskt skaft, blank för rostfritt stål

En 90° försänkare för försänkning och gradning av hål. Större släppning på skären gör den mycket lämplig för användning i rostfritt stål och andra sega material.

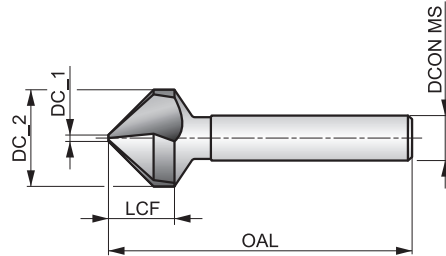

HSS	Bright	DIN 335C
R	90°	

Arbetsmaterialgrupper och startvärden för skärhastighet (m/min) och matningskod. Tabeller med matningar finns med början på sidan 280

P1.1 ■ 23 E	P1.2 ■ 26 E	P1.3 ■ 27 E	P2.1 ■ 20 E	P2.2 ■ 18 D	P2.3 ▧ 16 B	P3.1 ■ 16 D	P3.2 ■ 13 D	P3.3 ▧ 11 B	P4.1 ■ 10 D	P4.2 ▧ 8 B	M1.1 ■ 11 C	M1.2 ■ 9 C	M2.1 ■ 10 C
M2.2 ▧ 8 C	M3.1 ■ 7 B	M3.2 ▧ 6 B	M4.1 ▧ 4 A	N1.1 ■ 40 G	N1.2 ■ 30 G	N1.3 ▧ 20 F	N2.1 ▧ 20 F	N2.2 ▧ 18 F	N2.3 ▧ 20 F	N3.1 ■ 34 F	N3.2 ■ 20 F	N3.3 ■ 10 D	N4.1 ■ 40 G
N4.2 ■ 35 G													

DCON MS tolerans h9.

Product	DC_2 (mm)	DC_1 (mm)	LCF (mm)	OAL (mm)	DCON MS (mm)	NOF
G1425.0	5.00	1.50	4.5	40.0	4.00	3
G1426.3	6.30	1.50	5.5	45.0	5.00	3
G1428.0	8.00	2.00	6.1	50.0	6.00	3
G1428.3	8.30	2.00	6.5	50.0	6.00	3
G14210.0	10.00	2.50	7.6	50.0	6.00	3
G14210.4	10.40	2.50	7.6	50.0	6.00	3
G14212.4	12.40	2.80	8.5	56.0	8.00	3
G14215.0	15.00	3.20	9.5	60.0	10.00	3
G14216.5	16.50	3.20	10.5	60.0	10.00	3
G14220.5	20.50	3.50	13.0	63.0	10.00	3
G14223.0	23.00	3.80	13.7	67.0	10.00	3
G14225.0	25.00	3.80	15.5	67.0	10.00	3
G14231.0	31.00	4.20	18.5	71.0	12.00	3

G136

DORMER



Försänkare av HSS, 90°, cylindriskt skaft, blank

En 90° försänkare för försänkning och gradning av hål. Blankt, mångsidigt verktyg. Användbar i flertalet material.

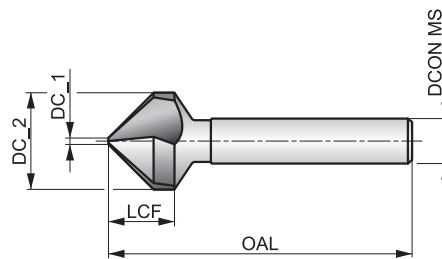

HSS	Bright	DIN 335C
R	Blank	90°

Arbetsmaterialgrupper och startvärden för skärhastighet (m/min) och matningskod. Tabeller med matningar finns med början på sidan 280

P1.1 ■ 23 E	P1.2 ■ 26 E	P1.3 ■ 27 E	P2.1 ■ 20 E	P2.2 ■ 18 D	P2.3 ■ 16 B	P3.1 ■ 16 D	P3.2 ■ 13 D	P3.3 ■ 11 B	P4.1 ■ 10 D	P4.2 ■ 8 B	M1.1 ■ 8 C	M1.2 ■ 6 C	M2.1 ■ 7 C
M2.2 ■ 6 C	K1.1 ■ 20 F	K1.2 ■ 15 D	K2.1 ■ 21 C	K2.2 ■ 17 C	K3.1 ■ 18 C	K3.2 ■ 14 C	K5.1 ■ 19 C	K5.2 ■ 15 C	N1.1 ■ 40 G	N1.2 ■ 30 G	N1.3 ■ 20 F	N2.1 ■ 20 F	N2.2 ■ 18 F
N3.1 ■ 21 F	N3.2 ■ 12 F	N3.3 ■ 16 D	N4.1 ■ 40 G	N4.2 ■ 35 G									

DCON MS tolerans h9.

Produkter från den här serien finns även i set. Se G236

Product	DC_2	DC_1	LCF	OAL	DCON MS	NOF
	(mm)	(mm)	(mm)	(mm)	(mm)	
G1364.3	4.30	1.30	4.0	40.0	4.00	3
G1365.0	5.00	1.50	4.5	40.0	4.00	3
G1365.3	5.30	1.50	4.5	40.0	4.00	3
G1365.8	5.80	1.50	5.0	45.0	5.00	3
G1366.0	6.00	1.50	5.0	45.0	5.00	3
G1366.3	6.30	1.50	5.5	45.0	5.00	3
G1367.0	7.00	1.80	5.5	50.0	6.00	3
G1367.3	7.30	1.80	6.1	50.0	6.00	3
G1368.0	8.00	2.00	6.1	50.0	6.00	3
G1368.3	8.30	2.00	6.5	50.0	6.00	3
G1369.4	9.40	2.20	7.2	50.0	6.00	3
G13610.0	10.00	2.50	7.6	50.0	6.00	3
G13610.4	10.40	2.50	7.6	50.0	6.00	3

Product	DC_2	DC_1	LCF	OAL	DCON MS	NOF
	(mm)	(mm)	(mm)	(mm)	(mm)	
G13611.5	11.50	2.80	8.0	56.0	8.00	3
G13612.4	12.40	2.80	8.5	56.0	8.00	3
G13613.4	13.40	2.90	9.0	56.0	8.00	3
G13615.0	15.00	3.20	9.5	60.0	10.00	3
G13616.5	16.50	3.20	10.5	60.0	10.00	3
G13619.0	19.00	3.50	11.7	63.0	10.00	3
G13620.5	20.50	3.50	13.0	63.0	10.00	3
G13623.0	23.00	3.80	13.7	67.0	10.00	3
G13625.0	25.00	3.80	15.5	67.0	10.00	3
G13626.0	26.00	3.80	15.5	67.0	10.00	3
G13628.0	28.00	4.00	16.5	71.0	12.00	3
G13630.0	30.00	4.20	18.5	71.0	12.00	3
G13631.0	31.00	4.20	18.5	71.0	12.00	3

G106

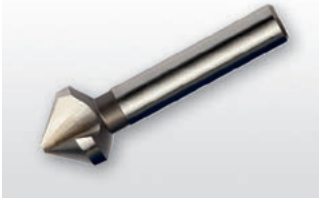

Försänkare av HSS, 90°, skaft med tre spännplattor, blank

En 90° försänkare för trebackschuck, för försänkning och gradning av hål. Blankt, mångsidigt verktyg. Användbar i flertalet material.

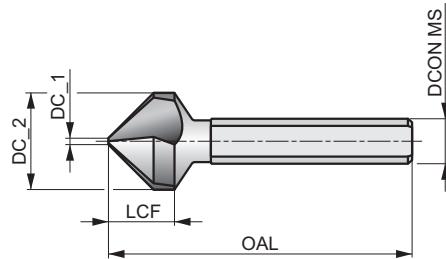

HSS	Bright	DIN 335C
R		90°

Arbetsmaterialgrupper och startvärden för skärhastighet (m/min) och matningskod. Tabeller med matningar finns med början på sidan 280

P1.1 ■ 23 E	P1.2 ■ 26 E	P1.3 ■ 27 E	P2.1 ■ 20 E	P2.2 ■ 18 D	P2.3 ▣ 16 B	P3.1 ■ 16 D	P3.2 ■ 13 D	P3.3 ▣ 11 B	P4.1 ■ 10 D	P4.2 ▣ 8 B	M1.1 ▣ 8 C	M1.2 ▣ 16 C	M2.1 ▣ 17 C
M2.2 ▣ 6 C	K1.1 ■ 20 F	K1.2 ■ 15 D	K2.1 ▣ 21 C	K2.2 ▣ 17 C	K3.1 ▣ 18 C	K3.2 ▣ 14 C	K5.1 ▣ 19 C	K5.2 ▣ 15 C	N1.1 ▣ 40 G	N1.2 ■ 30 G	N1.3 ▣ 20 F	N2.1 ▣ 20 F	N2.2 ▣ 18 F
N3.1 ■ 21 F	N3.2 ▣ 12 F	N3.3 ▣ 16 D	N4.1 ▣ 40 G	N4.2 ▣ 35 G									

DCON MS tolerans h9.
Produkter från den här serien finns även i set. Se G236

Product	DC_2 (mm)	DC_1 (mm)	LCF (mm)	OAL (mm)	DCON MS (mm)	NOF
G1066.3	6.30	1.50	5.6	45.0	5.00	3
G1068.3	8.30	2.00	6.9	50.0	6.00	3
G10610.4	10.40	2.50	7.8	50.0	6.00	3
G10612.4	12.40	2.80	8.6	56.0	8.00	3
G10616.5	16.50	3.20	11.1	60.0	10.00	3
G10620.5	20.50	3.50	12.9	63.0	10.00	3
G10625.0	25.00	3.80	15.7	67.0	10.00	3
G10631.0	31.00	4.20	18.5	71.0	12.00	3
G10634.0	34.00	4.50	19.0	103.0	16.00	3
G10637.0	37.00	4.50	21.2	118.0	16.00	3
G10640.0	40.00	4.50	20.0	118.0	16.00	3
G10650.0	50.00	5.00	23.6	126.0	16.00	3

G506

DORMER

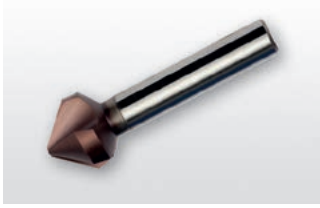

Försänkare av HSS, 90°, skaft med tre spännplattor, TiAlN-belagd

En 90° försänkare för trebackschuck, för försänkning och gradning av hål. Ett mångsidigt verktyg med TiAlN-beläggning som förlänger livslängden. Användbar i flertalet material.

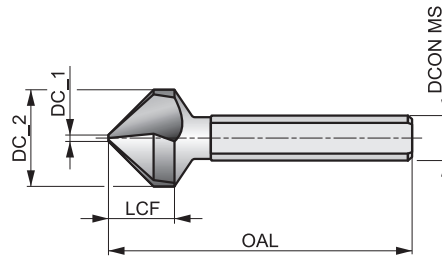

HSS		DIN 335C
		90°

Arbetsmaterialgrupper och startvärden för skärhastighet (m/min) och matningskod. Tabeller med matningar finns med början på sidan 280

P1.1 ■ 40 E	P1.2 ■ 45 E	P1.3 ■ 46 E	P2.1 ■ 34 E	P2.2 ■ 30 D	P2.3 ■ 27 B	P3.1 ■ 28 D	P3.2 ■ 22 D	P3.3 ■ 19 B	P4.1 ■ 16 D	P4.2 ■ 14 B	P4.3 ▣ 11 B	M1.1 ▣ 11 C	M1.2 ▣ 9 C
M2.1 ▣ 10 C	M2.2 ▣ 19 C	M2.3 ▣ 8 B	K1.1 ■ 41 F	K1.2 ■ 30 D	K1.3 ▣ 23 D	K2.1 ■ 42 C	K2.2 ■ 34 C	K2.3 ▣ 27 C	K3.1 ■ 37 C	K3.2 ■ 28 C	K3.3 ▣ 23 C	K4.1 ▣ 34 C	K4.2 ▣ 26 C
K4.3 ▣ 19 C	K5.1 ■ 39 C	K5.2 ■ 29 C	K5.3 ▣ 23 C	N1.1 ▣ 60 G	N1.2 ▣ 45 G	N1.3 ■ 30 F	N2.1 ■ 30 F	N2.2 ■ 27 F	N2.3 ■ 19 F	N3.1 ■ 32 F	N3.2 ■ 18 F	N3.3 ▣ 19 D	N4.1 ▣ 62 G
N4.2 ▣ 55 G													

DCON MS tolerans h9.

Produkter från den här serien finns även i set. Se G236

Product	DC_2 (mm)	DC_1 (mm)	LCF (mm)	OAL (mm)	DCON MS (mm)	NOF
G5066.3	6.30	1.50	5.6	45.0	5.00	3
G5068.3	8.30	2.00	6.9	50.0	6.00	3
G50610.4	10.40	2.50	7.8	50.0	6.00	3
G50612.4	12.40	2.80	8.6	56.0	8.00	3
G50616.5	16.50	3.20	11.1	60.0	10.00	3
G50620.5	20.50	3.50	12.9	63.0	10.00	3
G50625.0	25.00	3.80	15.7	67.0	10.00	3
G50631.0	31.00	4.20	18.5	71.0	12.00	3
G50637.0	37.00	4.50	21.2	118.0	16.00	3
G50640.0	40.00	4.50	20.0	118.0	16.00	3
G50650.0	50.00	5.00	23.6	126.0	16.00	3

G107



Försänkare av HSS-E, 90°, sexkantigt skaft, blank

En användbar försänkare med 1/4" Bits-fäste för enkel användning i handhållna el-maskiner. 90° försänkning i de flesta material.

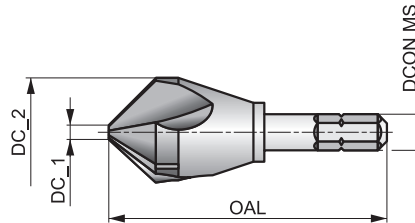

HSS-E	Bright	DORMER
R		90°

Arbetsmaterialgrupper och startvärden för skärhastighet (m/min) och matningskod. Tabeller med matningar finns med början på sidan 280

P1.1 ■ 23 E	P1.2 ■ 26 E	P1.3 ■ 27 E	P2.1 ■ 20 E	P2.2 ■ 18 D	P2.3 ■ 16 B	P3.1 ■ 16 D	P3.2 ■ 13 D	P3.3 ■ 11 B	P4.1 ■ 10 D	P4.2 ■ 8 B	M1.1 ■ 11 C	M1.2 ■ 9 C	M2.1 ■ 10 C
M2.2 ■ 9 C	M2.3 ■ 8 B	K1.1 ■ 20 F	K1.2 ■ 15 D	K2.1 ■ 21 C	K2.2 ■ 17 C	K3.1 ■ 18 C	K3.2 ■ 14 C	K4.1 ■ 15 C	K5.1 ■ 19 C	K5.2 ■ 15 C	N1.1 ■ 40 G	N1.2 ■ 30 G	N1.3 ■ 20 F
N2.1 ■ 20 F	N2.2 ■ 18 F	N2.3 ■ 20 F	N3.1 ■ 21 F	N3.2 ■ 12 F	N3.3 ■ 6 D	N4.1 ■ 40 G	N4.2 ■ 35 G						

6,35; 1/4" sexkantskaft; DIN 74.

Product	DC_2 (mm)	DC_1 (mm)	OAL (mm)	DCON MS (inch)	CZC MS	NOF
G1076.3	6.30	1.50	50.0	1/4"	M2-M3	3
G10710.4	10.40	2.50	50.0	1/4"	M5	3
G10712.4	12.40	2.80	50.0	1/4"	M6	3
G10716.5	16.50	3.20	50.0	1/4"	M8	3
G10720.5	20.50	3.50	50.0	1/4"	M10	3

G600



Försänkare av HSS med långt skaft, 90° försänkning, blank

Det långa skaftet gör det möjligt att nå svåråtkomliga ställen. Försänker och gradar hål för standardskruvskallar med nittio graders huvud. Kan användas i de flesta material.

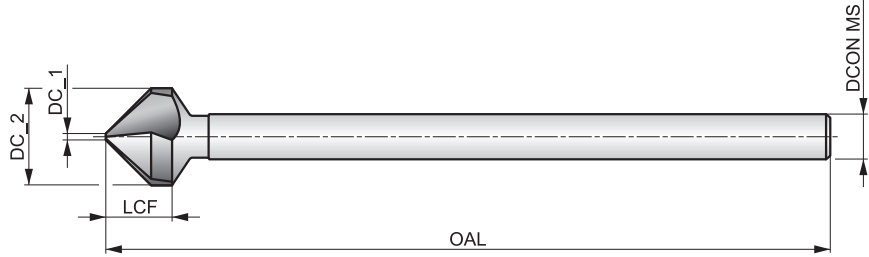

HSS	Bright	DORMER
R		90°

Arbetsmaterialgrupper och startvärden för skärhastighet (m/min) och matningskod. Tabeller med matningar finns med början på sidan 280

P1.1 ■ 20 E	P1.2 ■ 22 E	P1.3 ■ 23 E	P2.1 ■ 17 E	P2.2 ■ 15 D	P2.3 ▣ 13 B	P3.1 ■ 12 D	P3.2 ■ 9 D	P3.3 ▣ 8 B	P4.1 ■ 7 D	P4.2 ▣ 6 B	M1.1 ▣ 8 C	M1.2 ▣ 6 C	M2.1 ▣ 7 C
M2.2 ▣ 6 C	K1.1 ■ 17 E	K1.2 ▣ 12 C	K2.1 ▣ 18 B	K2.2 ▣ 14 B	K3.1 ▣ 15 B	K3.2 ▣ 11 B	K5.1 ▣ 16 B	K5.2 ▣ 12 B	N1.1 ▣ 35 G	N1.2 ▣ 25 G	N1.3 ▣ 15 F	N2.1 ▣ 15 F	N2.2 ▣ 13 F
N3.1 ■ 16 E	N3.2 ▣ 10 E	N3.3 ▣ 5 C											

DCON MS tolerans h9.

Product	DC_2 (mm)	DC_1 (mm)	LCF (mm)	OAL (mm)	DCON MS (mm)	NOF
G6006.3	6.30	1.30	5.6	154.0	5.00	3
G6008.3	8.30	1.80	6.9	155.0	6.00	3
G60010.4	10.40	2.20	7.8	157.0	6.00	3
G60012.4	12.40	2.50	8.6	158.0	8.00	3
G60015.0	15.00	2.80	10.3	159.0	10.00	3
G60016.5	16.50	2.80	11.1	161.0	10.00	3
G60020.5	20.50	3.00	12.9	164.0	10.00	3
G60025.0	25.00	3.20	15.7	168.0	10.00	3

G236



Försänkarsats i cylindrisk plastbehållare

Satser med försänkare i olika storlekar. Välj mellan fem olika satser med G106, G136 eller G560. Passar de flesta material.

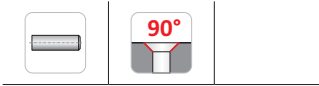

A=ingående produkt, B=antal i satsen, C=diametrar i satsen. DC <= 1,4mm 4-fasettspets.

Product	Nr.	A	B	C
G2361	1	G136	6	6.30 mm, 8.30 mm, 10.40 mm, 12.40 mm, 16.50 mm, 20.50 mm
G2362	2	G136	4	6.30 mm, 10.40 mm, 16.50 mm, 20.50 mm
G2363	3	G560	6	6.30 mm, 8.30 mm, 10.40 mm, 12.40 mm, 16.50 mm, 20.50 mm
G2364	4	G106	6	6.30 mm, 8.30 mm, 10.40 mm, 12.40 mm, 16.50 mm, 20.50 mm
G2365	5	G506	6	6.30 mm, 8.30 mm, 10.40 mm, 12.40 mm, 16.50 mm, 20.50 mm

Verktygsmaterial (BMC)	HSS	HSS	HSS	HSS	HSS	HSS-E	HSS	HSS	HSS	HSS	HSS	HSS	HSS
Beläggning	Bright ST	Bright	Bright	Bright	Bright ST	Bright	Bright ST	Bright	Bright	Bright	Bright	Bright	ST Bronze
Standard (BSG)	DIN 206	ANSI	ANSI	ANSI	BS 328	DIN 2179	DIN 9	DIN 9	ANSI	ANSI	ANSI	ANSI	ANSI
Skärriktning													
Skaft													
Brotschform	B				A		A	B					
Näbar håltolerans (TCHA)	H7												
Konicitet - millimeter					1:48	1:50	1:50	1:50	1:48	1:48	1:48		
Produktfamilj	B100	B610	B620	B650	B301	B953	B903	B952	B630	B660	B670	B680	B122
PSF skärdiameter	1.50 - 40.00	N60 - 1.1/2	1/16 - 1"	1/8 - 1"	3/32 - 1/2	2.00 - 12.00	1.50 - 20.00	1.20 - 40.00	7/0 - N10	N0 - N10	N0 - N10	1/8 - 1"	3/8 - 1"
P	P1	■	■	■	■	■	■	■	■	■	■	■	■
	P2	■	■	■	■	■	■	■	■	■	■	■	■
	P3	▣	■	■	■	■	▣	■	■	■	■	■	▣
	P4	▣	■	■	▣	▣	▣	▣	▣	■	▣	▣	▣
M	M1	▣	▣	▣	▣	▣	▣	▣	▣	▣	▣	▣	▣
	M2	▣	▣	▣	▣	▣	▣	▣	▣	▣	▣	▣	▣
	M3												
	M4												
K	K1	■	■	■	■	■	▣	▣	■	■	■	■	
	K2	▣	■	■	■	■	■	■	■	■	■	■	
	K3	■	▣	▣	■	▣	▣	▣	■	■	■	■	
	K4												
	K5												
N	N1	■	▣	■	■	■	▣	■	■	■	■	■	▣
	N2	■	▣	■	■	■	■	■	■	■	■	■	▣
	N3	■	■	■	■	■	▣	■	■	■	■	■	■
	N4	▣	▣		▣	▣	▣	▣	▣	▣	▣	▣	▣
	N5												
S	S1												
	S2												
	S3												
	S4												
H	H1												
	H2												
	H3												
	H4												

B100



Handbrottsch av HSS för H7-tolerans, blank och ånganlöpt

Handbrottsch med precisionsslipade vänsterskurna, blanka skär och ånganlöpta spår. För användning i de flesta material.

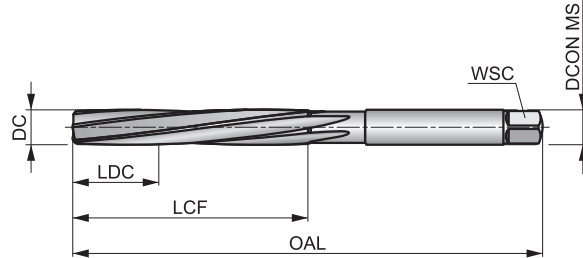

HSS	Bright ST	DIN 206
R		B
H7		

Arbetsmaterialgrupper

P1.1	P1.2	P1.3	P2.1	P2.2	P2.3	P3.1	P3.2	P3.3	P4.1	P4.2	P4.3	M1.1	M1.2
■	■	■	■	■	■	■	■	■	■	■	■	■	■
M2.1	K1.1	K1.2	K1.3	K2.1	K2.2	K2.3	K3.1	K3.2	N1.1	N1.2	N1.3	N2.1	N2.2
■	■	■	■	■	■	■	■	■	■	■	■	■	■
N2.3	N3.1	N3.2	N3.3	N4.1	N4.2								
■	■	■	■	■	■								

DCON MS tolerans e9.

Product	DC	DC	OAL	LCF	LDC	NOF	WSC	DCON MS
	(inch)	(mm)	(mm)	(mm)	(mm)		(mm)	(mm)
B1001.5	—	1.50	41.0	20.0	5.00	3	1.12	1.50
B1002.0	—	2.00	50.0	25.0	6.00	4	1.60	2.00
B1003/32	3/32	2.38	54.0	27.0	7.00	4	1.80	2.38
B1002.5	—	2.50	58.0	29.0	7.00	4	2.10	2.50
B1003.0	—	3.00	62.0	31.0	8.00	6	2.40	3.00
B1001/8	1/8	3.18	66.0	33.0	8.00	6	2.40	3.18
B1003.2	—	3.20	66.0	33.0	8.00	6	2.40	3.20
B1003.5	—	3.50	71.0	35.0	9.00	6	2.70	3.50
B1005/32	5/32	3.97	76.0	38.0	10.00	6	3.00	3.97
B1004.0	—	4.00	76.0	38.0	10.00	6	3.00	4.00
B1004.5	—	4.50	81.0	41.0	10.00	6	3.40	4.50
B1003/16	3/16	4.76	87.0	44.0	11.00	6	3.80	4.76
B1005.0	—	5.00	87.0	44.0	11.00	6	3.80	5.00
B1005.5	—	5.50	93.0	47.0	12.00	6	4.30	5.50
B1007/32	7/32	5.56	93.0	47.0	12.00	6	4.30	5.56
B1006.0	—	6.00	93.0	47.0	12.00	6	4.90	6.00
B1001/4	1/4	6.35	100.0	50.0	13.00	6	4.90	6.35
B1006.5	—	6.50	100.0	50.0	13.00	6	4.90	6.50
B10017/64	17/64	6.75	107.0	54.0	14.00	6	5.50	6.75
B1007.0	—	7.00	107.0	54.0	14.00	6	5.50	7.00
B1009/32	9/32	7.14	107.0	54.0	14.00	6	6.20	7.14
B1007.5	—	7.50	107.0	54.0	14.00	6	6.20	7.50
B1005/16	5/16	7.94	115.0	58.0	15.00	6	6.20	7.94
B1008.0	—	8.00	115.0	58.0	15.00	6	6.20	8.00
B10021/64	21/64	8.33	115.0	58.0	15.00	6	7.00	8.33
B1008.5	—	8.50	115.0	58.0	15.00	6	7.00	8.50
B10011/32	11/32	8.73	124.0	62.0	16.00	6	7.00	8.73



Product	DC	DC	OAL	LCF	LDC	NOF	WSC	DCON MS
	(inch)	(mm)	(mm)	(mm)	(mm)		(mm)	(mm)
B1009.0	–	9.00	124.0	62.0	16.00	6	7.00	9.00
B1009.5	–	9.50	124.0	62.0	16.00	6	8.00	9.50
B1003/8	3/8	9.52	124.0	62.0	17.00	6	8.00	9.52
B10010.0	–	10.00	133.0	66.0	17.00	6	8.00	10.00
B10013/32	13/32	10.32	133.0	66.0	17.00	6	8.00	10.32
B10010.5	–	10.50	133.0	66.0	17.00	6	8.00	10.50
B10011.0	–	11.00	142.0	71.0	18.00	6	9.00	11.00
B1007/16	7/16	11.11	142.0	71.0	18.00	6	9.00	11.11
B10011.5	–	11.50	142.0	71.0	18.00	6	9.00	11.50
B10012.0	–	12.00	152.0	76.0	19.00	6	9.00	12.00
B10012.5	–	12.50	152.0	76.0	19.00	6	10.00	12.50
B1001/2	1/2	12.70	152.0	76.0	19.00	6	10.00	12.70
B10013.0	–	13.00	152.0	76.0	19.00	6	10.00	13.00
B10013.5	–	13.50	163.0	81.0	20.00	8	11.00	13.50
B10014.0	–	14.00	163.0	81.0	20.00	8	11.00	14.00
B1009/16	9/16	14.29	163.0	81.0	20.00	8	11.00	14.29
B10014.5	–	14.50	163.0	81.0	20.00	8	11.00	14.50
B10015.0	–	15.00	163.0	81.0	20.00	8	12.00	15.00
B1005/8	5/8	15.88	175.0	87.0	22.00	8	12.00	15.88
B10016.0	–	16.00	175.0	87.0	22.00	8	12.00	16.00
B10017.0	–	17.00	175.0	87.0	22.00	8	13.00	17.00
B10018.0	–	18.00	188.0	93.0	23.00	8	14.50	18.00
B10019.0	–	19.00	188.0	93.0	23.00	8	14.50	19.00
B1003/4	3/4	19.05	188.0	93.0	25.00	8	14.50	19.05
B10020.0	–	20.00	201.0	100.0	25.00	8	16.00	20.00
B10021.0	–	21.00	201.0	100.0	25.00	8	16.00	21.00
B10022.0	–	22.00	215.0	107.0	27.00	8	18.00	22.00
B1007/8	7/8	22.22	215.0	107.0	27.00	8	18.00	22.22
B10023.0	–	23.00	215.0	107.0	27.00	8	18.00	23.00
B10024.0	–	24.00	231.0	115.0	29.00	8	18.00	24.00
B10025.0	–	25.00	231.0	115.0	29.00	8	20.00	25.00
B1001	1"	25.40	231.0	115.0	29.00	8	20.00	25.40
B10026.0	–	26.00	231.0	115.0	29.00	8	20.00	26.00
B10028.0	–	28.00	247.0	124.0	31.00	10	22.00	28.00
B10030.0	–	30.00	247.0	124.0	31.00	10	24.00	30.00
B10032.0	–	32.00	265.0	133.0	33.00	10	24.00	32.00
B10035.0	–	35.00	284.0	142.0	36.00	10	29.00	35.00
B10040.0	–	40.00	305.0	152.0	38.00	10	32.00	40.00

B610



HSS-fräs med rakt skaft och rakt skär, blank yta

Mångsidiga brotschar för allmänt bruk har kortare och djupare skär än handbrotschar och är konstruerade för effektiv maskinbrotschning av de flesta material. Ett stort urval av storlekar finns tillgängliga, inklusive tum, bokstavstorlekar och decimalstorlekar tillverkade enligt ANSI B94.2-1983 (R1988).

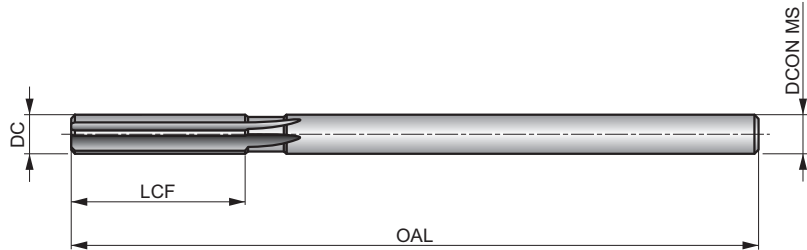

HSS	Bright	ANSI
R		

Arbetsmaterialgrupper och startvärden för skärhastighet (m/min) och matningskod. Tabeller med matningar finns med början på sidan 279

P1.1 19 C	P1.2 22 C	P1.3 23 C	P2.1 16 C	P2.2 14 C	P2.3 12 B	P3.1 11 B	P3.2 9 B	P3.3 7 A	P4.1 5 B	P4.2 4 A	P4.3 3	M1.1 9 C	M1.2 8 B
M2.1 7 B	K1.1 14 E	K1.2 10 D	K1.3 7 D	K2.1 14 C	K2.2 11 C	K2.3 9 C	K3.1 12 C	K3.2 9 C	N1.1 22 F	N1.2 16 F	N1.3 9 F	N2.1 25 E	N2.2 22 E
N2.3 14 E	N3.1 45 D	N3.2 26 E	N3.3 12 D	N4.1 28 B									

Product	DC (inch)	DC (Wire gauge size)	DC (inch)	DCON MS (inch)	LCF (inch)	OAL (inch)	NOF
B610N60	–	N60	0.0400	0.039	1/2	2.1/2	4
B610N59	–	N59	0.0410	0.039	1/2	2.1/2	4
B610N58	–	N58	0.0420	0.039	1/2	2.1/2	4
B610N57	–	N57	0.0430	0.039	1/2	2.1/2	4
B610N56	–	N56	0.0465	0.045	1/2	2.1/2	4
B6103/64	3/64	–	0.0469	0.045	1/2	2.1/2	4
B610N55	–	N55	0.0520	0.051	1/2	2.1/2	4
B610N54	–	N54	0.0550	0.051	1/2	2.1/2	4
B610N53	–	N53	0.0595	0.059	1/2	2.1/2	4
B6101/16	1/16	–	0.0625	0.059	1/2	2.1/2	4
B610N52	–	N52	0.0635	0.059	1/2	2.1/2	4
B610N51	–	N51	0.0670	0.066	3/4	3"	4
B610N50	–	N50	0.0700	0.066	3/4	3"	4
B610N49	–	N49	0.0730	0.066	3/4	3"	4
B610N48	–	N48	0.0760	0.072	3/4	3"	4
B6105/64	5/64	–	0.0781	0.072	3/4	3"	4
B610N47	–	N47	0.0785	0.072	3/4	3"	4
B610N46	–	N46	0.0810	0.077	3/4	3"	4
B610N45	–	N45	0.0820	0.077	3/4	3"	4
B610N44	–	N44	0.0860	0.081	3/4	3"	4
B610N43	–	N43	0.0890	0.081	3/4	3"	4
B610N42	–	N42	0.0935	0.088	3/4	3"	4
B6103/32	3/32	–	0.0938	0.088	3/4	3"	4
B610N41	–	N41	0.0960	0.093	7/8	3.1/2	4
B610N40	–	N40	0.0980	0.093	7/8	3.1/2	4
B610N39	–	N39	0.0995	0.093	7/8	3.1/2	4
B610N38	–	N38	0.1015	0.095	7/8	3.1/2	4
B610N37	–	N37	0.1040	0.095	7/8	3.1/2	4

Product	DC (inch)	DC (Wire gauge size)	DC (inch)	DCON MS (inch)	LCF (inch)	OAL (inch)	NOF
B610N36	–	N36	0.1065	0.103	7/8	3.1/2	4
B6107/64	7/64	–	0.1094	0.103	7/8	3.1/2	4
B610N35	–	N35	0.1100	0.103	7/8	3.1/2	4
B610N34	–	N34	0.1110	0.105	7/8	3.1/2	4
B610N33	–	N33	0.1130	0.105	7/8	3.1/2	4
B610N32	–	N32	0.1160	0.112	7/8	3.1/2	4
B610N31	–	N31	0.1200	0.112	7/8	3.1/2	4
B610.1230	–	–	0.1230	0.112	7/8	3.1/2	4
B610.1240	–	–	0.1240	0.119	7/8	3.1/2	4
B610.1247	–	–	0.1247	0.119	7/8	3.1/2	4
B6101/8	1/8	–	0.1250	0.119	7/8	3.1/2	4
B610.1260	–	–	0.1260	0.119	7/8	3.1/2	4
B610N30	–	N30	0.1285	0.119	7/8	3.1/2	4
B610N29	–	N29	0.1360	0.128	1"	4"	4
B610N28	–	N28	0.1400	0.135	1"	4"	4
B6109/64	9/64	–	0.1410	0.135	1"	4"	4
B610N27	–	N27	0.1440	0.135	1"	4"	4
B610N26	–	N26	0.1470	0.143	1"	4"	4
B610N25	–	N25	0.1495	0.143	1"	4"	4
B610N24	–	N24	0.1520	0.146	1"	4"	4
B610N23	–	N23	0.1540	0.146	1"	4"	4
B6105/32	5/32	–	0.1562	0.151	1"	4"	6
B610N22	–	N22	0.1570	0.151	1"	4"	6
B610N21	–	N21	0.1590	0.153	1.1/8	4.1/2	6
B610N20	–	N20	0.1610	0.153	1.1/8	4.1/2	6
B610N19	–	N19	0.1660	0.160	1.1/8	4.1/2	6
B610N18	–	N18	0.1695	0.160	1.1/8	4.1/2	6
B61011/64	11/64	–	0.1719	0.165	1.1/8	4.1/2	6

Product	DC	DC	DC	DCON MS	LCF	OAL	NOF
	(inch)	(Wire gauge size)	(inch)	(inch)	(inch)	(inch)	
B610N17	–	N17	0.1730	0.165	1.1/8	4.1/2	6
B610N16	–	N16	0.1770	0.170	1.1/8	4.1/2	6
B610N15	–	N15	0.1800	0.175	1.1/8	4.1/2	6
B610N14	–	N14	0.1820	0.175	1.1/8	4.1/2	6
B610N13	–	N13	0.1850	0.180	1.1/8	4.1/2	6
B610.1855	–	–	0.1855	0.180	1.1/8	4.1/2	6
B610.1865	–	–	0.1865	0.180	1.1/8	4.1/2	6
B610.1870	–	–	0.1870	0.180	1.1/8	4.1/2	6
B6103/16	3/16	–	0.1875	0.180	1.1/8	4.1/2	6
B610.1885	–	–	0.1885	0.180	1.1/8	4.1/2	6
B610N12	–	N12	0.1890	0.180	1.1/8	4.1/2	6
B610N11	–	N11	0.1910	0.186	1.1/4	5"	6
B610N10	–	N10	0.1935	0.186	1.1/4	5"	6
B610N9	–	N9	0.1960	0.190	1.1/4	5"	6
B610N8	–	N8	0.1990	0.190	1.1/4	5"	6
B610N7	–	N7	0.2010	0.195	1.1/4	5"	6
B61013/64	13/64	–	0.2031	0.195	1.1/4	5"	6
B610N6	–	N6	0.2040	0.195	1.1/4	5"	6
B610N5	–	N5	0.2055	0.202	1.1/4	5"	6
B610N4	–	N4	0.2090	0.202	1.1/4	5"	6
B610N3	–	N3	0.2130	0.207	1.1/4	5"	6
B6107/32	7/32	–	0.2188	0.207	1.1/4	5"	6
B610N2	–	N2	0.2210	0.217	1.1/2	6"	6
B610N1	–	N1	0.2280	0.217	1.1/2	6"	6
B610A	–	–	0.2340	0.227	1.1/2	6"	6
B61015/64	15/64	–	0.2344	0.227	1.1/2	6"	6
B610B	–	–	0.2380	0.233	1.1/2	6"	6
B610C	–	–	0.2420	0.233	1.1/2	6"	6
B610D	–	–	0.2460	0.233	1.1/2	6"	6
B610.2480	–	–	0.2480	0.233	1.1/2	6"	6
B610.2490	–	–	0.2490	0.240	1.1/2	6"	6
B610.2495	–	–	0.2495	0.240	1.1/2	6"	6
B6101/4	1/4	–	0.2500	0.240	1.1/2	6"	6
B610.2510	–	–	0.2510	0.240	1.1/2	6"	6
B610F	–	–	0.2570	0.248	1.1/2	6"	6
B610G	–	–	0.2610	0.248	1.1/2	6"	6
B61017/64	17/64	–	0.2656	0.248	1.1/2	6"	6
B610H	–	–	0.2660	0.248	1.1/2	6"	6
B610LETTERI	–	–	0.2720	0.248	1.1/2	6"	6
B610J	–	–	0.2770	0.248	1.1/2	6"	6
B610K	–	–	0.2810	0.248	1.1/2	6"	6
B6109/32	9/32	–	0.2812	0.248	1.1/2	6"	6
B610L	–	–	0.2900	0.279	1.1/2	6"	6
B610M	–	–	0.2950	0.279	1.1/2	6"	6
B61019/64	19/64	–	0.2969	0.279	1.1/2	6"	6
B610N	–	–	0.3020	0.279	1.1/2	6"	6
B610.3105	–	–	0.3105	0.279	1.1/2	6"	6
B610.3115	–	–	0.3115	0.279	1.1/2	6"	6
B610.3120	–	–	0.3120	0.279	1.1/2	6"	6
B6105/16	5/16	–	0.3125	0.279	1.1/2	6"	6
B610.3135	–	–	0.3135	0.279	1.1/2	6"	6
B610O	–	–	0.3160	0.279	1.1/2	6"	6
B610P	–	–	0.3230	0.279	1.1/2	6"	6
B61021/64	21/64	–	0.3281	0.279	1.1/2	6"	6
B610Q	–	–	0.3320	0.279	1.1/2	6"	6
B610R	–	–	0.3390	0.279	1.1/2	6"	6
B61011/32	11/32	–	0.3438	0.279	1.1/2	6"	6
B610S	–	–	0.3480	0.310	1.3/4	7"	6
B610T	–	–	0.3580	0.310	1.3/4	7"	6
B61023/64	23/64	–	0.3594	0.310	1.3/4	7"	6
B610U	–	–	0.3680	0.310	1.3/4	7"	6
B610.3730	–	–	0.3730	0.310	1.3/4	7"	6

Product	DC	DC	DC	DCON MS	LCF	OAL	NOF
	(inch)	(Wire gauge size)	(inch)	(inch)	(inch)	(inch)	
B610.3740	–	–	0.3740	0.310	1.3/4	7"	6
B610.3745	–	–	0.3745	0.310	1.3/4	7"	6
B6103/8	3/8	–	0.3750	0.310	1.3/4	7"	6
B610.3760	–	–	0.3760	0.310	1.3/4	7"	6
B610V	–	–	0.3770	0.310	1.3/4	7"	6
B610W	–	–	0.3860	0.310	1.3/4	7"	6
B61025/64	25/64	–	0.3910	0.310	1.3/4	7"	6
B610X	–	–	0.3970	0.310	1.3/4	7"	6
B610Y	–	–	0.4040	0.310	1.3/4	7"	6
B61013/32	13/32	–	0.4062	0.310	1.3/4	7"	6
B610Z	–	–	0.4130	0.373	1.3/4	7"	6
B61027/64	27/64	–	0.4219	0.373	1.3/4	7"	6
B610.4355	–	–	0.4355	0.373	1.3/4	7"	6
B610.4365	–	–	0.4365	0.373	1.3/4	7"	6
B610.4370	–	–	0.4370	0.373	1.3/4	7"	6
B6107/16	7/16	–	0.4375	0.373	1.3/4	7"	6
B610.4385	–	–	0.4385	0.373	1.3/4	7"	6
B61029/64	29/64	–	0.4531	0.373	1.3/4	7"	6
B61015/32	15/32	–	0.4688	0.373	1.3/4	7"	6
B61031/64	31/64	–	0.4844	0.435	2"	8"	6
B610.4980	–	–	0.4980	0.435	2"	8"	6
B610.4990	–	–	0.4990	0.435	2"	8"	6
B610.4995	–	–	0.4995	0.435	2"	8"	6
B6101/2	1/2	–	0.5000	0.435	2"	8"	6
B610.5010	–	–	0.5010	0.435	2"	8"	6
B61033/64	33/64	–	0.5156	0.435	2"	8"	6
B61017/32	17/32	–	0.5312	0.435	2"	8"	6
B61035/64	35/64	–	0.5469	0.435	2"	8"	8
B6109/16	9/16	–	0.5625	0.435	2"	8"	8
B61037/64	37/64	–	0.5781	0.435	2"	8"	8
B61019/32	19/32	–	0.5938	0.435	2"	8"	8
B61039/64	39/64	–	0.6094	0.562	2.1/4	9"	8
B6105/8	5/8	–	0.6250	0.562	2.1/4	9"	8
B61041/64	41/64	–	0.6410	0.562	2.1/4	9"	8
B61021/32	21/32	–	0.6562	0.562	2.1/4	9"	8
B61043/64	43/64	–	0.6719	0.562	2.1/4	9"	8
B61011/16	11/16	–	0.6875	0.562	2.1/4	9"	8
B61045/64	45/64	–	0.7031	0.562	2.1/4	9"	8
B61023/32	23/32	–	0.7188	0.562	2.1/4	9"	8
B61047/64	47/64	–	0.7344	0.625	2.1/2	9.1/2	8
B6103/4	3/4	–	0.7500	0.625	2.1/2	9.1/2	8
B61049/64	49/64	–	0.7656	0.625	2.1/2	9.1/2	8
B61025/32	25/32	–	0.7812	0.625	2.1/2	9.1/2	8
B61051/64	51/64	–	0.7969	0.625	2.1/2	9.1/2	8
B61013/16	13/16	–	0.8125	0.625	2.1/2	9.1/2	8
B61053/64	53/64	–	0.8281	0.625	2.1/2	9.1/2	8
B61027/32	27/32	–	0.8438	0.625	2.1/2	9.1/2	8
B61055/64	55/64	–	0.8594	0.750	2.5/8	10"	8
B6107/8	7/8	–	0.8750	0.750	2.5/8	10"	8
B61057/64	57/64	–	0.8910	0.750	2.5/8	10"	8
B61029/32	29/32	–	0.9062	0.750	2.5/8	10"	8
B61059/64	59/64	–	0.9219	0.750	2.5/8	10"	8
B61015/16	15/16	–	0.9375	0.750	2.5/8	10"	8
B61061/64	61/64	–	0.9531	0.750	2.5/8	10"	8
B61031/32	31/32	–	0.9688	0.750	2.5/8	10"	8
B61063/64	63/64	–	0.9844	0.875	2.3/4	10.1/2	8
B6101	1"	–	1.0000	0.875	2.3/4	10.1/2	8
B6101.1/16	1.1/16	–	1.0625	0.875	2.3/4	10.1/2	8
B6101.1/8	1.1/8	–	1.1250	0.875	2.7/8	11"	8
B6101.3/16	1.3/16	–	1.1875	1.000	2.7/8	11"	8
B6101.1/4	1.1/4	–	1.2500	1.000	3"	11.1/2	8
B6101.3/8	1.3/8	–	1.3750	1.000	3.1/4	12"	8
B6101.1/2	1.1/2	–	1.5000	1.250	3.1/2	12.1/2	8

B620



HSS-fräs med rakt skaft och långsam spiral, blank yta

Mångsidiga brotschar för allmänt bruk har kortare och djupare raka skär än handbrotschar och är konstruerade för effektiv maskinbrotschning av de flesta material. Ett stort antal storlekar finns tillgängliga, inklusive tum, bokstavstorlekar och decimalstorlekar. Tillverkade enligt ANSI B94.2-1983 (R1988).

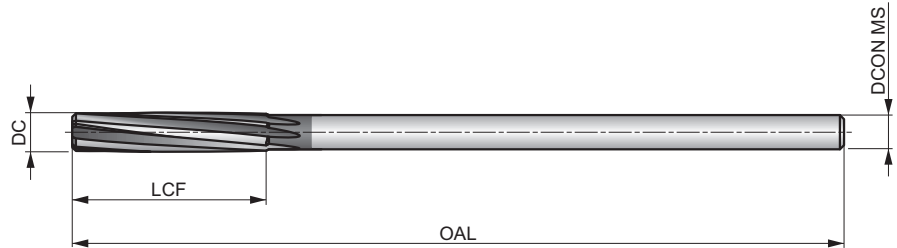

HSS	Bright	ANSI
R		

Arbetsmaterialgrupper och startvärden för skärhastighet (m/min) och matningskod. Tabeller med matningar finns med början på sidan 279

P1.1 ■ 21 C	P1.2 ■ 24 C	P1.3 ■ 25 C	P2.1 ■ 18 C	P2.2 ■ 16 C	P2.3 ■ 14 B	P3.1 ■ 13 B	P3.2 ■ 11 B	P3.3 ■ 9 B	P4.1 ■ 8 B	P4.2 ■ 7 B	P4.3 ■ 5 A	M1.1 ■ 11 C	M1.2 ■ 10 B
M2.1 ■ 9 B	M2.2 ■ 8 B	K1.1 ■ 16 E	K1.2 ■ 12 D	K1.3 ■ 9 D	K2.1 ■ 16 C	K2.2 ■ 13 C	K2.3 ■ 10 C	K3.1 ■ 14 C	K3.2 ■ 11 C	N1.1 ■ 24 F	N1.2 ■ 18 F	N1.3 ■ 11 F	N2.1 ■ 27 E
N2.2 ■ 24 E	N2.3 ■ 16 E	N3.1 ■ 47 D	N3.2 ■ 28 E	N3.3 ■ 14 D									

Product	DC	DC	DC	DCON MS	LCF	OAL	NOF
	(inch)	(Wire gauge size)	(inch)	(inch)	(inch)	(inch)	
B6201/16	1/16	—	0.0625	0.059	1/2	2.1/2	4
B6205/64	5/64	—	0.0781	0.072	3/4	3"	4
B6203/32	3/32	—	0.0938	0.088	3/4	3"	4
B6207/64	7/64	—	0.1094	0.103	7/8	3.1/2	4
B6201/8	1/8	—	0.1250	0.119	7/8	3.1/2	4
B6205/32	5/32	—	0.1562	0.151	1"	4"	6
B62011/64	11/64	—	0.1719	0.165	1.1/8	4.1/2	6
B6203/16	3/16	—	0.1875	0.180	1.1/8	4.1/2	6
B62013/64	13/64	—	0.2031	0.195	1.1/4	5"	6
B6207/32	7/32	—	0.2188	0.207	1.1/4	5"	6
B6201/4	1/4	—	0.2500	0.240	1.1/2	6"	6
B62017/64	17/64	—	0.2656	0.248	1.1/2	6"	6
B6209/32	9/32	—	0.2812	0.248	1.1/2	6"	6
B6205/16	5/16	—	0.3125	0.279	1.1/2	6"	6

Product	DC	DC	DC	DCON MS	LCF	OAL	NOF
	(inch)	(Wire gauge size)	(inch)	(inch)	(inch)	(inch)	
B62011/32	11/32	—	0.3438	0.279	1.1/2	6"	6
B6203/8	3/8	—	0.3750	0.310	1.3/4	7"	6
B62025/64	25/64	—	0.3910	0.310	1.3/4	7"	6
B62013/32	13/32	—	0.4062	0.310	1.3/4	7"	6
B6207/16	7/16	—	0.4375	0.373	1.3/4	7"	6
B62031/64	31/64	—	0.4844	0.435	2"	8"	6
B6201/2	1/2	—	0.5000	0.435	2"	8"	6
B62017/32	17/32	—	0.5312	0.435	2"	8"	6
B6209/16	9/16	—	0.5625	0.435	2"	8"	8
B6205/8	5/8	—	0.6250	0.562	2.1/4	9"	8
B62011/16	11/16	—	0.6875	0.562	2.1/4	9"	8
B6203/4	3/4	—	0.7500	0.625	2.1/2	9.1/2	8
B6207/8	7/8	—	0.8750	0.750	2.5/8	10"	8
B6201	1"	—	1.0000	0.875	2.3/4	10.1/2	8

B650



HSS handbrotch med rakt skär, blank yta

Kraftig handbrotch med raka skär som används för manuell efterbearbetning av borrade hål. Fyrkantig drivning gör det möjligt att rotera verktyget med en skiftnyckel eller montera verktyget stationärt för roterande delar. Lämplig för brotschning i de flesta material, inklusive stål. Tillverkad enligt ANSI B94.2-1983 (R1988).

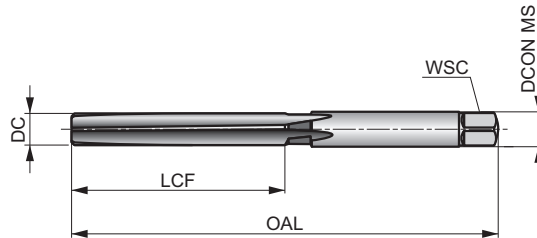

HSS	Bright	ANSI
R		

Arbetsmaterialgrupper

P1.1	P1.2	P1.3	P2.1	P2.2	P2.3	P3.1	P3.2	P3.3	P4.1	P4.2	P4.3	M1.1	M1.2
■	■	■	■	■	■	■	■	■	■	■	■	■	■
M2.1	K1.1	K1.2	K1.3	K2.1	K2.2	K2.3	K3.1	K3.2	N1.1	N1.2	N1.3	N2.1	N2.2
■	■	■	■	■	■	■	■	■	■	■	■	■	■
N2.3	N3.1	N3.2	N3.3	N4.1	N4.2								
■	■	■	■	■	■								

Product	DC	DC	LCF	OAL	NOF
	(inch)	(inch)	(inch)	(inch)	
B6501/8	1/8	0.1250	1.1/2	3"	6
B6503/16	3/16	0.1875	1.3/4	3.1/2	6
B6501/4	1/4	0.2500	2"	4"	6
B6505/16	5/16	0.3125	2.1/4	4.1/2	6
B6503/8	3/8	0.3750	2.1/2	5"	6
B6507/16	7/16	0.4375	2.3/4	5.1/2	6
B6501/2	1/2	0.5000	3"	6"	6
B6509/16	9/16	0.5625	3.1/4	6.1/2	8
B6505/8	5/8	0.6250	3.1/2	7"	8
B6503/4	3/4	0.7500	4.3/16	8.3/8	8
B6507/8	7/8	0.8750	4.7/8	9.3/4	8
B6501	1"	1.0000	5.7/16	10.7/8	8

B301

DORMER



Handbrottsch av HSS för koniska pinnhål, kona 1:48, blank och ånganlöp

Utformad för att brotscha pinnhål för koniska pinnar i tumdimensioner med kona 1 till 48. Med smal spets som enkelt kan äntra det förborrade hålet. Användbar i många olika materialsorters.

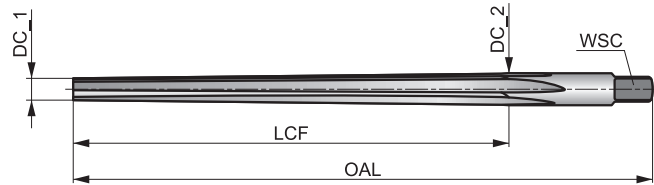

HSS	Bright ST	BS 328
R		A
1:48		

Arbetsmaterialgrupper

P1.1	P1.2	P1.3	P2.1	P2.2	P2.3	P3.1	P3.2	P3.3	P4.1	P4.2	P4.3	M1.1	M1.2
■	■	■	■	■	■	■	■	■	■	■	■	■	■
M2.1	K1.1	K1.2	K1.3	K2.1	K2.2	K2.3	K3.1	K3.2	N1.1	N1.2	N1.3	N2.1	N2.2
■	■	■	■	■	■	■	■	■	■	■	■	■	■
N2.3	N3.1	N3.2	N3.3	N4.1	N4.2								
■	■	■	■	■	■								

DC <= 1/4 toleransgräns +0,0030; DC >=9/32 toleransgräns +0,0050.

Product	nom d	DC_1	DC_2	OAL	LCF	NOF	WSC	DCON MS
		(mm)	(mm)	(mm)	(mm)		(mm)	(mm)
B3013/32	3/32	1.75	2.41	57.0	32.0	4	2.00	2.41
B3011/8	1/8	2.30	3.23	70.0	44.0	4	2.50	3.23
B3015/32	5/32	2.95	4.01	76.0	51.0	4	3.10	4.01
B3013/16	3/16	3.50	4.95	102.0	70.0	4	4.00	4.95
B3011/4	1/4	4.64	6.43	117.0	86.0	6	5.00	6.43
B3015/16	5/16	5.84	8.03	143.0	105.0	6	6.30	8.03
B3013/8	3/8	7.03	9.68	165.0	127.0	6	8.00	9.68
B3011/2	1/2	9.41	12.85	210.0	165.0	6	10.00	12.85

B953

DORMER



Konisk maskinbrottsch för pinnhål 1:50, blank

Utformad för att brotscha pinnhål för koniska pinnar i metrisk dimensioner med kona 1 till 50. Med snabb vänsterspiral och smal spets som enkelt kan äntra det förborrade hålet. Hög spiralvinkel. Användbar i många olika materialsorter.

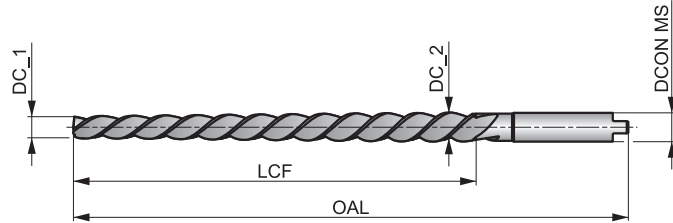

HSS-E	Bright	DIN 2179
R		1:50

Arbetsmaterialgrupper och startvärden för skärhastighet (m/min) och matningskod. Tabeller med matningar finns med början på sidan 279

P1.1 ■ 10 B	P1.2 ■ 12 B	P1.3 ■ 13 B	P2.1 ■ 9 B	P2.2 ■ 8 B	P2.3 ▣ 6 A	P3.1 ■ 7 A	P3.2 ▣ 6 A	P3.3 ▣ 3 A	P4.1 ■ 4 A	P4.2 ▣ 3 A	P4.3 ▣ 2 A	M1.1 ▣ 11 C	M1.2 ▣ 10 B
M2.1 ▣ 9 B	M2.2 ▣ 8 B	K1.1 ■ 10 C	K1.2 ■ 6 B	K1.3 ▣ 4 B	K2.1 ■ 8 A	K2.2 ■ 6 A	K2.3 ▣ 4 A	K3.1 ■ 7 A	K3.2 ▣ 4 A	N1.1 ▣ 14 D	N1.2 ■ 12 D	N1.3 ■ 9 D	N2.1 ■ 16 C
N2.2 ■ 14 C	N2.3 ▣ 10 C	N3.1 ■ 22 B	N3.2 ■ 14 C	N3.3 ▣ 6 B	N4.1 ▣ 22 B								

DCON MS tolerans h9.

Product	nom d	DC_1	DC_2	OAL	LCF	NOF	DCON MS
		(mm)	(mm)	(mm)	(mm)		(mm)
B9532.0	2.0	1.90	2.86	86.0	48.0	3	3.15
B9532.5	2.5	2.40	3.36	86.0	48.0	3	3.15
B9533.0	3.0	2.90	4.06	100.0	58.0	3	4.00
B9534.0	4.0	3.90	5.26	112.0	68.0	3	5.00
B9535.0	5.0	4.90	6.36	122.0	73.0	3	6.30
B9536.0	6.0	5.90	8.00	160.0	105.0	3	8.00
B9536.5	6.5	6.40	8.78	188.0	119.0	3	8.50
B9538.0	8.0	7.90	10.80	207.0	145.0	3	10.00
B95310.0	10.0	9.90	13.40	245.0	175.0	3	12.50
B95312.0	12.0	11.80	16.00	290.0	210.0	3	16.00

B903



Handbrottsch av HSS för koniska pinnhål, kona 1:50, blank och ånganlöp

Utformad för att brotscha pinnhål för koniska pinnar i metrisk dimensioner med kona 1 till 50. Med smal spets som enkelt kan ändra det förborrade hålet. Användbar i många olika materialsorters.

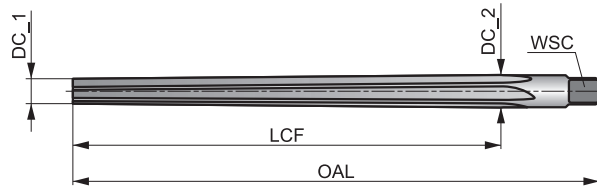

HSS	Bright ST	DIN 9
R		A
1:50		

Arbetsmaterialgrupper

P1.1	P1.2	P1.3	P2.1	P2.2	P2.3	P3.1	P3.2	P3.3	P4.1	P4.2	P4.3	M1.1	M1.2
■	■	■	■	■	■	■	■	■	■	■	■	■	■
M2.1	K1.1	K1.2	K1.3	K2.1	K2.2	K2.3	K3.1	K3.2	N1.1	N1.2	N1.3	N2.1	N2.2
■	■	■	■	■	■	■	■	■	■	■	■	■	■
N2.3	N3.1	N3.2	N3.3	N4.1	N4.2								
■	■	■	■	■	■								

DCON MS tolerans h11; DC <= 5mm toleransgräns +0,0750; DC > 5mm toleransgräns +0,1250.

Product	nom d	DC_1	DC_2	OAL	LCF	NOF	WSC	DCON MS
		(mm)	(mm)	(mm)	(mm)		(mm)	(mm)
B9031.5	1.5	1.40	2.14	57.0	37.0	4	1.80	2.14
B9032.0	2.0	1.90	2.86	68.0	48.0	4	2.24	2.86
B9032.5	2.5	2.40	3.36	68.0	48.0	4	2.80	3.36
B9033.0	3.0	2.90	4.06	80.0	58.0	4	3.15	4.00
B9034.0	4.0	3.90	5.26	93.0	68.0	4	4.00	5.00
B9035.0	5.0	4.90	6.36	100.0	73.0	4	5.00	6.30
B9036.0	6.0	5.90	8.00	135.0	105.0	6	6.30	7.90
B9038.0	8.0	7.90	10.80	180.0	145.0	6	8.00	10.50
B90310.0	10.0	9.90	13.40	215.0	175.0	6	10.00	13.30
B90312.0	12.0	11.80	16.00	255.0	210.0	8	11.20	16.00
B90313.0	13.0	12.86	16.74	255.0	210.0	8	12.50	16.74
B90314.0	14.0	13.86	17.74	255.0	210.0	8	12.50	17.74
B90316.0	16.0	15.80	20.40	280.0	230.0	8	14.00	20.40
B90320.0	20.0	19.80	24.80	310.0	250.0	8	18.00	24.80

B952



Konisk handbrottsch för pinnhål 1:50, blank

Utformad för att brotscha pinnhål för koniska pinnar i metrisk dimensioner med kona 1 till 50. Med smal spets som enkelt kan äntra det förborrade hålet. Hög spiralvinkel. Användbar i många olika materialsorters.

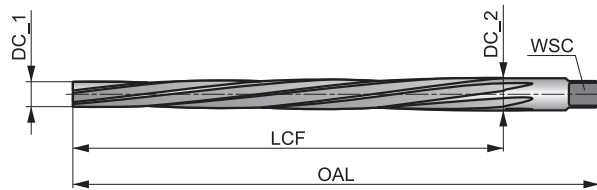

HSS	Bright	DIN 9
R		B
1:50		

Arbetsmaterialgrupper

P1.1	P1.2	P1.3	P2.1	P2.2	P2.3	P3.1	P3.2	P3.3	P4.1	P4.2	P4.3	M1.1	M1.2
■	■	■	■	■	■	■	■	■	■	■	■	■	■
M2.1	K1.1	K1.2	K1.3	K2.1	K2.2	K2.3	K3.1	K3.2	N1.1	N1.2	N1.3	N2.1	N2.2
■	■	■	■	■	■	■	■	■	■	■	■	■	■
N2.3	N3.1	N3.2	N3.3	N4.1	N4.2								
■	■	■	■	■	■								

DCON MS tolerans h11; DC <= 2,5mm Rakspårig, form A.

Product	nom d	DC_1	DC_2	OAL	LCF	NOF	WSC	DCON MS
		(mm)	(mm)	(mm)	(mm)			
B9521.2	1.2	1.10	1.74	50.0	32.0	3	2.40	3.15
B9521.5	1.5	1.40	2.14	57.0	37.0	3	2.40	3.15
B9522.0	2.0	1.90	2.86	68.0	48.0	3	2.40	3.15
B9522.5	2.5	2.40	3.36	68.0	48.0	4	2.40	3.15
B9523.0	3.0	2.90	4.06	80.0	58.0	5	3.00	4.00
B9523.5	3.5	3.40	4.66	87.0	63.0	5	3.40	4.50
B9524.0	4.0	3.90	5.26	93.0	68.0	5	3.80	5.00
B9525.0	5.0	4.90	6.36	100.0	73.0	5	4.90	6.30
B9526.0	6.0	5.90	8.00	135.0	105.0	6	6.20	8.00
B9527.0	7.0	6.90	9.40	160.0	125.0	6	7.00	9.00
B9528.0	8.0	7.90	10.80	180.0	145.0	6	8.00	10.00
B9529.0	9.0	8.90	12.10	195.0	160.0	6	9.00	11.20
B95210.0	10.0	9.90	13.40	215.0	175.0	6	10.00	12.50
B95212.0	12.0	11.80	16.00	255.0	210.0	8	11.00	14.00
B95213.0	13.0	12.80	17.00	255.0	210.0	8	12.00	16.00
B95214.0	14.0	13.80	18.00	255.0	210.0	8	12.00	16.00
B95216.0	16.0	15.80	20.40	280.0	230.0	8	14.50	18.00
B95220.0	20.0	19.80	24.80	310.0	250.0	8	18.00	22.40
B95225.0	25.0	24.70	30.70	370.0	300.0	10	22.00	28.00
B95230.0	30.0	29.70	36.10	400.0	320.0	10	24.00	31.50
B95240.0	40.0	39.70	46.50	430.0	340.0	12	32.00	40.00

B630



Maskinfräs med rakt skaft av HSS, konisk stifttyp, blank yta

Den långsamma högerspiralen gör att dessa brotschar ger en jämnare och mer vibrationsfri drift än brotschar med raka skär. Rekommenderas för mer svårbearbetade material, ger bättre ytfinish, utmärkt för avbrott och kan underlätta spånevakuering från blindhål. Tillverkad enligt ANSI B94.2-1983 (R1988).

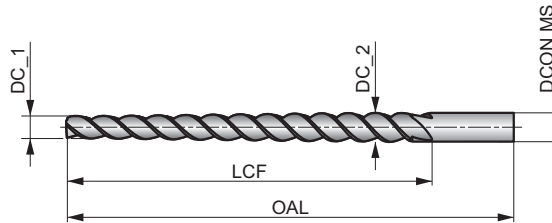

HSS	Bright	ANSI
R	1:48	

Arbetsmaterialgrupper och startvärden för skärhastighet (m/min) och matningskod. Tabeller med matningar finns med början på sidan 279

P1.1 ■ 10 B	P1.2 ■ 12 B	P1.3 ■ 13 B	P2.1 ■ 9 B	P2.2 ■ 8 B	P2.3 ▣ 6 A	P3.1 ■ 7 A	P3.2 ▣ 6 A	P3.3 ▣ 3 A	P4.1 ■ 4 A	P4.2 ▣ 3 A	P4.3 ▣ 2 A	M1.1 ▣ 11 C	M1.2 ▣ 10 B
M2.1 ▣ 9 B	M2.2 ▣ 8 B	K1.1 ■ 10 C	K1.2 ■ 6 B	K1.3 ▣ 4 B	K2.1 ■ 8 A	K2.2 ■ 6 A	K2.3 ▣ 4 A	K3.1 ■ 7 A	K3.2 ▣ 4 A	N1.1 ▣ 14 D	N1.2 ■ 12 D	N1.3 ■ 9 D	N2.1 ■ 16 C
N2.2 ■ 14 C	N2.3 ▣ 10 C	N3.1 ■ 22 B	N3.2 ■ 14 C	N3.3 ▣ 6 B	N4.1 ▣ 22 B								

Product	nom d	DC_1	DC_2	DCON MS	LCF	OAL	NOF
		(inch)	(inch)	(inch)	(inch)	(inch)	
B6307/0	7/0	0.0497	0.0666	5/64	13/16	1.13/16	2
B6306/0	6/0	0.0611	0.0810	3/32	15/16	1.15/16	2
B6305/0	5/0	0.0719	0.0966	7/64	1.3/16	2.3/16	2
B6304/0	4/0	0.0869	0.1142	1/8	1.5/16	2.5/16	2
B6303/0	3/0	0.1029	0.1300	9/64	1.5/16	5.5/16	2
B6302/0	2/0	0.1137	0.1462	5/32	1.9/16	2.9/16	3
B630N1	1	0.1447	0.1798	3/16	1.11/16	2.15/16	3
B630N2	2	0.1600	0.2010	13/64	1.15/16	3.3/16	3

Product	nom d	DC_1	DC_2	DCON MS	LCF	OAL	NOF
		(inch)	(inch)	(inch)	(inch)	(inch)	
B630N3	3	0.1813	0.2294	15/64	2.5/16	3.11/16	3
B630N4	4	0.2071	0.2600	17/64	2.9/16	4.1/16	3
B630N5	5	0.2410	0.2994	5/16	2.13/16	4.5/16	3
B630N6	6	0.2773	0.3540	23/64	3.11/16	5.7/16	3
B630N7	7	0.3297	0.4220	13/32	4.7/16	6.5/16	3
B630N8	8	0.3971	0.5050	7/16	5.3/16	7.3/16	3
B630N9	9	0.4800	0.6066	9/16	6.1/16	8.5/16	4
B630N10	10	0.5799	0.7216	5/8	6.13/16	9.5/16	4

B660



HSS handbrotch med rakt skär, konisk stifttyp, blank yta

Utformat för att omvandla ett rakt borrar hål till ett koniskt hål (1/4" per fot) för koniska standardstift (ASA B5.20-1958). Fyrkantig drivning gör det möjligt att rotera verktyget med en skiftnyckel eller montera verktyget stationärt för roterande delar. Lämplig för brotschning i de flesta material, inklusive stål. Tillverkad enligt ANSI B94.2-1983 (R1988).

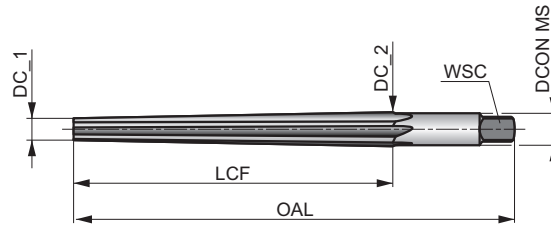

HSS	Bright	ANSI
R		1:48

Arbetsmaterialgrupper

P1.1	P1.2	P1.3	P2.1	P2.2	P2.3	P3.1	P3.2	P3.3	P4.1	P4.2	P4.3	M1.1	M1.2
■	■	■	■	■	■	■	■	■	■	■	■	■	■
M2.1	K1.1	K1.2	K1.3	K2.1	K2.2	K2.3	K3.1	K3.2	N1.1	N1.2	N1.3	N2.1	N2.2
■	■	■	■	■	■	■	■	■	■	■	■	■	■
N2.3	N3.1	N3.2	N3.3	N4.1	N4.2								
■	■	■	■	■	■								

Product	nom d	DC_1 (inch)	DC_2 (inch)	DCON MS (inch)	LCF (inch)	OAL (inch)	WSC (inch)	NOF
B660N0	0	0.1287	0.1638	11/64	1.11/16	2.15/16	0.130	6
B660N1	1	0.1447	0.1798	3/16	1.11/16	2.15/16	0.140	6
B660N2	2	0.1600	0.2010	13/64	1.15/16	3.3/16	0.150	6
B660N3	3	0.1813	0.2294	15/64	2.5/16	3.11/16	0.175	6
B660N4	4	0.2071	0.2600	17/64	2.9/16	4.1/16	0.200	6
B660N5	5	0.2410	0.2994	5/16	2.13/16	4.5/16	0.235	6
B660N6	6	0.2773	0.3540	23/64	3.11/16	5.7/16	0.270	6
B660N7	7	0.3297	0.4220	13/32	4.7/16	6.5/16	0.305	6
B660N8	8	0.3971	0.5050	7/16	5.3/16	7.3/16	0.330	6
B660N9	9	0.4800	0.6066	9/16	6.1/16	8.5/16	0.420	8
B660N10	10	0.5799	0.7216	5/8	6.13/16	9.5/16	0.470	8

B670



HSS spiral handbrotch, konisk stifttyp, blank yta

Högerskär med vänsterspiral för att fräsa ett koniskt hål (1/4" per fot) för koniska standardstift (ASA B5.20-1958). Fyrkantig drivning gör det möjligt att rotera verktyget eller montera verktyget statiskt för roterande delar. Spiralskär förbättrar ytfinishen genom att underlätta spånevakuering. Tillverkad enligt ANSI B94.2-1983 (R1988).

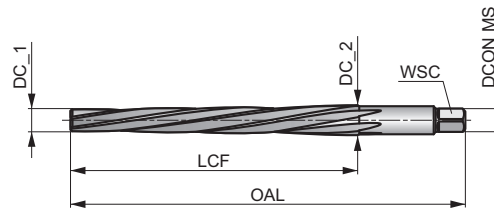

HSS	Bright	ANSI
R		1:48

Arbetsmaterialgrupper

P1.1	P1.2	P1.3	P2.1	P2.2	P2.3	P3.1	P3.2	P3.3	P4.1	P4.2	P4.3	M1.1	M1.2
■	■	■	■	■	■	■	■	■	■	■	■	■	■
M2.1	K1.1	K1.2	K1.3	K2.1	K2.2	K2.3	K3.1	K3.2	N1.1	N1.2	N1.3	N2.1	N2.2
■	■	■	■	■	■	■	■	■	■	■	■	■	■
N2.3	N3.1	N3.2	N3.3	N4.1	N4.2								
■	■	■	■	■	■								

Nom d är antalet koniska stift enligt American Standard Taper Pin Specification (ASA B5.20-1958)

Product	nom d	DC_1 (inch)	DC_2 (inch)	DCON MS (inch)	LCF (inch)	OAL (inch)	WSC (inch)	NOF
B670N0	0	0.1287	0.1638	11/64	1.11/16	2.15/16	0.130	6
B670N1	1	0.1447	0.1798	3/16	1.11/16	2.15/16	0.140	6
B670N2	2	0.1600	0.2010	13/64	1.15/16	3.3/16	0.150	6
B670N3	3	0.1813	0.2294	15/64	2.5/16	3.11/16	0.175	6
B670N4	4	0.2071	0.2600	17/64	2.9/16	4.1/16	0.200	6
B670N5	5	0.2410	0.2994	5/16	2.13/16	4.5/16	0.235	6
B670N6	6	0.2773	0.3540	23/64	3.11/16	5.7/16	0.270	6
B670N7	7	0.3297	0.4220	13/32	4.7/16	6.5/16	0.305	6
B670N8	8	0.3971	0.5050	7/16	5.3/16	7.3/16	0.330	6
B670N9	9	0.4800	0.6066	9/16	6.1/16	8.5/16	0.420	8
B670N10	10	0.5799	0.7216	5/8	6.13/16	9.5/16	0.470	8

B680

DORMER



HSS spiral handbrotch, NPT konisk rörtyp, blank yta

Högerskär med vänsterspiral för brotschning av ett koniskt hål (3/4" per fot) före NPT-gängning. Fyrkantig drivning gör det möjligt att rotera verktyget eller montera verktyget statiskt för roterande delar. Spiralskåret förbättrar ytfinishen genom att underlätta spånevakuering. Tillverkad enligt ANSI B94.2-1983 (R1988).

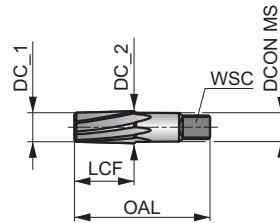

HSS	Bright	ANSI
R		

Arbetsmaterialgrupper

P1.1	P1.2	P1.3	P2.1	P2.2	P2.3	P3.1	P3.2	P3.3	P4.1	P4.2	P4.3	M1.1	M1.2
■	■	■	■	■	■	■	■	■	■	■	■	■	■
M2.1	K1.1	K1.2	K1.3	K2.1	K2.2	K2.3	K3.1	K3.2	N1.1	N1.2	N1.3	N2.1	N2.2
■	■	■	■	■	■	■	■	■	■	■	■	■	■
N2.3	N3.1	N3.2	N3.3	N4.1	N4.2								
■	■	■	■	■	■								

Nom d är NPT-rörets gängstorlek.

Product	nom d	DC_1	DC_2	DCON MS	LCF	OAL	WSC	NOF
		(inch)	(inch)	(inch)	(inch)	(inch)	(inch)	
B6801/8	1/8	0.3160	0.3620	0.438	3/4	2.1/8	0.328	6
B6801/4	1/4	0.4060	0.4720	0.563	1.1/16	2.7/16	0.421	6
B6803/8	3/8	0.5400	0.6060	0.700	1.1/16	2.9/16	0.531	8
B6801/2	1/2	0.6650	0.7510	0.688	1.3/8	3.1/8	0.575	8
B6803/4	3/4	0.8760	0.9620	0.906	1.3/8	3.1/4	0.679	10
B6801	1"	1.1030	1.2120	1.125	1.3/4	3.3/4	0.843	10

B122



Konisk brotsch av HSS med cylindriskt fäste, gulanlöpt

Avsedd att användas för att rikta upp hål i tunnplåt innan ihopnitning. Brotschkroppens främre del är konisk för att kunna äntra lätt. Därefter är kroppen cylindrisk. Användbar i de flesta material.

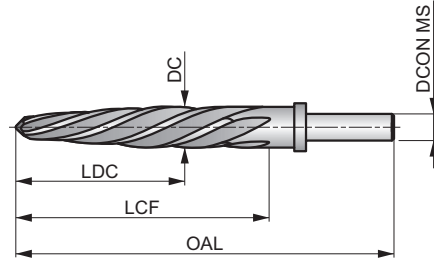

HSS	ST Bronze	ANSI
R		

Arbetsmaterialgrupper och startvärden för skärhastighet (m/min) och matningskod. Tabeller med matningar finns med början på sidan 279

P1.1 ■ 15 C	P1.2 ■ 16 C	P1.3 ■ 17 C	P2.1 ■ 13 C	P2.2 ■ 11 C	P3.1 ■ 7 B	M1.1 ■ 11 C	M1.2 ■ 10 B	M2.1 ■ 9 B	N1.1 ■ 23 F	N1.2 ■ 17 F	N2.1 ■ 23 E	N2.2 ■ 21 E	N3.1 ■ 34 D
N3.2 ■ 20 E	N4.1 ■ 22 B	N4.2 ■ 21 B											

Product	DC	DC	OAL	LCF	NOF	DCON MS
	(inch)	(inch)	(inch)	(inch)		
B1223/8	3/8	0.3750	4.5/8	2.1/2	4	3/8
B1221/2	1/2	0.5000	5.7/8	3.3/4	5	1/2
B1229/16	9/16	0.5625	5.7/8	3.3/4	5	1/2
B1225/8	5/8	0.6250	6.3/8	4.1/4	5	1/2
B12211/16	11/16	0.6875	6.3/8	4.1/4	5	1/2
B1223/4	3/4	0.7500	6.7/8	4.1/2	5	1/2
B12213/16	13/16	0.8125	6.7/8	4.1/2	5	1/2
B1227/8	7/8	0.8750	6.7/8	4.1/2	5	1/2
B12215/16	15/16	0.9375	6.7/8	4.1/2	5	1/2
B1221	1"	1.0000	6.7/8	4.1/2	5	1/2

Verktygsmaterial (BMC)	HSS	HSS	HSS	HSS	HSS	HSS	HSS
Standard (BSG)	DIN ANSI	DIN 338	DIN 338	DIN 338	DIN 338	DIN 338	DIN 338
Användbar längd (ULDR)	2.5xD	4xD	4xD	4xD	4xD	4xD	4xD
Spetsvinkel							
Beläggning							
Skافت							
Spiralform							
Skärriktning							
Produktfamilj	A088	A089	A087	A094	A095	A099 Drillboy	A188
PSF skärdiameter	Set	Set	Set	Set	Set	Set	Set
	92	92	93	93	94	94	95
P	P1						
	P2						
	P3						
	P4						
M	M1						
	M2						
	M3						
	M4						
K	K1						
	K2						
	K3						
	K4						
	K5						
N	N1						
	N2						
	N3						
	N4						
	N5						
S	S1						
	S2						
	S3						
	S4						
H	H1						
	H2						
	H3						
	H4						

- | | | | | |
|---------|---------|---------|---------|----------|
| HSS-E | HSS | HSS | HSS | Cr steel |
| DIN 338 | DIN 338 | DIN 338 | DIN 338 | |
| 4×D | 4×D | 4×D | 4×D | |
| | | | | |
| | | | | |
| | | | | |
| | | | | |
| | | | | |



	A295	A190	A191	A191_2	M900	M901	M902	A080
	Set	Set	Set	Set	Size 1 - 9	Set	Set	Set
	95	96	97	97	98	99	99	99
P1					■			
P2					■			
P3					■			
P4					■			
M1					■			
M2					■			
M3					■			
M4					■			
K1					■			
K2					■			
K3					■			
K4					■			
K5					■			
N1					■			
N2					■			
N3					■			
N4					■			
N5					■			
S1								
S2								
S3								
S4								
H1								
H2								
H3								
H4								

A088



Borrsats med extrakorta A022 HSS-borrar med TiN-belagd spets

Borrsats med 24 st A022-borr i en kompakt och praktisk ask med tydlig märkning för varje borr. De TiN-belagda borrarne är mycket användbara i de flesta material.

HSS	DIN ANSI	2.5×D
135°	TiN-Tip	
λ 20-35°	R	DC h8

A=ingående produkt, B=antal i satsen, C=diametrar i satsen. DC <= 1,4mm 4-fasettspets.

Product	Nr.	A	B	C
A0882005	2005	A022	24	1.0 mm - 10.5 mm x 0.5 mm + 3.3 mm, 4.2 mm, 6.8 mm, 10.2 mm

A089



Borrsats med A002 HSS-borrar med TiN-belagd spets

Borrsats med 5 st av de populära A002-borren i en kompakt och praktisk ask med tydlig märkning för varje borr. De TiN-belagda borrarne är mycket användbara i de flesta material.

HSS	DIN 338	4×D
118°	TiN-Tip	
λ 20-35°	R	DC h8

A=ingående produkt, B=antal i satsen, C=diametrar i satsen. DC <= 1,4mm 4-fasettspets.

Product	Nr.	A	B	C
A08910	10	A002	5	A0024.0, A0025.0, A0026.0, A0028.0, A00210.0

A087

DORMER



Borrsats med A002 HSS-borrar med TiN-belagd spets

Borrsats med 19 st av de populära A002-borren i en kompakt och praktisk ask med tydlig märkning för varje borr. De TiN-belagda borrararna är mycket användbara i de flesta material.

HSS	DIN 338	4xD
118°	TiN-Tip	
λ.20-35°	R	DC h8

A=ingående produkt, B=antal i satsen, C=diametrar i satsen. 1,0mm =< DC >= 2,9mm 118° 4-fasettspets.

Product	Nr.	A	B	C
A087201	201	A002	19	1.0 mm - 10.0 mm x 0.5 mm

A094

DORMER



Borrsats med A002 HSS-borrar med TiN-belagd spets

Borrsats med 13 eller 19 st av de populära A002-borren i en rund plastask med tydlig märkning för varje borr. De TiN-belagda borrararna är mycket användbara i de flesta material.

HSS	DIN 338	4xD
118°	TiN-Tip	
λ.20-35°	R	DC h8

A=ingående produkt, B=antal i satsen, C=diametrar i satsen. 1,0mm =< DC >= 2,9mm 118° 4-fasettspets.

Product	Nr.	A	B	C
A094413	413	A002	13	1.5 mm - 6.5 mm x 0.5 mm + 3.3 mm, 4.2 mm
A094419	419	A002	19	1.0 mm - 10.0 mm x 0.5 mm

A095

DORMER

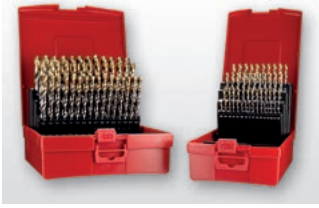

Borrsats med A002 HSS-borrar med TiN-belagd spets

Satserna finns i en rad varianter med mm eller tumdimensioner. Borrarna är förpackade i plastaskar med tydlig märkning för varje dimension. Satserna finns med diametrar i intervall om 0,5 mm eller 0,1 mm. A002-borrarna har TiN-belagd spets och fungerar i de flesta material.

HSS	DIN 338	4xD
118°	TiN-Tip	
λ 20-35°		DC h8

1,0mm =< DC >= 2,9mm 118° 4-fasettspets. A=ingående produkt, B=antal i satsen, C=diametrar i satsen.

Product	Nr.	A	B	C
A09518	18	A002	29	1/16 inch - 1/2 inch x 1/64 inch
A095200	200	A002	24	1.0 mm - 10.5 mm x 0.5 mm + 3.3 mm, 4.2 mm, 6.8 mm, 10.2 mm
A095201	201	A002	19	1.0 mm - 10.0 mm x 0.5 mm
A095202	202	A002	51	1.0 mm - 6.0 mm x 0.1 mm
A095203	203	A002	41	6.0 mm - 10.0 mm x 0.1 mm
A095204	204	A002	25	1.0 mm - 13.0 mm x 0.5 mm
A095206	206	A002	29	1.0 mm - 13.0 mm x 0.5 mm + 3.3 mm, 4.2 mm, 6.8 mm, 10.2 mm
A095209	209	A002	91	1.0 mm - 10.0 mm x 0.1 mm

A099 Drillboy

DORMER



Drillboy med A002 HSS-borrar med TiN-belagd spets

Bänkdispenser med A002-borrar. Avsedd för skyltning på en bänk. Enkel att fylla på vid behov.

HSS	DIN 338	4xD
118°	TiN-Tip	
λ 20-35°		DC h8

1,0mm =< DC >= 2,9mm 118° 4-fasettspets. A=ingående produkt, B=antal i satsen, C=diametrar i satsen.

Product	Nr.	A	B	C
A099DRILLBOYXL	DRILLBOY	A002	55	3 x (1.0, 1.5, 2.0, 2.5, 3.0, 3.3, 3.5, 4.0) + 2 x (4.2, 4.5, 5.0, 5.5, 6.0, 6.5, 6.8, 7.0, 7.5, 8.0) + 8.5, 9.0, 9.5, 10.0, 10.2, 10.5, 11.0, 11.5, 12.0, 12.5, 13.0 mm

A188

DORMER



Borrsats med A108 HSS-borrar, ånganlöpta

Borrsats med ånganlöpta A108-borr i praktisk plastask. Lämpliga framförallt för borring i rostfritt stål.

HSS	DIN 338	4xD
135°	ST	
λ > 35°	R	DC h8

A=ingående produkt, B=antal i satsen, C=diametrar i satsen. DC > 1,5mm; 1/16" Korsspets

Product	Nr.	A	B	C
A188201	201	A108	19	1.0 mm - 10.0 mm x 0.5 mm
A188204	204	A108	25	1.0 mm - 13.0 mm x 0.5 mm

A295

DORMER



Borrsats med A777-borrar av HSS-E (5% Kobolt), gulanlöpta

Borrsats med våra kraftiga A777-borrar. Förpackade i praktisk plastask. Borrarna är lämpliga för borring i hårda material

HSS-E	DIN 338	4xD
135°	Bronze	
λ 20-35°	R	DC h8

A=ingående produkt, B=antal i satsen, C=diametrar i satsen. DC <= 1,4mm 4-fasettspets.

Product	Nr.	A	B	C
A295219	219	A777	19	1.0 mm - 10.0 mm x 0.5 mm
A295225	225	A777	25	1.0 mm - 13.0 mm x 0.5 mm

A190



Borrsats med A100-borrar, ånganlöpta

Borrsats med A100-borr med konventionell 118° spets, som är enkel att slipa om. Finns i mm och tum-dimensioner. Borrarna är förpackade i plastaskar med tydlig märkning för varje dimension.

HSS	DIN 338	4xD
118°	ST	
λ 20-35°	R	DC h8

A=ingående produkt, B=antal i satsen, C=diametrar i satsen=antal i satsen, C=diametrar i satsen. DC <= 1mm; 3/64"; N60 Blank.

Product	Nr.	A	B	C
A1903	3	A100	21	1/16 inch - 3/8 inch x 1/64 inch
A19012	12	A100	60	No.1 - No.60
A19018	18	A100	29	1/16 inch - 1/2 inch x 1/64 inch
A19020	20	A100	15	1/16 inch - 1/2 inch x 1/32 inch
A190201	201	A100	19	1.0 mm - 10.0 mm x 0.5 mm
A190202	202	A100	51	1.0 mm - 6.0 mm x 0.1 mm
A190203	203	A100	41	6.0 mm - 10.0 mm x 0.1 mm
A190204	204	A100	25	1.0 mm - 13.0 mm x 0.5 mm
A190206	206	A100	29	1.0 mm - 13.0 mm x 0.5 mm + 3.3 mm, 4.2 mm, 6.8 mm, 10.2 mm
A190209 ¹⁾	209	A100	91	1.0 mm - 10.0 mm x 0.1 mm

¹⁾ Säljs i 2 askar: ask 1 innehåller diam. 1,0-5,9 x 0,1mm; ask 2 innehåller diam. 6,0-10,0 x 0,1mm.

A191



Borrsats med A100 HSS-borrar, ånganlöpta

Borrsats med ånganlöpta A100-borr i en kompakt ask. Finns i olika konstellationer med metriska, tum, eller nummerborr-dimensioner.

HSS	DIN 338	4xD
118°	Bright	
λ 20-35°	R	DC h8

A=ingående produkt, B=antal i satsen, C=diametrar i satsen=antal i satsen, C=diametrar i satsen. DC <= 1mm; 3/64"; N60 Blank.

Product	Nr.	A	B	C
A19131M	31M	A100	20	0.3 mm - 1.0 mm x 0.05 mm + 0.38 mm, 0.52 mm, 0.58 mm, 0.78 mm, 0.82 mm

A191_2



Borrsats med A100 HSS-borrar, ånganlöpta

Borrsats med ånganlöpta A100-borr i en rund plastask. Finns i olika konstellationer med metriska, tum, eller nummerborr-dimensioner.

HSS	DIN 338	4xD
118°	ST	
λ 20-35°	R	DC h8

A=ingående produkt, B=antal i satsen, C=diametrar i satsen=antal i satsen, C=diametrar i satsen. DC <= 1mm; 3/64"; N60 Blank.

Product	Nr.	A	B	C
A191413	413	A100	13	1.5 mm - 6.5 mm x 0.5 mm + 3.3 mm, 4.2 mm
A191419	419	A100	19	1.0 mm - 10.0 mm x 0.5 mm



M900



Bultutdragare

Bultutdragare vrids motsols för att avlägsna avbrutna hörgängade skruvar och bultar utan att förstöra gängan. Man bör borra ett styrhål av rätt storlek för utdragaren.

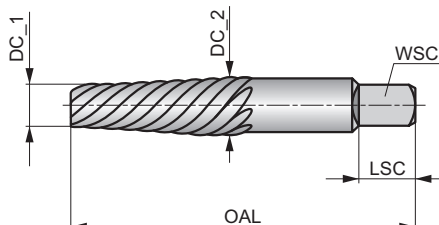

Borrstorlek A: Används för skruvar med låg eller medelhög draghållfasthet. B: För användning på skruvar med hög draghållfasthet

Product							DC_1	DC_2	WSC	LSC	OAL
		(mm)	(mm)	(inch)	(inch)	(inch)					
M9001	M5 - M6	2	2	3/16" - 1/4"	5/64	5/64	1.37	3.20	2.60	5.1	51.1
M9002	M6 - M8	2.8	3	1/4" - 5/16"	7/64	1/8	2.18	4.80	3.90	6.7	61.1
M9003	M8 - M12	4	4.2	5/16" - 7/16"	5/32	11/64	3.18	6.40	4.80	7.5	68.7
M9004	M12 - M14	5.5	6	7/16" - 9/16"	7/32	15/64	4.37	8.00	6.00	8	76.7
M9005	M14 - M20	7.2	8	9/16" - 3/4"	9/32	5/16	6.35	11.10	8.30	11.5	86.1
M9006	M20 - M30	10.5	11	3/4" - 1"	13/32	7/16	9.53	15.90	11.90	13.1	94.4
M9007	M30 - M42	13.5	14.5	1" - 1.3/8"	17/32	9/16	12.30	19.10	14.30	17.9	107.4
M9008	M42 - M45	20.5	21.5	1.3/8" - 1.3/4"	13/16	27/32	18.65	25.10	19.80	19.4	114.3
M9009	M45 - M50	27	28	1.3/4 - 2.1/8	1.1/16	1.3/32	24.61	32.30	24.60	22.6	121.3



M901

DORMER



Bultutdragare, sats

Sats med bultutdragare, storlek M9001 - M9005 eller M9001 - M9006.

A=ingående produkt, B=antal i satsen, C=diametrar i satsen.

Product	Nr.	A	B	C
M901A	A	M900	5	M9001-M9005
M901B	B	M900	6	M9001-M9006

M902



Bulturdragarsats

Verktyg för urtagning av brutna, högergängade bultar i set om fyra delar. Använd först filen P100 för att plana änden på bulten. Använd därefter P101 för att göra en försänkning i bultens centrum. Borra hål för utdragaren med HSS-E borrh A117. Skruva in utdragaren motsols i bulten för att gånga ur den utan att skada gängorna.

A=ingående produkt, B=antal i satsen, C=diametrar i satsen.

Product	Nr.	A	B	C
M902M6-M8	M6-M8	M900, P100, P101, A117	4	P1004.9, P1014.9, A1173.0, M9002
M902M8-M10	M8-M10	M900, P100, P101, A117	4	P1006.4, P1016.4, A1174.0, M9003
M902M10-M12	M10-M12	M900, P100, P101, A117	4	P1007.8, P1017.8, A1174.2, M9003
M902M12-M14	M12-M14	M900, P100, P101, A117	4	P1009.3, P1019.3, A1176.0, M9004
M902M14-M16	M14-M16	M900, P100, P101, A117	4	P10010.7, P10110.7, A1178.0, M9005

A080

DORMER



Tom borrdispenser

Tom dispenser som kan fyllas med borrar efter behov. Den är tillverkad av röd plast med Dormer-logotyp och bild på olika Dormerborr. De tre hyllorna är uppmärskade med mm-, alternativt tum-diametrar

Tom dispenser

Product	Nr.	C
A080M1EMPTY	M1EMPTY	(1.00, 1.50, 2.00, 2.50, 3.00, 3.50, 4.00, 4.50, 5.00, 5.50, 6.00, 6.50, 7.00, 7.50, 8.00, 8.50, 9.00, 9.50, 10.00, 10.50, 11.00, 11.50, 12.00) mm
A080F1EMPTY	F1EMPTY	(1/16, 5/64, 3/32, 7/64, 1/8, 9/64, 5/32, 11/64, 3/16, 13/64, 7/32, 15/64, 1/4, 17/64, 9/32, 19/64, 5/16, 21/64, 11/32, 3/8, 13/32, 7/16, 1/2) inch



**VERKTYG FÖR BLANDAD TILLVERKNING. ANVÄNDS VANLIGTVIS
MED KONVENTIONELLA MASKINER MED MASKINMATNING OCH CNC.**

Verktymsmaterial (BMC)	HSS-E	HSS	HSS-E	HSS-E	HSS-E	HM								
Standard (BSG)	DIN 1899	DIN 1897	DIN 1897	DIN 1897	DIN ANSI	DIN 6539								
Användbar längd (ULDR)	2.5×D	2.5×D	2.5×D	2.5×D	3×D	2.5×D								
Spetsvinkel	118°	130°	130°	135°	130°	120°								
Beläggning	Bright	TiN	Bronze	Bronze	Bright	TiN-Tip								
Skaft														
Spiralform	λ20-35°	λ32-40°	λ20-35°	λ20-35°	λ>35°	λ20-35°								
Skärriktning														
		ADX			PFX									
Produktfamilj	A720	A520	A620	A117	A920	R023								
PSF skärdiametrar	0.15 - 1.40	3.00 - 13.00	2.50 - 13.00	1.00 - 13.00	1.00 - 20.00	1.00 - 12.00								
	104	105	107	108	110	112								
P	P1	■	■	▣	▣	■	■							
	P2	■	■	▣	▣	■	■							
	P3	■	■	▣	▣	■	■							
	P4	▣	■	▣	■	■	■							
M	M1	▣	■	■	■	■	■							
	M2	▣	■	■	■	■	■							
	M3	▣	■	■	■	■	■							
	M4	▣	■	■	■	■	■							
K	K1	■	■	▣	▣	▣	■							
	K2	▣	■	▣	▣	▣	■							
	K3	▣	■	▣	▣	▣	■							
	K4	▣	■	▣	■	▣	▣							
	K5	▣	■	▣	▣	▣	■							
N	N1	▣	▣	▣	▣	▣	■							
	N2	▣	■	▣	▣	▣	▣							
	N3	▣	■	▣	▣	▣	▣							
	N4	▣	■	▣	▣	▣	■							
	N5													
S	S1	▣	■	▣	■	■								
	S2	▣	▣	▣	■	■								
	S3	▣	▣	▣	■	■								
	S4	▣	▣	▣	■	■								
H	H1						▣							
	H2						▣							
	H3						▣							
	H4													

A720



Mikroborr av HSS-E (5% Kobolt), blank

Mikro-borr med mycket små diametrar från 0,15 mm till 1,40 mm. För att förenkla inspänningen har borrarerna antingen 1,00 mm eller 1,50 mm skaftdiameter. Samtliga borrar har 118° 4-fasettspets som ger bra centrerig och minskar skärkraften.

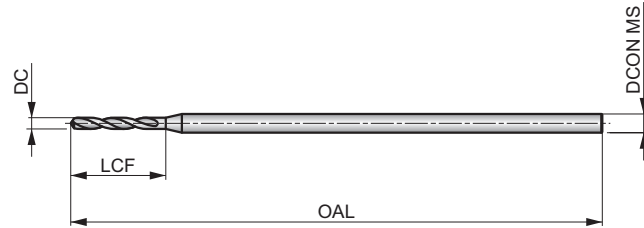

HSS-E	DIN 1899	2.5xD
118°	Bright	
λ 20-35°	R	

Arbetsmaterialgrupper och startvärden för skärhastighet (m/min) och matningskod. Tabeller med matningar finns med början på sidan 274

P1.1 ■ 36 A	P1.2 ■ 40 A	P1.3 ■ 41 A	P2.1 ■ 31 A	P2.2 ■ 27 A	P2.3 ■ 24 A	P3.1 ■ 25 A	P3.2 ■ 20 A	P3.3 ■ 17 A	P4.1 ■ 15 A	P4.2 ■ 13 A	P4.3 ■ 10 A	M1.1 ■ 30 A	M1.2 ■ 26 A
M2.1 ■ 27 A	M2.2 ■ 22 A	M3.1 ■ 12 A	M3.2 ■ 10 A	M3.3 ■ 9 A	M4.1 ■ 15 A	K1.1 ■ 30 A	K1.2 ■ 22 A	K1.3 ■ 17 A	K2.1 ■ 25 A	K2.2 ■ 20 A	K2.3 ■ 16 A	K3.1 ■ 22 A	K3.2 ■ 17 A
K3.3 ■ 13 A	K4.1 ■ 20 A	K4.2 ■ 15 A	K4.3 ■ 11 A	K4.4 ■ 10 A	K4.5 ■ 8 A	K5.1 ■ 23 A	K5.2 ■ 17 A	K5.3 ■ 13 A	N1.1 ■ 35 A	N1.2 ■ 26 A	N1.3 ■ 18 A	N2.1 ■ 42 A	N2.2 ■ 37 A
N2.3 ■ 27 A	N3.1 ■ 68 A	N3.2 ■ 40 A	N3.3 ■ 20 A	N4.1 ■ 48 A	N4.2 ■ 25 A	S1.1 ■ 23 A	S1.2 ■ 17 A	S1.3 ■ 8 A	S2.1 ■ 9 A	S2.2 ■ 6 A	S3.1 ■ 7 A	S3.2 ■ 4 A	S4.1 ■ 5 A
S4.2 ■ 3 A													

Product	DC (mm)	DC (inch)	LCF (mm)	OAL (mm)	D CON MS (mm)
A720.15	0.15	0.0059	1.0	25.0	1.00
A720.18	0.18	0.0070	1.4	25.0	1.00
A720.2	0.20	0.0079	1.8	25.0	1.00
A720.22	0.22	0.0087	1.8	25.0	1.00
A720.25	0.25	0.0098	2.2	25.0	1.00
A720.27	0.27	0.0106	2.2	25.0	1.00
A720.28	0.28	0.0110	2.2	25.0	1.00
A720.3	0.30	0.0118	2.2	25.0	1.00
A720.35	0.35	0.0138	2.8	25.0	1.00
A720.4	0.40	0.0157	3.6	25.0	1.00
A720.45	0.45	0.0177	3.6	25.0	1.00
A720.5	0.50	0.0197	4.0	25.0	1.00
A720.55	0.55	0.0217	4.5	25.0	1.00

Product	DC (mm)	DC (inch)	LCF (mm)	OAL (mm)	D CON MS (mm)
A720.6	0.60	0.0236	4.5	25.0	1.00
A720.62	0.62	0.0244	5.0	25.0	1.00
A720.65	0.65	0.0256	5.0	25.0	1.00
A720.7	0.70	0.0276	5.6	25.0	1.00
A720.75	0.75	0.0295	5.6	25.0	1.00
A720.8	0.80	0.0315	6.3	25.0	1.50
A720.85	0.85	0.0335	6.3	25.0	1.50
A720.9	0.90	0.0354	7.1	25.0	1.50
A720.95	0.95	0.0374	7.1	25.0	1.50
A7201.0	1.00	0.0394	8.0	25.0	1.50
A7201.05	1.05	0.0413	8.0	25.0	1.50
A7201.3	1.30	0.0512	10.0	25.0	1.50
A7201.4	1.40	0.0551	11.2	25.0	1.50

A520



ADX-borr av HSS, extrakort, TiN-belagd

Högproduktivt borr som ger hål med hög noggrannhet och finish. H9-tolerans möjlig under rätt förhållanden. 130° spetsvinkel och självcentrerande spets med svängda huvudeggar. TiN-beläggning ökar slitstyrka och livslängd. Används i CNC-maskiner och kan användas i de flesta material.

ADX

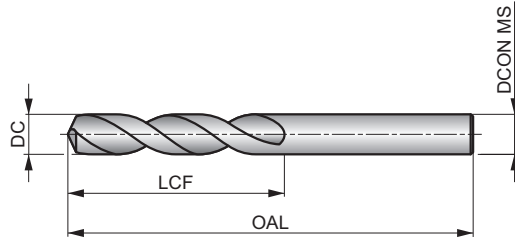

HSS	DIN 1897	2.5xD
130°	TiN	
λ 32-40°	R	DC h8

Arbetsmaterialgrupper och startvärden för skärhastighet (m/min) och matningskod. Tabeller med matningar finns med början på sidan 274

P1.1 ■ 53 M	P1.2 ■ 59 M	P1.3 ■ 61 M	P2.1 ■ 45 M	P2.2 ■ 40 K	P2.3 ■ 35 G	P3.1 ■ 31 I	P3.2 ■ 25 I	P3.3 ■ 21 G	P4.1 ■ 19 I	P4.2 ■ 16 G	P4.3 ■ 13 E	M1.1 ■ 41 I	M1.2 ■ 35 I
M2.1 ■ 37 I	M2.2 ■ 30 I	M3.1 ■ 19 I	M3.2 ■ 16 I	M3.3 ■ 14 I	M4.1 ■ 20 G	K1.1 ■ 48 M	K1.2 ■ 36 K	K1.3 ■ 27 K	K2.1 ■ 37 J	K2.2 ■ 30 J	K2.3 ■ 24 F	K3.1 ■ 33 J	K3.2 ■ 25 J
K3.3 ■ 20 F	K4.1 ■ 30 J	K4.2 ■ 23 J	K4.3 ■ 17 F	K4.4 ■ 14 F	K4.5 ■ 12 F	K5.1 ■ 34 J	K5.2 ■ 26 J	K5.3 ■ 20 F	N1.1 ■ 55 I	N1.2 ■ 41 I	N1.3 ■ 28 M	N2.1 ■ 57 K	N2.2 ■ 51 K
N2.3 ■ 37 K	N3.1 ■ 85 K	N3.2 ■ 50 I	N3.3 ■ 25 E	N4.1 ■ 65 G	N4.2 ■ 50 G	N4.3 ■ 35 F	S1.1 ■ 34 I	S1.2 ■ 20 G	S1.3 ■ 4 B	S2.1 ■ 15 G	S2.2 ■ 10 E	S3.1 ■ 11 G	S3.2 ■ 7 E
S4.1 ■ 9 G	S4.2 ■ 6 E												

Product	DC (inch)	DC (mm)	DC (inch)	LCF (mm)	OAL (mm)	DCON MS (mm)
A5203.0	-	3.00	0.1181	16.0	46.0	3.00
A5203.1	-	3.10	0.1220	18.0	49.0	3.10
A5201/8	1/8	3.18	0.1250	18.0	49.0	3.18
A5203.2	-	3.20	0.1260	18.0	49.0	3.20
A5203.3	-	3.30	0.1299	18.0	49.0	3.30
A5203.4	-	3.40	0.1339	20.0	52.0	3.40
A5203.5	-	3.50	0.1378	20.0	52.0	3.50
A5203.6	-	3.60	0.1417	20.0	52.0	3.60
A5203.7	-	3.70	0.1457	20.0	52.0	3.70
A5203.8	-	3.80	0.1496	22.0	55.0	3.80
A5203.9	-	3.90	0.1535	22.0	55.0	3.90
A5204.0	-	4.00	0.1575	22.0	55.0	4.00
A5204.1	-	4.10	0.1614	22.0	55.0	4.10
A5204.2	-	4.20	0.1654	22.0	55.0	4.20
A5204.3	-	4.30	0.1693	24.0	58.0	4.30
A52011/64	11/64	4.37	0.1719	24.0	58.0	4.37
A5204.4	-	4.40	0.1732	24.0	58.0	4.40
A5204.5	-	4.50	0.1772	24.0	58.0	4.50
A5204.6	-	4.60	0.1811	24.0	58.0	4.60
A5204.7	-	4.70	0.1850	24.0	58.0	4.70
A5203/16	3/16	4.76	0.1875	26.0	62.0	4.76
A5204.8	-	4.80	0.1890	26.0	62.0	4.80
A5204.9	-	4.90	0.1929	26.0	62.0	4.90
A5205.0	-	5.00	0.1969	26.0	62.0	5.00

Product	DC (inch)	DC (mm)	DC (inch)	LCF (mm)	OAL (mm)	DCON MS (mm)
A5205.1	-	5.10	0.2008	26.0	62.0	5.10
A5205.2	-	5.20	0.2047	26.0	62.0	5.20
A5205.3	-	5.30	0.2087	26.0	62.0	5.30
A5205.4	-	5.40	0.2126	28.0	66.0	5.40
A5205.5	-	5.50	0.2165	28.0	66.0	5.50
A5207/32	7/32	5.56	0.2188	28.0	66.0	5.56
A5205.6	-	5.60	0.2205	28.0	66.0	5.60
A5205.7	-	5.70	0.2244	28.0	66.0	5.70
A5205.8	-	5.80	0.2283	28.0	66.0	5.80
A5205.9	-	5.90	0.2323	28.0	66.0	5.90
A5206.0	-	6.00	0.2362	28.0	66.0	6.00
A5206.1	-	6.10	0.2402	31.0	70.0	6.10
A5206.2	-	6.20	0.2441	31.0	70.0	6.20
A5206.3	-	6.30	0.2480	31.0	70.0	6.30
A5201/4	1/4	6.35	0.2500	31.0	70.0	6.35
A5206.4	-	6.40	0.2520	31.0	70.0	6.40
A5206.5	-	6.50	0.2559	31.0	70.0	6.50
A5206.6	-	6.60	0.2598	31.0	70.0	6.60
A5206.7	-	6.70	0.2638	31.0	70.0	6.70
A52017/64	17/64	6.75	0.2656	34.0	74.0	6.75
A5206.8	-	6.80	0.2677	34.0	74.0	6.80
A5206.9	-	6.90	0.2717	34.0	74.0	6.90
A5207.0	-	7.00	0.2756	34.0	74.0	7.00
A5207.1	-	7.10	0.2795	34.0	74.0	7.10

Product	DC	DC	DC	LCF	OAL	D CON MS
	(inch)	(mm)	(inch)	(mm)	(mm)	(mm)
A5209/32	9/32	7.14	0.2813	34.0	74.0	7.14
A5207.2	–	7.20	0.2835	34.0	74.0	7.20
A5207.4	–	7.40	0.2913	34.0	74.0	7.40
A5207.5	–	7.50	0.2953	34.0	74.0	7.50
A5207.8	–	7.80	0.3071	37.0	79.0	7.80
A5207.9	–	7.90	0.3110	37.0	79.0	7.90
A5205/16	5/16	7.94	0.3125	37.0	79.0	7.94
A5208.0	–	8.00	0.3150	37.0	79.0	8.00
A5208.1	–	8.10	0.3189	37.0	79.0	8.10
A5208.2	–	8.20	0.3228	37.0	79.0	8.20
A5208.3	–	8.30	0.3268	37.0	79.0	8.30
A5208.4	–	8.40	0.3307	37.0	79.0	8.40
A5208.5	–	8.50	0.3346	37.0	79.0	8.50
A5208.6	–	8.60	0.3386	40.0	84.0	8.60
A5208.7	–	8.70	0.3425	40.0	84.0	8.70
A52011/32	11/32	8.73	0.3438	40.0	84.0	8.73
A5208.8	–	8.80	0.3465	40.0	84.0	8.80
A5209.0	–	9.00	0.3543	40.0	84.0	9.00
A5209.1	–	9.10	0.3583	40.0	84.0	9.10
A5209.5	–	9.50	0.3740	40.0	84.0	9.50
A5203/8	3/8	9.52	0.3750	43.0	89.0	9.52
A5209.6	–	9.60	0.3780	43.0	89.0	9.60
A5209.7	–	9.70	0.3819	43.0	89.0	9.70
A52025/64	25/64	9.92	0.3906	43.0	89.0	9.92

Product	DC	DC	DC	LCF	OAL	D CON MS
	(inch)	(mm)	(inch)	(mm)	(mm)	(mm)
A52010.0	–	10.00	0.3937	43.0	89.0	10.00
A52010.1	–	10.10	0.3976	43.0	89.0	10.10
A52010.2	–	10.20	0.4016	43.0	89.0	10.20
A52010.3	–	10.30	0.4055	43.0	89.0	10.30
A52013/32	13/32	10.32	0.4063	43.0	89.0	10.32
A52010.5	–	10.50	0.4134	43.0	89.0	10.50
A52027/64	27/64	10.72	0.4219	47.0	95.0	10.72
A52010.8	–	10.80	0.4252	47.0	95.0	10.80
A52011.0	–	11.00	0.4331	47.0	95.0	11.00
A52011.1	–	11.10	0.4370	47.0	95.0	11.10
A5207/16	7/16	11.11	0.4375	47.0	95.0	11.11
A52011.3	–	11.30	0.4449	47.0	95.0	11.30
A52011.5	–	11.50	0.4528	47.0	95.0	11.50
A52011.7	–	11.70	0.4606	47.0	95.0	11.70
A52011.8	–	11.80	0.4646	47.0	95.0	11.80
A52012.0	–	12.00	0.4724	51.0	102.0	12.00
A52012.1	–	12.10	0.4764	51.0	102.0	12.10
A52012.2	–	12.20	0.4803	51.0	102.0	12.20
A52031/64	31/64	12.30	0.4844	51.0	102.0	12.30
A52012.5	–	12.50	0.4921	51.0	102.0	12.50
A5201/2	1/2	12.70	0.5000	51.0	102.0	12.70
A52012.8	–	12.80	0.5039	51.0	102.0	12.80
A52013.0	–	13.00	0.5118	51.0	102.0	13.00

A620

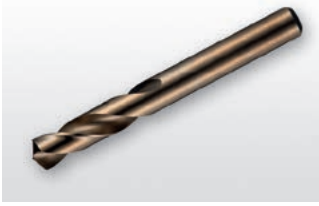

Extrakort borr av HSS-E (5% Kobolt), gulanlöpt

Ett effektivt borr för borring i de flesta stål och andra tuffa material. 130° spets med mycket kort tväregg gör borret självcentrerande och minskar skärkraften. Ett pålitligt borr med lång livslängd. Gulanlöpningen indikerar att borret är tillverkat av HSS-E stål med koboltinnehåll.

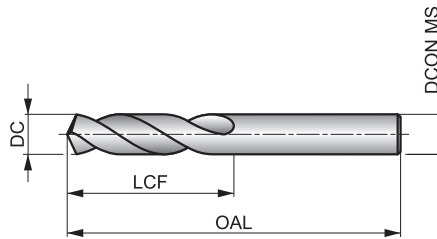

HSS-E	DIN 1897	2.5xD
130°	Bronze	
λ 20-35°	R	DC h8

Arbetsmaterialgrupper och startvärden för skärhastighet (m/min) och matningskod. Tabeller med matningar finns med början på sidan 274

P1.1 □40 H	P1.2 □45 H	P1.3 □46 H	P2.1 □34 H	P2.2 □30 G	P2.3 □27 F	P3.1 □27 G	P3.2 □21 G	P3.3 □18 F	P4.1 □16 G	P4.2 □13 F	P4.3 □11 E	M1.1 ■30 F	M1.2 ■26 F
M2.1 ■27 F	M2.2 ■22 F	M3.1 ■13 H	M3.2 ■11 H	M3.3 ■10 H	M4.1 ■15 D	K1.1 □34 K	K1.2 □25 F	K1.3 □19 F	K2.1 □27 F	K2.2 □22 F	K2.3 □18 F	K3.1 □24 F	K3.2 □18 F
K3.3 □15 F	K4.1 □22 F	K4.2 □17 F	K4.3 □12 F	K4.4 □11 F	K4.5 □9 F	K5.1 □25 F	K5.2 □19 F	K5.3 □15 F	N1.1 □40 K	N1.2 □30 K	N1.3 □20 J	N2.1 □49 I	N2.2 □44 I
N2.3 □32 I	N3.1 □68 J	N3.2 □40 K	N3.3 □20 I	N4.1 □40 L	N4.2 □32 K	N4.3 □18 I	S1.1 □30 G	S1.2 □18 F	S1.3 □10 C	S2.1 □12 F	S2.2 □8 C	S3.1 □9 F	S3.2 □6 C
S4.1 □7 F	S4.2 □5 C												

Product	DC (mm)	DC (inch)	LCF (mm)	OAL (mm)	DCON MS (mm)
A6202.5	2.50	0.0984	14.0	43.0	2.50
A6202.6	2.60	0.1024	14.0	43.0	2.60
A6202.7	2.70	0.1063	16.0	46.0	2.70
A6202.8	2.80	0.1102	16.0	46.0	2.80
A6202.9	2.90	0.1142	16.0	46.0	2.90
A6203.0	3.00	0.1181	16.0	46.0	3.00
A6203.1	3.10	0.1220	18.0	49.0	3.10
A6203.2	3.20	0.1260	18.0	49.0	3.20
A6203.3	3.30	0.1299	18.0	49.0	3.30
A6203.4	3.40	0.1339	20.0	52.0	3.40
A6203.5	3.50	0.1378	20.0	52.0	3.50
A6204.0	4.00	0.1575	22.0	55.0	4.00
A6204.1	4.10	0.1614	22.0	55.0	4.10
A6204.2	4.20	0.1654	22.0	55.0	4.20
A6204.3	4.30	0.1693	24.0	58.0	4.30
A6204.5	4.50	0.1772	24.0	58.0	4.50
A6204.7	4.70	0.1850	24.0	58.0	4.70
A6204.9	4.90	0.1929	26.0	62.0	4.90
A6205.0	5.00	0.1969	26.0	62.0	5.00
A6205.1	5.10	0.2008	26.0	62.0	5.10
A6205.2	5.20	0.2047	26.0	62.0	5.20
A6205.3	5.30	0.2087	26.0	62.0	5.30
A6205.5	5.50	0.2165	28.0	66.0	5.50
A6205.6	5.60	0.2205	28.0	66.0	5.60
A6206.0	6.00	0.2362	28.0	66.0	6.00

Product	DC (mm)	DC (inch)	LCF (mm)	OAL (mm)	DCON MS (mm)
A6206.2	6.20	0.2441	31.0	70.0	6.20
A6206.3	6.30	0.2480	31.0	70.0	6.30
A6206.5	6.50	0.2559	31.0	70.0	6.50
A6206.8	6.80	0.2677	34.0	74.0	6.80
A6206.9	6.90	0.2717	34.0	74.0	6.90
A6207.0	7.00	0.2756	34.0	74.0	7.00
A6207.5	7.50	0.2953	34.0	74.0	7.50
A6207.8	7.80	0.3071	37.0	79.0	7.80
A6208.0	8.00	0.3150	37.0	79.0	8.00
A6208.2	8.20	0.3228	37.0	79.0	8.20
A6208.5	8.50	0.3346	37.0	79.0	8.50
A6208.7	8.70	0.3425	40.0	84.0	8.70
A6209.0	9.00	0.3543	40.0	84.0	9.00
A6209.5	9.50	0.3740	40.0	84.0	9.50
A62010.0	10.00	0.3937	43.0	89.0	10.00
A62010.2	10.20	0.4016	43.0	89.0	10.20
A62010.3	10.30	0.4055	43.0	89.0	10.30
A62010.5	10.50	0.4134	43.0	89.0	10.50
A62010.8	10.80	0.4252	47.0	95.0	10.80
A62011.0	11.00	0.4331	47.0	95.0	11.00
A62011.5	11.50	0.4528	47.0	95.0	11.50
A62012.0	12.00	0.4724	51.0	102.0	12.00
A62012.5	12.50	0.4921	51.0	102.0	12.50
A62013.0	13.00	0.5118	51.0	102.0	13.00

A117



Extrakort borr av HSS-E (8% Kobolt), gulanlöp

Ett kraftigt borr för borrhining i legerat stål och andra tuffa material. 135° spets med korsspets gör borret självcentrerande och minskar skärkraften. Ett pålitligt borr med lång livslängd. Gulanlöpingen indikerar att borret är tillverkat av HSS-E stål med koboltinnehåll.

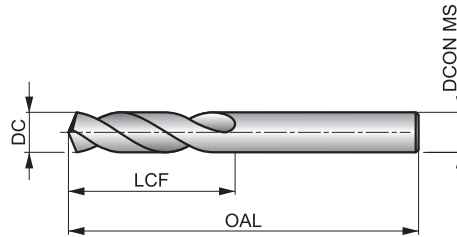

HSS-E	DIN 1897	2.5xD
135°	Bronze	
λ 20-35°	R	DC h8

Arbetsmaterialgrupper och startvärden för skärhastighet (m/min) och matningskod. Tabeller med matningar finns med början på sidan 274

P1.1 ■ 40 H	P1.2 ■ 45 H	P1.3 ■ 46 H	P2.1 ■ 34 H	P2.2 ■ 30 G	P2.3 ■ 27 F	P3.1 ■ 27 G	P3.2 ■ 21 G	P3.3 ■ 18 F	P4.1 ■ 16 G	P4.2 ■ 13 F	P4.3 ■ 11 E	M1.1 ■ 30 F	M1.2 ■ 26 F
M2.1 ■ 27 F	M2.2 ■ 22 F	M3.1 ■ 13 H	M3.2 ■ 11 H	M3.3 ■ 10 H	M4.1 ■ 15 D	K1.1 ■ 34 K	K1.2 ■ 25 F	K1.3 ■ 19 F	K2.1 ■ 27 F	K2.2 ■ 22 F	K2.3 ■ 18 F	K3.1 ■ 24 F	K3.2 ■ 18 F
K3.3 ■ 15 F	K4.1 ■ 22 F	K4.2 ■ 17 F	K4.3 ■ 12 F	K4.4 ■ 11 F	K4.5 ■ 9 F	K5.1 ■ 25 F	K5.2 ■ 19 F	K5.3 ■ 15 F	N1.1 ■ 35 K	N1.2 ■ 26 K	N1.3 ■ 18 J	N2.1 ■ 48 I	N2.2 ■ 43 I
N2.3 ■ 31 I	N3.1 ■ 68 J	N3.2 ■ 40 K	N3.3 ■ 20 I	N4.1 ■ 35 M	N4.2 ■ 28 K	N4.3 ■ 17 I	S1.1 ■ 30 G	S1.2 ■ 18 F	S1.3 ■ 10 C	S2.1 ■ 12 F	S2.2 ■ 8 C	S3.1 ■ 9 F	S3.2 ■ 6 C
S4.1 ■ 7 F	S4.2 ■ 5 C												

DC <= 1,5mm 118° spetsvinkel; DC < 3.00 mm 5% kobolt.

Product	DC (inch)	DC (mm)	DC (inch)	LCF (mm)	OAL (mm)	DCON MS (mm)
A1171.0	–	1.00	0.0394	6.0	26.0	1.00
A1171.1	–	1.10	0.0433	7.0	28.0	1.10
A1171.2	–	1.20	0.0472	8.0	30.0	1.20
A1171.3	–	1.30	0.0512	8.0	30.0	1.30
A1171.4	–	1.40	0.0551	9.0	32.0	1.40
A1171.5	–	1.50	0.0591	9.0	32.0	1.50
A1171.6	–	1.60	0.0630	10.0	34.0	1.60
A1171.7	–	1.70	0.0669	10.0	34.0	1.70
A1171.8	–	1.80	0.0709	11.0	36.0	1.80
A1171.9	–	1.90	0.0748	11.0	36.0	1.90
A1172.0	–	2.00	0.0787	12.0	38.0	2.00
A1172.1	–	2.10	0.0827	12.0	38.0	2.10
A1172.2	–	2.20	0.0866	13.0	40.0	2.20
A1172.3	–	2.30	0.0906	13.0	40.0	2.30
A1172.4	–	2.40	0.0945	14.0	43.0	2.40
A1172.5	–	2.50	0.0984	14.0	43.0	2.50
A1172.6	–	2.60	0.1024	14.0	43.0	2.60
A1172.7	–	2.70	0.1063	16.0	46.0	2.70
A1172.8	–	2.80	0.1102	16.0	46.0	2.80
A1172.9	–	2.90	0.1142	16.0	46.0	2.90
A1173.0	–	3.00	0.1181	16.0	46.0	3.00
A1173.1	–	3.10	0.1220	18.0	49.0	3.10
A1171/8	1/8	3.18	0.1250	18.0	49.0	3.18

Product	DC (inch)	DC (mm)	DC (inch)	LCF (mm)	OAL (mm)	DCON MS (mm)
A1173.2	–	3.20	0.1260	18.0	49.0	3.20
A1173.3	–	3.30	0.1299	18.0	49.0	3.30
A1173.4	–	3.40	0.1339	20.0	52.0	3.40
A1173.5	–	3.50	0.1378	20.0	52.0	3.50
A1173.6	–	3.60	0.1417	20.0	52.0	3.60
A1173.7	–	3.70	0.1457	20.0	52.0	3.70
A1173.8	–	3.80	0.1496	22.0	55.0	3.80
A1173.9	–	3.90	0.1535	22.0	55.0	3.90
A1175/32	5/32	3.97	0.1563	22.0	55.0	3.97
A1174.0	–	4.00	0.1575	22.0	55.0	4.00
A1174.1	–	4.10	0.1614	22.0	55.0	4.10
A1174.2	–	4.20	0.1654	22.0	55.0	4.20
A1174.3	–	4.30	0.1693	24.0	58.0	4.30
A1174.4	–	4.40	0.1732	24.0	58.0	4.40
A1174.5	–	4.50	0.1772	24.0	58.0	4.50
A1174.6	–	4.60	0.1811	24.0	58.0	4.60
A1174.7	–	4.70	0.1850	24.0	58.0	4.70
A1173/16	3/16	4.76	0.1875	26.0	62.0	4.76
A1174.8	–	4.80	0.1890	26.0	62.0	4.80
A1174.9	–	4.90	0.1929	26.0	62.0	4.90
A1175.0	–	5.00	0.1969	26.0	62.0	5.00
A1175.1	–	5.10	0.2008	26.0	62.0	5.10
A1175.2	–	5.20	0.2047	26.0	62.0	5.20



Product	DC	DC	DC	LCF	OAL	DCON MS
	(inch)	(mm)	(inch)	(mm)	(mm)	(mm)
A1175.3	–	5.30	0.2087	26.0	62.0	5.30
A1175.4	–	5.40	0.2126	28.0	66.0	5.40
A1175.5	–	5.50	0.2165	28.0	66.0	5.50
A1175.6	–	5.60	0.2205	28.0	66.0	5.60
A1175.7	–	5.70	0.2244	28.0	66.0	5.70
A1175.8	–	5.80	0.2283	28.0	66.0	5.80
A1175.9	–	5.90	0.2323	28.0	66.0	5.90
A1176.0	–	6.00	0.2362	28.0	66.0	6.00
A1176.1	–	6.10	0.2402	31.0	70.0	6.10
A1176.2	–	6.20	0.2441	31.0	70.0	6.20
A1176.3	–	6.30	0.2480	31.0	70.0	6.30
A1171/4	1/4	6.35	0.2500	31.0	70.0	6.35
A1176.4	–	6.40	0.2520	31.0	70.0	6.40
A1176.5	–	6.50	0.2559	31.0	70.0	6.50
A1176.6	–	6.60	0.2598	31.0	70.0	6.60
A1176.7	–	6.70	0.2638	31.0	70.0	6.70
A1176.8	–	6.80	0.2677	34.0	74.0	6.80
A1176.9	–	6.90	0.2717	34.0	74.0	6.90
A1177.0	–	7.00	0.2756	34.0	74.0	7.00
A1177.1	–	7.10	0.2795	34.0	74.0	7.10
A1177.2	–	7.20	0.2835	34.0	74.0	7.20
A1177.3	–	7.30	0.2874	34.0	74.0	7.30
A1177.4	–	7.40	0.2913	34.0	74.0	7.40
A1177.5	–	7.50	0.2953	34.0	74.0	7.50
A1177.6	–	7.60	0.2992	37.0	79.0	7.60
A1177.7	–	7.70	0.3031	37.0	79.0	7.70
A1177.8	–	7.80	0.3071	37.0	79.0	7.80

Product	DC	DC	DC	LCF	OAL	DCON MS
	(inch)	(mm)	(inch)	(mm)	(mm)	(mm)
A1177.9	–	7.90	0.3110	37.0	79.0	7.90
A1175/16	5/16	7.94	0.3125	37.0	79.0	7.94
A1178.0	–	8.00	0.3150	37.0	79.0	8.00
A1178.1	–	8.10	0.3189	37.0	79.0	8.10
A1178.2	–	8.20	0.3228	37.0	79.0	8.20
A1178.3	–	8.30	0.3268	37.0	79.0	8.30
A1178.4	–	8.40	0.3307	37.0	79.0	8.40
A1178.5	–	8.50	0.3346	37.0	79.0	8.50
A1178.6	–	8.60	0.3386	40.0	84.0	8.60
A1178.7	–	8.70	0.3425	40.0	84.0	8.70
A1178.8	–	8.80	0.3465	40.0	84.0	8.80
A1178.9	–	8.90	0.3504	40.0	84.0	8.90
A1179.0	–	9.00	0.3543	40.0	84.0	9.00
A1179.1	–	9.10	0.3583	40.0	84.0	9.10
A1179.2	–	9.20	0.3622	40.0	84.0	9.20
A1179.3	–	9.30	0.3661	40.0	84.0	9.30
A1179.5	–	9.50	0.3740	40.0	84.0	9.50
A1179.9	–	9.90	0.3898	43.0	89.0	9.90
A11710.0	–	10.00	0.3937	43.0	89.0	10.00
A11710.2	–	10.20	0.4016	43.0	89.0	10.20
A11710.5	–	10.50	0.4134	43.0	89.0	10.50
A11711.0	–	11.00	0.4331	47.0	95.0	11.00
A11711.5	–	11.50	0.4528	47.0	95.0	11.50
A11712.0	–	12.00	0.4724	51.0	102.0	12.00
A1171/2	1/2	12.70	0.5000	51.0	102.0	12.70
A11713.0	–	13.00	0.5118	51.0	102.0	13.00

A920



PFX-borr av HSS-E (5% Kobolt), extrakort, blank

Högproduktivt borr som ger hål med hög noggrannhet och finish. H10-tolerans möjlig under rätt förhållanden. 130° spetsvinkel med korspets och parabolisk spårutformning. Alcrona Top-beläggning ökar slitstyrka och livslängd. Kan användas i de flesta material.

PFX

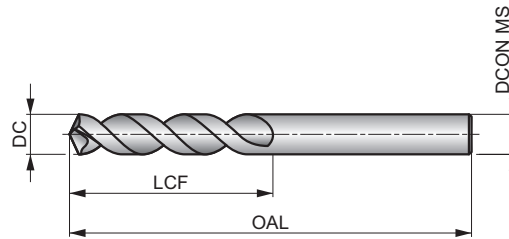

HSS-E	DIN ANSI	3×D
130°	Bright	
		DC h8

Arbetsmaterialgrupper och startvärden för skärhastighet (m/min) och matningskod. Tabeller med matningar finns med början på sidan 274

P1.1 ■ 42 J	P1.2 ■ 47 J	P1.3 ■ 49 J	P2.1 ■ 36 J	P2.2 ■ 32 I	P2.3 ■ 28 E	P3.1 ■ 34 I	P3.2 ■ 27 I	P3.3 ■ 23 E	P4.1 ■ 20 I	P4.2 ■ 17 E	P4.3 ■ 14 E	M1.1 ■ 21 F	M1.2 ■ 17 F
M2.1 ■ 18 F	M2.2 ■ 15 F	M3.1 ■ 8 F	M3.2 ■ 7 F	M3.3 ■ 6 F	M4.1 ■ 9 D	K1.1 □ 34 L	K1.2 □ 25 L	K1.3 □ 19 L	K2.1 □ 32 L	K2.2 □ 26 L	K2.3 □ 21 J	K3.1 □ 28 L	K3.2 □ 22 L
K3.3 □ 17 J	K4.1 □ 26 L	K4.2 □ 20 L	K4.3 □ 14 J	K4.4 □ 12 J	K4.5 □ 10 J	K5.1 □ 30 L	K5.2 □ 22 L	K5.3 □ 17 J	N1.1 □ 75 L	N1.2 □ 56 L	N1.3 □ 38 N	N2.1 □ 62 N	N2.2 □ 55 N
N2.3 □ 40 N	N3.1 □ 112 J	N3.2 □ 66 J	N3.3 □ 33 H	N4.1 □ 55 J	N4.2 □ 40 H	S1.1 ■ 30 G	S1.2 ■ 18 G	S1.3 ■ 10 C	S2.1 ■ 12 G	S2.2 ■ 8 E	S3.1 ■ 9 G	S3.2 ■ 6 E	S4.1 ■ 7 G
S4.2 ■ 5 E													

Product	DC (inch)	DC (mm)	DC (inch)	LCF (mm)	OAL (mm)	DCON MS (mm)
A9201.0	–	1.00	0.0394	6.0	26.0	1.00
A9203/64	3/64	1.19	0.0469	13.0	35.0	1.19
A9201.2	–	1.20	0.0472	8.0	30.0	1.20
A9201.25	–	1.25	0.0492	8.0	30.0	1.25
A9201.3	–	1.30	0.0512	8.0	30.0	1.30
A9201.35	–	1.35	0.0531	9.0	32.0	1.35
A9201.4	–	1.40	0.0551	9.0	32.0	1.40
A9201.5	–	1.50	0.0591	9.0	32.0	1.50
A9201.55	–	1.55	0.0610	10.0	34.0	1.55
A9201/16	1/16	1.59	0.0625	16.0	41.0	1.59
A9201.6	–	1.60	0.0630	10.0	34.0	1.60
A9201.7	–	1.70	0.0669	10.0	34.0	1.70
A9201.8	–	1.80	0.0709	11.0	36.0	1.80
A9201.9	–	1.90	0.0748	11.0	36.0	1.90
A9205/64	5/64	1.98	0.0781	17.0	43.0	1.98
A9202.0	–	2.00	0.0787	12.0	38.0	2.00
A9202.1	–	2.10	0.0827	12.0	38.0	2.10
A9202.15	–	2.15	0.0846	13.0	40.0	2.15
A9202.2	–	2.20	0.0866	13.0	40.0	2.20
A9202.3	–	2.30	0.0906	13.0	40.0	2.30
A9202.35	–	2.35	0.0925	14.0	43.0	2.35
A9203/32	3/32	2.38	0.0938	19.0	41.0	2.38
A9202.4	–	2.40	0.0945	14.0	43.0	2.40
A9202.5	–	2.50	0.0984	14.0	43.0	2.50

Product	DC (inch)	DC (mm)	DC (inch)	LCF (mm)	OAL (mm)	DCON MS (mm)
A9202.6	–	2.60	0.1024	14.0	43.0	2.60
A9202.7	–	2.70	0.1063	16.0	46.0	2.70
A9207/64	7/64	2.78	0.1094	21.0	46.0	2.78
A9202.8	–	2.80	0.1102	16.0	46.0	2.80
A9202.9	–	2.90	0.1142	16.0	46.0	2.90
A9203.0	–	3.00	0.1181	16.0	46.0	3.00
A9203.1	–	3.10	0.1220	18.0	49.0	3.10
A9201/8	1/8	3.18	0.1250	22.0	48.0	3.18
A9203.2	–	3.20	0.1260	18.0	49.0	3.20
A9203.3	–	3.30	0.1299	18.0	49.0	3.30
A9203.4	–	3.40	0.1339	20.0	52.0	3.40
A9203.5	–	3.50	0.1378	20.0	52.0	3.50
A9209/64	9/64	3.57	0.1406	24.0	49.0	3.57
A9203.6	–	3.60	0.1417	20.0	52.0	3.60
A9203.7	–	3.70	0.1457	20.0	52.0	3.70
A9203.8	–	3.80	0.1496	22.0	55.0	3.80
A9205/32	5/32	3.97	0.1563	25.0	52.0	3.97
A9204.0	–	4.00	0.1575	22.0	55.0	4.00
A9204.1	–	4.10	0.1614	22.0	55.0	4.10
A9204.2	–	4.20	0.1654	22.0	55.0	4.20
A9204.3	–	4.30	0.1693	24.0	58.0	4.30
A92011/64	11/64	4.37	0.1719	27.0	54.0	4.37
A9204.4	–	4.40	0.1732	24.0	58.0	4.40
A9204.5	–	4.50	0.1772	24.0	58.0	4.50



Product	DC	DC	DC	LCF	OAL	DCON MS
	(inch)	(mm)	(inch)	(mm)	(mm)	(mm)
A9204.6	–	4.60	0.1811	24.0	58.0	4.60
A9203/16	3/16	4.76	0.1875	29.0	56.0	4.76
A9204.8	–	4.80	0.1890	26.0	62.0	4.80
A9204.9	–	4.90	0.1929	26.0	62.0	4.90
A9205.0	–	5.00	0.1969	26.0	62.0	5.00
A9205.1	–	5.10	0.2008	26.0	62.0	5.10
A92013/64	13/64	5.16	0.2031	30.0	57.0	5.16
A9205.2	–	5.20	0.2047	26.0	62.0	5.20
A9205.3	–	5.30	0.2087	26.0	62.0	5.30
A9205.4	–	5.40	0.2126	28.0	66.0	5.40
A9205.5	–	5.50	0.2165	28.0	66.0	5.50
A9207/32	7/32	5.56	0.2188	32.0	60.0	5.56
A9205.6	–	5.60	0.2205	28.0	66.0	5.60
A9205.7	–	5.70	0.2244	28.0	66.0	5.70
A9205.9	–	5.90	0.2323	28.0	66.0	5.90
A9206.0	–	6.00	0.2362	28.0	66.0	6.00
A9206.2	–	6.20	0.2441	31.0	70.0	6.20
A9201/4	1/4	6.35	0.2500	35.0	64.0	6.35
A9206.4	–	6.40	0.2520	31.0	70.0	6.40
A9206.5	–	6.50	0.2559	31.0	70.0	6.50
A9206.6	–	6.60	0.2598	31.0	70.0	6.60
A9206.7	–	6.70	0.2638	31.0	70.0	6.70
A92017/64	17/64	6.75	0.2656	37.0	67.0	6.75
A9206.8	–	6.80	0.2677	34.0	74.0	6.80
A9206.9	–	6.90	0.2717	34.0	74.0	6.90
A9207.0	–	7.00	0.2756	34.0	74.0	7.00
A9207.1	–	7.10	0.2795	34.0	74.0	7.10
A9209/32	9/32	7.14	0.2813	38.0	68.0	7.14
A9207.5	–	7.50	0.2953	34.0	74.0	7.50
A92019/64	19/64	7.54	0.2969	40.0	70.0	7.54
A9207.8	–	7.80	0.3071	37.0	79.0	7.80
A9205/16	5/16	7.94	0.3125	41.0	71.0	7.94
A9208.0	–	8.00	0.3150	37.0	79.0	8.00
A9208.3	–	8.30	0.3268	37.0	79.0	8.30

Product	DC	DC	DC	LCF	OAL	DCON MS
	(inch)	(mm)	(inch)	(mm)	(mm)	(mm)
A9208.4	–	8.40	0.3307	37.0	79.0	8.40
A9208.5	–	8.50	0.3346	37.0	79.0	8.50
A9208.6	–	8.60	0.3386	40.0	84.0	8.60
A9208.7	–	8.70	0.3425	40.0	84.0	8.70
A9209.0	–	9.00	0.3543	40.0	84.0	9.00
A9209.5	–	9.50	0.3740	40.0	84.0	9.50
A9203/8	3/8	9.52	0.3750	46.0	79.0	9.52
A92025/64	25/64	9.92	0.3906	48.0	83.0	9.92
A92010.0	–	10.00	0.3937	43.0	89.0	10.00
A92010.2	–	10.20	0.4016	43.0	89.0	10.20
A92010.3	–	10.30	0.4055	43.0	89.0	10.30
A92010.5	–	10.50	0.4134	43.0	89.0	10.50
A92027/64	27/64	10.72	0.4219	51.0	86.0	10.72
A92010.8	–	10.80	0.4252	47.0	95.0	10.80
A92011.0	–	11.00	0.4331	47.0	95.0	11.00
A9207/16	7/16	11.11	0.4375	52.0	87.0	11.11
A92011.5	–	11.50	0.4528	47.0	95.0	11.50
A92011.8	–	11.80	0.4646	47.0	95.0	11.80
A92012.0	–	12.00	0.4724	51.0	102.0	12.00
A92012.5	–	12.50	0.4921	51.0	102.0	12.50
A9201/2	1/2	12.70	0.5000	57.0	95.0	12.70
A92013.0	–	13.00	0.5118	51.0	102.0	13.00
A92014.0	–	14.00	0.5512	54.0	107.0	14.00
A92014.5	–	14.50	0.5709	56.0	111.0	14.50
A92016.0	–	16.00	0.6299	58.0	115.0	16.00
A92016.5	–	16.50	0.6496	60.0	119.0	16.50
A92021/32	21/32	16.67	0.6563	73.0	114.0	16.67
A92017.0	–	17.00	0.6693	60.0	119.0	17.00
A92017.5	–	17.50	0.6890	62.0	123.0	17.50
A92018.0	–	18.00	0.7087	62.0	123.0	18.00
A92023/32	23/32	18.26	0.7188	76.0	121.0	18.26
A92019.0	–	19.00	0.7480	64.0	127.0	19.00
A92025/32	25/32	19.84	0.7813	83.0	130.0	19.84
A92020.0	–	20.00	0.7874	66.0	131.0	20.00

R023



Extra kort borrh i solid hårdmetall, TiN-spetsbelagd

Mångsidig instegsborrh med 120° spetsvinkel med fyra fasetters spetsgeometri för minskad skärkraft och CTW-spårkonstruktion för ökad produktivitet. TiN-beläggning förbättrar prestanda och förlänger verktygets livslängd. Lämplig för både CNC-maskiner och konventionella maskiner i ett brett spektrum av olika material.

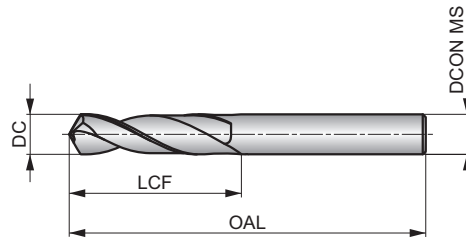

HM	DIN 6539	2.5xD
120°	TiN-Tip	
λ 20-35°	R	DC h7

Arbetsmaterialgrupper och startvärden för skärhastighet (m/min) och matningskod. Tabeller med matningar finns med början på sidan 274

P1.1 ■ 99 T	P1.2 ■ 111 T	P1.3 ■ 115 T	P2.1 ■ 85 T	P2.2 ■ 75 T	P2.3 ■ 66 T	P3.1 ■ 66 T	P3.2 ■ 53 T	P3.3 ■ 45 T	P4.1 ■ 40 S	P4.2 ■ 34 S	P4.3 ■ 27 S	K1.1 ■ 75 U	K1.2 ■ 56 U
K1.3 ■ 42 U	K2.1 ■ 68 U	K2.2 ■ 55 U	K2.3 ■ 44 U	K3.1 ■ 60 U	K3.2 ■ 46 U	K3.3 ■ 37 U	K4.1 ■ 55 T	K4.2 ■ 42 T	K4.3 ■ 31 T	K4.4 ■ 26 T	K4.5 ■ 22 T	K5.1 ■ 63 U	K5.2 ■ 47 U
K5.3 ■ 37 U	N1.1 ■ 150 W	N1.2 ■ 113 W	N1.3 ■ 75 W	N2.1 ■ 129 W	N2.2 ■ 116 W	N2.3 ■ 84 W	N3.1 ■ 317 W	N3.2 ■ 190 W	N4.1 ■ 60 V	N4.2 ■ 100 V	H1.1 ■ 34 S	H2.1 ■ 20 S	H3.1 ■ 22 S

Product	DC (mm)	DC (inch)	LCF (mm)	OAL (mm)	DCON MS (mm)
R0231.0	1.00	0.0394	6.0	26.0	1.00
R0231.1	1.10	0.0433	7.0	28.0	1.10
R0231.2	1.20	0.0472	8.0	30.0	1.20
R0231.3	1.30	0.0512	8.0	30.0	1.30
R0231.4	1.40	0.0551	9.0	32.0	1.40
R0231.5	1.50	0.0591	9.0	32.0	1.50
R0231.6	1.60	0.0630	10.0	34.0	1.60
R0231.7	1.70	0.0669	10.0	34.0	1.70
R0231.8	1.80	0.0709	11.0	36.0	1.80
R0231.9	1.90	0.0748	11.0	36.0	1.90
R0232.0	2.00	0.0787	12.0	38.0	2.00
R0232.1	2.10	0.0827	12.0	38.0	2.10
R0232.2	2.20	0.0866	13.0	40.0	2.20
R0232.3	2.30	0.0906	13.0	40.0	2.30
R0232.4	2.40	0.0945	14.0	43.0	2.40
R0232.5	2.50	0.0984	14.0	43.0	2.50
R0232.6	2.60	0.1024	14.0	43.0	2.60
R0232.7	2.70	0.1063	16.0	46.0	2.70
R0232.8	2.80	0.1102	16.0	46.0	2.80
R0232.9	2.90	0.1142	16.0	46.0	2.90
R0233.0	3.00	0.1181	16.0	46.0	3.00
R0233.1	3.10	0.1220	18.0	49.0	3.10
R0233.2	3.20	0.1260	18.0	49.0	3.20
R0233.3	3.30	0.1299	18.0	49.0	3.30
R0233.4	3.40	0.1339	20.0	52.0	3.40
R0233.5	3.50	0.1378	20.0	52.0	3.50
R0233.6	3.60	0.1417	20.0	52.0	3.60
R0233.7	3.70	0.1457	20.0	52.0	3.70

Product	DC (mm)	DC (inch)	LCF (mm)	OAL (mm)	DCON MS (mm)
R0233.8	3.80	0.1496	22.0	55.0	3.80
R0233.9	3.90	0.1535	22.0	55.0	3.90
R0234.0	4.00	0.1575	22.0	55.0	4.00
R0234.1	4.10	0.1614	22.0	55.0	4.10
R0234.2	4.20	0.1654	22.0	55.0	4.20
R0234.3	4.30	0.1693	24.0	58.0	4.30
R0234.4	4.40	0.1732	24.0	58.0	4.40
R0234.5	4.50	0.1772	24.0	58.0	4.50
R0234.6	4.60	0.1811	24.0	58.0	4.60
R0234.7	4.70	0.1850	24.0	58.0	4.70
R0234.8	4.80	0.1890	26.0	62.0	4.80
R0234.9	4.90	0.1929	26.0	62.0	4.90
R0235.0	5.00	0.1969	26.0	62.0	5.00
R0235.1	5.10	0.2008	26.0	62.0	5.10
R0235.2	5.20	0.2047	26.0	62.0	5.20
R0235.3	5.30	0.2087	26.0	62.0	5.30
R0235.4	5.40	0.2126	28.0	66.0	5.40
R0235.5	5.50	0.2165	28.0	66.0	5.50
R0235.6	5.60	0.2205	28.0	66.0	5.60
R0235.7	5.70	0.2244	28.0	66.0	5.70
R0235.8	5.80	0.2283	28.0	66.0	5.80
R0235.9	5.90	0.2323	28.0	66.0	5.90
R0236.0	6.00	0.2362	28.0	66.0	6.00
R0236.1	6.10	0.2402	31.0	70.0	6.10
R0236.2	6.20	0.2441	31.0	70.0	6.20
R0236.3	6.30	0.2480	31.0	70.0	6.30
R0236.4	6.40	0.2520	31.0	70.0	6.40
R0236.5	6.50	0.2559	31.0	70.0	6.50



Product	DC	DC	LCF	OAL	DCON MS
	(mm)	(inch)	(mm)	(mm)	(mm)
R0236.6	6.60	0.2598	31.0	70.0	6.60
R0236.7	6.70	0.2638	31.0	70.0	6.70
R0236.8	6.80	0.2677	34.0	74.0	6.80
R0236.9	6.90	0.2717	34.0	74.0	6.90
R0237.0	7.00	0.2756	34.0	74.0	7.00
R0237.1	7.10	0.2795	34.0	74.0	7.10
R0237.2	7.20	0.2835	34.0	74.0	7.20
R0237.3	7.30	0.2874	34.0	74.0	7.30
R0237.4	7.40	0.2913	34.0	74.0	7.40
R0237.5	7.50	0.2953	34.0	74.0	7.50
R0237.6	7.60	0.2992	37.0	79.0	7.60
R0237.7	7.70	0.3031	37.0	79.0	7.70
R0237.8	7.80	0.3071	37.0	79.0	7.80
R0237.9	7.90	0.3110	37.0	79.0	7.90
R0238.0	8.00	0.3150	37.0	79.0	8.00
R0238.1	8.10	0.3189	37.0	79.0	8.10
R0238.2	8.20	0.3228	37.0	79.0	8.20
R0238.3	8.30	0.3268	37.0	79.0	8.30
R0238.4	8.40	0.3307	37.0	79.0	8.40
R0238.5	8.50	0.3346	37.0	79.0	8.50

Product	DC	DC	LCF	OAL	DCON MS
	(mm)	(inch)	(mm)	(mm)	(mm)
R0238.6	8.60	0.3386	40.0	84.0	8.60
R0238.7	8.70	0.3425	40.0	84.0	8.70
R0238.8	8.80	0.3465	40.0	84.0	8.80
R0238.9	8.90	0.3504	40.0	84.0	8.90
R0239.0	9.00	0.3543	40.0	84.0	9.00
R0239.1	9.10	0.3583	40.0	84.0	9.10
R0239.2	9.20	0.3622	40.0	84.0	9.20
R0239.3	9.30	0.3661	40.0	84.0	9.30
R0239.4	9.40	0.3701	40.0	84.0	9.40
R0239.5	9.50	0.3740	40.0	84.0	9.50
R0239.6	9.60	0.3780	43.0	89.0	9.60
R0239.7	9.70	0.3819	43.0	89.0	9.70
R0239.8	9.80	0.3858	43.0	89.0	9.80
R0239.9	9.90	0.3898	43.0	89.0	9.90
R02310.0	10.00	0.3937	43.0	89.0	10.00
R02310.2	10.20	0.4016	43.0	89.0	10.20
R02310.5	10.50	0.4134	43.0	89.0	10.50
R02311.0	11.00	0.4331	47.0	95.0	11.00
R02311.5	11.50	0.4528	47.0	95.0	11.50
R02312.0	12.00	0.4724	51.0	102.0	12.00

Verktygsmaterial (BMC)	HSS-E	HSS-E	HSS	HSS-E	HM								
Standard (BSG)	DIN 338	DIN 338	DIN 338	DORMER	DIN 338								
Användbar längd (ULDR)	4xD	4xD	4xD	5xD	4xD								
Spetsvinkel	135°	130°	130°	130°	120°								
Beläggning	Bronze	Bright	TiN	TiAlN Top	TiN-Tip								
Skaft				DIN 6335HA									
Spiralform	λ20-35°	VA	λ32-40°	λ>35°	λ20-35°								
Skärriktning	R	R	R	R	R								
Kylning (CSP)													
			ADX	ADX									

Produktfamilj	A777	A147	A510	A553	R003								
PSF skärdiameterar	0.30 - 16.00	0.30 - 15.0	3.00 - 14.00	5.00 - 18.00	1.00 - 14.00								
	116	118	120	122	123								
P	P1	☑	☑	☐	☐	☐							
	P2	☑	☑	☐	☐	☐							
	P3	☑	☑	☐	☐	☐							
	P4	☐	☑	☐	☐	☐							
M	M1	☑	☐	☐	☐								
	M2	☑	☐	☐	☐								
	M3	☑	☐	☐	☐								
	M4	☑	☑	☑	☑								
K	K1	☑	☑	☐	☐	☐							
	K2	☑	☑	☐	☐	☐							
	K3	☑	☑	☐	☐	☐							
	K4	☐	☑	☐	☐	☑							
	K5	☑	☑	☐	☐	☐							
N	N1	☑	☑	☑	☑	☐							
	N2	☑	☑	☐	☐	☑							
	N3	☑	☑	☐	☐	☐							
	N4		☑	☐	☐	☐							
	N5			☐	☐	☐							
S	S1	☐	☐	☑	☑								
	S2	☑	☑	☑	☑								
	S3	☑	☑	☑	☑								
	S4	☑	☑	☑	☑								
H	H1					☑							
	H2					☑							
	H3					☑							
	H4												

A777



Kort borr av HSS-E (5% kobolt), gulanlöpt

Ett borr med kraftig design som är lämpligt för borrar i hållfasta och hårda stål. 135° korspetsad, självcentrerande spets. Gulanlöpningen indikerar att borret är tillverkat av HSS-E stål med koboltinnehåll.

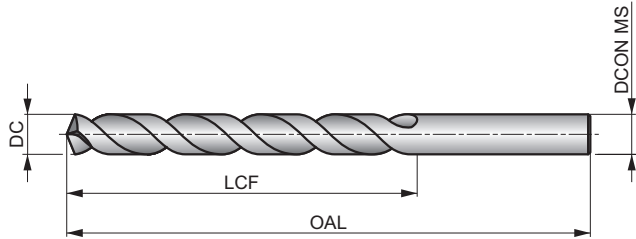

HSS-E	DIN 338	4×D
135°	Bronze	
λ 20-35°	R	DC h8

Arbetsmaterialgrupper och startvärden för skärhastighet (m/min) och matningskod. Tabeller med matningar finns med början på sidan 274

P1.1 ▣36 H	P1.2 ▣40 H	P1.3 ▣41 H	P2.1 ▣31 H	P2.2 ▣27 G	P2.3 ▣24 E	P3.1 ▣25 F	P3.2 ▣20 F	P3.3 ▣17 E	P4.1 ▣15 F	P4.2 ▣13 E	P4.3 ▣10 D	M1.1 ▣30 E	M1.2 ▣26 E
M2.1 ▣27 E	M2.2 ▣22 E	M3.1 ▣13 G	M3.2 ▣11 G	M3.3 ▣10 G	M4.1 ▣15 C	K1.1 ▣35 H	K1.2 ▣26 D	K1.3 ▣19 D	K2.1 ▣27 E	K2.2 ▣22 E	K2.3 ▣18 E	K3.1 ▣24 E	K3.2 ▣18 E
K3.3 ▣15 E	K4.1 ▣22 E	K4.2 ▣17 E	K4.3 ▣12 E	K4.4 ▣11 E	K4.5 ▣9 E	K5.1 ▣25 E	K5.2 ▣19 E	K5.3 ▣15 E	N1.1 ▣33 J	N1.2 ▣25 J	N1.3 ▣17 I	N2.1 ▣46 H	N2.2 ▣42 H
N2.3 ▣30 H	N3.1 ▣68 H	N3.2 ▣40 F	N3.3 ▣20 H	S1.1 ▣28 F	S1.2 ▣20 D	S1.3 ▣11 C	S2.1 ▣9 E	S2.2 ▣8 B	S3.1 ▣7 E	S3.2 ▣6 B	S4.1 ▣5 E	S4.2 ▣5 B	

NAS907J. DC ≤ 1,4mm 4-fasettspets.
Produkter från den här serien finns även i set. Se A295

Product	DC	DC	DC	LCF	OAL	DCON MS
	(inch)	(mm)	(inch)	(mm)	(mm)	(mm)
A777.3	–	0.30	0.0118	3.0	19.0	0.30
A777.35	–	0.35	0.0138	4.0	19.0	0.35
A777.4	–	0.40	0.0157	5.0	20.0	0.40
A777.45	–	0.45	0.0177	5.0	20.0	0.45
A777.5	–	0.50	0.0197	6.0	22.0	0.50
A777.55	–	0.55	0.0217	7.0	24.0	0.55
A777.6	–	0.60	0.0236	7.0	24.0	0.60
A777.65	–	0.65	0.0256	8.0	26.0	0.65
A777.7	–	0.70	0.0276	9.0	28.0	0.70
A777.8	–	0.80	0.0315	10.0	30.0	0.80
A777.9	–	0.90	0.0354	11.0	32.0	0.90
A777.95	–	0.95	0.0374	11.0	32.0	0.95
A7771.0	–	1.00	0.0394	12.0	34.0	1.00
A7771.1	–	1.10	0.0433	14.0	36.0	1.10
A7771.2	–	1.20	0.0472	16.0	38.0	1.20
A7771.3	–	1.30	0.0512	16.0	38.0	1.30
A7771.4	–	1.40	0.0551	18.0	40.0	1.40
A7771.5	–	1.50	0.0591	18.0	40.0	1.50
A7771/16	1/16	1.59	0.0625	20.0	43.0	1.59
A7771.6	–	1.60	0.0630	20.0	43.0	1.60
A7771.7	–	1.70	0.0669	20.0	43.0	1.70
A7771.8	–	1.80	0.0709	22.0	46.0	1.80
A7771.9	–	1.90	0.0748	22.0	46.0	1.90
A7775/64	5/64	1.98	0.0781	24.0	49.0	1.98

Product	DC	DC	DC	LCF	OAL	DCON MS
	(inch)	(mm)	(inch)	(mm)	(mm)	(mm)
A7772.0	–	2.00	0.0787	24.0	49.0	2.00
A7772.1	–	2.10	0.0827	24.0	49.0	2.10
A7772.2	–	2.20	0.0866	27.0	53.0	2.20
A7772.3	–	2.30	0.0906	27.0	53.0	2.30
A7773/32	3/32	2.38	0.0938	30.0	57.0	2.38
A7772.4	–	2.40	0.0945	30.0	57.0	2.40
A7772.5	–	2.50	0.0984	30.0	57.0	2.50
A7772.6	–	2.60	0.1024	30.0	57.0	2.60
A7772.7	–	2.70	0.1063	33.0	61.0	2.70
A7777/64	7/64	2.78	0.1094	33.0	61.0	2.78
A7772.8	–	2.80	0.1102	33.0	61.0	2.80
A7772.9	–	2.90	0.1142	33.0	61.0	2.90
A7773.0	–	3.00	0.1181	33.0	61.0	3.00
A7773.1	–	3.10	0.1220	36.0	65.0	3.10
A7771/8	1/8	3.18	0.1250	36.0	65.0	3.18
A7773.2	–	3.20	0.1260	36.0	65.0	3.20
A7773.3	–	3.30	0.1299	36.0	65.0	3.30
A7773.4	–	3.40	0.1339	39.0	70.0	3.40
A7773.5	–	3.50	0.1378	39.0	70.0	3.50
A7779/64	9/64	3.57	0.1406	39.0	70.0	3.57
A7773.6	–	3.60	0.1417	39.0	70.0	3.60
A7773.7	–	3.70	0.1457	39.0	70.0	3.70
A7773.8	–	3.80	0.1496	43.0	75.0	3.80
A7773.9	–	3.90	0.1535	43.0	75.0	3.90

Product	DC	DC	DC	LCF	OAL	D CON MS
	(inch)	(mm)	(inch)	(mm)	(mm)	(mm)
A7775/32	5/32	3.97	0.1563	43.0	75.0	3.97
A7774.0	–	4.00	0.1575	43.0	75.0	4.00
A7774.1	–	4.10	0.1614	43.0	75.0	4.10
A7774.2	–	4.20	0.1654	43.0	75.0	4.20
A7774.3	–	4.30	0.1693	47.0	80.0	4.30
A77711/64	11/64	4.37	0.1719	47.0	80.0	4.37
A7774.4	–	4.40	0.1732	47.0	80.0	4.40
A7774.5	–	4.50	0.1772	47.0	80.0	4.50
A7774.6	–	4.60	0.1811	47.0	80.0	4.60
A7774.7	–	4.70	0.1850	47.0	80.0	4.70
A7773/16	3/16	4.76	0.1875	52.0	86.0	4.76
A7774.8	–	4.80	0.1890	52.0	86.0	4.80
A7774.9	–	4.90	0.1929	52.0	86.0	4.90
A7775.0	–	5.00	0.1969	52.0	86.0	5.00
A7775.1	–	5.10	0.2008	52.0	86.0	5.10
A77713/64	13/64	5.16	0.2031	52.0	86.0	5.16
A7775.2	–	5.20	0.2047	52.0	86.0	5.20
A7775.3	–	5.30	0.2087	52.0	86.0	5.30
A7775.4	–	5.40	0.2126	57.0	93.0	5.40
A7775.5	–	5.50	0.2165	57.0	93.0	5.50
A7777/32	7/32	5.56	0.2188	57.0	93.0	5.56
A7775.6	–	5.60	0.2205	57.0	93.0	5.60
A7775.7	–	5.70	0.2244	57.0	93.0	5.70
A7775.8	–	5.80	0.2283	57.0	93.0	5.80
A7775.9	–	5.90	0.2323	57.0	93.0	5.90
A77715/64	15/64	5.95	0.2344	57.0	93.0	5.95
A7776.0	–	6.00	0.2362	57.0	93.0	6.00
A7776.1	–	6.10	0.2402	63.0	101.0	6.10
A7776.2	–	6.20	0.2441	63.0	101.0	6.20
A7776.3	–	6.30	0.2480	63.0	101.0	6.30
A7771/4	1/4	6.35	0.2500	63.0	101.0	6.35
A7776.4	–	6.40	0.2520	63.0	101.0	6.40
A7776.5	–	6.50	0.2559	63.0	101.0	6.50
A7776.6	–	6.60	0.2598	63.0	101.0	6.60
A7776.7	–	6.70	0.2638	63.0	101.0	6.70
A77717/64	17/64	6.75	0.2656	69.0	109.0	6.75
A7776.8	–	6.80	0.2677	69.0	109.0	6.80
A7776.9	–	6.90	0.2717	69.0	109.0	6.90
A7777.0	–	7.00	0.2756	69.0	109.0	7.00
A7777.1	–	7.10	0.2795	69.0	109.0	7.10
A7779/32	9/32	7.14	0.2813	69.0	109.0	7.14
A7777.2	–	7.20	0.2835	69.0	109.0	7.20
A7777.3	–	7.30	0.2874	69.0	109.0	7.30
A7777.4	–	7.40	0.2913	69.0	109.0	7.40
A7777.5	–	7.50	0.2953	69.0	109.0	7.50
A77719/64	19/64	7.54	0.2969	75.0	117.0	7.54
A7777.6	–	7.60	0.2992	75.0	117.0	7.60
A7777.7	–	7.70	0.3031	75.0	117.0	7.70
A7777.8	–	7.80	0.3071	75.0	117.0	7.80
A7777.9	–	7.90	0.3110	75.0	117.0	7.90
A7775/16	5/16	7.94	0.3125	75.0	117.0	7.94
A7778.0	–	8.00	0.3150	75.0	117.0	8.00

Product	DC	DC	DC	LCF	OAL	D CON MS
	(inch)	(mm)	(inch)	(mm)	(mm)	(mm)
A7778.1	–	8.10	0.3189	75.0	117.0	8.10
A7778.2	–	8.20	0.3228	75.0	117.0	8.20
A7778.3	–	8.30	0.3268	75.0	117.0	8.30
A77721/64	21/64	8.33	0.3281	75.0	117.0	8.33
A7778.4	–	8.40	0.3307	75.0	117.0	8.40
A7778.5	–	8.50	0.3346	75.0	117.0	8.50
A7778.6	–	8.60	0.3386	81.0	125.0	8.60
A7778.7	–	8.70	0.3425	81.0	125.0	8.70
A77711/32	11/32	8.73	0.3438	81.0	125.0	8.73
A7778.8	–	8.80	0.3465	81.0	125.0	8.80
A7778.9	–	8.90	0.3504	81.0	125.0	8.90
A7779.0	–	9.00	0.3543	81.0	125.0	9.00
A7779.1	–	9.10	0.3583	81.0	125.0	9.10
A77723/64	23/64	9.13	0.3594	81.0	125.0	9.13
A7779.2	–	9.20	0.3622	81.0	125.0	9.20
A7779.3	–	9.30	0.3661	81.0	125.0	9.30
A7779.4	–	9.40	0.3701	81.0	125.0	9.40
A7779.5	–	9.50	0.3740	81.0	125.0	9.50
A7773/8	3/8	9.52	0.3750	87.0	133.0	9.52
A7779.6	–	9.60	0.3780	87.0	133.0	9.60
A7779.7	–	9.70	0.3819	87.0	133.0	9.70
A7779.8	–	9.80	0.3858	87.0	133.0	9.80
A7779.9	–	9.90	0.3898	87.0	133.0	9.90
A77725/64	25/64	9.92	0.3906	87.0	133.0	9.92
A77710.0	–	10.00	0.3937	87.0	133.0	10.00
A77710.1	–	10.10	0.3976	87.0	133.0	10.10
A77710.2	–	10.20	0.4016	87.0	133.0	10.20
A77713/32	13/32	10.32	0.4063	87.0	133.0	10.32
A77710.5	–	10.50	0.4134	87.0	133.0	10.50
A77727/64	27/64	10.72	0.4219	94.0	142.0	10.72
A77710.8	–	10.80	0.4252	94.0	142.0	10.80
A77711.0	–	11.00	0.4331	94.0	142.0	11.00
A7777/16	7/16	11.11	0.4375	94.0	142.0	11.11
A77711.2	–	11.20	0.4409	94.0	142.0	11.20
A77711.5	–	11.50	0.4528	94.0	142.0	11.50
A77729/64	29/64	11.51	0.4531	94.0	142.0	11.51
A77711.8	–	11.80	0.4646	94.0	142.0	11.80
A77715/32	15/32	11.91	0.4688	101.0	151.0	11.91
A77712.0	–	12.00	0.4724	101.0	151.0	12.00
A77712.2	–	12.20	0.4803	101.0	151.0	12.20
A77731/64	31/64	12.30	0.4844	101.0	151.0	12.30
A77712.5	–	12.50	0.4921	101.0	151.0	12.50
A7771/2	1/2	12.70	0.5000	101.0	151.0	12.70
A77712.8	–	12.80	0.5039	101.0	151.0	12.80
A77713.0	–	13.00	0.5118	101.0	151.0	13.00
A77713.5	–	13.50	0.5315	108.0	160.0	13.50
A77714.0	–	14.00	0.5512	108.0	160.0	14.00
A77714.5	–	14.50	0.5709	114.0	169.0	14.50
A77715.0	–	15.00	0.5906	114.0	169.0	15.00
A77715.5	–	15.50	0.6102	120.0	178.0	15.50
A77716.0	–	16.00	0.6299	120.0	178.0	16.00

A147



Kort borr av HSS-E (5% Kobolt) 4xD, för rostfritt stål, blank

Ett mångsidigt borr för rostfritt stål och varmhållfasta material i första hand men som går att använda i de flesta andra material. Det har en korsspetsad 130°-spets som är självcentererande. Blank finish.

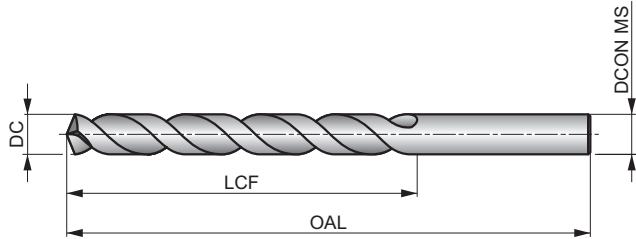

HSS-E	DIN 338	4xD
130°	Bright	
VA	R	DC h8

Arbetsmaterialgrupper och startvärden för skärhastighet (m/min) och matningskod. Tabeller med matningar finns med början på sidan 274

P1.1 33 I	P1.2 37 I	P1.3 38 I	P2.1 28 I	P2.2 25 G	P2.3 22 E	P3.1 19 F	P3.2 15 F	P3.3 13 E	P4.1 11 F	P4.2 10 E	P4.3 8 D	M1.1 21 E	M1.2 17 E
M2.1 18 E	M2.2 15 E	M2.3 13 B	M3.1 10 G	M3.2 9 G	M3.3 8 G	M4.1 10 D	M4.2 9 B	K1.1 30 H	K1.2 22 F	K1.3 17 F	K2.1 25 E	K2.2 20 E	K2.3 16 E
K3.1 22 E	K3.2 17 E	K3.3 13 E	K4.1 20 E	K4.2 15 E	K4.3 11 E	K4.4 10 E	K4.5 8 E	K5.1 23 E	K5.2 17 E	K5.3 13 E	N1.1 33 J	N1.2 25 J	N1.3 17 I
N2.1 42 H	N2.2 37 H	N2.3 27 H	N3.1 59 H	N3.2 35 I	N3.3 18 G	N4.1 30 J	N4.2 28 H	N4.3 14 F	S1.1 25 G	S1.2 16 E	S1.3 7 B	S2.1 9 G	S2.2 8 E
S3.1 7 G	S3.2 6 E	S4.1 5 G	S4.2 5 E										

Product	DC (inch)	DC (mm)	DC (inch)	LCF (mm)	OAL (mm)	DCON MS (mm)
A147.3	-	0.30	0.0118	3.0	19.0	0.30
A147.4	-	0.40	0.0157	5.0	20.0	0.40
A147.5	-	0.50	0.0197	6.0	22.0	0.50
A147.6	-	0.60	0.0236	7.0	24.0	0.60
A147.7	-	0.70	0.0276	9.0	28.0	0.70
A147.8	-	0.80	0.0315	10.0	30.0	0.80
A147.9	-	0.90	0.0354	11.0	32.0	0.90
A1471.0	-	1.00	0.0394	12.0	34.0	1.00
A1471.1	-	1.10	0.0433	14.0	36.0	1.10
A1471.2	-	1.20	0.0472	16.0	38.0	1.20
A1471.3	-	1.30	0.0512	16.0	38.0	1.30
A1471.4	-	1.40	0.0551	18.0	40.0	1.40
A1471.5	-	1.50	0.0591	18.0	40.0	1.50
A1471/16	1/16	1.59	0.0625	20.0	43.0	1.59
A1471.6	-	1.60	0.0630	20.0	43.0	1.60
A1471.7	-	1.70	0.0669	20.0	43.0	1.70
A1471.8	-	1.80	0.0709	22.0	46.0	1.80
A1471.9	-	1.90	0.0748	22.0	46.0	1.90
A1472.0	-	2.00	0.0787	24.0	49.0	2.00
A1472.1	-	2.10	0.0827	24.0	49.0	2.10
A1472.2	-	2.20	0.0866	27.0	53.0	2.20
A1472.3	-	2.30	0.0906	27.0	53.0	2.30
A1473/32	3/32	2.38	0.0938	30.0	57.0	2.38
A1472.4	-	2.40	0.0945	30.0	57.0	2.40

Product	DC (inch)	DC (mm)	DC (inch)	LCF (mm)	OAL (mm)	DCON MS (mm)
A1472.5	-	2.50	0.0984	30.0	57.0	2.50
A1472.6	-	2.60	0.1024	30.0	57.0	2.60
A1472.7	-	2.70	0.1063	33.0	61.0	2.70
A1472.8	-	2.80	0.1102	33.0	61.0	2.80
A1472.9	-	2.90	0.1142	33.0	61.0	2.90
A1473.0	-	3.00	0.1181	33.0	61.0	3.00
A1473.1	-	3.10	0.1220	36.0	65.0	3.10
A1471/8	1/8	3.18	0.1250	36.0	65.0	3.18
A1473.2	-	3.20	0.1260	36.0	65.0	3.20
A1473.3	-	3.30	0.1299	36.0	65.0	3.30
A1473.4	-	3.40	0.1339	39.0	70.0	3.40
A1473.5	-	3.50	0.1378	39.0	70.0	3.50
A1473.6	-	3.60	0.1417	39.0	70.0	3.60
A1473.7	-	3.70	0.1457	39.0	70.0	3.70
A1473.8	-	3.80	0.1496	43.0	75.0	3.80
A1473.9	-	3.90	0.1535	43.0	75.0	3.90
A1475/32	5/32	3.97	0.1563	43.0	75.0	3.97
A1474.0	-	4.00	0.1575	43.0	75.0	4.00
A1474.1	-	4.10	0.1614	43.0	75.0	4.10
A1474.2	-	4.20	0.1654	43.0	75.0	4.20
A1474.3	-	4.30	0.1693	47.0	80.0	4.30
A1474.4	-	4.40	0.1732	47.0	80.0	4.40
A1474.5	-	4.50	0.1772	47.0	80.0	4.50
A1474.6	-	4.60	0.1811	47.0	80.0	4.60

Product	DC	DC	DC	LCF	OAL	DCON MS
	(inch)	(mm)	(inch)	(mm)	(mm)	(mm)
A1474.7	–	4.70	0.1850	47.0	80.0	4.70
A1473/16	3/16	4.76	0.1875	52.0	86.0	4.76
A1474.8	–	4.80	0.1890	52.0	86.0	4.80
A1474.9	–	4.90	0.1929	52.0	86.0	4.90
A1475.0	–	5.00	0.1969	52.0	86.0	5.00
A1475.1	–	5.10	0.2008	52.0	86.0	5.10
A1475.2	–	5.20	0.2047	52.0	86.0	5.20
A1475.3	–	5.30	0.2087	52.0	86.0	5.30
A1475.4	–	5.40	0.2126	57.0	93.0	5.40
A1475.5	–	5.50	0.2165	57.0	93.0	5.50
A1475.6	–	5.60	0.2205	57.0	93.0	5.60
A1475.7	–	5.70	0.2244	57.0	93.0	5.70
A1475.8	–	5.80	0.2283	57.0	93.0	5.80
A1475.9	–	5.90	0.2323	57.0	93.0	5.90
A1476.0	–	6.00	0.2362	57.0	93.0	6.00
A1476.1	–	6.10	0.2402	63.0	101.0	6.10
A1476.2	–	6.20	0.2441	63.0	101.0	6.20
A1476.3	–	6.30	0.2480	63.0	101.0	6.30
A1471/4	1/4	6.35	0.2500	63.0	101.0	6.35
A1476.4	–	6.40	0.2520	63.0	101.0	6.40
A1476.5	–	6.50	0.2559	63.0	101.0	6.50
A1476.6	–	6.60	0.2598	63.0	101.0	6.60
A1476.7	–	6.70	0.2638	63.0	101.0	6.70
A1476.8	–	6.80	0.2677	69.0	109.0	6.80
A1476.9	–	6.90	0.2717	69.0	109.0	6.90
A1477.0	–	7.00	0.2756	69.0	109.0	7.00
A1477.1	–	7.10	0.2795	69.0	109.0	7.10
A1477.2	–	7.20	0.2835	69.0	109.0	7.20
A1477.3	–	7.30	0.2874	69.0	109.0	7.30
A1477.4	–	7.40	0.2913	69.0	109.0	7.40
A1477.5	–	7.50	0.2953	69.0	109.0	7.50

Product	DC	DC	DC	LCF	OAL	DCON MS
	(inch)	(mm)	(inch)	(mm)	(mm)	(mm)
A1477.7	–	7.70	0.3031	75.0	117.0	7.70
A1477.8	–	7.80	0.3071	75.0	117.0	7.80
A1477.9	–	7.90	0.3110	75.0	117.0	7.90
A1478.0	–	8.00	0.3150	75.0	117.0	8.00
A1478.1	–	8.10	0.3189	75.0	117.0	8.10
A1478.2	–	8.20	0.3228	75.0	117.0	8.20
A1478.3	–	8.30	0.3268	75.0	117.0	8.30
A1478.4	–	8.40	0.3307	75.0	117.0	8.40
A1478.5	–	8.50	0.3346	75.0	117.0	8.50
A1478.6	–	8.60	0.3386	81.0	125.0	8.60
A1478.7	–	8.70	0.3425	81.0	125.0	8.70
A1478.8	–	8.80	0.3465	81.0	125.0	8.80
A1478.9	–	8.90	0.3504	81.0	125.0	8.90
A1479.0	–	9.00	0.3543	81.0	125.0	9.00
A1479.1	–	9.10	0.3583	81.0	125.0	9.10
A1479.2	–	9.20	0.3622	81.0	125.0	9.20
A1479.5	–	9.50	0.3740	81.0	125.0	9.50
A1479.7	–	9.70	0.3819	87.0	133.0	9.70
A1479.8	–	9.80	0.3858	87.0	133.0	9.80
A14710.0	–	10.00	0.3937	87.0	133.0	10.00
A14710.2	–	10.20	0.4016	87.0	133.0	10.20
A14710.5	–	10.50	0.4134	87.0	133.0	10.50
A14711.0	–	11.00	0.4331	94.0	142.0	11.00
A14711.5	–	11.50	0.4528	94.0	142.0	11.50
A14712.0	–	12.00	0.4724	101.0	151.0	12.00
A14712.5	–	12.50	0.4921	101.0	151.0	12.50
A14713.0	–	13.00	0.5118	101.0	151.0	13.00
A14713.5	–	13.50	0.5315	108.0	160.0	13.50
A14714.0	–	14.00	0.5512	108.0	160.0	14.00
A14715.0	–	15.00	0.5906	114.0	169.0	15.00

A510



ADX-borr av HSS, kort, TiN-belagd

Högproduktivt borr som ger hål med hög noggrannhet och finish. H9-tolerans möjlig under rätt förhållanden. 130° spetsvinkel och självcentrerande spets med svängda huvudeggar. TiN-beläggning ökar slitstyrka och livslängd. Används i CNC-maskiner och kan användas i de flesta material.

ADX

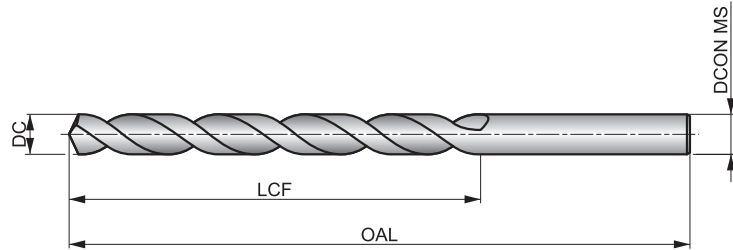

HSS	DIN 338	4×D
130°	TiN	
λ 32-40°	R	DC h8

Arbetsmaterialgrupper och startvärden för skärhastighet (m/min) och matningskod. Tabeller med matningar finns med början på sidan 274

P1.1 ■ 53 M	P1.2 ■ 59 M	P1.3 ■ 61 M	P2.1 ■ 45 M	P2.2 ■ 40 K	P2.3 ■ 35 F	P3.1 ■ 31 H	P3.2 ■ 25 H	P3.3 ■ 21 F	P4.1 ■ 19 H	P4.2 ■ 16 F	P4.3 ▣ 13 D	M1.1 ■ 38 G	M1.2 ■ 32 G
M2.1 ■ 34 G	M2.2 ■ 28 G	M3.1 ■ 16 I	M3.2 ■ 14 I	M3.3 ▣ 13 I	M4.1 ▣ 19 G	K1.1 ■ 42 K	K1.2 ■ 31 J	K1.3 ■ 23 J	K2.1 ■ 34 J	K2.2 ■ 28 J	K2.3 ■ 22 F	K3.1 ■ 30 J	K3.2 ■ 23 J
K3.3 ■ 19 F	K4.1 ■ 28 J	K4.2 ■ 21 J	K4.3 ■ 16 F	K4.4 ■ 13 F	K4.5 ■ 11 F	K5.1 ■ 32 J	K5.2 ■ 24 J	K5.3 ■ 19 F	N1.1 ▣ 50 G	N1.2 ▣ 38 G	N1.3 ■ 25 M	N2.1 ■ 48 I	N2.2 ■ 43 I
N2.3 ■ 31 I	N3.1 ■ 85 I	N3.2 ■ 50 I	N3.3 ▣ 25 D	N4.1 ■ 65 G	N4.2 ■ 50 G	N4.3 ■ 35 F	S1.1 ▣ 32 G	S1.2 ▣ 20 H	S1.3 ▣ 4 B	S2.1 ▣ 12 E	S2.2 ▣ 8 E	S3.1 ▣ 9 E	S3.2 ▣ 6 E
S4.1 ▣ 7 E	S4.2 ▣ 5 E												

Product	DC (inch)	DC (mm)	DC (inch)	LCF (mm)	OAL (mm)	DCON MS (mm)
A5103.0	–	3.00	0.1181	33.0	61.0	3.00
A5103.1	–	3.10	0.1220	36.0	65.0	3.10
A5101/8	1/8	3.18	0.1250	36.0	65.0	3.18
A5103.2	–	3.20	0.1260	36.0	65.0	3.20
A5103.3	–	3.30	0.1299	36.0	65.0	3.30
A5103.4	–	3.40	0.1339	39.0	70.0	3.40
A5103.5	–	3.50	0.1378	39.0	70.0	3.50
A5109/64	9/64	3.57	0.1406	39.0	70.0	3.57
A5103.6	–	3.60	0.1417	39.0	70.0	3.60
A5103.7	–	3.70	0.1457	39.0	70.0	3.70
A5103.8	–	3.80	0.1496	43.0	75.0	3.80
A5103.9	–	3.90	0.1535	43.0	75.0	3.90
A5105/32	5/32	3.97	0.1563	43.0	75.0	3.97
A5104.0	–	4.00	0.1575	43.0	75.0	4.00
A5104.1	–	4.10	0.1614	43.0	75.0	4.10
A5104.2	–	4.20	0.1654	43.0	75.0	4.20
A5104.3	–	4.30	0.1693	47.0	80.0	4.30
A5104.4	–	4.40	0.1732	47.0	80.0	4.40
A5104.5	–	4.50	0.1772	47.0	80.0	4.50
A5104.6	–	4.60	0.1811	47.0	80.0	4.60
A5104.7	–	4.70	0.1850	47.0	80.0	4.70
A5103/16	3/16	4.76	0.1875	52.0	86.0	4.76
A5104.8	–	4.80	0.1890	52.0	86.0	4.80
A5104.9	–	4.90	0.1929	52.0	86.0	4.90

Product	DC (inch)	DC (mm)	DC (inch)	LCF (mm)	OAL (mm)	DCON MS (mm)
A5105.0	–	5.00	0.1969	52.0	86.0	5.00
A5105.1	–	5.10	0.2008	52.0	86.0	5.10
A51013/64	13/64	5.16	0.2031	52.0	86.0	5.16
A5105.2	–	5.20	0.2047	52.0	86.0	5.20
A5105.3	–	5.30	0.2087	52.0	86.0	5.30
A5105.4	–	5.40	0.2126	57.0	93.0	5.40
A5105.5	–	5.50	0.2165	57.0	93.0	5.50
A5107/32	7/32	5.56	0.2188	57.0	93.0	5.56
A5105.6	–	5.60	0.2205	57.0	93.0	5.60
A5105.7	–	5.70	0.2244	57.0	93.0	5.70
A5105.8	–	5.80	0.2283	57.0	93.0	5.80
A5105.9	–	5.90	0.2323	57.0	93.0	5.90
A51015/64	15/64	5.95	0.2344	57.0	93.0	5.95
A5106.0	–	6.00	0.2362	57.0	93.0	6.00
A5106.1	–	6.10	0.2402	63.0	101.0	6.10
A5106.2	–	6.20	0.2441	63.0	101.0	6.20
A5106.3	–	6.30	0.2480	63.0	101.0	6.30
A5101/4	1/4	6.35	0.2500	63.0	101.0	6.35
A5106.4	–	6.40	0.2520	63.0	101.0	6.40
A5106.5	–	6.50	0.2559	63.0	101.0	6.50
A5106.6	–	6.60	0.2598	63.0	101.0	6.60
A5106.7	–	6.70	0.2638	63.0	101.0	6.70
A51017/64	17/64	6.75	0.2656	69.0	109.0	6.75
A5106.8	–	6.80	0.2677	69.0	109.0	6.80



Product	DC	DC	DC	LCF	OAL	DCON MS
	(inch)	(mm)	(inch)	(mm)	(mm)	(mm)
A5106.9	–	6.90	0.2717	69.0	109.0	6.90
A5107.0	–	7.00	0.2756	69.0	109.0	7.00
A5107.1	–	7.10	0.2795	69.0	109.0	7.10
A5109/32	9/32	7.14	0.2813	69.0	109.0	7.14
A5107.2	–	7.20	0.2835	69.0	109.0	7.20
A5107.3	–	7.30	0.2874	69.0	109.0	7.30
A5107.4	–	7.40	0.2913	69.0	109.0	7.40
A5107.5	–	7.50	0.2953	69.0	109.0	7.50
A51019/64	19/64	7.54	0.2969	75.0	117.0	7.54
A5107.6	–	7.60	0.2992	75.0	117.0	7.60
A5107.8	–	7.80	0.3071	75.0	117.0	7.80
A5105/16	5/16	7.94	0.3125	75.0	117.0	7.94
A5108.0	–	8.00	0.3150	75.0	117.0	8.00
A5108.1	–	8.10	0.3189	75.0	117.0	8.10
A5108.2	–	8.20	0.3228	75.0	117.0	8.20
A5108.3	–	8.30	0.3268	75.0	117.0	8.30
A5108.5	–	8.50	0.3346	75.0	117.0	8.50
A5108.6	–	8.60	0.3386	81.0	125.0	8.60
A5108.7	–	8.70	0.3425	81.0	125.0	8.70
A51011/32	11/32	8.73	0.3438	81.0	125.0	8.73
A5108.8	–	8.80	0.3465	81.0	125.0	8.80
A5108.9	–	8.90	0.3504	81.0	125.0	8.90
A5109.0	–	9.00	0.3543	81.0	125.0	9.00
A5109.1	–	9.10	0.3583	81.0	125.0	9.10
A5109.2	–	9.20	0.3622	81.0	125.0	9.20
A5109.3	–	9.30	0.3661	81.0	125.0	9.30
A5109.4	–	9.40	0.3701	81.0	125.0	9.40
A5109.5	–	9.50	0.3740	81.0	125.0	9.50
A5103/8	3/8	9.52	0.3750	87.0	133.0	9.52

Product	DC	DC	DC	LCF	OAL	DCON MS
	(inch)	(mm)	(inch)	(mm)	(mm)	(mm)
A5109.6	–	9.60	0.3780	87.0	133.0	9.60
A5109.7	–	9.70	0.3819	87.0	133.0	9.70
A5109.8	–	9.80	0.3858	87.0	133.0	9.80
A5109.9	–	9.90	0.3898	87.0	133.0	9.90
A51025/64	25/64	9.92	0.3906	87.0	133.0	9.92
A51010.0	–	10.00	0.3937	87.0	133.0	10.00
A51010.1	–	10.10	0.3976	87.0	133.0	10.10
A51010.2	–	10.20	0.4016	87.0	133.0	10.20
A51010.3	–	10.30	0.4055	87.0	133.0	10.30
A51013/32	13/32	10.32	0.4063	87.0	133.0	10.32
A51010.4	–	10.40	0.4094	87.0	133.0	10.40
A51010.5	–	10.50	0.4134	87.0	133.0	10.50
A51027/64	27/64	10.72	0.4219	94.0	142.0	10.72
A51010.8	–	10.80	0.4252	94.0	142.0	10.80
A51011.0	–	11.00	0.4331	94.0	142.0	11.00
A51011.1	–	11.10	0.4370	94.0	142.0	11.10
A5107/16	7/16	11.11	0.4375	94.0	142.0	11.11
A51011.5	–	11.50	0.4528	94.0	142.0	11.50
A51011.7	–	11.70	0.4606	94.0	142.0	11.70
A51011.8	–	11.80	0.4646	94.0	142.0	11.80
A51015/32	15/32	11.91	0.4688	101.0	151.0	11.91
A51012.0	–	12.00	0.4724	101.0	151.0	12.00
A51012.3	–	12.30	0.4843	101.0	151.0	12.30
A51031/64	31/64	12.30	0.4844	101.0	151.0	12.30
A51012.5	–	12.50	0.4921	101.0	151.0	12.50
A5101/2	1/2	12.70	0.5000	101.0	151.0	12.70
A51013.0	–	13.00	0.5118	101.0	151.0	13.00
A51014.0	–	14.00	0.5512	108.0	160.0	14.00

A553



ADX-borr av HSS-E (5% Kobolt), kort, TiAlN Top-belagd, invändiga kylkanaler

Högproduktivt borr som ger hål med hög noggrannhet och finish. H9-tolerans möjlig under rätt förhållanden. 130° spetsvinkel och självcentrerande spets med svängda huvudeggar. TiN-beläggning ökar slitstyrka och livslängd. Invändiga kylkanaler. Används i CNC-maskiner och kan användas i de flesta material.

ADX

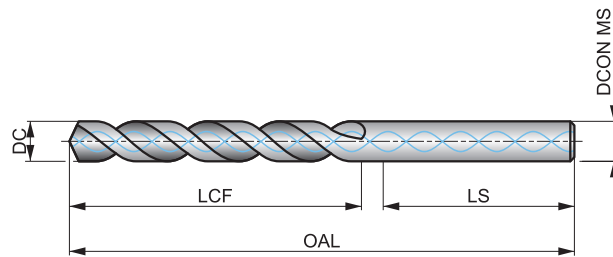

HSS-E	DORMER	5xD
130°	TiAlN Top	DIN 6535HA
>35°	R	
DC h8		

Arbetsmaterialgrupper och startvärden för skärhastighet (m/min) och matningskod. Tabeller med matningar finns med början på sidan 274

P1.1 ■ 80 L	P1.2 ■ 89 L	P1.3 ■ 92 L	P2.1 ■ 68 L	P2.2 ■ 60 L	P2.3 ■ 53 F	P3.1 ■ 41 H	P3.2 ■ 33 H	P3.3 ■ 28 F	P4.1 ■ 25 H	P4.2 ■ 21 F	P4.3 ■ 17 D	M1.1 ■ 55 G	M1.2 ■ 46 G
M2.1 ■ 49 G	M2.2 ■ 40 G	M3.1 ■ 22 I	M3.2 ■ 19 I	M3.3 ▣ 17 I	M4.1 ▣ 27 G	K1.1 ■ 70 K	K1.2 ■ 52 J	K1.3 ■ 39 J	K2.1 ■ 55 J	K2.2 ■ 45 J	K2.3 ■ 36 F	K3.1 ■ 49 J	K3.2 ■ 37 J
K3.3 ■ 30 F	K4.1 ■ 45 J	K4.2 ■ 34 J	K4.3 ■ 25 F	K4.4 ■ 22 F	K4.5 ■ 18 F	K5.1 ■ 51 J	K5.2 ■ 39 J	K5.3 ■ 30 F	N1.1 ▣ 70 H	N1.2 ▣ 53 H	N1.3 ■ 35 M	N2.1 ■ 85 I	N2.2 ■ 76 I
N2.3 ■ 55 I	N3.1 ■ 144 I	N3.2 ■ 85 I	N3.3 ▣ 43 G	N4.1 ■ 90 G	S1.1 ■ 45 G	S1.2 ▣ 30 E	S1.3 ▣ 8 C	S2.1 ▣ 20 E	S2.2 ▣ 14 G	S3.1 ▣ 15 E	S3.2 ▣ 10 G	S4.1 ▣ 12 E	S4.2 ▣ 8 G

DCON MS tolerans h6.

Product	DC (mm)	DC (inch)	LCF (mm)	OAL (mm)	LS (mm)	DCON MS (mm)
A5535.0	5.00	0.1969	36.0	79.0	36.0	6.00
A5535.5	5.50	0.2165	40.0	79.0	36.0	6.00
A5536.0	6.00	0.2362	43.0	79.0	36.0	6.00
A5538.0	8.00	0.3150	58.0	94.0	36.0	8.00
A5538.5	8.50	0.3346	75.0	130.0	40.0	10.00
A5539.0	9.00	0.3543	75.0	130.0	40.0	10.00
A5539.5	9.50	0.3740	75.0	130.0	40.0	10.00
A55310.3	10.30	0.4055	87.0	150.0	45.0	12.00
A55311.0	11.00	0.4331	94.0	150.0	45.0	12.00

Product	DC (mm)	DC (inch)	LCF (mm)	OAL (mm)	LS (mm)	DCON MS (mm)
A55311.3	11.30	0.4449	94.0	150.0	45.0	12.00
A55311.5	11.50	0.4528	94.0	150.0	45.0	12.00
A55312.0	12.00	0.4724	94.0	150.0	45.0	12.00
A55312.5	12.50	0.4921	101.0	160.0	45.0	14.00
A55313.0	13.00	0.5118	101.0	160.0	45.0	14.00
A55313.5	13.50	0.5315	101.0	160.0	45.0	14.00
A55314.0	14.00	0.5512	101.0	160.0	45.0	14.00
A55315.0	15.00	0.5906	108.0	170.0	48.0	16.00
A55318.0	18.00	0.7087	130.0	190.0	48.0	18.00

R003



Kort borr i solid hårdmetall, TiN-spetsbelagd

Mångsidig instegsborr med 120° spetsvinkel med fyra fasetters delad spetsgeometri för minskad skärkraft och CTW-spårkonstruktion för ökad inträngningsförmåga. TiN-beläggning förbättrar prestanda och förlänger verktygets livslängd. Lämplig för både CNC-maskiner och konventionella maskiner i ett brett spektrum av arbetsstyckesmaterial.

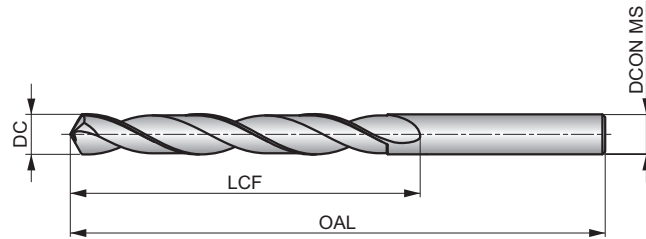

HM	DIN 338	4×D
120°	TiN-Tip	
λ 20-35°	R	DC h7

Arbetsmaterialgrupper och startvärden för skärhastighet (m/min) och matningskod. Tabeller med matningar finns med början på sidan 274

P1.1 ■ 99 S	P1.2 ■ 111 S	P1.3 ■ 115 S	P2.1 ■ 85 S	P2.2 ■ 75 S	P2.3 ■ 66 S	P3.1 ■ 66 S	P3.2 ■ 53 S	P3.3 ■ 45 S	P4.1 ■ 40 S	P4.2 ■ 34 S	P4.3 ■ 27 S	K1.1 ■ 75 T	K1.2 ■ 56 T
K1.3 ■ 42 T	K2.1 ■ 68 T	K2.2 ■ 55 T	K2.3 ■ 44 T	K3.1 ■ 60 T	K3.2 ■ 46 T	K3.3 ■ 37 T	K4.1 ■ 55 T	K4.2 ■ 42 T	K4.3 ■ 31 T	K4.4 ■ 26 T	K4.5 ■ 22 T	K5.1 ■ 63 T	K5.2 ■ 47 T
K5.3 ■ 37 T	N1.1 ■ 150 V	N1.2 ■ 113 V	N1.3 ■ 75 V	N2.1 ■ 129 V	N2.2 ■ 116 V	N2.3 ■ 84 V	N3.1 ■ 317 V	N3.2 ■ 190 V	N4.1 ■ 60 U	N4.2 ■ 100 U	H1.1 ■ 34 S	H2.1 ■ 20 S	H3.1 ■ 22 S

Product	DC (inch)	DC (mm)	DC (inch)	LCF (mm)	OAL (mm)	DCON MS (mm)
R0031.0	–	1.00	0.0394	12.0	34.0	1.00
R003N60	N60	1.02	0.0400	12.0	34.0	1.02
R0031.1	–	1.10	0.0433	14.0	36.0	1.10
R003N56	N56	1.18	0.0465	16.0	38.0	1.18
R0033/64	3/64	1.19	0.0469	16.0	38.0	1.19
R0031.2	–	1.20	0.0472	16.0	38.0	1.20
R0031.3	–	1.30	0.0512	16.0	38.0	1.30
R003N54	N54	1.40	0.0550	18.0	40.0	1.40
R0031.4	–	1.40	0.0551	18.0	40.0	1.40
R0031.5	–	1.50	0.0591	18.0	40.0	1.50
R003N53	N53	1.51	0.0595	20.0	43.0	1.51
R0031/16	1/16	1.59	0.0625	20.0	43.0	1.59
R0031.6	–	1.60	0.0630	20.0	43.0	1.60
R003N52	N52	1.61	0.0635	20.0	43.0	1.61
R0031.7	–	1.70	0.0669	20.0	43.0	1.70
R003N51	N51	1.70	0.0670	22.0	46.0	1.70
R003N50	N50	1.78	0.0700	22.0	46.0	1.78
R0031.8	–	1.80	0.0709	22.0	46.0	1.80
R0031.9	–	1.90	0.0748	22.0	46.0	1.90
R003N48	N48	1.93	0.0760	24.0	49.0	1.93
R0035/64	5/64	1.98	0.0781	24.0	49.0	1.98
R003N47	N47	1.99	0.0785	24.0	49.0	1.99
R0032.0	–	2.00	0.0787	24.0	49.0	2.00
R003N46	N46	2.06	0.0810	24.0	49.0	2.06
R0032.1	–	2.10	0.0827	24.0	49.0	2.10
R003N44	N44	2.18	0.0860	27.0	53.0	2.18
R0032.2	–	2.20	0.0866	27.0	53.0	2.20
R003N43	N43	2.26	0.0890	27.0	53.0	2.26

Product	DC (inch)	DC (mm)	DC (inch)	LCF (mm)	OAL (mm)	DCON MS (mm)
R0032.3	–	2.30	0.0906	27.0	53.0	2.30
R0033/32	3/32	2.38	0.0937	30.0	57.0	2.38
R0032.4	–	2.40	0.0945	30.0	57.0	2.40
R003N41	N41	2.44	0.0960	30.0	57.0	2.44
R0032.5	–	2.50	0.0984	30.0	57.0	2.50
R003N39	N39	2.53	0.0995	30.0	57.0	2.53
R003N38	N38	2.58	0.1015	30.0	57.0	2.58
R0032.6	–	2.60	0.1024	30.0	57.0	2.60
R003N37	N37	2.64	0.1040	30.0	57.0	2.64
R0032.7	–	2.70	0.1063	33.0	61.0	2.70
R003N36	N36	2.71	0.1065	33.0	61.0	2.71
R0037/64	7/64	2.78	0.1094	33.0	61.0	2.78
R0032.8	–	2.80	0.1102	33.0	61.0	2.80
R003N33	N33	2.87	0.1130	33.0	61.0	2.87
R0032.9	–	2.90	0.1142	33.0	61.0	2.90
R003N32	N32	2.95	0.1160	33.0	61.0	2.95
R0033.0	–	3.00	0.1181	33.0	61.0	3.00
R003N31	N31	3.05	0.1200	36.0	65.0	3.05
R0033.1	–	3.10	0.1220	36.0	65.0	3.10
R0031/8	1/8	3.17	0.1250	36.0	65.0	3.17
R0033.2	–	3.20	0.1260	36.0	65.0	3.20
R0033.3	–	3.30	0.1299	36.0	65.0	3.30
R0033.4	–	3.40	0.1339	39.0	70.0	3.40
R003N29	N29	3.45	0.1360	39.0	70.0	3.45
R0033.5	–	3.50	0.1378	39.0	70.0	3.50
R003N28	N28	3.57	0.1405	39.0	70.0	3.57
R0039/64	9/64	3.57	0.1406	39.0	70.0	3.57
R0033.6	–	3.60	0.1417	39.0	70.0	3.60

Product	DC	DC	DC	LCF	OAL	DCON MS
	(inch)	(mm)	(inch)	(mm)	(mm)	(mm)
R0033.7	–	3.70	0.1457	39.0	70.0	3.70
R003N26	N26	3.73	0.1470	39.0	70.0	3.73
R003N25	N25	3.80	0.1495	43.0	75.0	3.80
R0033.8	–	3.80	0.1496	43.0	75.0	3.80
R0033.9	–	3.90	0.1535	43.0	75.0	3.90
R0035/32	5/32	3.97	0.1563	43.0	75.0	3.97
R0034.0	–	4.00	0.1575	43.0	75.0	4.00
R003N21	N21	4.04	0.1590	43.0	75.0	4.04
R003N20	N20	4.09	0.1610	43.0	75.0	4.09
R0034.1	–	4.10	0.1614	43.0	75.0	4.10
R0034.2	–	4.20	0.1654	43.0	75.0	4.20
R003N19	N19	4.22	0.1660	43.0	75.0	4.22
R0034.3	–	4.30	0.1693	47.0	80.0	4.30
R00311/64	11/64	4.37	0.1719	47.0	80.0	4.37
R003N17	N17	4.39	0.1730	47.0	80.0	4.39
R0034.4	–	4.40	0.1732	47.0	80.0	4.40
R0034.5	–	4.50	0.1772	47.0	80.0	4.50
R003N15	N15	4.57	0.1800	47.0	80.0	4.57
R0034.6	–	4.60	0.1811	47.0	80.0	4.60
R0034.7	–	4.70	0.1850	47.0	80.0	4.70
R0033/16	3/16	4.76	0.1875	52.0	86.0	4.76
R003N12	N12	4.80	0.1890	52.0	86.0	4.80
R0034.8	–	4.80	0.1890	52.0	86.0	4.80
R003N11	N11	4.85	0.1910	52.0	86.0	4.85
R0034.9	–	4.90	0.1929	52.0	86.0	4.90
R003N10	N10	4.92	0.1935	52.0	86.0	4.92
R0035.0	–	5.00	0.1969	52.0	86.0	5.00
R0035.1	–	5.10	0.2008	52.0	86.0	5.10
R003N7	N7	5.11	0.2010	52.0	86.0	5.11
R00313/64	13/64	5.16	0.2031	52.0	86.0	5.16
R0035.2	–	5.20	0.2047	52.0	86.0	5.20
R0035.3	–	5.30	0.2087	52.0	86.0	5.30
R0035.4	–	5.40	0.2126	57.0	93.0	5.40
R003N3	N3	5.41	0.2130	57.0	93.0	5.41
R0035.5	–	5.50	0.2165	57.0	93.0	5.50
R0037/32	7/32	5.56	0.2187	57.0	93.0	5.56
R0035.6	–	5.60	0.2205	57.0	93.0	5.60
R003N2	N2	5.61	0.2210	57.0	93.0	5.61
R0035.7	–	5.70	0.2244	57.0	93.0	5.70
R0035.8	–	5.80	0.2283	57.0	93.0	5.80
R0035.9	–	5.90	0.2323	57.0	93.0	5.90
R00315/64	15/64	5.95	0.2344	57.0	93.0	5.95
R0036.0	–	6.00	0.2362	57.0	93.0	6.00
R0036.1	–	6.10	0.2402	63.0	101.0	6.10
R003C	C	6.15	0.2420	63.0	101.0	6.15
R0036.2	–	6.20	0.2441	63.0	101.0	6.20
R0036.3	–	6.30	0.2480	63.0	101.0	6.30
R0031/4	1/4	6.35	0.2500	63.0	101.0	6.35
R0036.4	–	6.40	0.2520	63.0	101.0	6.40
R0036.5	–	6.50	0.2559	63.0	101.0	6.50
R003F	F	6.53	0.2570	63.0	101.0	6.53
R0036.6	–	6.60	0.2598	63.0	101.0	6.60
R0036.7	–	6.70	0.2638	63.0	101.0	6.70
R00317/64	17/64	6.75	0.2656	69.0	109.0	6.75
R0036.8	–	6.80	0.2677	69.0	109.0	6.80
R0036.9	–	6.90	0.2717	69.0	109.0	6.90

Product	DC	DC	DC	LCF	OAL	DCON MS
	(inch)	(mm)	(inch)	(mm)	(mm)	(mm)
R003I	I	6.91	0.2720	69.0	109.0	6.91
R0037.0	–	7.00	0.2756	69.0	109.0	7.00
R0037.1	–	7.10	0.2795	69.0	109.0	7.10
R0039/32	9/32	7.14	0.2813	69.0	109.0	7.14
R0037.2	–	7.20	0.2835	69.0	109.0	7.20
R0037.3	–	7.30	0.2874	69.0	109.0	7.30
R0037.4	–	7.40	0.2913	69.0	109.0	7.40
R0037.5	–	7.50	0.2953	69.0	109.0	7.50
R00319/64	19/64	7.54	0.2969	75.0	117.0	7.54
R0037.6	–	7.60	0.2992	75.0	117.0	7.60
R0037.7	–	7.70	0.3031	75.0	117.0	7.70
R0037.8	–	7.80	0.3071	75.0	117.0	7.80
R0037.9	–	7.90	0.3110	75.0	117.0	7.90
R0035/16	5/16	7.94	0.3125	75.0	117.0	7.94
R0038.0	–	8.00	0.3150	75.0	117.0	8.00
R0038.1	–	8.10	0.3189	75.0	117.0	8.10
R0038.2	–	8.20	0.3228	75.0	117.0	8.20
R0038.3	–	8.30	0.3268	75.0	117.0	8.30
R00321/64	21/64	8.33	0.3281	75.0	117.0	8.33
R0038.4	–	8.40	0.3307	75.0	117.0	8.40
R003Q	Q	8.43	0.3320	75.0	117.0	8.43
R0038.5	–	8.50	0.3346	75.0	117.0	8.50
R0038.6	–	8.60	0.3386	81.0	125.0	8.60
R003R	R	8.61	0.3390	81.0	125.0	8.61
R0038.7	–	8.70	0.3425	81.0	125.0	8.70
R00311/32	11/32	8.73	0.3437	81.0	125.0	8.73
R0038.8	–	8.80	0.3465	81.0	125.0	8.80
R0038.9	–	8.90	0.3504	81.0	125.0	8.90
R0039.0	–	9.00	0.3543	81.0	125.0	9.00
R0039.1	–	9.10	0.3583	81.0	125.0	9.10
R00323/64	23/64	9.13	0.3594	81.0	125.0	9.13
R0039.2	–	9.20	0.3622	81.0	125.0	9.20
R0039.3	–	9.30	0.3661	81.0	125.0	9.30
R003U	U	9.35	0.3680	81.0	125.0	9.35
R0039.4	–	9.40	0.3701	81.0	125.0	9.40
R0039.5	–	9.50	0.3740	81.0	125.0	9.50
R0033/8	3/8	9.53	0.3750	87.0	133.0	9.53
R0039.6	–	9.60	0.3780	87.0	133.0	9.60
R0039.7	–	9.70	0.3819	87.0	133.0	9.70
R0039.8	–	9.80	0.3858	87.0	133.0	9.80
R003W	W	9.80	0.3860	87.0	133.0	9.80
R0039.9	–	9.90	0.3898	87.0	133.0	9.90
R00310.0	–	10.00	0.3937	87.0	133.0	10.00
R00310.2	–	10.20	0.4016	87.0	133.0	10.20
R00313/32	13/32	10.32	0.4063	87.0	133.0	10.32
R00310.5	–	10.50	0.4134	87.0	133.0	10.50
R00327/64	27/64	10.72	0.4219	94.0	142.0	10.72
R00311.0	–	11.00	0.4331	94.0	142.0	11.00
R0037/16	7/16	11.11	0.4375	94.0	142.0	11.11
R00311.5	–	11.50	0.4528	94.0	142.0	11.50
R00329/64	29/64	11.51	0.4531	94.0	142.0	11.51
R00315/32	15/32	11.91	0.4687	101.0	151.0	11.91
R00312.0	–	12.00	0.4724	101.0	151.0	12.00
R0031/2	1/2	12.70	0.5000	101.0	151.0	12.70
R00313.0	–	13.00	0.5118	101.0	151.0	13.00
R00314.0	–	14.00	0.5512	108.0	160.0	14.00

Verktymsmaterial (BMC)	HSS-E	HSS-E	HSS-E	HSS-E	HSS-E	HSS												
Standard (BSG)	DIN ANSI	DIN ANSI	DIN 1869-1	DIN 1869-2	DIN 1869-3	DIN 1870(2)												
Användbar längd (ULDR)	6×D	10×D	15×D	20×D	25×D	20×D												
Spetsvinkel																		
Beläggning	Bright	Bright	Bright	Bright	Bright	Bright ST												
Skaf																		
Spiralform																		
Skärriktning																		
	PFX	PFX	PFX	PFX	PFX	PFX												
Produktfamilj	A900	A940	A976	A977	A978	A952												
PSF skärdiametrar	1.00 - 20.00	1.00 - 19.00	1.50 - 14.00	1.50 - 14.00	3.00 - 10.00	8.00 - 30.00												
P	P1	■	■	■	■	■												
	P2	■	■	■	■	■												
	P3	■	■	■	■	■												
	P4	■	■	■	■	■												
M	M1	■	■	■	■	■												
	M2	■	■	■	■	■												
	M3	■	■	■	■	■												
	M4	■	■	■	■	■												
K	K1	■																
	K2	■	■	■	■	■												
	K3	■	■	■	■	■												
	K4	■	■	■	■	■												
	K5	■	■	■	■	■												
N	N1	■	■															
	N2	■	■															
	N3	■	■	■	■	■												
	N4	■	■															
	N5																	
S	S1	■	■	■	■	■												
	S2	■																
	S3	■																
	S4	■																
H	H1																	
	H2																	
	H3																	
	H4																	

A900



PFX-borr av HSS-E (5% Kobolt), kort, blank

Högproduktivt borr som ger hål med hög noggrannhet och finish. H10-tolerans möjlig under rätt förhållanden. 130° spetsvinkel med korspets och parabolisk spårutformning. Alcrona Top-beläggning ökar slitstyrka och livslängd. Kan användas i de flesta material.

PFX

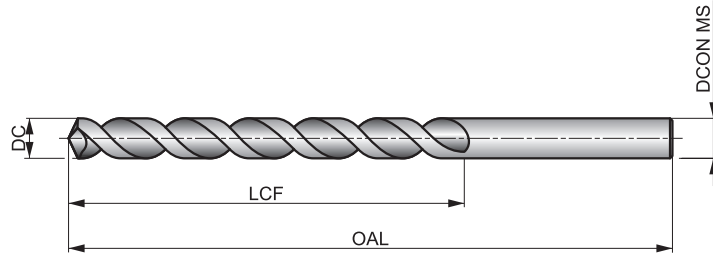

HSS-E	DIN ANSI	6×D
130°	Bright	
λ>35°		DC h8

Arbetsmaterialgrupper och startvärden för skärhastighet (m/min) och matningskod. Tabeller med matningar finns med början på sidan 274

P1.1 ■ 34 H	P1.2 ■ 39 H	P1.3 ■ 40 H	P2.1 ■ 30 H	P2.2 ■ 26 H	P2.3 ■ 23 E	P3.1 ■ 31 H	P3.2 ■ 25 H	P3.3 ■ 21 E	P4.1 ■ 19 H	P4.2 ■ 16 E	P4.3 ■ 13 E	M1.1 ■ 21 E	M1.2 ■ 17 E
M2.1 ■ 18 E	M2.2 ■ 15 E	M3.1 ■ 8 E	M3.2 ■ 7 E	M3.3 ■ 6 E	M4.1 ■ 9 C	K1.1 □ 24 J	K1.2 □ 18 J	K1.3 □ 13 J	K2.1 □ 23 J	K2.2 □ 19 J	K2.3 □ 15 I	K3.1 □ 21 J	K3.2 □ 16 J
K3.3 □ 13 I	K4.1 □ 19 J	K4.2 □ 14 J	K4.3 □ 11 I	K4.4 □ 9 I	K4.5 □ 8 I	K5.1 □ 22 J	K5.2 □ 16 J	K5.3 □ 13 I	N1.1 □ 60 J	N1.2 □ 45 J	N1.3 □ 30 N	N2.1 □ 62 N	N2.2 □ 55 N
N2.3 □ 40 N	N3.1 □ 90 H	N3.2 □ 53 I	N3.3 □ 27 G	N4.1 □ 55 I	N4.2 □ 40 G	S1.1 ■ 22 E	S1.2 ■ 15 E	S1.3 ■ 6 C	S2.1 ■ 9 G	S2.2 ■ 8 C	S3.1 ■ 7 G	S3.2 ■ 6 C	S4.1 ■ 5 G
S4.2 ■ 5 C													

Product	DC (inch)	DC (mm)	DC (inch)	LCF (mm)	OAL (mm)	DCON MS (mm)
A9001.0	–	1.00	0.0394	12.0	34.0	1.00
A9001.1	–	1.10	0.0433	14.0	36.0	1.10
A9001.2	–	1.20	0.0472	16.0	38.0	1.20
A9001.25	–	1.25	0.0492	16.0	36.0	1.25
A9001.3	–	1.30	0.0512	16.0	38.0	1.30
A9001.4	–	1.40	0.0551	18.0	40.0	1.40
A9001.5	–	1.50	0.0591	18.0	40.0	1.50
A9001.55	–	1.55	0.0610	20.0	43.0	1.55
A9001/16	1/16	1.59	0.0625	22.0	48.0	1.59
A9001.6	–	1.60	0.0630	20.0	43.0	1.60
A9001.7	–	1.70	0.0669	20.0	43.0	1.70
A9001.75	–	1.75	0.0689	22.0	46.0	1.75
A9001.8	–	1.80	0.0709	22.0	46.0	1.80
A9001.9	–	1.90	0.0748	22.0	46.0	1.90
A9005/64	5/64	1.98	0.0781	25.0	51.0	1.98
A9002.0	–	2.00	0.0787	24.0	49.0	2.00
A9002.1	–	2.10	0.0827	24.0	49.0	2.10
A9002.2	–	2.20	0.0866	27.0	53.0	2.20
A9002.3	–	2.30	0.0906	27.0	53.0	2.30
A9003/32	3/32	2.38	0.0937	32.0	57.0	2.38
A9002.4	–	2.40	0.0945	30.0	57.0	2.40
A9002.5	–	2.50	0.0984	30.0	57.0	2.50
A9002.6	–	2.60	0.1024	30.0	57.0	2.60
A9002.7	–	2.70	0.1063	33.0	61.0	2.70

Product	DC (inch)	DC (mm)	DC (inch)	LCF (mm)	OAL (mm)	DCON MS (mm)
A9007/64	7/64	2.78	0.1094	38.0	67.0	2.78
A9002.8	–	2.80	0.1102	33.0	61.0	2.80
A9002.9	–	2.90	0.1142	33.0	61.0	2.90
A9003.0	–	3.00	0.1181	33.0	61.0	3.00
A9003.1	–	3.10	0.1220	36.0	65.0	3.10
A9001/8	1/8	3.18	0.1250	41.0	70.0	3.18
A9003.2	–	3.20	0.1260	36.0	65.0	3.20
A9003.3	–	3.30	0.1299	36.0	65.0	3.30
A9003.4	–	3.40	0.1339	39.0	70.0	3.40
A9003.5	–	3.50	0.1378	39.0	70.0	3.50
A9009/64	9/64	3.57	0.1406	44.0	73.0	3.57
A9003.6	–	3.60	0.1417	39.0	70.0	3.60
A9003.7	–	3.70	0.1457	39.0	70.0	3.70
A9003.8	–	3.80	0.1496	43.0	75.0	3.80
A9003.9	–	3.90	0.1535	43.0	75.0	3.90
A9005/32	5/32	3.97	0.1563	51.0	79.0	3.97
A9004.0	–	4.00	0.1575	43.0	75.0	4.00
A9004.1	–	4.10	0.1614	43.0	75.0	4.10
A9004.2	–	4.20	0.1654	43.0	75.0	4.20
A9004.3	–	4.30	0.1693	47.0	80.0	4.30
A90011/64	11/64	4.37	0.1719	54.0	83.0	4.37
A9004.5	–	4.50	0.1772	47.0	80.0	4.50
A9004.6	–	4.60	0.1811	47.0	80.0	4.60
A9004.7	–	4.70	0.1850	47.0	80.0	4.70



Product	DC	DC	DC	LCF	OAL	DCON MS
	(inch)	(mm)	(inch)	(mm)	(mm)	(mm)
A9003/16	3/16	4.76	0.1875	59.0	89.0	4.76
A9004.9	–	4.90	0.1929	52.0	86.0	4.90
A9005.0	–	5.00	0.1969	52.0	86.0	5.00
A9005.1	–	5.10	0.2008	52.0	86.0	5.10
A90013/64	13/64	5.16	0.2031	62.0	92.0	5.16
A9005.2	–	5.20	0.2047	52.0	86.0	5.20
A9005.3	–	5.30	0.2087	52.0	86.0	5.30
A9005.4	–	5.40	0.2126	57.0	93.0	5.40
A9005.5	–	5.50	0.2165	57.0	93.0	5.50
A9007/32	7/32	5.56	0.2188	64.0	95.0	5.56
A9005.6	–	5.60	0.2205	57.0	93.0	5.60
A9005.7	–	5.70	0.2244	57.0	93.0	5.70
A9005.8	–	5.80	0.2283	57.0	93.0	5.80
A9005.9	–	5.90	0.2323	57.0	93.0	5.90
A9006.0	–	6.00	0.2362	57.0	93.0	6.00
A9006.1	–	6.10	0.2402	63.0	101.0	6.10
A9006.2	–	6.20	0.2441	63.0	101.0	6.20
A9006.3	–	6.30	0.2480	63.0	101.0	6.30
A9001/4	1/4	6.35	0.2500	70.0	102.0	6.35
A9006.4	–	6.40	0.2520	63.0	101.0	6.40
A9006.5	–	6.50	0.2559	63.0	101.0	6.50
A9006.6	–	6.60	0.2598	63.0	101.0	6.60
A9006.7	–	6.70	0.2638	63.0	101.0	6.70
A90017/64	17/64	6.75	0.2656	73.0	105.0	6.75
A9006.8	–	6.80	0.2677	69.0	109.0	6.80
A9006.9	–	6.90	0.2717	69.0	109.0	6.90
A9007.0	–	7.00	0.2756	69.0	109.0	7.00
A9007.1	–	7.10	0.2795	69.0	109.0	7.10
A9007.2	–	7.20	0.2835	69.0	109.0	7.20
A9007.4	–	7.40	0.2913	69.0	109.0	7.40
A9007.5	–	7.50	0.2953	69.0	109.0	7.50
A9005/16	5/16	7.94	0.3125	81.0	114.0	7.94
A9008.0	–	8.00	0.3150	75.0	117.0	8.00
A9008.1	–	8.10	0.3189	75.0	117.0	8.10
A9008.5	–	8.50	0.3346	75.0	117.0	8.50

Product	DC	DC	DC	LCF	OAL	DCON MS
	(inch)	(mm)	(inch)	(mm)	(mm)	(mm)
A9008.7	–	8.70	0.3425	81.0	125.0	8.70
A90011/32	11/32	8.73	0.3438	87.0	121.0	8.73
A9008.8	–	8.80	0.3465	81.0	125.0	8.80
A9009.0	–	9.00	0.3543	81.0	125.0	9.00
A9009.5	–	9.50	0.3740	81.0	125.0	9.50
A9003/8	3/8	9.52	0.3750	92.0	127.0	9.52
A90010.0	–	10.00	0.3937	87.0	133.0	10.00
A90010.2	–	10.20	0.4016	87.0	133.0	10.20
A90010.3	–	10.30	0.4055	87.0	133.0	10.30
A90010.5	–	10.50	0.4134	87.0	133.0	10.50
A90011.0	–	11.00	0.4331	94.0	142.0	11.00
A90011.5	–	11.50	0.4528	94.0	142.0	11.50
A90011.8	–	11.80	0.4646	94.0	142.0	11.80
A90015/32	15/32	11.91	0.4688	110.0	146.0	11.91
A90012.0	–	12.00	0.4724	101.0	151.0	12.00
A90031/64	31/64	12.30	0.4844	111.0	149.0	12.30
A90012.5	–	12.50	0.4921	101.0	151.0	12.50
A9001/2	1/2	12.70	0.5000	101.0	151.0	12.70
A90013.0	–	13.00	0.5118	101.0	151.0	13.00
A90013.5	–	13.50	0.5315	108.0	160.0	13.50
A90014.0	–	14.00	0.5512	108.0	160.0	14.00
A9009/16	9/16	14.29	0.5625	122.0	168.0	14.29
A90015.0	–	15.00	0.5906	114.0	169.0	15.00
A90016.0	–	16.00	0.6299	120.0	178.0	16.00
A90017.0	–	17.00	0.6693	125.0	184.0	17.00
A90011/16	11/16	17.46	0.6875	143.0	194.0	17.46
A90018.0	–	18.00	0.7087	130.0	191.0	18.00
A90023/32	23/32	18.26	0.7188	130.0	191.0	18.26
A90018.5	–	18.50	0.7283	135.0	198.0	18.50
A90047/64	47/64	18.65	0.7344	135.0	198.0	18.65
A9003/4	3/4	19.05	0.7500	135.0	198.0	19.05
A90049/64	49/64	19.45	0.7656	135.0	198.0	19.45
A90019.5	–	19.50	0.7677	140.0	205.0	19.50
A90025/32	25/32	19.84	0.7813	140.0	205.0	19.84
A90020.0	–	20.00	0.7874	140.0	205.0	20.00

A940



PFX-borr av HSS-E (5% Kobolt), lång, blank

Högproduktivt borr som ger hål med hög noggrannhet och finish. H10-tolerans möjlig under rätt förhållanden. 130° spetsvinkel med korspets och parabolisk spårutformning. Alcrona Top-beläggning ökar slitstyrka och livslängd. Kan användas i de flesta material.

PFX

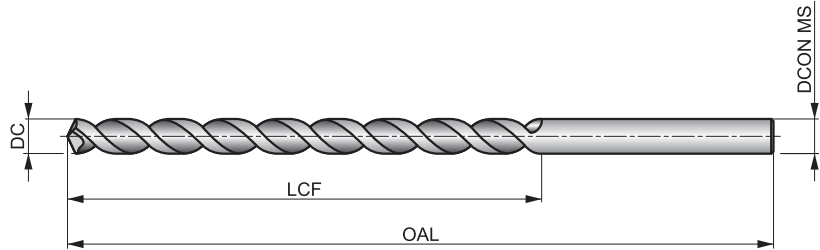

HSS-E	DIN ANSI	10xD
	Bright	
	R	DC h8

Arbetsmaterialgrupper och startvärden för skärhastighet (m/min) och matningskod. Tabeller med matningar finns med början på sidan 274

P1.1 ■ 29 F	P1.2 ■ 33 F	P1.3 ■ 34 F	P2.1 ■ 25 F	P2.2 ■ 22 G	P2.3 ■ 19 C	P3.1 ■ 25 G	P3.2 ■ 20 G	P3.3 ■ 17 C	P4.1 ■ 15 G	P4.2 ■ 13 C	P4.3 ■ 10 C	M1.1 ■ 21 C	M1.2 ■ 17 C
M2.1 ■ 18 C	M2.2 ■ 15 C	M3.1 ■ 8 E	M3.2 ■ 7 E	M3.3 ■ 6 E	M4.1 ■ 9 B	K2.1 ▣ 20 I	K2.2 ▣ 16 I	K2.3 ▣ 13 H	K3.1 ▣ 17 I	K3.2 ▣ 13 I	K3.3 ▣ 11 H	K4.1 ▣ 16 I	K4.2 ▣ 12 I
K4.3 ▣ 9 H	K4.4 ▣ 18 H	K4.5 ▣ 6 H	K5.1 ▣ 18 I	K5.2 ▣ 14 I	K5.3 ▣ 11 H	N1.1 ▣ 53 H	N1.2 ▣ 40 H	N1.3 ■ 27 N	N2.1 ▣ 62 N	N2.2 ▣ 55 N	N2.3 ▣ 40 N	N3.1 ▣ 119 G	N3.2 ▣ 70 F
N3.3 ▣ 35 F	N4.1 ▣ 55 H	N4.2 ▣ 40 F	S1.1 ■ 18 E	S1.2 ■ 13 C	S1.3 ■ 6 C								

DC >= 9,6mm mindre än 10xD.

Product	DC (inch)	DC (mm)	DC (inch)	LCF (mm)	OAL (mm)	DCON MS (mm)
A9401.0	–	1.00	0.0394	33.0	56.0	1.00
A9401.1	–	1.10	0.0433	37.0	60.0	1.10
A9403/64	3/64	1.19	0.0469	29.0	57.0	1.19
A9401.2	–	1.20	0.0472	41.0	65.0	1.20
A9401.3	–	1.30	0.0512	41.0	65.0	1.30
A9401.4	–	1.40	0.0551	45.0	70.0	1.40
A9401.5	–	1.50	0.0591	45.0	70.0	1.50
A9401/16	1/16	1.59	0.0625	44.0	76.0	1.59
A9401.6	–	1.60	0.0630	50.0	76.0	1.60
A9401.7	–	1.70	0.0669	50.0	76.0	1.70
A9401.8	–	1.80	0.0709	53.0	80.0	1.80
A9401.9	–	1.90	0.0748	53.0	80.0	1.90
A9405/64	5/64	1.98	0.0781	51.0	95.0	1.98
A9402.0	–	2.00	0.0787	56.0	85.0	2.00
A9402.1	–	2.10	0.0827	56.0	85.0	2.10
A9402.2	–	2.20	0.0866	59.0	90.0	2.20
A9402.3	–	2.30	0.0906	59.0	90.0	2.30
A9403/32	3/32	2.38	0.0938	57.0	108.0	2.38
A9402.4	–	2.40	0.0945	62.0	95.0	2.40
A9402.5	–	2.50	0.0984	62.0	95.0	2.50
A9402.6	–	2.60	0.1024	62.0	95.0	2.60
A9402.7	–	2.70	0.1063	66.0	100.0	2.70
A9407/64	7/64	2.78	0.1094	64.0	117.0	2.78
A9402.8	–	2.80	0.1102	66.0	100.0	2.80
A9402.9	–	2.90	0.1142	66.0	100.0	2.90

Product	DC (inch)	DC (mm)	DC (inch)	LCF (mm)	OAL (mm)	DCON MS (mm)
A9403.0	–	3.00	0.1181	66.0	100.0	3.00
A9403.1	–	3.10	0.1220	69.0	106.0	3.10
A9401/8	1/8	3.18	0.1250	70.0	130.0	3.18
A9403.2	–	3.20	0.1260	69.0	106.0	3.20
A9403.3	–	3.30	0.1299	69.0	106.0	3.30
A9403.4	–	3.40	0.1339	73.0	112.0	3.40
A9403.5	–	3.50	0.1378	73.0	112.0	3.50
A9409/64	9/64	3.57	0.1406	76.0	137.0	3.57
A9403.6	–	3.60	0.1417	73.0	112.0	3.60
A9403.7	–	3.70	0.1457	73.0	112.0	3.70
A9403.8	–	3.80	0.1496	78.0	119.0	3.80
A9403.9	–	3.90	0.1535	78.0	119.0	3.90
A9405/32	5/32	3.97	0.1563	76.0	137.0	3.97
A9404.0	–	4.00	0.1575	78.0	119.0	4.00
A9404.1	–	4.10	0.1614	78.0	119.0	4.10
A9404.2	–	4.20	0.1654	78.0	119.0	4.20
A9404.3	–	4.30	0.1693	82.0	126.0	4.30
A9404.4	–	4.40	0.1732	82.0	126.0	4.40
A9404.5	–	4.50	0.1772	82.0	126.0	4.50
A9404.6	–	4.60	0.1811	82.0	126.0	4.60
A9403/16	3/16	4.76	0.1875	86.0	146.0	4.76
A9404.8	–	4.80	0.1890	87.0	132.0	4.80
A9404.9	–	4.90	0.1929	87.0	132.0	4.90
A9405.0	–	5.00	0.1969	87.0	132.0	5.00
A9405.1	–	5.10	0.2008	87.0	132.0	5.10

Product	DC	DC	DC	LCF	OAL	DCON MS
	(inch)	(mm)	(inch)	(mm)	(mm)	(mm)
A9405.2	–	5.20	0.2047	87.0	132.0	5.20
A9405.3	–	5.30	0.2087	87.0	132.0	5.30
A9405.4	–	5.40	0.2126	91.0	139.0	5.40
A9405.5	–	5.50	0.2165	91.0	139.0	5.50
A9405.8	–	5.80	0.2283	91.0	139.0	5.80
A9405.9	–	5.90	0.2323	91.0	139.0	5.90
A9406.0	–	6.00	0.2362	91.0	139.0	6.00
A9406.1	–	6.10	0.2402	97.0	148.0	6.10
A9406.2	–	6.20	0.2441	97.0	148.0	6.20
A9401/4	1/4	6.35	0.2500	95.0	156.0	6.35
A9406.4	–	6.40	0.2520	97.0	148.0	6.40
A9406.5	–	6.50	0.2559	97.0	148.0	6.50
A9406.6	–	6.60	0.2598	97.0	148.0	6.60
A9406.7	–	6.70	0.2638	97.0	148.0	6.70
A94017/64	17/64	6.75	0.2656	98.0	159.0	6.75
A9406.8	–	6.80	0.2677	102.0	156.0	6.80
A9406.9	–	6.90	0.2717	102.0	156.0	6.90
A9407.0	–	7.00	0.2756	102.0	156.0	7.00
A9407.2	–	7.20	0.2835	102.0	156.0	7.20
A9407.3	–	7.30	0.2874	102.0	156.0	7.30
A9407.5	–	7.50	0.2953	102.0	156.0	7.50
A9407.8	–	7.80	0.3071	109.0	165.0	7.80
A9405/16	5/16	7.94	0.3125	102.0	162.0	7.94
A9408.0	–	8.00	0.3150	109.0	165.0	8.00
A9408.2	–	8.20	0.3228	109.0	165.0	8.20
A9408.3	–	8.30	0.3268	109.0	165.0	8.30
A9408.5	–	8.50	0.3346	109.0	165.0	8.50
A9408.6	–	8.60	0.3386	115.0	175.0	8.60
A9408.7	–	8.70	0.3425	115.0	175.0	8.70
A94011/32	11/32	8.73	0.3438	105.0	165.0	8.73

Product	DC	DC	DC	LCF	OAL	DCON MS
	(inch)	(mm)	(inch)	(mm)	(mm)	(mm)
A9409.0	–	9.00	0.3543	115.0	175.0	9.00
A9409.5	–	9.50	0.3740	115.0	175.0	9.50
A9409.8	–	9.80	0.3858	121.0	184.0	9.80
A94010.0	–	10.00	0.3937	121.0	184.0	10.00
A94010.2	–	10.20	0.4016	121.0	184.0	10.20
A94010.3	–	10.30	0.4055	121.0	184.0	10.30
A94013/32	13/32	10.32	0.4063	111.0	178.0	10.32
A94010.5	–	10.50	0.4134	121.0	184.0	10.50
A94027/64	27/64	10.72	0.4219	117.0	184.0	10.72
A94011.0	–	11.00	0.4331	128.0	195.0	11.00
A9407/16	7/16	11.11	0.4375	117.0	184.0	11.11
A94011.5	–	11.50	0.4528	128.0	195.0	11.50
A94029/64	29/64	11.51	0.4531	121.0	190.0	11.51
A94011.8	–	11.80	0.4646	128.0	195.0	11.80
A94012.0	–	12.00	0.4724	134.0	205.0	12.00
A94012.2	–	12.20	0.4803	134.0	205.0	12.20
A94031/64	31/64	12.30	0.4844	121.0	197.0	12.30
A94012.5	–	12.50	0.4921	134.0	205.0	12.50
A94013.0	–	13.00	0.5118	134.0	205.0	13.00
A94017/32	17/32	13.49	0.5313	121.0	203.0	13.49
A94014.0	–	14.00	0.5512	140.0	214.0	14.00
A9409/16	9/16	14.29	0.5625	124.0	210.0	14.29
A94014.5	–	14.50	0.5709	144.0	220.0	14.50
A94015.0	–	15.00	0.5906	144.0	220.0	15.00
A94015.5	–	15.50	0.6102	149.0	227.0	15.50
A94016.0	–	16.00	0.6299	149.0	227.0	16.00
A94021/32	21/32	16.67	0.6563	130.0	229.0	16.67
A94017.0	–	17.00	0.6693	154.0	235.0	17.00
A94011/16	11/16	17.46	0.6875	137.0	235.0	17.46
A94019.0	–	19.00	0.7480	162.0	247.0	19.00

A976

DORMER



PFX-borr av HSS-E (5% Kobolt), extralång (DIN 1869 serie 1), blank

För borrning av mycket djupa hål och i applikationer där längre räckvidd krävs. Spåren har en speciell parabolisk design som ger effektiv spåntransport och gör urspänning överflödigt. Spetsvinkel 130°. Användbart i de flesta material.

PFX

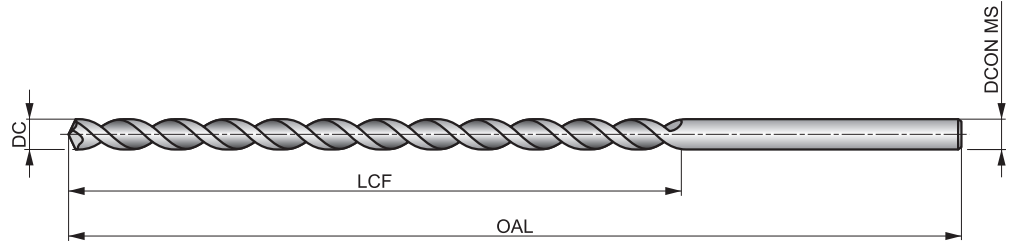

HSS-E	DIN 1869-1	15×D
130°	Bright	
λ>35°	R	DC h8

Arbetsmaterialgrupper och startvärden för skärhastighet (m/min) och matningskod. Tabeller med matningar finns med början på sidan 274

P1.1 ▣29 C	P1.2 ▣33 C	P1.3 ▣34 C	P2.1 ▣25 C	P2.2 ▣22 C	P2.3 ▣19 A	P3.1 ▣18 C	P3.2 ▣14 C	P3.3 ▣12 A	P4.1 ▣11 C	P4.2 ▣9 A	P4.3 ▣7 A	M1.1 ▣16 B	M1.2 ▣14 B
M2.1 ▣15 B	M2.2 ▣12 B	M3.1 ▣8 C	M3.2 ▣7 C	M3.3 ▣6 C	M4.1 ▣8 A	K2.1 ▣20 C	K2.2 ▣16 C	K2.3 ▣13 A	K3.1 ▣17 C	K3.2 ▣13 C	K3.3 ▣11 A	K4.1 ▣16 C	K4.2 ▣12 C
K4.3 ▣19 A	K4.4 ▣8 A	K4.5 ▣6 A	K5.1 ▣18 C	K5.2 ▣14 C	K5.3 ▣11 A	N3.1 ▣30 D	S1.1 ▣15 C	S1.2 ▣11 A	S1.3 ▣5 A				

Product	DC (inch)	DC (mm)	DC (inch)	LCF (mm)	OAL (mm)	DCON MS (mm)
A9761.5	–	1.50	0.0591	75.0	115.0	1.50
A9762.0X125	–	2.00	0.0787	85.0	125.0	2.00
A9762.1X125	–	2.10	0.0827	85.0	125.0	2.10
A9762.2X135	–	2.20	0.0866	90.0	135.0	2.20
A9762.3X135	–	2.30	0.0906	90.0	135.0	2.30
A9762.4X140	–	2.40	0.0945	95.0	140.0	2.40
A9762.5X140	–	2.50	0.0984	95.0	140.0	2.50
A9762.6X140	–	2.60	0.1024	95.0	140.0	2.60
A9762.7X150	–	2.70	0.1063	100.0	150.0	2.70
A9762.8X150	–	2.80	0.1102	100.0	150.0	2.80
A9762.9X150	–	2.90	0.1142	100.0	150.0	2.90
A9763.0X150	–	3.00	0.1181	100.0	150.0	3.00
A9763.1X155	–	3.10	0.1220	105.0	155.0	3.10
A9761/8	1/8	3.18	0.1250	105.0	155.0	3.18
A9763.2X155	–	3.20	0.1260	105.0	155.0	3.20
A9763.3X155	–	3.30	0.1299	105.0	155.0	3.30
A9763.4X165	–	3.40	0.1339	115.0	165.0	3.40
A9763.5X165	–	3.50	0.1378	115.0	165.0	3.50
A9763.6X165	–	3.60	0.1417	115.0	165.0	3.60
A9763.7X165	–	3.70	0.1457	115.0	165.0	3.70
A9763.8X175	–	3.80	0.1496	120.0	175.0	3.80
A9763.9X175	–	3.90	0.1535	120.0	175.0	3.90
A9765/32	5/32	3.97	0.1563	120.0	175.0	3.97
A9764.0X175	–	4.00	0.1575	120.0	175.0	4.00
A9764.1X175	–	4.10	0.1614	120.0	175.0	4.10
A9764.2X175	–	4.20	0.1654	120.0	175.0	4.20
A9764.3X185	–	4.30	0.1693	125.0	185.0	4.30
A9764.5X185	–	4.50	0.1772	125.0	185.0	4.50
A9764.6X185	–	4.60	0.1811	125.0	185.0	4.60
A9764.7X185	–	4.70	0.1850	125.0	185.0	4.70
A9763/16	3/16	4.76	0.1875	135.0	195.0	4.76
A9764.8X195	–	4.80	0.1890	135.0	195.0	4.80
A9765.0X195	–	5.00	0.1969	135.0	195.0	5.00

Product	DC (inch)	DC (mm)	DC (inch)	LCF (mm)	OAL (mm)	DCON MS (mm)
A9765.1X195	–	5.10	0.2008	135.0	195.0	5.10
A9765.2X195	–	5.20	0.2047	135.0	195.0	5.20
A9765.3X195	–	5.30	0.2087	135.0	195.0	5.30
A9765.5X205	–	5.50	0.2165	140.0	205.0	5.50
A9765.7X205	–	5.70	0.2244	140.0	205.0	5.70
A9765.8X205	–	5.80	0.2283	140.0	205.0	5.80
A9765.9X205	–	5.90	0.2323	140.0	205.0	5.90
A9766.0X205	–	6.00	0.2362	140.0	205.0	6.00
A9766.1X215	–	6.10	0.2402	150.0	215.0	6.10
A9766.2X215	–	6.20	0.2441	150.0	215.0	6.20
A9761/4	1/4	6.35	0.2500	150.0	215.0	6.35
A9766.4X215	–	6.40	0.2520	150.0	215.0	6.40
A9766.5X215	–	6.50	0.2559	150.0	215.0	6.50
A9766.7X215	–	6.70	0.2638	150.0	215.0	6.70
A9766.8X225	–	6.80	0.2677	155.0	225.0	6.80
A9767.0X225	–	7.00	0.2756	155.0	225.0	7.00
A9767.5X225	–	7.50	0.2953	155.0	225.0	7.50
A9765/16	5/16	7.94	0.3125	165.0	240.0	7.94
A9768.0X240	–	8.00	0.3150	165.0	240.0	8.00
A9768.5X240	–	8.50	0.3346	165.0	240.0	8.50
A97611/32	11/32	8.73	0.3438	175.0	250.0	8.73
A9769.0X250	–	9.00	0.3543	175.0	250.0	9.00
A9769.5X250	–	9.50	0.3740	175.0	250.0	9.50
A9763/8	3/8	9.52	0.3750	185.0	265.0	9.52
A97610.0X265	–	10.00	0.3937	185.0	265.0	10.00
A97610.5	–	10.50	0.4134	185.0	265.0	10.50
A97611.0	–	11.00	0.4331	195.0	280.0	11.00
A9767/16	7/16	11.11	0.4375	195.0	280.0	11.11
A97611.5	–	11.50	0.4528	195.0	280.0	11.50
A97612.0	–	12.00	0.4724	205.0	295.0	12.00
A97612.5	–	12.50	0.4921	205.0	295.0	12.50
A97613.0	–	13.00	0.5118	205.0	295.0	13.00
A97614.0 ¹⁾	–	14.00	0.5512	215.0	310.0	14.00

A977



PFX-borr av HSS-E (5% Kobolt), extralång (DIN 1869 serie 2), blank

För borrning av mycket djupa hål och i applikationer där längre räckvidd krävs. Spåren har en speciell parabolisk design som ger effektiv spåntransport och gör urspänning överflödigt. Spetsvinkel 130°. Användbart i de flesta material.

PFX

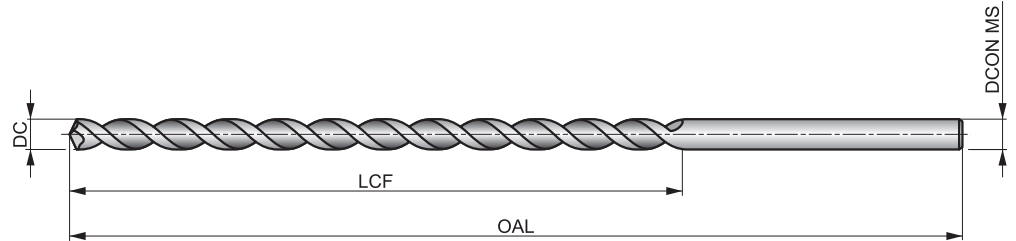

HSS-E	DIN 1869-2	20xD
130°	Bright	
λ>35°	R	DC h8

Arbetsmaterialgrupper och startvärden för skärhastighet (m/min) och matningskod. Tabeller med matningar finns med början på sidan 274

P1.1 □29 B	P1.2 □33 B	P1.3 □34 B	P2.1 □25 B	P2.2 ■22 B	P2.3 ■19 A	P3.1 ■18 B	P3.2 ■14 B	P3.3 ■12 A	P4.1 ■11 B	P4.2 ■9 A	P4.3 ■7 A	M1.1 □16 B	M1.2 □14 B
M2.1 □15 B	M2.2 □12 B	M3.1 □8 B	M3.2 □7 B	M3.3 □6 B	M4.1 □8 A	K2.1 □20 B	K2.2 □16 B	K2.3 □13 A	K3.1 □17 B	K3.2 □13 B	K3.3 □11 A	K4.1 □16 B	K4.2 □12 B
K4.3 □9 A	K4.4 □8 A	K4.5 □6 A	K5.1 □18 B	K5.2 □14 B	K5.3 □11 A	N3.1 □30 C	S1.1 □15 B	S1.2 □11 A	S1.3 □5 A				

Product	DC (inch)	DC (mm)	DC (inch)	LCF (mm)	OAL (mm)	DCON MS (mm)
A9771.5 ¹⁾	–	1.50	0.0591	100.0	150.0	1.50
A9771/16 ¹⁾	1/16	1.59	0.0625	100.0	150.0	1.59
A9772.0 ¹⁾	–	2.00	0.0787	110.0	160.0	2.00
A9773/32 ¹⁾	3/32	2.38	0.0938	115.0	170.0	2.38
A9773.0X190	–	3.00	0.1181	130.0	190.0	3.00
A9771/8	1/8	3.18	0.1250	135.0	200.0	3.18
A9773.5X210	–	3.50	0.1378	145.0	210.0	3.50
A9774.0X220	–	4.00	0.1575	150.0	220.0	4.00
A9774.5X235	–	4.50	0.1772	160.0	235.0	4.50
A9773/16	3/16	4.76	0.1875	170.0	245.0	4.76
A9775.0X245	–	5.00	0.1969	170.0	245.0	5.00
A9775.5X260	–	5.50	0.2165	180.0	260.0	5.50
A9776.0X260	–	6.00	0.2362	180.0	260.0	6.00
A9771/4	1/4	6.35	0.2500	190.0	275.0	6.35

Product	DC (inch)	DC (mm)	DC (inch)	LCF (mm)	OAL (mm)	DCON MS (mm)
A9776.5X275	–	6.50	0.2559	190.0	275.0	6.50
A9777.0X290	–	7.00	0.2756	200.0	290.0	7.00
A9778.0X305	–	8.00	0.3150	210.0	305.0	8.00
A9778.5X305	–	8.50	0.3346	210.0	305.0	8.50
A9779.0X320	–	9.00	0.3543	220.0	320.0	9.00
A9779.5X320	–	9.50	0.3740	220.0	320.0	9.50
A97710.0X340	–	10.00	0.3937	235.0	340.0	10.00
A97710.5	–	10.50	0.4134	235.0	340.0	10.50
A97711.0	–	11.00	0.4331	250.0	365.0	11.00
A97711.5	–	11.50	0.4528	250.0	365.0	11.50
A97712.0	–	12.00	0.4724	260.0	375.0	12.00
A97712.5	–	12.50	0.4921	260.0	375.0	12.50
A97713.0	–	13.00	0.5118	260.0	375.0	13.00
A97714.0 ¹⁾	–	14.00	0.5512	270.0	390.0	14.00

¹⁾ Dormer-standard.

A978



PFX-borr av HSS-E (5% Kobolt), extralång (DIN 1869 serie 3), blank

För borrning av mycket djupa hål och i applikationer där längre räckvidd krävs. Spåren har en speciell parabolisk design som ger effektiv spåntransport och gör urspänning överflödig. Spetsvinkel 130°. Användbart i de flesta material.

PFX

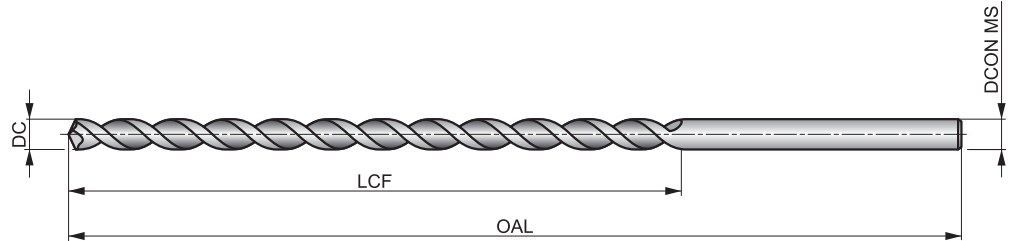

HSS-E	DIN 1869-3	25xD
130°	Bright	
λ>35°	R	DC h8

Arbetsmaterialgrupper och startvärden för skärhastighet (m/min) och matningskod. Tabeller med matningar finns med början på sidan 274

P1.1 ▣29 A	P1.2 ▣33 A	P1.3 ▣34 A	P2.1 ▣25 A	P2.2 ▣22 A	P2.3 ▣19 A	P3.1 ▣18 A	P3.2 ▣14 A	P3.3 ▣12 A	P4.1 ▣11 A	P4.2 ▣9 A	P4.3 ▣7 A	M1.1 ▣16 A	M1.2 ▣14 A
M2.1 ▣15 A	M2.2 ▣12 A	M3.1 ▣8 A	M3.2 ▣7 A	M3.3 ▣6 A	M4.1 ▣8 A	K2.1 ▣20 A	K2.2 ▣16 A	K2.3 ▣13 A	K3.1 ▣17 A	K3.2 ▣13 A	K3.3 ▣11 A	K4.1 ▣16 A	K4.2 ▣12 A
K4.3 ▣9 A	K4.4 ▣8 A	K4.5 ▣6 A	K5.1 ▣18 A	K5.2 ▣14 A	K5.3 ▣11 A	N3.1 ▣30 B	S1.1 ▣15 A	S1.2 ▣11 A	S1.3 ▣5 A				

Product	DC	DC	DC	LCF	OAL	DCON MS
	(inch)	(mm)	(inch)			
A9783.0 ¹⁾	–	3.00	0.1181	160.0	240.0	3.00
A9783.5X265	–	3.50	0.1378	180.0	265.0	3.50
A9784.0X280	–	4.00	0.1575	190.0	280.0	4.00
A9784.5X295	–	4.50	0.1772	200.0	295.0	4.50
A9785.0X315	–	5.00	0.1969	210.0	315.0	5.00
A9786.0X330	–	6.00	0.2362	225.0	330.0	6.00
A9781/4	1/4	6.35	0.2500	235.0	350.0	6.35
A9786.5X350	–	6.50	0.2559	235.0	350.0	6.50
A9787.0X370	–	7.00	0.2756	250.0	370.0	7.00
A9788.0X390	–	8.00	0.3150	265.0	390.0	8.00
A9788.5X390	–	8.50	0.3346	265.0	390.0	8.50
A9789.0X410	–	9.00	0.3543	280.0	410.0	9.00
A9789.5X410	–	9.50	0.3740	280.0	410.0	9.50
A97810.0X430	–	10.00	0.3937	295.0	430.0	10.00

¹⁾ Dormer-standard.

A952

DORMER



PFX-borr av HSS, extra lång serie, koniskt skaft (DIN 1870 Serie 2), blank

Ett mångsidigt borr med speciell parabolisk spårdesign för borrhning av djupa hål i en passering utan urspänning. Borret har en självcenterande 130° spets. Användbart i de flesta material.

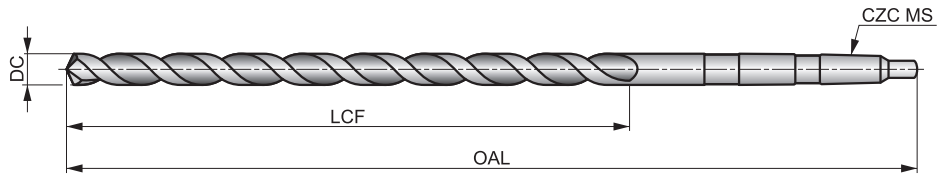

HSS	DIN 1870(2)	20xD
130°	Bright ST	
$\lambda > 35^\circ$	R	DC h8

Arbetsmaterialgrupper och startvärden för skärhastighet (m/min) och matningskod. Tabeller med matningar finns med början på sidan 274

P1.1 ■ 25 G	P1.2 ■ 28 G	P1.3 ■ 29 G	P2.1 ■ 22 G	P2.2 ■ 19 E	P2.3 ■ 17 C	P3.1 ■ 12 D	P3.2 ■ 9 D	P3.3 ■ 8 C	P4.1 ■ 7 D	P4.2 ■ 6 C	P4.3 ■ 5 B	M1.1 ■ 16 C	M1.2 ■ 14 C
M2.1 ■ 15 C	M2.2 ■ 12 C	M3.1 ■ 17 E	M3.2 ■ 16 E	M3.3 ■ 15 E	M4.1 ■ 12 A	K1.1 ■ 22 G	K1.2 ■ 16 D	K1.3 ■ 12 D	K2.1 ■ 16 C	K2.2 ■ 13 C	K2.3 ■ 10 C	K3.1 ■ 14 C	K3.2 ■ 11 C
K3.3 ■ 9 C	K4.1 ■ 13 C	K4.2 ■ 10 C	K4.3 ■ 7 C	K4.4 ■ 6 C	K4.5 ■ 5 C	K5.1 ■ 15 C	K5.2 ■ 11 C	K5.3 ■ 9 C	N1.1 ■ 30 H	N1.2 ■ 23 H	N1.3 ■ 15 G	N2.1 ■ 37 F	N2.2 ■ 33 F
N2.3 ■ 24 F	N3.1 ■ 56 F	N3.2 ■ 33 G	N3.3 ■ 17 D	N4.1 ■ 30 J	N4.2 ■ 30 H	N4.3 ■ 10 F	S1.1 ■ 18 D	S1.2 ■ 10 B	S1.3 ■ 6 A	S2.1 ■ 7 C	S2.2 ■ 4 A	S3.1 ■ 5 C	S3.2 ■ 3 A
S4.1 ■ 4 C	S4.2 ■ 2 A												

DC >= 14,5mm mindre än 20xD; DC > 23mm Blank.

Product	DC (mm)	DC (inch)	LCF (mm)	OAL (mm)	CZC MS
A9528.0	8.00	0.3150	210.0	330.0	MK 1
A9529.0	9.00	0.3543	220.0	345.0	MK 1
A95210.0	10.00	0.3937	235.0	360.0	MK 1
A95211.0	11.00	0.4331	250.0	375.0	MK 1
A95213.0	13.00	0.5118	260.0	395.0	MK 1
A95214.0	14.00	0.5512	275.0	410.0	MK 1
A95215.0	15.00	0.5906	275.0	425.0	MK 2
A95216.0	16.00	0.6299	295.0	445.0	MK 2
A95217.0	17.00	0.6693	295.0	445.0	MK 2
A95219.0	19.00	0.7480	310.0	465.0	MK 2

Product	DC (mm)	DC (inch)	LCF (mm)	OAL (mm)	CZC MS
A95220.0	20.00	0.7874	325.0	490.0	MK 2
A95221.0	21.00	0.8268	325.0	490.0	MK 2
A95223.0	23.00	0.9055	345.0	515.0	MK 2
A95224.0	24.00	0.9449	365.0	555.0	MK 3
A95225.0	25.00	0.9843	365.0	555.0	MK 3
A95226.0	26.00	1.0236	365.0	555.0	MK 3
A95227.0	27.00	1.0630	385.0	580.0	MK 3
A95228.0	28.00	1.1024	385.0	580.0	MK 3
A95229.0	29.00	1.1417	385.0	580.0	MK 3
A95230.0	30.00	1.1811	385.0	580.0	MK 3

Verktygsmaterial (BMC)	HSS	HSS	HSS	HSS	HSS	HSS	HSS	HSS	HSS	HSS	HSS	HSS
Standard (BSG)	DORMER	DIN 373	ANSI	ANSI	ANSI	ANSI	ANSI	DIN 8374	DIN 8376	DORMER	DORMER	
Användbar längd (ULDR)								4×D	4×D	2.5×D	2.5×D	
Spetsvinkel	20°	180°						90°	180°	180°	90°	
Beläggning	Bright	Bright	Bright	Bright	Bright	Bright	Bright	ST	ST	ST	ST	
Skaft												
Spiralform								λ 20-35°	λ 20-35°			
Skärriktning	R	R	R	R		R	R	R	R	R	R	
Produktfamilj	G314	G125	G702	G703	G704	G705	G706	A400	A402	A413	A412	
PSF skärdiametrar	4.00 - 9.00	6.50 - 20.00	1/4 - 2"	1/2 - 2.1/8	1/8 - 1.1/2	1/4 - 15/16	1/4 - 1"	M3 - M8	M3 - M10	M3 - M10	M3 - M10	
	136	137	138	139	140	141	142	143	144	145	146	
P	P1	■	■	■	■	■	■	■	■	■	■	
	P2	■	■	■	■	■	■	■	■	■	■	
	P3	■	■	■	■	■	■	■	■	■	■	
	P4	■	■	■	■	■	■	■	■	■	■	
M	M1	■	■	■	■	■	■	■	■	■	■	
	M2	■	■	■	■	■	■	■	■	■	■	
	M3							■	■	■	■	
	M4							■	■	■	■	
K	K1	■	■	■	■	■	■	■	■	■	■	
	K2		■	■	■	■	■	■	■	■	■	
	K3		■	■	■	■	■	■	■	■	■	
	K4		■	■	■	■	■	■	■	■	■	
	K5		■	■	■	■	■	■	■	■	■	
N	N1	■	■	■	■	■	■	■	■	■	■	
	N2	■	■	■	■	■	■	■	■	■	■	
	N3	■	■	■	■	■	■	■	■	■	■	
	N4	■	■	■	■	■	■	■	■	■	■	
	N5		■	■	■	■	■	■	■	■	■	
S	S1							■	■	■	■	
	S2							■	■	■	■	
	S3							■	■	■	■	
	S4							■	■	■	■	
H	H1											
	H2											
	H3											
	H4											

G314



Koniskt plåtblåborr med olika diametrar, blank

Mångsidigt tunnplåtblåborr i ett flertal varianter med olika diametrar för stegvis uppborring till lämplig diameter. Cylindriskt skaft som kan spännas i standardchuck.

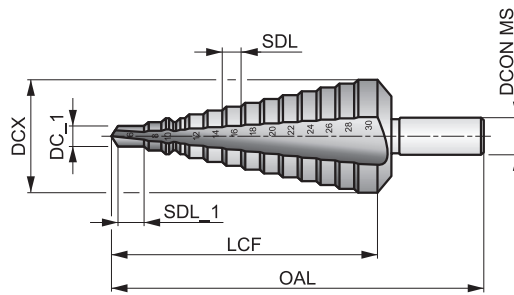

HSS	Bright	DORMER
R	20°	

Arbetsmaterialgrupper och startvärden för skärhastighet (m/min) och matningskod. Tabeller med matningar finns med början på sidan 274

P1.1 ■ 20	P1.2 ■ 22	P1.3 ■ 23	P2.1 ■ 17	P2.2 ■ 15	P2.3 ■ 13	P3.1 ■ 12	P3.2 ■ 9	M1.1 ■ 8	M1.2 ■ 6	M2.1 ■ 7	K1.1 ■ 17	N1.1 ■ 30	N1.2 ■ 23
N1.3 ■ 15	N2.1 ■ 31	N2.2 ■ 28	N3.1 ■ 34	N3.2 ■ 20	N3.3 ■ 10	N4.1 ■ 30	N4.2 ■ 20						

SDI = Diametersteg.

Product	Nr.	DC_1 (mm)	DCX (mm)	SDL (mm)	SDI (mm)	SDL_1 (mm)	LCF (mm)	OAL (mm)	DCON MS (mm)
G314412	412	4.00	12.00	5.00	4 - 5 - 6 - 7 - 8 - 9 - 10 - 11 - 12	5.00	61.0	80.0	6.00
G3141220	1220	12.00	20.00	4.00	12 - 13 - 14 - 15 - 16 - 17 - 18 - 19 - 20	4.00	55.0	76.0	9.00
G3142030	2030	20.00	30.00	4.00	20 - 21 - 22 - 23 - 24 - 25 - 26 - 27 - 28 - 29 - 30	4.00	67.0	88.0	12.00
G3143040	3040	30.00	40.00	4.00	30 - 31 - 32 - 33 - 34 - 35 - 36 - 37 - 38 - 39 - 40	4.00	74.0	98.0	13.00
G314420	420	4.00	20.00	4.00	4 - 6 - 8 - 10 - 12 - 14 - 16 - 18 - 20	4.00	48.0	76.0	8.00
G314630	630	6.00	30.00	4.00	6 - 8 - 10 - 12 - 14 - 16 - 18 - 20 - 22 - 24 - 26 - 28 - 30	4.00	73.0	98.0	10.00
G314M	M	9.00	36.00	3.00	9 - 12 - 15 - 18 - 21 - 24 - 27 - 30 - 33 - 36	3.00	57.0	86.0	12.00

G125

DORMER



Tappförsänkare av HSS, 180° försänkning, cyl. skaft, blank

Tappförsänkare för 180° försänkning för standardskruvskallar. Fast styrtapp i olika diametrar för förborrade pilothål. Användbar i många olika materialsorter.

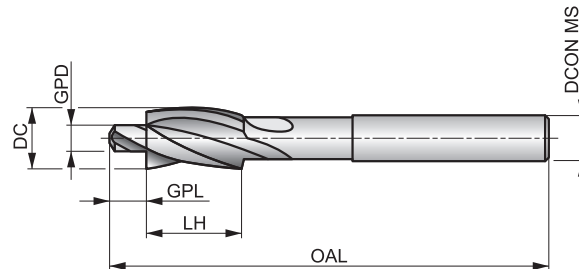

HSS	Bright	DIN 373
R	180°	

Arbetsmaterialgrupper och startvärden för skärhastighet (m/min) och matningskod. Tabeller med matningar finns med början på sidan 274

P1.1 ■ 20 E	P1.2 ■ 22 E	P1.3 ■ 23 E	P2.1 ■ 17 E	P2.2 ■ 15 D	P2.3 ▧ 13 C	P3.1 ■ 12 D	P3.2 ▧ 9 D	P3.3 ▧ 8 C	P4.1 ▧ 7 D	P4.2 ▧ 6 C	M1.1 ▧ 8 D	M1.2 ▧ 6 D	M2.1 ▧ 7 D
M2.2 ▧ 6 D	M2.3 ▧ 5 C	K1.1 ■ 17 E	K1.2 ▧ 12 E	K1.3 ▧ 11 E	K2.1 ■ 15 D	K2.2 ▧ 12 D	K2.3 ▧ 10 C	K3.1 ▧ 13 D	K3.2 ▧ 10 D	K4.1 ▧ 12 D	K4.2 ▧ 9 D	K5.1 ■ 14 D	K5.2 ▧ 10 D
N1.1 ▧ 30 G	N1.2 ■ 23 G	N1.3 ■ 15 G	N2.1 ▧ 31 G	N2.2 ▧ 28 G	N2.3 ▧ 20 G	N3.1 ■ 34 C	N3.2 ■ 20 C	N3.3 ▧ 10 C	N4.1 ■ 30 C	N4.2 ▧ 20 C			

DCON MS tolerans h9.

Product	DC (mm)	GPD (mm)	CZC MS	GPL (mm)	OAL (mm)	LH (mm)	DCON MS (mm)	NOF
G1256.5X3.2 ¹⁾	6.50	3.20	M 3 f	4.50	71.0	14.0	5.00	3
G1256.5X3.4 ²⁾	6.50	3.40	M 3 m	4.50	71.0	14.0	5.00	3
G1258.0X3.3 ³⁾	8.00	3.30	M 4 t	5.00	71.0	14.0	5.00	3
G1258.0X4.3 ¹⁾	8.00	4.30	M 4 f	5.00	71.0	14.0	5.00	3
G1258.0X4.5 ²⁾	8.00	4.50	M 4 m	5.00	71.0	14.0	5.00	3
G12510.0X4.2 ³⁾	10.00	4.20	M 5 t	5.50	80.0	18.0	8.00	3
G12510.0X5.3 ¹⁾	10.00	5.30	M 5 f	5.50	80.0	18.0	8.00	3
G12510.0X5.5 ²⁾	10.00	5.50	M 5 m	5.50	80.0	18.0	8.00	3
G12511.0X5.0 ³⁾	11.00	5.00	M 6 t	6.00	80.0	18.0	8.00	3
G12511.0X6.4 ¹⁾	11.00	6.40	M 6 f	6.00	80.0	18.0	8.00	3
G12511.0X6.6 ²⁾	11.00	6.60	M 6 m	6.00	80.0	18.0	8.00	3
G12515.0X6.8 ³⁾	15.00	6.80	M 8 t	8.00	100.0	22.0	12.50	3
G12515.0X8.4 ¹⁾	15.00	8.40	M 8 f	8.00	100.0	22.0	12.50	3
G12515.0X9.0 ²⁾	15.00	9.00	M 8 m	8.00	100.0	22.0	12.50	3
G12518.0X8.5 ³⁾	18.00	8.50	M 10 t	10.00	100.0	22.0	12.50	3
G12518.0X10.5 ¹⁾	18.00	10.50	M 10 f	10.00	100.0	22.0	12.50	3
G12518.0X11.0 ²⁾	18.00	11.00	M 10 m	10.00	100.0	22.0	12.50	3
G12520.0X10.2 ³⁾	20.00	10.20	M 12 t	10.00	100.0	22.0	12.50	3
G12520.0X13.0 ¹⁾	20.00	13.00	M 12 f	10.00	100.0	22.0	12.50	3
G12520.0X13.5 ²⁾	20.00	13.50	M 12 m	10.00	100.0	22.0	12.50	3

¹⁾ f= för genomgående hål, fin passning.

²⁾ m= för genomgående hål, medelfin passning.

³⁾ t= tapp för hål.

G702

DORMER



HSS-försänkt kropp med reducerat skaft, utbytbar pilottyp

Försänkarkropp med cylindriskt skaft som används tillsammans med avtagbara styrcinnar för att förstora toppen av ett förborrat hål genom att använda en planförsänkare. En avtagbar styrcinne G704, som inte skär, är monterad i kroppen och följer det befintliga hålet för att styra och centrera försänkningen.

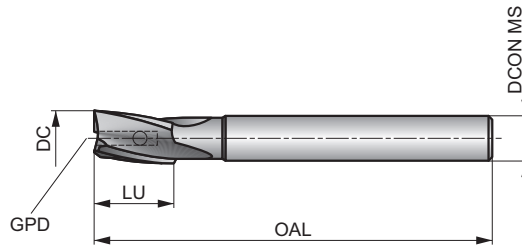

HSS	Bright	ANSI
R		

Arbetsmaterialgrupper och startvärden för skärhastighet (m/min) och matningskod. Tabeller med matningar finns med början på sidan 274

P1.1 ■ 20 E	P1.2 ■ 22 E	P1.3 ■ 23 E	P2.1 ■ 17 E	P2.2 ■ 15 D	P2.3 ■ 13 C	P3.1 ■ 12 D	P3.2 ■ 9 D	P3.3 ■ 8 C	P4.1 ■ 7 D	P4.2 ■ 6 C	P4.3 ■	M1.1 ■ 8 D	M1.2 ■ 6 D
M2.1 ■ 7 D	M2.2 ■ 6 D	M2.3 ■ 5 C	K1.1 ■ 17 E	K1.2 ■ 12 E	K1.3 ■ 11 E	K2.1 ■ 15 D	K2.2 ■ 12 D	K2.3 ■ 10 C	K3.1 ■ 13 D	K3.2 ■ 10 D	K4.1 ■ 12 D	K4.2 ■ 9 D	K5.1 ■ 14 D
K5.2 ■ 10 D	N1.1 ■ 30 G	N1.2 ■ 23 G	N1.3 ■ 15 G	N2.1 ■ 31 G	N2.2 ■ 28 G	N2.3 ■ 20 G	N3.1 ■ 34 C	N3.2 ■ 20 C	N3.3 ■ 10 C	N4.1 ■ 30 C	N4.2 ■ 20 C		

Product	DC	DC	LU	OAL	DCON MS	NOF	GPD	GPDN	GPDX
	(inch)	(inch)	(inch)	(inch)	(inch)		(inch)	(inch)	(inch)
G7021/4	1/4	0.2500	3/4	3.13/16	15/64	3	3/32	1/8	3/16
G7029/32	9/32	0.2813	3/4	3.13/16	17/64	3	3/32	1/8	7/32
G7025/16	5/16	0.3125	3/4	3.13/16	19/64	3	3/32	1/8	1/4
G70211/32	11/32	0.3438	3/4	3.13/16	5/16	3	3/32	1/8	9/32
G7023/8	3/8	0.3750	1"	4.1/16	5/16	3	5/32	3/16	5/16
G70213/32	13/32	0.4063	1"	4.1/16	3/8	3	5/32	3/16	11/32
G7027/16	7/16	0.4375	1"	4.1/16	3/8	3	5/32	3/16	3/8
G70215/32	15/32	0.4688	1.1/4	4.5/16	7/16	3	3/16	3/16	13/32
G7021/2	1/2	0.5000	1.1/4	4.5/16	7/16	3	3/16	3/16	7/16
G7029/16	9/16	0.5625	1.1/4	4.5/16	1/2	3	3/16	3/16	1/2
G70219/32	19/32	0.5938	1.1/4	5.1/8	1/2	3	3/16	3/16	17/32
G7025/8	5/8	0.6250	1.1/4	5.1/8	1/2	3	3/16	3/16	9/16
G70211/16	11/16	0.6875	1.1/4	5.1/8	1/2	3	3/16	3/16	5/8
G7023/4	3/4	0.7500	1.1/2	5.3/8	1/2	3	1/4	5/16	11/16
G70225/32	25/32	0.7813	1.1/2	5.3/8	5/8	3	1/4	5/16	23/32
G70213/16	13/16	0.8125	1.1/2	5.3/8	5/8	3	1/4	5/16	3/4
G70227/32	27/32	0.8438	1.1/2	5.3/8	3/4	3	1/4	5/16	25/32
G7027/8	7/8	0.8750	1.1/2	5.3/8	3/4	3	1/4	5/16	13/16
G7021	1"	1.0000	1.3/4	6.3/8	3/4	3	5/16	3/8	15/16
G7022	2"	2.0000	2.1/2	8.3/8	1.1/2	5	1/2	9/16	1.15/16

G703



HSS-försänkt kropp med koniskt skaft, utbytbar pilottyp

Försänkarkropp med Morsekona-skaft som används tillsammans med avtagbara styrcinnor för att förstora toppen av ett förborrat hål genom att använda en planförsänkare. En avtagbar styrcinne G704, som inte skär, är monterad i kroppen och följer det befintliga hålet för att styra och centrera försänkningen.

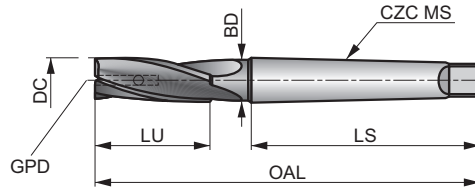

HSS	Bright	ANSI
R		

Arbetsmaterialgrupper och startvärden för skärhastighet (m/min) och matningskod. Tabeller med matningar finns med början på sidan 274

P1.1 ■ 20 E	P1.2 ■ 22 E	P1.3 ■ 23 E	P2.1 ■ 17 E	P2.2 ■ 15 D	P2.3 ■ 13 C	P3.1 ■ 12 D	P3.2 ■ 9 D	P3.3 ■ 8 C	P4.1 ■ 7 D	P4.2 ■ 6 C	P4.3 ■	M1.1 ■ 8 D	M1.2 ■ 6 D
M2.1 ■ 7 D	M2.2 ■ 6 D	M2.3 ■ 5 C	K1.1 ■ 17 E	K1.2 ■ 12 E	K1.3 ■ 11 E	K2.1 ■ 15 D	K2.2 ■ 12 D	K2.3 ■ 10 C	K3.1 ■ 13 D	K3.2 ■ 10 D	K4.1 ■ 12 D	K4.2 ■ 9 D	K5.1 ■ 14 D
K5.2 ■ 10 D	N1.1 ■ 30 G	N1.2 ■ 23 G	N1.3 ■ 15 G	N2.1 ■ 31 G	N2.2 ■ 28 G	N2.3 ■ 20 G	N3.1 ■ 34 C	N3.2 ■ 20 C	N3.3 ■ 10 C	N4.1 ■ 30 C	N4.2 ■ 20 C		

Product	DC (inch)	DC (inch)	LU (inch)	OAL (inch)	CZC MS	BD (inch)	LS (inch)	NOF	GPD (inch)	GPDN (inch)	GPDX (inch)
G7031/2	1/2	0.5000	1.1/4	4.5/16	1	29/64	2.9/16	3	3/16	1/4	7/16
G70311/16	11/16	0.6875	1.1/4	5.1/8	2	5/8	3.1/8	3	3/16	1/4	5/8
G7033/4	3/4	0.7500	1.1/2	5.3/8	2	21/32	3.1/8	3	1/4	5/16	11/16
G70313/16	13/16	0.8125	1.1/2	5.3/8	2	21/32	3.1/8	3	1/4	5/16	3/4
G7037/8	7/8	0.8750	1.1/2	5.3/8	2	21/32	3.1/8	3	1/4	5/16	13/16
G70315/16	15/16	0.9375	1.1/2	6.1/8	3	7/8	3.7/8	3	1/4	5/16	7/8
G7031	1"	1.0000	1.3/4	6.3/8	3	7/8	3.7/8	3	5/16	3/8	15/16
G7031.1/16	1.1/16	1.0625	1.3/4	6.3/8	3	7/8	3.7/8	3	5/16	3/8	1"
G7031.1/8	1.1/8	1.1250	1.3/4	6.3/8	3	7/8	3.7/8	3	5/16	3/8	1.1/16
G7031.3/16	1.3/16	1.1875	1.3/4	6.3/8	3	7/8	3.7/8	3	5/16	3/8	1.1/8
G7031.1/4	1.1/4	1.2500	2"	6.5/8	3	7/8	3.7/8	5	3/8	7/16	1.3/16
G7031.3/8	1.3/8	1.3750	2"	6.5/8	3	7/8	3.7/8	5	3/8	7/16	1.5/16
G7031.1/2	1.1/2	1.5000	2"	7.7/8	4	1.3/16	4.7/8	5	3/8	7/16	1.7/16
G7031.5/8	1.5/8	1.6250	2.1/4	8.1/8	4	1.3/8	4.7/8	5	7/16	1/2	1.9/16
G7032	2"	2.0000	2.1/2	8.3/8	4	1.1/2	4.7/8	5	1/2	9/16	1.5/16
G7032.1/8	2.1/8	2.1250	2.1/2	9.7/8	5	1.3/4	6.1/8	5	1/2	9/16	2.1/16

G704



HSS försänkarpilot, löstagbar

Avtagbara, icke-skärande piloter för användning med försänkingsborrkroppar för att följa befintliga hål i arbetsstycket. Flera piloter med samma monteringsdiameter (skaft) passar monteringsdiametern i försänkaren. Se till att piloternas monteringsdiameter är korrekt anpassad till kropps monteringsdiameter

HSS	Bright	ANSI
		

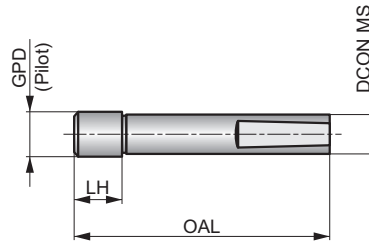

Product	GPD (inch)	DCON MS (inch)	LH (inch)	OAL (inch)
G7041/8X3/32	1/8	3/32	0.125	1.1/4
G7045/32X3/32	5/32	3/32	0.188	1.5/16
G7043/16X3/32	3/16	3/32	0.188	1.5/16
G7047/32X3/32	7/32	3/32	0.250	1.3/8
G7041/4X3/32	1/4	3/32	0.250	1.3/8
G7041/8X1/8	1/8	1/8	0.125	1.7/16
G7045/32X1/8	5/32	1/8	0.188	1.1/2
G7043/16X1/8	3/16	1/8	0.188	1.1/2
G7047/32X1/8	7/32	1/8	0.250	1.9/16
G7041/4X1/8	1/4	1/8	0.250	1.9/16
G7049/32X1/8	9/32	1/8	0.313	1.5/8
G7045/16X1/8	5/16	1/8	0.313	1.5/8
G7043/8X1/8	3/8	1/8	0.375	1.11/16
G7047/16X1/8	7/16	1/8	0.438	1.3/4
G7041/2X1/8	1/2	1/8	0.500	1.13/16
G7043/16X5/32	3/16	5/32	0.188	1.9/16
G7047/32X5/32	7/32	5/32	0.250	1.5/8
G7041/4X5/32	1/4	5/32	0.250	1.5/8
G7049/32X5/32	9/32	5/32	0.313	1.11/16
G7045/16X5/32	5/16	5/32	0.313	1.11/16
G7043/8X5/32	3/8	5/32	0.375	1.3/4
G7043/16X3/16	3/16	3/16	0.250	1.7/8
G7047/32X3/16	7/32	3/16	0.250	1.7/8
G7041/4X3/16	1/4	3/16	0.250	1.7/8
G7049/32X3/16	9/32	3/16	0.313	1.15/16
G7045/16X3/16	5/16	3/16	0.313	1.15/16
G70411/32X3/16	11/32	3/16	0.375	2"
G7043/8X3/16	3/8	3/16	0.375	2"
G70413/32X3/16	13/32	3/16	0.438	2.1/16
G7047/16X3/16	7/16	3/16	0.438	2.1/16
G70415/32X3/16	15/32	3/16	0.500	2.1/8
G7041/2X3/16	1/2	3/16	0.500	2.1/8
G7049/16X3/16	9/16	3/16	0.563	2.3/16
G7045/8X3/16	5/8	3/16	0.563	2.3/16
G70413/16X3/16	13/16	3/16	0.813	2.7/16
G7047/8X3/16	7/8	3/16	0.875	2.1/2
G7041/4X1/4	1/4	1/4	0.250	1.11/16
G7049/32X1/4	9/32	1/4	0.313	1.3/4
G7045/16X1/4	5/16	1/4	0.313	1.3/4

Product	GPD (inch)	DCON MS (inch)	LH (inch)	OAL (inch)
G7043/8X1/4	3/8	1/4	0.375	1.13/16
G7047/16X1/4	7/16	1/4	0.438	1.7/8
G7041/2X1/4	1/2	1/4	0.500	1.15/16
G70417/32X1/4	17/32	1/4	0.563	2"
G7049/16X1/4	9/16	1/4	0.563	2"
G7045/8X1/4	5/8	1/4	0.625	2.1/16
G70411/16X1/4	11/16	1/4	0.688	2.1/8
G7043/4X1/4	3/4	1/4	0.750	2.3/16
G70413/16X1/4	13/16	1/4	0.875	2.5/16
G7041X1/4	1"	1/4	1.000	2.7/16
G7043/8X5/16	3/8	5/16	0.375	2"
G7047/16X5/16	7/16	5/16	0.438	2.1/16
G7041/2X5/16	1/2	5/16	0.500	2.1/8
G7049/16X5/16	9/16	5/16	0.563	2.3/16
G7045/8X5/16	5/8	5/16	0.625	2.1/4
G70411/16X5/16	11/16	5/16	0.688	2.5/16
G7043/4X5/16	3/4	5/16	0.750	2.3/8
G70413/16X5/16	13/16	5/16	0.875	2.1/2
G70415/16X5/16	15/16	5/16	1.000	2.5/8
G7041X5/16	1"	5/16	1.000	2.5/8
G7047/16X3/8	7/16	3/8	0.438	2.5/16
G7041/2X3/8	1/2	3/8	0.500	2.3/8
G7049/16X3/8	9/16	3/8	0.563	2.7/16
G7045/8X3/8	5/8	3/8	0.625	2.1/2
G70411/16X3/8	11/16	3/8	0.688	2.9/16
G7043/4X3/8	3/4	3/8	0.750	2.5/8
G70413/16X3/8	13/16	3/8	0.875	2.3/4
G7047/8X3/8	7/8	3/8	0.875	2.3/4
G70415/16X3/8	15/16	3/8	1.000	2.5/8
G7049/16X7/16	9/16	7/16	0.625	2.7/8
G70411/16X7/16	11/16	7/16	0.750	3"
G7043/4X7/16	3/4	7/16	0.750	3"
G70413/16X7/16	13/16	7/16	0.875	3.1/8
G7047/8X7/16	7/8	7/16	0.875	3.1/8
G70415/16X7/16	15/16	7/16	1.000	3.1/4
G7041X7/16	1"	7/16	1.000	3.1/4
G7049/16X1/2	9/16	1/2	0.625	3.1/8
G7041X1/2	1"	1/2	1.000	3.1/2
G7041.1/2X1/2	1.1/2	1/2	1.500	4"

G705



HSS försänkt kropp, lång serie för flygplan, utbytbar pilottyp

Cylindriskt skaft för flygplansborr med lång serie som används tillsammans med avtagbara styrpinor för att förstora toppen av ett förborrat hål genom att använda en planförsänkare. En avtagbar styrpinne G704, som inte skär, är monterad i kroppen och följer det befintliga hålet för att styra och centrera försänkningen.

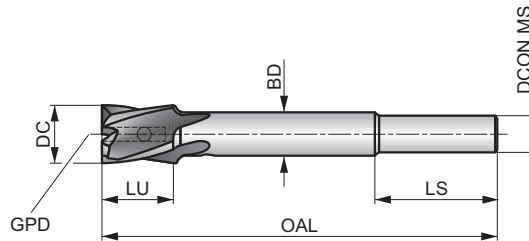

HSS	Bright	ANSI
R		

Arbetsmaterialgrupper och startvärden för skärhastighet (m/min) och matningskod. Tabeller med matningar finns med början på sidan 274

P1.1 ■ 20 E	P1.2 ■ 22 E	P1.3 ■ 23 E	P2.1 ■ 17 E	P2.2 ■ 15 D	P2.3 ■ 13 C	P3.1 ■ 12 D	P3.2 ■ 9 D	P3.3 ■ 8 C	P4.1 ■ 7 D	P4.2 ■ 6 C	M1.1 ■ 8 D	M1.2 ■ 6 D	M2.1 ■ 7 D
M2.2 ■ 6 D	M2.3 ■ 5 C	K1.1 ■ 17 E	K1.2 ■ 12 E	K1.3 ■ 11 E	K2.1 ■ 15 D	K2.2 ■ 12 D	K2.3 ■ 10 C	K3.1 ■ 13 D	K3.2 ■ 10 D	K4.1 ■ 12 D	K4.2 ■ 9 D	K5.1 ■ 14 D	K5.2 ■ 10 D
N1.1 ■ 30 G	N1.2 ■ 23 G	N1.3 ■ 15 G	N2.1 ■ 31 G	N2.2 ■ 28 G	N2.3 ■ 20 G	N3.1 ■ 34 C	N3.2 ■ 20 C	N3.3 ■ 10 C	N4.1 ■ 30 C	N4.2 ■ 20 C			

Product	DC (inch)	DC (inch)	LU (inch)	OAL (inch)	DCON MS (inch)	LS (inch)	BD (inch)	NOF	GPD (inch)	GPDN (inch)	GPDX (inch)
G7051/4	1/4	0.2500	1/2	4	15/64	15/64	15/64	4	3/32	1/8	3/16
G7055/16	5/16	0.3125	1/2	4	19/64	19/64	19/64	4	3/32	1/8	1/4
G7053/8	3/8	0.3750	5/8	4	5/16	5/16	5/16	4	3/32	1/8	5/16
G7057/16	7/16	0.4375	5/8	4	3/8	3/8	3/8	4	1/8	3/16	3/8
G7051/2	1/2	0.5000	5/8	4.1/4	7/16	7/16	7/16	4	1/8	1/8	7/16
G70517/32	17/32	0.5313	5/8	4.1/4	1/2	1/2	1/2	4	1/8	1/8	1/2
G7059/16	9/16	0.5625	5/8	4.1/4	1/2	1/2	1/2	4	1/8	1/8	1/2
G70519/32	19/32	0.5938	5/8	4.1/4	1/2	9/16	9/16	4	1/8	1/8	1/2
G7055/8	5/8	0.6250	5/8	4.1/4	1/2	9/16	9/16	4	1/8	1/8	1/2
G70521/32	21/32	0.6563	5/8	5.3/8	1/2	9/16	9/16	4	3/16	3/16	5/8
G70511/16	11/16	0.6875	5/8	5.3/8	1/2	5/8	5/8	4	3/16	3/16	5/8
G7053/4	3/4	0.7500	3/4	5.3/8	1/2	11/16	11/16	4	3/16	3/16	5/8
G70525/32	25/32	0.7813	3/4	5.3/8	1/2	11/16	11/16	4	3/16	3/16	5/8
G70513/16	13/16	0.8125	3/4	5.3/8	1/2	3/4	3/4	4	3/16	3/16	5/8
G7057/8	7/8	0.8750	15/16	5.3/8	1/2	3/4	3/4	4	3/16	3/16	13/16
G70515/16	15/16	0.9375	15/16	5.3/8	1/2	3/4	3/4	4	3/16	3/16	7/8

G706



HSS försänkt kropp, kort serie för flygplan, utbyttbar pilottyp

Cylindriskt skaft för kort serie flygplansborr som används tillsammans med avtagbara styrcinnar för att förstora toppen av ett förborrat hål genom att använda en planförsänkare. En avtagbar styrcinne G704, som inte skär, är monterad i kroppen och följer det befintliga hålet för att styra och centrera försänkningen.

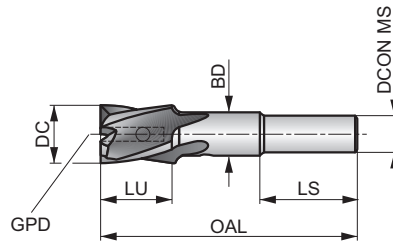

HSS	Bright	ANSI
R		

Arbetsmaterialgrupper och startvärden för skärhastighet (m/min) och matningskod. Tabeller med matningar finns med början på sidan 274

P1.1 ■ 20 E	P1.2 ■ 22 E	P1.3 ■ 23 E	P2.1 ■ 17 E	P2.2 ■ 15 D	P2.3 ▣ 13 C	P3.1 ■ 12 D	P3.2 ▣ 9 D	P3.3 ▣ 8 C	P4.1 ▣ 7 D	P4.2 ▣ 6 C	M1.1 ▣ 8 D	M1.2 ▣ 6 D	M2.1 ▣ 7 D
M2.2 ▣ 6 D	M2.3 ▣ 5 C	K1.1 ■ 17 E	K1.2 ▣ 12 E	K1.3 ▣ 11 E	K2.1 ■ 15 D	K2.2 ▣ 12 D	K2.3 ▣ 10 C	K3.1 ▣ 13 D	K3.2 ▣ 10 D	K4.1 ▣ 12 D	K4.2 ▣ 9 D	K5.1 ■ 14 D	K5.2 ▣ 10 D
N1.1 ▣ 30 G	N1.2 ■ 23 G	N1.3 ■ 15 G	N2.1 ▣ 31 G	N2.2 ▣ 28 G	N2.3 ▣ 20 G	N3.1 ■ 34 C	N3.2 ■ 20 C	N3.3 ▣ 10 C	N4.1 ■ 30 C	N4.2 ▣ 20 C			

Product	DC (inch)	DC (inch)	LU (inch)	OAL (inch)	DCON MS (inch)	LS (inch)	BD (inch)	NOF	GPD (inch)	GPDN (inch)	GPDX (inch)
G7061/4	1/4	0.2500	1/2	2.3/8	1/4	1.1/8	15/64	4	3/32	1/8	3/16
G7065/16	5/16	0.3125	1/2	2.3/8	1/4	7/8	17/64	4	3/32	1/8	1/4
G70611/32	11/32	0.3438	1/2	2.3/8	1/4	7/8	19/64	4	3/32	1/8	9/32
G7063/8	3/8	0.3750	1/2	2.3/8	1/4	7/8	5/16	4	3/32	3/16	5/16
G70613/32	13/32	0.4063	1/2	2.13/16	1/4	7/8	5/16	4	1/8	3/16	11/32
G7067/16	7/16	0.4375	1/2	2.13/16	1/4	7/8	5/16	4	1/8	3/16	3/8
G70615/32	15/32	0.4688	1/2	2.13/16	1/4	7/8	5/16	4	1/8	1/4	13/32
G7061/2	1/2	0.5000	1/2	2.13/16	1/4	7/8	3/8	4	1/8	1/4	7/16
G70617/32	17/32	0.5313	1/2	2.13/16	1/4	7/8	3/8	4	1/8	1/4	15/32
G7069/16	9/16	0.5625	1/2	2.13/16	1/4	7/8	3/8	4	1/8	1/4	1/2
G70611/16	11/16	0.6875	1/2	2.13/16	1/4	7/8	1/2	4	1/8	1/4	5/8
G7063/4	3/4	0.7500	1/2	2.13/16	1/4	7/8	1/2	4	3/16	5/16	11/16
G70613/16	13/16	0.8125	1/2	2.13/16	1/4	7/8	1/2	4	3/16	5/16	3/4
G7067/8	7/8	0.8750	1/2	2.13/16	1/4	7/8	1/2	4	3/16	5/16	13/16
G7061	1"	1.0000	1/2	2.13/16	1/4	7/8	1/2	4	3/16	3/8	15/16

A400



Stegbör av HSS för frigångshål, ånganlöpt

Stegbör för borrar av frigångshål och försänkning för metrisk skruvar. 118° spets och 90° försänkingsvinkel. Ånganlöpt. Användbart i både styrda och konventionella maskiner och i de flesta materialtyper.

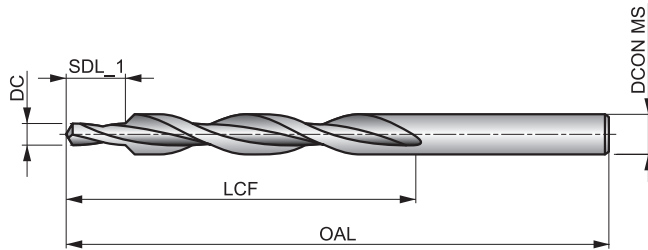

HSS	DIN 8374	4×D
90°	ST	
λ 20-35°	R	118°

Arbetsmaterialgrupper och startvärden för skärhastighet (m/min) och matningskod. Tabeller med matningar finns med början på sidan 274

P1.1 ■ 29 G	P1.2 ■ 33 G	P1.3 ■ 34 G	P2.1 ■ 25 G	P2.2 ■ 22 E	P2.3 ■ 19 C	P3.1 ■ 15 E	P3.2 ■ 12 E	P3.3 ■ 10 C	P4.1 ■ 9 E	P4.2 ■ 7 C	P4.3 ■ 6 C	M1.1 ■ 22 E	M1.2 ■ 19 E
M2.1 ■ 20 E	M2.2 ■ 16 E	M3.1 ■ 10 G	M3.2 ■ 9 G	M3.3 ■ 8 G	M4.1 ■ 12 C	K1.1 ■ 30 G	K1.2 ■ 22 E	K1.3 ■ 17 E	K2.1 ■ 23 E	K2.2 ■ 19 E	K2.3 ■ 15 C	K3.1 ■ 21 E	K3.2 ■ 16 E
K3.3 ■ 13 C	K4.1 ■ 19 E	K4.2 ■ 14 E	K4.3 ■ 11 C	K4.4 ■ 9 C	K4.5 ■ 8 C	K5.1 ■ 22 E	K5.2 ■ 16 E	K5.3 ■ 13 C	N1.1 ■ 45 E	N1.2 ■ 34 E	N1.3 ■ 23 E	N2.1 ■ 49 E	N2.2 ■ 44 E
N2.3 ■ 32 E	N3.1 ■ 68 E	N3.2 ■ 40 E	N3.3 ■ 20 E	N4.1 ■ 30 I	S1.1 ■ 23 E	S1.2 ■ 14 C	S1.3 ■ 8 A	S2.1 ■ 8 C	S2.2 ■ 6 A	S3.1 ■ 6 C	S3.2 ■ 4 A	S4.1 ■ 5 C	S4.2 ■ 3 A

Product	TDZ	DC	DC	LCF	OAL	SDL_1	DCON MS
		(mm)	(inch)				
A400M3	M3	3.20	0.1260	57.0	93.0	9.00	6.00
A400M4	M4	4.30	0.1693	75.0	117.0	11.00	8.00
A400M5	M5	5.30	0.2087	87.0	133.0	13.00	10.00
A400M6	M6	6.40	0.2520	94.0	142.0	15.00	11.50
A400M8	M8	8.40	0.3307	114.0	169.0	19.00	15.00

A402

DORMER



Stegborr av HSS för frigångshål, ånganlöpt

Stegborr för borrar av frigångshål och försänkning för metrisk skruvar. 118° spets och 180° försänkingsvinkel. Ånganlöpt. Användbart i både styrda och konventionella maskiner och i de flesta materialtyper.

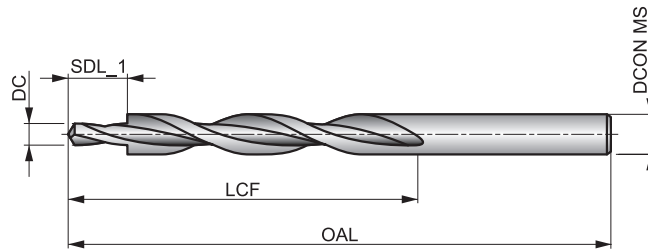

HSS	DIN 8376	4×D
180°	ST	
λ 20-35°	R	118°

Arbetsmaterialgrupper och startvärden för skärhastighet (m/min) och matningskod. Tabeller med matningar finns med början på sidan 274

P1.1 ■ 29 G	P1.2 ■ 33 G	P1.3 ■ 34 G	P2.1 ■ 25 G	P2.2 ■ 22 E	P2.3 ■ 19 C	P3.1 ■ 15 E	P3.2 ■ 12 E	P3.3 ■ 10 C	P4.1 ■ 9 E	P4.2 ■ 7 C	P4.3 ■ 6 C	M1.1 ■ 22 E	M1.2 ■ 19 E
M2.1 ■ 20 E	M2.2 ■ 16 E	M3.1 ■ 10 G	M3.2 ■ 9 G	M3.3 ■ 8 G	M4.1 ■ 12 C	K1.1 ■ 30 G	K1.2 ■ 22 E	K1.3 ■ 17 E	K2.1 ■ 23 E	K2.2 ■ 19 E	K2.3 ■ 15 C	K3.1 ■ 21 E	K3.2 ■ 16 E
K3.3 ■ 13 C	K4.1 ■ 19 E	K4.2 ■ 14 E	K4.3 ■ 11 C	K4.4 ■ 9 C	K4.5 ■ 8 C	K5.1 ■ 22 E	K5.2 ■ 16 E	K5.3 ■ 13 C	N1.1 ■ 45 E	N1.2 ■ 34 E	N1.3 ■ 23 E	N2.1 ■ 49 E	N2.2 ■ 44 E
N2.3 ■ 32 E	N3.1 ■ 68 E	N3.2 ■ 40 E	N3.3 ■ 20 E	N4.1 ■ 30 I	S1.1 ■ 23 E	S1.2 ■ 14 C	S1.3 ■ 8 A	S2.1 ■ 8 C	S2.2 ■ 6 A	S3.1 ■ 6 C	S3.2 ■ 4 A	S4.1 ■ 5 C	S4.2 ■ 3 A

Product	TDZ	DC	DC	LCF	OAL	SDL_1	DCON MS
		(mm)	(inch)				
A402M3	M3	3.40	0.1339	57.0	93.0	9.00	6.00
A402M4	M4	4.50	0.1772	75.0	117.0	11.00	8.00
A402M5	M5	5.50	0.2165	87.0	133.0	13.00	10.00
A402M6	M6	6.60	0.2598	94.0	142.0	15.00	11.00
A402M8	M8	9.00	0.3543	114.0	169.0	19.00	15.00
A402M10	M10	11.00	0.4331	130.0	191.0	23.00	18.00

A413

DORMER

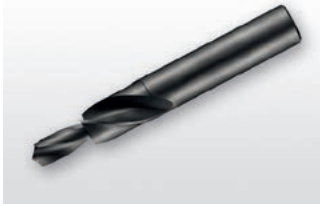

Tappborr av HSS för frigångshål, ånganlöpt

Tappborr för borrar av frigångshål och försänkning för metrisk skruvar. 118° spets och 180° försänkingsvinkel. Ånganlöpt. Användbart i både styrda och konventionella maskiner och i de flesta materialtyper.

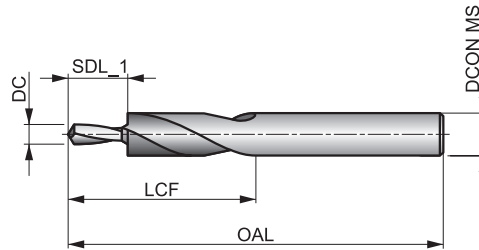

HSS		2.5xD
180°		
R	118°	

Arbetsmaterialgrupper och startvärden för skärhastighet (m/min) och matningskod. Tabeller med matningar finns med början på sidan 274

P1.1 ■ 29 I	P1.2 ■ 33 I	P1.3 ■ 34 I	P2.1 ■ 25 I	P2.2 ■ 22 G	P2.3 ■ 19 E	P3.1 ■ 15 G	P3.2 ■ 12 G	P3.3 ■ 10 E	P4.1 ■ 9 G	P4.2 ■ 7 E	P4.3 ■ 6 C	M1.1 ■ 22 G	M1.2 ■ 19 G
M2.1 ■ 20 G	M2.2 ■ 16 G	M3.1 ■ 10 I	M3.2 ■ 9 I	M3.3 ■ 8 I	M4.1 ■ 12 E	K1.1 ■ 30 G	K1.2 ■ 22 E	K1.3 ■ 17 E	K2.1 ■ 23 E	K2.2 ■ 19 E	K2.3 ■ 15 E	K3.1 ■ 21 E	K3.2 ■ 16 E
K3.3 ■ 13 E	K4.1 ■ 19 E	K4.2 ■ 14 E	K4.3 ■ 11 E	K4.4 ■ 9 E	K4.5 ■ 8 E	K5.1 ■ 22 E	K5.2 ■ 16 E	K5.3 ■ 13 E	N1.1 ■ 45 G	N1.2 ■ 34 G	N1.3 ■ 23 G	N2.1 ■ 42 G	N2.2 ■ 37 G
N2.3 ■ 27 G	N3.1 ■ 68 G	N3.2 ■ 40 G	N3.3 ■ 20 G	N4.1 ■ 30 I	S1.1 ■ 27 G	S1.2 ■ 16 E	S1.3 ■ 8 C	S2.1 ■ 11 G	S2.2 ■ 6 C	S3.1 ■ 8 G	S3.2 ■ 4 C	S4.1 ■ 6 G	S4.2 ■ 3 C

Product	TDZ	DC	DC	LCF	OAL	SDL_1	DCON MS
		(mm)	(inch)				
A413M3	M3	3.40	0.1339	28.0	66.0	9.00	6.00
A413M4	M4	4.50	0.1772	37.0	79.0	11.00	8.00
A413M5	M5	5.50	0.2165	43.0	89.0	13.00	10.00
A413M6	M6	6.60	0.2598	47.0	95.0	15.00	11.00
A413M8	M8	9.00	0.3543	56.0	111.0	19.00	15.00
A413M10	M10	11.00	0.4331	62.0	123.0	23.00	18.00

A412

DORMER



Tappborr av HSS för frigångshål, ånganlöpt

Tappborr för borrar av frigångshål och försänkning för standardskruvar. 118° spetsvinkel på pilotborret och 90° försänkingsvinkel. Ånganlöpt. Kan användas i både CNC-maskiner och i konventionella och i de flesta material.

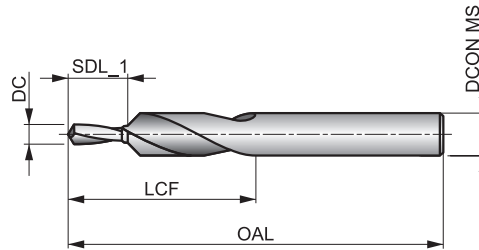

HSS		2.5xD
90°		
R		

Arbetsmaterialgrupper och startvärden för skärhastighet (m/min) och matningskod. Tabeller med matningar finns med början på sidan 274

P1.1 ■ 29 I	P1.2 ■ 33 I	P1.3 ■ 34 I	P2.1 ■ 25 I	P2.2 ■ 22 G	P2.3 ■ 19 E	P3.1 ■ 15 G	P3.2 ■ 12 G	P3.3 ■ 10 E	P4.1 ■ 9 G	P4.2 ■ 7 E	P4.3 ■ 6 C	M1.1 ■ 22 G	M1.2 ■ 19 G
M2.1 ■ 20 G	M2.2 ■ 16 G	M3.1 ■ 10 I	M3.2 ■ 9 I	M3.3 ■ 8 I	M4.1 ■ 12 E	K1.1 ■ 30 G	K1.2 ■ 22 E	K1.3 ■ 17 E	K2.1 ■ 23 E	K2.2 ■ 19 E	K2.3 ■ 15 E	K3.1 ■ 21 E	K3.2 ■ 16 E
K3.3 ■ 13 E	K4.1 ■ 19 E	K4.2 ■ 14 E	K4.3 ■ 11 E	K4.4 ■ 9 E	K4.5 ■ 8 E	K5.1 ■ 22 E	K5.2 ■ 16 E	K5.3 ■ 13 E	N1.1 ■ 45 G	N1.2 ■ 34 G	N1.3 ■ 23 G	N2.1 ■ 42 G	N2.2 ■ 37 G
N2.3 ■ 27 G	N3.1 ■ 68 G	N3.2 ■ 40 G	N3.3 ■ 20 G	N4.1 ■ 30 I	S1.1 ■ 27 G	S1.2 ■ 16 E	S1.3 ■ 8 C	S2.1 ■ 11 G	S2.2 ■ 6 C	S3.1 ■ 8 G	S3.2 ■ 4 C	S4.1 ■ 6 G	S4.2 ■ 3 C

Product	TDZ	DC	DC	LCF	OAL	SDL_1	DCON MS
		(mm)	(inch)				
A412M3	M3	3.40	0.1339	31.0	70.0	9.00	6.60
A412M4	M4	4.50	0.1772	40.0	84.0	11.00	9.00
A412M5	M5	5.50	0.2165	47.0	95.0	13.00	11.00
A412M6	M6	6.60	0.2598	51.0	102.0	15.00	13.00
A412M8	M8	9.00	0.3543	62.0	123.0	19.00	17.20
A412M10	M10	11.00	0.4331	70.0	141.0	23.00	21.50

Verktygsmaterial (BMC)	HSS	HSS	HSS-E	HSS-E	HSS	HSS	HSS	HSS-E	HM	HSS		
Standard (BSG)	DIN 333A	DIN 333A	DIN 333A	DIN 333A	DIN 333R	DORMER	BS 328	DORMER	DIN 333A			
Användbar längd (ULDR)	1xD	1xD	1xD	1xD	1xD	1xD	1xD	1xD	1xD	1xD		
Spetsvinkel	60°	60°	60°	60°	R	60°	60°	60°	60°	60°		
Beläggning	Bright	TiN	Bright	TiAlN	Bright	Bright	Bright	Bright	Bright	Bright		
Skaft												
Skärriktning	R	R	R	R	R	R	R	R	R	R		
Produktfamilj	A200	A205	A206	A266	A210	A201	A225	A242	R200	A296		
PSF skärdiametrar	0.50 - 12.50	1.00 - 5.00	1.00 - 5.00	1.00 - 5.00	0.50 - 8.00	0.63 - 6.00	3/64 - 5/16	1.00 - 5.00	1.00 - 5.00	Set		
P	P1	■	■	■	■	■	■	■	■			
	P2	■	■	■	■	■	■	■	■			
	P3	■	■	■	■	■	■	■	■			
	P4	■	■	■	■	■	■	■	■			
M	M1	■	■	■	■	■	■	■	■			
	M2	■	■	■	■	■	■	■	■			
	M3	■	■	■	■	■	■	■	■			
	M4	■	■	■	■	■	■	■	■			
K	K1	■	■	■	■	■	■	■	■			
	K2	■	■	■	■	■	■	■	■			
	K3	■	■	■	■	■	■	■	■			
	K4	■	■	■	■	■	■	■	■			
	K5	■	■	■	■	■	■	■	■			
N	N1	■	■	■	■	■	■	■	■			
	N2	■	■	■	■	■	■	■	■			
	N3	■	■	■	■	■	■	■	■			
	N4	■	■	■	■	■	■	■	■			
	N5	■	■	■	■	■	■	■	■			
S	S1	■	■	■	■	■	■	■	■			
	S2	■	■	■	■	■	■	■	■			
	S3	■	■	■	■	■	■	■	■			
	S4	■	■	■	■	■	■	■	■			
H	H1											
	H2											
	H3											
	H4											

A200



Dubbhålsborr HSS med 118° spets och 60° försänkning, blank

Används till att borra dubbhål i axeländar för att kunna spänna in dem för vidare bearbetning. Dubbhålsborren har skär i båda ändarna för bättre ekonomi. Går att använda i de flesta material.

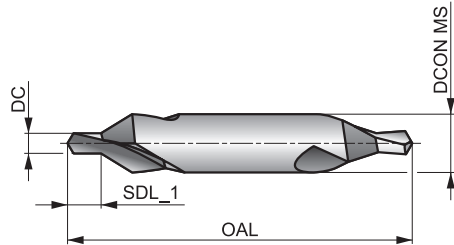

HSS	DIN 333A	1xD
60°	Bright	
R	118°	

Arbetsmaterialgrupper och startvärden för skärhastighet (m/min) och matningskod. Tabeller med matningar finns med början på sidan 274

P1.1 ■ 33 I	P1.2 ■ 37 I	P1.3 ■ 38 I	P2.1 ■ 28 I	P2.2 ■ 25 G	P2.3 ■ 22 E	P3.1 ■ 19 F	P3.2 ■ 15 F	P3.3 ■ 13 E	P4.1 ■ 11 F	P4.2 ■ 10 E	P4.3 ■ 8 D	M1.1 ■ 21 E	M1.2 ■ 17 E
M2.1 ■ 18 E	M2.2 ■ 15 E	M3.1 ■ 9 G	M3.2 ■ 8 G	M3.3 ■ 7 G	M4.1 ■ 10 C	K1.1 ■ 30 I	K1.2 ■ 22 F	K1.3 ■ 17 F	K2.1 ■ 25 E	K2.2 ■ 20 E	K2.3 ■ 16 E	K3.1 ■ 22 E	K3.2 ■ 17 E
K3.3 ■ 13 E	K4.1 ■ 20 E	K4.2 ■ 15 E	K4.3 ■ 11 E	K4.4 ■ 10 E	K4.5 ■ 8 E	K5.1 ■ 23 E	K5.2 ■ 17 E	K5.3 ■ 13 E	N1.1 ■ 33 J	N1.2 ■ 25 J	N1.3 ■ 17 I	N2.1 ■ 42 H	N2.2 ■ 37 H
N2.3 ■ 27 H	N3.1 ■ 56 H	N3.2 ■ 33 I	N3.3 ■ 17 G	N4.1 ■ 30 J	N4.2 ■ 28 H	N4.3 ■ 14 F	S1.1 ■ 24 F	S1.2 ■ 13 D	S1.3 ■ 7 B	S2.1 ■ 7 E	S2.2 ■ 6 A	S3.1 ■ 5 E	S3.2 ■ 4 A
S4.1 ■ 4 E	S4.2 ■ 3 A												

Produkter från den här serien finns även i set. Se A296

Product	DC	DC	SDL_1	OAL	DCON MS
	(mm)	(inch)	(mm)	(mm)	(mm)
A200.5X3.15 ¹⁾	0.50	0.0197	0.9 - 0.6	25.0	3.15
A200.8X3.15 ¹⁾	0.80	0.0315	1.3 - 1.0	25.0	3.15
A2001.0X3.15	1.00	0.0394	1.7 - 1.3	31.0	3.15
A2001.25X3.15	1.25	0.0492	2.0 - 1.6	31.0	3.15
A2001.6X4.0	1.60	0.0630	2.6 - 2.0	35.0	4.00
A2002.0X5.0	2.00	0.0787	3.1 - 2.5	40.0	5.00
A2002.5X6.3	2.50	0.0984	3.8 - 3.1	45.0	6.30
A2003.15X8.0	3.15	0.1240	4.6 - 3.9	50.0	8.00
A2004.0X10.0	4.00	0.1575	5.9 - 5.0	55.0	10.00
A2005.0X12.5	5.00	0.1969	7.2 - 6.3	63.0	12.50
A2006.3X16.0	6.30	0.2480	8.9 - 8.0	71.0	16.00
A2008.0X20.0	8.00	0.3150	11.1 - 10.1	80.0	20.00
A20010.0X25.0	10.00	0.3937	13.8 - 12.8	100.0	25.00
A20012.5X31.5	12.50	0.4921	17.5 - 16.5	125.0	31.50

¹⁾ Endast enkel ände.

A205

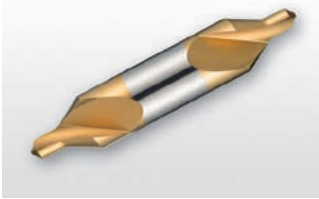

Dubbhålsborr HSS med 118° spets och 60° försänkning, TiN-belagd

Används till att borra dubbhål i axeländar för att kunna spänna in dem för vidare bearbetning. Dubbhålsborren har skär i båda ändarna för bättre ekonomi. TiN-belagd. Går att använda i de flesta material.

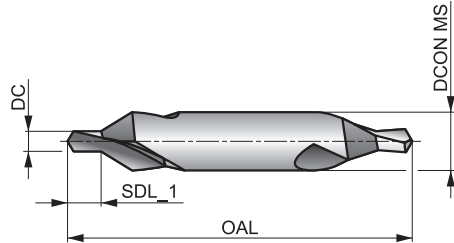

HSS	DIN 333A	1xD
60°	TiN	
R	118°	

Arbetsmaterialgrupper och startvärden för skärhastighet (m/min) och matningskod. Tabeller med matningar finns med början på sidan 274

P1.1 ■ 40 I	P1.2 ■ 45 I	P1.3 ■ 46 I	P2.1 ■ 34 I	P2.2 ■ 30 G	P2.3 ■ 27 E	P3.1 ■ 24 F	P3.2 ■ 19 F	P3.3 ■ 16 E	P4.1 ■ 14 F	P4.2 ■ 12 E	P4.3 ■ 10 D	M1.1 ■ 25 E	M1.2 ■ 21 E
M2.1 ■ 22 E	M2.2 ■ 18 E	M3.1 ■ 12 G	M3.2 ■ 10 G	M3.3 ■ 9 G	M4.1 ■ 12 C	K1.1 ■ 36 I	K1.2 ■ 27 F	K1.3 ■ 20 F	K2.1 ■ 30 E	K2.2 ■ 24 E	K2.3 ■ 19 E	K3.1 ■ 26 E	K3.2 ■ 20 E
K3.3 ■ 16 E	K4.1 ■ 24 E	K4.2 ■ 18 E	K4.3 ■ 13 E	K4.4 ■ 11 E	K4.5 ■ 10 E	K5.1 ■ 27 E	K5.2 ■ 21 E	K5.3 ■ 16 E	N1.1 ■ 40 J	N1.2 ■ 30 J	N1.3 ■ 20 I	N2.1 ■ 49 H	N2.2 ■ 44 H
N2.3 ■ 32 H	N3.1 ■ 24 E	N3.2 ■ 40 I	N3.3 ■ 20 G	N4.1 ■ 36 J	N4.2 ■ 34 H	N4.3 ■ 17 F	S1.1 ■ 29 F	S1.2 ■ 16 D	S1.3 ■ 8 B	S2.1 ■ 8 E	S2.2 ■ 7 A	S3.1 ■ 6 E	S3.2 ■ 5 A
S4.1 ■ 5 E	S4.2 ■ 4 A												

Product	DC	DC	SDL_1	OAL	DCON MS
	(mm)	(inch)			
A2051.0X3.15	1.00	0.0394	1.7 - 1.3	31.0	3.15
A2051.25X3.15	1.25	0.0492	2.0 - 1.6	31.0	3.15
A2051.6X4.0	1.60	0.0630	2.6 - 2.0	35.0	4.00
A2052.0X5.0	2.00	0.0787	3.1 - 2.5	40.0	5.00
A2052.5X6.3	2.50	0.0984	3.8 - 3.1	45.0	6.30
A2053.15X8.0	3.15	0.1240	4.6 - 3.9	50.0	8.00
A2054.0X10.0	4.00	0.1575	5.9 - 5.0	55.0	10.00
A2055.0X12.5	5.00	0.1969	7.2 - 6.3	63.0	12.50

A206

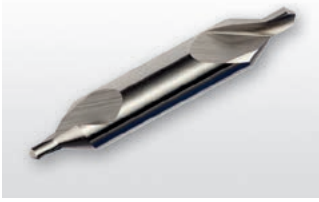

Dubbhålsborr HSS-E med 118° spets och 60° försänkning, blank

Används till att borra dubbhål i axeländar för att kunna spänna in dem för vidare bearbetning. Dubbhålsborren har skär i båda ändarna för bättre ekonomi. Går att använda i de flesta material.

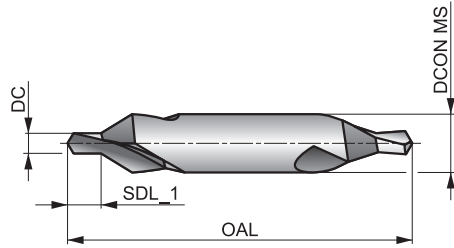

HSS-E	DIN 333A	1xD
60°	Bright	
R	118°	

Arbetsmaterialgrupper och startvärden för skärhastighet (m/min) och matningskod. Tabeller med matningar finns med början på sidan 274

P1.1 ■ 40 I	P1.2 ■ 45 I	P1.3 ■ 46 I	P2.1 ■ 34 I	P2.2 ■ 30 G	P2.3 ▣ 27 E	P3.1 ■ 24 F	P3.2 ■ 19 F	P3.3 ▣ 16 E	P4.1 ■ 14 F	P4.2 ▣ 12 E	P4.3 ▣ 10 D	M1.1 ▣ 25 E	M1.2 ▣ 21 E
M2.1 ▣ 22 E	M2.2 ▣ 18 E	M3.1 ▣ 12 G	M3.2 ▣ 10 G	M3.3 ▣ 9 G	M4.1 ▣ 12 C	K1.1 ■ 36 I	K1.2 ■ 27 F	K1.3 ■ 20 F	K2.1 ▣ 30 E	K2.2 ▣ 24 E	K2.3 ▣ 19 E	K3.1 ▣ 26 E	K3.2 ▣ 20 E
K3.3 ▣ 16 E	K4.1 ▣ 24 E	K4.2 ▣ 18 E	K4.3 ▣ 13 E	K4.4 ▣ 11 E	K4.5 ▣ 10 E	K5.1 ▣ 27 E	K5.2 ▣ 21 E	K5.3 ▣ 16 E	N1.1 ▣ 40 J	N1.2 ▣ 30 J	N1.3 ▣ 20 I	N2.1 ▣ 49 H	N2.2 ▣ 44 H
N2.3 ▣ 32 H	N3.1 ▣ 68 H	N3.2 ▣ 40 I	N3.3 ▣ 20 G	N4.1 ▣ 36 J	N4.2 ▣ 34 H	N4.3 ▣ 17 F	S1.1 ▣ 29 F	S1.2 ▣ 16 D	S1.3 ▣ 8 B	S2.1 ▣ 8 E	S2.2 ▣ 7 A	S3.1 ▣ 6 E	S3.2 ▣ 5 A
S4.1 ▣ 5 E	S4.2 ▣ 4 A												

Product	DC	DC	SDL_1	OAL	DCON MS
	(mm)	(inch)			
A2061.0X3.15	1.00	0.0394	1.7 - 1.3	31.0	3.15
A2061.25X3.15	1.25	0.0492	2.0 - 1.6	31.0	3.15
A2061.6X4.0	1.60	0.0630	2.6 - 2.0	35.0	4.00
A2062.0X5.0	2.00	0.0787	3.1 - 2.5	40.0	5.00
A2062.5X6.3	2.50	0.0984	3.8 - 3.1	45.0	6.30
A2063.15X8.0	3.15	0.1240	4.6 - 3.9	50.0	8.00
A2064.0X10.0	4.00	0.1575	5.9 - 5.0	55.0	10.00
A2065.0X12.5	5.00	0.1969	7.2 - 6.3	63.0	12.50

A266

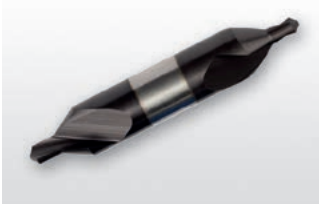

Dubbhålsborr HSS-E med 118° spets och 60° försänkning, TiAIN-belagd

Används till att borra dubbhål i axeländar för att kunna späna in dem för vidare bearbetning. Dubbhålsborren har skär i båda ändarna för bättre ekonomi. TiAIN-belagd. Går att använda i de flesta material.

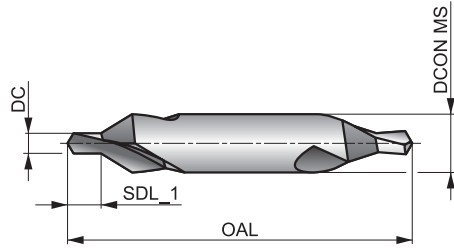

HSS-E	DIN 333A	1xD
60°	TiAIN	
R	118°	

Arbetsmaterialgrupper och startvärden för skärhastighet (m/min) och matningskod. Tabeller med matningar finns med början på sidan 274

P1.1 ■ 40 I	P1.2 ■ 45 I	P1.3 ■ 46 I	P2.1 ■ 34 I	P2.2 ■ 30 G	P2.3 ▣ 27 E	P3.1 ■ 24 F	P3.2 ■ 19 F	P3.3 ▣ 16 E	P4.1 ■ 14 F	P4.2 ▣ 12 E	P4.3 ▣ 10 D	M1.1 ▣ 25 E	M1.2 ▣ 21 E
M2.1 ▣ 22 E	M2.2 ▣ 18 E	M3.1 ▣ 12 G	M3.2 ▣ 10 G	M3.3 ▣ 9 G	M4.1 ▣ 12 C	K1.1 ■ 36 I	K1.2 ■ 27 F	K1.3 ■ 20 F	K2.1 ▣ 30 E	K2.2 ▣ 24 E	K2.3 ▣ 19 E	K3.1 ▣ 26 E	K3.2 ▣ 20 E
K3.3 ▣ 16 E	K4.1 ▣ 24 E	K4.2 ▣ 18 E	K4.3 ▣ 13 E	K4.4 ▣ 11 E	K4.5 ▣ 10 E	K5.1 ▣ 27 E	K5.2 ▣ 21 E	K5.3 ▣ 16 E	N1.1 ▣ 40 J	N1.2 ▣ 30 J	N1.3 ▣ 20 I	N2.1 ▣ 49 H	N2.2 ▣ 44 H
N2.3 ▣ 32 H	N3.1 ▣ 24 E	N3.2 ▣ 40 I	N3.3 ▣ 20 G	N4.1 ▣ 36 J	N4.2 ▣ 34 H	N4.3 ▣ 17 F	S1.1 ▣ 29 F	S1.2 ▣ 16 D	S1.3 ▣ 8 B	S2.1 ▣ 8 E	S2.2 ▣ 7 A	S3.1 ▣ 6 E	S3.2 ▣ 5 A
S4.1 ▣ 5 E	S4.2 ▣ 4 A												

Product	DC	DC	SDL_1	OAL	DCON MS
	(mm)	(inch)			
A2661.0X3.15	1.00	0.0394	1.7 - 1.3	31.0	3.15
A2661.25X3.15	1.25	0.0492	2.0 - 1.6	31.0	3.15
A2661.6X4.0	1.60	0.0630	2.6 - 2.0	35.0	4.00
A2662.0X5.0	2.00	0.0787	3.1 - 2.5	40.0	5.00
A2662.5X6.3	2.50	0.0984	3.8 - 3.1	45.0	6.30
A2663.15X8.0	3.15	0.1240	4.6 - 3.9	50.0	8.00
A2664.0X10.0	4.00	0.1575	5.9 - 5.0	55.0	10.00
A2665.0X12.5	5.00	0.1969	7.2 - 6.3	63.0	12.50

A210

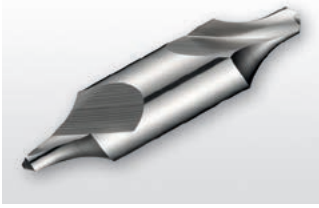

Dubbhålsborr av HSS med 120° spets och konkav försänkning, blank

Används till att borra dubbhål i axeländar för att kunna spänna in dem för vidare bearbetning. Dubbhålsborren har skär i båda ändarna för bättre ekonomi. Går att använda i de flesta material.

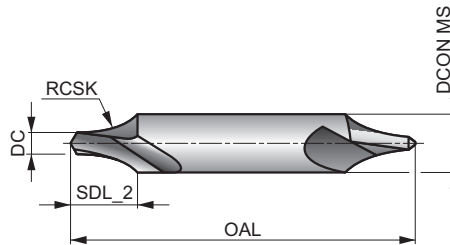

HSS	DIN 333R	1xD
R	Bright	
R	118°	

Arbetsmaterialgrupper och startvärden för skärhastighet (m/min) och matningskod. Tabeller med matningar finns med början på sidan 274

P1.1 ■ 33 I	P1.2 ■ 37 I	P1.3 ■ 38 I	P2.1 ■ 28 I	P2.2 ■ 25 G	P2.3 ■ 22 E	P3.1 ■ 19 F	P3.2 ■ 15 F	P3.3 ■ 13 E	P4.1 ■ 11 F	P4.2 ■ 10 E	P4.3 ■ 8 D	M1.1 ■ 21 E	M1.2 ■ 17 E
M2.1 ■ 18 E	M2.2 ■ 15 E	M3.1 ■ 9 G	M3.2 ■ 8 G	M3.3 ■ 7 G	M4.1 ■ 10 C	K1.1 ■ 30 I	K1.2 ■ 22 F	K1.3 ■ 17 F	K2.1 ■ 25 E	K2.2 ■ 20 E	K2.3 ■ 16 E	K3.1 ■ 22 E	K3.2 ■ 17 E
K3.3 ■ 13 E	K4.1 ■ 20 E	K4.2 ■ 15 E	K4.3 ■ 11 E	K4.4 ■ 10 E	K4.5 ■ 8 E	K5.1 ■ 23 E	K5.2 ■ 17 E	K5.3 ■ 13 E	N1.1 ■ 33 J	N1.2 ■ 25 J	N1.3 ■ 17 I	N2.1 ■ 42 H	N2.2 ■ 37 H
N2.3 ■ 27 H	N3.1 ■ 56 H	N3.2 ■ 33 I	N3.3 ■ 17 G	N4.1 ■ 30 J	N4.2 ■ 28 H	N4.3 ■ 14 F	S1.1 ■ 24 F	S1.2 ■ 13 D	S1.3 ■ 7 B	S2.1 ■ 7 E	S2.2 ■ 6 A	S3.1 ■ 5 E	S3.2 ■ 4 A
S4.1 ■ 4 E	S4.2 ■ 3 A												

Product	DC	DC	SDL_2	OAL	RCSK	DCON MS
	(mm)	(inch)	(mm)	(mm)	(mm)	(mm)
A210.5X3.15 ¹⁾	0.50	0.0197	2.6 - 2.3	25.0	2.50 - 2.00	3.15
A210.8X3.15 ¹⁾	0.80	0.0315	2.9 - 2.6	25.0	3.15 - 2.50	3.15
A2101.0X3.15	1.00	0.0394	3.3 - 3.0	31.0	3.65 - 2.90	3.15
A2101.25X3.15	1.25	0.0492	3.6 - 3.3	31.0	3.95 - 3.15	3.15
A2101.6X4.0	1.60	0.0630	4.7 - 4.2	35.0	5.00 - 4.00	4.00
A2102.0X5.0	2.00	0.0787	5.4 - 5.0	40.0	6.25 - 5.00	5.00
A2102.5X6.3	2.50	0.0984	6.8 - 6.3	45.0	7.88 - 6.30	6.30
A2103.15X8.0	3.15	0.1240	8.5 - 8.0	50.0	10.00 - 8.00	8.00
A2104.0X10.0	4.00	0.1575	10.6 - 10.0	55.0	12.50 - 10.00	10.00
A2105.0X12.5	5.00	0.1969	13.1 - 12.5	63.0	15.63 - 12.50	12.50
A2106.3X16.0	6.30	0.2480	16.6 - 16.0	71.0	20.00 - 16.00	16.00
A2108.0X20.0	8.00	0.3150	20.7 - 20.0	80.0	25.00 - 20.00	20.00

¹⁾ Endast enkel ände.

A201

DORMER



Dubbhålsborr HSS med 122° spets och 60° försänkning, blank

Används till att borra dubbhål i axeländar för att kunna spänna in dem för vidare bearbetning. Dubbhålsborren har skär i båda ändarna för bättre ekonomi. Går att använda i de flesta material.

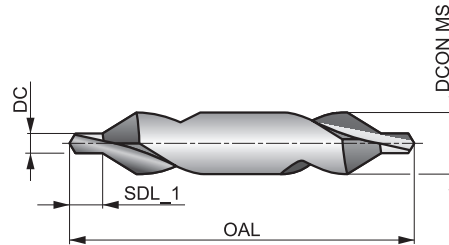

HSS		1xD
60°	Bright	
R	122°	

Arbetsmaterialgrupper och startvärden för skärhastighet (m/min) och matningskod. Tabeller med matningar finns med början på sidan 274

P1.1 ■ 33 I	P1.2 ■ 37 I	P1.3 ■ 38 I	P2.1 ■ 28 I	P2.2 ■ 25 G	P2.3 ■ 22 E	P3.1 ■ 19 F	P3.2 ■ 15 F	P3.3 ■ 13 E	P4.1 ■ 11 F	P4.2 ■ 10 E	P4.3 ■ 8 D	M1.1 ■ 21 E	M1.2 ■ 17 E
M2.1 ■ 18 E	M2.2 ■ 15 E	M3.1 ■ 9 G	M3.2 ■ 8 G	M3.3 ■ 7 G	M4.1 ■ 10 C	K1.1 ■ 30 I	K1.2 ■ 22 F	K1.3 ■ 17 F	K2.1 ■ 25 E	K2.2 ■ 20 E	K2.3 ■ 16 E	K3.1 ■ 22 E	K3.2 ■ 17 E
K3.3 ■ 13 E	K4.1 ■ 20 E	K4.2 ■ 15 E	K4.3 ■ 11 E	K4.4 ■ 10 E	K4.5 ■ 8 E	K5.1 ■ 23 E	K5.2 ■ 17 E	K5.3 ■ 13 E	N1.1 ■ 33 J	N1.2 ■ 25 J	N1.3 ■ 17 I	N2.1 ■ 42 H	N2.2 ■ 37 H
N2.3 ■ 27 H	N3.1 ■ 56 H	N3.2 ■ 33 I	N3.3 ■ 17 G	N4.1 ■ 30 J	N4.2 ■ 28 H	N4.3 ■ 14 F	S1.1 ■ 24 F	S1.2 ■ 13 D	S1.3 ■ 7 B	S2.1 ■ 7 E	S2.2 ■ 6 A	S3.1 ■ 5 E	S3.2 ■ 4 A
S4.1 ■ 4 E	S4.2 ■ 3 A												

Product	DC	DC	SDL_1	OAL	DC ON MS
	(mm)	(inch)			
A201.63X3.15 ¹⁾	0.63	0.0248	1.2 - 0.9	20.0	3.15
A201.75X3.5	0.75	0.0295	1.3 - 1.0	35.0	3.50
A2011.0X4.0	1.00	0.0394	2.1 - 1.5	35.0	4.00
A2011.5X5.0	1.50	0.0591	2.8 - 2.0	40.0	5.00
A2011.6X5.0	1.60	0.0630	2.4 - 2.0	40.0	5.00
A2012.0X6.0	2.00	0.0787	4.0 - 3.0	45.0	6.00
A2012.0X6.3	2.00	0.0787	2.9 - 2.5	45.0	6.30
A2012.5X8.0	2.50	0.0984	4.5 - 3.5	50.0	8.00
A2013.0X8.0	3.00	0.1181	4.4 - 3.9	50.0	8.00
A2013.0X10.0	3.00	0.1181	5.0 - 4.0	56.0	10.00
A2013.15X10.0	3.15	0.1240	4.4 - 3.9	56.0	10.00
A2014.0X12.0	4.00	0.1575	6.2 - 5.0	66.0	12.00
A2015.0X14.0	5.00	0.1969	7.7 - 6.5	78.0	14.00
A2016.0X18.0	6.00	0.2362	9.2 - 8.0	90.0	18.00

¹⁾ Endast enkel ände.

A225

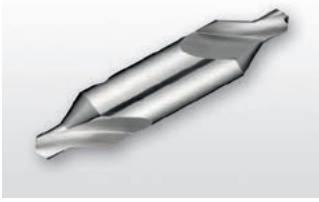

Dubbhålsborr av HSS med 120° spets och 60° försänkning, blank

Används till att borra dubbhål i axeländar för att kunna spänna in dem för vidare bearbetning. Dubbhålsborren har skär i båda ändarna för bättre ekonomi. Går att använda i de flesta material.

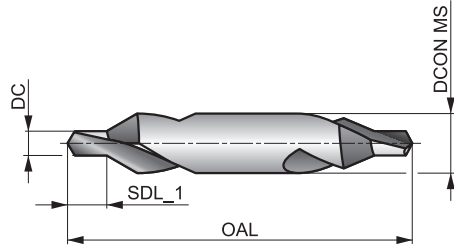

HSS	BS 328	1xD
60°	Bright	
R	120°	

Arbetsmaterialgrupper och startvärden för skärhastighet (m/min) och matningskod. Tabeller med matningar finns med början på sidan 274

P1.1 ■ 33 I	P1.2 ■ 37 I	P1.3 ■ 38 I	P2.1 ■ 28 I	P2.2 ■ 25 G	P2.3 ■ 22 E	P3.1 ■ 19 F	P3.2 ■ 15 F	P3.3 ■ 13 E	P4.1 ■ 11 F	P4.2 ■ 10 E	P4.3 ■ 8 D	M1.1 ■ 21 E	M1.2 ■ 17 E
M2.1 ■ 18 E	M2.2 ■ 15 E	M3.1 ■ 9 G	M3.2 ■ 8 G	M3.3 ■ 7 G	M4.1 ■ 10 C	K1.1 ■ 30 I	K1.2 ■ 22 F	K1.3 ■ 17 F	K2.1 ■ 25 E	K2.2 ■ 20 E	K2.3 ■ 16 E	K3.1 ■ 22 E	K3.2 ■ 17 E
K3.3 ■ 13 E	K4.1 ■ 20 E	K4.2 ■ 15 E	K4.3 ■ 11 E	K4.4 ■ 10 E	K4.5 ■ 8 E	K5.1 ■ 23 E	K5.2 ■ 17 E	K5.3 ■ 13 E	N1.1 ■ 33 J	N1.2 ■ 25 J	N1.3 ■ 17 I	N2.1 ■ 42 H	N2.2 ■ 37 H
N2.3 ■ 27 H	N3.1 ■ 56 H	N3.2 ■ 33 I	N3.3 ■ 17 G	N4.1 ■ 30 J	N4.2 ■ 28 H	N4.3 ■ 14 F	S1.1 ■ 24 F	S1.2 ■ 13 D	S1.3 ■ 7 B	S2.1 ■ 7 E	S2.2 ■ 6 A	S3.1 ■ 5 E	S3.2 ■ 4 A
S4.1 ■ 4 E	S4.2 ■ 3 A												

Produkter från den här serien finns även i set. Se A296

Product	Nr.	DC (inch)	DC (inch)	SDL_1 (inch)	OAL (inch)	DCON MS (inch)
A225BS1	BS1	3/64	0.0469	5/64 - 1/16	1.1/2	1/8
A225BS2	BS2	1/16	0.0625	3/32 - 5/64	1.3/4	3/16
A225BS3	BS3	3/32	0.0938	5/32 - 1/8	2"	1/4
A225BS4	BS4	1/8	0.1250	3/16 - 5/32	2.1/4	5/16
A225BS5	BS5	3/16	0.1875	9/32 - 1/4	2.1/2	7/16
A225BS5A	BS5A	7/32	0.2188	5/16 - 9/32	2.3/4	1/2
A225BS6	BS6	1/4	0.2500	3/8 - 5/16	3"	5/8
A225BS7	BS7	5/16	0.3125	15/32 - 13/32	3.1/2	3/4

A242



Lång dubbhålsborr av HSS-E (5% Kobolt), 118° spets, 60° försänkning, blank

Används till att borra dubbhål i axeländar för att kunna spänna in dem för vidare bearbetning. Dubbhålsborren har skär i båda ändarna för bättre ekonomi. Går att använda i de flesta material.

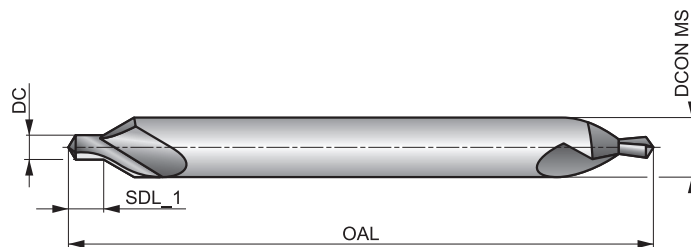

HSS-E		1xD
60°	Bright	
R	118°	

Arbetsmaterialgrupper och startvärden för skärhastighet (m/min) och matningskod. Tabeller med matningar finns med början på sidan 274

P1.1 ■ 33 I	P1.2 ■ 37 I	P1.3 ■ 38 I	P2.1 ■ 28 I	P2.2 ■ 25 G	P2.3 ▣ 22 E	P3.1 ■ 19 F	P3.2 ■ 15 F	P3.3 ▣ 13 E	P4.1 ■ 11 F	P4.2 ▣ 10 E	P4.3 ▣ 8 D	M1.1 ▣ 21 E	M1.2 ▣ 17 E
M2.1 ▣ 18 E	M2.2 ▣ 15 E	M3.1 ▣ 19 G	M3.2 ▣ 8 G	M3.3 ▣ 7 G	M4.1 ▣ 10 C	K1.1 ■ 30 I	K1.2 ■ 22 F	K1.3 ■ 17 F	K2.1 ▣ 25 E	K2.2 ▣ 20 E	K2.3 ▣ 16 E	K3.1 ▣ 22 E	K3.2 ▣ 17 E
K3.3 ▣ 13 E	K4.1 ▣ 20 E	K4.2 ▣ 15 E	K4.3 ▣ 11 E	K4.4 ▣ 10 E	K4.5 ▣ 8 E	K5.1 ▣ 23 E	K5.2 ▣ 17 E	K5.3 ▣ 13 E	N1.1 ▣ 33 J	N1.2 ▣ 25 J	N1.3 ▣ 17 I	N2.1 ▣ 42 H	N2.2 ▣ 37 H
N2.3 ▣ 27 H	N3.1 ▣ 56 H	N3.2 ▣ 33 I	N3.3 ▣ 17 G	N4.1 ▣ 30 J	N4.2 ▣ 28 H	N4.3 ▣ 14 F	S1.1 ▣ 24 F	S1.2 ▣ 13 D	S1.3 ▣ 7 B	S2.1 ▣ 7 E	S2.2 ▣ 6 A	S3.1 ▣ 5 E	S3.2 ▣ 4 A
S4.1 ▣ 4 E	S4.2 ▣ 3 A												

Product	DC	DC	SDL_1	OAL	DCON MS
	(mm)	(inch)			
A2421.0X4.0	1.00	0.0394	1.7 - 1.3	100.0	4.00
A2421.5X5.0	1.50	0.0591	2.6 - 2.0	100.0	5.00
A2422.0X6.0	2.00	0.0787	3.1 - 2.5	100.0	6.00
A2422.5X8.0	2.50	0.0984	3.8 - 3.1	100.0	8.00
A2423.0X8.0	3.00	0.1181	4.6 - 3.9	100.0	8.00
A2423.0X10.0	3.00	0.1181	4.6 - 3.9	100.0	10.00
A2424.0X10.0	4.00	0.1575	5.9 - 5.0	100.0	10.00
A2424.0X12.0	4.00	0.1575	5.9 - 5.0	100.0	12.00
A2425.0X12.0	5.00	0.1969	7.2 - 6.3	100.0	12.00

R200

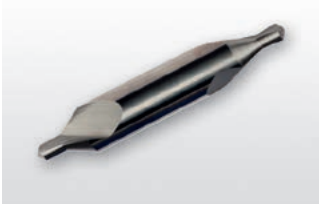

Dubbhålsborr av solid HM med 118° spets och 60° försänkning, blank

Används till att borra dubbhål i axeländar för att kunna spänna in dem för vidare bearbetning. Dubbhålsborren har skär i båda ändarna för bättre ekonomi. För användning i CNC-maskiner. Går att använda i de flesta material.

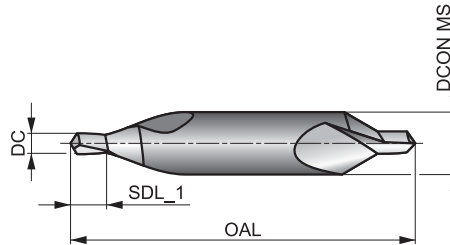

HM	DIN 333A	1xD
60°	Bright	
R		

Arbetsmaterialgrupper och startvärden för skärhastighet (m/min) och matningskod. Tabeller med matningar finns med början på sidan 274

P1.1 ■ 60 H	P1.2 ■ 67 H	P1.3 ■ 69 H	P2.1 ■ 51 H	P2.2 ■ 45 F	P2.3 ■ 40 D	P3.1 ■ 44 E	P3.2 ■ 36 E	P3.3 ■ 30 D	P4.1 ■ 26 E	P4.2 ■ 22 D	P4.3 ■ 18 C	K1.1 ■ 40 H	K1.2 ■ 30 E
K1.3 ■ 22 E	K2.1 ■ 37 D	K2.2 ■ 30 D	K2.3 ■ 24 D	K3.1 ■ 33 D	K3.2 ■ 25 D	K3.3 ■ 20 D	K4.1 ■ 30 D	K4.2 ■ 23 D	K4.3 ■ 17 D	K4.4 ■ 14 D	K4.5 ■ 12 D	K5.1 ■ 34 D	K5.2 ■ 26 D
K5.3 ■ 20 D	N1.1 ■ 120 I	N1.2 ■ 90 I	N1.3 ■ 60 H	N2.1 ■ 154 G	N2.2 ■ 138 G	N2.3 ■ 100 G	N3.1 ■ 169 G	N3.2 ■ 100 H	N3.3 ■ 50 F				

Product	DC	DC	SDL_1	OAL	DCON MS
	(mm)	(inch)			
R2001.0X3.15	1.00	0.0394	1.7 - 1.3	31.0	3.15
R2001.25X3.15	1.25	0.0492	2.0 - 1.6	31.0	3.15
R2001.6X4.0	1.60	0.0630	2.6 - 2.0	35.0	4.00
R2002.0X5.0	2.00	0.0787	3.1 - 2.5	40.0	5.00
R2002.5X6.3	2.50	0.0984	3.8 - 3.1	45.0	6.30
R2003.15X8.0	3.15	0.1240	4.6 - 3.9	50.0	8.00
R2004.0X10.0	4.00	0.1575	5.9 - 5.0	55.0	10.00
R2005.0X12.5	5.00	0.1969	7.2 - 6.3	63.0	12.50

A296



Sats med dubbhålsborrar av HSS

Sats med fem dubbhålsborrar i praktisk plastask. För borring av dubbhål i axlar. Borrarna har skär i båda ändarna.

A296200 - 118° spets DIN333A, A296225 - 120° spets BS328. A=ingående produkt, B=antal i satsen, C=diametrar i satsen.

Product	Nr.	A	B	C
A296200	200	A200	5	1.00 mm, 2.00 mm, 2.50 mm, 3.15 mm, 4.00 mm
A296225	225	A225	5	BS1, BS2, BS3, BS4, BS5

Verktygsmaterial (BMC)		HSS	HSS-E	HSS	HSS-E	HM	HSS	HSS	HSS	HSS
Beläggning		TIN	Bright	TIAIN	ALTiCN	Bright	TIAIN	Bright	Bright	TIN
Standard (BSG)		DIN 334C	DORMER	DIN 335C	DIN 335C	DIN 335C	DIN 335C	DIN 334D	DIN 335D	DIN 335D
Skärriktning										
Skaft										
Spetsvinkel		60°	90°	90°	90°	90°	100°	60°	90°	90°
Produktfamilj		G335	G149	G560	G570	G400	G171	G137	G138	G338
PSF skärdiametrar		6.30 - 25.00	5.00 - 25.00	6.30 - 31.00	6.30 - 31.00	6.30 - 31.00	6.30 - 25.00	31.50 - 50.00	25.00 - 63.00	25.00 - 50.00
		158	159	160	161	162	163	164	165	166
P	P1	■	■	■	▣	■	■	■	■	■
	P2	■	■	■	▣	■	■	■	■	■
	P3	■	■	■	■	■	■	▣	▣	■
	P4	■	■	■	■	■	■	▣	▣	■
M	M1	▣	▣	▣	■	■	▣	▣	▣	▣
	M2	▣	▣	▣	■	▣	▣	▣	▣	▣
	M3	▣	■	■	■	▣	▣	▣	▣	▣
	M4	■	■	■	▣	▣	■	■	■	■
K	K1	■	▣	■	■	■	■	▣	▣	■
	K2	■	▣	■	■	■	■	▣	▣	■
	K3	■	▣	■	■	■	■	▣	▣	■
	K4	▣	■	▣	▣	■	▣	■	■	▣
	K5	■	▣	■	■	■	■	▣	▣	■
N	N1	■	■	▣	▣	■	▣	▣	▣	■
	N2	■	▣	■	▣	■	■	▣	▣	■
	N3	■	■	■	▣	■	■	■	■	■
	N4	▣	▣	▣	■	■	▣	▣	▣	▣
	N5	■	■	■	■	■	■	■	■	■
S	S1	■	■	■	■	■	■	■	■	■
	S2	■	■	■	■	▣	■	■	■	■
	S3	■	■	■	■	▣	■	■	■	■
	S4	■	■	■	■	▣	■	■	■	■
H	H1	■	■	■	■	■	■	■	■	■
	H2	■	■	■	■	■	■	■	■	■
	H3	■	■	■	■	▣	■	■	■	■
	H4	■	■	■	■	▣	■	■	■	■

G335

DORMER



Försänkare av HSS med cyl. skaft, 60°, TiN-belagd

En 60° försänkare för försänkning och gradning av hål. TiN-belagd för längre livslängd. Mångsidigt verktyg som är användbar i de flesta material.

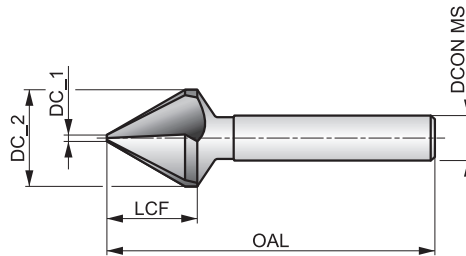

HSS	TiN	DIN 334C
R	ISO 513	60°

Arbetsmaterialgrupper och startvärden för skärhastighet (m/min) och matningskod. Tabeller med matningar finns med början på sidan 280

P1.1 ■ 33 E	P1.2 ■ 37 E	P1.3 ■ 38 E	P2.1 ■ 28 E	P2.2 ■ 25 D	P2.3 ■ 22 B	P3.1 ■ 23 D	P3.2 ■ 18 D	P3.3 ■ 15 B	P4.1 ■ 13 D	P4.2 ■ 11 B	P4.3 ▧ 9 B	M1.1 ▧ 10 C	M1.2 ▧ 8 C
M2.1 ▧ 9 C	M3.1 ▧ 8 B	K1.1 ■ 34 F	K1.2 ■ 25 D	K1.3 ▧ 19 D	K2.1 ■ 35 C	K2.2 ■ 28 C	K2.3 ▧ 23 C	K3.1 ■ 31 C	K3.2 ■ 24 C	K3.3 ▧ 19 C	K4.1 ▧ 29 C	K4.2 ▧ 22 C	K4.3 ▧ 16 C
K5.1 ■ 32 C	K5.2 ■ 24 C	K5.3 ▧ 19 C	N1.1 ■ 53 G	N1.2 ■ 40 G	N1.3 ■ 27 F	N2.1 ■ 27 F	N2.2 ■ 24 F	N2.3 ■ 17 F	N3.1 ■ 28 F	N3.2 ■ 16 F	N3.3 ▧ 8 D	N4.1 ▧ 58 G	N4.2 ▧ 50 G

DCON MS tolerans h9.

Product	DC_2 (mm)	DC_1 (mm)	LCF (mm)	OAL (mm)	DCON MS (mm)	NOF
G3356.3	6.30	1.60	6.8	45.0	5.00	3
G3358.0	8.00	2.00	8.5	50.0	6.00	3
G33510.0	10.00	2.50	7.6	50.0	6.00	3
G33512.5	12.50	3.20	11.7	56.0	8.00	3
G33516.0	16.00	4.00	14.5	63.0	10.00	3
G33520.0	20.00	5.00	17.5	67.0	10.00	3
G33525.0	25.00	6.30	20.5	71.0	10.00	3

G149



Försänkare av HSS, 90°, cylindriskt skaft, enskärig, blank

En 90° enskärig försänkare för försänkning och gradning av hål. Blankt, mångsidigt verktyg. Användbar i flertalet material.

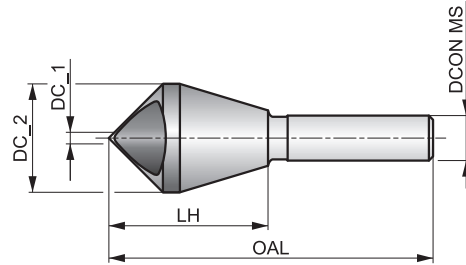

HSS-E	Bright	DORMER
R	Blank	90°

Arbetsmaterialgrupper och startvärden för skärhastighet (m/min) och matningskod. Tabeller med matningar finns med början på sidan 280

P1.1 ▣21 D	P1.2 ▣24 D	P1.3 ▣25 D	P2.1 ▣18 D	P2.2 ▣16 C	P2.3 ▣14 A	P3.1 ▣16 B	P3.2 ▣13 B	M1.1 ▣8 B	M1.2 ▣6 B	M2.1 ▣7 B	K1.1 ▣18 D	K2.1 ▣19 A	K3.1 ▣16 A
K5.1 ▣14 A	N1.1 ▣34 D	N1.2 ▣25 D	N1.3 ▣16 C	N2.1 ▣16 C	N2.2 ▣14 C	N3.1 ▣17 C	N3.2 ▣9 C	N3.3 ▣5 B	N4.1 ▣17 D	N4.2 ▣5 D			

Product	DC_2 (mm)	DC_1 (mm)	LH (mm)	OAL (mm)	DCON MS (mm)	DC (mm)	NOF
G1495	5.00	2.00	19.0	45.0	6.00	10.00	1
G14910	10.00	5.00	23.0	48.0	8.00	14.00	1
G14915	15.00	10.00	34.0	65.0	10.00	21.00	1
G14920	20.00	15.00	43.0	84.0	12.00	28.00	1
G14925	25.00	20.00	48.0	102.0	15.00	35.00	1

G560

DORMER



Försänkare av HSS, 90°, cylindriskt skaft, TiAIN-belagd

En 90° försänkare för försänkning och gradning av hål. Ett mångsidigt verktyg med TiAIN-beläggning som förlänger livslängden. Användbar i flertalet material.

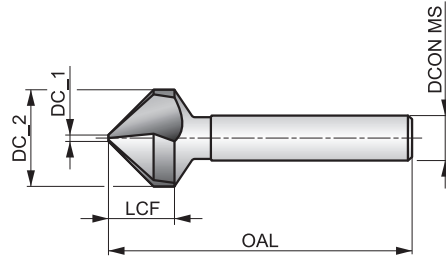

HSS	TiAIN	DIN 335C
R	90°	

Arbetsmaterialgrupper och startvärden för skärhastighet (m/min) och matningskod. Tabeller med matningar finns med början på sidan 280

P1.1 ■ 40 E	P1.2 ■ 45 E	P1.3 ■ 46 E	P2.1 ■ 34 E	P2.2 ■ 30 D	P2.3 ■ 27 B	P3.1 ■ 28 D	P3.2 ■ 22 D	P3.3 ■ 19 B	P4.1 ■ 16 D	P4.2 ■ 14 B	P4.3 ■ 11 B	M1.1 ■ 11 C	M1.2 ■ 9 C
M2.1 ■ 10 C	M2.2 ■ 19 C	M2.3 ■ 8 B	K1.1 ■ 41 F	K1.2 ■ 30 D	K1.3 ■ 23 D	K2.1 ■ 42 C	K2.2 ■ 34 C	K2.3 ■ 27 C	K3.1 ■ 37 C	K3.2 ■ 28 C	K3.3 ■ 23 C	K4.1 ■ 34 C	K4.2 ■ 26 C
K4.3 ■ 19 C	K5.1 ■ 39 C	K5.2 ■ 29 C	K5.3 ■ 23 C	N1.1 ■ 60 G	N1.2 ■ 45 G	N1.3 ■ 30 F	N2.1 ■ 30 F	N2.2 ■ 27 F	N2.3 ■ 19 F	N3.1 ■ 32 F	N3.2 ■ 18 F	N3.3 ■ 19 D	N4.1 ■ 62 G
N4.2 ■ 55 G													

DCON MS tolerans h9.

Produkter från den här serien finns även i set. Se G236

Product	DC_2 (mm)	DC_1 (mm)	LCF (mm)	OAL (mm)	DCON MS (mm)	NOF
G5606.3	6.30	1.50	5.5	45.0	5.00	3
G5608.0	8.00	2.00	6.1	50.0	6.00	3
G5608.3	8.30	2.00	6.5	50.0	6.00	3
G56010.0	10.00	2.50	7.6	50.0	6.00	3
G56010.4	10.40	2.50	7.6	50.0	6.00	3
G56012.4	12.40	2.80	8.5	56.0	8.00	3
G56016.5	16.50	3.20	10.5	60.0	10.00	3
G56020.5	20.50	3.50	13.0	63.0	10.00	3
G56025.0	25.00	3.80	15.5	67.0	10.00	3
G56031.0	31.00	4.20	18.5	71.0	12.00	3

G570

DORMER



Försänkare av HSS, 90°, cylindriskt skaft, AlTiCN-belagd

En 90° försänkare för försänkning och gradning av hål. AlTiCN-beläggningen gör den användbar i hårda och slitande material.

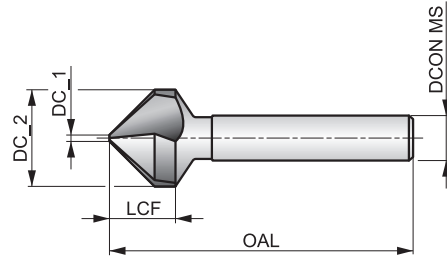

HSS-E	AlTiCN	DIN 335C
R	90°	

Arbetsmaterialgrupper och startvärden för skärhastighet (m/min) och matningskod. Tabeller med matningar finns med början på sidan 280

P1.1 ■ 40 E	P1.2 ■ 45 E	P1.3 ■ 46 E	P2.1 ■ 34 E	P2.2 ■ 30 D	P2.3 ■ 27 B	P3.1 ■ 28 D	P3.2 ■ 22 D	P3.3 ■ 19 B	P4.1 ■ 16 D	P4.2 ■ 14 B	P4.3 ■ 11 B	M1.1 ■ 23 C	M1.2 ■ 20 C
M2.1 ■ 21 C	M2.2 ■ 17 C	M2.3 ■ 14 A	M3.1 ■ 14 B	M3.2 ■ 12 B	M3.3 ■ 11 B	M4.1 ■ 15 A	M4.2 ■ 13 A	K1.1 ■ 41 C	K1.2 ■ 30 C	K1.3 ■ 23 C	K2.1 ■ 42 C	K2.2 ■ 34 C	K2.3 ■ 27 C
K3.1 ■ 37 C	K3.2 ■ 28 C	K3.3 ■ 23 C	K4.1 ■ 34 C	K4.2 ■ 26 C	K4.3 ■ 19 C	K5.1 ■ 39 C	K5.2 ■ 29 C	K5.3 ■ 23 C	N1.1 ■ 60 G	N1.2 ■ 45 G	N1.3 ■ 30 F	N2.1 ■ 30 F	N2.2 ■ 27 F
N2.3 ■ 19 F	N3.1 ■ 32 F	N3.2 ■ 18 F	N3.3 ■ 9 D										

DCON MS tolerans h9.

Product	DC_2 (mm)	DC_1 (mm)	LCF (mm)	OAL (mm)	DCON MS (mm)	NOF
G5706.3	6.30	1.50	6.5	45.0	5.00	3
G5708.3	8.30	2.00	8.2	50.0	6.00	3
G57010.4	10.40	2.50	9.7	50.0	6.00	3
G57012.4	12.40	2.80	10.6	56.0	8.00	3
G57016.5	16.50	3.20	13.9	60.0	10.00	3
G57020.5	20.50	3.50	17.1	63.0	10.00	3
G57025.0	25.00	3.80	21.4	67.0	10.00	3
G57031.0	31.00	4.20	24.4	71.0	12.00	3

G400

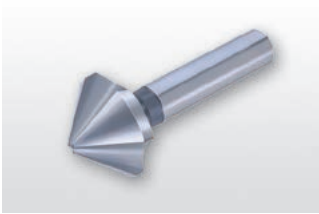

Försänkare av HM med cyl. skaft, 90°, Blank

Blank hårdmetallförsänkare, 90°, för användning i CNC-maskiner där hög produktivitet och kvalitet erfordras. Kan användas i hårda och slitande material.

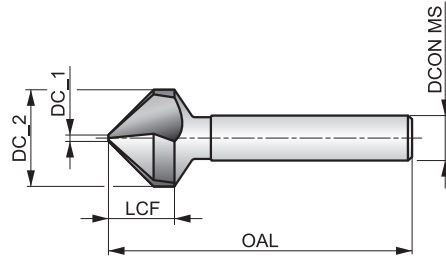

HM	Bright	DIN 335C
R	Standard	90°

Arbetsmaterialgrupper och startvärden för skärhastighet (m/min) och matningskod. Tabeller med matningar finns med början på sidan 280

P1.1 ■ 64 E	P1.2 ■ 72 E	P1.3 ■ 74 E	P2.1 ■ 55 E	P2.2 ■ 48 D	P2.3 ■ 43 B	P3.1 ■ 45 D	P3.2 ■ 36 D	P3.3 ■ 30 B	P4.1 ■ 26 D	P4.2 ■ 23 B	P4.3 ■ 18 A	M1.1 ■ 24 C	M1.2 ■ 21 C
M2.1 ■ 22 C	M2.2 ▧ 18 C	M2.3 ▧ 15 B	M3.1 ■ 20 B	M3.2 ▧ 17 B	M3.3 ▧ 15 B	M4.1 ▧ 15 A	M4.2 ▧ 13 A	K1.1 ■ 45 F	K1.2 ■ 33 D	K1.3 ■ 25 D	K2.1 ■ 46 C	K2.2 ■ 37 C	K2.3 ▧ 30 C
K3.1 ■ 41 C	K3.2 ■ 31 C	K3.3 ▧ 25 C	K4.1 ■ 38 C	K4.2 ■ 28 C	K4.3 ■ 21 C	K4.4 ▧ 18 C	K4.5 ▧ 15 C	K5.1 ■ 43 C	K5.2 ■ 32 C	K5.3 ■ 25 C	N1.1 ▧ 75 G	N1.2 ■ 55 G	N1.3 ■ 40 F
N2.1 ■ 40 F	N2.2 ■ 36 F	N2.3 ■ 26 F	N3.1 ■ 42 F	N3.2 ■ 25 F	N3.3 ▧ 13 D	N4.3 ■ 17 E	S1.1 ■ 12 C	S1.2 ■ 10 A	S1.3 ▧ 9 A	S2.1 ■ 8 B	S2.2 ▧ 7 A	S3.1 ■ 6 B	S3.2 ▧ 5 A
S4.1 ■ 5 B	S4.2 ▧ 4 A	H1.1 ■ 12 A	H2.1 ■ 7 A	H2.2 ▧ 6 B	H3.1 ■ 8 A	H3.2 ▧ 7 B	H4.1 ■ 5 A	H4.2 ▧ 4 B					

DCON MS tolerans h6.

Product	DC_2 (mm)	DC_1 (mm)	LCF (mm)	OAL (mm)	DCON MS (mm)	NOF
G4006.3	6.30	1.50	5.0	45.0	5.00	3
G4008.3	8.30	2.00	6.0	50.0	6.00	3
G40010.4	10.40	2.50	7.1	50.0	6.00	3
G40012.4	12.40	2.80	8.0	56.0	8.00	3
G40016.5	16.50	3.20	10.0	60.0	10.00	3
G40020.5	20.50	3.50	12.5	63.0	10.00	3
G40025.0	25.00	3.80	15.0	67.0	10.00	3
G40031.0	31.00	4.20	18.0	71.0	12.00	3

G171

DORMER



Försänkare av HSS, 100°, cylindriskt skaft, TiAlN-belagd

En 100° försänkare för försänkning och gradning av hål. Ett mångsidigt verktyg med TiAlN-beläggning som förlänger livslängden. Användbar i flertalet material.

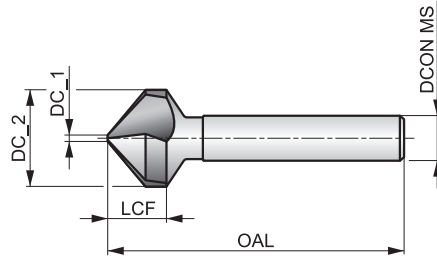

HSS		DIN 335C
		100°

Arbetsmaterialgrupper och startvärden för skärhastighet (m/min) och matningskod. Tabeller med matningar finns med början på sidan 280

P1.1 ■ 40 E	P1.2 ■ 45 E	P1.3 ■ 46 E	P2.1 ■ 34 E	P2.2 ■ 30 D	P2.3 ■ 27 B	P3.1 ■ 28 D	P3.2 ■ 22 D	P3.3 ■ 19 B	P4.1 ■ 16 D	P4.2 ■ 14 B	P4.3 ▣ 11 B	M1.1 ▣ 11 C	M1.2 ▣ 9 C
M2.1 ▣ 10 C	K1.1 ■ 41 F	K1.2 ■ 30 D	K1.3 ▣ 23 D	K2.1 ■ 42 C	K2.2 ■ 34 C	K2.3 ▣ 27 C	K3.1 ■ 37 C	K3.2 ■ 28 C	K3.3 ▣ 23 C	K4.1 ▣ 34 C	K4.2 ▣ 26 C	K4.3 ▣ 19 C	K5.1 ■ 39 C
K5.2 ■ 29 C	K5.3 ▣ 23 C	N1.1 ▣ 60 G	N1.2 ▣ 45 G	N1.3 ■ 30 F	N2.1 ■ 30 F	N2.2 ■ 27 F	N2.3 ■ 19 F	N3.1 ■ 32 F	N3.2 ■ 18 F	N3.3 ▣ 9 D	N4.1 ▣ 62 G	N4.2 ▣ 55 G	

DCON MS tolerans h9.

Product	DC_2 (mm)	DC_1 (mm)	LCF (mm)	OAL (mm)	DCON MS (mm)	NOF
G1716.3	6.30	1.50	4.5	44.0	5.00	3
G1718.3	8.30	2.00	5.5	49.0	6.00	3
G17110.4	10.40	2.50	6.6	49.0	6.00	3
G17112.4	12.40	2.80	7.0	53.0	8.00	3
G17116.5	16.50	3.20	9.0	56.0	10.00	3
G17120.5	20.50	3.50	11.0	61.0	10.00	3
G17125.0	25.00	3.80	13.5	65.0	10.00	3

G137



Försänkare av HSS med Morse-konskaft, 60°, blank

Blank försänkare med 60° försänkingsvinkel för försänkning och gradning av förborrade hål i de flesta materialtyper. Morse-konfäste för inspänning direkt i maskinspindel.

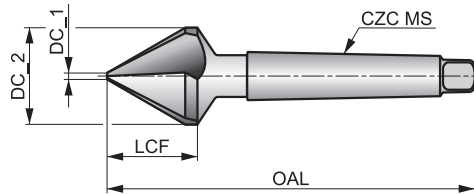

HSS	Bright	DIN 334D
R		60°

Arbetsmaterialgrupper och startvärden för skärhastighet (m/min) och matningskod. Tabeller med matningar finns med början på sidan 280

P1.1 ■ 23 E	P1.2 ■ 26 E	P1.3 ■ 27 E	P2.1 ■ 20 E	P2.2 ■ 18 D	P2.3 ▣ 16 B	P3.1 ■ 16 D	P3.2 ▣ 13 D	P3.3 ▣ 11 B	P4.1 ■ 10 D	P4.2 ▣ 8 B	M1.1 ▣ 8 C	M1.2 ▣ 16 C	M2.1 ▣ 17 C
M2.2 ▣ 16 C	K1.1 ▣ 20 F	K1.2 ▣ 15 D	K2.1 ▣ 21 C	K2.2 ▣ 17 C	K3.1 ▣ 18 C	K3.2 ▣ 14 C	K5.1 ▣ 19 C	K5.2 ▣ 15 C	N1.1 ▣ 40 G	N1.2 ■ 30 G	N1.3 ▣ 20 F	N2.1 ■ 20 F	N2.2 ▣ 18 F
N3.1 ■ 21 F	N3.2 ■ 12 F	N3.3 ▣ 16 D	N4.1 ▣ 40 G	N4.2 ▣ 35 G									

Product	DC_2 (mm)	DC_1 (mm)	LCF (mm)	OAL (mm)	CZC MS	NOF
G13731.5	31.50	10.00	23.0	118.0	MK 2	3
G13740.0	40.00	12.50	28.5	150.0	MK 3	3
G13750.0	50.00	16.00	36.0	160.0	MK 3	3

G138

DORMER



Försänkare av HSS, 90°, koniskt skaft, blank

En 90° försänkare med MK-fäste, för försänkning och gradning av hål. Blankt, mångsidigt verktyg. Användbar i flertalet material.

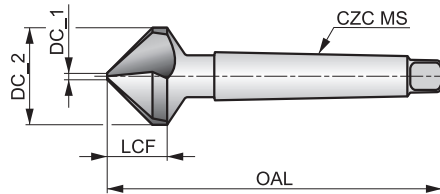

HSS	Bright	DIN 335D
R		90°

Arbetsmaterialgrupper och startvärden för skärhastighet (m/min) och matningskod. Tabeller med matningar finns med början på sidan 280

P1.1 ■ 23 E	P1.2 ■ 26 E	P1.3 ■ 27 E	P2.1 ■ 20 E	P2.2 ■ 18 D	P2.3 ▣ 16 B	P3.1 ■ 16 D	P3.2 ▣ 13 D	P3.3 ▣ 11 B	P4.1 ■ 10 D	P4.2 ▣ 8 B	M1.1 ▣ 8	M1.2 ▣ 6	M2.1 ▣ 7
M2.2 ▣ 6	K1.1 ▣ 20 F	K1.2 ▣ 15 D	K2.1 ▣ 21 C	K2.2 ▣ 17 C	K3.1 ▣ 18 C	K3.2 ▣ 14 C	K5.1 ▣ 19 C	K5.2 ▣ 15 C	N1.1 ▣ 40 G	N1.2 ■ 30 G	N1.3 ▣ 20 F	N2.1 ■ 20 F	N2.2 ▣ 18 F
N3.1 ■ 21 F	N3.2 ■ 12 F	N3.3 ▣ 16 D	N4.1 ▣ 40 G	N4.2 ▣ 35 G									

Product	DC_2 (mm)	DC_1 (mm)	LCF (mm)	OAL (mm)	CZC MS	NOF
G13825.0	25.00	3.80	15.5	106.0	MK 2	3
G13830.0	30.00	4.20	18.5	112.0	MK 2	3
G13831.0	31.00	4.20	20.0	112.0	MK 2	3
G13834.0	34.00	4.50	19.5	118.0	MK 2	3
G13837.0	37.00	4.80	21.7	118.0	MK 2	3
G13840.0	40.00	10.00	20.5	140.0	MK 3	3
G13850.0	50.00	14.00	24.1	150.0	MK 3	3
G13863.0	63.00	16.00	28.5	180.0	MK 4	3

G338

DORMER

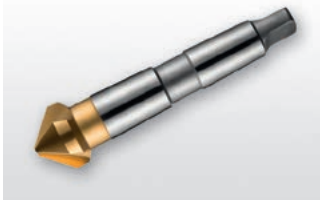

Försänkare av HSS, 90°, koniskt skaft, TiN-belagd

En 90° försänkare med MK-fäste, för försänkning och gradning av hål. TiN-belagt, mångsidigt verktyg. Användbar i flertalet material.

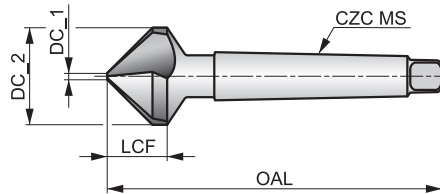

HSS	TiN	DIN 335D
R		90°

Arbetsmaterialgrupper och startvärden för skärhastighet (m/min) och matningskod. Tabeller med matningar finns med början på sidan 280

P1.1 ■ 33 E	P1.2 ■ 37 E	P1.3 ■ 38 E	P2.1 ■ 28 E	P2.2 ■ 25 D	P2.3 ■ 22 B	P3.1 ■ 23 D	P3.2 ■ 18 D	P3.3 ■ 15 B	P4.1 ■ 13 D	P4.2 ■ 11 B	P4.3 ▧ 9 B	M1.1 ▧ 11 C	M1.2 ▧ 9 C
M2.1 ▧ 10 C	M2.2 ▧ 19 C	M2.3 ▧ 8 B	K1.1 ■ 34 F	K1.2 ■ 25 D	K1.3 ▧ 19 D	K2.1 ■ 35 C	K2.2 ■ 28 C	K2.3 ▧ 23 C	K3.1 ■ 31 C	K3.2 ■ 24 C	K3.3 ▧ 19 C	K4.1 ▧ 29 C	K4.2 ▧ 22 C
K4.3 ▧ 16 C	K5.1 ■ 32 C	K5.2 ■ 24 C	K5.3 ▧ 19 C	N1.1 ■ 53 G	N1.2 ■ 40 G	N1.3 ■ 27 F	N2.1 ■ 27 F	N2.2 ■ 24 F	N2.3 ■ 17 F	N3.1 ■ 28 F	N3.2 ■ 16 F	N3.3 ▧ 18 D	N4.1 ▧ 58 G
N4.2 ▧ 50 G													

Product	DC_2 (mm)	DC_1 (mm)	LCF (mm)	OAL (mm)	CZC MS	NOF
G33825.0	25.00	3.80	15.5	106.0	MK 2	3
G33831.0	31.00	4.20	20.0	112.0	MK 2	3
G33837.0	37.00	4.80	21.7	118.0	MK 2	3
G33840.0	40.00	10.00	20.5	140.0	MK 3	3
G33850.0	50.00	14.00	24.1	150.0	MK 3	3

Verktygsmaterial (BMC)	HSS-E	HSS-E	HSS-E	HSS-E	HSS-E	HSS-E	HSS	HSS											
Beläggning	Bright ST	Bright	Bright	Bright	Bright ST	Bright	Bright ST	ST											
Standard (BSG)	BS 328	DIN 212	DIN 212	DIN 208	BS 328	DIN 2180	DIN 311	ANSI											
Skärriktning																			
Skaft																			
Brottschform	B	B	B	B	B														
Nåbar håltolerans (TCHA)	H7	H7	$\begin{matrix} \phi 95-5.5 \\ +0.004 \\ \phi 5.51-12 \\ +0.005 \end{matrix}$	H7	H7			k11											
Konicitet - millimeter						1:50													
Produktfamilj	B901	B180	B170	B161	B101	B954	B121	B640											
PSF skärdiameter	1.50 - 1/2	1.50 - 20.00	1.00 - 12.00	3.00 - 50.00	3.00 - 50.00	8.00 - 30.00	12.00 - 25.00	7/16 - 1.1/16											
	168	169	171	173	174	175	176	177											
P	P1	■	■	■	■	■	■	■											
	P2	■	■	■	■	■	■	■											
	P3	■	■	■	■	■	■	■											
	P4	▣	▣	▣	▣	▣	▣	▣	▣										
M	M1	▣	▣	▣	▣	▣	▣	▣											
	M2	▣	▣	▣	▣	▣	▣	▣											
	M3																		
	M4																		
K	K1	■	■	■	■	■	■	■											
	K2	■	■	■	■	■	■	■											
	K3	▣	▣	▣	▣	▣	▣	▣	▣										
	K4																		
	K5																		
N	N1	■	■	■	■	■	■	■											
	N2	■	■	■	■	■	■	■											
	N3	■	■	■	■	■	■	■											
	N4	▣	▣	▣	▣	▣	▣	▣	▣										
	N5																		
S	S1																		
	S2																		
	S3																		
	S4																		
H	H1																		
	H2																		
	H3																		
	H4																		

B901



Maskinbrotsch av HSS-E, för H7-tolerans, blank och ånganlöpt

Tillverkad enligt BS 328-standard. Precisionslipade vänsterspiralskår. Blank med ånganlöpta spår. Går att använda i de flesta material.

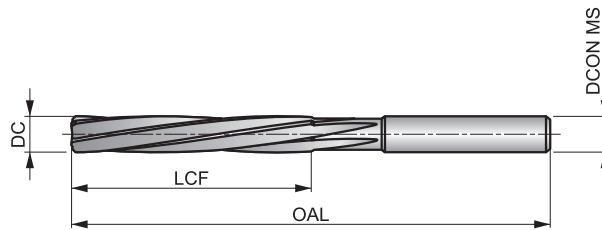

HSS-E	Bright ST	BS 328
R		B
H7		

Arbetsmaterialgrupper och startvärden för skärhastighet (m/min) och matningskod. Tabeller med matningar finns med början på sidan 279

P1.1 ■ 15 C	P1.2 ■ 16 C	P1.3 ■ 17 C	P2.1 ■ 13 C	P2.2 ■ 11 C	P2.3 ■ 10 B	P3.1 ■ 7 B	P3.2 ■ 6 B	P3.3 ■ 5 B	P4.1 ■ 4 B	P4.2 ■ 4 B	P4.3 ■ 3 A	M1.1 ■ 10 C	M1.2 ■ 8 C
M2.1 ■ 9 C	K1.1 ■ 14 E	K1.2 ■ 10 D	K1.3 ■ 8 D	K2.1 ■ 12 C	K2.2 ■ 10 C	K2.3 ■ 8 C	K3.1 ■ 11 C	K3.2 ■ 8 C	N1.1 ■ 23 F	N1.2 ■ 17 F	N1.3 ■ 12 F	N2.1 ■ 25 E	N2.2 ■ 22 E
N2.3 ■ 14 E	N3.1 ■ 34 D	N3.2 ■ 20 E	N3.3 ■ 10 D	N4.1 ■ 22 B	N4.2 ■ 21 B								

Product	DC (inch)	DC (mm)	OAL (mm)	LCF (mm)	NOF (mm)	DCON MS (mm)
B9011.5	–	1.50	44.0	21.0	4	1.50
B9012.0	–	2.00	50.0	25.0	4	2.00
B9013/32	3/32	2.38	58.0	29.0	4	2.38
B9012.5	–	2.50	58.0	29.0	4	2.50
B9013.0	–	3.00	62.0	31.0	4	3.00
B9011/8	1/8	3.18	66.0	33.0	4	3.18
B9015/32	5/32	3.97	76.0	38.0	6	3.97
B9014.0	–	4.00	76.0	38.0	6	4.00
B9013/16	3/16	4.76	87.0	44.0	6	4.76
B9015.0	–	5.00	87.0	44.0	6	5.00
B90115/64	15/64	5.95	93.0	47.0	6	5.95
B9016.0	–	6.00	93.0	47.0	6	6.00

Product	DC (inch)	DC (mm)	OAL (mm)	LCF (mm)	NOF (mm)	DCON MS (mm)
B9011/4	1/4	6.35	100.0	50.0	6	6.35
B9017.0	–	7.00	107.0	54.0	6	7.00
B9019/32	9/32	7.14	107.0	54.0	6	7.14
B9015/16	5/16	7.94	115.0	58.0	6	7.94
B9018.0	–	8.00	115.0	58.0	6	8.00
B9019.0	–	9.00	124.0	62.0	6	9.00
B9013/8	3/8	9.52	133.0	66.0	6	9.52
B90110.0	–	10.00	133.0	66.0	6	10.00
B90111.0	–	11.00	142.0	71.0	6	11.00
B9017/16	7/16	11.11	142.0	71.0	6	11.11
B90112.0	–	12.00	152.0	76.0	6	12.00
B9011/2	1/2	12.70	152.0	76.0	6	12.70

B180



Maskinbrotsch av HSS-E för H7-tolerans, blank

NC-brotsch för CNC-maskiner. Precisionslipat skaft för inspänning i precisionschuck. Högerroterande med vänsterspiralspår. Blank.

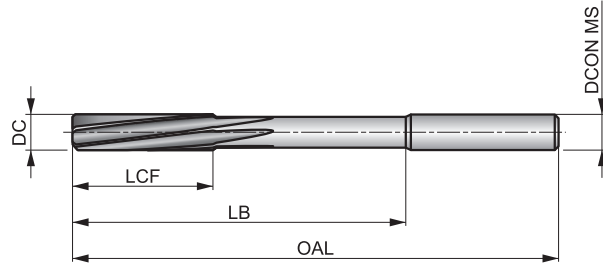

HSS-E	Bright	DIN 212
R	DIN 6535HA	B
H7		

Arbetsmaterialgrupper och startvärden för skärhastighet (m/min) och matningskod. Tabeller med matningar finns med början på sidan 279

P1.1 ■ 21 C	P1.2 ■ 24 C	P1.3 ■ 25 C	P2.1 ■ 18 C	P2.2 ■ 16 C	P2.3 ▣ 14 B	P3.1 ■ 13 B	P3.2 ■ 11 B	P3.3 ▣ 9 B	P4.1 ■ 8 B	P4.2 ▣ 7 B	P4.3 ▣ 5 A	M1.1 ▣ 11 C	M1.2 ▣ 10 B
M2.1 ▣ 9 B	K1.1 ■ 16 E	K1.2 ■ 12 D	K1.3 ▣ 9 D	K2.1 ■ 16 C	K2.2 ■ 13 C	K2.3 ▣ 10 C	K3.1 ■ 14 C	K3.2 ▣ 11 C	N1.1 ▣ 24 F	N1.2 ■ 18 F	N1.3 ■ 11 F	N2.1 ▣ 27 E	N2.2 ■ 24 E
N2.3 ■ 16 E	N3.1 ■ 47 D	N3.2 ■ 28 E	N3.3 ▣ 14 D	N4.1 ▣ 30 B									

DCON MS tolerans h6.

Product	DC (mm)	OAL (mm)	LCF (mm)	LB (mm)	NOF	DCON MS (mm)
B1801.5	1.50	40.0	8.0	18.00	3	2.00
B1801.6	1.60	43.0	9.0	20.00	3	2.00
B1801.7	1.70	43.0	9.0	20.00	3	2.00
B1801.8	1.80	46.0	10.0	22.00	4	2.00
B1801.9	1.90	46.0	10.0	22.00	4	2.00
B1802.0	2.00	49.0	11.0	24.00	4	2.00
B1802.1	2.10	49.0	11.0	24.00	4	2.00
B1802.2	2.20	53.0	12.0	26.00	4	3.00
B1802.3	2.30	53.0	12.0	26.00	4	3.00
B1802.4	2.40	57.0	14.0	28.00	4	3.00
B1802.5	2.50	57.0	14.0	28.00	4	3.00
B1802.6	2.60	57.0	14.0	28.00	4	3.00
B1802.7	2.70	61.0	15.0	32.00	6	3.00
B1802.8	2.80	61.0	15.0	32.00	6	3.00
B1802.9	2.90	61.0	15.0	32.00	6	3.00
B1803.0	3.00	61.0	15.0	32.00	6	3.00
B1803.1	3.10	65.0	16.0	35.00	6	4.00
B1803.2	3.20	65.0	16.0	35.00	6	4.00
B1803.3	3.30	65.0	16.0	35.00	6	4.00
B1803.4	3.40	70.0	18.0	40.00	6	4.00
B1803.5	3.50	70.0	18.0	40.00	6	4.00
B1803.6	3.60	70.0	18.0	40.00	6	4.00
B1803.9	3.90	75.0	19.0	43.00	6	4.00
B1804.0	4.00	75.0	19.0	43.00	6	4.00
B1804.1	4.10	75.0	19.0	43.00	6	4.00
B1804.2	4.20	75.0	19.0	43.00	6	4.00
B1804.3	4.30	80.0	21.0	47.00	6	5.00

Product	DC (mm)	OAL (mm)	LCF (mm)	LB (mm)	NOF	DCON MS (mm)
B1804.5	4.50	80.0	21.0	47.00	6	5.00
B1804.6	4.60	80.0	21.0	47.00	6	5.00
B1804.7	4.70	80.0	21.0	47.00	6	5.00
B1804.8	4.80	86.0	23.0	52.00	6	5.00
B1804.9	4.90	86.0	23.0	52.00	6	5.00
B1805.0	5.00	86.0	23.0	52.00	6	5.00
B1805.1	5.10	86.0	23.0	52.00	6	5.00
B1805.2	5.20	86.0	23.0	52.00	6	5.00
B1805.3	5.30	86.0	23.0	52.00	6	5.00
B1805.4	5.40	93.0	26.0	57.00	6	6.00
B1805.5	5.50	93.0	26.0	57.00	6	6.00
B1805.6	5.60	93.0	26.0	57.00	6	6.00
B1805.7	5.70	93.0	26.0	57.00	6	6.00
B1805.9	5.90	93.0	26.0	57.00	6	6.00
B1806.0	6.00	93.0	26.0	57.00	6	6.00
B1806.1	6.10	101.0	28.0	63.00	6	6.00
B1806.2	6.20	101.0	28.0	63.00	6	6.00
B1806.3	6.30	101.0	28.0	63.00	6	6.00
B1806.4	6.40	101.0	28.0	63.00	6	6.00
B1806.5	6.50	101.0	28.0	63.00	6	6.00
B1806.6	6.60	101.0	28.0	63.00	6	6.00
B1806.7	6.70	101.0	28.0	63.00	6	6.00
B1806.8	6.80	109.0	31.0	69.00	6	8.00
B1807.0	7.00	109.0	31.0	69.00	6	8.00
B1807.1	7.10	109.0	31.0	69.00	6	8.00
B1807.2	7.20	109.0	31.0	69.00	6	8.00
B1807.5	7.50	109.0	31.0	69.00	6	8.00



Product	DC	OAL	LCF	LB	NOF	D CON MS
	(mm)	(mm)	(mm)	(mm)		(mm)
B1807.8	7.80	117.0	33.0	75.00	6	8.00
B1807.9	7.90	117.0	33.0	75.00	6	8.00
B1808.0	8.00	117.0	33.0	75.00	6	8.00
B1808.1	8.10	117.0	33.0	75.00	6	8.00
B1808.2	8.20	117.0	33.0	75.00	6	8.00
B1808.3	8.30	117.0	33.0	75.00	6	8.00
B1808.4	8.40	117.0	33.0	75.00	6	8.00
B1808.5	8.50	117.0	33.0	75.00	6	8.00
B1808.7	8.70	125.0	36.0	81.00	6	10.00
B1808.8	8.80	125.0	36.0	81.00	6	10.00
B1809.0	9.00	125.0	36.0	81.00	6	10.00
B1809.5	9.50	125.0	36.0	81.00	6	10.00

Product	DC	OAL	LCF	LB	NOF	D CON MS
	(mm)	(mm)	(mm)	(mm)		(mm)
B1809.6	9.60	133.0	38.0	87.00	6	10.00
B18010.0	10.00	133.0	38.0	87.00	6	10.00
B18011.0	11.00	142.0	41.0	96.00	6	10.00
B18012.0	12.00	151.0	44.0	105.00	6	10.00
B18013.0	13.00	151.0	44.0	105.00	6	10.00
B18014.0	14.00	160.0	47.0	110.00	8	14.00
B18015.0	15.00	162.0	50.0	112.00	8	14.00
B18016.0	16.00	170.0	52.0	120.00	8	14.00
B18017.0	17.00	175.0	54.0	123.00	8	14.00
B18018.0	18.00	182.0	56.0	130.00	8	14.00
B18019.0	19.00	189.0	58.0	131.00	8	16.00
B18020.0	20.00	195.0	60.0	137.00	8	16.00

B170



Hundradelsbrottsch av HSS-E, i steg om 0,01 mm, blank

Brottschen finns i hundradelsintervall runt hela och halva millimetrar som gör det möjligt att brotscha till valfri tolerans. Högerskärande med vänsterspiral. Går att använda i de flesta material.

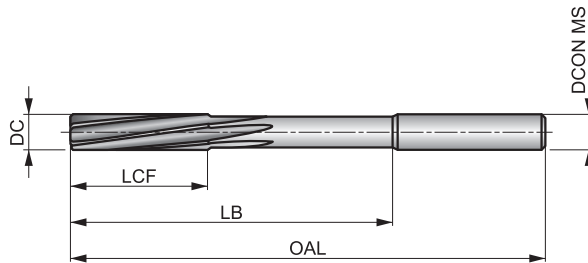

HSS-E	Bright	DIN 212
R		B
ø 95-5.5 +0.004 ø 5.51-12 +0.005		

Arbetsmaterialgrupper och startvärden för skärhastighet (m/min) och matningskod. Tabeller med matningar finns med början på sidan 279

P1.1 ■ 21 C	P1.2 ■ 24 C	P1.3 ■ 25 C	P2.1 ■ 18 C	P2.2 ■ 16 C	P2.3 ■ 14 B	P3.1 ■ 13 B	P3.2 ■ 11 B	P3.3 ■ 9 B	P4.1 ■ 8 B	P4.2 ■ 7 B	P4.3 ■ 5 A	M1.1 ■ 11 C	M1.2 ■ 10 B
M2.1 ■ 9 B	K1.1 ■ 16 E	K1.2 ■ 12 D	K1.3 ■ 9 D	K2.1 ■ 16 C	K2.2 ■ 13 C	K2.3 ■ 10 C	K3.1 ■ 14 C	K3.2 ■ 11 C	N1.1 ■ 24 D	N1.2 ■ 18 F	N1.3 ■ 11 F	N2.1 ■ 27 E	N2.2 ■ 24 E
N2.3 ■ 16 E	N3.1 ■ 47 D	N3.2 ■ 28 E	N3.3 ■ 14 D	N4.1 ■ 30 B									

DCON MS tolerans h9.

Product	DC (mm)	OAL (mm)	LCF (mm)	LB (mm)	NOF	DCON MS (mm)
B1701.0	1.00	34.0	5.5	15.00	3	1.00
B1701.05	1.05	34.0	5.5	15.00	3	1.00
B1701.49	1.49	40.0	8.0	18.00	3	1.50
B1701.5	1.50	40.0	8.0	18.00	3	1.50
B1701.52	1.52	43.0	9.0	20.00	3	1.60
B1701.98	1.98	49.0	11.0	24.00	4	2.00
B1701.99	1.99	49.0	11.0	24.00	4	2.00
B1702.0	2.00	49.0	11.0	24.00	4	2.00
B1702.01	2.01	49.0	11.0	24.00	4	2.00
B1702.02	2.02	49.0	11.0	24.00	4	2.00
B1702.03	2.03	49.0	11.0	24.00	4	2.00
B1702.05	2.05	49.0	11.0	24.00	4	2.00
B1702.5	2.50	57.0	14.0	28.00	4	2.50
B1702.51	2.51	57.0	14.0	28.00	4	2.50
B1702.98	2.98	61.0	15.0	32.00	6	3.00
B1702.99	2.99	61.0	15.0	32.00	6	3.00
B1703.0	3.00	61.0	15.0	32.00	6	3.00
B1703.01	3.01	65.0	16.0	35.00	6	3.20
B1703.02	3.02	65.0	16.0	35.00	6	3.20
B1703.03	3.03	65.0	16.0	35.00	6	3.20
B1703.05	3.05	65.0	16.0	35.00	6	3.20
B1703.98	3.98	75.0	19.0	43.00	6	4.00
B1703.99	3.99	75.0	19.0	43.00	6	4.00
B1704.0	4.00	75.0	19.0	43.00	6	4.00
B1704.01	4.01	75.0	19.0	43.00	6	4.00
B1704.02	4.02	75.0	19.0	43.00	6	4.00
B1704.03	4.03	75.0	19.0	43.00	6	4.00

Product	DC (mm)	OAL (mm)	LCF (mm)	LB (mm)	NOF	DCON MS (mm)
B1704.04	4.04	75.0	19.0	43.00	6	4.00
B1704.05	4.05	75.0	19.0	43.00	6	4.00
B1704.98	4.98	86.0	23.0	52.00	6	5.00
B1704.99	4.99	86.0	23.0	52.00	6	5.00
B1705.0	5.00	86.0	23.0	52.00	6	5.00
B1705.01	5.01	86.0	23.0	52.00	6	5.00
B1705.02	5.02	86.0	23.0	52.00	6	5.00
B1705.03	5.03	86.0	23.0	52.00	6	5.00
B1705.04	5.04	86.0	23.0	52.00	6	5.00
B1705.05	5.05	86.0	23.0	52.00	6	5.00
B1705.5	5.50	93.0	26.0	57.00	6	5.60
B1705.98	5.98	93.0	26.0	57.00	6	5.60
B1705.99	5.99	93.0	26.0	57.00	6	5.60
B1706.0	6.00	93.0	26.0	57.00	6	5.60
B1706.01	6.01	101.0	28.0	63.00	6	6.30
B1706.02	6.02	101.0	28.0	63.00	6	6.30
B1706.03	6.03	101.0	28.0	63.00	6	6.30
B1706.04	6.04	101.0	28.0	63.00	6	6.30
B1706.05	6.05	101.0	28.0	63.00	6	6.30
B1706.51	6.51	101.0	28.0	63.00	6	6.30
B1706.98	6.98	109.0	31.0	69.00	6	7.10
B1706.99	6.99	109.0	31.0	69.00	6	7.10
B1707.0	7.00	109.0	31.0	69.00	6	7.10
B1707.01	7.01	109.0	31.0	69.00	6	7.10
B1707.02	7.02	109.0	31.0	69.00	6	7.10
B1707.05	7.05	109.0	31.0	69.00	6	7.10
B1707.98	7.98	117.0	33.0	75.00	6	8.00



Product	DC	OAL	LCF	LB	NOF	DCON MS
	(mm)	(mm)	(mm)	(mm)		(mm)
B1707.99	7.99	117.0	33.0	75.00	6	8.00
B1708.0	8.00	117.0	33.0	75.00	6	8.00
B1708.01	8.01	117.0	33.0	75.00	6	8.00
B1708.02	8.02	117.0	33.0	75.00	6	8.00
B1708.03	8.03	117.0	33.0	75.00	6	8.00
B1708.04	8.04	117.0	33.0	75.00	6	8.00
B1708.05	8.05	117.0	33.0	75.00	6	8.00
B1708.98	8.98	125.0	36.0	81.00	6	9.00
B1709.0	9.00	125.0	36.0	81.00	6	9.00
B1709.01	9.01	125.0	36.0	81.00	6	9.00
B1709.02	9.02	125.0	36.0	81.00	6	9.00
B1709.05	9.05	125.0	36.0	81.00	6	9.00
B1709.5	9.50	125.0	36.0	81.00	6	9.00
B1709.51	9.51	133.0	38.0	87.00	6	10.00

Product	DC	OAL	LCF	LB	NOF	DCON MS
	(mm)	(mm)	(mm)	(mm)		(mm)
B1709.52	9.52	133.0	38.0	87.00	6	10.00
B1709.98	9.98	133.0	38.0	87.00	6	10.00
B1709.99	9.99	133.0	38.0	87.00	6	10.00
B17010.0	10.00	133.0	38.0	87.00	6	10.00
B17010.01	10.01	133.0	38.0	87.00	6	10.00
B17010.02	10.02	133.0	38.0	87.00	6	10.00
B17010.03	10.03	133.0	38.0	87.00	6	10.00
B17010.04	10.04	133.0	38.0	87.00	6	10.00
B17010.05	10.05	133.0	38.0	87.00	6	10.00
B17010.98	10.98	142.0	41.0	96.00	6	10.00
B17011.98	11.98	151.0	44.0	105.00	6	10.00
B17011.99	11.99	151.0	44.0	105.00	6	10.00
B17012.0	12.00	151.0	44.0	105.00	6	10.00

B161



Maskinbrotsch med MK-fäste, för H7-tolerans, blank

Tillverkad enligt DIN 208-standard. Precisionslipade vänsterspiralskår. Blank med ånganlöpta spår. Går att använda i de flesta material.

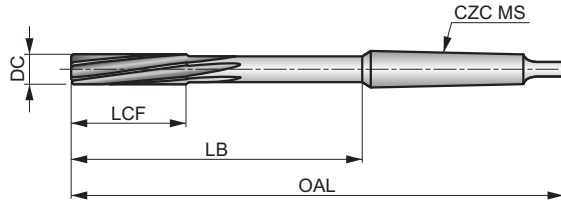

HSS-E	Bright	DIN 208
R		B
H7		

Arbetsmaterialgrupper och startvärden för skärhastighet (m/min) och matningskod. Tabeller med matningar finns med början på sidan 279

P1.1 ■ 21 C	P1.2 ■ 24 C	P1.3 ■ 25 C	P2.1 ■ 18 C	P2.2 ■ 16 C	P2.3 ▣ 14 B	P3.1 ■ 13 B	P3.2 ■ 11 B	P3.3 ▣ 9 B	P4.1 ■ 8 B	P4.2 ▣ 7 B	P4.3 ▣ 5 A	M1.1 ▣ 11 C	M1.2 ▣ 10 B
M2.1 ▣ 9 B	K1.1 ■ 16 E	K1.2 ■ 12 D	K1.3 ▣ 9 D	K2.1 ■ 16 C	K2.2 ■ 13 C	K2.3 ▣ 10 C	K3.1 ■ 14 C	K3.2 ▣ 11 C	N1.1 ▣ 24 F	N1.2 ■ 18 F	N1.3 ■ 11 F	N2.1 ▣ 27 E	N2.2 ■ 24 E
N2.3 ■ 16 E	N3.1 ■ 47 D	N3.2 ■ 28 E	N3.3 ▣ 14 D	N4.1 ▣ 30 B									

Product	DC (mm)	OAL (mm)	LCF (mm)	LB (mm)	NOF	CZC MS
B1613.0	3.00	113.0	15.0	47.50	6	MK 1
B1614.0	4.00	124.0	19.0	58.50	6	MK 1
B1615.0	5.00	133.0	23.0	67.50	6	MK 1
B1616.0	6.00	138.0	26.0	72.50	6	MK 1
B1617.0	7.00	150.0	31.0	84.50	6	MK 1
B1618.0	8.00	156.0	33.0	90.50	6	MK 1
B1619.0	9.00	162.0	36.0	96.50	6	MK 1
B16110.0	10.00	168.0	38.0	102.50	6	MK 1
B16111.0	11.00	175.0	41.0	109.50	6	MK 1
B16112.0	12.00	182.0	44.0	116.50	6	MK 1
B16113.0	13.00	182.0	44.0	116.50	6	MK 1
B16114.0	14.00	189.0	47.0	123.50	8	MK 1
B16115.0	15.00	204.0	50.0	124.00	8	MK 2
B16116.0	16.00	210.0	52.0	130.00	8	MK 2
B16117.0	17.00	214.0	54.0	134.00	8	MK 2
B16118.0	18.00	219.0	56.0	139.00	8	MK 2
B16119.0	19.00	223.0	58.0	143.00	8	MK 2
B16120.0	20.00	228.0	60.0	148.00	8	MK 2

Product	DC (mm)	OAL (mm)	LCF (mm)	LB (mm)	NOF	CZC MS
B16121.0	21.00	232.0	62.0	152.00	8	MK 2
B16122.0	22.00	237.0	64.0	157.00	8	MK 2
B16123.0	23.00	241.0	66.0	161.00	8	MK 2
B16124.0	24.00	268.0	68.0	169.00	8	MK 3
B16125.0	25.00	268.0	68.0	169.00	8	MK 3
B16126.0	26.00	273.0	70.0	174.00	8	MK 3
B16127.0	27.00	277.0	71.0	178.00	10	MK 3
B16128.0	28.00	277.0	71.0	178.00	10	MK 3
B16130.0	30.00	281.0	73.0	182.00	10	MK 3
B16132.0	32.00	317.0	77.0	193.00	10	MK 4
B16134.0	34.00	321.0	78.0	197.00	10	MK 4
B16135.0	35.00	321.0	78.0	197.00	10	MK 4
B16138.0	38.00	329.0	81.0	205.00	10	MK 4
B16140.0	40.00	329.0	81.0	205.00	10	MK 4
B16142.0	42.00	333.0	82.0	209.00	12	MK 4
B16145.0	45.00	336.0	83.0	212.00	12	MK 4
B16150.0	50.00	344.0	86.0	220.00	12	MK 4

B101

DORMER

Maskinbrotsch av HSS-E med MK-fäste, för H7-tolerans

Tillverkad enligt BS 328-standard. Precisionslipade, vänsterspiralskår. Blank med ånganlöpta spår. Går att använda i de flesta material.

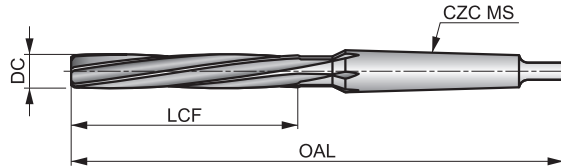

HSS-E	Bright ST	BS 328
R		B
H7		

Arbetsmaterialgrupper och startvärden för skärhastighet (m/min) och matningskod. Tabeller med matningar finns med början på sidan 279

P1.1 ■ 15 C	P1.2 ■ 16 C	P1.3 ■ 17 C	P2.1 ■ 13 C	P2.2 ■ 11 C	P2.3 ▣ 10 B	P3.1 ■ 7 B	P3.2 ■ 6 B	P3.3 ▣ 5 B	P4.1 ■ 4 B	P4.2 ▣ 4 B	P4.3 ▣ 3 A	M1.1 ▣ 7 B	M1.2 ▣ 6 A
K1.1 ■ 14 E	K1.2 ■ 10 D	K1.3 ▣ 8 D	K2.1 ■ 12 C	K2.2 ■ 10 C	K2.3 ▣ 8 C	K3.1 ■ 11 C	K3.2 ▣ 8 C	N1.1 ▣ 23 F	N1.2 ■ 17 F	N1.3 ■ 9 F	N2.1 ▣ 25 E	N2.2 ■ 18 E	N2.3 ■ 14 E
N3.1 ■ 34 D	N3.2 ■ 20 E	N3.3 ▣ 10 D	N4.1 ▣ 22 B										

Product	DC (inch)	DC (mm)	OAL (mm)	LCF (mm)	NOF	CZC MS
B1013.0	–	3.00	112.0	33.0	4	MK 1
B1014.0	–	4.00	117.0	38.0	6	MK 1
B1013/16	3/16	4.76	124.0	44.0	6	MK 1
B1015.0	–	5.00	124.0	44.0	6	MK 1
B1016.0	–	6.00	127.0	47.0	6	MK 1
B1011/4	1/4	6.35	130.0	50.0	6	MK 1
B1015/16	5/16	7.94	138.0	58.0	6	MK 1
B1018.0	–	8.00	138.0	58.0	6	MK 1
B1013/8	3/8	9.52	146.0	66.0	6	MK 1
B10110.0	–	10.00	146.0	66.0	6	MK 1
B10111.0	–	11.00	151.0	71.0	6	MK 1
B1017/16	7/16	11.11	151.0	71.0	6	MK 1
B10112.0	–	12.00	156.0	76.0	6	MK 1
B1011/2	1/2	12.70	156.0	76.0	6	MK 1
B10113.0	–	13.00	156.0	76.0	6	MK 1
B10114.0	–	14.00	161.0	81.0	8	MK 1
B1019/16	9/16	14.29	181.0	81.0	8	MK 2
B10115.0	–	15.00	181.0	81.0	8	MK 2
B1015/8	5/8	15.88	187.0	87.0	8	MK 2
B10116.0	–	16.00	187.0	87.0	8	MK 2
B10116.5	–	16.50	187.0	87.0	8	MK 2
B10117.0	–	17.00	187.0	87.0	8	MK 2

Product	DC (inch)	DC (mm)	OAL (mm)	LCF (mm)	NOF	CZC MS
B10118.0	–	18.00	193.0	93.0	8	MK 2
B10119.0	–	19.00	193.0	93.0	8	MK 2
B1013/4	3/4	19.05	200.0	100.0	8	MK 2
B10120.0	–	20.00	200.0	100.0	8	MK 2
B10121.0	–	21.00	200.0	100.0	8	MK 2
B10122.0	–	22.00	207.0	107.0	8	MK 2
B1017/8	7/8	22.22	207.0	107.0	8	MK 2
B10123.0	–	23.00	207.0	107.0	8	MK 2
B10124.0	–	24.00	242.0	115.0	8	MK 3
B10125.0	–	25.00	242.0	115.0	10	MK 3
B1011	1"	25.40	242.0	115.0	10	MK 3
B10126.0	–	26.00	242.0	115.0	10	MK 3
B10128.0	–	28.00	251.0	124.0	10	MK 3
B10129.0	–	29.00	251.0	124.0	10	MK 3
B10130.0	–	30.00	251.0	124.0	10	MK 3
B1011.1/4	1.1/4	31.75	260.0	133.0	10	MK 3
B10135.0	–	35.00	302.0	142.0	10	MK 4
B10140.0	–	40.00	312.0	152.0	10	MK 4
B10141.0	–	41.00	312.0	152.0	10	MK 4
B10144.0	–	44.00	323.0	163.0	10	MK 4
B10150.0	–	50.00	334.0	174.0	12	MK 4

B954



Konisk maskinbrottsch av HSS-E med MK-fäste, för koniska pinnhål, kona 1:50

Utformad för att brotscha pinnhål för koniska pinnar i metrisk dimensioner med kona 1 till 50. Med smal spets som enkelt kan äntra det förborrade hålet. Hög spiralvinkel. Användbar i många olika materialsorters.

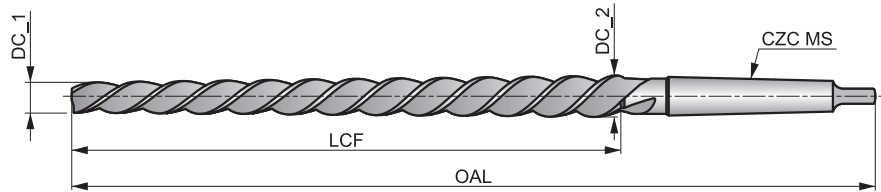

HSS-E	Bright	DIN 2180
R		1:50

Arbetsmaterialgrupper och startvärden för skärhastighet (m/min) och matningskod. Tabeller med matningar finns med början på sidan 279

P1.1 ■ 10 B	P1.2 ■ 12 B	P1.3 ■ 13 B	P2.1 ■ 9 B	P2.2 ■ 8 B	P2.3 ▣ 6 A	P3.1 ■ 7 A	P3.2 ■ 6 A	P3.3 ▣ 3 A	P4.1 ■ 4 A	P4.2 ▣ 3 A	P4.3 ▣ 2 A	M1.1 ▣ 11 C	M1.2 ▣ 10 B
M2.1 ▣ 9 B	M2.2 ▣ 8 B	K1.1 ■ 10 C	K1.2 ■ 6 B	K1.3 ▣ 4 B	K2.1 ■ 8 A	K2.2 ■ 6 A	K2.3 ▣ 4 A	K3.1 ■ 11 A	K3.2 ▣ 8 A	N1.1 ▣ 14 F	N1.2 ■ 12 F	N1.3 ■ 9 F	N2.1 ■ 16 E
N2.2 ■ 14 E	N2.3 ▣ 10 E	N3.1 ■ 22 D	N3.2 ■ 14 E	N3.3 ▣ 6 D	N4.1 ▣ 22 B								

Product	nom d	DC_1	DC_2	OAL	LCF	NOF	CZC MS
		(mm)	(mm)	(mm)	(mm)		
B9548.0	8.0	7.90	10.80	227.0	145.0	3	MK 1
B95410.0	10.0	9.90	13.40	257.0	175.0	3	MK 1
B95412.0	12.0	11.80	16.00	315.0	210.0	3	MK 2
B95413.0	13.0	12.86	16.74	295.0	194.0	3	MK 2
B95414.0	14.0	13.86	17.74	295.0	194.0	3	MK 2
B95416.0	16.0	15.80	20.40	335.0	230.0	3	MK 2
B95420.0	20.0	19.80	24.80	377.0	250.0	3	MK 3
B95425.0	25.0	24.70	30.70	427.0	300.0	3	MK 3
B95430.0	30.0	29.70	36.10	475.0	320.0	4	MK 4

B121

DORMER



Konisk brotsch av HSS med Morse-konfäste, blank och ånganlöp

Avsedd att användas för att rikta upp hål i grövre plåtar innan ihopnitning. Brotschkroppens främre del konar 1:10 för att kunna äntra lätt. Därefter är kroppen cylindrisk. Användbar i de flesta material.

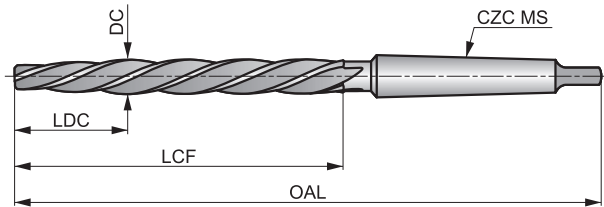

HSS	Bright ST	DIN 311
R		k11

Arbetsmaterialgrupper och startvärden för skärhastighet (m/min) och matningskod. Tabeller med matningar finns med början på sidan 279

P1.1 ■ 15 C	P1.2 ■ 16 C	P1.3 ■ 17 C	P2.1 ■ 13 C	P2.2 ■ 11 C	P2.3 ▣ 10 B	P3.1 ■ 7 B	P3.2 ■ 6 B	P3.3 ▣ 5 B	P4.1 ■ 4 B	P4.2 ▣ 4 B	P4.3 ▣ 3 A	K1.1 ■ 14 E	K1.2 ■ 10 D
K1.3 ▣ 8 D	K2.1 ■ 12 C	K2.2 ■ 10 C	K2.3 ▣ 8 C	K3.1 ▣ 11 C	K3.2 ▣ 8 C	N1.1 ▣ 23 F	N1.2 ■ 17 F	N1.3 ■ 9 F	N2.1 ▣ 21 E	N2.2 ■ 18 E	N2.3 ▣ 14 E	N3.1 ■ 34 D	N3.2 ■ 20 E
N3.3 ▣ 10 D	N4.1 ▣ 21 B												

Med ingångskon 1:10 (LDC)

Product	DC (mm)	OAL (mm)	LCF (mm)	LDC (mm)	NOF	CZC MS
B12112.0	12.00	199.0	105.0	39.00	4	MK 2
B12114.0	14.00	209.0	115.0	42.00	4	MK 2
B12116.0	16.00	229.0	135.0	48.00	4	MK 2
B12117.0	17.00	251.0	135.0	51.00	4	MK 3
B12118.0	18.00	261.0	145.0	58.00	4	MK 3
B12120.0	20.00	271.0	155.0	62.00	4	MK 3
B12121.0	21.00	271.0	155.0	62.00	4	MK 3
B12122.0	22.00	281.0	165.0	66.00	4	MK 3
B12124.0	24.00	296.0	180.0	72.00	4	MK 3
B12125.0	25.00	296.0	180.0	72.00	4	MK 3

B640

DORMER



HSS brotsch med koniskt skaft, ånganlöpt

Används för att rikta om hål i stora konstruktioner som I-balkar, där två eller flera arbetsstycken ska sammanfogas genom bultning eller nitning. Den mindre startänden med lång avsmalning gör det möjligt för operatören att rikta in de felaktigt förborrade hålen genom att brotscha bort det felaktigt förborrade hålet. Tillverkad enligt ANSI B94.2-1983 (R1988).

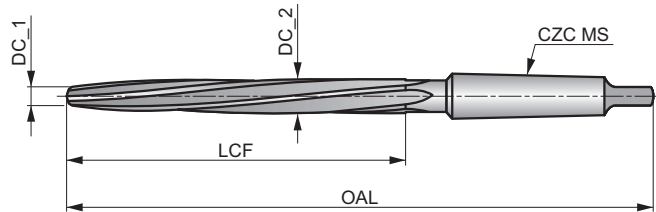

HSS		ANSI

Arbetsmaterialgrupper och startvärden för skärhastighet (m/min) och matningskod. Tabeller med matningar finns med början på sidan 279

P1.1 ■ 15 C	P1.2 ■ 16 C	P1.3 ■ 17 C	P2.1 ■ 13 C	P2.2 ■ 11 C	P2.3 ■ 10 B	P3.1 ■ 7 B	P3.2 ■ 6 B	P3.3 ■ 5 B	P4.1 ■ 4 B	P4.2 ■ 4 B	P4.3 ■ 3 A	K1.1 ■ 14 E	K1.2 ■ 10 D
K1.3 ■ 8 D	K2.1 ■ 12 C	K2.2 ■ 10 C	K2.3 ■ 8 C	K3.1 ■ 11 C	K3.2 ■ 8 C	N1.1 ■ 23 F	N1.2 ■ 17 F	N1.3 ■ 9 F	N2.1 ■ 21 E	N2.2 ■ 18 E	N2.3 ■ 14 E	N3.1 ■ 34 D	N3.2 ■ 20 E
N3.3 ■ 10 D	N4.1 ■ 21 B												

Product	nom d	DC_1 (inch)	DC_2 (inch)	CZC MS	LCF (inch)	OAL (inch)	NOF
B6407/16	7/16	0.2500	0.4375	2	4.3/8	8.1/4	5
B6401/2	1/2	0.2813	0.5000	2	5.1/8	9"	5
B6409/16	9/16	0.3438	0.5625	2	5.1/8	9"	5
B6405/8	5/8	0.3750	0.6250	2	6.1/8	10"	5
B64011/16	11/16	0.3906	0.6875	3	7.1/8	11.3/4	5
B6403/4	3/4	0.4375	0.7500	3	7.3/8	12"	5
B64013/16	13/16	0.5000	0.8125	3	7.3/8	12"	5
B6407/8	7/8	0.5625	0.8750	3	7.3/8	12"	5
B64015/16	15/16	0.6250	0.9375	3	7.3/8	12"	5
B6401	1"	0.6875	1.0000	3	7.3/8	12"	5
B6401.1/16	1.1/16	0.7500	1.0625	3	7.3/8	12"	5



ISO
13399



PMK
NSH



**VERKTYG FÖR PROCESSÄKERHET OCH PRODUKTIVITET.
ANVÄNDS VANLIGTVIS VID CNC OCH AUTOMATISERAD TILLVERKNING.**

Verktygsmaterial (BMC)	HM	HM	HM	HM															
Standard (BSG)																			
Användbar längd (ULDR)	1×D	1×D	1×D	1×D															
Spetsvinkel																			
Beläggning																			
Skaft																			
Spiralform																			
Skärriktning																			

Produktfamilj	R123	R6011	R122	R125															
PSF skärdiametrar	5.00 - 20.00	6.00 - 16.00	5.00 - 20.00	5.00 - 16.00															

		182	183	184	185															
P	P1	■	■	■	■															
	P2	■	■	■	■															
	P3	■	■	■	■															
	P4	■	■	■	■															
M	M1	■	■	■	■															
	M2	■	■	■	■															
	M3	■	■	■	■															
	M4																			
K	K1	■	■	■	■															
	K2	■	■	■	■															
	K3	■	■	■	■															
	K4	■	■	■	■															
	K5	■	■	■	■															
N	N1	■	■	■	■															
	N2	■	■	■	■															
	N3	■	■	■	■															
	N4	■	■	■	■															
	N5																			
S	S1	■	■	■	■															
	S2	■	■	■	■															
	S3	■	■	■	■															
	S4	■	■	■	■															
H	H1	■	■	■	■															
	H2	▣	▣	▣	▣															
	H3	▣	▣	▣	▣															
	H4																			

R123



Centrerborr av solid HM, 90° spetsvinkel,

Centrerborr av solid HM, lämpligt att använda i styrda maskiner. Används för att göra styrningar för efterkommande borrning. Borret är självcentrerande.

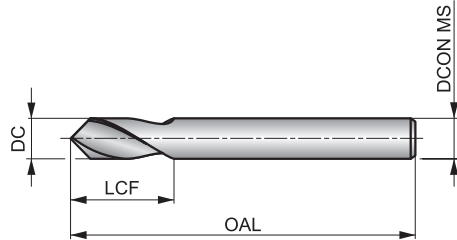

HM		1xD
90°	Bright	
λ 20-35°		DC h6

Arbetsmaterialgrupper och startvärden för skärhastighet (m/min) och matningskod. Tabeller med matningar finns med början på sidan 274

P1.1 ■ 99 S	P1.2 ■ 111 S	P1.3 ■ 115 S	P2.1 ■ 85 S	P2.2 ■ 75 S	P2.3 ■ 66 S	P3.1 ■ 66 S	P3.2 ■ 53 S	P3.3 ■ 45 S	P4.1 ■ 40 S	P4.2 ■ 34 S	P4.3 ■ 27 S	M1.1 ■ 73 S	M1.2 ■ 61 S
M2.1 ■ 65 S	M2.2 ■ 53 S	M3.1 ■ 52 S	M3.2 ■ 45 S	K1.1 ■ 75 T	K1.2 ■ 56 T	K1.3 ■ 42 T	K2.1 ■ 68 T	K2.2 ■ 55 T	K2.3 ■ 44 T	K3.1 ■ 60 T	K3.2 ■ 46 T	K3.3 ■ 37 T	K4.1 ■ 55 T
K4.2 ■ 42 T	K4.3 ■ 31 T	K4.4 ■ 26 T	K4.5 ■ 22 T	K5.1 ■ 63 T	K5.2 ■ 47 T	K5.3 ■ 37 T	N1.1 ■ 200 V	N1.2 ■ 150 V	N1.3 ■ 100 V	N2.1 ■ 172 V	N2.2 ■ 155 V	N2.3 ■ 112 V	N3.1 ■ 423 V
N3.2 ■ 250 V	N3.3 ■ 125 V	N4.1 ■ 60 X	N4.2 ■ 100 V	S1.1 ■ 45 T	S1.2 ■ 35 T	S1.3 ■ 25 S	S2.1 ■ 40 S	S2.2 ■ 28 S	S3.1 ■ 30 S	S3.2 ■ 20 S	S4.1 ■ 23 S	S4.2 ■ 16 S	H1.1 ■ 56 S
H2.1 ■ 33 S	H2.2 ■ 36 S	H3.1 ■ 37 S	H3.2 ■ 30 S										

Product	DC	DC	LCF	OAL	DCON MS
	(mm)	(inch)	(mm)	(mm)	(mm)
R1235.0	5.00	0.1969	16.0	62.0	5.00
R1236.0	6.00	0.2362	17.0	66.0	6.00
R1238.0	8.00	0.3150	22.0	79.0	8.00
R12310.0	10.00	0.3937	26.0	89.0	10.00
R12312.0	12.00	0.4724	30.0	102.0	12.00
R12316.0	16.00	0.6299	34.0	115.0	16.00
R12320.0	20.00	0.7874	40.0	131.0	20.00

R6011



Centrerborr av solid HM, 90° spetsvinkel, TiAIN-belagd

Centrerborr av solid HM, lämpligt att använda i styrda maskiner. Används för att göra styrningar för efterkommande borrning. Borret är självcentrerande.

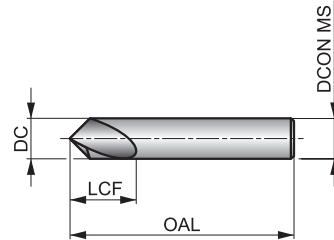

HM	DORMER	1xD
90°	TiAIN	DIN 6535HA
λ 20-35°	R	DC h6

Arbetsmaterialgrupper och startvärden för skärhastighet (m/min) och matningskod. Tabeller med matningar finns med början på sidan 274

P1.1 ■ 119 S	P1.2 ■ 134 S	P1.3 ■ 138 S	P2.1 ■ 102 S	P2.2 ■ 90 S	P2.3 ■ 80 S	P3.1 ■ 81 S	P3.2 ■ 65 S	P3.3 ■ 55 S	P4.1 ■ 48 S	P4.2 ■ 41 S	P4.3 ■ 34 S	M1.1 ■ 82 S	M1.2 ■ 70 S
M2.1 ■ 73 S	M2.2 ■ 60 S	M3.1 ■ 58 S	M3.2 ■ 50 S	K1.1 ■ 80 T	K1.2 ■ 59 T	K1.3 ■ 44 T	K2.1 ■ 86 T	K2.2 ■ 70 T	K2.3 ■ 56 T	K3.1 ■ 76 T	K3.2 ■ 58 T	K3.3 ■ 47 T	K4.1 ■ 71 T
K4.2 ■ 53 T	K4.3 ■ 39 T	K4.4 ■ 33 T	K4.5 ■ 28 T	K5.1 ■ 80 T	K5.2 ■ 60 T	K5.3 ■ 46 T	N1.1 ■ 200 V	N1.2 ■ 150 V	N1.3 ■ 100 V	N2.1 ■ 172 V	N2.2 ■ 155 V	N2.3 ■ 112 V	N3.1 ■ 423 V
N3.2 ■ 250 V	N3.3 ■ 125 V	N4.1 ■ 60 X	N4.2 ■ 100 V	S1.1 ■ 55 T	S1.2 ■ 45 T	S1.3 ■ 35 S	S2.1 ■ 53 S	S2.2 ■ 42 S	S3.1 ■ 40 S	S3.2 ■ 30 S	S4.1 ■ 31 S	S4.2 ■ 24 S	H1.1 ■ 56 S
H2.1 ■ 33 S	H2.2 ■ 36 S	H3.1 ■ 37 S	H3.2 ■ 30 S										

DCON MS tolerans h6.

Product	DC	DC	LCF	OAL	DCON MS
	(mm)	(inch)	(mm)	(mm)	(mm)
R60116.0	6.00	0.2362	16.0	50.0	6.00
R601110.0	10.00	0.3937	25.0	70.0	10.00
R601116.0	16.00	0.6299	26.0	90.0	16.00

R122



Centrerborr av solid HM, 120° spetsvinkel

Centrerborr av solid HM, lämpligt att använda i styrda maskiner. Används för att göra styrningar för efterkommande borrning. Borret är självcentrerande. Efterföljande borr bör helst ha en spetsvinkel som är mindre (spetsigare) än centrerborrets för bästa resultat.

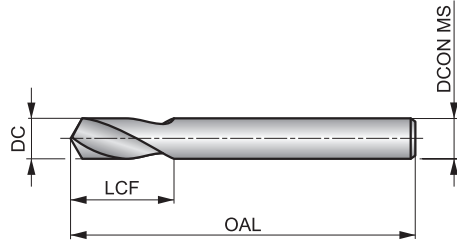

HM	DORMER	1xD
120°	Bright	
λ 20-35°	R	DC h6

Arbetsmaterialgrupper och startvärden för skärhastighet (m/min) och matningskod. Tabeller med matningar finns med början på sidan 274

P1.1 ■ 99 S	P1.2 ■ 111 S	P1.3 ■ 115 S	P2.1 ■ 85 S	P2.2 ■ 75 S	P2.3 ■ 66 S	P3.1 ■ 66 S	P3.2 ■ 53 S	P3.3 ■ 45 S	P4.1 ■ 40 S	P4.2 ■ 34 S	P4.3 ■ 27 S	M1.1 ■ 73 S	M1.2 ■ 61 S
M2.1 ■ 65 S	M2.2 ■ 53 S	M3.1 ■ 52 S	M3.2 ■ 45 S	K1.1 ■ 75 T	K1.2 ■ 56 T	K1.3 ■ 42 T	K2.1 ■ 68 T	K2.2 ■ 55 T	K2.3 ■ 44 T	K3.1 ■ 60 T	K3.2 ■ 46 T	K3.3 ■ 37 T	K4.1 ■ 55 T
K4.2 ■ 42 T	K4.3 ■ 31 T	K4.4 ■ 26 T	K4.5 ■ 22 T	K5.1 ■ 63 T	K5.2 ■ 47 T	K5.3 ■ 37 T	N1.1 ■ 200 V	N1.2 ■ 150 V	N1.3 ■ 100 V	N2.1 ■ 172 V	N2.2 ■ 155 V	N2.3 ■ 112 V	N3.1 ■ 423 V
N3.2 ■ 250 V	N3.3 ■ 125 V	N4.1 ■ 60 X	N4.2 ■ 100 V	S1.1 ■ 45 T	S1.2 ■ 35 T	S1.3 ■ 25 S	S2.1 ■ 40 S	S2.2 ■ 28 S	S3.1 ■ 30 S	S3.2 ■ 20 S	S4.1 ■ 23 S	S4.2 ■ 16 S	H1.1 ■ 56 S
H2.1 ■ 33 S	H2.2 ■ 36 S	H3.1 ■ 37 S	H3.2 ■ 30 S										

Product	DC	DC	LCF	OAL	DCON MS
	(mm)	(inch)			
R1225.0	5.00	0.1969	16.0	62.0	5.00
R1226.0	6.00	0.2362	17.0	66.0	6.00
R1228.0	8.00	0.3150	22.0	79.0	8.00
R12210.0	10.00	0.3937	26.0	89.0	10.00
R12212.0	12.00	0.4724	30.0	102.0	12.00
R12216.0	16.00	0.6299	34.0	115.0	16.00
R12220.0	20.00	0.7874	40.0	131.0	20.00

R125

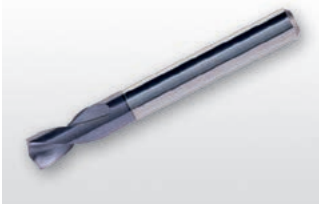

Centrerborr av solid HM, 150° spetsvinkel, TiAlN-belagd

Centrerborr av solid HM, lämpligt att använda i styrda maskiner. Används för att göra styrningar för efterkommande borrar. Borret är självcenterande. Efterföljande borrar bör helst ha en spetsvinkel som är mindre (spetsigare) än centrerborrets för bästa resultat.

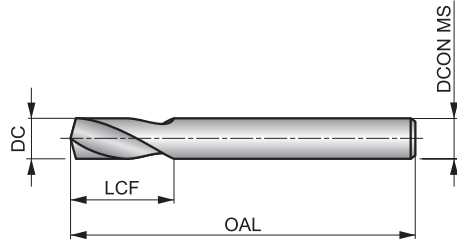

HM	DORMER	1xD
150°	TiAlN	
λ 20-35°	R	DC h6

Arbetsmaterialgrupper och startvärden för skärhastighet (m/min) och matningskod. Tabeller med matningar finns med början på sidan 274

P1.1 ■ 119 S	P1.2 ■ 134 S	P1.3 ■ 138 S	P2.1 ■ 102 S	P2.2 ■ 90 S	P2.3 ■ 80 S	P3.1 ■ 81 S	P3.2 ■ 65 S	P3.3 ■ 55 S	P4.1 ■ 48 S	P4.2 ■ 41 S	P4.3 ■ 34 S	M1.1 ■ 82 S	M1.2 ■ 70 S
M2.1 ■ 73 S	M2.2 ■ 60 S	M3.1 ■ 58 S	M3.2 ■ 50 S	K1.1 ■ 80 T	K1.2 ■ 59 T	K1.3 ■ 44 T	K2.1 ■ 86 T	K2.2 ■ 70 T	K2.3 ■ 56 T	K3.1 ■ 76 T	K3.2 ■ 58 T	K3.3 ■ 47 T	K4.1 ■ 71 T
K4.2 ■ 53 T	K4.3 ■ 39 T	K4.4 ■ 33 T	K4.5 ■ 28 T	K5.1 ■ 80 T	K5.2 ■ 60 T	K5.3 ■ 46 T	N1.1 ■ 200 V	N1.2 ■ 150 V	N1.3 ■ 100 V	N2.1 ■ 172 V	N2.2 ■ 155 V	N2.3 ■ 112 V	N3.1 ■ 423 V
N3.2 ■ 250 V	N3.3 ■ 125 V	N4.1 ■ 60 X	N4.2 ■ 100 V	S1.1 ■ 55 T	S1.2 ■ 45 T	S1.3 ■ 35 S	S2.1 ■ 53 S	S2.2 ■ 42 S	S3.1 ■ 40 S	S3.2 ■ 30 S	S4.1 ■ 31 S	S4.2 ■ 24 S	H1.1 ■ 56 S
H2.1 ■ 33 S	H2.2 ■ 36 S	H3.1 ■ 37 S	H3.2 ■ 30 S										

DCON MS tolerans h6.

Product	DC (mm)	LCF (mm)	OAL (mm)	DCON MS (mm)
R1255.0	5.00	16.0	62.0	5.00
R1256.0	6.00	17.0	66.0	6.00
R1258.0	8.00	22.0	79.0	8.00
R12510.0	10.00	26.0	89.0	10.00
R12512.0	12.00	30.0	102.0	12.00
R12516.0	16.00	34.0	115.0	16.00

Verktygsmaterial (BMC)	HM	HM	HM	HM	HM	HM	HM	HM	HM	HM									
	Standard (BSG)	DIN 6539	DIN 338	DIN 6537K	DIN 6537K	DIN 6537L	DIN 6537L	DORNER	DIN 6537K	DIN 6537L	DORNER								
Användbar längd (ULDR)	2.5xD	4xD	3xD	3xD	5xD	5xD	8xD	3xD	5xD	3xD									
Spetsvinkel	130°	130°	140°	140°	140°	140°	140°	140°	140°	140°	90°								
Beläggning	TIN	TIN	TIAlN	TIAlN	TIAlN	TIAlN	TIAlN	TIAlN	TIAlN	TIAlN	TIAlN								
Skaft			DIN 6535HA	DIN 6535HA	DIN 6535HA	DIN 6535HA	DIN 6535HA	DIN 6535HA	DIN 6535HA	DIN 6535HA	DIN 6535HA								
Spiralform	λ 20-35°	λ 20-35°	CTW	CTW	CTW	CTW	CTW	CTW	CTW	CTW	λ 20-35°								
Skärriktning	R	R	R	R	R	R	R	R	R	R	R								
Kylning (CSP)																			
		CDX	CDX	FORCE X	FORCE X	FORCE X	FORCE X	FORCE X	FORCE M	FORCE M									
Produktfamilj		R520	R510	R458	R457	R454	R453	R459	R467	R463	R7131								
PSF skärdiameter		3.00 - 16.50	3.00 - 14.00	3.00 - 20.00	3.00 - 20.00	3.00 - 20.00	3.00 - 20.00	3.00 - 16.00	3.00 - 16.00	3.00 - 16.00	3.30 - 10.40								
		188	190	191	195	199	203	207	210	213	216								
P	P1	■	■	■	■	■	■	■			■								
	P2	■	■	■	■	■	■	■			■								
	P3	■	■	■	■	■	■	■			■								
	P4	■	■	■	■	■	■	■			■								
M	M1	■	■	■	■	■	■	■	■	■	■								
	M2	■	■	■	■	■	■	■	■	■	■								
	M3			■	■	■	■	■	■	■	■								
	M4			■	■	■	■	■	■	■	■								
K	K1	■	■	■	■	■	■	■			■								
	K2	■	■	■	■	■	■	■			■								
	K3	■	■	■	■	■	■	■			■								
	K4	■	■	■	■	■	■	■			■								
	K5	■	■	■	■	■	■	■			■								
N	N1	■	■	■	■	■	■	■	■	■	■								
	N2	■	■	■	■	■	■	■	■	■	■								
	N3			■	■	■	■	■	■	■	■								
	N4	■	■																
	N5																		
S	S1	■	■	■	■	■	■			■	■								
	S2									■	■								
	S3									■	■								
	S4									■	■								
H	H1	■	■	■	■	■	■												
	H2	■	■	■	■	■	■												
	H3	■	■	■	■	■	■												
	H4																		

R520



CDX-borr av solid HM, extrakort, TiN-belagd

Högproduktivt borr som ger hål med hög noggrannhet och finish. H8-tolerans möjlig under rätt förhållanden. 130° spetsvinkel och självcentrerande spets minskar skärkrafterna. TiN-beläggning ökar slitstyrka och livslängd. Används i CNC-maskiner och kan användas i de flesta material.

CDX

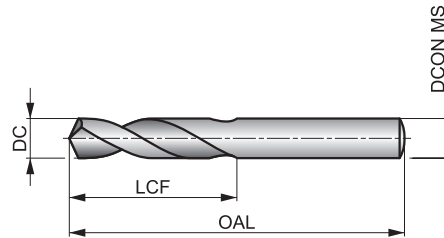

HM	DIN 6539	2.5xD
130°	TiN	
λ 20-35°	R	DC h7

Arbetsmaterialgrupper och startvärden för skärhastighet (m/min) och matningskod. Tabeller med matningar finns med början på sidan 274

P1.1 ■ 119 X	P1.2 ■ 134 X	P1.3 ■ 138 X	P2.1 ■ 102 X	P2.2 ■ 90 X	P2.3 ■ 80 X	P3.1 ■ 81 X	P3.2 ■ 65 X	P3.3 ■ 55 X	P4.1 ■ 48 X	P4.2 ■ 41 X	P4.3 ■ 34 W	M1.1 ■ 69 W	M1.2 ■ 58 W
M2.1 ■ 61 W	M2.2 ■ 50 W	K1.1 ■ 90 Y	K1.2 ■ 67 Y	K1.3 ■ 50 Y	K2.1 ■ 80 X	K2.2 ■ 65 X	K2.3 ■ 52 X	K3.1 ■ 71 X	K3.2 ■ 54 X	K3.3 ■ 44 X	K4.1 ■ 66 X	K4.2 ■ 49 X	K4.3 ■ 36 X
K4.4 ■ 31 X	K4.5 ■ 26 X	K5.1 ■ 74 X	K5.2 ■ 56 X	K5.3 ■ 43 X	N1.1 ■ 225 Z	N1.2 ■ 169 Z	N1.3 ■ 113 Z	N2.1 ■ 231 Y	N2.2 ■ 208 Y	N2.3 ■ 150 Y	N4.1 ■ 75 Z	N4.2 ■ 115 V	S1.1 ■ 60 W
S1.2 ■ 45 V	S1.3 ■ 35 U	H1.1 ■ 65 U	H2.1 ■ 38 U	H2.2 ■ 36 T	H3.1 ■ 43 U	H3.2 ■ 35 U							

DCON MS tolerans h7.

Product	DC (inch)	DC (mm)	DC (inch)	LCF (mm)	OAL (mm)	DCON MS (mm)
R5203.0	–	3.00	0.1181	16.0	46.0	3.00
R5203.1	–	3.10	0.1220	18.0	49.0	3.10
R5201/8	1/8	3.18	0.1250	18.0	49.0	3.18
R5203.2	–	3.20	0.1260	18.0	49.0	3.20
R5203.3	–	3.30	0.1299	18.0	49.0	3.30
R5203.4	–	3.40	0.1339	20.0	52.0	3.40
R5203.5	–	3.50	0.1378	20.0	52.0	3.50
R5203.6	–	3.60	0.1417	20.0	52.0	3.60
R5203.7	–	3.70	0.1457	20.0	52.0	3.70
R5203.8	–	3.80	0.1496	22.0	55.0	3.80
R5203.9	–	3.90	0.1535	22.0	55.0	3.90
R5204.0	–	4.00	0.1575	22.0	55.0	4.00
R5204.1	–	4.10	0.1614	22.0	55.0	4.10
R5204.2	–	4.20	0.1654	22.0	55.0	4.20
R5204.3	–	4.30	0.1693	24.0	58.0	4.30
R5204.4	–	4.40	0.1732	24.0	58.0	4.40
R5204.5	–	4.50	0.1772	24.0	58.0	4.50
R5204.6	–	4.60	0.1811	24.0	58.0	4.60
R5204.7	–	4.70	0.1850	24.0	58.0	4.70
R5204.8	–	4.80	0.1890	26.0	62.0	4.80
R5204.9	–	4.90	0.1929	26.0	62.0	4.90
R5205.0	–	5.00	0.1969	26.0	62.0	5.00
R5205.1	–	5.10	0.2008	26.0	62.0	5.10
R5205.2	–	5.20	0.2047	26.0	62.0	5.20
R5205.3	–	5.30	0.2087	26.0	62.0	5.30

Product	DC (inch)	DC (mm)	DC (inch)	LCF (mm)	OAL (mm)	DCON MS (mm)
R5205.4	–	5.40	0.2126	28.0	66.0	5.40
R5205.5	–	5.50	0.2165	28.0	66.0	5.50
R5205.6	–	5.60	0.2205	28.0	66.0	5.60
R5205.8	–	5.80	0.2283	28.0	66.0	5.80
R5205.9	–	5.90	0.2323	28.0	66.0	5.90
R5206.0	–	6.00	0.2362	28.0	66.0	6.00
R5206.1	–	6.10	0.2402	31.0	70.0	6.10
R5206.2	–	6.20	0.2441	31.0	70.0	6.20
R5206.3	–	6.30	0.2480	31.0	70.0	6.30
R5201/4	1/4	6.35	0.2500	31.0	70.0	6.35
R5206.4	–	6.40	0.2520	31.0	70.0	6.40
R5206.5	–	6.50	0.2559	31.0	70.0	6.50
R5206.6	–	6.60	0.2598	31.0	70.0	6.60
R5206.7	–	6.70	0.2638	31.0	70.0	6.70
R5206.8	–	6.80	0.2677	34.0	74.0	6.80
R5206.9	–	6.90	0.2717	34.0	74.0	6.90
R5207.0	–	7.00	0.2756	34.0	74.0	7.00
R5207.1	–	7.10	0.2795	34.0	74.0	7.10
R5207.2	–	7.20	0.2835	34.0	74.0	7.20
R5207.3	–	7.30	0.2874	34.0	74.0	7.30
R5207.4	–	7.40	0.2913	34.0	74.0	7.40
R5207.5	–	7.50	0.2953	34.0	74.0	7.50
R5207.6	–	7.60	0.2992	37.0	79.0	7.60
R5207.7	–	7.70	0.3031	37.0	79.0	7.70
R5207.8	–	7.80	0.3071	37.0	79.0	7.80



Product	DC	DC	DC	LCF	OAL	D CON MS
	(inch)	(mm)	(inch)	(mm)	(mm)	(mm)
R5205/16	5/16	7.94	0.3126	37.0	79.0	7.94
R5208.0	–	8.00	0.3150	37.0	79.0	8.00
R5208.1	–	8.10	0.3189	37.0	79.0	8.10
R5208.2	–	8.20	0.3228	37.0	79.0	8.20
R5208.3	–	8.30	0.3268	37.0	79.0	8.30
R5208.4	–	8.40	0.3307	37.0	79.0	8.40
R5208.5	–	8.50	0.3346	37.0	79.0	8.50
R5208.6	–	8.60	0.3386	40.0	84.0	8.60
R5208.7	–	8.70	0.3425	40.0	84.0	8.70
R5208.8	–	8.80	0.3465	40.0	84.0	8.80
R5209.0	–	9.00	0.3543	40.0	84.0	9.00
R5209.1	–	9.10	0.3583	40.0	84.0	9.10
R5209.3	–	9.30	0.3661	40.0	84.0	9.30
R5209.5	–	9.50	0.3740	40.0	84.0	9.50
R5203/8	3/8	9.52	0.3748	43.0	89.0	9.52
R5209.6	–	9.60	0.3780	43.0	89.0	9.60
R5209.7	–	9.70	0.3819	43.0	89.0	9.70
R5209.8	–	9.80	0.3858	43.0	89.0	9.80
R52010.0	–	10.00	0.3937	43.0	89.0	10.00
R52010.1	–	10.10	0.3976	43.0	89.0	10.10
R52010.2	–	10.20	0.4016	43.0	89.0	10.20

Product	DC	DC	DC	LCF	OAL	D CON MS
	(inch)	(mm)	(inch)	(mm)	(mm)	(mm)
R52010.3	–	10.30	0.4055	43.0	89.0	10.30
R52010.4	–	10.40	0.4094	43.0	89.0	10.40
R52010.5	–	10.50	0.4134	43.0	89.0	10.50
R52011.0	–	11.00	0.4331	47.0	95.0	11.00
R5207/16	7/16	11.11	0.4374	47.0	95.0	11.11
R52011.2	–	11.20	0.4409	47.0	95.0	11.20
R52011.5	–	11.50	0.4528	47.0	95.0	11.50
R52012.0	–	12.00	0.4724	51.0	102.0	12.00
R52012.5	–	12.50	0.4921	51.0	102.0	12.50
R5201/2	1/2	12.70	0.5000	51.0	102.0	12.70
R52013.0	–	13.00	0.5118	51.0	102.0	13.00
R52013.5	–	13.50	0.5315	54.0	107.0	13.50
R52014.0	–	14.00	0.5512	54.0	107.0	14.00
R52014.2	–	14.20	0.5591	56.0	111.0	14.20
R52014.25	–	14.25	0.5610	56.0	111.0	14.25
R52014.5	–	14.50	0.5709	56.0	111.0	14.50
R52015.0	–	15.00	0.5906	56.0	111.0	15.00
R52015.1	–	15.10	0.5945	58.0	115.0	15.10
R5205/8	5/8	15.88	0.6252	58.0	115.0	15.88
R52016.0	–	16.00	0.6299	58.0	115.0	16.00
R52016.5	–	16.50	0.6496	60.0	119.0	16.50

R510



CDX-borr av solid hårdmetall, kort, TiN-belagd

Högproduktivt borr som ger hål med hög noggrannhet och finish. H8-tolerans möjlig under rätt förhållanden. 130° spetsvinkel och självcentrerande spets minskar skärkrafterna. TiN-beläggning ökar slitstyrka och livslängd. Används i CNC-maskiner och kan användas i de flesta material.

CDX

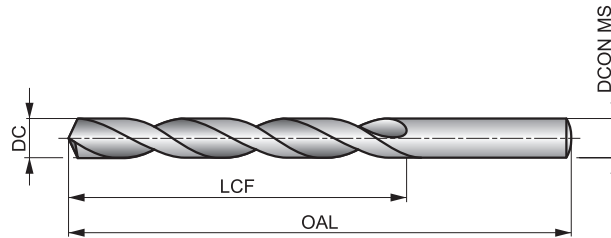

HM	DIN 338	4xD
130°	TiN	
λ 20-35°	R	DC h7

Arbetsmaterialgrupper och startvärden för skärhastighet (m/min) och matningskod. Tabeller med matningar finns med början på sidan 274

P1.1 ■ 119 W	P1.2 ■ 134 W	P1.3 ■ 138 W	P2.1 ■ 102 W	P2.2 ■ 90 W	P2.3 ■ 80 W	P3.1 ■ 81 W	P3.2 ■ 65 W	P3.3 ■ 55 W	P4.1 ■ 48 W	P4.2 ■ 41 W	P4.3 ■ 34 W	M1.1 ■ 69 V	M1.2 ■ 58 V
M2.1 ■ 61 V	M2.2 ■ 50 V	K1.1 ■ 90 X	K1.2 ■ 67 X	K1.3 ■ 50 X	K2.1 ■ 80 W	K2.2 ■ 65 W	K2.3 ■ 52 W	K3.1 ■ 71 W	K3.2 ■ 54 W	K3.3 ■ 44 W	K4.1 ■ 66 W	K4.2 ■ 49 W	K4.3 ■ 36 W
K4.4 ■ 31 W	K4.5 ■ 26 W	K5.1 ■ 74 W	K5.2 ■ 56 W	K5.3 ■ 43 W	N1.1 ■ 225 Y	N1.2 ■ 169 Y	N1.3 ■ 113 Y	N2.1 ■ 231 X	N2.2 ■ 208 X	N2.3 ■ 150 X	N4.1 ■ 75 X	N4.2 ■ 115 V	S1.1 ■ 45 V
H1.1 ■ 65 T	H2.1 ■ 38 T	H2.2 ■ 36 S	H3.1 ■ 43 T	H3.2 ■ 35 T									

DCON MS tolerans h7.

Product	DC (inch)	DC (mm)	DC (inch)	LCF (mm)	OAL (mm)	DCON MS (mm)
R5103.0	–	3.00	0.1181	33.0	61.0	3.00
R5101/8	1/8	3.18	0.1250	36.0	65.0	3.18
R5103.2	–	3.20	0.1260	36.0	65.0	3.20
R5103.3	–	3.30	0.1299	36.0	65.0	3.30
R5103.4	–	3.40	0.1339	39.0	70.0	3.40
R5103.5	–	3.50	0.1378	39.0	70.0	3.50
R5103.7	–	3.70	0.1457	39.0	70.0	3.70
R5103.9	–	3.90	0.1535	43.0	75.0	3.90
R5104.0	–	4.00	0.1575	43.0	75.0	4.00
R5104.1	–	4.10	0.1614	43.0	75.0	4.10
R5104.2	–	4.20	0.1654	43.0	75.0	4.20
R5104.3	–	4.30	0.1693	47.0	80.0	4.30
R5104.5	–	4.50	0.1772	47.0	80.0	4.50
R5104.7	–	4.70	0.1850	47.0	80.0	4.70
R5103/16	3/16	4.76	0.1874	52.0	86.0	4.76
R5104.9	–	4.90	0.1929	52.0	86.0	4.90
R5105.0	–	5.00	0.1969	52.0	86.0	5.00
R5105.1	–	5.10	0.2008	52.0	86.0	5.10
R5105.5	–	5.50	0.2165	57.0	93.0	5.50
R5105.6	–	5.60	0.2205	57.0	93.0	5.60
R5105.7	–	5.70	0.2244	57.0	93.0	5.70
R5106.0	–	6.00	0.2362	57.0	93.0	6.00
R5101/4	1/4	6.35	0.2500	63.0	101.0	6.35
R5106.5	–	6.50	0.2559	63.0	101.0	6.50
R5106.6	–	6.60	0.2598	63.0	101.0	6.60
R5106.8	–	6.80	0.2677	69.0	109.0	6.80
R5107.0	–	7.00	0.2756	69.0	109.0	7.00
R5107.3	–	7.30	0.2874	69.0	109.0	7.30

Product	DC (inch)	DC (mm)	DC (inch)	LCF (mm)	OAL (mm)	DCON MS (mm)
R5107.4	–	7.40	0.2913	69.0	109.0	7.40
R5107.5	–	7.50	0.2953	69.0	109.0	7.50
R5107.8	–	7.80	0.3071	75.0	117.0	7.80
R5105/16	5/16	7.94	0.3126	75.0	117.0	7.94
R5108.0	–	8.00	0.3150	75.0	117.0	8.00
R5108.5	–	8.50	0.3346	75.0	117.0	8.50
R5108.7	–	8.70	0.3425	81.0	125.0	8.70
R5108.8	–	8.80	0.3465	81.0	125.0	8.80
R5109.0	–	9.00	0.3543	81.0	125.0	9.00
R5109.2	–	9.20	0.3622	81.0	125.0	9.20
R5109.3	–	9.30	0.3661	81.0	125.0	9.30
R5109.5	–	9.50	0.3740	81.0	125.0	9.50
R5103/8	3/8	9.52	0.3748	87.0	133.0	9.52
R5109.9	–	9.90	0.3898	87.0	133.0	9.90
R51010.0	–	10.00	0.3937	87.0	133.0	10.00
R51010.2	–	10.20	0.4016	87.0	133.0	10.20
R51010.3	–	10.30	0.4055	87.0	133.0	10.30
R51010.4	–	10.40	0.4094	87.0	133.0	10.40
R51010.5	–	10.50	0.4134	87.0	133.0	10.50
R51010.8	–	10.80	0.4252	94.0	142.0	10.80
R51011.0	–	11.00	0.4331	94.0	142.0	11.00
R5107/16	7/16	11.11	0.4374	94.0	142.0	11.11
R51011.2	–	11.20	0.4409	94.0	142.0	11.20
R51011.5	–	11.50	0.4528	94.0	142.0	11.50
R51012.0	–	12.00	0.4724	101.0	151.0	12.00
R5101/2	1/2	12.70	0.5000	101.0	151.0	12.70
R51013.0	–	13.00	0.5118	101.0	151.0	13.00
R51014.0	–	14.00	0.5512	108.0	160.0	14.00

R458



FORCE X-borr av solid hårdmetall, borrhjup 3xD, TiAlN-belag

Högproduktivt borr som ger hål med hög noggrannhet och finish. H9-tolerans möjlig under rätt förhållanden. 140° spetsvinkel och 4-fasettspetslipning. Spårutformning med CTW-design. TiAlN-beläggning ökar slitstyrka och livslängd. Lämpar sig för borrar i de flesta material.

FORCE X

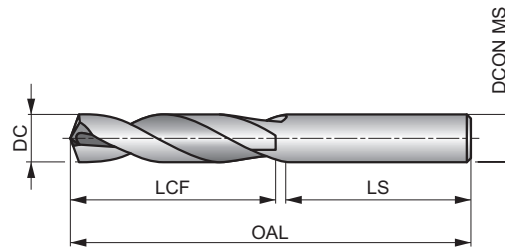

HM	DIN 6537K	3xD
140°	TiAlN	DIN 6535HA
CTW	R	DC m7

Arbetsmaterialgrupper och startvärden för skärhastighet (m/min) och matningskod. Tabeller med matningar finns med början på sidan 274

P1.1 ■ 143 W	P1.2 ■ 160 W	P1.3 ■ 166 W	P2.1 ■ 122 W	P2.2 ■ 108 W	P2.3 ■ 95 V	P3.1 ■ 106 V	P3.2 ■ 86 V	P3.3 ■ 72 V	P4.1 ■ 63 V	P4.2 ■ 54 V	P4.3 ■ 44 U	M1.1 □ 60 U	M1.2 □ 51 U
M2.1 □ 54 U	M2.2 □ 44 U	M2.3 □ 37 T	M3.1 □ 33 T	M3.2 □ 28 T	M3.3 □ 26 T	M4.1 □ 24 T	M4.2 □ 21 T	K1.1 ■ 88 W	K1.2 ■ 65 W	K1.3 ■ 49 W	K2.1 ■ 78 V	K2.2 ■ 64 V	K2.3 ■ 51 V
K3.1 ■ 70 V	K3.2 ■ 54 V	K3.3 ■ 43 V	K4.1 ■ 65 V	K4.2 ■ 49 V	K4.3 ■ 36 V	K4.4 ■ 30 V	K4.5 ■ 26 V	K5.1 ■ 73 V	K5.2 ■ 55 V	K5.3 ■ 42 V	N1.1 ■ 200 W	N1.2 ■ 150 W	N1.3 ■ 100 W
N2.1 ■ 246 V	N2.2 ■ 222 V	N2.3 ■ 160 V	N3.1 ■ 298 V	N3.2 ■ 176 V	N3.3 ■ 88 V	S1.1 □ 44 U	S1.2 □ 36 U	S1.3 □ 32 T	H1.1 ■ 45 U	H2.1 □ 26 U	H2.2 □ 24 U	H3.1 □ 30 U	H3.2 □ 24 U

DCON MS tolerans h6.

Product	DC (inch)	DC (mm)	DC (inch)	LCF (mm)	OAL (mm)	LS (mm)	DCON MS (mm)
R4583.0	–	3.00	0.1181	20.0	62.0	36.0	6.00
R4583.1	–	3.10	0.1220	20.0	62.0	36.0	6.00
R4581/8	1/8	3.18	0.1250	20.0	62.0	36.0	6.00
R4583.2	–	3.20	0.1260	20.0	62.0	36.0	6.00
R458N30	N30	3.26	0.1283	20.0	62.0	36.0	6.00
R4583.3	–	3.30	0.1299	20.0	62.0	36.0	6.00
R4583.4	–	3.40	0.1339	20.0	62.0	36.0	6.00
R458N29	N29	3.45	0.1360	20.0	62.0	36.0	6.00
R4583.5	–	3.50	0.1378	20.0	62.0	36.0	6.00
R458N28	N28	3.57	0.1406	20.0	62.0	36.0	6.00
R4589/64	9/64	3.57	0.1406	20.0	62.0	36.0	6.00
R4583.6	–	3.60	0.1417	20.0	62.0	36.0	6.00
R458N27	N27	3.66	0.1441	20.0	62.0	36.0	6.00
R4583.7	–	3.70	0.1457	20.0	62.0	36.0	6.00
R4583.73	–	3.73	0.1469	24.0	66.0	36.0	6.00
R458N26	N26	3.73	0.1469	24.0	66.0	36.0	6.00
R458N25	N25	3.80	0.1496	24.0	66.0	36.0	6.00
R4583.8	–	3.80	0.1496	24.0	66.0	36.0	6.00
R458N24	N24	3.86	0.1520	24.0	66.0	36.0	6.00
R4583.9	–	3.90	0.1535	24.0	66.0	36.0	6.00
R458N23	N23	3.91	0.1539	24.0	66.0	36.0	6.00
R4585/32	5/32	3.97	0.1563	24.0	66.0	36.0	6.00
R458N22	N22	3.99	0.1571	24.0	66.0	36.0	6.00
R4584.0	–	4.00	0.1575	24.0	66.0	36.0	6.00
R458N21	N21	4.04	0.1591	24.0	66.0	36.0	6.00

Product	DC	DC	DC	LCF	OAL	LS	DCON MS
	(inch)	(mm)	(inch)	(mm)	(mm)	(mm)	(mm)
R458N20	N20	4.09	0.1610	24.0	66.0	36.0	6.00
R4584.1	–	4.10	0.1614	24.0	66.0	36.0	6.00
R4584.2	–	4.20	0.1654	24.0	66.0	36.0	6.00
R458N19	N19	4.22	0.1661	24.0	66.0	36.0	6.00
R4584.3	–	4.30	0.1693	24.0	66.0	36.0	6.00
R458N18	N18	4.31	0.1697	24.0	66.0	36.0	6.00
R45811/64	11/64	4.37	0.1719	24.0	66.0	36.0	6.00
R458N17	N17	4.39	0.1728	24.0	66.0	36.0	6.00
R4584.4	–	4.40	0.1732	24.0	66.0	36.0	6.00
R4584.5	–	4.50	0.1772	24.0	66.0	36.0	6.00
R458N16	N16	4.50	0.1772	24.0	66.0	36.0	6.00
R458N15	N15	4.57	0.1799	24.0	66.0	36.0	6.00
R4584.6	–	4.60	0.1811	24.0	66.0	36.0	6.00
R458N14	N14	4.62	0.1819	24.0	66.0	36.0	6.00
R458N13	N13	4.70	0.1850	24.0	66.0	36.0	6.00
R4584.7	–	4.70	0.1850	24.0	66.0	36.0	6.00
R4583/16	3/16	4.76	0.1875	28.0	66.0	36.0	6.00
R4584.8	–	4.80	0.1890	28.0	66.0	36.0	6.00
R458N12	N12	4.80	0.1890	28.0	66.0	36.0	6.00
R458N11	N11	4.85	0.1909	28.0	66.0	36.0	6.00
R4584.9	–	4.90	0.1929	28.0	66.0	36.0	6.00
R458N10	N10	4.92	0.1937	28.0	66.0	36.0	6.00
R458N9	N9	4.98	0.1961	28.0	66.0	36.0	6.00
R4585.0	–	5.00	0.1969	28.0	66.0	36.0	6.00
R458N8	N8	5.06	0.1992	28.0	66.0	36.0	6.00
R4585.1	–	5.10	0.2008	28.0	66.0	36.0	6.00
R458N7	N7	5.11	0.2010	28.0	66.0	36.0	6.00
R45813/64	13/64	5.16	0.2031	28.0	66.0	36.0	6.00
R458N6	N6	5.18	0.2039	28.0	66.0	36.0	6.00
R4585.2	–	5.20	0.2047	28.0	66.0	36.0	6.00
R458N5	N5	5.22	0.2055	28.0	66.0	36.0	6.00
R4585.3	–	5.30	0.2087	28.0	66.0	36.0	6.00
R458N4	N4	5.31	0.2091	28.0	66.0	36.0	6.00
R4585.4	–	5.40	0.2126	28.0	66.0	36.0	6.00
R458N3	N3	5.41	0.2130	28.0	66.0	36.0	6.00
R4585.5	–	5.50	0.2165	28.0	66.0	36.0	6.00
R4587/32	7/32	5.56	0.2188	28.0	66.0	36.0	6.00
R4585.6	–	5.60	0.2205	28.0	66.0	36.0	6.00
R458N2	N2	5.61	0.2209	28.0	66.0	36.0	6.00
R4585.7	–	5.70	0.2244	28.0	66.0	36.0	6.00
R458N1	N1	5.79	0.2280	28.0	66.0	36.0	6.00
R4585.8	–	5.80	0.2283	28.0	66.0	36.0	6.00
R4585.9	–	5.90	0.2323	28.0	66.0	36.0	6.00
R45815/64	15/64	5.95	0.2344	28.0	66.0	36.0	6.00
R4586.0	–	6.00	0.2362	28.0	66.0	36.0	6.00
R458B	B	6.05	0.2380	34.0	79.0	36.0	8.00
R4586.1	–	6.10	0.2402	34.0	79.0	36.0	8.00
R458C	C	6.15	0.2421	34.0	79.0	36.0	8.00
R4586.2	–	6.20	0.2441	34.0	79.0	36.0	8.00
R458D	D	6.25	0.2461	34.0	79.0	36.0	8.00
R4586.3	–	6.30	0.2480	34.0	79.0	36.0	8.00
R4581/4	1/4	6.35	0.2500	34.0	79.0	36.0	8.00
R4586.4	–	6.40	0.2520	34.0	79.0	36.0	8.00
R4586.5	–	6.50	0.2559	34.0	79.0	36.0	8.00
R458F	F	6.53	0.2571	34.0	79.0	36.0	8.00
R4586.6	–	6.60	0.2598	34.0	79.0	36.0	8.00
R458G	G	6.63	0.2610	34.0	79.0	36.0	8.00
R4586.7	–	6.70	0.2638	34.0	79.0	36.0	8.00
R45817/64	17/64	6.75	0.2656	34.0	79.0	36.0	8.00
R458H	H	6.76	0.2661	34.0	79.0	36.0	8.00
R4586.8	–	6.80	0.2677	34.0	79.0	36.0	8.00
R4586.9	–	6.90	0.2717	34.0	79.0	36.0	8.00



Product	DC	DC	DC	LCF	OAL	LS	DCON MS
	(inch)	(mm)	(inch)	(mm)	(mm)	(mm)	(mm)
R458I	I	6.91	0.2720	34.0	79.0	36.0	8.00
R4587.0	–	7.00	0.2756	34.0	79.0	36.0	8.00
R458J	J	7.04	0.2772	34.0	79.0	36.0	8.00
R4587.1	–	7.10	0.2795	41.0	79.0	36.0	8.00
R4589/32	9/32	7.14	0.2813	41.0	79.0	36.0	8.00
R4587.2	–	7.20	0.2835	41.0	79.0	36.0	8.00
R4587.3	–	7.30	0.2874	41.0	79.0	36.0	8.00
R458L	L	7.37	0.2902	41.0	79.0	36.0	8.00
R4587.4	–	7.40	0.2913	41.0	79.0	36.0	8.00
R4587.5	–	7.50	0.2953	41.0	79.0	36.0	8.00
R45819/64	19/64	7.54	0.2969	41.0	79.0	36.0	8.00
R4587.6	–	7.60	0.2992	41.0	79.0	36.0	8.00
R458N	N	7.67	0.3020	41.0	79.0	36.0	8.00
R4587.7	–	7.70	0.3031	41.0	79.0	36.0	8.00
R4587.8	–	7.80	0.3071	41.0	79.0	36.0	8.00
R4587.9	–	7.90	0.3110	41.0	79.0	36.0	8.00
R4585/16	5/16	7.94	0.3125	41.0	79.0	36.0	8.00
R4588.0	–	8.00	0.3150	41.0	79.0	36.0	8.00
R4580	O	8.03	0.3161	47.0	89.0	40.0	10.00
R4588.1	–	8.10	0.3189	47.0	89.0	40.0	10.00
R4588.2	–	8.20	0.3228	47.0	89.0	40.0	10.00
R4588.3	–	8.30	0.3268	47.0	89.0	40.0	10.00
R45821/64	21/64	8.33	0.3281	47.0	89.0	40.0	10.00
R4588.4	–	8.40	0.3307	47.0	89.0	40.0	10.00
R458Q	Q	8.43	0.3319	47.0	89.0	40.0	10.00
R4588.5	–	8.50	0.3346	47.0	89.0	40.0	10.00
R4588.6	–	8.60	0.3386	47.0	89.0	40.0	10.00
R458R	R	8.61	0.3390	47.0	89.0	40.0	10.00
R4588.7	–	8.70	0.3425	47.0	89.0	40.0	10.00
R45811/32	11/32	8.73	0.3438	47.0	89.0	40.0	10.00
R4588.8	–	8.80	0.3465	47.0	89.0	40.0	10.00
R458S	S	8.84	0.3480	47.0	89.0	40.0	10.00
R4588.9	–	8.90	0.3504	47.0	89.0	40.0	10.00
R4589.0	–	9.00	0.3543	47.0	89.0	40.0	10.00
R458T	T	9.09	0.3579	47.0	89.0	40.0	10.00
R4589.1	–	9.10	0.3583	47.0	89.0	40.0	10.00
R45823/64	23/64	9.13	0.3594	47.0	89.0	40.0	10.00
R4589.2	–	9.20	0.3622	47.0	89.0	40.0	10.00
R4589.3	–	9.30	0.3661	47.0	89.0	40.0	10.00
R458U	U	9.35	0.3681	47.0	89.0	40.0	10.00
R4589.4	–	9.40	0.3701	47.0	89.0	40.0	10.00
R4589.5	–	9.50	0.3740	47.0	89.0	40.0	10.00
R4583/8	3/8	9.53	0.3750	47.0	89.0	40.0	10.00
R458V	V	9.58	0.3772	47.0	89.0	40.0	10.00
R4589.6	–	9.60	0.3780	47.0	89.0	40.0	10.00
R4589.7	–	9.70	0.3819	47.0	89.0	40.0	10.00
R4589.8	–	9.80	0.3858	47.0	89.0	40.0	10.00
R4589.9	–	9.90	0.3898	47.0	89.0	40.0	10.00
R45825/64	25/64	9.92	0.3906	47.0	89.0	40.0	10.00
R45810.0	–	10.00	0.3937	47.0	89.0	40.0	10.00
R458X	X	10.08	0.3969	55.0	102.0	45.0	12.00
R45810.1	–	10.10	0.3976	55.0	102.0	45.0	12.00
R45810.2	–	10.20	0.4016	55.0	102.0	45.0	12.00
R458Y	Y	10.26	0.4039	55.0	102.0	45.0	12.00
R45810.3	–	10.30	0.4055	55.0	102.0	45.0	12.00
R45813/32	13/32	10.32	0.4063	55.0	102.0	45.0	12.00
R45810.4	–	10.40	0.4094	55.0	102.0	45.0	12.00
R45810.5	–	10.50	0.4134	55.0	102.0	45.0	12.00
R45810.6	–	10.60	0.4173	55.0	102.0	45.0	12.00
R45810.7	–	10.70	0.4213	55.0	102.0	45.0	12.00
R45827/64	27/64	10.72	0.4219	55.0	102.0	45.0	12.00
R45810.8	–	10.80	0.4252	55.0	102.0	45.0	12.00

Product	DC	DC	DC	LCF	OAL	LS	DCON MS
	(inch)	(mm)	(inch)	(mm)	(mm)	(mm)	(mm)
R45810.9	–	10.90	0.4291	55.0	102.0	45.0	12.00
R45811.0	–	11.00	0.4331	55.0	102.0	45.0	12.00
R45811.1	–	11.10	0.4370	55.0	102.0	45.0	12.00
R4587/16	7/16	11.11	0.4375	55.0	102.0	45.0	12.00
R45811.2	–	11.20	0.4409	55.0	102.0	45.0	12.00
R45811.3	–	11.30	0.4449	55.0	102.0	45.0	12.00
R45811.4	–	11.40	0.4488	55.0	102.0	45.0	12.00
R45811.5	–	11.50	0.4528	55.0	102.0	45.0	12.00
R45829/64	29/64	11.51	0.4531	55.0	102.0	45.0	12.00
R45811.6	–	11.60	0.4567	55.0	102.0	45.0	12.00
R45811.7	–	11.70	0.4606	55.0	102.0	45.0	12.00
R45811.8	–	11.80	0.4646	55.0	102.0	45.0	12.00
R45811.9	–	11.90	0.4685	55.0	102.0	45.0	12.00
R45815/32	15/32	11.91	0.4688	55.0	102.0	45.0	12.00
R45812.0	–	12.00	0.4724	55.0	102.0	45.0	12.00
R45812.1	–	12.10	0.4764	60.0	107.0	45.0	14.00
R45812.2	–	12.20	0.4803	60.0	107.0	45.0	14.00
R45831/64	31/64	12.30	0.4844	60.0	107.0	45.0	14.00
R45812.5	–	12.50	0.4921	60.0	107.0	45.0	14.00
R45812.7	–	12.70	0.5000	60.0	107.0	45.0	14.00
R4581/2	1/2	12.70	0.5000	60.0	107.0	45.0	14.00
R45812.8	–	12.80	0.5039	60.0	107.0	45.0	14.00
R45813.0	–	13.00	0.5118	60.0	107.0	45.0	14.00
R45833/64	33/64	13.10	0.5156	60.0	107.0	45.0	14.00
R45813.3	–	13.30	0.5236	60.0	107.0	45.0	14.00
R45817/32	17/32	13.49	0.5313	60.0	107.0	45.0	14.00
R45813.5	–	13.50	0.5315	60.0	107.0	45.0	14.00
R45813.8	–	13.80	0.5433	60.0	107.0	45.0	14.00
R45835/64	35/64	13.89	0.5469	60.0	107.0	45.0	14.00
R45814.0	–	14.00	0.5512	60.0	107.0	45.0	14.00
R45814.25	–	14.25	0.5610	65.0	115.0	48.0	16.00
R4589/16	9/16	14.29	0.5625	65.0	115.0	48.0	16.00
R45814.5	–	14.50	0.5709	65.0	115.0	48.0	16.00
R45837/64	37/64	14.68	0.5781	65.0	115.0	48.0	16.00
R45814.8	–	14.80	0.5827	65.0	115.0	48.0	16.00
R45815.0	–	15.00	0.5906	65.0	115.0	48.0	16.00
R45819/32	19/32	15.08	0.5938	65.0	115.0	48.0	16.00
R45815.1	–	15.10	0.5945	65.0	115.0	48.0	16.00
R45815.3	–	15.30	0.6024	65.0	115.0	48.0	16.00
R45839/64	39/64	15.48	0.6094	65.0	115.0	48.0	16.00
R45815.5	–	15.50	0.6102	65.0	115.0	48.0	16.00
R45815.8	–	15.80	0.6220	65.0	115.0	48.0	16.00
R4585/8	5/8	15.88	0.6250	65.0	115.0	48.0	16.00
R45816.0	–	16.00	0.6299	65.0	115.0	48.0	16.00
R45841/64	41/64	16.27	0.6406	73.0	123.0	48.0	18.00
R45816.5	–	16.50	0.6496	73.0	123.0	48.0	18.00
R45821/32	21/32	16.67	0.6563	73.0	123.0	48.0	18.00
R45817.0	–	17.00	0.6693	73.0	123.0	48.0	18.00
R45843/64	43/64	17.07	0.6720	73.0	123.0	48.0	18.00
R45811/16	11/16	17.46	0.6874	73.0	123.0	48.0	18.00
R45817.5	–	17.50	0.6890	73.0	123.0	48.0	18.00
R45817.8	–	17.80	0.7008	73.0	123.0	48.0	18.00
R45845/64	45/64	17.86	0.7031	73.0	123.0	48.0	18.00
R45818.0	–	18.00	0.7087	73.0	123.0	48.0	18.00
R45823/32	23/32	18.26	0.7189	79.0	131.0	50.0	20.00
R45818.5	–	18.50	0.7283	79.0	131.0	50.0	20.00
R45847/64	47/64	18.65	0.7343	79.0	131.0	50.0	20.00
R45819.0	–	19.00	0.7480	79.0	131.0	50.0	20.00
R4583/4	–	19.05	0.7500	79.0	131.0	50.0	20.00
R45819.5	–	19.50	0.7677	79.0	131.0	50.0	20.00
R45819.8	–	19.80	0.7795	79.0	131.0	50.0	20.00
R45820.0	–	20.00	0.7874	79.0	131.0	50.0	20.00

R457



FORCE X-borr av solid hårdmetall, borrhjup 3xD, invändiga kylkanaler, TiAIN-belagd

Högproduktivt borr som ger hål med hög noggrannhet och finish. H9-tolerans möjlig under rätt förhållanden. 140° spetsvinkel och 4-fasettspetslipning. Spårutformning med CTW-design. Invändiga kylkanaler. TiAIN-beläggning ökar slitstyrka och livslängd. Lämpar sig för borrhjup i de flesta material.

FORCE X

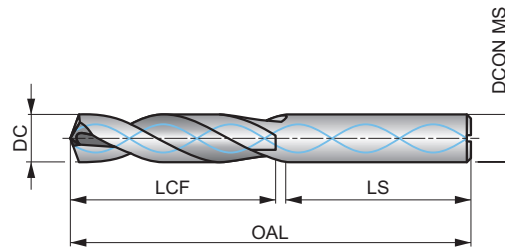

HM	DIN 6537K	3xD
140°	TiAIN	DIN 6535HA
CTW	R	
DC m7		

Arbetsmaterialgrupper och startvärden för skärhastighet (m/min) och matningskod. Tabeller med matningar finns med början på sidan 274

P1.1 ■ 179 W	P1.2 ■ 200 W	P1.3 ■ 207 W	P2.1 ■ 153 W	P2.2 ■ 135 W	P2.3 ■ 119 V	P3.1 ■ 133 V	P3.2 ■ 107 V	P3.3 ■ 90 V	P4.1 ■ 79 V	P4.2 ■ 67 V	P4.3 ■ 55 U	M1.1 ▣ 75 V	M1.2 ▣ 64 V
M2.1 ▣ 67 V	M2.2 ▣ 55 V	M2.3 ▣ 46 U	M3.1 ▣ 41 V	M3.2 ▣ 35 V	M3.3 ▣ 32 V	M4.1 ▣ 30 U	M4.2 ▣ 26 U	K1.1 ■ 110 W	K1.2 ■ 81 W	K1.3 ■ 61 W	K2.1 ■ 98 V	K2.2 ■ 80 V	K2.3 ■ 64 V
K3.1 ■ 87 V	K3.2 ■ 67 V	K3.3 ■ 54 V	K4.1 ■ 81 V	K4.2 ■ 61 V	K4.3 ■ 45 V	K4.4 ■ 38 V	K4.5 ■ 32 V	K5.1 ■ 91 V	K5.2 ■ 69 V	K5.3 ■ 53 V	N1.1 ■ 250 W	N1.2 ■ 188 W	N1.3 ■ 125 W
N2.1 ■ 308 V	N2.2 ■ 277 V	N2.3 ■ 200 V	N3.1 ■ 373 W	N3.2 ■ 220 W	N3.3 ■ 110 W	S1.1 ■ 55 V	S1.2 ■ 45 V	S1.3 ■ 40 U	H1.1 ■ 56 U	H2.1 ▣ 33 U	H2.2 ▣ 30 U	H3.1 ▣ 37 U	H3.2 ▣ 30 U

DCON MS tolerans h6.

Product	DC (inch)	DC (mm)	DC (inch)	LCF (mm)	OAL (mm)	LS (mm)	DCON MS (mm)
R4573.0	–	3.00	0.1181	20.0	62.0	36.0	6.00
R4573.1	–	3.10	0.1220	20.0	62.0	36.0	6.00
R4571/8	1/8	3.18	0.1250	20.0	62.0	36.0	6.00
R4573.2	–	3.20	0.1260	20.0	62.0	36.0	6.00
R457N30	N30	3.26	0.1283	20.0	62.0	36.0	6.00
R4573.3	–	3.30	0.1299	20.0	62.0	36.0	6.00
R4573.4	–	3.40	0.1339	20.0	62.0	36.0	6.00
R457N29	N29	3.45	0.1360	20.0	62.0	36.0	6.00
R4573.5	–	3.50	0.1378	20.0	62.0	36.0	6.00
R457N28	N28	3.57	0.1406	20.0	62.0	36.0	6.00
R4579/64	9/64	3.57	0.1406	20.0	62.0	36.0	6.00
R4573.6	–	3.60	0.1417	20.0	62.0	36.0	6.00
R457N27	N27	3.66	0.1441	20.0	62.0	36.0	6.00
R4573.7	–	3.70	0.1457	20.0	62.0	36.0	6.00
R457N26	N26	3.73	0.1469	24.0	66.0	36.0	6.00
R457N25	N25	3.80	0.1496	24.0	66.0	36.0	6.00
R4573.8	–	3.80	0.1496	24.0	66.0	36.0	6.00
R457N24	N24	3.86	0.1520	24.0	66.0	36.0	6.00
R4573.9	–	3.90	0.1535	24.0	66.0	36.0	6.00
R457N23	N23	3.91	0.1539	24.0	66.0	36.0	6.00
R4575/32	5/32	3.97	0.1563	24.0	66.0	36.0	6.00
R457N22	N22	3.99	0.1571	24.0	66.0	36.0	6.00
R4574.0	–	4.00	0.1575	24.0	66.0	36.0	6.00
R457N21	N21	4.04	0.1591	24.0	66.0	36.0	6.00
R4574.05	–	4.05	0.1594	24.0	66.0	36.0	6.00

Product	DC	DC	DC	LCF	OAL	LS	DCON MS
	(inch)	(mm)	(inch)	(mm)	(mm)	(mm)	(mm)
R457N20	N20	4.09	0.1610	24.0	66.0	36.0	6.00
R4574.1	–	4.10	0.1614	24.0	66.0	36.0	6.00
R4574.2	–	4.20	0.1654	24.0	66.0	36.0	6.00
R4574.3	–	4.30	0.1693	24.0	66.0	36.0	6.00
R457N18	N18	4.31	0.1697	24.0	66.0	36.0	6.00
R45711/64	11/64	4.37	0.1719	24.0	66.0	36.0	6.00
R457N17	N17	4.39	0.1728	24.0	66.0	36.0	6.00
R4574.4	–	4.40	0.1732	24.0	66.0	36.0	6.00
R4574.5	–	4.50	0.1772	24.0	66.0	36.0	6.00
R457N16	N16	4.50	0.1772	24.0	66.0	36.0	6.00
R457N15	N15	4.57	0.1799	24.0	66.0	36.0	6.00
R4574.6	–	4.60	0.1811	24.0	66.0	36.0	6.00
R457N14	N14	4.62	0.1819	24.0	66.0	36.0	6.00
R4574.7	–	4.70	0.1850	24.0	66.0	36.0	6.00
R4573/16	3/16	4.76	0.1875	28.0	66.0	36.0	6.00
R4574.8	–	4.80	0.1890	28.0	66.0	36.0	6.00
R457N11	N11	4.85	0.1909	28.0	66.0	36.0	6.00
R4574.9	–	4.90	0.1929	28.0	66.0	36.0	6.00
R457N9	N9	4.98	0.1961	28.0	66.0	36.0	6.00
R4575.0	–	5.00	0.1969	28.0	66.0	36.0	6.00
R4575.05	–	5.05	0.1988	28.0	66.0	36.0	6.00
R457N8	N8	5.06	0.1992	28.0	66.0	36.0	6.00
R4575.1	–	5.10	0.2008	28.0	66.0	36.0	6.00
R457N7	N7	5.11	0.2010	28.0	66.0	36.0	6.00
R45713/64	13/64	5.16	0.2031	28.0	66.0	36.0	6.00
R457N6	N6	5.18	0.2039	28.0	66.0	36.0	6.00
R4575.2	–	5.20	0.2047	28.0	66.0	36.0	6.00
R457N5	N5	5.22	0.2055	28.0	66.0	36.0	6.00
R4575.3	–	5.30	0.2087	28.0	66.0	36.0	6.00
R457N4	N4	5.31	0.2091	28.0	66.0	36.0	6.00
R4575.4	–	5.40	0.2126	28.0	66.0	36.0	6.00
R457N3	N3	5.41	0.2130	28.0	66.0	36.0	6.00
R4575.5	–	5.50	0.2165	28.0	66.0	36.0	6.00
R4577/32	7/32	5.56	0.2188	28.0	66.0	36.0	6.00
R4575.6	–	5.60	0.2205	28.0	66.0	36.0	6.00
R457N2	N2	5.61	0.2209	28.0	66.0	36.0	6.00
R4575.7	–	5.70	0.2244	28.0	66.0	36.0	6.00
R457N1	N1	5.79	0.2280	28.0	66.0	36.0	6.00
R4575.8	–	5.80	0.2283	28.0	66.0	36.0	6.00
R4575.9	–	5.90	0.2323	28.0	66.0	36.0	6.00
R457A	A	5.94	0.2339	28.0	66.0	36.0	6.00
R45715/64	15/64	5.95	0.2344	28.0	66.0	36.0	6.00
R4576.0	–	6.00	0.2362	28.0	66.0	36.0	6.00
R457B	B	6.05	0.2380	34.0	79.0	36.0	8.00
R4576.05	–	6.05	0.2382	34.0	79.0	36.0	8.00
R4576.1	–	6.10	0.2402	34.0	79.0	36.0	8.00
R457C	C	6.15	0.2421	34.0	79.0	36.0	8.00
R4576.2	–	6.20	0.2441	34.0	79.0	36.0	8.00
R457D	D	6.25	0.2461	34.0	79.0	36.0	8.00
R4576.3	–	6.30	0.2480	34.0	79.0	36.0	8.00
R4571/4	1/4	6.35	0.2500	34.0	79.0	36.0	8.00
R4576.4	–	6.40	0.2520	34.0	79.0	36.0	8.00
R4576.5	–	6.50	0.2559	34.0	79.0	36.0	8.00
R457F	F	6.53	0.2571	34.0	79.0	36.0	8.00
R4576.6	–	6.60	0.2598	34.0	79.0	36.0	8.00
R457G	G	6.63	0.2610	34.0	79.0	36.0	8.00
R4576.7	–	6.70	0.2638	34.0	79.0	36.0	8.00
R45717/64	17/64	6.75	0.2656	34.0	79.0	36.0	8.00
R4576.8	–	6.80	0.2677	34.0	79.0	36.0	8.00
R4576.9	–	6.90	0.2717	34.0	79.0	36.0	8.00
R457I	I	6.91	0.2720	34.0	79.0	36.0	8.00
R4577.0	–	7.00	0.2756	34.0	79.0	36.0	8.00

Product	DC	DC	DC	LCF	OAL	LS	DCON MS
	(inch)	(mm)	(inch)	(mm)	(mm)	(mm)	(mm)
R457J	J	7.04	0.2772	41.0	79.0	36.0	8.00
R4577.1	–	7.10	0.2795	41.0	79.0	36.0	8.00
R4579/32	9/32	7.14	0.2813	41.0	79.0	36.0	8.00
R4577.2	–	7.20	0.2835	41.0	79.0	36.0	8.00
R4577.3	–	7.30	0.2874	41.0	79.0	36.0	8.00
R4577.4	–	7.40	0.2913	41.0	79.0	36.0	8.00
R4577.5	–	7.50	0.2953	41.0	79.0	36.0	8.00
R45719/64	19/64	7.54	0.2969	41.0	79.0	36.0	8.00
R4577.6	–	7.60	0.2992	41.0	79.0	36.0	8.00
R457N	N	7.67	0.3020	41.0	79.0	36.0	8.00
R4577.7	–	7.70	0.3031	41.0	79.0	36.0	8.00
R4577.8	–	7.80	0.3071	41.0	79.0	36.0	8.00
R4577.9	–	7.90	0.3110	41.0	79.0	36.0	8.00
R4575/16	5/16	7.94	0.3125	41.0	79.0	36.0	8.00
R4578.0	–	8.00	0.3150	41.0	79.0	36.0	8.00
R4570	O	8.03	0.3161	47.0	89.0	40.0	10.00
R4578.05	–	8.05	0.3169	47.0	89.0	40.0	10.00
R4578.1	–	8.10	0.3189	47.0	89.0	40.0	10.00
R4578.2	–	8.20	0.3228	47.0	89.0	40.0	10.00
R457P	P	8.20	0.3228	47.0	89.0	40.0	10.00
R4578.3	–	8.30	0.3268	47.0	89.0	40.0	10.00
R45721/64	21/64	8.33	0.3281	47.0	89.0	40.0	10.00
R4578.4	–	8.40	0.3307	47.0	89.0	40.0	10.00
R457Q	Q	8.43	0.3319	47.0	89.0	40.0	10.00
R4578.5	–	8.50	0.3346	47.0	89.0	40.0	10.00
R4578.6	–	8.60	0.3386	47.0	89.0	40.0	10.00
R457R	R	8.61	0.3390	47.0	89.0	40.0	10.00
R4578.7	–	8.70	0.3425	47.0	89.0	40.0	10.00
R45711/32	11/32	8.73	0.3438	47.0	89.0	40.0	10.00
R4578.8	–	8.80	0.3465	47.0	89.0	40.0	10.00
R457S	S	8.84	0.3480	47.0	89.0	40.0	10.00
R4578.9	–	8.90	0.3504	47.0	89.0	40.0	10.00
R4579.0	–	9.00	0.3543	47.0	89.0	40.0	10.00
R4579.1	–	9.10	0.3583	47.0	89.0	40.0	10.00
R45723/64	23/64	9.13	0.3594	47.0	89.0	40.0	10.00
R4579.2	–	9.20	0.3622	47.0	89.0	40.0	10.00
R4579.3	–	9.30	0.3661	47.0	89.0	40.0	10.00
R457U	U	9.35	0.3681	47.0	89.0	40.0	10.00
R4579.4	–	9.40	0.3701	47.0	89.0	40.0	10.00
R4579.5	–	9.50	0.3740	47.0	89.0	40.0	10.00
R4573/8	3/8	9.53	0.3750	47.0	89.0	40.0	10.00
R457V	V	9.58	0.3772	47.0	89.0	40.0	10.00
R4579.6	–	9.60	0.3780	47.0	89.0	40.0	10.00
R4579.7	–	9.70	0.3819	47.0	89.0	40.0	10.00
R4579.8	–	9.80	0.3858	47.0	89.0	40.0	10.00
R457W	W	9.80	0.3858	47.0	89.0	40.0	10.00
R4579.9	–	9.90	0.3898	47.0	89.0	40.0	10.00
R45725/64	25/64	9.92	0.3906	47.0	89.0	40.0	10.00
R45710.0	–	10.00	0.3937	47.0	89.0	40.0	10.00
R45710.05	–	10.05	0.3957	55.0	102.0	45.0	12.00
R457X	X	10.08	0.3969	55.0	102.0	45.0	12.00
R45710.1	–	10.10	0.3976	55.0	102.0	45.0	12.00
R45710.2	–	10.20	0.4016	55.0	102.0	45.0	12.00
R457Y	Y	10.26	0.4039	55.0	102.0	45.0	12.00
R45710.3	–	10.30	0.4055	55.0	102.0	45.0	12.00
R45713/32	13/32	10.32	0.4063	55.0	102.0	45.0	12.00
R45710.4	–	10.40	0.4094	55.0	102.0	45.0	12.00
R457Z	Z	10.49	0.4130	55.0	102.0	45.0	12.00
R45710.5	–	10.50	0.4134	55.0	102.0	45.0	12.00
R45710.6	–	10.60	0.4173	55.0	102.0	45.0	12.00
R45727/64	27/64	10.72	0.4219	55.0	102.0	45.0	12.00
R45710.8	–	10.80	0.4252	55.0	102.0	45.0	12.00

Product	DC	DC	DC	LCF	OAL	LS	DCON MS
	(inch)	(mm)	(inch)	(mm)	(mm)	(mm)	(mm)
R45711.0	–	11.00	0.4331	55.0	102.0	45.0	12.00
R4577/16	7/16	11.11	0.4375	55.0	102.0	45.0	12.00
R45711.2	–	11.20	0.4409	55.0	102.0	45.0	12.00
R45711.3	–	11.30	0.4449	55.0	102.0	45.0	12.00
R45711.4	–	11.40	0.4488	55.0	102.0	45.0	12.00
R45711.5	–	11.50	0.4528	55.0	102.0	45.0	12.00
R45729/64	29/64	11.51	0.4531	55.0	102.0	45.0	12.00
R45711.6	–	11.60	0.4567	55.0	102.0	45.0	12.00
R45711.8	–	11.80	0.4646	55.0	102.0	45.0	12.00
R45715/32	15/32	11.91	0.4688	55.0	102.0	45.0	12.00
R45712.0	–	12.00	0.4724	55.0	102.0	45.0	12.00
R45712.05	–	12.05	0.4744	60.0	107.0	45.0	14.00
R45712.1	–	12.10	0.4764	60.0	107.0	45.0	14.00
R45712.2	–	12.20	0.4803	60.0	107.0	45.0	14.00
R45731/64	31/64	12.30	0.4844	60.0	107.0	45.0	14.00
R45712.5	–	12.50	0.4921	60.0	107.0	45.0	14.00
R45712.7	–	12.70	0.5000	60.0	107.0	45.0	14.00
R4571/2	1/2	12.70	0.5000	60.0	107.0	45.0	14.00
R45712.8	–	12.80	0.5039	60.0	107.0	45.0	14.00
R45713.0	–	13.00	0.5118	60.0	107.0	45.0	14.00
R45733/64	33/64	13.10	0.5156	60.0	107.0	45.0	14.00
R45713.3	–	13.30	0.5236	60.0	107.0	45.0	14.00
R45717/32	17/32	13.49	0.5313	60.0	107.0	45.0	14.00
R45713.5	–	13.50	0.5315	60.0	107.0	45.0	14.00
R45713.8	–	13.80	0.5433	60.0	107.0	45.0	14.00
R45735/64	35/64	13.89	0.5469	60.0	107.0	45.0	14.00
R45714.0	–	14.00	0.5512	60.0	107.0	45.0	14.00
R45714.25	–	14.25	0.5610	65.0	115.0	48.0	16.00
R4579/16	9/16	14.29	0.5625	65.0	115.0	48.0	16.00
R45714.5	–	14.50	0.5709	65.0	115.0	48.0	16.00
R45737/64	37/64	14.68	0.5781	65.0	115.0	48.0	16.00
R45714.8	–	14.80	0.5827	65.0	115.0	48.0	16.00
R45715.0	–	15.00	0.5906	65.0	115.0	48.0	16.00
R45719/32	19/32	15.08	0.5938	65.0	115.0	48.0	16.00
R45715.1	–	15.10	0.5945	65.0	115.0	48.0	16.00
R45715.3	–	15.30	0.6024	65.0	115.0	48.0	16.00
R45739/64	39/64	15.48	0.6094	65.0	115.0	48.0	16.00
R45715.5	–	15.50	0.6102	65.0	115.0	48.0	16.00
R45715.8	–	15.80	0.6220	65.0	115.0	48.0	16.00
R4575/8	5/8	15.88	0.6250	65.0	115.0	48.0	16.00
R45716.0	–	16.00	0.6299	65.0	115.0	48.0	16.00
R45741/64	41/64	16.27	0.6406	73.0	123.0	48.0	18.00
R45716.5	–	16.50	0.6496	73.0	123.0	48.0	18.00
R45721/32	21/32	16.67	0.6563	73.0	123.0	48.0	18.00
R45717.0	–	17.00	0.6693	73.0	123.0	48.0	18.00
R45743/64	43/64	17.07	0.6720	73.0	123.0	48.0	18.00
R45711/16	11/16	17.46	0.6874	73.0	123.0	48.0	18.00
R45717.5	–	17.50	0.6890	73.0	123.0	48.0	18.00
R45745/64	45/64	17.86	0.7031	73.0	123.0	48.0	18.00
R45718.0	–	18.00	0.7087	73.0	123.0	48.0	18.00
R45723/32	23/32	18.26	0.7189	79.0	131.0	50.0	20.00
R45718.5	–	18.50	0.7283	79.0	131.0	50.0	20.00
R45747/64	47/64	18.65	0.7343	79.0	131.0	50.0	20.00
R45718.8	–	18.80	0.7402	79.0	131.0	50.0	20.00
R45719.0	–	19.00	0.7480	79.0	131.0	50.0	20.00
R4573/4	3/4	19.05	0.7500	79.0	131.0	50.0	20.00
R45719.5	–	19.50	0.7677	79.0	131.0	50.0	20.00
R45719.8	–	19.80	0.7795	79.0	131.0	50.0	20.00
R45720.0	–	20.00	0.7874	79.0	131.0	50.0	20.00

R454



FORCE X-borr av solid hårdmetall, borrhjup 5xD, TiAlN-belag

Högproduktivt borr som ger hål med hög noggrannhet och finish. H9-tolerans möjlig under rätt förhållanden. 140° spetsvinkel och 4-fasettspetslipning. Spårutformning med CTW-design. TiAlN-beläggning ökar slitstyrka och livslängd. Lämpar sig för borrar i de flesta material.

FORCE X

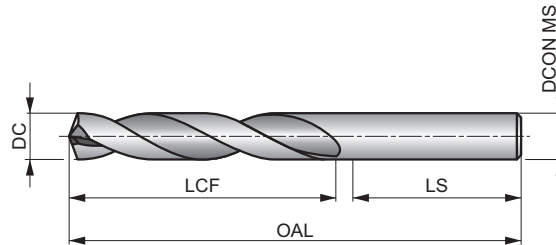

HM	DIN 6537L	5xD
140°	TiAlN	DIN 6535HA
CTW	R	DC m7

Arbetsmaterialgrupper och startvärden för skärhastighet (m/min) och matningskod. Tabeller med matningar finns med början på sidan 274

P1.1 ■ 134V	P1.2 ■ 150V	P1.3 ■ 155V	P2.1 ■ 115V	P2.2 ■ 101V	P2.3 ■ 89V	P3.1 ■ 100V	P3.2 ■ 80V	P3.3 ■ 68V	P4.1 ■ 59V	P4.2 ■ 50V	P4.3 ■ 41 U	M1.1 ▣ 56 U	M1.2 ▣ 48 U
M2.1 ▣ 50 U	M2.2 ▣ 41 U	M2.3 ▣ 35 T	M3.1 ▣ 31 T	M3.2 ▣ 26 T	M3.3 ▣ 24 T	M4.1 ▣ 23 T	M4.2 ▣ 20 T	K1.1 ■ 83 W	K1.2 ■ 61 W	K1.3 ■ 46 W	K2.1 ■ 74 V	K2.2 ■ 60 V	K2.3 ■ 48 V
K3.1 ■ 65 V	K3.2 ■ 50 V	K3.3 ■ 41 V	K4.1 ■ 61 V	K4.2 ■ 46 V	K4.3 ■ 34 V	K4.4 ■ 29 V	K4.5 ■ 24 V	K5.1 ■ 68 V	K5.2 ■ 52 V	K5.3 ■ 40 V	N1.1 ■ 188 W	N1.2 ■ 141 W	N1.3 ■ 94 W
N2.1 ■ 231 V	N2.2 ■ 208 V	N2.3 ■ 150 V	N3.1 ■ 280 V	N3.2 ■ 165 V	N3.3 ■ 83 V	S1.1 ▣ 41 U	S1.2 ▣ 34 U	S1.3 ▣ 30 T	H1.1 ■ 42 U	H2.1 ▣ 25 U	H2.2 ▣ 23 U	H3.1 ▣ 28 U	H3.2 ▣ 23 U

DCON MS tolerans h6.

Product	DC (inch)	DC (mm)	DC (inch)	LCF (mm)	OAL (mm)	LS (mm)	DCON MS (mm)
R4543.0	–	3.00	0.1181	28.0	66.0	36.0	6.00
R4543.1	–	3.10	0.1220	28.0	66.0	36.0	6.00
R4541/8	1/8	3.18	0.1250	28.0	66.0	36.0	6.00
R4543.2	–	3.20	0.1260	28.0	66.0	36.0	6.00
R454N30	N30	3.26	0.1283	28.0	66.0	36.0	6.00
R4543.3	–	3.30	0.1299	28.0	66.0	36.0	6.00
R4543.4	–	3.40	0.1339	28.0	66.0	36.0	6.00
R454N29	N29	3.45	0.1360	28.0	66.0	36.0	6.00
R4543.5	–	3.50	0.1378	28.0	66.0	36.0	6.00
R454N28	N28	3.57	0.1406	28.0	66.0	36.0	6.00
R4549/64	9/64	3.57	0.1406	28.0	66.0	36.0	6.00
R4543.6	–	3.60	0.1417	28.0	66.0	36.0	6.00
R454N27	N27	3.66	0.1441	28.0	66.0	36.0	6.00
R4543.7	–	3.70	0.1457	28.0	66.0	36.0	6.00
R454N26	N26	3.73	0.1469	36.0	74.0	36.0	6.00
R4543.8	–	3.80	0.1496	36.0	74.0	36.0	6.00
R454N24	N24	3.86	0.1520	36.0	74.0	36.0	6.00
R4543.9	–	3.90	0.1535	36.0	74.0	36.0	6.00
R4545/32	5/32	3.97	0.1563	36.0	74.0	36.0	6.00
R4544.0	–	4.00	0.1575	36.0	74.0	36.0	6.00
R454N21	N21	4.04	0.1591	36.0	74.0	36.0	6.00
R454N20	N20	4.09	0.1610	36.0	74.0	36.0	6.00
R4544.1	–	4.10	0.1614	36.0	74.0	36.0	6.00
R4544.2	–	4.20	0.1654	36.0	74.0	36.0	6.00
R454N19	N19	4.22	0.1661	36.0	74.0	36.0	6.00

Product	DC	DC	DC	LCF	OAL	LS	DCON MS
	(inch)	(mm)	(inch)	(mm)	(mm)	(mm)	(mm)
R4544.3	–	4.30	0.1693	36.0	74.0	36.0	6.00
R45411/64	11/64	4.37	0.1719	36.0	74.0	36.0	6.00
R4544.4	–	4.40	0.1732	36.0	74.0	36.0	6.00
R4544.5	–	4.50	0.1772	36.0	74.0	36.0	6.00
R454N16	N16	4.50	0.1772	36.0	74.0	36.0	6.00
R454N15	N15	4.57	0.1799	36.0	74.0	36.0	6.00
R4544.6	–	4.60	0.1811	36.0	74.0	36.0	6.00
R454N14	N14	4.62	0.1819	36.0	74.0	36.0	6.00
R4544.7	–	4.70	0.1850	36.0	74.0	36.0	6.00
R4543/16	3/16	4.76	0.1875	44.0	82.0	36.0	6.00
R4544.8	–	4.80	0.1890	44.0	82.0	36.0	6.00
R454N11	N11	4.85	0.1909	44.0	82.0	36.0	6.00
R4544.9	–	4.90	0.1929	44.0	82.0	36.0	6.00
R454N10	N10	4.92	0.1937	44.0	82.0	36.0	6.00
R454N9	N9	4.98	0.1961	44.0	82.0	36.0	6.00
R4545.0	–	5.00	0.1969	44.0	82.0	36.0	6.00
R454N8	N8	5.06	0.1992	44.0	82.0	36.0	6.00
R4545.1	–	5.10	0.2008	44.0	82.0	36.0	6.00
R454N7	N7	5.11	0.2010	44.0	82.0	36.0	6.00
R45413/64	13/64	5.16	0.2031	44.0	82.0	36.0	6.00
R454N6	N6	5.18	0.2039	44.0	82.0	36.0	6.00
R4545.2	–	5.20	0.2047	44.0	82.0	36.0	6.00
R454N5	N5	5.22	0.2055	44.0	82.0	36.0	6.00
R454N4	N4	5.31	0.2091	44.0	82.0	36.0	6.00
R454N3	N3	5.41	0.2130	44.0	82.0	36.0	6.00
R4545.5	–	5.50	0.2165	44.0	82.0	36.0	6.00
R4547/32	7/32	5.56	0.2188	44.0	82.0	36.0	6.00
R4545.6	–	5.60	0.2205	44.0	82.0	36.0	6.00
R454N2	N2	5.61	0.2209	44.0	82.0	36.0	6.00
R4545.7	–	5.70	0.2244	44.0	82.0	36.0	6.00
R454N1	N1	5.79	0.2280	44.0	82.0	36.0	6.00
R4545.8	–	5.80	0.2283	44.0	82.0	36.0	6.00
R454A	A	5.94	0.2339	44.0	82.0	36.0	6.00
R45415/64	15/64	5.95	0.2344	44.0	82.0	36.0	6.00
R4546.0	–	6.00	0.2362	44.0	82.0	36.0	6.00
R454B	B	6.05	0.2380	53.0	91.0	36.0	8.00
R4546.1	–	6.10	0.2402	53.0	91.0	36.0	8.00
R454C	C	6.15	0.2421	53.0	91.0	36.0	8.00
R4546.2	–	6.20	0.2441	53.0	91.0	36.0	8.00
R454D	D	6.25	0.2461	53.0	91.0	36.0	8.00
R4546.3	–	6.30	0.2480	53.0	91.0	36.0	8.00
R4541/4	1/4	6.35	0.2500	53.0	91.0	36.0	8.00
R454E	E	6.35	0.2500	53.0	91.0	36.0	8.00
R4546.4	–	6.40	0.2520	53.0	91.0	36.0	8.00
R4546.5	–	6.50	0.2559	53.0	91.0	36.0	8.00
R454F	F	6.53	0.2571	53.0	91.0	36.0	8.00
R4546.6	–	6.60	0.2598	53.0	91.0	36.0	8.00
R454G	G	6.63	0.2610	53.0	91.0	36.0	8.00
R4546.7	–	6.70	0.2638	53.0	91.0	36.0	8.00
R45417/64	17/64	6.75	0.2656	53.0	91.0	36.0	8.00
R454H	H	6.76	0.2661	53.0	91.0	36.0	8.00
R4546.8	–	6.80	0.2677	53.0	91.0	36.0	8.00
R4546.9	–	6.90	0.2717	53.0	91.0	36.0	8.00
R454I	I	6.91	0.2720	53.0	91.0	36.0	8.00
R4547.0	–	7.00	0.2756	53.0	91.0	36.0	8.00
R454J	J	7.04	0.2772	53.0	91.0	36.0	8.00
R4547.1	–	7.10	0.2795	53.0	91.0	36.0	8.00
R4549/32	9/32	7.14	0.2813	53.0	91.0	36.0	8.00
R4547.3	–	7.30	0.2874	53.0	91.0	36.0	8.00
R454L	L	7.37	0.2902	53.0	91.0	36.0	8.00
R4547.4	–	7.40	0.2913	53.0	91.0	36.0	8.00
R4547.5	–	7.50	0.2953	53.0	91.0	36.0	8.00



Product	DC	DC	DC	LCF	OAL	LS	DCON MS
	(inch)	(mm)	(inch)	(mm)	(mm)	(mm)	(mm)
R45419/64	19/64	7.54	0.2969	53.0	91.0	36.0	8.00
R4547.6	–	7.60	0.2992	53.0	91.0	36.0	8.00
R454N	N	7.67	0.3020	53.0	91.0	36.0	8.00
R4547.7	–	7.70	0.3031	53.0	91.0	36.0	8.00
R4547.8	–	7.80	0.3071	53.0	91.0	36.0	8.00
R4547.9	–	7.90	0.3110	53.0	91.0	36.0	8.00
R4545/16	5/16	7.94	0.3125	53.0	91.0	36.0	8.00
R4548.0	–	8.00	0.3150	53.0	91.0	36.0	8.00
R4540	0	8.03	0.3161	61.0	103.0	40.0	10.00
R4548.1	–	8.10	0.3189	61.0	103.0	40.0	10.00
R4548.2	–	8.20	0.3228	61.0	103.0	40.0	10.00
R45421/64	21/64	8.33	0.3281	61.0	103.0	40.0	10.00
R4548.4	–	8.40	0.3307	61.0	103.0	40.0	10.00
R454Q	Q	8.43	0.3319	61.0	103.0	40.0	10.00
R4548.5	–	8.50	0.3346	61.0	103.0	40.0	10.00
R4548.6	–	8.60	0.3386	61.0	103.0	40.0	10.00
R454R	R	8.61	0.3390	61.0	103.0	40.0	10.00
R4548.7	–	8.70	0.3425	61.0	103.0	40.0	10.00
R45411/32	11/32	8.73	0.3438	61.0	103.0	40.0	10.00
R4548.8	–	8.80	0.3465	61.0	103.0	40.0	10.00
R454S	S	8.84	0.3480	61.0	103.0	40.0	10.00
R4548.9	–	8.90	0.3504	61.0	103.0	40.0	10.00
R4549.0	–	9.00	0.3543	61.0	103.0	40.0	10.00
R4549.1	–	9.10	0.3583	61.0	103.0	40.0	10.00
R45423/64	23/64	9.13	0.3594	61.0	103.0	40.0	10.00
R4549.3	–	9.30	0.3661	61.0	103.0	40.0	10.00
R454U	U	9.35	0.3681	61.0	103.0	40.0	10.00
R4549.4	–	9.40	0.3701	61.0	103.0	40.0	10.00
R4549.5	–	9.50	0.3740	61.0	103.0	40.0	10.00
R4543/8	3/8	9.53	0.3750	61.0	103.0	40.0	10.00
R4549.6	–	9.60	0.3780	61.0	103.0	40.0	10.00
R4549.7	–	9.70	0.3819	61.0	103.0	40.0	10.00
R4549.8	–	9.80	0.3858	61.0	103.0	40.0	10.00
R4549.9	–	9.90	0.3898	61.0	103.0	40.0	10.00
R454W	W	9.80	0.3858	61.0	103.0	40.0	10.00
R45425/64	25/64	9.92	0.3906	61.0	103.0	40.0	10.00
R45410.0	–	10.00	0.3937	61.0	103.0	40.0	10.00
R454X	X	10.08	0.3969	70.0	118.0	45.0	12.00
R45410.1	–	10.10	0.3976	70.0	118.0	45.0	12.00
R45410.2	–	10.20	0.4016	70.0	118.0	45.0	12.00
R454Y	Y	10.26	0.4039	70.0	118.0	45.0	12.00
R45410.3	–	10.30	0.4055	70.0	118.0	45.0	12.00
R45413/32	13/32	10.32	0.4063	70.0	118.0	45.0	12.00
R45410.4	–	10.40	0.4094	70.0	118.0	45.0	12.00
R454Z	Z	10.49	0.4130	70.0	118.0	45.0	12.00
R45410.5	–	10.50	0.4134	70.0	118.0	45.0	12.00
R45410.6	–	10.60	0.4173	70.0	118.0	45.0	12.00
R45427/64	27/64	10.72	0.4219	70.0	118.0	45.0	12.00
R45411.0	–	11.00	0.4331	70.0	118.0	45.0	12.00
R4547/16	7/16	11.11	0.4375	70.0	118.0	45.0	12.00
R45411.2	–	11.20	0.4409	70.0	118.0	45.0	12.00
R45411.4	–	11.40	0.4488	70.0	118.0	45.0	12.00
R45411.5	–	11.50	0.4528	70.0	118.0	45.0	12.00
R45429/64	29/64	11.51	0.4531	70.0	118.0	45.0	12.00
R45411.6	–	11.60	0.4567	70.0	118.0	45.0	12.00
R45411.8	–	11.80	0.4646	70.0	118.0	45.0	12.00
R45415/32	15/32	11.91	0.4688	70.0	118.0	45.0	12.00
R45412.0	–	12.00	0.4724	70.0	118.0	45.0	12.00
R45412.1	–	12.10	0.4764	76.0	124.0	45.0	14.00
R45412.2	–	12.20	0.4803	76.0	124.0	45.0	14.00
R45431/64	31/64	12.30	0.4844	76.0	124.0	45.0	14.00
R45412.5	–	12.50	0.4921	76.0	124.0	45.0	14.00



Product	DC	DC	DC	LCF	OAL	LS	DCON MS
	(inch)	(mm)	(inch)	(mm)	(mm)	(mm)	(mm)
R45412.7	–	12.70	0.5000	76.0	124.0	45.0	14.00
R4541/2	1/2	12.70	0.5000	76.0	124.0	45.0	14.00
R45412.8	–	12.80	0.5039	76.0	124.0	45.0	14.00
R45413.0	–	13.00	0.5118	76.0	124.0	45.0	14.00
R45433/64	33/64	13.10	0.5156	76.0	124.0	45.0	14.00
R45417/32	17/32	13.49	0.5313	76.0	124.0	45.0	14.00
R45413.5	–	13.50	0.5315	76.0	124.0	45.0	14.00
R45413.8	–	13.80	0.5433	76.0	124.0	45.0	14.00
R45435/64	35/64	13.89	0.5469	76.0	124.0	45.0	14.00
R45414.0	–	14.00	0.5512	76.0	124.0	45.0	14.00
R45414.25	–	14.25	0.5610	82.0	133.0	48.0	16.00
R4549/16	9/16	14.29	0.5625	82.0	133.0	48.0	16.00
R45414.5	–	14.50	0.5709	82.0	133.0	48.0	16.00
R45437/64	37/64	14.68	0.5781	82.0	133.0	48.0	16.00
R45414.8	–	14.80	0.5827	82.0	133.0	48.0	16.00
R45415.0	–	15.00	0.5906	82.0	133.0	48.0	16.00
R45419/32	19/32	15.08	0.5938	82.0	133.0	48.0	16.00
R45415.1	–	15.10	0.5945	82.0	133.0	48.0	16.00
R45439/64	39/64	15.48	0.6094	82.0	133.0	48.0	16.00
R45415.5	–	15.50	0.6102	82.0	133.0	48.0	16.00
R45415.8	–	15.80	0.6220	82.0	133.0	48.0	16.00
R4545/8	5/8	15.88	0.6250	82.0	133.0	48.0	16.00
R45416.0	–	16.00	0.6299	82.0	133.0	48.0	16.00
R45441/64	41/64	16.27	0.6406	91.0	143.0	48.0	18.00
R45416.5	–	16.50	0.6496	91.0	143.0	48.0	18.00
R45421/32	21/32	16.67	0.6563	91.0	143.0	48.0	18.00
R45417.0	–	17.00	0.6693	91.0	143.0	48.0	18.00
R45443/64	43/64	17.07	0.6720	91.0	143.0	48.0	18.00
R45411/16	11/16	17.46	0.6874	91.0	143.0	48.0	18.00
R45417.5	–	17.50	0.6890	91.0	143.0	48.0	18.00
R45417.8	–	17.80	0.7008	91.0	143.0	48.0	18.00
R45445/64	45/64	17.86	0.7031	91.0	143.0	48.0	18.00
R45418.0	–	18.00	0.7087	91.0	143.0	48.0	18.00
R45423/32	23/32	18.26	0.7189	99.0	153.0	50.0	20.00
R45418.5	–	18.50	0.7283	99.0	153.0	50.0	20.00
R45447/64	47/64	18.65	0.7343	99.0	153.0	50.0	20.00
R45419.0	–	19.00	0.7480	99.0	153.0	50.0	20.00
R4543/4	3/4	19.05	0.7500	99.0	153.0	50.0	20.00
R45419.5	–	19.50	0.7677	99.0	153.0	50.0	20.00
R45419.8	–	19.80	0.7795	99.0	153.0	50.0	20.00
R45420.0	–	20.00	0.7874	99.0	153.0	50.0	20.00

R453



FORCE X-borr av solid hårdmetall, borrhjup 5xD, invändiga kylkanaler, TiAlN-belag

Högproduktivt borr som ger hål med hög noggrannhet och finish. H9-tolerans möjlig under rätt förhållanden. 140° spetsvinkel och 4-fasettspetslipning. Spårutformning med CTW-design. Invändiga kylkanaler. TiAlN-beläggning ökar slitstyrka och livslängd. Lämpar sig för borrar i de flesta material.

FORCE X

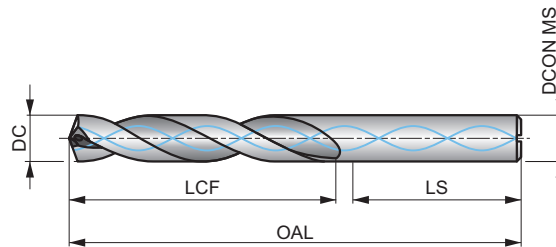

HM	DIN 6537L	5xD
140°	TiAlN	DIN 6535HA
CTW	R	
DC m7		

Arbetsmaterialgrupper och startvärden för skärhastighet (m/min) och matningskod. Tabeller med matningar finns med början på sidan 274

P1.1 ■ 170V	P1.2 ■ 190V	P1.3 ■ 197V	P2.1 ■ 145V	P2.2 ■ 128V	P2.3 ■ 113V	P3.1 ■ 126V	P3.2 ■ 102V	P3.3 ■ 86V	P4.1 ■ 75V	P4.2 ■ 64V	P4.3 ■ 52U	M1.1 ▣ 71V	M1.2 ▣ 61V
M2.1 ▣ 64V	M2.2 ▣ 52V	M2.3 ▣ 44U	M3.1 ▣ 39V	M3.2 ▣ 33V	M3.3 ▣ 30V	M4.1 ▣ 29U	M4.2 ▣ 25U	K1.1 ■ 105W	K1.2 ■ 77W	K1.3 ■ 58W	K2.1 ■ 93V	K2.2 ■ 76V	K2.3 ■ 61V
K3.1 ■ 83V	K3.2 ■ 64V	K3.3 ■ 51V	K4.1 ■ 77V	K4.2 ■ 58V	K4.3 ■ 43V	K4.4 ■ 36V	K4.5 ■ 30V	K5.1 ■ 86V	K5.2 ■ 66V	K5.3 ■ 50V	N1.1 ■ 238W	N1.2 ■ 179W	N1.3 ■ 119W
N2.1 ■ 293V	N2.2 ■ 263V	N2.3 ■ 190V	N3.1 ■ 354W	N3.2 ■ 209W	N3.3 ■ 105W	S1.1 ■ 52V	S1.2 ■ 43V	S1.3 ■ 38U	H1.1 ■ 53U	H2.1 ▣ 31U	H2.2 ▣ 29U	H3.1 ▣ 35U	H3.2 ▣ 29U

DCON MS tolerans h6.

Product	DC (inch)	DC (mm)	DC (inch)	LCF (mm)	OAL (mm)	LS (mm)	DCON MS (mm)
R4533.0	–	3.00	0.1181	28.0	66.0	36.0	6.00
R4533.1	–	3.10	0.1220	28.0	66.0	36.0	6.00
R4531/8	1/8	3.18	0.1250	28.0	66.0	36.0	6.00
R4533.2	–	3.20	0.1260	28.0	66.0	36.0	6.00
R453N30	N30	3.26	0.1283	28.0	66.0	36.0	6.00
R4533.3	–	3.30	0.1299	28.0	66.0	36.0	6.00
R4533.4	–	3.40	0.1339	28.0	66.0	36.0	6.00
R453N29	N29	3.45	0.1360	28.0	66.0	36.0	6.00
R4533.5	–	3.50	0.1378	28.0	66.0	36.0	6.00
R453N28	N28	3.57	0.1406	28.0	66.0	36.0	6.00
R4539/64	9/64	3.57	0.1406	28.0	66.0	36.0	6.00
R4533.6	–	3.60	0.1417	28.0	66.0	36.0	6.00
R453N27	N27	3.66	0.1441	28.0	66.0	36.0	6.00
R4533.7	–	3.70	0.1457	28.0	66.0	36.0	6.00
R453N26	N26	3.73	0.1469	36.0	74.0	36.0	6.00
R4533.8	–	3.80	0.1496	36.0	74.0	36.0	6.00
R453N24	N24	3.86	0.1520	36.0	74.0	36.0	6.00
R4533.9	–	3.90	0.1535	36.0	74.0	36.0	6.00
R453N23	N23	3.91	0.1539	36.0	74.0	36.0	6.00
R4535/32	5/32	3.97	0.1563	36.0	74.0	36.0	6.00
R453N22	N22	3.99	0.1571	36.0	74.0	36.0	6.00
R4534.0	–	4.00	0.1575	36.0	74.0	36.0	6.00
R453N21	N21	4.04	0.1591	36.0	74.0	36.0	6.00
R4534.05	–	4.05	0.1594	36.0	74.0	36.0	6.00
R453N20	N20	4.09	0.1610	36.0	74.0	36.0	6.00

Product	DC	DC	DC	LCF	OAL	LS	DCON MS
	(inch)	(mm)	(inch)	(mm)	(mm)	(mm)	(mm)
R4534.1	–	4.10	0.1614	36.0	74.0	36.0	6.00
R4534.2	–	4.20	0.1654	36.0	74.0	36.0	6.00
R453N19	N19	4.22	0.1661	36.0	74.0	36.0	6.00
R4534.3	–	4.30	0.1693	36.0	74.0	36.0	6.00
R453N18	N18	4.31	0.1697	36.0	74.0	36.0	6.00
R45311/64	11/64	4.37	0.1719	36.0	74.0	36.0	6.00
R4534.4	–	4.40	0.1732	36.0	74.0	36.0	6.00
R4534.5	–	4.50	0.1772	36.0	74.0	36.0	6.00
R453N16	N16	4.50	0.1772	36.0	74.0	36.0	6.00
R453N15	N15	4.57	0.1799	36.0	74.0	36.0	6.00
R4534.6	–	4.60	0.1811	36.0	74.0	36.0	6.00
R453N14	N14	4.62	0.1819	36.0	74.0	36.0	6.00
R4534.7	–	4.70	0.1850	36.0	74.0	36.0	6.00
R4533/16	3/16	4.76	0.1875	44.0	82.0	36.0	6.00
R4534.8	–	4.80	0.1890	44.0	82.0	36.0	6.00
R453N12	N12	4.80	0.1890	44.0	82.0	36.0	6.00
R453N11	N11	4.85	0.1909	44.0	82.0	36.0	6.00
R4534.9	–	4.90	0.1929	44.0	82.0	36.0	6.00
R453N10	N10	4.92	0.1937	44.0	82.0	36.0	6.00
R453N9	N9	4.98	0.1961	44.0	82.0	36.0	6.00
R4535.0	–	5.00	0.1969	44.0	82.0	36.0	6.00
R4535.05	–	5.05	0.1988	44.0	82.0	36.0	6.00
R453N8	N8	5.06	0.1992	44.0	82.0	36.0	6.00
R4535.1	–	5.10	0.2008	44.0	82.0	36.0	6.00
R453N7	N7	5.11	0.2010	44.0	82.0	36.0	6.00
R45313/64	13/64	5.16	0.2031	44.0	82.0	36.0	6.00
R4535.2	–	5.20	0.2047	44.0	82.0	36.0	6.00
R453N5	N5	5.22	0.2055	44.0	82.0	36.0	6.00
R4535.3	–	5.30	0.2087	44.0	82.0	36.0	6.00
R453N4	N4	5.31	0.2091	44.0	82.0	36.0	6.00
R4535.4	–	5.40	0.2126	44.0	82.0	36.0	6.00
R453N3	N3	5.41	0.2130	44.0	82.0	36.0	6.00
R4535.5	–	5.50	0.2165	44.0	82.0	36.0	6.00
R4537/32	7/32	5.56	0.2188	44.0	82.0	36.0	6.00
R4535.6	–	5.60	0.2205	44.0	82.0	36.0	6.00
R453N2	N2	5.61	0.2209	44.0	82.0	36.0	6.00
R4535.7	–	5.70	0.2244	44.0	82.0	36.0	6.00
R453N1	N1	5.79	0.2280	44.0	82.0	36.0	6.00
R4535.8	–	5.80	0.2283	44.0	82.0	36.0	6.00
R4535.9	–	5.90	0.2323	44.0	82.0	36.0	6.00
R453A	A	5.94	0.2339	44.0	82.0	36.0	6.00
R45315/64	15/64	5.95	0.2344	44.0	82.0	36.0	6.00
R4536.0	–	6.00	0.2362	44.0	82.0	36.0	6.00
R453B	B	6.05	0.2380	53.0	91.0	36.0	8.00
R4536.05	–	6.05	0.2382	53.0	91.0	36.0	8.00
R4536.1	–	6.10	0.2402	53.0	91.0	36.0	8.00
R453C	C	6.15	0.2421	53.0	91.0	36.0	8.00
R4536.2	–	6.20	0.2441	53.0	91.0	36.0	8.00
R453D	D	6.25	0.2461	53.0	91.0	36.0	8.00
R4536.3	–	6.30	0.2480	53.0	91.0	36.0	8.00
R4531/4	1/4	6.35	0.2500	53.0	91.0	36.0	8.00
R4536.4	–	6.40	0.2520	53.0	91.0	36.0	8.00
R4536.5	–	6.50	0.2559	53.0	91.0	36.0	8.00
R453F	F	6.53	0.2571	53.0	91.0	36.0	8.00
R4536.6	–	6.60	0.2598	53.0	91.0	36.0	8.00
R453G	G	6.63	0.2610	53.0	91.0	36.0	8.00
R4536.7	–	6.70	0.2638	53.0	91.0	36.0	8.00
R45317/64	17/64	6.75	0.2656	53.0	91.0	36.0	8.00
R4536.8	–	6.80	0.2677	53.0	91.0	36.0	8.00
R4536.9	–	6.90	0.2717	53.0	91.0	36.0	8.00
R453I	I	6.91	0.2720	53.0	91.0	36.0	8.00
R4537.0	–	7.00	0.2756	53.0	91.0	36.0	8.00

Product	DC	DC	DC	LCF	OAL	LS	DCON MS
	(inch)	(mm)	(inch)	(mm)	(mm)	(mm)	(mm)
R453J	J	7.04	0.2772	53.0	91.0	36.0	8.00
R4537.1	–	7.10	0.2795	53.0	91.0	36.0	8.00
R453K	K	7.14	0.2811	53.0	91.0	36.0	8.00
R4539/32	9/32	7.14	0.2813	53.0	91.0	36.0	8.00
R4537.2	–	7.20	0.2835	53.0	91.0	36.0	8.00
R4537.3	–	7.30	0.2874	53.0	91.0	36.0	8.00
R453L	L	7.37	0.2902	53.0	91.0	36.0	8.00
R4537.4	–	7.40	0.2913	53.0	91.0	36.0	8.00
R453M	M	7.49	0.2949	53.0	91.0	36.0	8.00
R4537.5	–	7.50	0.2953	53.0	91.0	36.0	8.00
R45319/64	19/64	7.54	0.2969	53.0	91.0	36.0	8.00
R4537.6	–	7.60	0.2992	53.0	91.0	36.0	8.00
R453N	N	7.67	0.3020	53.0	91.0	36.0	8.00
R4537.7	–	7.70	0.3031	53.0	91.0	36.0	8.00
R4537.8	–	7.80	0.3071	53.0	91.0	36.0	8.00
R4537.9	–	7.90	0.3110	53.0	91.0	36.0	8.00
R4535/16	5/16	7.94	0.3125	53.0	91.0	36.0	8.00
R4538.0	–	8.00	0.3150	53.0	91.0	36.0	8.00
R4530	O	8.03	0.3161	61.0	103.0	40.0	10.00
R4538.05	–	8.05	0.3169	61.0	103.0	40.0	10.00
R4538.1	–	8.10	0.3189	61.0	103.0	40.0	10.00
R4538.2	–	8.20	0.3228	61.0	103.0	40.0	10.00
R453P	P	8.20	0.3228	61.0	103.0	40.0	10.00
R4538.3	–	8.30	0.3268	61.0	103.0	40.0	10.00
R45321/64	21/64	8.33	0.3281	61.0	103.0	40.0	10.00
R4538.4	–	8.40	0.3307	61.0	103.0	40.0	10.00
R453Q	Q	8.43	0.3319	61.0	103.0	40.0	10.00
R4538.5	–	8.50	0.3346	61.0	103.0	40.0	10.00
R4538.6	–	8.60	0.3386	61.0	103.0	40.0	10.00
R453R	R	8.61	0.3390	61.0	103.0	40.0	10.00
R4538.7	–	8.70	0.3425	61.0	103.0	40.0	10.00
R45311/32	11/32	8.73	0.3438	61.0	103.0	40.0	10.00
R4538.8	–	8.80	0.3465	61.0	103.0	40.0	10.00
R453S	S	8.84	0.3480	61.0	103.0	40.0	10.00
R4538.9	–	8.90	0.3504	61.0	103.0	40.0	10.00
R4539.0	–	9.00	0.3543	61.0	103.0	40.0	10.00
R4539.1	–	9.10	0.3583	61.0	103.0	40.0	10.00
R45323/64	23/64	9.13	0.3594	61.0	103.0	40.0	10.00
R4539.2	–	9.20	0.3622	61.0	103.0	40.0	10.00
R4539.3	–	9.30	0.3661	61.0	103.0	40.0	10.00
R453U	U	9.35	0.3681	61.0	103.0	40.0	10.00
R4539.4	–	9.40	0.3701	61.0	103.0	40.0	10.00
R4539.5	–	9.50	0.3740	61.0	103.0	40.0	10.00
R4533/8	3/8	9.53	0.3750	61.0	103.0	40.0	10.00
R4539.6	–	9.60	0.3780	61.0	103.0	40.0	10.00
R4539.7	–	9.70	0.3819	61.0	103.0	40.0	10.00
R4539.8	–	9.80	0.3858	61.0	103.0	40.0	10.00
R453W	W	9.80	0.3858	61.0	103.0	40.0	10.00
R4539.9	–	9.90	0.3898	61.0	103.0	40.0	10.00
R45325/64	25/64	9.92	0.3906	61.0	103.0	40.0	10.00
R45310.0	–	10.00	0.3937	61.0	103.0	40.0	10.00
R45310.05	–	10.05	0.3957	70.0	118.0	45.0	12.00
R453X	X	10.08	0.3969	70.0	118.0	45.0	12.00
R45310.1	–	10.10	0.3976	70.0	118.0	45.0	12.00
R45310.2	–	10.20	0.4016	70.0	118.0	45.0	12.00
R453Y	Y	10.26	0.4039	70.0	118.0	45.0	12.00
R45310.3	–	10.30	0.4055	70.0	118.0	45.0	12.00
R45313/32	13/32	10.32	0.4063	70.0	118.0	45.0	12.00
R45310.4	–	10.40	0.4094	70.0	118.0	45.0	12.00
R45310.5	–	10.50	0.4134	70.0	118.0	45.0	12.00
R45310.6	–	10.60	0.4173	70.0	118.0	45.0	12.00
R45327/64	27/64	10.72	0.4219	70.0	118.0	45.0	12.00

Product	DC	DC	DC	LCF	OAL	LS	DCON MS
	(inch)	(mm)	(inch)	(mm)	(mm)	(mm)	(mm)
R45310.8	–	10.80	0.4252	70.0	118.0	45.0	12.00
R45311.0	–	11.00	0.4331	70.0	118.0	45.0	12.00
R4537/16	7/16	11.11	0.4375	70.0	118.0	45.0	12.00
R45311.2	–	11.20	0.4409	70.0	118.0	45.0	12.00
R45311.3	–	11.30	0.4449	70.0	118.0	45.0	12.00
R45311.4	–	11.40	0.4488	70.0	118.0	45.0	12.00
R45311.5	–	11.50	0.4528	70.0	118.0	45.0	12.00
R45329/64	29/64	11.51	0.4531	70.0	118.0	45.0	12.00
R45311.6	–	11.60	0.4567	70.0	118.0	45.0	12.00
R45311.8	–	11.80	0.4646	70.0	118.0	45.0	12.00
R45315/32	15/32	11.91	0.4688	70.0	118.0	45.0	12.00
R45312.0	–	12.00	0.4724	70.0	118.0	45.0	12.00
R45312.05	–	12.05	0.4744	76.0	124.0	45.0	14.00
R45312.2	–	12.20	0.4803	76.0	124.0	45.0	14.00
R45331/64	31/64	12.30	0.4844	76.0	124.0	45.0	14.00
R45312.5	–	12.50	0.4921	76.0	124.0	45.0	14.00
R45312.7	–	12.70	0.5000	76.0	124.0	45.0	14.00
R4531/2	1/2	12.70	0.5000	76.0	124.0	45.0	14.00
R45312.8	–	12.80	0.5039	76.0	124.0	45.0	14.00
R45313.0	–	13.00	0.5118	76.0	124.0	45.0	14.00
R45333/64	33/64	13.10	0.5156	76.0	124.0	45.0	14.00
R45313.3	–	13.30	0.5236	76.0	124.0	45.0	14.00
R45317/32	17/32	13.49	0.5313	76.0	124.0	45.0	14.00
R45313.5	–	13.50	0.5315	76.0	124.0	45.0	14.00
R45313.8	–	13.80	0.5433	76.0	124.0	45.0	14.00
R45335/64	35/64	13.89	0.5469	76.0	124.0	45.0	14.00
R45314.0	–	14.00	0.5512	76.0	124.0	45.0	14.00
R45314.25	–	14.25	0.5610	82.0	133.0	48.0	16.00
R4539/16	9/16	14.29	0.5625	82.0	133.0	48.0	16.00
R45314.5	–	14.50	0.5709	82.0	133.0	48.0	16.00
R45337/64	37/64	14.68	0.5781	82.0	133.0	48.0	16.00
R45314.8	–	14.80	0.5827	82.0	133.0	48.0	16.00
R45315.0	–	15.00	0.5906	82.0	133.0	48.0	16.00
R45319/32	19/32	15.08	0.5938	82.0	133.0	48.0	16.00
R45315.1	–	15.10	0.5945	82.0	133.0	48.0	16.00
R45315.3	–	15.30	0.6024	82.0	133.0	48.0	16.00
R45315.5	–	15.50	0.6102	82.0	133.0	48.0	16.00
R45315.8	–	15.80	0.6220	82.0	133.0	48.0	16.00
R4535/8	5/8	15.88	0.6250	82.0	133.0	48.0	16.00
R45316.0	–	16.00	0.6299	82.0	133.0	48.0	16.00
R45341/64	41/64	16.27	0.6406	91.0	143.0	48.0	18.00
R45316.5	–	16.50	0.6496	91.0	143.0	48.0	18.00
R45321/32	21/32	16.67	0.6563	91.0	143.0	48.0	18.00
R45317.0	–	17.00	0.6693	91.0	143.0	48.0	18.00
R45343/64	43/64	17.07	0.6720	91.0	143.0	48.0	18.00
R45311/16	11/16	17.46	0.6874	91.0	143.0	48.0	18.00
R45317.5	–	17.50	0.6890	91.0	143.0	48.0	18.00
R45317.8	–	17.80	0.7008	91.0	143.0	48.0	18.00
R45345/64	45/64	17.86	0.7031	91.0	143.0	48.0	18.00
R45318.0	–	18.00	0.7087	91.0	143.0	48.0	18.00
R45323/32	23/32	18.26	0.7189	99.0	153.0	50.0	20.00
R45318.5	–	18.50	0.7283	99.0	153.0	50.0	20.00
R45347/64	47/64	18.65	0.7343	99.0	153.0	50.0	20.00
R45319.0	–	19.00	0.7480	99.0	153.0	50.0	20.00
R4533/4	3/4	19.05	0.7500	99.0	153.0	50.0	20.00
R45319.5	–	19.50	0.7677	99.0	153.0	50.0	20.00
R45319.8	–	19.80	0.7795	99.0	153.0	50.0	20.00
R45320.0	–	20.00	0.7874	99.0	153.0	50.0	20.00

R459



FORCE X-borr av solid hårdmetall, borrhjup 8xD, invändiga kylkanaler, TiAlN-belagd

Högproduktivt borr som ger hål med hög noggrannhet och finish. H9-tolerans möjlig under rätt förhållanden. 140° spetsvinkel och 4-fasettspetslipning. Spårutformning med CTW-design. Invändiga kylkanaler. TiAlN-beläggning ökar slitstyrka och livslängd. Lämpar sig för borrhjup i de flesta material.

FORCE X

HM	DORMER	8xD
140°	TiAlN	DIN 6535HA
CTW	R	
DC m7		

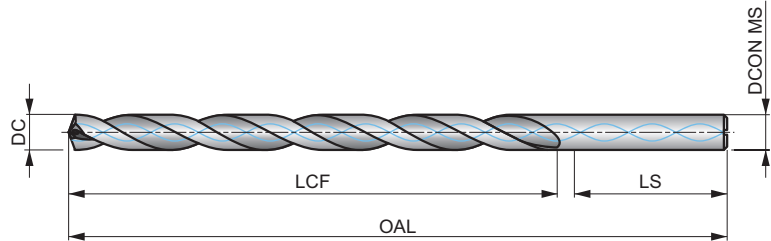

Arbetsmaterialgrupper och startvärden för skärhastighet (m/min) och matningskod. Tabeller med matningar finns med början på sidan 274

P1.1 ■ 143 V	P1.2 ■ 160 V	P1.3 ■ 166 V	P2.1 ■ 122 V	P2.2 ■ 108 U	P2.3 ■ 95 U	P3.1 ■ 106 U	P3.2 ■ 86 U	P3.3 ■ 72 U	P4.1 ■ 63 U	P4.2 ■ 54 U	P4.3 ■ 44 T	M1.1 ▣ 60 V	M1.2 ▣ 51 V
M2.1 ▣ 54 V	M2.2 ▣ 44 V	M2.3 ▣ 37 U	M3.1 ▣ 33 V	M3.2 ▣ 28 V	M3.3 ▣ 26 V	M4.1 ▣ 24 U	M4.2 ▣ 21 U	K1.1 ■ 88 W	K1.2 ■ 65 W	K1.3 ■ 49 W	K2.1 ■ 78 V	K2.2 ■ 64 V	K2.3 ■ 51 V
K3.1 ■ 70 V	K3.2 ■ 54 V	K3.3 ■ 43 V	K4.1 ■ 65 V	K4.2 ■ 49 V	K4.3 ■ 36 V	K4.4 ■ 30 V	K4.5 ■ 26 V	K5.1 ■ 73 V	K5.2 ■ 55 V	K5.3 ■ 42 V	N1.1 ▣ 1200 W	N1.2 ▣ 150 W	N1.3 ■ 100 W
N2.1 ■ 246 V	N2.2 ■ 222 V	N2.3 ■ 160 V	N3.1 ▣ 298 V	N3.2 ▣ 176 V	N3.3 ▣ 88 V								

DCON MS tolerans h6.

Product	DC (inch)	DC (mm)	DC (inch)	LCF (mm)	OAL (mm)	LS (mm)	DCON MS (mm)
R4593.0	–	3.00	0.1181	37.0	79.0	36.0	6.00
R4593.1	–	3.10	0.1220	37.0	79.0	36.0	6.00
R4591/8	1/8	3.18	0.1250	37.0	79.0	36.0	6.00
R4593.2	–	3.20	0.1260	37.0	79.0	36.0	6.00
R4593.3	–	3.30	0.1299	37.0	79.0	36.0	6.00
R4593.4	–	3.40	0.1339	37.0	79.0	36.0	6.00
R4593.5	–	3.50	0.1378	37.0	79.0	36.0	6.00
R4599/64	9/64	3.57	0.1406	37.0	79.0	36.0	6.00
R4593.6	–	3.60	0.1417	37.0	79.0	36.0	6.00
R4593.7	–	3.70	0.1457	37.0	79.0	36.0	6.00
R4593.8	–	3.80	0.1496	48.0	90.0	36.0	6.00
R4593.9	–	3.90	0.1535	48.0	90.0	36.0	6.00
R4595/32	5/32	3.97	0.1563	48.0	90.0	36.0	6.00
R4594.0	–	4.00	0.1575	48.0	90.0	36.0	6.00
R4594.1	–	4.10	0.1614	48.0	90.0	36.0	6.00
R4594.2	–	4.20	0.1654	48.0	90.0	36.0	6.00
R4594.3	–	4.30	0.1693	48.0	90.0	36.0	6.00
R45911/64	11/64	4.37	0.1719	48.0	90.0	36.0	6.00
R4594.4	–	4.40	0.1732	48.0	90.0	36.0	6.00
R4594.5	–	4.50	0.1772	48.0	90.0	36.0	6.00
R4594.6	–	4.60	0.1811	48.0	90.0	36.0	6.00
R4594.7	–	4.70	0.1850	62.0	104.0	36.0	6.00
R4593/16	3/16	4.76	0.1875	62.0	104.0	36.0	6.00
R4594.8	–	4.80	0.1890	62.0	104.0	36.0	6.00
R4594.9	–	4.90	0.1929	62.0	104.0	36.0	6.00

Product	DC	DC	DC	LCF	OAL	LS	DCON MS
	(inch)	(mm)	(inch)	(mm)	(mm)	(mm)	
R4595.0	–	5.00	0.1969	62.0	104.0	36.0	6.00
R4595.1	–	5.10	0.2008	62.0	104.0	36.0	6.00
R45913/64	13/64	5.16	0.2031	62.0	104.0	36.0	6.00
R4595.2	–	5.20	0.2047	62.0	104.0	36.0	6.00
R4595.3	–	5.30	0.2087	62.0	104.0	36.0	6.00
R4595.4	–	5.40	0.2126	62.0	104.0	36.0	6.00
R4595.5	–	5.50	0.2165	62.0	104.0	36.0	6.00
R4597/32	7/32	5.56	0.2188	62.0	104.0	36.0	6.00
R4595.6	–	5.60	0.2205	62.0	104.0	36.0	6.00
R4595.7	–	5.70	0.2244	62.0	104.0	36.0	6.00
R4595.8	–	5.80	0.2283	62.0	104.0	36.0	6.00
R4595.9	–	5.90	0.2323	62.0	104.0	36.0	6.00
R45915/64	15/64	5.95	0.2344	62.0	104.0	36.0	6.00
R4596.0	–	6.00	0.2362	62.0	104.0	36.0	6.00
R4596.1	–	6.10	0.2402	84.0	126.0	36.0	8.00
R4596.2	–	6.20	0.2441	84.0	126.0	36.0	8.00
R4596.3	–	6.30	0.2480	84.0	126.0	36.0	8.00
R4591/4	1/4	6.35	0.2500	84.0	126.0	36.0	8.00
R4596.4	–	6.40	0.2520	84.0	126.0	36.0	8.00
R4596.5	–	6.50	0.2559	84.0	126.0	36.0	8.00
R4596.6	–	6.60	0.2598	84.0	126.0	36.0	8.00
R4596.7	–	6.70	0.2638	84.0	126.0	36.0	8.00
R45917/64	17/64	6.75	0.2656	84.0	126.0	36.0	8.00
R4596.8	–	6.80	0.2677	84.0	126.0	36.0	8.00
R4596.9	–	6.90	0.2717	84.0	126.0	36.0	8.00
R4597.0	–	7.00	0.2756	84.0	126.0	36.0	8.00
R4597.1	–	7.10	0.2795	84.0	126.0	36.0	8.00
R4599/32	9/32	7.14	0.2813	84.0	126.0	36.0	8.00
R4597.2	–	7.20	0.2835	84.0	126.0	36.0	8.00
R4597.3	–	7.30	0.2874	84.0	126.0	36.0	8.00
R4597.4	–	7.40	0.2913	84.0	126.0	36.0	8.00
R4597.5	–	7.50	0.2953	84.0	126.0	36.0	8.00
R45919/64	19/64	7.54	0.2969	84.0	126.0	36.0	8.00
R4597.6	–	7.60	0.2992	84.0	126.0	36.0	8.00
R4597.7	–	7.70	0.3031	84.0	126.0	36.0	8.00
R4597.8	–	7.80	0.3071	84.0	126.0	36.0	8.00
R4597.9	–	7.90	0.3110	84.0	126.0	36.0	8.00
R4595/16	5/16	7.94	0.3125	84.0	126.0	36.0	8.00
R4598.0	–	8.00	0.3150	84.0	126.0	36.0	8.00
R4598.1	–	8.10	0.3189	106.0	152.0	40.0	10.00
R4598.2	–	8.20	0.3228	106.0	152.0	40.0	10.00
R4598.3	–	8.30	0.3268	106.0	152.0	40.0	10.00
R45921/64	21/64	8.33	0.3281	106.0	152.0	40.0	10.00
R4598.4	–	8.40	0.3307	106.0	152.0	40.0	10.00
R4598.5	–	8.50	0.3346	106.0	152.0	40.0	10.00
R4598.6	–	8.60	0.3386	106.0	152.0	40.0	10.00
R4598.7	–	8.70	0.3425	106.0	152.0	40.0	10.00
R45911/32	11/32	8.73	0.3438	106.0	152.0	40.0	10.00
R4598.8	–	8.80	0.3465	106.0	152.0	40.0	10.00
R4598.9	–	8.90	0.3504	106.0	152.0	40.0	10.00
R4599.0	–	9.00	0.3543	106.0	152.0	40.0	10.00
R4599.1	–	9.10	0.3583	106.0	152.0	40.0	10.00
R45923/64	23/64	9.13	0.3594	106.0	152.0	40.0	10.00
R4599.2	–	9.20	0.3622	106.0	152.0	40.0	10.00
R4599.3	–	9.30	0.3661	106.0	152.0	40.0	10.00
R4599.4	–	9.40	0.3701	106.0	152.0	40.0	10.00
R4599.5	–	9.50	0.3740	106.0	152.0	40.0	10.00
R4593/8	3/8	9.53	0.3750	106.0	152.0	40.0	10.00
R4599.6	–	9.60	0.3780	106.0	152.0	40.0	10.00
R4599.7	–	9.70	0.3819	106.0	152.0	40.0	10.00
R4599.8	–	9.80	0.3858	106.0	152.0	40.0	10.00
R4599.9	–	9.90	0.3898	106.0	152.0	40.0	10.00

Product	DC	DC	DC	LCF	OAL	LS	DCON MS
	(inch)	(mm)	(inch)	(mm)	(mm)	(mm)	(mm)
R45925/64	25/64	9.92	0.3906	106.0	152.0	40.0	10.00
R45910.0	–	10.00	0.3937	106.0	152.0	40.0	10.00
R45910.2	–	10.20	0.4016	128.0	180.0	45.0	12.00
R45910.3	–	10.30	0.4055	128.0	180.0	45.0	12.00
R45913/32	13/32	10.32	0.4063	128.0	180.0	45.0	12.00
R45910.4	–	10.40	0.4094	128.0	180.0	45.0	12.00
R45910.5	–	10.50	0.4134	128.0	180.0	45.0	12.00
R45927/64	27/64	10.72	0.4219	128.0	180.0	45.0	12.00
R45910.8	–	10.80	0.4252	128.0	180.0	45.0	12.00
R45911.0	–	11.00	0.4331	128.0	180.0	45.0	12.00
R4597/16	7/16	11.11	0.4375	128.0	180.0	45.0	12.00
R45911.2	–	11.20	0.4409	128.0	180.0	45.0	12.00
R45911.3	–	11.30	0.4449	128.0	180.0	45.0	12.00
R45911.5	–	11.50	0.4528	128.0	180.0	45.0	12.00
R45929/64	29/64	11.51	0.4531	128.0	180.0	45.0	12.00
R45911.8	–	11.80	0.4646	128.0	180.0	45.0	12.00
R45915/32	15/32	11.91	0.4688	128.0	180.0	45.0	12.00
R45912.0	–	12.00	0.4724	128.0	180.0	45.0	12.00
R45912.2	–	12.20	0.4803	151.0	202.0	48.0	14.00
R45931/64	31/64	12.30	0.4844	151.0	202.0	48.0	14.00
R45912.5	–	12.50	0.4921	151.0	202.0	48.0	14.00
R4591/2	1/2	12.70	0.5000	151.0	202.0	48.0	14.00
R45912.8	–	12.80	0.5039	151.0	202.0	48.0	14.00
R45913.0	–	13.00	0.5118	151.0	202.0	48.0	14.00
R45933/64	33/64	13.10	0.5156	151.0	202.0	48.0	14.00
R45917/32	17/32	13.49	0.5313	151.0	202.0	48.0	14.00
R45913.5	–	13.50	0.5315	151.0	202.0	48.0	14.00
R45935/64	35/64	13.89	0.5469	151.0	202.0	48.0	14.00
R45914.0	–	14.00	0.5512	151.0	202.0	48.0	14.00
R45914.25	–	14.25	0.5610	172.0	227.0	48.0	16.00
R4599/16	9/16	14.29	0.5625	172.0	227.0	48.0	16.00
R45914.5	–	14.50	0.5709	172.0	227.0	48.0	16.00
R45937/64	37/64	14.68	0.5781	172.0	227.0	48.0	16.00
R45915.0	–	15.00	0.5906	172.0	227.0	48.0	16.00
R45919/32	19/32	15.08	0.5938	172.0	227.0	48.0	16.00
R45915.1	–	15.10	0.5945	172.0	227.0	48.0	16.00
R45915.5	–	15.50	0.6102	172.0	227.0	48.0	16.00
R4595/8	5/8	15.88	0.6250	172.0	227.0	48.0	16.00
R45916.0	–	16.00	0.6299	172.0	227.0	48.0	16.00

R467

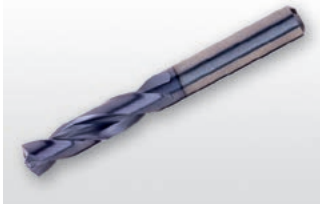

FORCE M-borr av solid hårdmetall, borrhjup 3xD, invändiga kylkanaler, TiAIN-belagd

Högproduktivt borr som ger hål med hög noggrannhet och finish. H9-tolerans möjlig under rätt förhållanden. 140° spetsvinkel och 4-fasettspetslipning. Spårutformning med CTW-design. Invändiga kylkanaler. TiAIN-beläggning ökar slitstyrka och livslängd. Lämpar sig bäst för borrar i rostfritt stål och varmhållfasta material.

FORCE M

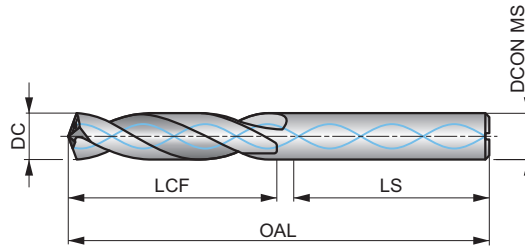

HM	DIN 6537K	3xD
140°	TiAIN	DIN 6535HA
CTW	R	
DC m7		

Arbetsmaterialgrupper och startvärden för skärhastighet (m/min) och matningskod. Tabeller med matningar finns med början på sidan 274

M1.1 ■ 117 G	M1.2 ■ 99 G	M2.1 ■ 104 G	M2.2 ■ 85 G	M2.3 ■ 71 E	M3.1 ■ 87 G	M3.2 ■ 75 G	M3.3 ■ 68 F	M4.1 ■ 60 F	M4.2 ■ 52 E	S1.1 ■ 55 V	S1.2 ■ 45 V	S1.3 ■ 40 U	S2.1 ■ 60 U
S2.2 ■ 56 U	S3.1 ■ 45 U	S3.2 ■ 40 U	S4.1 ■ 35 U	S4.2 ■ 32 U									

DCON MS tolerans h6.

Product	DC (inch)	DC (mm)	DC (inch)	LCF (mm)	OAL (mm)	LS (mm)	DCON MS (mm)
R4673.0	–	3.00	0.1181	20.0	62.0	36.0	6.00
R4673.1	–	3.10	0.1220	20.0	62.0	36.0	6.00
R4671/8	1/8	3.18	0.1250	20.0	62.0	36.0	6.00
R4673.2	–	3.20	0.1260	20.0	62.0	36.0	6.00
R4673.3	–	3.30	0.1299	20.0	62.0	36.0	6.00
R4673.4	–	3.40	0.1339	20.0	62.0	36.0	6.00
R467N29	N29	3.45	0.1360	20.0	62.0	36.0	6.00
R4673.5	–	3.50	0.1378	20.0	62.0	36.0	6.00
R4679/64	9/64	3.57	0.1406	20.0	62.0	36.0	6.00
R4673.6	–	3.60	0.1417	20.0	62.0	36.0	6.00
R4673.7	–	3.70	0.1457	20.0	62.0	36.0	6.00
R4673.8	–	3.80	0.1496	24.0	66.0	36.0	6.00
R4673.9	–	3.90	0.1535	24.0	66.0	36.0	6.00
R4675/32	5/32	3.97	0.1563	24.0	66.0	36.0	6.00
R4674.0	–	4.00	0.1575	24.0	66.0	36.0	6.00
R4674.05	–	4.05	0.1594	24.0	66.0	36.0	6.00
R4674.1	–	4.10	0.1614	24.0	66.0	36.0	6.00
R4674.2	–	4.20	0.1654	24.0	66.0	36.0	6.00
R4674.3	–	4.30	0.1693	24.0	66.0	36.0	6.00
R46711/64	11/64	4.37	0.1719	24.0	66.0	36.0	6.00
R4674.4	–	4.40	0.1732	24.0	66.0	36.0	6.00
R4674.5	–	4.50	0.1772	24.0	66.0	36.0	6.00
R4674.6	–	4.60	0.1811	24.0	66.0	36.0	6.00
R4674.7	–	4.70	0.1850	24.0	66.0	36.0	6.00
R4673/16	3/16	4.76	0.1875	28.0	66.0	36.0	6.00
R4674.8	–	4.80	0.1890	28.0	66.0	36.0	6.00
R4674.9	–	4.90	0.1929	28.0	66.0	36.0	6.00
R4675.0	–	5.00	0.1969	28.0	66.0	36.0	6.00
R4675.05	–	5.05	0.1988	28.0	66.0	36.0	6.00

Product	DC	DC	DC	LCF	OAL	LS	DCON MS
	(inch)	(mm)	(inch)	(mm)	(mm)	(mm)	(mm)
R4675.1	–	5.10	0.2008	28.0	66.0	36.0	6.00
R467N7	N7	5.11	0.2010	28.0	66.0	36.0	6.00
R46713/64	13/64	5.16	0.2031	28.0	66.0	36.0	6.00
R4675.2	–	5.20	0.2047	28.0	66.0	36.0	6.00
R467N5	N5	5.22	0.2055	28.0	66.0	36.0	6.00
R4675.3	–	5.30	0.2087	28.0	66.0	36.0	6.00
R4675.4	–	5.40	0.2126	28.0	66.0	36.0	6.00
R4675.5	–	5.50	0.2165	28.0	66.0	36.0	6.00
R4677/32	7/32	5.56	0.2188	28.0	66.0	36.0	6.00
R4675.6	–	5.60	0.2205	28.0	66.0	36.0	6.00
R4675.7	–	5.70	0.2244	28.0	66.0	36.0	6.00
R4675.8	–	5.80	0.2283	28.0	66.0	36.0	6.00
R4675.9	–	5.90	0.2323	28.0	66.0	36.0	6.00
R46715/64	15/64	5.95	0.2344	28.0	66.0	36.0	6.00
R4676.0	–	6.00	0.2362	28.0	66.0	36.0	6.00
R4676.05	–	6.05	0.2382	34.0	79.0	36.0	8.00
R4676.1	–	6.10	0.2402	34.0	79.0	36.0	8.00
R4676.2	–	6.20	0.2441	34.0	79.0	36.0	8.00
R4676.3	–	6.30	0.2480	34.0	79.0	36.0	8.00
R4671/4	1/4	6.35	0.2500	34.0	79.0	36.0	8.00
R4676.4	–	6.40	0.2520	34.0	79.0	36.0	8.00
R4676.5	–	6.50	0.2559	34.0	79.0	36.0	8.00
R4676.6	–	6.60	0.2598	34.0	79.0	36.0	8.00
R4676.7	–	6.70	0.2638	34.0	79.0	36.0	8.00
R46717/64	17/64	6.75	0.2656	34.0	79.0	36.0	8.00
R4676.8	–	6.80	0.2677	34.0	79.0	36.0	8.00
R4676.9	–	6.90	0.2717	34.0	79.0	36.0	8.00
R4677.0	–	7.00	0.2756	34.0	79.0	36.0	8.00
R4677.1	–	7.10	0.2795	41.0	79.0	36.0	8.00
R4679/32	9/32	7.14	0.2813	41.0	79.0	36.0	8.00
R4677.2	–	7.20	0.2835	41.0	79.0	36.0	8.00
R4677.3	–	7.30	0.2874	41.0	79.0	36.0	8.00
R4677.4	–	7.40	0.2913	41.0	79.0	36.0	8.00
R4677.5	–	7.50	0.2953	41.0	79.0	36.0	8.00
R46719/64	19/64	7.54	0.2969	41.0	79.0	36.0	8.00
R4677.6	–	7.60	0.2992	41.0	79.0	36.0	8.00
R4677.7	–	7.70	0.3031	41.0	79.0	36.0	8.00
R4677.8	–	7.80	0.3071	41.0	79.0	36.0	8.00
R4675/16	5/16	7.94	0.3125	41.0	79.0	36.0	8.00
R4678.0	–	8.00	0.3150	41.0	79.0	36.0	8.00
R4678.05	–	8.05	0.3169	47.0	89.0	40.0	10.00
R4678.1	–	8.10	0.3189	47.0	89.0	40.0	10.00
R4678.2	–	8.20	0.3228	47.0	89.0	40.0	10.00
R4678.3	–	8.30	0.3268	47.0	89.0	40.0	10.00
R4678.4	–	8.40	0.3307	47.0	89.0	40.0	10.00
R4678.5	–	8.50	0.3346	47.0	89.0	40.0	10.00
R4678.6	–	8.60	0.3386	47.0	89.0	40.0	10.00
R4678.7	–	8.70	0.3425	47.0	89.0	40.0	10.00
R46711/32	11/32	8.73	0.3438	47.0	89.0	40.0	10.00
R4678.8	–	8.80	0.3465	47.0	89.0	40.0	10.00
R4678.9	–	8.90	0.3504	47.0	89.0	40.0	10.00
R4679.0	–	9.00	0.3543	47.0	89.0	40.0	10.00
R4679.1	–	9.10	0.3583	47.0	89.0	40.0	10.00
R46723/64	23/64	9.13	0.3594	47.0	89.0	40.0	10.00
R4679.3	–	9.30	0.3661	47.0	89.0	40.0	10.00
R4679.4	–	9.40	0.3701	47.0	89.0	40.0	10.00
R4679.5	–	9.50	0.3740	47.0	89.0	40.0	10.00
R4673/8	3/8	9.53	0.3750	47.0	89.0	40.0	10.00
R4679.6	–	9.60	0.3780	47.0	89.0	40.0	10.00
R4679.7	–	9.70	0.3819	47.0	89.0	40.0	10.00
R4679.8	–	9.80	0.3858	47.0	89.0	40.0	10.00
R4679.9	–	9.90	0.3898	47.0	89.0	40.0	10.00

Product	DC	DC	DC	LCF	OAL	LS	DCON MS
	(inch)	(mm)	(inch)	(mm)	(mm)	(mm)	(mm)
R46725/64	25/64	9.92	0.3906	47.0	89.0	40.0	10.00
R46710.0	–	10.00	0.3937	47.0	89.0	40.0	10.00
R46710.05	–	10.05	0.3957	55.0	102.0	45.0	12.00
R46710.1	–	10.10	0.3976	55.0	102.0	45.0	12.00
R46710.2	–	10.20	0.4016	55.0	102.0	45.0	12.00
R46710.3	–	10.30	0.4055	55.0	102.0	45.0	12.00
R46713/32	13/32	10.32	0.4063	55.0	102.0	45.0	12.00
R46710.4	–	10.40	0.4094	55.0	102.0	45.0	12.00
R46710.5	–	10.50	0.4134	55.0	102.0	45.0	12.00
R46710.6	–	10.60	0.4173	55.0	102.0	45.0	12.00
R46727/64	27/64	10.72	0.4219	55.0	102.0	45.0	12.00
R46710.9	–	10.90	0.4291	55.0	102.0	45.0	12.00
R46711.0	–	11.00	0.4331	55.0	102.0	45.0	12.00
R4677/16	7/16	11.11	0.4375	55.0	102.0	45.0	12.00
R46711.2	–	11.20	0.4409	55.0	102.0	45.0	12.00
R46711.4	–	11.40	0.4488	55.0	102.0	45.0	12.00
R46711.5	–	11.50	0.4528	55.0	102.0	45.0	12.00
R46729/64	29/64	11.51	0.4531	55.0	102.0	45.0	12.00
R46711.8	–	11.80	0.4646	55.0	102.0	45.0	12.00
R46715/32	15/32	11.91	0.4688	55.0	102.0	45.0	12.00
R46712.0	–	12.00	0.4724	55.0	102.0	45.0	12.00
R46712.05	–	12.05	0.4744	60.0	107.0	45.0	14.00
R46712.1	–	12.10	0.4764	60.0	107.0	45.0	14.00
R46712.2	–	12.20	0.4803	60.0	107.0	45.0	14.00
R46731/64	31/64	12.30	0.4844	60.0	107.0	45.0	14.00
R46712.5	–	12.50	0.4921	60.0	107.0	45.0	14.00
R46712.7	–	12.70	0.5000	60.0	107.0	45.0	14.00
R4671/2	1/2	12.70	0.5000	60.0	107.0	45.0	14.00
R46713.0	–	13.00	0.5118	60.0	107.0	45.0	14.00
R46733/64	33/64	13.10	0.5156	60.0	107.0	45.0	14.00
R46717/32	17/32	13.49	0.5313	60.0	107.0	45.0	14.00
R46713.5	–	13.50	0.5315	60.0	107.0	45.0	14.00
R46735/64	35/64	13.89	0.5469	60.0	107.0	45.0	14.00
R46714.0	–	14.00	0.5512	60.0	107.0	45.0	14.00
R46714.25	–	14.25	0.5610	65.0	115.0	48.0	16.00
R4679/16	9/16	14.29	0.5625	65.0	115.0	48.0	16.00
R46714.5	–	14.50	0.5709	65.0	115.0	48.0	16.00
R46737/64	37/64	14.68	0.5781	65.0	115.0	48.0	16.00
R46715.0	–	15.00	0.5906	65.0	115.0	48.0	16.00
R46719/32	19/32	15.08	0.5938	65.0	115.0	48.0	16.00
R46715.1	–	15.10	0.5945	65.0	115.0	48.0	16.00
R46715.3	–	15.30	0.6024	65.0	115.0	48.0	16.00
R46715.5	–	15.50	0.6102	65.0	115.0	48.0	16.00
R4675/8	5/8	15.88	0.6250	65.0	115.0	48.0	16.00
R46716.0	–	16.00	0.6299	65.0	115.0	48.0	16.00

R463



FORCE M-borr av solid hårdmetall, borrhjup 5xD, invändiga kylkanaler, TiAlN-belagd

Högproduktivt borr som ger hål med hög noggrannhet och finish. H9-tolerans möjlig under rätt förhållanden. 140° spetsvinkel och 4-fasettspetslipning. Spårutformning med CTW-design. Invändiga kylkanaler. TiAlN-beläggning ökar slitstyrka och livslängd. Lämpar sig bäst för borrar i rostfritt stål och varmhållfasta material.

FORCE M

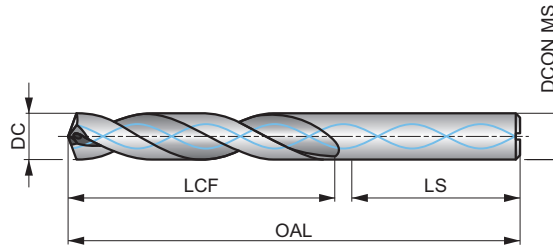

HM	DIN 6537L	5xD
140°	TiAlN	DIN 6535HA
CTW	R	
DC m7		

Arbetsmaterialgrupper och startvärden för skärhastighet (m/min) och matningskod. Tabeller med matningar finns med början på sidan 274

M1.1 ■ 111 G	M1.2 ■ 94 G	M2.1 ■ 99 G	M2.2 ■ 81 G	M2.3 ■ 67 E	M3.1 ■ 83 G	M3.2 ■ 71 G	M3.3 ■ 65 F	M4.1 ■ 57 F	M4.2 ■ 49 E	S1.1 ■ 52 V	S1.2 ■ 43 V	S1.3 ■ 38 U	S2.1 ■ 57 U
S2.2 ■ 53 U	S3.1 ■ 43 U	S3.2 ■ 38 U	S4.1 ■ 33 U	S4.2 ■ 30 U									

DCON MS tolerans h6.

Product	DC (inch)	DC (mm)	DC (inch)	LCF (mm)	OAL (mm)	LS (mm)	DCON MS (mm)
R4633.0	–	3.00	0.1181	28.0	66.0	36.0	6.00
R4633.1	–	3.10	0.1220	28.0	66.0	36.0	6.00
R4631/8	1/8	3.18	0.1250	28.0	66.0	36.0	6.00
R4633.2	–	3.20	0.1260	28.0	66.0	36.0	6.00
R4633.3	–	3.30	0.1299	28.0	66.0	36.0	6.00
R4633.4	–	3.40	0.1339	28.0	66.0	36.0	6.00
R463N29	N29	3.45	0.1360	28.0	66.0	36.0	6.00
R4633.5	–	3.50	0.1378	28.0	66.0	36.0	6.00
R4639/64	9/64	3.57	0.1406	28.0	66.0	36.0	6.00
R4633.6	–	3.60	0.1417	28.0	66.0	36.0	6.00
R4633.7	–	3.70	0.1457	28.0	66.0	36.0	6.00
R4633.8	–	3.80	0.1496	36.0	74.0	36.0	6.00
R4633.9	–	3.90	0.1535	36.0	74.0	36.0	6.00
R4635/32	5/32	3.97	0.1563	36.0	74.0	36.0	6.00
R4634.0	–	4.00	0.1575	36.0	74.0	36.0	6.00
R4634.05	–	4.05	0.1594	36.0	74.0	36.0	6.00
R4634.1	–	4.10	0.1614	36.0	74.0	36.0	6.00
R4634.2	–	4.20	0.1654	36.0	74.0	36.0	6.00
R4634.3	–	4.30	0.1693	36.0	74.0	36.0	6.00
R46311/64	11/64	4.37	0.1719	36.0	74.0	36.0	6.00
R4634.4	–	4.40	0.1732	36.0	74.0	36.0	6.00
R4634.5	–	4.50	0.1772	36.0	74.0	36.0	6.00
R4634.6	–	4.60	0.1811	36.0	74.0	36.0	6.00
R4634.7	–	4.70	0.1850	36.0	74.0	36.0	6.00
R4633/16	3/16	4.76	0.1875	44.0	82.0	36.0	6.00
R4634.8	–	4.80	0.1890	44.0	82.0	36.0	6.00
R4634.9	–	4.90	0.1929	44.0	82.0	36.0	6.00
R4635.0	–	5.00	0.1969	44.0	82.0	36.0	6.00
R4635.05	–	5.05	0.1988	44.0	82.0	36.0	6.00

Product	DC	DC	DC	LCF	OAL	LS	DCON MS
	(inch)	(mm)	(inch)	(mm)	(mm)	(mm)	(mm)
R4635.1	–	5.10	0.2008	44.0	82.0	36.0	6.00
R463N7	N7	5.11	0.2010	44.0	82.0	36.0	6.00
R46313/64	13/64	5.16	0.2031	44.0	82.0	36.0	6.00
R4635.2	–	5.20	0.2047	44.0	82.0	36.0	6.00
R463N5	N5	5.22	0.2055	44.0	82.0	36.0	6.00
R4635.3	–	5.30	0.2087	44.0	82.0	36.0	6.00
R4635.5	–	5.50	0.2165	44.0	82.0	36.0	6.00
R4637/32	7/32	5.56	0.2188	44.0	82.0	36.0	6.00
R4635.6	–	5.60	0.2205	44.0	82.0	36.0	6.00
R4635.7	–	5.70	0.2244	44.0	82.0	36.0	6.00
R4635.8	–	5.80	0.2283	44.0	82.0	36.0	6.00
R4635.9	–	5.90	0.2323	44.0	82.0	36.0	6.00
R46315/64	15/64	5.95	0.2344	44.0	82.0	36.0	6.00
R4636.0	–	6.00	0.2362	44.0	82.0	36.0	6.00
R4636.05	–	6.05	0.2382	53.0	91.0	36.0	8.00
R4636.1	–	6.10	0.2402	53.0	91.0	36.0	8.00
R4636.2	–	6.20	0.2441	53.0	91.0	36.0	8.00
R4636.3	–	6.30	0.2480	53.0	91.0	36.0	8.00
R4631/4	1/4	6.35	0.2500	53.0	91.0	36.0	8.00
R4636.4	–	6.40	0.2520	53.0	91.0	36.0	8.00
R4636.5	–	6.50	0.2559	53.0	91.0	36.0	8.00
R4636.6	–	6.60	0.2598	53.0	91.0	36.0	8.00
R4636.7	–	6.70	0.2638	53.0	91.0	36.0	8.00
R46317/64	17/64	6.75	0.2656	53.0	91.0	36.0	8.00
R4636.8	–	6.80	0.2677	53.0	91.0	36.0	8.00
R4636.9	–	6.90	0.2717	53.0	91.0	36.0	8.00
R4637.0	–	7.00	0.2756	53.0	91.0	36.0	8.00
R4637.1	–	7.10	0.2795	53.0	91.0	36.0	8.00
R4637.2	–	7.20	0.2835	53.0	91.0	36.0	8.00
R4637.3	–	7.30	0.2874	53.0	91.0	36.0	8.00
R4637.4	–	7.40	0.2913	53.0	91.0	36.0	8.00
R4637.5	–	7.50	0.2953	53.0	91.0	36.0	8.00
R4637.6	–	7.60	0.2992	53.0	91.0	36.0	8.00
R4637.7	–	7.70	0.3031	53.0	91.0	36.0	8.00
R4637.8	–	7.80	0.3071	53.0	91.0	36.0	8.00
R4637.9	–	7.90	0.3110	53.0	91.0	36.0	8.00
R4635/16	5/16	7.94	0.3125	53.0	91.0	36.0	8.00
R4638.0	–	8.00	0.3150	53.0	91.0	36.0	8.00
R4638.05	–	8.05	0.3169	61.0	103.0	40.0	10.00
R4638.1	–	8.10	0.3189	61.0	103.0	40.0	10.00
R4638.2	–	8.20	0.3228	61.0	103.0	40.0	10.00
R4638.3	–	8.30	0.3268	61.0	103.0	40.0	10.00
R46321/64	21/64	8.33	0.3281	61.0	103.0	40.0	10.00
R4638.4	–	8.40	0.3307	61.0	103.0	40.0	10.00
R4638.5	–	8.50	0.3346	61.0	103.0	40.0	10.00
R4638.6	–	8.60	0.3386	61.0	103.0	40.0	10.00
R4638.7	–	8.70	0.3425	61.0	103.0	40.0	10.00
R46311/32	11/32	8.73	0.3438	61.0	103.0	40.0	10.00
R4638.8	–	8.80	0.3465	61.0	103.0	40.0	10.00
R4638.9	–	8.90	0.3504	61.0	103.0	40.0	10.00
R4639.0	–	9.00	0.3543	61.0	103.0	40.0	10.00
R4639.1	–	9.10	0.3583	61.0	103.0	40.0	10.00
R46323/64	23/64	9.13	0.3594	61.0	103.0	40.0	10.00
R4639.2	–	9.20	0.3622	61.0	103.0	40.0	10.00
R4639.3	–	9.30	0.3661	61.0	103.0	40.0	10.00
R4639.4	–	9.40	0.3701	61.0	103.0	40.0	10.00
R4639.5	–	9.50	0.3740	61.0	103.0	40.0	10.00
R4633/8	3/8	9.53	0.3750	61.0	103.0	40.0	10.00
R4639.6	–	9.60	0.3780	61.0	103.0	40.0	10.00
R4639.7	–	9.70	0.3819	61.0	103.0	40.0	10.00
R4639.8	–	9.80	0.3858	61.0	103.0	40.0	10.00
R4639.9	–	9.90	0.3898	61.0	103.0	40.0	10.00



Product	DC	DC	DC	LCF	OAL	LS	DCON MS
	(inch)	(mm)	(inch)	(mm)	(mm)	(mm)	(mm)
R46310.0	–	10.00	0.3937	61.0	103.0	40.0	10.00
R46310.05	–	10.05	0.3957	70.0	118.0	45.0	12.00
R46310.1	–	10.10	0.3976	70.0	118.0	45.0	12.00
R46310.2	–	10.20	0.4016	70.0	118.0	45.0	12.00
R46310.3	–	10.30	0.4055	70.0	118.0	45.0	12.00
R46313/32	13/32	10.32	0.4063	70.0	118.0	45.0	12.00
R46310.4	–	10.40	0.4094	70.0	118.0	45.0	12.00
R46310.5	–	10.50	0.4134	70.0	118.0	45.0	12.00
R46327/64	27/64	10.72	0.4219	70.0	118.0	45.0	12.00
R46310.8	–	10.80	0.4252	70.0	118.0	45.0	12.00
R46311.0	–	11.00	0.4331	70.0	118.0	45.0	12.00
R4637/16	7/16	11.11	0.4375	70.0	118.0	45.0	12.00
R46311.2	–	11.20	0.4409	70.0	118.0	45.0	12.00
R46311.3	–	11.30	0.4449	70.0	118.0	45.0	12.00
R46311.4	–	11.40	0.4488	70.0	118.0	45.0	12.00
R46311.5	–	11.50	0.4528	70.0	118.0	45.0	12.00
R46329/64	29/64	11.51	0.4531	70.0	118.0	45.0	12.00
R46311.6	–	11.60	0.4567	70.0	118.0	45.0	12.00
R46311.8	–	11.80	0.4646	70.0	118.0	45.0	12.00
R46315/32	15/32	11.91	0.4688	70.0	118.0	45.0	12.00
R46312.0	–	12.00	0.4724	70.0	118.0	45.0	12.00
R46312.05	–	12.05	0.4744	76.0	124.0	45.0	14.00
R46312.2	–	12.20	0.4803	76.0	124.0	45.0	14.00
R46331/64	31/64	12.30	0.4844	76.0	124.0	45.0	14.00
R46312.5	–	12.50	0.4921	76.0	124.0	45.0	14.00
R46312.7	–	12.70	0.5000	76.0	124.0	45.0	14.00
R4631/2	1/2	12.70	0.5000	76.0	124.0	45.0	14.00
R46312.8	–	12.80	0.5039	76.0	124.0	45.0	14.00
R46313.0	–	13.00	0.5118	76.0	124.0	45.0	14.00
R46333/64	33/64	13.10	0.5156	76.0	124.0	45.0	14.00
R46313.5	–	13.50	0.5315	76.0	124.0	45.0	14.00
R46313.8	–	13.80	0.5433	76.0	124.0	45.0	14.00
R46314.0	–	14.00	0.5512	76.0	124.0	45.0	14.00
R46314.25	–	14.25	0.5610	82.0	133.0	48.0	16.00
R46314.5	–	14.50	0.5709	82.0	133.0	48.0	16.00
R46315.0	–	15.00	0.5906	82.0	133.0	48.0	16.00
R46315.3	–	15.30	0.6024	82.0	133.0	48.0	16.00
R46315.5	–	15.50	0.6102	82.0	133.0	48.0	16.00
R46315.8	–	15.80	0.6220	82.0	133.0	48.0	16.00
R46316.0	–	16.00	0.6299	82.0	133.0	48.0	16.00

R7131



Tappborr av solid HM för borring och fasning av gänghål, inv. kylkanaler, TiAlN-belagd

Universellt tappborr med tapplängd anpassad för borring av gänghål för metriskå gängor med samtidig fasning av hålkanten, vilket sparar ett moment. Tappen har 140° spetsvinkel och försänkingskären har 90° vinkel. TiAlN-beläggning förbättrar livslängden. Användbart i många olika material.

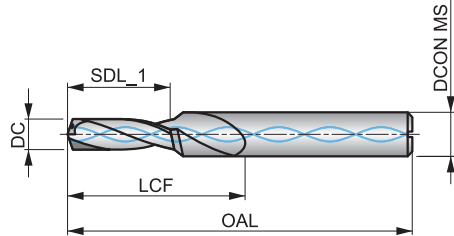

HM	DORMER	3xD
90°	TiAlN	DIN 6535HA
λ 20-35°	R	
DC m7		

Arbetsmaterialgrupper och startvärden för skärhastighet (m/min) och matningskod. Tabeller med matningar finns med början på sidan 274

P1.1 ■ 139 W	P1.2 ■ 156 W	P1.3 ■ 161 W	P2.1 ■ 119 W	P2.2 ■ 105 W	P2.3 ■ 93 V	P3.1 ■ 96 V	P3.2 ■ 77 V	P3.3 ■ 65 V	P4.1 ■ 57 V	P4.2 ■ 48 V	M1.1 ■ 62 V	M1.2 ■ 52 V	M2.1 ■ 55 V
M2.2 ■ 45 V	M3.1 ■ 47 V	M3.2 ■ 40 V	M3.3 ■ 36 U	M4.1 ■ 35 U	K1.1 ■ 90 W	K1.2 ■ 67 W	K1.3 ■ 50 W	K2.1 ■ 92 V	K2.2 ■ 75 V	K2.3 ■ 60 V	K3.1 ■ 82 V	K3.2 ■ 62 V	K3.3 ■ 50 V
K4.1 ■ 76 V	K4.2 ■ 57 V	K4.3 ■ 42 V	K4.4 ■ 36 V	K4.5 ■ 30 V	K5.1 ■ 86 V	K5.2 ■ 64 V	K5.3 ■ 50 V	N1.1 ■ 250 W	N1.2 ■ 188 W	N1.3 ■ 125 W	N2.1 ■ 308 V	N2.2 ■ 277 V	N2.3 ■ 200 V
N3.1 ■ 373 W	N3.2 ■ 220 W	N3.3 ■ 110 W											

DCON MS tolerans h6.

Product	DC (mm)	DC (inch)	SDL_1 (mm)	LCF (mm)	OAL (mm)	DCON MS (mm)	TDZ
R71313.3	3.30	0.1299	11.40	20.0	66.0	6.00	M4
R71314.2	4.20	0.1654	13.60	24.0	66.0	6.00	M5
R71315.0	5.00	0.1969	16.50	28.0	79.0	8.00	M6
R71316.8	6.80	0.2677	21.00	34.0	89.0	10.00	M8
R71318.5	8.50	0.3346	25.50	47.0	102.0	12.00	M10
R713110.2	10.20	0.4016	30.00	55.0	107.0	14.00	M12
R713110.4	10.40	0.4094	30.00	55.0	107.0	14.00	M12

Verktygsmaterial (BMC)	HSS	HSS	HSS	HSS	HSS	HM	HM						
Standard (BSG)	DORMER	DORMER	DORMER	DORMER	DORMER	DORMER	DORMER						
Användbar längd (ULDR)	1.5xD	3xD	5xD	8xD	12xD								
Spetsvinkel						140°	140°						
Beläggning	Bright Ni	Bright Ni	Bright Ni	Bright Ni	Bright Ni	Ti-phon	Ti-phon						
Skaft	ISO 9786	DIN 6535HB DIN 6535HE	DIN 6535HB DIN 6535HE	DIN 6535HB DIN 6535HE									
Skärriktning	R	R	R	R	R	R	R						
Kylning (CSP)													
Produktfamilj	H851	H853	H855	H858	H8512	R950	R960	H860	H861				
PSF skärdiametrar	31/64 - 30.00	12.00 - 42.50	12.00 - 42.50	14.00 - 42.50	14.00 - 25.00	15/32 - 42.00	15/32 - 30.50	N1 - N7	N1 - N5				
	218	219	221	223	224	225	227	229	229				
P	P1					■	■						
	P2					■	■						
	P3					■	■						
	P4					■	■						
M	M1						■						
	M2						■						
	M3						■						
	M4						■						
K	K1						■						
	K2					■	■						
	K3					■	■						
	K4					■	■						
	K5					■	■						
N	N1												
	N2												
	N3												
	N4												
	N5												
S	S1						■						
	S2						■						
	S3						■						
	S4						■						
H	H1												
	H2												
	H3												
	H4												

H851



HYDRA borkropp, 1,5xD, med kylkanaler, nickelpläterad

Används tillsammans med borkronorna R950 och R960. Flera krondiametrar passar på en och samma borkropp, vilket ökar flexibiliteten, samtidigt som man sparar kostnader. Borkroppen är tillverkad av verktygsstål och borddelen är nickelpläterad för att motstå korrosion och för lägre friktion mot spånorna.

HYDRA

HSS		1.5xD
Bright Ni		

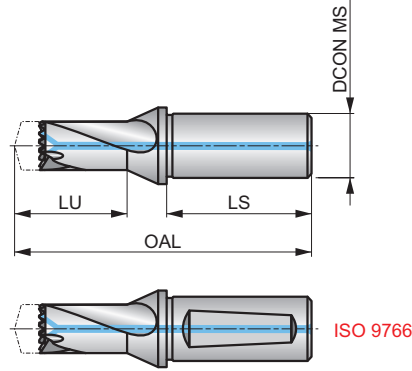

Fyra (4) skruvaroch en(1) mejsel medföljer borkroppen, DCON MS tolerans h6

Product	DCON MS	DCON MS	LU	OAL	LS	ADINTMS
	(inch)	(mm)	(mm)	(mm)	(mm)	
H85131/64	5/8	15.88	25.50	88.5	47.6	Cylindrical
H85117/32	5/8	15.88	30.90	93.9	47.6	Cylindrical
H85112.0	–	16.00	25.50	88.5	48.0	ISO 9766
H85112.5	–	16.00	25.80	88.8	48.0	ISO 9766
H85113.0	–	16.00	27.00	90.0	48.0	ISO 9766
H85114.0	–	16.00	30.90	93.9	48.0	ISO 9766
H85139/64	3/4	19.05	32.30	97.3	50.8	Cylindrical
H85141/64	3/4	19.05	34.90	99.9	50.8	Cylindrical
H85111/16	3/4	19.05	36.40	101.4	50.8	Cylindrical
H85123/32	3/4	19.05	39.00	104.0	50.8	Cylindrical
H85115.0	–	20.00	32.30	97.3	50.0	ISO 9766
H85116.0	–	20.00	34.90	99.9	50.0	ISO 9766
H85117.0	–	20.00	36.40	101.4	50.0	ISO 9766
H85118.0	–	20.00	39.00	104.0	50.0	ISO 9766
H85119.0	–	25.00	40.40	111.4	56.0	ISO 9766
H85120.0	–	25.00	43.00	114.0	56.0	ISO 9766
H85121.0	–	25.00	44.50	115.5	56.0	ISO 9766
H85122.0	–	25.00	46.10	117.1	56.0	ISO 9766
H85123.0	–	25.00	47.00	118.0	56.0	ISO 9766
H85149/64	1"	25.40	40.40	111.4	57.1	Cylindrical
H85151/64	1"	25.40	43.00	114.0	57.1	Cylindrical
H85127/32	1"	25.40	44.50	115.5	57.1	Cylindrical
H85157/64	1"	25.40	46.10	117.1	57.1	Cylindrical
H85159/64	1"	25.40	47.00	118.0	57.1	Cylindrical
H85131/32	1"	25.40	49.30	124.3	57.1	Cylindrical
H8511.1/64	1.1/4	31.75	49.70	124.7	60.3	Cylindrical
H8511.3/64	1.1/4	31.75	52.30	127.3	60.3	Cylindrical
H8511.3/32	1.1/4	31.75	52.80	127.8	60.3	Cylindrical
H8511.3/16	1.1/4	31.75	58.40	133.4	60.3	Cylindrical
H85124.0	–	32.00	49.30	124.3	60.0	ISO 9766
H85125.0	–	32.00	49.70	124.7	60.0	ISO 9766
H85126.0	–	32.00	52.30	127.3	60.0	ISO 9766
H85127.0	–	32.00	52.80	127.8	60.0	ISO 9766
H85128.0	–	32.00	54.40	129.4	60.0	ISO 9766
H85129.0	–	32.00	55.80	130.8	60.0	ISO 9766
H85130.0	–	32.00	58.40	133.4	60.0	ISO 9766

H853



HYDRA borkropp, 3xD, med kylkanaler, nickelpläterad

Används tillsammans med borkronorna R950 och R960. Flera krondiametrar passar på en och samma borkropp, vilket ökar flexibiliteten, samtidigt som man sparar kostnader. Borkroppen är tillverkad av verktygsstål och borddelen är nickelpläterad för att motstå korrosion och för lägre friktion mot spånorna.

HYDRA

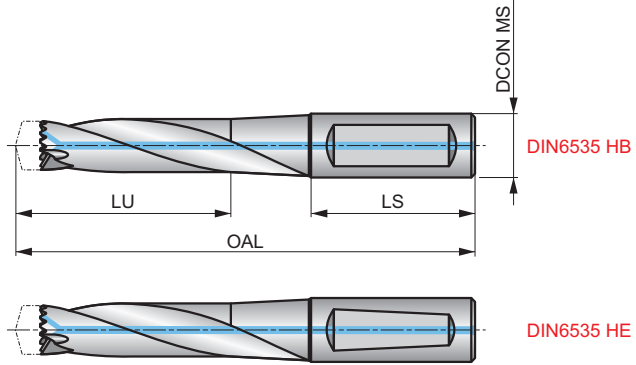

HSS	DORMER	3xD
Bright Ni	DIN 6535HB DIN 6535HE	R

Fyra (4) skruvaroch en(1) mejsel medföljer borkroppen, DCON MS tolerans h6

Product	DCON MS		LU	OAL	LS	ADINTMS
	(inch)	(mm)				
H85312.0	–	16.00	44.00	105.0	48.0	DIN6535HE
H85331/64	5/8	15.88	44.00	105.0	48.0	DIN6535HB
H85312.5	–	16.00	44.00	105.0	48.0	DIN6535HE
H8531/2	5/8	15.88	44.00	105.0	48.0	DIN6535HB
H85313.0	–	16.00	47.00	110.0	48.0	DIN6535HE
H85317/32	5/8	15.88	47.00	110.0	48.0	DIN6535HB
H85314.0	–	16.00	52.50	116.5	48.0	DIN6535HE
H8539/16	3/4	19.05	52.50	116.5	48.0	DIN6535HB
H85315.0	–	20.00	55.50	126.5	50.0	DIN6535HE
H85339/64	3/4	19.05	55.50	126.5	50.0	DIN6535HB
H85316.0	–	20.00	59.50	131.5	50.0	DIN6535HE
H85341/64	3/4	19.05	59.50	131.5	50.0	DIN6535HB
H85317.0	–	20.00	62.50	136.5	50.0	DIN6535HE
H85311/16	3/4	19.05	62.50	136.5	50.0	DIN6535HB
H85318.0	–	20.00	66.50	141.5	50.0	DIN6535HE
H85323/32	3/4	19.05	66.50	141.5	50.0	DIN6535HB
H85319.0	–	25.00	69.50	156.5	56.0	DIN6535HE
H85349/64	1"	25.40	69.50	156.5	56.0	DIN6535HB
H85320.0	–	25.00	73.50	156.5	56.0	DIN6535HE
H85351/64	1"	25.40	73.50	156.5	56.0	DIN6535HB
H85321.0	–	25.00	76.50	156.5	56.0	DIN6535HE
H85327/32	1"	25.40	76.50	156.5	56.0	DIN6535HB
H85322.0	–	25.00	80.10	161.5	56.0	DIN6535HE
H85357/64	1"	25.40	80.10	161.5	56.0	DIN6535HB
H85323.0	–	25.00	82.50	160.5	56.0	DIN6535HE
H85359/64	1"	25.40	82.50	160.5	56.0	DIN6535HB
H85324.0	–	32.00	86.20	170.2	60.0	DIN6535HE
H85331/32	1"	25.40	86.20	170.2	60.0	DIN6535HB
H85325.0	–	32.00	88.00	170.0	60.0	DIN6535HE
H8531.1/64	1.1/4	31.75	88.00	170.0	60.0	DIN6535HB
H85326.0	–	32.00	92.00	175.0	60.0	DIN6535HE
H8531.3/64	1.1/4	31.75	92.00	175.0	60.0	DIN6535HB
H85327.0	–	32.00	94.00	175.0	60.0	DIN6535HE
H8531.3/32	1.1/4	31.75	94.00	175.0	60.0	DIN6535HB

Product	DCON MS	DCON MS	LU	OAL	LS	ADINTMS
	(inch)	(mm)	(mm)	(mm)	(mm)	
H85328.0	–	32.00	97.00	180.0	60.0	DIN6535HE
H8531.1/8	1.1/4	31.75	97.00	180.0	60.0	DIN6535HB
H85329.0	–	32.00	100.00	185.0	60.0	DIN6535HE
H8531.11/64	1.1/4	31.75	100.00	185.0	60.0	DIN6535HB
H85330.0	–	32.00	104.00	185.0	60.0	DIN6535HE
H8531.3/16	1.1/4	31.75	104.00	185.0	60.0	DIN6535HB
H85332.0	–	32.00	111.50	196.5	60.0	DIN6535HE
H85333.5	–	32.00	116.50	201.5	60.0	DIN6535HE
H85335.0	–	40.00	121.50	216.5	70.0	DIN6535HB
H85336.5	–	40.00	125.50	221.5	70.0	DIN6535HB
H85338.0	–	40.00	131.50	226.5	70.0	DIN6535HB
H85339.5	–	40.00	136.50	231.5	70.0	DIN6535HB
H85341.0	–	40.00	146.50	246.5	70.0	DIN6535HB
H85342.5	–	40.00	151.60	251.6	70.0	DIN6535HB

H855



HYDRA borkropp, 5xD, med kylkanaler, nickelpläterad

Används tillsammans med borkronorna R950 och R960. Flera krondiametrar passar på en och samma borkropp, vilket ökar flexibiliteten, samtidigt som man sparar kostnader. Borkroppen är tillverkad av verktygsstål och borddelen är nickelpläterad för att motstå korrosion och för lägre friktion mot spånorna.

HYDRA

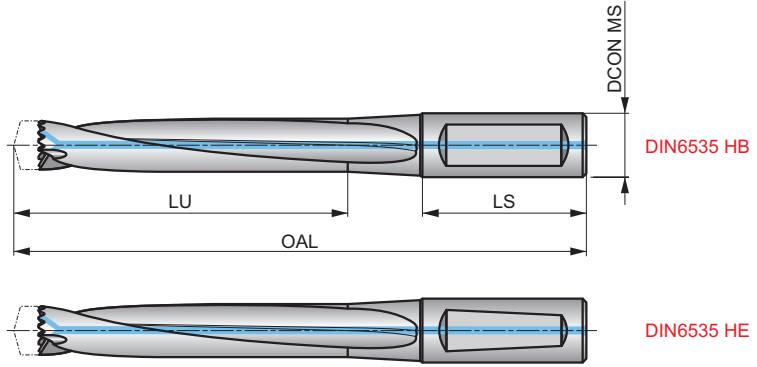

HSS	DORMER	5xD
Bright Ni	DIN 6535HB DIN 6535HE	R

Fyra (4) skruvaroch en(1) mejsel medföljer borkroppen, DCON MS tolerans h6

Product	DCON MS		LU	OAL	LS	ADINTMS
	(inch)	(mm)				
H85512.0	–	16.00	69.00	130.0	48.0	DIN6535HE
H85531/64	5/8	15.88	69.00	130.0	48.0	DIN6535HB
H85512.5	–	16.00	69.00	130.0	48.0	DIN6535HE
H8551/2	5/8	15.88	69.00	130.0	48.0	DIN6535HB
H85513.0	–	16.00	74.00	140.0	48.0	DIN6535HE
H85517/32	5/8	15.88	74.00	140.0	48.0	DIN6535HB
H85514.0	–	16.00	81.50	146.5	48.0	DIN6535HE
H8559/16	3/4	19.05	81.50	146.5	48.0	DIN6535HB
H85515.0	–	20.00	86.50	156.5	50.0	DIN6535HE
H85539/64	3/4	19.05	86.50	156.5	50.0	DIN6535HB
H85516.0	–	20.00	92.50	166.5	50.0	DIN6535HE
H85541/64	3/4	19.05	92.50	166.5	50.0	DIN6535HB
H85517.0	–	20.00	97.50	171.5	50.0	DIN6535HE
H85511/16	3/4	19.05	97.50	171.5	50.0	DIN6535HB
H85518.0	–	20.00	103.50	176.5	50.0	DIN6535HE
H85523/32	3/4	19.05	103.50	176.5	50.0	DIN6535HB
H85519.0	–	25.00	108.50	191.5	56.0	DIN6535HE
H85549/64	1"	25.40	108.50	191.5	56.0	DIN6535HB
H85520.0	–	25.00	114.50	196.5	56.0	DIN6535HE
H85551/64	1"	25.40	114.50	196.5	56.0	DIN6535HB
H85521.0	–	25.00	119.50	196.5	56.0	DIN6535HE
H85527/32	1"	25.40	119.50	196.5	56.0	DIN6535HB
H85522.0	–	25.00	125.10	201.1	56.0	DIN6535HE
H85557/64	1"	25.40	125.10	201.1	56.0	DIN6535HB
H85523.0	–	25.00	129.50	210.5	56.0	DIN6535HE
H85559/64	1"	25.40	129.50	210.5	56.0	DIN6535HB
H85524.0	–	32.00	135.20	220.2	60.0	DIN6535HE
H85531/32	1"	25.40	135.20	220.2	60.0	DIN6535HB
H85525.0	–	32.00	140.00	225.0	60.0	DIN6535HE
H8551.1/64	1.1/4	31.75	140.00	225.0	60.0	DIN6535HB
H85526.0	–	32.00	146.00	230.0	60.0	DIN6535HE
H8551.3/64	1.1/4	31.75	146.00	230.0	60.0	DIN6535HB
H85527.0	–	32.00	151.00	235.0	60.0	DIN6535HE
H8551.3/32	1.1/4	31.75	151.00	235.0	60.0	DIN6535HB

Product	DCON MS	DCON MS	LU	OAL	LS	ADINTMS
	(inch)	(mm)	(mm)	(mm)	(mm)	
H85528.0	–	32.00	157.00	240.0	60.0	DIN6535HE
H8551.1/8	1.1/4	31.75	157.00	240.0	60.0	DIN6535HB
H85529.0	–	32.00	162.00	245.0	60.0	DIN6535HE
H8551.11/64	1.1/4	31.75	162.00	245.0	60.0	DIN6535HB
H85530.0	–	32.00	167.00	255.0	60.0	DIN6535HE
H8551.3/16	1.1/4	31.75	167.00	255.0	60.0	DIN6535HB
H85532.0	–	32.00	176.50	261.5	60.0	DIN6535HE
H85533.5	–	32.00	186.50	271.5	60.0	DIN6535HE
H85535.0	–	40.00	196.50	291.5	70.0	DIN6535HB
H85536.5	–	40.00	201.50	296.5	70.0	DIN6535HB
H85538.0	–	40.00	211.50	306.5	70.0	DIN6535HB
H85539.5	–	40.00	221.50	316.5	70.0	DIN6535HB
H85541.0	–	40.00	226.50	325.6	70.0	DIN6535HB
H85542.5	–	40.00	236.50	336.5	70.0	DIN6535HB

H858

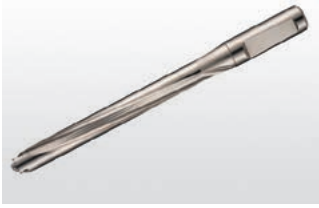

HYDRA borrhopp, 8xD, med kylkanaler, nickelpläterad

Används tillsammans med borrhörnorna R950, R960. Flera krondiametrar passar på en och samma borrhopp, vilket ökar flexibiliteten, samtidigt som man sparar kostnader. Borrhoppens är tillverkad av verktygsstål och borrhölen är nickelpläterad för att motstå korrosion och för lägre friktion mot spånorna.

HYDRA

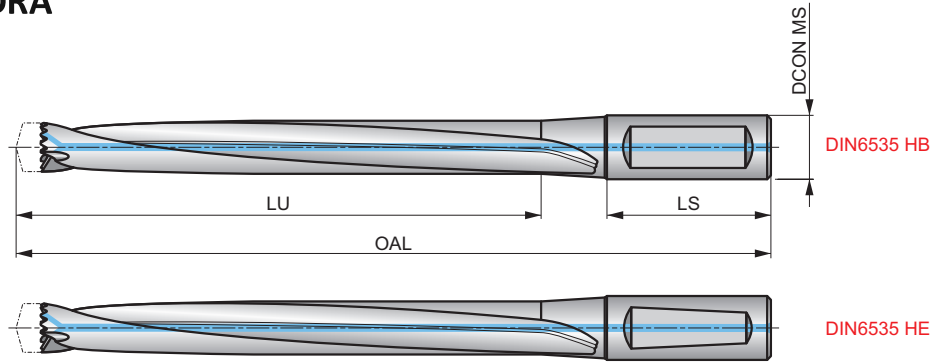

HSS	DORMER	8xD
Bright Ni	DIN 6535HB DIN 6535HE	R

Fyra (4) skruvaroch en(1) mejsel medföljer borrhoppens, DCON MS tolerans h6

Product	DCON MS	LU	OAL	LS	ADINTMS
	(mm)	(mm)	(mm)	(mm)	
H85814.0	16.00	124.50	191.5	48.0	DIN6535HE
H85815.0	20.00	133.50	201.5	50.0	DIN6535HE
H85816.0	20.00	141.50	211.5	50.0	DIN6535HE
H85817.0	20.00	150.50	221.5	50.0	DIN6535HE
H85818.0	20.00	158.50	226.5	50.0	DIN6535HE
H85819.0	25.00	167.50	251.5	56.0	DIN6535HE
H85820.0	25.00	175.50	264.5	56.0	DIN6535HE
H85821.0	25.00	184.50	266.5	56.0	DIN6535HE
H85822.0	25.00	192.10	271.1	56.0	DIN6535HE
H85823.0	25.00	200.50	280.5	56.0	DIN6535HE
H85824.0	32.00	208.20	295.2	60.0	DIN6535HE
H85825.0	32.00	217.00	300.0	60.0	DIN6535HE
H85826.0	32.00	225.00	310.0	60.0	DIN6535HE
H85827.0	32.00	234.00	320.0	60.0	DIN6535HE
H85828.0	32.00	242.00	325.0	60.0	DIN6535HE
H85829.0	32.00	251.00	335.0	60.0	DIN6535HE
H85830.0	32.00	259.00	345.0	60.0	DIN6535HE
H85832.0	32.00	271.50	356.5	60.0	DIN6535HE
H85833.5	32.00	286.50	371.5	60.0	DIN6535HE
H85835.0	40.00	301.50	396.5	70.0	DIN6535HB
H85836.5	40.00	311.50	406.5	70.0	DIN6535HB
H85838.0	40.00	326.50	421.5	70.0	DIN6535HB
H85839.5	40.00	336.50	431.5	70.0	DIN6535HB
H85841.0	40.00	351.50	451.5	70.0	DIN6535HB
H85842.5	40.00	361.50	461.5	70.0	DIN6535HB

H8512



HYDRA borrkropp, 12xD, med kylkanaler, nickelpläterad

Används tillsammans med borrkronorna R950 och R960. Flera krondiametrar passar på en och samma borrkropp, vilket ökar flexibiliteten, samtidigt som man sparar kostnader. Borrkroppen är tillverkad av verktygsstål och borr delen är nickelpläterad för att motstå korrosion och för lägre friktion mot spånorna.

HYDRA

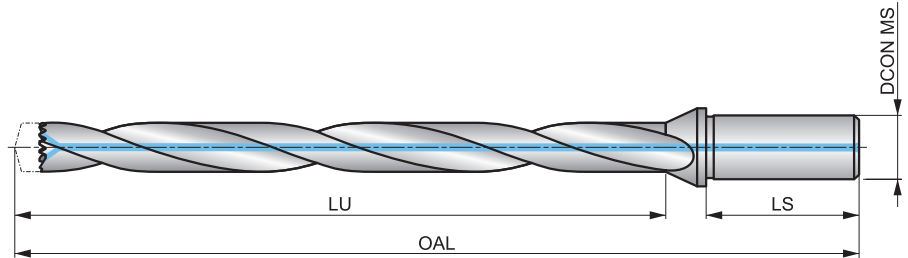

HSS	DORMER	12xD
Bright Ni		R

Fyra (4) skruvaroch en(1) mejsel medföljer borrkroppen, DCON MS tolerans h6

Product	DCON MS (mm)	LU (mm)	OAL (mm)	LS (mm)
H851214.0	16.00	168.00	236.0	48.0
H851215.0	20.00	180.00	250.3	50.0
H851216.0	20.00	192.00	262.6	50.0
H851217.0	20.00	204.00	275.0	50.0
H851218.0	20.00	216.00	287.2	50.0
H851219.0	25.00	228.00	305.6	56.0
H851220.0	25.00	240.00	317.8	56.0
H851221.0	25.00	252.00	330.1	56.0
H851222.0	25.00	264.00	343.0	56.0
H851223.0	25.00	276.00	354.8	56.0
H851224.0	32.00	288.00	371.7	60.0
H851225.0	32.00	300.00	383.8	60.0

R950

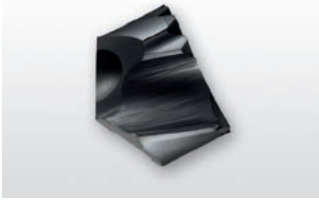

HYDRA-borrkrona för stål, Ti-phon-belagd

Kostnadseffektiv precisionsborkrona av solid HM för borming i stål och hårda material. Självcenterande borspets med 140° spetsvinkel minskar skärkrafterna. Belagd med Ti-phon, som skyddar mot påkletning och förbättrar spånavgången samt ökar livslängden och eggstyrkan.

HYDRA

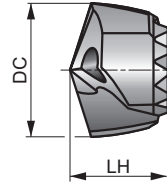

HM	DORMER	140°
Ti-phon	R	DC
DC h7		

H851	Apply starting values for speed and feed with a correction factor of 1.10
H853	Apply starting values for speed and feed with a correction factor of 1.00
H855	Apply starting values for speed and feed with a correction factor of 0.80
H858	Apply starting values for speed and feed with a correction factor of 0.60
H8512	Apply starting values for speed and feed with a correction factor of 0.50

Arbetsmaterialgrupper och startvärden för skärhastighet (m/min) och matningskod. Tabeller med matningar finns med början på sidan 274

P1.1	P1.2	P1.3	P2.1	P2.2	P2.3	P3.1	P3.2	P3.3	P4.1	P4.2	P4.3	M2.3	M4.2
▣133 W	▣148 W	▣154 W	▣114 W	▣100 W	▣88 W	▣125 W	▣101 W	▣85 W	▣75 W	▣63 W	▣52 T	▣41 T	▣35 T
K2.1	K2.2	K2.3	K3.1	K3.2	K3.3	K4.1	K4.2	K4.3	K4.4	K4.5	K5.1	K5.2	K5.3
▣108 V	▣88 V	▣70 V	▣96 V	▣73 V	▣59 V	▣89 V	▣67 V	▣49 V	▣42 V	▣35 V	▣100 V	▣76 V	▣58 V

Product	DC	DC	DC	LH
	(inch)	(mm)	(inch)	(mm)
R95015/32	15/32	11.91	0.4688	9.1
R95012.0	–	12.00	0.4724	9.1
R95012.1	–	12.10	0.4764	9.1
R95012.2	–	12.20	0.4803	9.1
R95031/64	31/64	12.30	0.4844	9.1
R95012.5	–	12.50	0.4921	9.4
R95012.6	–	12.60	0.4961	9.4
R9501/2	1/2	12.70	0.5000	9.4
R95012.8	–	12.80	0.5039	9.4
R95012.9	–	12.90	0.5079	9.4
R95013.0	–	13.00	0.5118	9.7
R95033/64	33/64	13.10	0.5156	9.7
R95013.2	–	13.20	0.5197	9.7
R95017/32	17/32	13.49	0.5313	9.7
R95013.5	–	13.50	0.5315	10.3
R95013.6	–	13.60	0.5354	10.3
R95013.7	–	13.70	0.5394	10.3
R95013.8	–	13.80	0.5433	10.3
R95035/64	35/64	13.89	0.5469	10.3
R95014.0	–	14.00	0.5512	10.3
R95014.1	–	14.10	0.5551	10.3
R95014.2	–	14.20	0.5591	10.3
R9509/16	9/16	14.29	0.5625	10.3
R95014.5	–	14.50	0.5709	10.3
R95014.6	–	14.60	0.5748	11.0
R95037/64	37/64	14.68	0.5781	11.0
R95014.7	–	14.70	0.5787	11.0
R95014.8	–	14.80	0.5827	11.0
R95015.0	–	15.00	0.5906	11.0
R95019/32	19/32	15.08	0.5938	11.0

Product	DC	DC	DC	LH
	(inch)	(mm)	(inch)	(mm)
R95015.1	–	15.10	0.5945	11.0
R95015.2	–	15.20	0.5984	11.0
R95015.24	–	15.24	0.6000	11.0
R95039/64	39/64	15.48	0.6094	11.0
R95015.5	–	15.50	0.6102	11.0
R95015.6	–	15.60	0.6142	11.6
R95015.7	–	15.70	0.6181	11.6
R9505/8	5/8	15.88	0.6250	11.6
R95016.0	–	16.00	0.6299	11.6
R95016.08	–	16.08	0.6331	11.6
R95016.1	–	16.10	0.6339	11.6
R95016.2	–	16.20	0.6378	11.6
R95041/64	41/64	16.27	0.6406	11.6
R95016.3	–	16.30	0.6417	11.6
R95016.5	–	16.50	0.6496	11.6
R95016.6	–	16.60	0.6535	12.2
R95021/32	21/32	16.67	0.6563	12.2
R95016.7	–	16.70	0.6575	12.2
R95017.0	–	17.00	0.6693	12.2
R95043/64	43/64	17.07	0.6719	12.2
R95017.1	–	17.10	0.6732	12.2
R95017.2	–	17.20	0.6772	12.2
R95011/16	11/16	17.46	0.6875	12.2
R95017.5	–	17.50	0.6890	12.2
R95017.6	–	17.60	0.6929	12.9
R95017.7	–	17.70	0.6969	12.9
R95045/64	45/64	17.86	0.7031	12.9
R95018.0	–	18.00	0.7087	12.9
R95018.1	–	18.10	0.7126	12.9
R95018.2	–	18.20	0.7165	12.9

Product	DC	DC	DC	LH
	(inch)	(mm)	(inch)	(mm)
R95023/32	23/32	18.26	0.7188	12.9
R95018.5	–	18.50	0.7283	12.9
R95018.6	–	18.60	0.7323	13.5
R95047/64	47/64	18.65	0.7344	13.5
R95018.7	–	18.70	0.7362	13.5
R95018.9	–	18.90	0.7441	13.5
R95019.0	–	19.00	0.7480	13.5
R9503/4	3/4	19.05	0.7500	13.5
R95019.1	–	19.10	0.7520	13.5
R95019.2	–	19.20	0.7559	13.5
R95019.25	–	19.25	0.7579	13.5
R95019.3	–	19.30	0.7598	13.5
R95019.35	–	19.35	0.7618	13.5
R95049/64	49/64	19.45	0.7656	13.5
R95019.5	–	19.50	0.7677	13.5
R95019.6	–	19.60	0.7717	14.1
R95019.7	–	19.70	0.7756	14.1
R95025/32	25/32	19.84	0.7813	14.1
R95020.0	–	20.00	0.7874	14.1
R95051/64	51/64	20.24	0.7969	14.1
R95020.5	–	20.50	0.8071	14.1
R95013/16	13/16	20.64	0.8125	14.8
R95021.0	–	21.00	0.8268	14.8
R95053/64	53/64	21.03	0.8281	14.8
R95027/32	27/32	21.43	0.8438	14.8
R95021.5	–	21.50	0.8465	14.8
R95055/64	55/64	21.83	0.8594	15.0
R95022.0	–	22.00	0.8661	15.0
R9507/8	7/8	22.22	0.8750	15.0
R95022.5	–	22.50	0.8858	15.0
R95057/64	57/64	22.62	0.8906	15.0
R95022.7	–	22.70	0.8937	15.0
R95023.0	–	23.00	0.9055	15.1
R95029/32	29/32	23.02	0.9063	15.1
R95059/64	59/64	23.42	0.9219	15.1
R95023.5	–	23.50	0.9252	15.1
R95015/16	15/16	23.81	0.9375	15.4
R95024.0	–	24.00	0.9449	15.4
R95061/64	61/64	24.21	0.9531	15.4
R95024.5	–	24.50	0.9646	15.4
R95031/32	31/32	24.61	0.9688	15.4
R95025.0	–	25.00	0.9844	15.8
R95063/64	63/64	25.00	0.9844	15.8
R9501	1"	25.40	1.0000	15.8
R95025.5	–	25.50	1.0039	15.8
R95025.6	–	25.60	1.0079	15.8
R95025.65	–	25.65	1.0098	15.8
R9501.1/64	1.1/64	25.80	1.0156	15.8
R95026.0	–	26.00	1.0236	16.4
R9501.1/32	1.1/32	26.19	1.0313	16.4

Product	DC	DC	DC	LH
	(inch)	(mm)	(inch)	(mm)
R95026.5	–	26.50	1.0433	16.4
R9501.3/64	1.3/64	26.59	1.0469	16.4
R9501.1/16	1.1/16	26.99	1.0625	17.1
R95027.0	–	27.00	1.0630	17.1
R9501.5/64	1.5/64	27.38	1.0781	17.1
R95027.5	–	27.50	1.0827	17.1
R9501.3/32	1.3/32	27.78	1.0938	17.1
R95028.0	–	28.00	1.1024	17.7
R9501.7/64	1.7/64	28.18	1.1094	17.7
R95028.5	–	28.50	1.1220	17.7
R9501.1/8	1.1/8	28.58	1.1250	17.7
R9501.9/64	1.9/64	28.97	1.1406	18.3
R95029.0	–	29.00	1.1417	18.3
R9501.5/32	1.5/32	29.37	1.1563	18.3
R95029.5	–	29.50	1.1614	18.3
R9501.11/64	1.11/64	29.77	1.1719	18.3
R95030.0	–	30.00	1.1811	19.0
R9501.3/16	1.3/16	30.16	1.1875	19.0
R95030.5	–	30.50	1.2008	19.0
R9501.7/32	1.7/32	30.96	1.2188	21.0
R95031.0	–	31.00	1.2205	21.0
R9501.1/4	1.1/4	31.75	1.2500	21.0
R95032.0	–	32.00	1.2598	21.0
R95032.5	–	32.50	1.2795	21.0
R9501.19/64	1.19/64	32.94	1.2969	21.0
R95033.0	–	33.00	1.2992	21.0
R95033.5	–	33.50	1.3189	21.0
R95034.0	–	34.00	1.3386	23.0
R9501.11/32	1.11/32	34.13	1.3438	23.0
R95034.5	–	34.50	1.3583	23.0
R9501.3/8	1.3/8	34.93	1.3750	23.0
R95035.0	–	35.00	1.3780	23.0
R95036.0	–	36.00	1.4173	23.0
R9501.27/64	1.27/64	36.12	1.4219	23.0
R95036.5	–	36.50	1.4370	23.0
R95037.0	–	37.00	1.4567	25.0
R9501.15/32	1.15/32	37.31	1.4688	25.0
R95037.5	–	37.50	1.4764	25.0
R95038.0	–	38.00	1.4961	25.0
R9501.1/2	1.1/2	38.10	1.5000	25.0
R95038.5	–	38.50	1.5157	25.0
R9501.17/32	1.17/32	38.89	1.5313	25.0
R95039.0	–	39.00	1.5354	25.0
R95039.5	–	39.50	1.5551	25.0
R9501.9/16	1.9/16	39.69	1.5625	27.0
R95040.0	–	40.00	1.5748	27.0
R95041.0	–	41.00	1.6142	27.0
R9501.5/8	1.5/8	41.28	1.6250	27.0
R95042.0	–	42.00	1.6535	27.0

R960

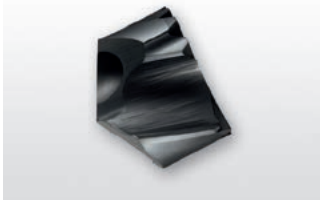

HYDRA-borrkrona för rostfritt stål, Ti-phon-belagd

Kostnadseffektiv precisionsborrkrona av solid HM för bormning i rostfritt stål. Självcenterande borrarpet med 140° spetsvinkel minskar skärkrafterna. Belagd med Ti-phon, som skyddar mot påkletning och förbättrar spånavgången samt ökar livslängden och eggstyrkan.

HYDRA

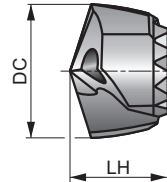

HM	DORMER	140°
Ti-phon	R	DC
DC h7		

H851	Apply starting values for speed and feed with a correction factor of 1.10
H853	Apply starting values for speed and feed with a correction factor of 1.00
H855	Apply starting values for speed and feed with a correction factor of 0.80
H858	Apply starting values for speed and feed with a correction factor of 0.60
H8512	Apply starting values for speed and feed with a correction factor of 0.50

Arbetsmaterialgrupper och startvärden för skärhastighet (m/min) och matningskod. Tabeller med matningar finns med början på sidan 274

P1.1	P1.2	P1.3	P2.1	M1.1	M1.2	M2.1	M2.2	M2.3	M3.1	M3.2	M3.3	M4.1	M4.2
■ 133 W	■ 148 W	■ 154 W	■ 114 W	■ 82 V	■ 70 V	■ 73 V	■ 60 V	▣ 50 T	■ 58 T	■ 50 T	■ 45 T	■ 40 T	▣ 34 T
K1.1	K1.2	K1.3	K2.1	K2.2	K2.3	K3.1	K3.2	K3.3	K4.1	K4.2	K4.3	K4.4	K4.5
■ 120 V	■ 89 V	■ 67 V	▣ 108 V	▣ 88 V	▣ 70 V	▣ 96 V	▣ 73 V	▣ 59 V	▣ 89 V	▣ 67 V	▣ 49 V	▣ 42 V	▣ 35 V
K5.1	K5.2	K5.3	S1.1	S1.2	S1.3	S2.1	S2.2	S3.1	S3.2	S4.1	S4.2		
▣ 100 V	▣ 76 V	▣ 58 V	▣ 45 T	▣ 35 T	▣ 30 S	▣ 40 S	▣ 35 S	▣ 30 S	▣ 25 S	▣ 23 S	▣ 20 S		

Product	DC	DC	DC	LH
	(inch)	(mm)	(inch)	(mm)
R96015/32	15/32	11.91	0.4688	9.1
R96012.0	–	12.00	0.4724	9.1
R96012.1	–	12.10	0.4764	9.1
R96012.2	–	12.20	0.4803	9.1
R96031/64	31/64	12.30	0.4844	9.1
R96012.5	–	12.50	0.4921	9.4
R96012.6	–	12.60	0.4961	9.4
R9601/2	1/2	12.70	0.5000	9.4
R96012.8	–	12.80	0.5039	9.4
R96012.9	–	12.90	0.5079	9.4
R96013.0	–	13.00	0.5118	9.7
R96033/64	33/64	13.10	0.5156	9.7
R96013.2	–	13.20	0.5197	9.7
R96017/32	17/32	13.49	0.5313	9.7
R96013.5	–	13.50	0.5315	10.3
R96013.6	–	13.60	0.5354	10.3
R96013.7	–	13.70	0.5394	10.3
R96013.8	–	13.80	0.5433	10.3
R96035/64	35/64	13.89	0.5469	10.3
R96014.0	–	14.00	0.5512	10.3
R96014.1	–	14.10	0.5551	10.3
R96014.2	–	14.20	0.5591	10.3
R9609/16	9/16	14.29	0.5625	10.3
R96014.5	–	14.50	0.5709	10.3
R96014.6	–	14.60	0.5748	11.0
R96037/64	37/64	14.68	0.5781	11.0
R96014.7	–	14.70	0.5787	11.0
R96014.8	–	14.80	0.5827	11.0

Product	DC	DC	DC	LH
	(inch)	(mm)	(inch)	(mm)
R96015.0	–	15.00	0.5906	11.0
R96019/32	19/32	15.08	0.5938	11.0
R96015.1	–	15.10	0.5945	11.0
R96015.2	–	15.20	0.5984	11.0
R96015.24	–	15.24	0.6000	11.0
R96039/64	39/64	15.48	0.6094	11.0
R96015.5	–	15.50	0.6102	11.0
R96015.6	–	15.60	0.6142	11.6
R96015.7	–	15.70	0.6181	11.6
R9605/8	5/8	15.88	0.6250	11.6
R96016.0	–	16.00	0.6299	11.6
R96016.08	–	16.08	0.6331	11.6
R96016.1	–	16.10	0.6339	11.6
R96016.2	–	16.20	0.6378	11.6
R96041/64	41/64	16.27	0.6406	11.6
R96016.3	–	16.30	0.6417	11.6
R96016.5	–	16.50	0.6496	11.6
R96016.6	–	16.60	0.6535	12.2
R96021/32	21/32	16.67	0.6563	12.2
R96016.7	–	16.70	0.6575	12.2
R96017.0	–	17.00	0.6693	12.2
R96043/64	43/64	17.07	0.6719	12.2
R96017.1	–	17.10	0.6732	12.2
R96017.2	–	17.20	0.6772	12.2
R96011/16	11/16	17.46	0.6875	12.2
R96017.5	–	17.50	0.6890	12.2
R96017.6	–	17.60	0.6929	12.9
R96017.7	–	17.70	0.6969	12.9



Product	DC	DC	DC	LH
	(inch)	(mm)	(inch)	(mm)
R96045/64	45/64	17.86	0.7031	12.9
R96018.0	–	18.00	0.7087	12.9
R96018.1	–	18.10	0.7126	12.9
R96018.2	–	18.20	0.7165	12.9
R96023/32	23/32	18.26	0.7188	12.9
R96018.5	–	18.50	0.7283	12.9
R96018.6	–	18.60	0.7323	13.5
R96047/64	47/64	18.65	0.7344	13.5
R96018.7	–	18.70	0.7362	13.5
R96018.9	–	18.90	0.7441	13.5
R96019.0	–	19.00	0.7480	13.5
R9603/4	3/4	19.05	0.7500	13.5
R96019.1	–	19.10	0.7520	13.5
R96019.2	–	19.20	0.7559	13.5
R96019.25	–	19.25	0.7579	13.5
R96019.3	–	19.30	0.7598	13.5
R96019.35	–	19.35	0.7618	13.5
R96049/64	49/64	19.45	0.7656	13.5
R96019.5	–	19.50	0.7677	13.5
R96019.6	–	19.60	0.7717	14.1
R96019.7	–	19.70	0.7756	14.1
R96025/32	25/32	19.84	0.7813	14.1
R96020.0	–	20.00	0.7874	14.1
R96051/64	51/64	20.24	0.7969	14.1
R96020.5	–	20.50	0.8071	14.1
R96013/16	13/16	20.64	0.8125	14.8
R96021.0	–	21.00	0.8268	14.8
R96053/64	53/64	21.03	0.8281	14.8
R96027/32	27/32	21.43	0.8438	14.8
R96021.5	–	21.50	0.8465	14.8
R96055/64	55/64	21.83	0.8594	15.0
R96022.0	–	22.00	0.8661	15.0
R9607/8	7/8	22.22	0.8750	15.0
R96022.5	–	22.50	0.8858	15.0
R96057/64	57/64	22.62	0.8906	15.0
R96022.7	–	22.70	0.8937	15.0

Product	DC	DC	DC	LH
	(inch)	(mm)	(inch)	(mm)
R96023.0	–	23.00	0.9055	15.1
R96029/32	29/32	23.02	0.9063	15.1
R96059/64	59/64	23.42	0.9219	15.1
R96023.5	–	23.50	0.9252	15.1
R96015/16	15/16	23.81	0.9375	15.4
R96024.0	–	24.00	0.9449	15.4
R96061/64	61/64	24.21	0.9531	15.4
R96024.5	–	24.50	0.9646	15.4
R96031/32	31/32	24.61	0.9688	15.4
R96025.0	–	25.00	0.9844	15.8
R96063/64	63/64	25.00	0.9844	15.8
R9601	1"	25.40	1.0000	15.8
R96025.5	–	25.50	1.0039	15.8
R96025.65	–	25.65	1.0098	15.8
R9601.1/64	1.1/64	25.80	1.0156	15.8
R96026.0	–	26.00	1.0236	16.4
R9601.1/32	1.1/32	26.19	1.0313	16.4
R96026.5	–	26.50	1.0433	16.4
R9601.3/64	1.3/64	26.59	1.0469	16.4
R9601.1/16	1.1/16	26.99	1.0625	17.1
R96027.0	–	27.00	1.0630	17.1
R9601.5/64	1.5/64	27.38	1.0781	17.1
R96027.5	–	27.50	1.0827	17.1
R9601.3/32	1.3/32	27.78	1.0938	17.1
R96028.0	–	28.00	1.1024	17.7
R9601.7/64	1.7/64	28.18	1.1094	17.7
R96028.5	–	28.50	1.1220	17.7
R9601.1/8	1.1/8	28.58	1.1250	17.7
R9601.9/64	1.9/64	28.97	1.1406	18.3
R96029.0	–	29.00	1.1417	18.3
R9601.5/32	1.5/32	29.37	1.1563	18.3
R96029.5	–	29.50	1.1614	18.3
R9601.11/64	1.11/64	29.77	1.1719	18.3
R96030.0	–	30.00	1.1811	19.0
R9601.3/16	1.3/16	30.16	1.1875	19.0
R96030.5	–	30.50	1.2008	19.0



H860

DORMER



Skrivar till HYDRA borkronor

Utbytesskrivar för att hålla HYDRA borkronor. OBS! Välj rätt skruv beroende på krona.

HYDRA

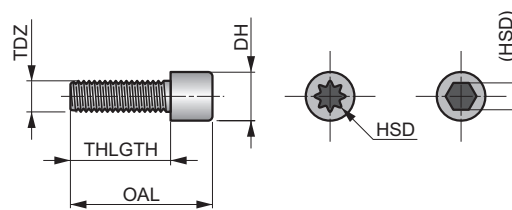

Product	Nr.	TDZ	OAL	THLGTH	DH	HSD
			(mm)	(mm)	(mm)	
H860N1	1	M2.2	7.5	5.70	3.5	8IP
H860N2	2	M2.5	9.0	7.00	4.1	10IP
H860N3	3	M3.0	10.5	8.00	4.9	15IP
H860N4	4	M3.5	11.5	8.80	5.5	15IP
H860N5	5	M4.0	12.5	9.50	6.0	20IP
H860N6	6	M4.5	14.3	10.80	6.8	25IP
H860N7	7	M5.0	20.0	15.00	8.5	4

H861

DORMER



Torxmejsel till HYDRA-borr





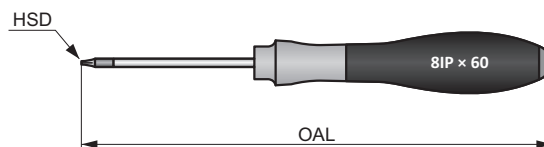





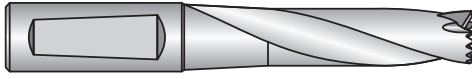











Torxmejsel för skruvar till HYDRA borkronor

HYDRA



Product	Nr.	HSD	OAL
			(mm)
H861N1	N1	8IP	164.0
H861N2	N2	10IP	191.0
H861N3	N3	15IP	191.0
H861N4	N4	20IP	218.0
H861N5	N5	25IP	218.0

HIGH PERFORMANCE REPLACEABLE HEAD DRILLS

SetUp									
	DC	H851 1.5×D	H853 3×D	H855 5×D	H858 8×D	H8512 12×D	R950	R960	H860
									
Range	12.00 – 30.50 15/32" – 1.3/16"	12.00 – 42.50 15/32" – 1.5/8"	12.00 – 42.50 15/32" – 1.5/8"	13.50 – 42.50 35/64" – 1.5/8"	13.50 – 25.65 35/64" – 1.1/64"	12.00 – 42.00 15/32" – 1.5/8"	12.00 – 30.50 15/32" – 1.3/16"	N1 – N7	N1 – N6
Pages	 218	 219	 221	 223	 224	 225	 227	 229	 229

DC	H851 1.5×D	H853 3×D	H855 5×D	H858 8×D	H8512 12×D	R950	R960	H860	H861
15/32"						R95015/32	R96015/32	H860N1	H861N1
12.0						R95012.0	R96012.0		
12.1	H85112.0	H85312.0	H85512.0	–	–	R95012.1	R96012.1		
12.2	H85131/64	H85331/64	H85531/64			R95012.2	R96012.2		
31/64"						R95031/64	R96031/64		
12.5						R95012.5	R96012.5		
12.6						R95012.6	R96012.6		
1/2"						R9501/2	R9601/2		
12.8	H85112.5	H85312.5	H85512.5	–	–	R95012.8	R96012.8		
12.9						R95012.9	R96012.9		
13.0						R95013.0	R96013.0		
33/64"						R95033/64	R96033/64		
13.2	H85113.0	H85313.0	H85513.0	–	–	R95013.2	R96013.2		
17/32"	H85117/32	H85317/32	H85517/32			R95017/32	R96017/32		
13.5						R95013.5	R96013.5		
13.6						R95013.6	R96013.6		
13.7						R95013.7	R96013.7		
13.8						R95013.8	R96013.8		
35/64"						R95035/64	R96035/64		
14.0	H85114.0	H85314.0	H85514.0	H85814.0	H851214.0	R95014.0	R96014.0		
14.1		H85339/16	H8559/16			R95014.1	R96014.1		
14.2						R95014.2	R96014.2		
9/16"						R9509/16	R9609/16		
14.5						R95014.5	R96014.5		
14.6						R95014.6	R96014.6		
37/64"						R95037/64	R96037/64		
14.7						R95014.7	R96014.7		
14.8						R95014.8	R96014.8		
15.0						R95015.0	R96015.0		
19/32"						R95019/32	R96019/32		
15.1	H85115.0	H85315.0	H85515.0	H85815.0	H851215.0	R95015.1	R96015.1		
15.2	H85139/64	H85339/64	H85539/64			R95015.2	R96015.2		
15.24						R95015.24	R96015.24		
39/64"						R95039/64	R96039/64		
15.5						R95015.5	R96015.5		

HIGH PERFORMANCE REPLACEABLE HEAD DRILLS

DC	H851 1.5xD	H853 3xD	H855 5xD	H858 8xD	H8512 12xD	R950	R960	H860	H861							
15.6	H85116.0 H85141/64	H85316.0 H85341/64	H85516.0 H85541/64	H85816.0	H851216.0	R95015.6	R96015.6	H860N2	H861N2							
15.7						R95015.7	R96015.7									
5/8"						R9505/8	R9605/8									
16.0						R95016.0	R96016.0									
16.08						R95016.08	R96016.08									
16.1						R95016.1	R96016.1									
16.2						R95016.2	R96016.2									
16.3						R95016.3	R96016.3									
41/64"						R95041/64	R96041/64									
16.5						R95016.5	R96016.5									
16.6	H85117.0 H85111/16	H85317.0 H85311/16	H85517.0 H85511/16	H85817.0	H851217.0	R95016.6	R96016.6	H860N2	H861N2							
21/32"						R95021/32	R96021/32									
16.7						R95016.7	R96016.7									
17.0						R95017.0	R96017.0									
43/64"						R95043/64	R96043/64									
17.1						R95017.1	R96017.1									
17.2						R95017.2	R96017.2									
11/16"						R95011/16	R96011/16									
17.5						R95017.5	R96017.5									
17.6						H85118.0 H85123/32	H85318.0 H85323/32			H85518.0 H85523/32	H85818.0	H851218.0	R95017.6	R96017.6	H860N3	H861N3
17.7	R95017.7	R96017.7														
45/64"	R95045/64	R96045/64														
18.0	R95018.0	R96018.0														
18.1	R95018.1	R96018.1														
18.2	R95018.2	R96018.2														
23/32"	R95023/32	R96023/32														
18.5	R95018.5	R96018.5														
18.6	H85119.0 H85149/64	H85319.0 H85349/64	H85519.0 H85549/64	H85819.0	H851219.0			R95018.6	R96018.6				H860N3	H861N3		
47/64"								R95047/64	R96047/64							
18.7						R95018.7	R96018.7									
18.9						R95018.9	R96018.9									
19.0						R95019.0	R96019.0									
3/4"						R9503/4	R9603/4									
19.1						R95019.1	R96019.1									
19.2						R95019.2	R96019.2									
19.25						R95019.25	R96019.25									
19.3						R95019.3	R96019.3									
19.35	R95019.35	R96019.35														
49/64"	R95049/64	R96049/64														
19.5	R95019.5	R96019.5														
19.6	H85120.0 H85151/64	H85320.0 H85351/64	H85520.0 H85551/64	H85820.0	H851220.0	R95019.6	R96019.6	H860N4	H861N3							
19.7						R95019.7	R96019.7									
25/32"						R95025/32	R96025/32									
20.0						R95020.0	R96020.0									
51/64"						R95051/64	R96051/64									
20.5						R95020.5	R96020.5									
13/16"						R95013/16	R96013/16									
21.0						R95021.0	R96021.0									
53/64"						R95053/64	R96053/64									
27/32"						R95027/32	R96027/32									
21.5	R95021.5	R96021.5														
55/64"	H85122.0 H85157/64	H85322.0 H85357/64	H85522.0 H85557/64	H85822.0	H851222.0	R95055/64	R96055/64	H860N4	H861N3							
22.0						R95022.0	R96022.0									
7/8"						R9507/8	R9607/8									
22.5						R95022.5	R96022.5									
57/64"						R95057/64	R96057/64									
22.7						R95022.7	R96022.7									
23.0	H85123.0 H85159/64	H85323.0 H85359/64	H85523.0 H85559/64	H85823.0	H851223.0	R95023.0	R96023.0	H860N4	H861N3							
29/32"						R95029/32	R96029/32									
59/64"						R95059/64	R96059/64									
23.5						R95023.5	R96023.5									

HIGH PERFORMANCE REPLACEABLE HEAD DRILLS

DC	H851 1.5xD	H853 3xD	H855 5xD	H858 8xD	H8512 12xD	R950	R960	H860	H861
15/16	H85124.0 H85131/32	H85324.0 H85331/32	H85524.0 H85531/32	H85824.0	H851224.0	R95015/16	R96015/16	H860N4	H861N3
24.0						R95024.0	R96024.0		
61/64						R95061/64	R96061/64		
24.5						R95024.5	R96024.5		
31/32"						R95031/32	R96031/32		
25.0	H85125.0 H8511.1/64	H85325.0 H8531.1/64	H85525.0 H8551.1/64	H85825.0	H851225.0	R95025.0	R96025.0	H860N5	H861N4
63/64"						R95063/64	R96063/64		
1"						R9501	R9601		
25.5						R95025.5	R96025.5		
25.6						R95025.6	–		
25.65						R95025.65	R96025.65		
1.1/64"						R9501.1/64	R9601.1/64		
26.0	H85126.0 H8511.3/64	H85326.0 H8531.3/64	H85526.0 H8551.3/64	H85826.0	–	R95026.0	R96026.0	H860N6	H861N5
1.1/32"						R9501.1/32	R9601.1/32		
26.5						R95026.5	R96026.5		
1.3/64						R9501.3/64	R9601.3/64		
1.1/16"	H85127.0 H8511.3/32	H85327.0 H8531.3/32	H85527.0 H8551.3/32	H85827.0	–	R9501.1/16	R9601.1/16	H860N7	H861N6
27.0						R95027.0	R96027.0		
1.5/64"						R9501.5/64	R9601.5/64		
27.5						R95027.5	R96027.5		
1.3/32"						R9501.3/32	R9601.3/32		
28.0	H85128.0	H85328.0 H8531.1/8	H85528.0 H8551.1/8	H85828.0	–	R95028.0	R96028.0	H860N8	H861N7
1.7/64"						R9501.7/64	R9601.7/64		
28.5						R95028.5	R96028.5		
1.1/8"						R9501.1/8	R9601.1/8		
1.9/64"	H85129.0	H85329.0 H8531.11/64	H85529.0 H8551.11/64	H85829.0	–	R9501.9/64	R9601.9/64	H860N9	H861N8
29.0						R95029.0	R96029.0		
1.5/32"						R9501.5/32	R9601.5/32		
29.5						R95029.5	R96029.5		
1.11/64"						R9501.11/64	R9601.11/64		
30.0	H85130.0 H8511.3/16	H85330.0 H8531.3/16	H85530.0 H8551.3/16	H85830.0	–	R95030.0	R96030.0	H860N10	H861N9
1.3/16"						R9501.3/16	R9601.3/16		
30.5	–	H85332.0	H85532.0	H85832.0	–	R95030.5	R96030.5	H860N11	H861N10
1.7/32"						R9501.7/32	–		
31.0						R95031.0	–		
1.1/4"						R9501.1/4	–		
32.0	–	H85333.5	H85533.5	H85833.5	–	R95032.0	–	H860N12	H861N11
32.5						R95032.5	–		
1.19/64"						R9501.19/64	–		
33.0						R95033.0	–		
33.5						R95033.5	–		
34.0	–	H85335.0	H85535.0	H85835.0	–	R95034.0	–	H860N13	H861N12
1.11/32"						R9501.11/32	–		
34.5						R95034.5	–		
1.3/8"						R9501.3/8	–		
35.0	–	H85336.5	H85536.5	H85836.5	–	R95035.0	–	H860N14	H861N13
36.0						R95036.0	–		
1.27/64"						R9501.27/64	–		
36.5						R95036.5	–		
37.0						R95037.0	–		
1.15/32"	–	H85338.0	H85538.0	H85838.0	–	R9501.15/32	–	H860N15	H861N14
37.5						R95037.5	–		
38.0						R95038.0	–		
1.1/2"						R9501.1/2	–		
38.5	–	H85339.5	H85539.5	H85839.5	–	R95038.5	–	H860N16	H861N15
1.17/32"						R9501.17/32	–		
39.0						R95039.0	–		
39.5						R95039.5	–		
1.9/16"						R9501.9/16	–		
40.0	–	H85341.0	H85541.0	H85841.0	–	R95040.0	–	H860N17	H861N16
41.0						R95041.0	–		

HIGH PERFORMANCE REPLACEABLE HEAD DRILLS

DC	H851 1.5×D	H853 3×D	H855 5×D	H858 8×D	H8512 12×D	R950	R960	H860	H861
1.5/8"	–	H85342.5	H85542.5	H85842.5	–	R9501.5/8	–	H860N7	–
42.0	–					R95042.0	–		

Accessories

H860	H861	Hydra Head DC range			Wrench Size / Bit
		Metric (min. – max.)	Fractional (min. – max.)	Decimal (min. – max.)	
H860N1	H861N1	12.0 mm – 15.5 mm	15/32" – 39/64"	0.4688" – 0.6102"	8IP
H860N2	H861N2	15.6 mm – 18.5 mm	5/8" – 23/32"	0.6142" – 0.7283"	10IP
H860N3	H861N3	18.6 mm – 21.5 mm	47/64" – 27/32"	0.7323" – 0.8465"	15IP
H860N4	H861N3	22.0 mm – 24.5 mm	55/64" – 31/32"	0.8594" – 0.9688"	15IP
H860N5	H861N4	25.0 mm – 27.5 mm	63/64" – 1-3/32"	0.9843" – 1.0938"	20IP
H860N6	H861N5	28.0 mm – 33.5 mm	1-7/64" – 1-19/64"	1.1024" – 1.3189"	25IP
H860N7	–	34.0 mm – 42.0 mm	1-11/32" – 1-5/8"	1.3386" – 1.6535"	4 mm Hex

Verktygsmaterial (BMC)	HSS	HSS	HSS	HSS							
Användbar längd (ULDR)	2×D	3×D	4×D	5×D							
Beläggning	Bright Ni	Bright Ni	Bright Ni	Bright Ni							
Skaft	ISO 9766	ISO 9766	ISO 9766	ISO 9766							
Skärriktning	R	R	R	R							
Kylning (CSP)											
Borrtolerans	± 0.05	± 0.05	± 0.05	± 0.05							
Håltolerans *	0/+0.2	0/+0.3	0/+0.4	0/+0.5							
Ytfinhet*	2–6 µm	2–6 µm	2–6 µm	2–6 µm							
Produktfamilj	802D	803D	804D	805D	XPET..AP	SCET..-UD	XPET..AP-SD	SCET..-SD	EP		
	15.0–40.0	15.0–58.0	17.0–58.0	19.0–31.0							
	236	238	241	243	246	245	246	245	247		
P	P1				■	■	■	■			
	P2				■	■	■	■			
	P3				■	■	■	■			
	P4				■	■	■	■			
M	M1						■	■			
	M2						■	■			
	M3						■	■			
	M4						■	■			
K	K1				▣	■	▣	▣			
	K2				▣	■	▣	▣			
	K3				▣	■	▣	▣			
	K4				▣	■	▣	▣			
	K5				▣	■	▣	▣			
N	N1										
	N2										
	N3										
	N4										
	N5										
S	S1						▣	▣			
	S2						▣	▣			
	S3						▣	▣			
	S4						▣	▣			
H	H1										
	H2										

* Toleransen hos det borrarade hålet beror i hög grad på maskinens kondition

802D



PRAMET







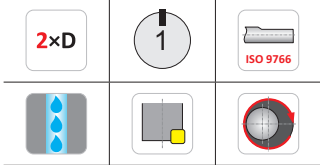
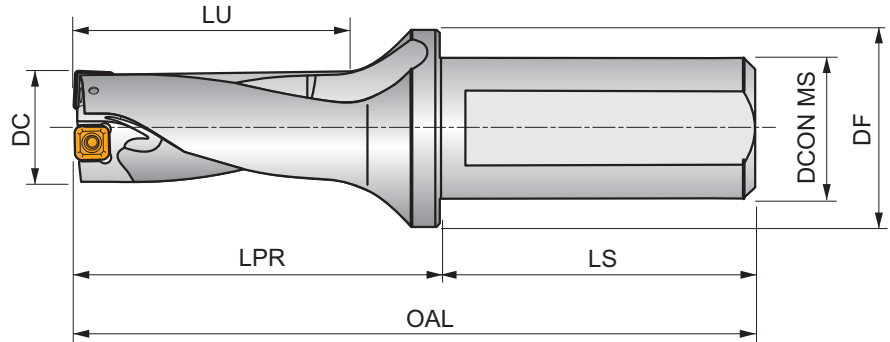



Korthålsborr typ 802D för borrhjup 2xD, invändiga kylkanaler

Korthålsborr för effektiv borrar av bottenhål och genomgående hål. Kan även användas vid korsande hål, paketborrning, borrar mot vinklade eller konkava ytor, mm. Finns i dimensioner 15 - 40 mm. Borrhjup upp till 2xD i de flesta material.



Product	DC	APMX	OAL	LPR	LS	LU	DCON MS	DF	\bar{D}	D^+				kg	
	(mm)	(mm)	(mm)	(mm)	(mm)	(mm)	(mm)	(mm)	(mm)	(mm)					
802D-15-30-S25	15	30.00	121	65	56	34.5	25	35	0.25	0.35	EP253253	GI300	GI313	0.32	HM001
802D-16-32-S25	16	32.00	123	67	56	37	25	35	0.15	0.45	EP253253	GI300	GI313	0.32	HM001
802D-17-34-S25	17	34.00	125	69	56	39.5	25	35	0.10	0.50	EP253253	GI300	GI313	0.31	HM001
802D-18-36-S25	18	36.00	127	71	56	42	25	35	0.35	0.25	EP253253	GI301	GI314	0.31	HM002
802D-19-38-S25	19	38.00	129	73	56	44.5	25	35	0.15	0.45	EP253253	GI301	GI314	0.32	HM002
802D-20-40-S25	20	40.00	131	75	56	47	25	35	0.10	0.45	EP253253	GI302	GI315	0.35	HM003
802D-21-42-S25	21	42.00	133	77	56	49.5	25	35	0.10	0.50	EP253253	GI302	GI315	0.34	HM003
802D-22-44-S25	22	44.00	135	79	56	52	25	35	0.45	0.50	EP253253	GI303	GI316	0.35	HM004
802D-23-46-S25	23	46.00	137	81	56	54.5	25	35	0.35	0.50	EP253253	GI304	GI317	0.36	HM005
802D-24-48-S25	24	48.00	139	83	56	57	25	35	0.15	0.50	EP253253	GI304	GI317	0.37	HM005
802D-25-50-S32	25	50.00	145	85	60	57	32	42	0.15	0.50	EP324058	GI304	GI317	0.57	HM005
802D-26-52-S32	26	52.00	147	87	60	59.5	32	42	0.10	0.50	EP324058	GI304	GI317	0.58	HM005
802D-27-54-S32	27	54.00	149	89	60	62	32	42	0.50	0.30	EP324058	GI305	GI318	0.59	HM006
802D-28-56-S32	28	56.00	151	91	60	64.5	32	42	0.30	0.50	EP324058	GI306	GI319	0.61	HM007
802D-29-58-S32	29	58.00	153	93	60	67	32	42	0.20	0.50	EP324058	GI306	GI319	0.62	HM007
802D-30-60-S32	30	60.00	155	95	60	69.5	32	42	0.15	0.50	EP324058	GI306	GI319	0.67	HM007
802D-32-64-S32	32	64.00	159	99	60	70	32	42	0.50	0.35	EP324058	GI307	GI320	0.68	HM008
802D-32-64-S40	32	64.00	167	99	68	70	40	50	0.50	0.35	-	GI307	GI320	1.03	HM008
802D-34-68-S32	34	68.00	163	103	60	75	32	42	0.25	0.50	EP324058	GI307	GI320	0.73	HM008
802D-34-68-S40	34	68.00	171	103	68	75	40	50	0.25	0.50	-	GI307	GI320	1.07	HM008
802D-36-72-S32	36	72.00	167	107	60	80	32	42	0.10	0.50	EP324058	GI308	GI321	0.76	HM009
802D-36-72-S40	36	72.00	173	105	68	77.5	40	50	0.10	0.50	-	GI308	GI321	1.11	HM009
802D-38-76-S32	38	76.00	171	111	60	85	32	42	0.50	0.50	EP324058	GI308	GI321	0.83	HM009
802D-38-76-S40	38	76.00	179	111	68	85	40	50	0.50	0.50	-	GI308	GI321	1.17	HM009
802D-40-80-S32	40	80.00	175	115	60	90	32	42	0.20	0.50	EP324058	GI309	GI322	0.94	HM009
802D-40-80-S40	40	80.00	183	115	68	90	40	50	0.20	0.50	-	GI309	GI322	1.25	HM009

		
GI300	XPET 0502AP	SCET 050204-UD
GI301	XPET 0602AP	SCET 050204-UD
GI302	XPET 0602AP	SCET 060204-UD
GI303	XPET 0703AP	SCET 060204-UD
GI304	XPET 0703AP	SCET 070308-UD
GI305	XPET 0903AP	SCET 070308-UD
GI306	XPET 0903AP	SCET 09T308-UD
GI307	XPET 11T3AP	SCET 09T308-UD
GI308	XPET 11T3AP	SCET 120408-UD
GI309	XPET 12T3AP	SCET 120408-UD
GI313	XPET 0502AP-SD	SCET 050204-SD
GI314	XPET 0602AP-SD	SCET 050204-SD
GI315	XPET 0602AP-SD	SCET 060204-SD
GI316	XPET 0703AP-SD	SCET 060204-SD
GI317	XPET 0703AP-SD	SCET 070308-SD
GI318	XPET 0903AP-SD	SCET 070308-SD
GI319	XPET 0903AP-SD	SCET 09T308-SD
GI320	XPET 11T3AP-SD	SCET 09T308-SD
GI321	XPET 11T3AP-SD	SCET 120408-SD
GI322	XPET 12T3AP-SD	SCET 120408-SD

					
HM001	US 2245-T07P	0.9	US 2245-T07P	0.9	FLAG T07P
HM002	US 2205-T07P	0.9	US 2245-T07P	0.9	FLAG T07P
HM003	US 2205-T07P	0.9	US 2205-T07P	0.9	FLAG T07P
HM004	US 2506-T07P	1.2	US 2506-T07P	1.2	FLAG T07P
HM005	US 2507-T08P	1.2	US 3007-T08P	2.0	FLAG T08P
HM006	US 3007-T09P	2.0	US 3007-T09P	2.0	FLAG T09P
HM007	US 3007-T09P	2.0	US 3009-T09P	2.0	FLAG T09P
HM008	US 3510-T15P	3.0	US 3508-T15P	3.0	FLAG T15P
HM009	US 3510-T15P	3.0	US 5012-T15P	5.0	FLAG T15P

803D



PRAMET







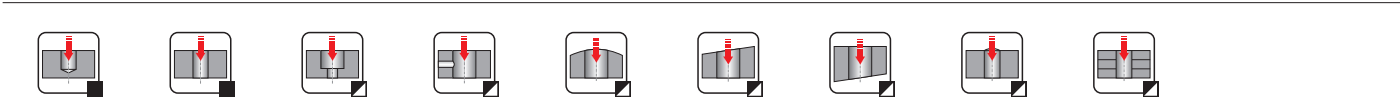
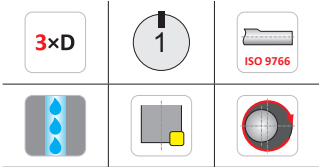
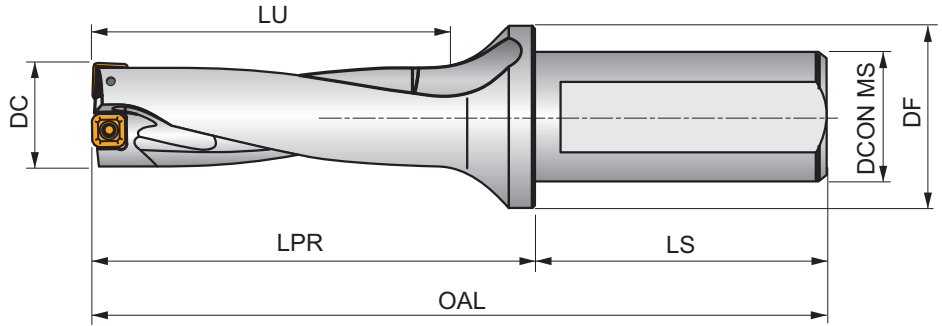



Korthålsborr typ 803D för borrhjup 3xD, invändiga kylkanaler



Korthålsborr för effektiv borrar av bottenhål och genomgående hål. Kan även användas vid korsande hål, paketborrning, borrar mot vinklade eller konkava ytor, mm. Finns i dimensioner 15 - 58 mm. Borrhjup upp till 3xD i de flesta material.









Product	DC	APMX	OAL	LPR	LS	LU	DCON MS	DF	\bar{D}	D^+					kg	
	(mm)	(mm)	(mm)	(mm)	(mm)	(mm)	(mm)	(mm)	(mm)	(mm)						
803D-15-45-S25	15	45.00	136	80	56	49.5	25	35	0.25	0.35	EP253253	GI300	GI313	0.33	HM001	
803D-15,5-46,5-S25	15.5	47.00	137.5	81.5	56	51.2	25	35	0.30	0.35	EP253253	GI300	GI313	0.31	HM001	
803D-16-48-S25	16	48.00	139	83	56	53	25	35	0.15	0.45	EP253253	GI300	GI313	0.32	HM001	
803D-16,5-49,5-S25	16.5	50.00	140.5	84.5	56	54.7	25	35	0.15	0.40	EP253253	GI300	GI313	0.32	HM001	
803D-17-51-S25	17	51.00	142	86	56	56.5	25	35	0.10	0.50	EP253253	GI300	GI313	0.35	HM001	
803D-17,5-52,5-S25	17.5	53.00	143.5	87.5	56	58.2	25	35	0.50	0.50	EP253253	GI301	GI314	0.32	HM002	
803D-18-54-S25	18	54.00	145	89	56	60	25	35	0.35	0.25	EP253253	GI301	GI314	0.33	HM002	
803D-18,5-55,5-S25	18.5	56.00	146.5	90.5	56	61.2	25	35	0.35	0.25	EP253253	GI301	GI314	0.34	HM002	
803D-19-57-S25	19	57.00	148	92	56	63.5	25	35	0.15	0.45	EP253253	GI301	GI314	0.34	HM002	
803D-19,5-58,5-S25	19.5	59.00	149.5	93.5	56	63.7	25	35	0.25	0.40	EP253253	GI302	GI315	0.34	HM003	
803D-20-60-S25	20	60.00	151	95	56	67	25	35	0.10	0.45	EP253253	GI302	GI315	0.33	HM003	
803D-20,5-61,5-S25	20.5	62.00	152.5	96.5	56	67.2	25	35	0.10	0.50	EP253253	GI302	GI315	0.36	HM003	
803D-21-63-S25	21	63.00	154	98	56	70.5	25	35	0.10	0.50	EP253253	GI302	GI315	0.36	HM003	
803D-21,5-64,5-S25	21.5	65.00	155.5	99.5	56	70.8	25	35	0.35	0.50	EP253253	GI303	GI316	0.37	HM004	
803D-22-66-S25	22	66.00	157	101	56	74	25	35	0.45	0.50	EP253253	GI303	GI316	0.40	HM004	
803D-22,5-67,5-S25	22.5	68.00	158.5	102.5	56	74.3	25	35	0.35	0.50	EP253253	GI304	GI317	0.42	HM005	
803D-23-69-S25	23	69.00	160	104	56	77.5	25	35	0.35	0.50	EP253253	GI304	GI317	0.40	HM005	
803D-23,5-70,5-S25	23.5	71.00	161.5	105.5	56	77.6	25	35	0.10	0.50	EP253253	GI304	GI317	0.40	HM005	
803D-24-72-S25	24	72.00	163	107	56	81	25	35	0.15	0.50	EP253253	GI304	GI317	0.41	HM005	
803D-24,5-73,5-S25	24.5	74.00	168.5	108.5	60	78.7	25	35	0.10	0.50	EP253253	GI304	GI317	0.45	HM005	
803D-25-75-S32	25	75.00	170	110	60	82	32	42	0.15	0.50	EP324058	GI304	GI317	0.62	HM005	
803D-25,5-76,5-S32	25.5	77.00	171.5	111.5	60	82.2	32	42	0.50	0.10	EP324058	GI304	GI317	0.63	HM005	
803D-26-78-S32	26	78.00	173	113	60	85.5	32	42	0.10	0.50	EP324058	GI304	GI317	0.66	HM005	
803D-26,5-79,5-S32	26.5	80.00	174.5	114.5	60	85.7	32	42	0.50	0.10	EP324058	GI305	GI318	0.67	HM006	
803D-27-81-S32	27	81.00	176	116	60	89	32	42	0.50	0.30	EP324058	GI305	GI318	0.65	HM006	
803D-28-84-S32	28	84.00	179	119	60	92.5	32	42	0.30	0.50	EP324058	GI306	GI319	0.68	HM007	
803D-29-87-S32	29	87.00	182	122	60	96	32	42	0.20	0.50	EP324058	GI306	GI319	0.70	HM007	

Product	DC	APMX	OAL	LPR	LS	LU	DCON MS	DF	\bar{D}	D^+					
	(mm)	(mm)	(mm)	(mm)	(mm)	(mm)	(mm)	(mm)	(mm)	(mm)					
803D-30-90-S32	30	90.00	185	125	60	99.5	32	42	0.15	0.50	EP324058	GI306	GI319	0.73	HM007
803D-31-93-S32	31	93.00	188	128	60	103	32	42	0.15	0.50	EP324058	GI306	GI319	0.76	HM007
803D-32-96-S32	32	96.00	191	131	60	102	32	42	0.50	0.30	EP324058	GI307	GI320	0.79	HM008
803D-32-96-S40	32	96.00	199	131	68	102	40	50	0.50	0.30	—	GI307	GI320	1.14	HM008
803D-33-99-S32	33	99.00	194	134	60	105.5	32	42	0.50	0.50	EP324058	GI307	GI320	0.83	HM008
803D-33-99-S40	33	99.00	202	134	68	105.5	40	50	0.50	0.50	—	GI307	GI320	1.18	HM008
803D-34-102-S32	34	102.00	197	137	60	109	32	42	0.25	0.50	EP324058	GI307	GI320	0.86	HM008
803D-34-102-S40	34	102.00	205	137	68	109	40	50	0.25	0.50	—	GI307	GI320	1.12	HM008
803D-35-105-S32	35	105.00	200	140	60	112.5	32	42	0.25	0.50	EP324058	GI308	GI321	0.90	HM009
803D-35-105-S40	35	105.00	208	140	68	112.5	40	50	0.25	0.50	—	GI308	GI321	1.24	HM009
803D-36-108-S32	36	108.00	203	143	60	116	32	42	0.10	0.50	EP324058	GI308	GI321	0.91	HM009
803D-36-108-S40	36	108.00	211	143	68	116	40	50	0.10	0.50	—	GI308	GI321	1.25	HM009
803D-37-111-S32	37	111.00	206	146	60	119.5	32	42	0.10	0.50	EP324058	GI308	GI321	0.95	HM009
803D-37-111-S40	37	111.00	214	146	68	119.5	40	50	0.10	0.50	—	GI308	GI321	1.29	HM009
803D-38-114-S32	38	114.00	199	139	60	124.5	32	42	0.50	0.50	EP324058	GI308	GI321	1.00	HM009
803D-38-114-S40	38	114.00	217	149	68	123	40	50	0.50	0.50	—	GI308	GI321	1.34	HM009
803D-39-117-S32	38	114.00	209	149	60	123	32	42	0.40	0.50	EP324058	GI309	GI322	1.06	HM009
803D-39-117-S40	39	117.00	220	152	68	126.5	40	50	0.40	0.50	—	GI309	GI322	1.40	HM009
803D-40-120-S32	40	120.00	215	155	60	130	32	42	0.20	0.50	EP324058	GI309	GI322	1.12	HM009
803D-40-120-S40	40	120.00	223	155	68	130	40	50	0.20	0.50	—	GI309	GI322	1.46	HM009
803D-41-123-S40	41	123.00	219	149	70	133	40	50	0.20	0.50	—	GI309	GI322	1.48	HM009
803D-42-126-S40	42	126.00	221.5	152	70	136	40	50	0.15	0.50	—	GI309	GI322	1.52	HM009
803D-43-129-S40	43	129.00	224	154	70	139	40	50	0.10	0.50	—	GI309	GI322	1.58	HM009
803D-44-132-S40	44	132.00	226.5	157	70	142	40	50	0.50	0.50	—	GI310	GI323	1.63	HM010
803D-45-135-S40	45	135.00	230.5	161	70	144	40	55	0.50	0.50	—	GI311	GI324	1.73	HM010
803D-46-138-S40	46	138.00	235	165	70	148	40	55	0.50	0.50	—	GI311	GI324	1.82	HM010
803D-47-141-S40	47	141.00	237.5	168	70	151	40	55	0.50	0.50	—	GI311	GI324	1.90	HM010
803D-48-144-S40	48	144.00	240	170	70	154	40	55	0.50	0.50	—	GI311	GI324	1.98	HM010
803D-49-147-S40	49	147.00	242.5	173	70	157	40	55	0.30	0.50	—	GI311	GI324	2.06	HM010
803D-50-150-S40	50	150.00	246.5	177	70	160	40	58	0.15	0.50	—	GI311	GI324	2.18	HM010
803D-51-153-S40	51	153.00	249	179	70	163	40	58	0.15	0.50	—	GI311	GI324	2.24	HM010
803D-52-156-S40	52	156.00	251.5	182	70	166	40	58	0.50	0.50	—	GI312	GI325	2.20	HM010
803D-53-159-S40	53	159.00	254	184	70	169	40	58	0.50	0.50	—	GI312	GI325	2.29	HM010
803D-54-162-S40	54	162.00	257.5	188	70	173	40	58	0.50	0.50	—	GI312	GI325	2.39	HM010
803D-55-165-S40	55	165.00	260	190	70	176	40	58	0.50	0.50	—	GI312	GI325	2.46	HM010
803D-56-168-S40	56	168.00	264	194	70	179	40	58	0.50	0.50	—	GI312	GI325	2.59	HM010
803D-57-171-S40	57	171.00	266.5	197	70	182	40	58	0.35	0.50	—	GI312	GI325	2.70	HM010
803D-58-174-S40	58	174.00	270	200	70	186	40	58	0.15	0.50	—	GI312	GI325	2.83	HM010

		
GI300	XPET 0502AP	SCET 050204-UD
GI301	XPET 0602AP	SCET 050204-UD
GI302	XPET 0602AP	SCET 060204-UD
GI303	XPET 0703AP	SCET 060204-UD
GI304	XPET 0703AP	SCET 070308-UD
GI305	XPET 0903AP	SCET 070308-UD
GI306	XPET 0903AP	SCET 09T308-UD
GI307	XPET 11T3AP	SCET 09T308-UD
GI308	XPET 11T3AP	SCET 120408-UD
GI309	XPET 12T3AP	SCET 120408-UD
GI310	XPET 1504AP	SCET 120408-UD
GI311	XPET 1504AP	SCET 150512-UD
GI312	XPET 1904AP	SCET 150512-UD
GI313	XPET 0502AP-SD	SCET 050204-SD
GI314	XPET 0602AP-SD	SCET 050204-SD
GI315	XPET 0602AP-SD	SCET 060204-SD
GI316	XPET 0703AP-SD	SCET 060204-SD
GI317	XPET 0703AP-SD	SCET 070308-SD
GI318	XPET 0903AP-SD	SCET 070308-SD
GI319	XPET 0903AP-SD	SCET 09T308-SD

		
GI320	XPET 11T3AP-SD	SCET 09T308-SD
GI321	XPET 11T3AP-SD	SCET 120408-SD
GI322	XPET 12T3AP-SD	SCET 120408-SD
GI323	XPET 1504AP-SD	SCET 120408-SD
GI324	XPET 1504AP-SD	SCET 150512-SD
GI325	XPET 1904AP-SD	SCET 150512-SD

		 Nm		 Nm	
HM001	US 2245-T07P	0.9	US 2245-T07P	0.9	FLAG T07P
HM002	US 2205-T07P	0.9	US 2245-T07P	0.9	FLAG T07P
HM003	US 2205-T07P	0.9	US 2205-T07P	0.9	FLAG T07P
HM004	US 2506-T07P	1.2	US 2506-T07P	1.2	FLAG T07P
HM005	US 2507-T08P	1.2	US 3007-T08P	2.0	FLAG T08P
HM006	US 3007-T09P	2.0	US 3007-T09P	2.0	FLAG T09P
HM007	US 3007-T09P	2.0	US 3009-T09P	2.0	FLAG T09P
HM008	US 3510-T15P	3.0	US 3508-T15P	3.0	FLAG T15P
HM009	US 3510-T15P	3.0	US 5012-T15P	5.0	FLAG T15P
HM010	US 4011-T15P	3.5	US 5012-T15P	5.0	FLAG T15P

804D



PRAMET







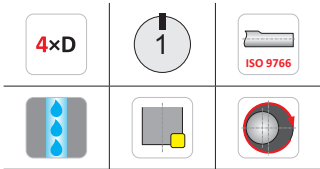
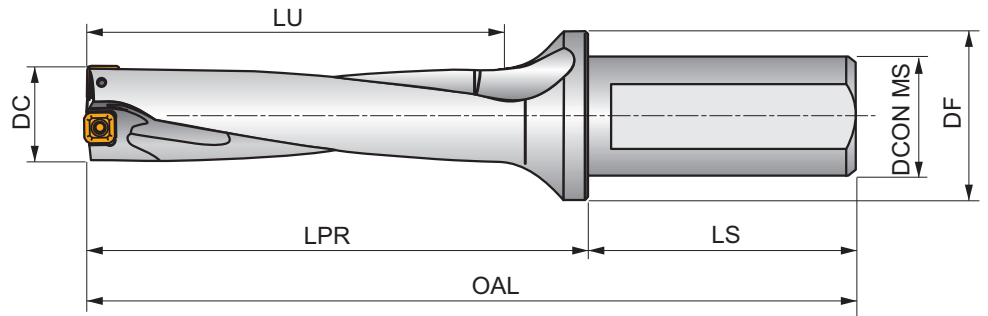



Korthålsborr typ 804D för borrhjup 4xD, invändiga kylkanaler







Korthålsborr för effektiv borrar av bottenhål och genomgående hål. Kan även användas vid korsande hål, paketborrning, borrar mot vinklade eller konkava ytor, mm. Finns i dimensioner 17 - 58 mm. Borrhjup upp till 4xD i de flesta material.



Product	DC	APMX	OAL	LPR	LS	LU	DCON MS	DF	\bar{D}	\bar{D}^+				kg	
	(mm)	(mm)	(mm)	(mm)	(mm)	(mm)	(mm)	(mm)	(mm)	(mm)					
804D-17-68-S25	17	68.00	149	93	56	73	25	35	0.10	0.50	–	GI300	GI313	0.34	HM001
804D-18-72-S25	18	72.00	153	97	56	77	25	35	0.35	0.25	–	GI301	GI314	0.35	HM002
804D-19-76-S25	19	76.00	157	101	56	81.5	25	35	0.15	0.45	–	GI301	GI314	0.36	HM002
804D-20-80-S25	20	80.00	161	105	56	85	25	35	0.10	0.45	–	GI302	GI315	0.37	HM003
804D-21-84-S25	21	84.00	165	109	56	89.5	25	35	0.10	0.50	–	GI302	GI315	0.43	HM003
804D-22-88-S25	22	88.00	169	113	56	94	25	35	0.45	0.50	–	GI303	GI316	0.45	HM004
804D-23-92-S25	23	92.00	173	117	56	98.5	25	35	0.35	0.50	–	GI304	GI317	0.44	HM005
804D-24-96-S25	24	96.00	177	121	56	103	25	35	0.15	0.50	–	GI304	GI317	0.45	HM005
804D-25-100-S32	25	100.00	185	125	60	105	32	42	0.15	0.50	–	GI304	GI317	0.67	HM005
804D-26-104-S32	26	104.00	189	129	60	109.5	32	42	0.10	0.50	–	GI304	GI317	0.70	HM005
804D-27-108-S32	27	108.00	193	133	60	114	32	42	0.50	0.30	–	GI305	GI318	0.71	HM006
804D-28-112-S32	28	112.00	197	137	60	118.5	32	42	0.30	0.50	–	GI306	GI319	0.75	HM007
804D-29-116-S32	29	116.00	201	141	60	123	32	42	0.20	0.50	–	GI306	GI319	0.78	HM007
804D-30-120-S32	30	120.00	205	145	60	127.5	32	42	0.15	0.50	–	GI306	GI319	0.82	HM007
804D-31-124-S32	31	124.00	209	149	60	132	32	42	0.15	0.50	–	GI306	GI319	0.85	HM007
804D-32-128-S32	32	128.00	213	153	60	136.5	32	42	0.50	0.30	–	GI307	GI320	0.90	HM008
804D-33-132-S32	33	132.00	217	157	60	141	32	42	0.50	0.50	–	GI307	GI320	0.95	HM008
804D-34-136-S32	34	136.00	221	161	60	145.5	32	42	0.25	0.50	–	GI307	GI320	0.99	HM008
804D-35-140-S32	35	140.00	225	165	60	149	32	42	0.25	0.50	–	GI308	GI321	1.04	HM009
804D-36-144-S32	36	144.00	229	169	60	153.5	32	42	0.10	0.50	–	GI308	GI321	1.05	HM009
804D-37-148-S32	37	148.00	233	173	60	158	32	42	0.10	0.50	–	GI308	GI321	1.11	HM009
804D-38-152-S32	38	152.00	237	177	60	162.5	32	42	0.50	0.50	–	GI308	GI321	1.18	HM009
804D-39-156-S32	39	156.00	241	181	60	167	32	42	0.40	0.50	–	GI309	GI322	1.25	HM009
804D-40-160-S32	40	160.00	245	185	60	171.5	32	42	0.20	0.50	–	GI309	GI322	1.33	HM009
804D-41-164-S40	41	164.00	259	189	70	172	40	50	0.20	0.50	–	GI309	GI322	1.68	HM009
804D-42-168-S40	42	168.00	263	193	70	176.5	40	50	0.15	0.50	–	GI309	GI322	1.76	HM009
804D-43-172-S40	43	172.00	267	197	70	181	40	50	0.10	0.50	–	GI309	GI322	1.83	HM009

Product	DC	APMX	OAL	LPR	LS	LU	DCON MS	DF	\bar{D}	D^+					
	(mm)	(mm)	(mm)	(mm)	(mm)	(mm)	(mm)	(mm)	(mm)	(mm)				kg	
804D-44-176-S40	44	176.00	271	201	70	185.5	40	50	0.50	0.50	–	GI310	GI323	1.91	HM010
804D-45-180-S40	45	180.00	275	205	70	187.5	40	55	0.50	0.50	–	GI311	GI324	2.02	HM010
804D-46-184-S40	46	184.00	279	209	70	192	40	55	0.50	0.50	–	GI311	GI324	2.12	HM010
804D-47-188-S40	47	188.00	283	213	70	196.5	40	55	0.50	0.50	–	GI311	GI324	2.22	HM010
804D-48-192-S40	48	192.00	287	217	70	201	40	55	0.50	0.50	–	GI311	GI324	2.33	HM010
804D-49-196-S40	49	196.00	291	221	70	205.5	40	55	0.30	0.50	–	GI311	GI324	2.45	HM010
804D-50-200-S40	50	200.00	295	225	70	208.5	40	58	0.15	0.50	–	GI311	GI324	2.58	HM010
804D-51-204-S40	51	204.00	299	229	70	213	40	58	0.15	0.50	–	GI311	GI324	2.68	HM010
804D-52-208-S40	52	208.00	303	233	70	217.5	40	58	0.50	0.50	–	GI312	GI325	2.64	HM010
804D-53-212-S40	53	212.00	307	237	70	222	40	58	0.50	0.50	–	GI312	GI325	2.76	HM010
804D-54-216-S40	54	216.00	311	241	70	226.5	40	58	0.50	0.50	–	GI312	GI325	2.90	HM010
804D-55-220-S40	55	220.00	315	245	70	231	40	58	0.50	0.50	–	GI312	GI325	3.00	HM010
804D-56-224-S40	56	224.00	319	249	70	235.5	40	58	0.50	0.50	–	GI312	GI325	3.15	HM010
804D-57-228-S40	57	228.00	323	253	70	240	40	58	0.35	0.50	–	GI312	GI325	3.30	HM010
804D-58-232-S40	58	232.00	327	257	70	244.5	40	58	0.15	0.50	–	GI312	GI325	3.46	HM010

		
GI300	XPET 0502AP	SCET 050204-UD
GI301	XPET 0602AP	SCET 050204-UD
GI302	XPET 0602AP	SCET 060204-UD
GI303	XPET 0703AP	SCET 060204-UD
GI304	XPET 0703AP	SCET 070308-UD
GI305	XPET 0903AP	SCET 070308-UD
GI306	XPET 0903AP	SCET 09T308-UD
GI307	XPET 11T3AP	SCET 09T308-UD
GI308	XPET 11T3AP	SCET 120408-UD
GI309	XPET 12T3AP	SCET 120408-UD
GI310	XPET 1504AP	SCET 120408-UD
GI311	XPET 1504AP	SCET 150512-UD
GI312	XPET 1904AP	SCET 150512-UD
GI313	XPET 0502AP-SD	SCET 050204-SD
GI314	XPET 0602AP-SD	SCET 050204-SD
GI315	XPET 0602AP-SD	SCET 060204-SD
GI316	XPET 0703AP-SD	SCET 060204-SD
GI317	XPET 0703AP-SD	SCET 070308-SD
GI318	XPET 0903AP-SD	SCET 070308-SD
GI319	XPET 0903AP-SD	SCET 09T308-SD
GI320	XPET 11T3AP-SD	SCET 09T308-SD
GI321	XPET 11T3AP-SD	SCET 120408-SD
GI322	XPET 12T3AP-SD	SCET 120408-SD
GI323	XPET 1504AP-SD	SCET 120408-SD
GI324	XPET 1504AP-SD	SCET 150512-SD
GI325	XPET 1904AP-SD	SCET 150512-SD

					
HM001	US 2245-T07P	0.9	US 2245-T07P	0.9	FLAG T07P
HM002	US 2205-T07P	0.9	US 2245-T07P	0.9	FLAG T07P
HM003	US 2205-T07P	0.9	US 2205-T07P	0.9	FLAG T07P
HM004	US 2506-T07P	1.2	US 2506-T07P	1.2	FLAG T07P
HM005	US 2507-T08P	1.2	US 3007-T08P	2.0	FLAG T08P
HM006	US 3007-T09P	2.0	US 3007-T09P	2.0	FLAG T09P
HM007	US 3007-T09P	2.0	US 3009-T09P	2.0	FLAG T09P
HM008	US 3510-T15P	3.0	US 3508-T15P	3.0	FLAG T15P
HM009	US 3510-T15P	3.0	US 5012-T15P	5.0	FLAG T15P
HM010	US 4011-T15P	3.5	US 5012-T15P	5.0	FLAG T15P

805D



PRAMET







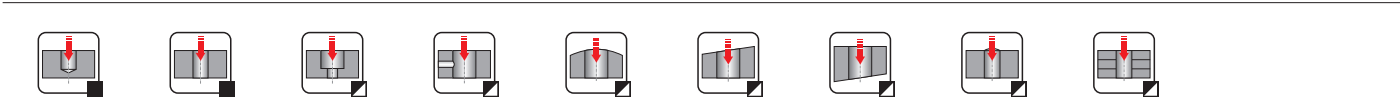
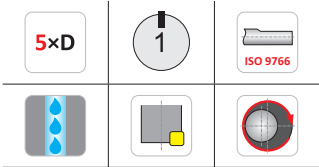
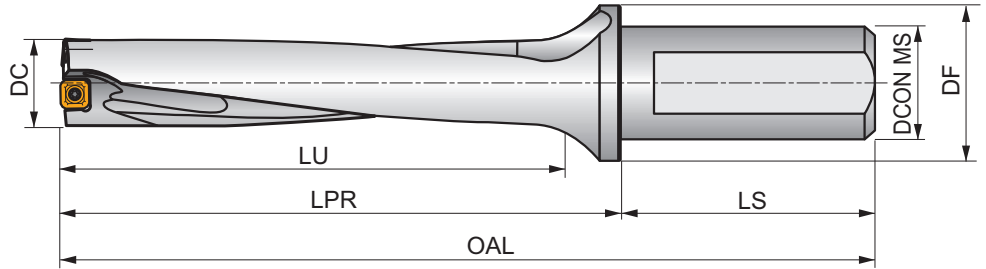

Korthålsborr typ 805D för borrhjup 5xD, invändiga kylkanaler

Korthålsborr för effektiv borrar av bottenhål och genomgående hål. Kan även användas vid korsande hål, paketborrning, borrar mot vinklade eller konkava ytor, mm. Finns i dimensioner 19 - 31 mm. Borrhjup upp till 5xD i de flesta material.



Product	DC	APMX	OAL	LPR	LS	LU	DCON MS	DF	\bar{D}	\bar{D}^+				kg	
	(mm)	(mm)	(mm)	(mm)	(mm)	(mm)	(mm)	(mm)	(mm)	(mm)					
805D-19-95-S25	19	95.00	176	120	56	100.5	25	35	0.15	0.45	–	GI301	GI314	0.38	HM002
805D-20-100-S25	20	100.00	181	125	56	105	25	35	0.10	0.45	–	GI302	GI315	0.40	HM003
805D-21-105-S25	21	105.00	186	130	56	110.5	25	35	0.10	0.50	–	GI302	GI315	0.42	HM003
805D-22-110-S25	22	110.00	191	135	56	116	25	35	0.45	0.50	–	GI303	GI316	0.45	HM004
805D-23-115-S25	23	115.00	196	140	56	121.5	25	35	0.35	0.50	–	GI304	GI317	0.48	HM005
805D-24-120-S25	24	120.00	201	145	56	127	25	35	0.15	0.50	–	GI304	GI317	0.49	HM005
805D-25-125-S32	25	125.00	210	150	60	130	32	42	0.15	0.50	–	GI304	GI317	0.72	HM005
805D-26-130-S32	26	130.00	215	155	60	135.5	32	42	0.10	0.50	–	GI304	GI317	0.82	HM005
805D-27-135-S32	27	135.00	220	160	60	141	32	42	0.50	0.30	–	GI305	GI318	0.78	HM006
805D-28-140-S32	28	140.00	225	165	60	146.5	32	42	0.30	0.50	–	GI306	GI319	0.82	HM007
805D-29-145-S32	29	145.00	230	170	60	152	32	42	0.20	0.50	–	GI306	GI319	0.86	HM007
805D-30-150-S32	30	150.00	235	175	60	157.5	32	42	0.15	0.50	–	GI306	GI319	0.90	HM007
805D-31-155-S32	31	155.00	240	180	60	163	32	42	0.15	0.50	–	GI306	GI319	0.95	HM007

GI301	XPET 0602AP	SCET 050204-UD
GI302	XPET 0602AP	SCET 060204-UD
GI303	XPET 0703AP	SCET 060204-UD
GI304	XPET 0703AP	SCET 070308-UD
GI305	XPET 0903AP	SCET 070308-UD
GI306	XPET 0903AP	SCET 09T308-UD
GI314	XPET 0602AP-SD	SCET 050204-SD
GI315	XPET 0602AP-SD	SCET 060204-SD
GI316	XPET 0703AP-SD	SCET 060204-SD
GI317	XPET 0703AP-SD	SCET 070308-SD
GI318	XPET 0903AP-SD	SCET 070308-SD
GI319	XPET 0903AP-SD	SCET 09T308-SD

		 Nm		 Nm	
HM002	US 2205-T07P	0.9	US 2245-T07P	0.9	FLAG T07P
HM003	US 2205-T07P	0.9	US 2205-T07P	0.9	FLAG T07P
HM004	US 2506-T07P	1.2	US 2506-T07P	1.2	FLAG T07P
HM005	US 2507-T08P	1.2	US 3007-T08P	2.0	FLAG T08P
HM006	US 3007-T09P	2.0	US 3007-T09P	2.0	FLAG T09P
HM007	US 3007-T09P	2.0	US 3009-T09P	2.0	FLAG T09P

SCET



	IC (mm)	D1 (mm)	L (mm)	S (mm)
0502	5.556	2.40	5.56	2.38
0602	6.350	2.90	6.35	2.38
0703	7.937	3.50	7.94	3.18
09T3	9.525	4.50	9.53	3.97
1204	12.700	5.60	12.70	4.76
1505	15.875	5.60	15.88	5.56

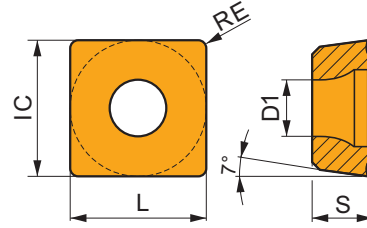

Lämplighet och startvärden för skärhastighet (vc), matning (f) och skärdjup (ap). Vi refererar till vår Dormer Pramet Calculator-app för vidare beräkningar.

Product	Interrupted/ Continuous cut	RE (mm)	P			M			K			N			S			H		
			vc (m/min)	f (mm/rev)	ap (mm)	vc (m/min)	f (mm/rev)	ap (mm)	vc (m/min)	f (mm/rev)	ap (mm)	vc (m/min)	f (mm/rev)	ap (mm)	vc (m/min)	f (mm/rev)	ap (mm)	vc (m/min)	f (mm/rev)	ap (mm)



SCET 050204-UD 0.12
 SCET 060204-UD 0.15
 SCET 070308-UD 0.15
 SCET 09T308-UD 0.15
 SCET 120408-UD 0.20
 SCET 150512-UD 0.20



UD-geometri med universell design för periferiskär

SCET 050204-UD:D8330	●	0.4	165	0.08	—	—	—	—	155	0.08	—	—	—	—	—	—	—	—	—
SCET 050204-UD:D9335	●	0.4	240	0.08	—	—	—	—	225	0.08	—	—	—	—	—	—	—	—	—
SCET 060204-UD:D8330	●	0.4	165	0.11	—	—	—	—	155	0.11	—	—	—	—	—	—	—	—	—
SCET 060204-UD:D9335	●	0.4	240	0.11	—	—	—	—	225	0.11	—	—	—	—	—	—	—	—	—
SCET 070308-UD:D8330	●	0.8	165	0.13	—	—	—	—	155	0.13	—	—	—	—	—	—	—	—	—
SCET 070308-UD:D9335	●	0.8	240	0.13	—	—	—	—	225	0.13	—	—	—	—	—	—	—	—	—
SCET 09T308-UD:D8330	●	0.8	165	0.14	—	—	—	—	155	0.14	—	—	—	—	—	—	—	—	—
SCET 09T308-UD:D9335	●	0.8	240	0.14	—	—	—	—	225	0.14	—	—	—	—	—	—	—	—	—
SCET 120408-UD:D8330	●	0.8	165	0.16	—	—	—	—	155	0.16	—	—	—	—	—	—	—	—	—
SCET 120408-UD:D9335	●	0.8	240	0.16	—	—	—	—	225	0.16	—	—	—	—	—	—	—	—	—
SCET 150512-UD:D8330	●	1.2	165	0.18	—	—	—	—	155	0.18	—	—	—	—	—	—	—	—	—
SCET 150512-UD:D9335	●	1.2	240	0.18	—	—	—	—	225	0.18	—	—	—	—	—	—	—	—	—

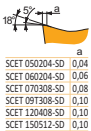

SCET 050204-SD 0.04
 SCET 060204-SD 0.06
 SCET 070308-SD 0.08
 SCET 09T308-SD 0.10
 SCET 120408-SD 0.10
 SCET 150512-SD 0.10



SD-geometri med positiv design för periferiskär

SCET 050204-SD:D8330	●	0.4	165	0.08	—	95	0.07	—	155	0.08	—	—	—	—	40	0.06	—	—	—
SCET 050204-SD:D9335	●	0.4	240	0.08	—	140	0.07	—	225	0.08	—	—	—	—	60	0.06	—	—	—
SCET 060204-SD:D8330	●	0.4	165	0.11	—	95	0.09	—	155	0.11	—	—	—	—	40	0.07	—	—	—
SCET 060204-SD:D9335	●	0.4	240	0.11	—	140	0.09	—	225	0.11	—	—	—	—	60	0.07	—	—	—
SCET 070308-SD:D8330	●	0.8	165	0.13	—	95	0.11	—	155	0.13	—	—	—	—	40	0.09	—	—	—
SCET 070308-SD:D9335	●	0.8	240	0.13	—	140	0.11	—	225	0.13	—	—	—	—	60	0.09	—	—	—
SCET 09T308-SD:D8330	●	0.8	165	0.14	—	95	0.13	—	155	0.14	—	—	—	—	40	0.10	—	—	—
SCET 09T308-SD:D9335	●	0.8	240	0.14	—	140	0.13	—	225	0.14	—	—	—	—	60	0.10	—	—	—
SCET 120408-SD:D8330	●	0.8	165	0.16	—	95	0.14	—	155	0.16	—	—	—	—	40	0.11	—	—	—
SCET 120408-SD:D9335	●	0.8	240	0.16	—	140	0.14	—	225	0.16	—	—	—	—	60	0.11	—	—	—
SCET 150512-SD:D8330	●	1.2	165	0.18	—	95	0.16	—	155	0.18	—	—	—	—	40	0.12	—	—	—
SCET 150512-SD:D9335	●	1.2	240	0.18	—	140	0.16	—	225	0.18	—	—	—	—	60	0.12	—	—	—

XPET



	IC (mm)	D1 (mm)	L (mm)	S (mm)
0502	5.556	2.40	5.56	2.38
0602	6.350	2.60	6.35	2.38
0703	7.937	2.90	7.94	3.18
0903	9.525	3.50	9.53	3.18
11T3	11.509	3.90	11.50	3.97
12T3	12.700	3.90	12.70	3.97
1504	15.875	4.50	15.88	4.76
1904	19.050	4.50	19.05	4.76

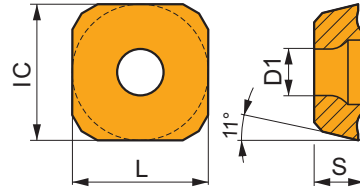

Lämplighet och startvärden för skärhastighet (vc), matning (f) och skärdjup (ap). Vi refererar till vår Dormer Pramet Calculator-app för vidare beräkningar.

Product	Incrumfeed/ Continuous cut (mm)	RE (mm)	P			M			K			N			S			H		
			vc (m/min)	f (mm/rev)	ap (mm)	vc (m/min)	f (mm/rev)	ap (mm)	vc (m/min)	f (mm/rev)	ap (mm)	vc (m/min)	f (mm/rev)	ap (mm)	vc (m/min)	f (mm/rev)	ap (mm)	vc (m/min)	f (mm/rev)	ap (mm)



XPET 0502AP	0,10
XPET 0602AP	0,10
XPET 0703AP	0,15
XPET 0903AP	0,25
XPET 11T3AP	0,25
XPET 12T3AP	0,25
XPET 1504AP	0,25
XPET 1904AP	0,25



Geometri med universell design för centrumskår

XPET 0502AP:D8345	☹	—	■	165	0.08	—	■	—	—	—	■	155	0.08	—	■	—	—	—	■	—	—	—
XPET 0602AP:D8345	☹	—	■	165	0.11	—	■	—	—	—	■	155	0.11	—	■	—	—	—	■	—	—	—
XPET 0703AP:D8345	☹	—	■	165	0.13	—	■	—	—	—	■	155	0.13	—	■	—	—	—	■	—	—	—
XPET 0903AP:D8345	☹	—	■	165	0.14	—	■	—	—	—	■	155	0.14	—	■	—	—	—	■	—	—	—
XPET 11T3AP:D8345	☹	—	■	165	0.16	—	■	—	—	—	■	155	0.16	—	■	—	—	—	■	—	—	—
XPET 12T3AP:D8345	☹	—	■	165	0.16	—	■	—	—	—	■	155	0.16	—	■	—	—	—	■	—	—	—
XPET 1504AP:D8345	☹	—	■	165	0.18	—	■	—	—	—	■	155	0.18	—	■	—	—	—	■	—	—	—
XPET 1904AP:D8345	☹	—	■	165	0.18	—	■	—	—	—	■	155	0.18	—	■	—	—	—	■	—	—	—

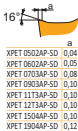

XPET 0502AP-SD	0,04
XPET 0602AP-SD	0,05
XPET 0703AP-SD	0,08
XPET 0903AP-SD	0,10
XPET 11T3AP-SD	0,10
XPET 12T3AP-SD	0,10
XPET 1504AP-SD	0,10
XPET 1904AP-SD	0,12



SD-geometri med positiv design för centrumskår

XPET 0502AP-SD:D8345	☹	—	■	165	0.08	—	■	95	0.07	—	■	155	0.08	—	■	40	0.06	—	■	—	—	—
XPET 0602AP-SD:D8345	☹	—	■	165	0.11	—	■	95	0.09	—	■	155	0.11	—	■	40	0.07	—	■	—	—	—
XPET 0703AP-SD:D8345	☹	—	■	165	0.13	—	■	95	0.11	—	■	155	0.13	—	■	40	0.09	—	■	—	—	—
XPET 0903AP-SD:D8345	☹	—	■	165	0.14	—	■	95	0.13	—	■	155	0.14	—	■	40	0.10	—	■	—	—	—
XPET 11T3AP-SD:D8345	☹	—	■	165	0.16	—	■	95	0.14	—	■	155	0.16	—	■	40	0.11	—	■	—	—	—
XPET 12T3AP-SD:D8345	☹	—	■	165	0.16	—	■	95	0.14	—	■	155	0.16	—	■	40	0.11	—	■	—	—	—
XPET 1504AP-SD:D8345	☹	—	■	165	0.18	—	■	95	0.16	—	■	155	0.18	—	■	40	0.12	—	■	—	—	—
XPET 1904AP-SD:D8345	☹	—	■	165	0.18	—	■	95	0.16	—	■	155	0.18	—	■	40	0.12	—	■	—	—	—



EP

PRAMET



Justerhylsa för korthålsborr

Kan användas tillsammans med korthålsborr för att justera diametern. Kan användas i 32mm, 40 mm eller 50 mm Weldonhållare. Inställning av borrhålets diameter sker genom att vrida hylsan i förhållande till borret.

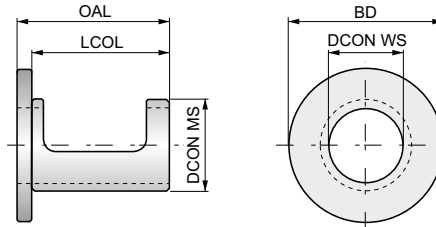

Diametern justerbar inom 0,4 - -0,2; centrumhöjden justerbar inom 0,2 - -0,15.

Product	DCON WS (mm)	DCON MS (mm)	BD (mm)	OAL (mm)	LCOL (mm)	 kg
EP253253	25.00	32.00	53.00	53.0	48	0.15
EP324058	32.00	40.00	58.00	58.0	53	0.19
EP405085-F	40.00	50.00	76.00	85.0	80	0.25

Verktygsmaterial (BMC)	HM	HM	HM	HM	HM										
Beläggning	Bright	Bright	Bright	Bright	Bright										
Standard (BSG)	DIN 8093	DIN 8093	DIN 8050	DIN 8094	DIN 8051										
Skärriktning															
Skaft															
Brotschform	B	B	A	B	A										
Nåbar håltolerans (TCHA)	H7	$\begin{matrix} \phi 95.5-5 \\ +0.004 \\ \phi 5.51-12 \\ +0.005 \end{matrix}$	H7	H7	H7										
Produktfamilj	B400	B481	B441	B411	B442										
PSF skärdiameter	1.00 - 20.00	0.98 - 12.05	10.00 - 20.00	5.00 - 30.00	10.00 - 20.00										
	250	251	253	254	255										
P	P1	■	■	■	■	■									
	P2	■	■	■	■	■									
	P3	■	■	■	■	■									
	P4	■	■	■	■	■									
M	M1	▣	▣	▣	▣	▣									
	M2	▣	▣	▣	▣	▣									
	M3														
	M4														
K	K1	■	■	■	■	■									
	K2	■	■	■	■	■									
	K3	■	■	■	■	■									
	K4														
	K5	■	■	■	■	■									
N	N1	■	■	■	■	■									
	N2	■	■	■	■	■									
	N3	■	■	■	■	■									
	N4	▣	▣	▣	▣	▣									
	N5														
S	S1														
	S2														
	S3														
	S4														
H	H1														
	H2														
	H3														
	H4														

B400



Maskinbrotsch av HM, extrem differentialdelning, blank

Utförd för att bearbeta hål till H7-tolerans. Brotschen är gjord av solid HM eller har pålörd HM-krona, beroende på storlek. Skären är extremt differentialdelade för att få bästa möjliga rundhet, ytfinhet och vibrationsfrihet. Lämplig för bearbetning av hårda och slitande material.

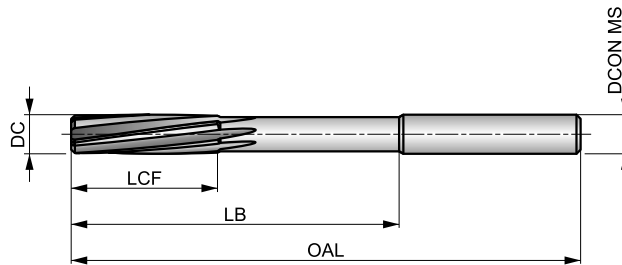

HM	Bright	DIN 8093
R		B
H7		

Arbetsmaterialgrupper och startvärden för skärhastighet (m/min) och matningskod. Tabeller med matningar finns med början på sidan 279

P1.1 ■ 23 B	P1.2 ■ 26 B	P1.3 ■ 27 B	P2.1 ■ 20 B	P2.2 ■ 18 B	P2.3 ■ 16 C	P3.1 ■ 16 B	P3.2 ■ 13 B	P3.3 ■ 11 C	P4.1 ■ 10 B	P4.2 ■ 8 C	P4.3 ■ 7 C	M1.1 ▣ 10 C	M1.2 ▣ 8 C
M2.1 ▣ 9 C	M2.2 ▣ 17 C	M2.3 ▣ 16 B	K1.1 ■ 20 D	K1.2 ■ 15 D	K1.3 ■ 11 D	K2.1 ■ 21 D	K2.2 ■ 17 D	K2.3 ■ 14 D	K3.1 ■ 18 D	K3.2 ■ 14 D	K3.3 ■ 11 D	K5.1 ■ 19 D	K5.2 ■ 15 D
K5.3 ■ 11 D	N1.1 ▣ 60 D	N1.2 ■ 45 D	N1.3 ■ 30 D	N2.1 ■ 38 D	N2.2 ■ 35 D	N2.3 ■ 25 D	N3.1 ■ 64 E	N3.2 ■ 38 E	N3.3 ▣ 19 E	N4.1 ▣ 35 C	N4.2 ▣ 30 C		

DCON MS tolerans h6; DC >= 14 mm Hårdmetallbestyckad.

Product	DC	OAL	LCF	LB	NOF	DCON MS
	(mm)	(mm)	(mm)	(mm)		(mm)
B4001.0	1.00	34.0	5.5	15.00	3	1.00
B4001.2	1.20	38.0	7.5	16.50	3	1.20
B4001.4	1.40	40.0	8.0	18.00	3	1.50
B4001.5	1.50	40.0	8.0	18.00	3	1.50
B4001.6	1.60	43.0	9.0	20.00	3	1.60
B4001.8	1.80	46.0	10.0	22.00	4	1.80
B4002.0	2.00	49.0	11.0	24.00	4	2.00
B4002.2	2.20	53.0	12.0	25.00	4	2.20
B4002.5	2.50	57.0	14.0	29.00	4	2.50
B4002.8	2.80	61.0	15.0	33.00	6	3.00
B4003.0	3.00	61.0	15.0	33.00	6	3.00
B4003.2	3.20	65.0	16.0	37.00	6	3.20
B4003.5	3.50	70.0	18.0	42.00	6	3.50
B4004.0	4.00	75.0	19.0	47.00	6	4.00

Product	DC	OAL	LCF	LB	NOF	DCON MS
	(mm)	(mm)	(mm)	(mm)		(mm)
B4004.5	4.50	80.0	21.0	52.00	6	4.50
B4005.0	5.00	86.0	23.0	58.00	6	5.00
B4005.5	5.50	93.0	26.0	57.00	6	5.60
B4006.0	6.00	93.0	26.0	57.00	6	5.60
B4006.5	6.50	101.0	28.0	65.00	6	6.30
B4007.0	7.00	109.0	31.0	73.00	6	7.10
B4008.0	8.00	117.0	33.0	81.00	6	8.00
B4009.0	9.00	125.0	36.0	85.00	6	9.00
B40010.0	10.00	133.0	38.0	93.00	6	10.00
B40012.0	12.00	151.0	44.0	111.00	6	10.00
B40014.0	14.00	160.0	47.0	115.00	6	12.50
B40016.0	16.00	170.0	52.0	125.00	6	12.50
B40018.0	18.00	182.0	56.0	137.00	6	14.00
B40020.0	20.00	195.0	60.0	147.00	6	16.00

B481



Hundradelsbrottsch av solid HM, i steg om 0,01 mm, blank

NC-brottsch med precisionskraft för inspanning i precisionshållare i CNC-maskiner. Extrem differentialdelning. Brottschen finns i hundradelsintervall runt hela och halva millimetrar som gör det möjligt att brotscha till valfri tolerans. Högerskärande med vänsterspiral. Går att använda i de flesta material, särskilt hårda och slitande.

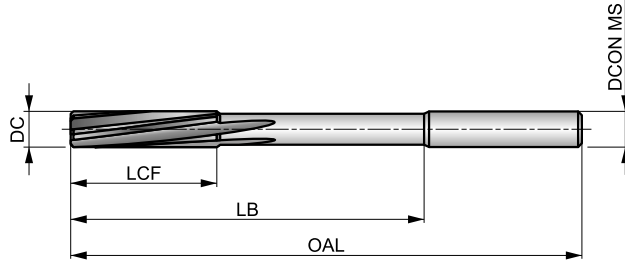

HM	Bright	DIN 8093
R	DIN 6535HA	B
ø 95-5.5 +0.004 ø 5.51-12 +0.005		

Arbetsmaterialgrupper och startvärden för skärhastighet (m/min) och matningskod. Tabeller med matningar finns med början på sidan 279

P1.1 ■ 23 B	P1.2 ■ 26 B	P1.3 ■ 27 B	P2.1 ■ 20 B	P2.2 ■ 18 B	P2.3 ■ 16 C	P3.1 ■ 16 B	P3.2 ■ 13 B	P3.3 ■ 11 C	P4.1 ■ 10 B	P4.2 ■ 8 C	P4.3 ■ 7 C	M1.1 ■ 10 C	M1.2 ■ 8 C
M2.1 ■ 9 C	M2.2 ■ 7 C	M2.3 ■ 6 B	K1.1 ■ 20 D	K1.2 ■ 15 D	K1.3 ■ 11 D	K2.1 ■ 21 D	K2.2 ■ 17 D	K2.3 ■ 14 D	K3.1 ■ 18 D	K3.2 ■ 14 D	K3.3 ■ 11 D	K5.1 ■ 19 D	K5.2 ■ 15 D
K5.3 ■ 11 D	N1.1 ■ 60 D	N1.2 ■ 45 D	N1.3 ■ 30 D	N2.1 ■ 38 D	N2.2 ■ 35 D	N2.3 ■ 25 D	N3.1 ■ 64 E	N3.2 ■ 38 E	N3.3 ■ 19 E	N4.1 ■ 35 C	N4.2 ■ 30 C		

DCON MS tolerans h6.

Product	DC	OAL	LCF	LB	NOF	DCON MS
	(mm)	(mm)	(mm)	(mm)		(mm)
B4810.98	0.98	50.0	6.0	22.00	3	3.00
B4810.99	0.99	50.0	6.0	22.00	3	3.00
B4811.03	1.03	50.0	6.0	22.00	3	3.00
B4811.50	1.50	50.0	9.0	22.00	3	3.00
B4811.51	1.51	50.0	10.0	22.00	3	3.00
B4811.52	1.52	50.0	10.0	22.00	3	3.00
B4811.53	1.53	50.0	10.0	22.00	3	3.00
B4811.98	1.98	50.0	12.0	22.00	4	3.00
B4811.99	1.99	50.0	12.0	22.00	4	3.00
B4812.00	2.00	50.0	12.0	22.00	4	3.00
B4812.01	2.01	50.0	12.0	22.00	4	3.00
B4812.02	2.02	50.0	12.0	22.00	4	3.00
B4812.03	2.03	50.0	12.0	22.00	4	3.00
B4812.48	2.48	60.0	16.0	32.00	4	3.00
B4812.49	2.49	60.0	16.0	32.00	4	3.00
B4812.50	2.50	60.0	16.0	32.00	4	3.00
B4812.51	2.51	60.0	16.0	32.00	4	3.00
B4812.52	2.52	60.0	16.0	32.00	4	3.00
B4812.53	2.53	60.0	16.0	32.00	4	3.00
B4812.97	2.97	65.0	17.0	37.00	6	4.00
B4812.98	2.98	65.0	17.0	37.00	6	4.00
B4812.99	2.99	65.0	17.0	37.00	6	4.00
B4813.00	3.00	65.0	17.0	37.00	6	4.00
B4813.01	3.01	65.0	17.0	37.00	6	4.00
B4813.02	3.02	65.0	17.0	37.00	6	4.00
B4813.03	3.03	65.0	17.0	37.00	6	4.00
B4813.97	3.97	75.0	19.0	47.00	6	4.00

Product	DC	OAL	LCF	LB	NOF	DCON MS
	(mm)	(mm)	(mm)	(mm)		(mm)
B4813.98	3.98	75.0	19.0	47.00	6	4.00
B4813.99	3.99	75.0	19.0	47.00	6	4.00
B4814.00	4.00	75.0	19.0	47.00	6	4.00
B4814.01	4.01	75.0	19.0	47.00	6	4.00
B4814.02	4.02	75.0	19.0	47.00	6	4.00
B4814.03	4.03	75.0	19.0	47.00	6	4.00
B4814.97	4.97	93.0	23.0	57.00	6	6.00
B4814.98	4.98	93.0	23.0	57.00	6	6.00
B4814.99	4.99	93.0	23.0	57.00	6	6.00
B4815.00	5.00	93.0	23.0	57.00	6	6.00
B4815.01	5.01	93.0	23.0	57.00	6	6.00
B4815.02	5.02	93.0	23.0	57.00	6	6.00
B4815.03	5.03	93.0	23.0	57.00	6	6.00
B4815.97	5.97	93.0	26.0	57.00	6	6.00
B4815.98	5.98	93.0	26.0	57.00	6	6.00
B4815.99	5.99	93.0	26.0	57.00	6	6.00
B4816.00	6.00	93.0	26.0	57.00	6	6.00
B4816.01	6.01	93.0	26.0	57.00	6	6.00
B4816.02	6.02	93.0	26.0	57.00	6	6.00
B4816.03	6.03	93.0	26.0	57.00	6	6.00
B4817.97	7.97	117.0	33.0	81.00	6	8.00
B4817.98	7.98	117.0	33.0	81.00	6	8.00
B4817.99	7.99	117.0	33.0	81.00	6	8.00
B4818.00	8.00	117.0	33.0	81.00	6	8.00
B4818.01	8.01	117.0	33.0	81.00	6	8.00
B4818.02	8.02	117.0	33.0	81.00	6	8.00
B4818.03	8.03	117.0	33.0	81.00	6	8.00



Product	DC	OAL	LCF	LB	NOF	DCON MS
	(mm)	(mm)	(mm)	(mm)		(mm)
B4818.04	8.04	117.0	33.0	81.00	6	8.00
B4819.97	9.97	133.0	38.0	93.00	6	10.00
B4819.98	9.98	133.0	38.0	93.00	6	10.00
B4819.99	9.99	133.0	38.0	93.00	6	10.00
B48110.00	10.00	133.0	38.0	93.00	6	10.00
B48110.01	10.01	133.0	38.0	93.00	6	10.00
B48110.02	10.02	133.0	38.0	93.00	6	10.00
B48110.03	10.03	133.0	38.0	93.00	6	10.00
B48110.04	10.04	133.0	38.0	93.00	6	10.00

Product	DC	OAL	LCF	LB	NOF	DCON MS
	(mm)	(mm)	(mm)	(mm)		(mm)
B48110.05	10.05	133.0	38.0	93.00	6	10.00
B48111.98	11.98	151.0	44.0	106.00	6	12.00
B48111.99	11.99	151.0	44.0	106.00	6	12.00
B48112.00	12.00	151.0	44.0	106.00	6	12.00
B48112.01	12.01	151.0	44.0	106.00	6	12.00
B48112.02	12.02	151.0	44.0	106.00	6	12.00
B48112.03	12.03	151.0	44.0	106.00	6	12.00
B48112.04	12.04	151.0	44.0	106.00	6	12.00
B48112.05	12.05	151.0	44.0	106.00	6	12.00

B441

DORMER



Maskinbrotsch med pålödda HM-skär, extrem differentialdelning, för H7-tolerans, blank

Rakspårig maskinbrotsch med pålödd hårdmetallkrona. Lämplig för brotschning i hårda och slitande material. Extremt differentialdelade skär ger mycket hög rundhet och ytfinhet med hålstorlek inom H7-tolans. Lämpar sig utmärkt för användning i CNC-maskiner.

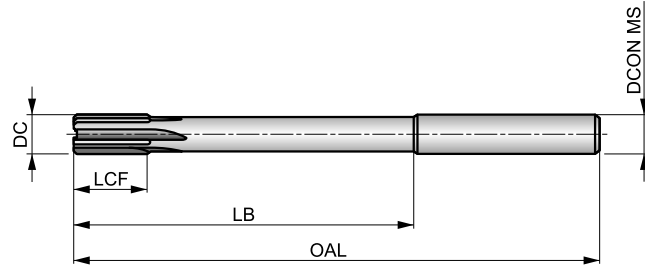

HM	Bright	DIN 8050
R		A
H7		

Arbetsmaterialgrupper och startvärden för skärhastighet (m/min) och matningskod. Tabeller med matningar finns med början på sidan 279

P1.1 ■ 23 B	P1.2 ■ 26 B	P1.3 ■ 27 B	P2.1 ■ 20 B	P2.2 ■ 18 B	P2.3 ■ 16 C	P3.1 ■ 16 B	P3.2 ■ 13 B	P3.3 ■ 11 C	P4.1 ■ 10 B	P4.2 ■ 8 C	P4.3 ■ 7 C	M1.1 ▣ 10 C	M1.2 ▣ 8 C
M2.1 ▣ 9 C	M2.2 ▣ 17 C	M2.3 ▣ 16 B	K1.1 ■ 20 D	K1.2 ■ 15 D	K1.3 ■ 11 D	K2.1 ■ 21 D	K2.2 ■ 17 D	K2.3 ■ 14 D	K3.1 ■ 18 D	K3.2 ■ 14 D	K3.3 ■ 11 D	K5.1 ■ 19 D	K5.2 ■ 15 D
K5.3 ■ 11 D	N1.1 ▣ 60 D	N1.2 ■ 45 D	N1.3 ■ 30 D	N2.1 ■ 38 D	N2.2 ■ 35 D	N2.3 ■ 25 D	N3.1 ■ 64 E	N3.2 ■ 38 E	N3.3 ▣ 19 E	N4.1 ▣ 35 C	N4.2 ▣ 30 C		

DCON MS tolerans h9; Hårdmetallbestyckad.

Product	DC (mm)	OAL (mm)	LCF (mm)	LB (mm)	NOF	DCON MS (mm)
B44110.0	10.00	133.0	19.0	87.00	6	10.00
B44111.0	11.00	142.0	19.0	96.00	6	10.00
B44112.0	12.00	151.0	19.0	105.00	6	10.00
B44113.0	13.00	151.0	19.0	105.00	6	10.00
B44114.0	14.00	160.0	19.0	110.00	6	12.50
B44115.0	15.00	162.0	19.0	112.00	6	12.50
B44116.0	16.00	170.0	22.0	120.00	6	12.50
B44117.0	17.00	175.0	22.0	123.00	6	14.00
B44118.0	18.00	182.0	22.0	130.00	6	14.00
B44119.0	19.00	189.0	22.0	131.00	6	16.00
B44120.0	20.00	195.0	22.0	137.00	6	16.00

B411



Maskinbrotsch med HM-skär, extrem differentialdelning, för H7-tolerans, blank

Maskinbrotsch med pålödd hårdmetallkrona. Lämplig för brotschning i hårda och slitande material. Extremt differentialdelade skär ger mycket hög rundhet och ytfinitet med hålstorlek inom H7-tolerans. Lämpar sig utmärkt för användning i CNC-maskiner.

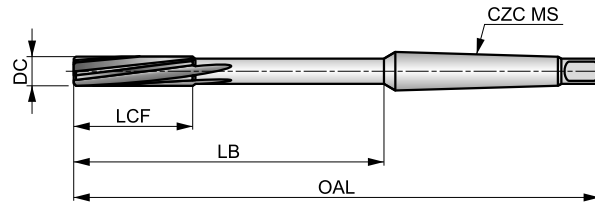

HM	Bright	DIN 8094
R		B
H7		

Arbetsmaterialgrupper och startvärden för skärhastighet (m/min) och matningskod. Tabeller med matningar finns med början på sidan 279

P1.1 ■ 23 B	P1.2 ■ 26 B	P1.3 ■ 27 B	P2.1 ■ 20 B	P2.2 ■ 18 B	P2.3 ■ 16 C	P3.1 ■ 16 B	P3.2 ■ 13 B	P3.3 ■ 11 C	P4.1 ■ 10 B	P4.2 ■ 8 C	P4.3 ■ 7 C	M1.1 ▣ 10 C	M1.2 ▣ 8 C
M2.1 ▣ 9 C	M2.2 ▣ 17 C	M2.3 ▣ 16 B	K1.1 ■ 20 D	K1.2 ■ 15 D	K1.3 ■ 11 D	K2.1 ■ 21 D	K2.2 ■ 17 D	K2.3 ■ 14 D	K3.1 ■ 18 D	K3.2 ■ 14 D	K3.3 ■ 11 D	K5.1 ■ 19 D	K5.2 ■ 15 D
K5.3 ■ 11 D	N1.1 ▣ 60 D	N1.2 ■ 45 D	N1.3 ■ 30 D	N2.1 ■ 38 D	N2.2 ■ 35 D	N2.3 ■ 25 D	N3.1 ■ 64 E	N3.2 ■ 38 E	N3.3 ▣ 19 E	N4.1 ▣ 35 C	N4.2 ▣ 30 C		

DC <= 16mm Hårdmetallkrona; DC > 16mm Hårdmetallskär.

Product	DC (mm)	OAL (mm)	LCF (mm)	LB (mm)	NOF	CZC MS
B4115.0	5.00	133.0	23.0	67.50	6	MK 1
B4116.0	6.00	138.0	26.0	72.50	6	MK 1
B4117.0	7.00	150.0	31.0	84.50	6	MK 1
B4118.0	8.00	156.0	33.0	90.50	6	MK 1
B4119.0	9.00	162.0	36.0	96.50	6	MK 1
B41110.0	10.00	168.0	38.0	102.50	6	MK 1
B41112.0	12.00	182.0	44.0	116.50	6	MK 1
B41114.0	14.00	189.0	47.0	123.50	8	MK 1
B41115.0	15.00	204.0	50.0	124.00	8	MK 2
B41116.0	16.00	210.0	52.0	130.00	8	MK 2
B41117.0	17.00	214.0	54.0	134.00	6	MK 2
B41118.0	18.00	219.0	56.0	139.00	6	MK 2
B41119.0	19.00	223.0	58.0	143.00	6	MK 2
B41120.0	20.00	228.0	60.0	148.00	6	MK 2
B41122.0	22.00	237.0	64.0	157.00	6	MK 2
B41124.0	24.00	268.0	68.0	169.00	8	MK 3
B41125.0	25.00	268.0	68.0	169.00	8	MK 3
B41126.0	26.00	273.0	70.0	174.00	8	MK 3
B41130.0	30.00	281.0	73.0	182.00	8	MK 3

B442



Maskinbrotsch med HM-krona, extrem differentialdelning, blank

Utformad för att bearbeta hål till H7-tolerans. Brotschen har pålödd HM-krona med raka skär. Skären är extremt differentialdelade för att få bästa möjliga rundhet, ytfinitet och vibrationsfrihet. Lämplig för bearbetning av hårda och slitande material.

HM	Bright	DIN 8051
R		A
H7		

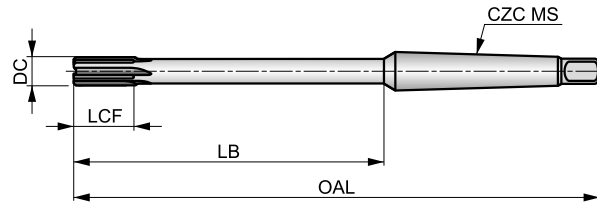

Arbetsmaterialgrupper och startvärden för skärhastighet (m/min) och matningskod. Tabeller med matningar finns med början på sidan 279

P1.1 ■ 23 B	P1.2 ■ 26 B	P1.3 ■ 27 B	P2.1 ■ 20 B	P2.2 ■ 18 B	P2.3 ■ 16 C	P3.1 ■ 16 B	P3.2 ■ 13 B	P3.3 ■ 11 C	P4.1 ■ 10 B	P4.2 ■ 8 C	P4.3 ■ 7 C	M1.1 ▣ 10 C	M1.2 ▣ 8 C
M2.1 ▣ 9 C	M2.2 ▣ 7 C	M2.3 ▣ 6 B	K1.1 ■ 20 D	K1.2 ■ 15 D	K1.3 ■ 11 D	K2.1 ■ 21 D	K2.2 ■ 17 D	K2.3 ■ 14 D	K3.1 ■ 18 D	K3.2 ■ 14 D	K3.3 ■ 11 D	K5.1 ■ 19 D	K5.2 ■ 15 D
K5.3 ■ 11 D	N1.1 ▣ 60 D	N1.2 ■ 45 D	N1.3 ■ 30 D	N2.1 ■ 38 D	N2.2 ■ 35 D	N2.3 ■ 25 D	N3.1 ■ 64 E	N3.2 ■ 38 E	N3.3 ▣ 19 E	N4.1 ▣ 35 C	N4.2 ▣ 30 C		

Product	DC (mm)	OAL (mm)	LCF (mm)	LB (mm)	NOF	CZC MS
B44210.0	10.00	168.0	19.0	102.50	6	MK 1
B44212.0	12.00	182.0	19.0	116.50	6	MK 1
B44214.0	14.00	189.0	19.0	123.50	6	MK 1
B44215.0	15.00	204.0	19.0	124.00	6	MK 2
B44216.0	16.00	210.0	22.0	130.00	6	MK 2
B44217.0	17.00	214.0	22.0	134.00	6	MK 2
B44218.0	18.00	219.0	22.0	139.00	6	MK 2
B44219.0	19.00	223.0	22.0	143.00	6	MK 2
B44220.0	20.00	228.0	22.0	148.00	6	MK 2



ANVISNINGAR

DRILLS – PAGE OVERVIEW

1 R003



Kort borr i solid hårdmetall, TiN-spetsbelag

Mångsidig instegsborr med 120° spetsvinkel med fyra fasseters delad spetsgeometri för minskad skärkraft och CTW-spårkonstruktion för ökad in-trängningsförmåga. TiN-beläggning förbättrar prestanda och förlänger verktygets livslängd. Lämplig för både CNC-maskiner och konventionella maskiner i ett brett spektrum av arbetsstyckesmaterial.

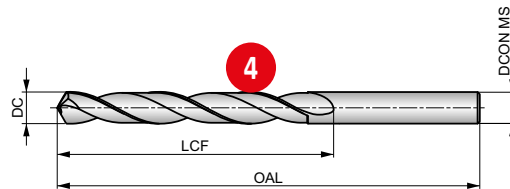

HM	DIN 338	4xD
120°	TiN-Tip	5
λ _{20-35°}	R	DC h7

Arbetsmaterialgrupper och startvärden för skärhastighet (m/min) och matningskod. Tabeller med matningar finns med början på sidan 274

P1.1	P1.2	P1.3	P2.1	P2.2	P2.3	P3.1	P3.2	P3.3	P4.1	P4.2	P4.3	K1.1	K1.2
■ 99 S	■ 111 S	■ 115 S	■ 85 S	■ 75 S	■ 66 S	■ 66 S	■ 53 S	■ 45 S	■ 40 S	■ 34 S	■ 27 S	■ 75 T	■ 56 T
K1.3	K2.1	K2.2	K2.3	K3.1	K3.2	K3.3	1.1	K4.2	K4.3	K4.4	K4.5	K5.1	K5.2
■ 42 T	■ 68 T	■ 55 T	■ 44 T	■ 60 T	■ 46 T	■ 37 T	■ 55 T	■ 42 T	■ 31 T	■ 26 T	■ 22 T	■ 63 T	■ 47 T
K5.3	N1.1	N1.2	N1.3	N2.1	N2.2	N2.3	N3.1	N3.2	N4.1	N4.2	H1.1	H2.1	H3.1
■ 37 T	■ 150 V	■ 113 V	■ 75 V	■ 129 V	■ 116 V	■ 84 V	■ 317 V	■ 190 V	■ 60 U	■ 100 U	■ 34 S	■ 20 S	■ 22 S

Product	DC (inch)	DC (mm)	DC (inch)	LCF (mm)	OAL (mm)	DCON MS (mm)
R0031.0	–	1.00	0.0394	12.0	34.0	1.00
R003N60	N60	1.02	0.0400	12.0	34.0	1.02
R0031.1	–	1.10	0.0433	14.0	36.0	1.10
R003N56	N56	1.18	0.0465	16.0	38.0	1.18
R003N54	3/64	1.19	0.0469	16.0	38.0	1.19
R0031.3	–	1.20	0.0472	16.0	38.0	1.20
R0031.3	–	1.30	0.0512	16.0	38.0	1.30
R003N54	N54	1.40	0.0550	18.0	40.0	1.40
R0031.4	–	1.40	0.0551	18.0	40.0	1.40
R0031.5	–	1.50	0.0591	18.0	40.0	1.50
R003N53	N53	1.51	0.0595	20.0	43.0	1.51
R0031/16	1/16	1.59	0.0625	20.0	43.0	1.59
R0031.6	–	1.60	0.0630	20.0	43.0	1.60
R003N52	N52	1.61	0.0635	20.0	43.0	1.61

Product	DC (inch)	DC (mm)	DC (inch)	LCF (mm)	OAL (mm)	DCON MS (mm)
R0032.3	–	2.30	0.0906	27.0	53.0	2.30
R0033/32	3/32	2.38	0.0937	30.0	57.0	2.38
R0032.4	–	2.40	0.0945	30.0	57.0	2.40
R003N41	N41	2.44	0.0960	30.0	57.0	2.44
R0032.5	–	2.50	0.0984	30.0	57.0	2.50
R003N39	N39	2.53	0.0995	30.0	57.0	2.53
R003N38	N38	2.58	0.1015	30.0	57.0	2.58
R0032.6	–	2.60	0.1024	30.0	57.0	2.60
R003N37	N37	2.64	0.1040	30.0	57.0	2.64
R0032.7	–	2.70	0.1063	33.0	61.0	2.70
R003N36	N36	2.71	0.1065	33.0	61.0	2.71
R0037/64	7/64	2.78	0.1094	33.0	61.0	2.78
R0032.8	–	2.80	0.1102	33.0	61.0	2.80
R003N33	N33	2.87	0.1130	33.0	61.0	2.87

Pos.	Description
1	Designation of drill
2	Product description
3	Illustrative picture
4	Schematic drawing of tool

Pos.	Description
5	Product features
6	Material group recommendations incl. speed and feed guidance
7	Product code
8	Product dimensions

INSERTS – PAGE OVERVIEW

1 SCET



	IC (mm)	D1 (mm)	L (mm)	S (mm)
0502	5.556	3	5.56	2.38
0602	6.350	2.90	6.35	2.38
0703	7.937	3.50	7.94	3.18
09T3	9.525	4.50	9.53	3.97
1204	12.700	5.60	12.70	4.76
1505	15.875	5.60	15.88	5.56

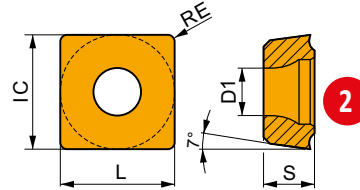

Lämplighet och startvärden för skärhastighet (vc), matning (f) och skärdjup (ap). Vi refererar till vår Dormer Pramet Calculator-app för vidare beräkningar.

Produkt	Interrupted/ Continuous cut	RE (mm)	P			M			K			N			S			H		
			vc (m/min)	f (mm/rev)	ap (mm)	vc (m/min)	f (mm/rev)	ap (mm)	vc (m/min)	f (mm/rev)	ap (mm)	vc (m/min)	f (mm/rev)	ap (mm)	vc (m/min)	f (mm/rev)	ap (mm)			



UD-geometri med universell design för periferiskär

SCET 050204-UD:D8330	● 0.4	■ 165	0.08	–	–	–	–	■ 155	0.08	–	–	–	–	–	–	–	–	–	–
SCET 050204-UD:D9335	● 0.4	■ 240	0.08	–	–	–	–	■ 225	0.08	–	–	–	–	–	–	–	–	–	–
SCET 060204-UD:D8330	● 0.4	■ 165	0.11	–	–	–	–	■ 155	0.11	–	–	–	–	–	–	–	–	–	–
SCET 060204-UD:D9335	● 0.4	■ 240	0.11	–	–	–	–	■ 225	0.11	–	–	–	–	–	–	–	–	–	–
SCET 070303-UD:D8330	● 0.4	■ 165	0.13	–	–	–	–	■ 155	0.13	–	–	–	–	–	–	–	–	–	–
SCET 070303-UD:D9335	● 0.4	■ 240	0.13	–	–	–	–	■ 225	0.13	–	–	–	–	–	–	–	–	–	–
SCET 09T308-UD:D8330	● 0.8	■ 165	0.14	–	–	–	–	■ 155	0.14	–	–	–	–	–	–	–	–	–	–
SCET 09T308-UD:D9335	● 0.8	■ 240	0.14	–	–	–	–	■ 225	0.14	–	–	–	–	–	–	–	–	–	–
SCET 120408-UD:D8330	● 0.8	■ 165	0.16	–	–	–	–	■ 155	0.16	–	–	–	–	–	–	–	–	–	–
SCET 120408-UD:D9335	● 0.8	■ 240	0.16	–	–	–	–	■ 225	0.16	–	–	–	–	–	–	–	–	–	–
SCET 150512-UD:D8330	● 1.2	■ 165	0.18	–	–	–	–	■ 155	0.18	–	–	–	–	–	–	–	–	–	–
SCET 150512-UD:D9335	● 1.2	■ 240	0.18	–	–	–	–	■ 225	0.18	–	–	–	–	–	–	–	–	–	–

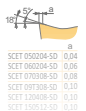

UD-geometri med universell design för periferiskär



Pos.	Description
1	Designation of insert
2	Schematic drawing of insert
3	Table with insert sizes (mm)
4	Picture of representative insert
5	Profile of main cutting edge
6	Icons – specific features and cutting edge type

Pos.	Description
7	ISO insert code: Grade
8	Working conditions
9	Insert radii (mm)
10	Geometry description
11	Application area of insert

Typical page with drilling inserts displayed – specific page details will differ.

INDEXABLE DRILLS – PAGE OVERVIEW

1
2
P
M
K
N
S
H
PRAMET
S
3



Korthålsborr typ 802D för borrhjup 2xD, invändiga kylkanaler
 Korthålsborr för effektiv borrar av bottenhål och genomgående hål. Kan även användas vid korsande hål, paketborrning, borrar mot vinklade eller konkava ytor, mm. Finns i dimensioner 15 - 40 mm. Borrhjup upp till 2xD i de flesta material.

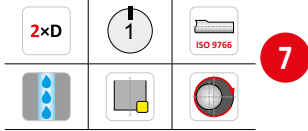
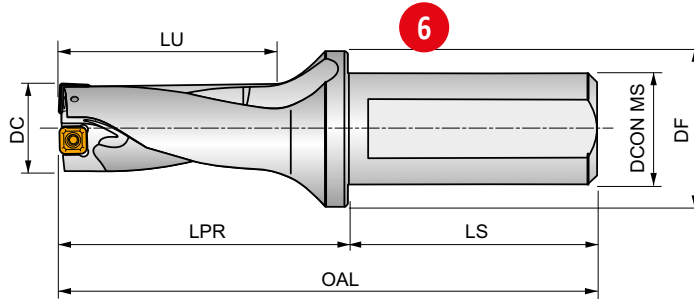

Product	DC	APMX	OAL	LPR	LS	LU	DCON MS	DF	\bar{D}	D^+					
	[mm]	[mm]	[mm]	[mm]	[mm]	[mm]	[mm]	[mm]	[mm]	[mm]			[kg]		
802D-15-30-S25	15	30.00	121	65	56	34.5	25	35	0.25	0.35	EP253253	GI300	GI313	0.30	HM001
802D-16-32-S25	16	32.00	123	67	56	37	25	35	0.15	0.45	EP253253	GI300	GI313	0.30	HM001
802D-17-34-S25	17	34.00	125	69	56	39.5	25	35	0.15	0.50	EP253253	GI300	GI313	0.30	HM001
802D-18-36-S25	18	36.00	127	71	56	42	25	35	0.35	0.25	EP253253	GI301	GI314	0.31	HM002
802D-19-38-S25	19	38.00	129	73	56	44.5	25	35	0.15	0.45	EP253253	GI301	GI314	0.32	HM002
802D-20-40-S25	20	40.00	131	75	56	47	25	35	0.10	0.45	EP253253	GI302	GI315	0.33	HM003
802D-21-42-S25	21	42.00	133	77	56	49.5	25	35	0.10	0.50	EP253253	GI302	GI315	0.34	HM003
802D-22-44-S25	22	44.00	135	79	56	52	25	35	0.45	0.50	EP253253	GI303	GI316	0.35	HM004
802D-23-46-S25	23	46.00	137	81	56	54.5	25	35	0.35	0.50	EP253253	GI304	GI317	0.36	HM005
802D-24-48-S25	24	48.00	139	83	56	57	25	35	0.15	0.50	EP253253	GI304	GI317	0.37	HM005

GI300	XPET 0502AP	SCET 050204-UD
GI301	XPET 0602AP	SCET 050204-UD
GI302	XPET 0602AP	SCET 060204-UD
GI303	XPET 0703AP	SCET 060204-UD
GI304	XPET 0703AP	SCET 070308-UD
GI305	XPET 0903AP	SCET 070308-UD
GI306	XPET 0903AP	SCET 09T308-UD
GI307	XPET 11T3AP	SCET 09T308-UD
GI308	XPET 11T3AP	SCET 120408-UD
GI309	XPET 12T3AP	SCET 120408-UD
GI313	XPET 0502AP-SD	SCET 050204-SD
GI314	XPET 0602AP-SD	SCET 050204-SD
GI315	XPET 0602AP-SD	SCET 060204-SD
GI316	XPET 0703AP-SD	SCET 060204-SD
GI317	XPET 0703AP-SD	SCET 070308-SD

GI300	XPET 0502AP	SCET 050204-UD
GI301	XPET 0602AP	SCET 050204-UD
GI302	XPET 0602AP	SCET 060204-UD
GI303	XPET 0703AP	SCET 060204-UD
GI304	XPET 0703AP	SCET 070308-UD



INDEXABLE DRILLS – PAGE OVERVIEW

Pos.	Description	Pos.	Description
1	Designation of drill	11	Radial setting (mm)
2	Material group recommendations	12	Adjustable sleeve
3	Clamping system of insert	13	Group of compatible inserts with chip breaker UD ^{1),2)}
4	Tool description	14	Group of compatible inserts with chip breaker SD ^{1),2)}
5	Illustrative picture	15	Weight (kg)
6	Schematic drawing of tool	16	Group of spare parts ¹⁾
7	Product features	17	Compatible inserts with chip breaker UD
8	Product applications	18	Compatible inserts with chip breaker SD
9	Tool code	19	Spare parts
10	Tool dimensions		

¹⁾ Code of Group of compatible inserts and spare parts is used only for purposes of this catalogue. It cannot be used for orders.

²⁾ External (SCET) and internal (XPET) inserts must always have the same chip breaker (please note: UD chip breaker is not visibly included in designation of XPET inserts – e.g. XPET 0502AP); info needed for correct choice of chip breaker (UD vs SD) can be found on the insert packaging.



IKONÖVERSIKT

0

 Förstaval Möjlig användning

Standard (BSG)

DIN 1897	DIN 1897 - Extrakorta borrar	DIN 6539	DIN 6539	DIN 212	DIN 212 - Maskinbrotschar
DIN 1899	DIN 1899 - Mikroborrar	DIN 6537K	DIN 6537 K	DIN 2179	DIN 2179 - Koniska brotschar med cyl. skaft
DIN 338	DIN 338 - Standard för cylindriska borrar	DIN 6537L	DIN 6537 L	DIN 2180	DIN 2180 - Koniska brotschar med Morse-konskaft
NAS 907	NAS907 – Standard för flygplansborrar	DIN 333R	DIN 333 R - Standard för försänkare med cyl. skaft	DIN 311	DIN 311 - Standard för nithålsbrotschar med Morse-konskaft
DIN 340	DIN 340 - Standard för långa cylindriska borrar	DIN 333C	DIN 333 C - Standard för försänkare med cyl. skaft	DIN 8050	DIN 8050 - Standard för maskinbrotschar med cyl. skaft
DIN 1869-1	DIN 1869 / 1 – Standard för extralånga borrar med cyl. skaft	DIN 335A	DIN 335 A - Standard för försänkare med cyl. skaft	DIN 8051	DIN 8051 - Standard för brotschar med Morse-konskaft
DIN 1869-2	DIN 1869 / 2 – Standard för extralånga borrar med cyl. Skaft	DIN 335C	DIN 335 C - Standard för försänkare med cyl. skaft	DIN 8093	DIN 8093 - Standard för brotschar med cyl. skaft
DIN 1869-3	DIN 1869 / 60-100° Försänkare – Standard för extralånga borrar med cyl. Skaft	DIN 334D	DIN 334 D - Standard för försänkare med Morse-konskaft	DIN 8094	DIN 8094 - Standard för brotschar med Morse-konskaft
DIN 1870(2)	DIN 1870 (2) – Standard för extralånga borrar med Morse-konskaft	DIN 335D	DIN 335 D - Standard för försänkare med Morse-konskaft	DIN 9	DIN - Standard för koniska pinnbrotschar
DIN 345	DIN 345 - Standard för borrar med Morse-konskaft	DIN 373	DIN 373 - Standard för tappförsänkare	DIN ANSI	DIN/ANSI standard
DIN 8374	DIN 8374 - Standard för stegborrar	BS 328	BS 328 – Borr- och brotschstandard	ANSI	ANSI – Standard för tappar
DIN 8376	DIN 8376 - Standard för tappborrar	DIN 206	DIN 206 - Handbrotschar	DORMER	Dormer-standard
DIN 333A	DIN 333 A - Standard för centrerborrar	DIN 208	DIN 208 - Maskinbrotschar med Morse-konskaft		

Användbar längd (ULDR)

1×D	1×D Rekommenderat max. borrdjup	3.5×D	60-100° Försänkare.5×D Rekommenderat max. borrdjup	12×D	12×D Rekommenderat max. borrdjup
1.25×D	1.25×D Rekommenderat max. borrdjup	4×D	4×D Rekommenderat max. borrdjup	15×D	15×D Rekommenderat max. borrdjup
1.5×D	1,5×D Rekommenderat max. borrdjup	5×D	5×D Rekommenderat max. borrdjup	20×D	20×D Rekommenderat max. borrdjup
2×D	2×D Rekommenderat max. borrdjup	6×D	6×D Rekommenderat max. borrdjup	25×D	25×D Rekommenderat max. borrdjup
2.5×D	2,5×D Rekommenderat max. borrdjup	8×D	8×D Rekommenderat max. borrdjup		
3×D	3×D Rekommenderat max. borrdjup	10×D	10×D Rekommenderat max. borrdjup		

IKONÖVERSIKT

Spetsvinkel

118°	Spetsvinkel 118°	120°	Spetsvinkel 120°	82°	82° Försänkare
120°	Spetsvinkel 120°	150°	Spetsvinkel 150°	90°	90° Försänkare
122°	Spetsvinkel 122°	90°	Tappborr med 90° försänkning (för gänghål)	100°	100° Försänkare
130°	Spetsvinkel 130°	90°	Stegborr 90° försänkning	60-100°	60-100° Försänkare
135°	Spetsvinkel 135°	180°	Stegborr 180° försänkning	60°	60° Centerborr
140°	Spetsvinkel 140°	180°	180° Försänkingsborr	R	Centerborr med radieförsänkning
90°	Spetsvinkel 90°	20°	20° Koniskt borr		
90°/120°	Spetsvinkel 90°/120°	60°	60° Försänkare		

Skaft

Cylindriskt skaft	Cylindriskt skaft med fyrkant	Universalskaft ISO 9766
DIN 6535 HA Cylindriskt skaft	Cylindriskt skaft med sexkant	Cylindriskt skaft med fläns
Cylindriskt skaft med tunga	Morskaft	ISO 9766 Cylindriskt skaft (med eller utan plattor)
Cylindriskt skaft med tre plattor	Reducerat cylindriskt skaft	DIN 6535 – HB (Weldon) eller HE (Whistlenotch) skaf

Spiralform

Kontinuerligt urtunnad kärna	Högspiral $\lambda > 35^\circ$	Standardspiral $\lambda 20-35^\circ$
Högspiral $\lambda 32-40^\circ$	VA Speciell spetsurtunning	

Skärriktning

Vänsterroterande	Högerroterande	Invärdig kylkanal
------------------	----------------	-------------------

Kylning (CSP)

Skärdiameter, toleransklass (TCDC)

DC h6	h6 - Industristandardtolerans (baserad på diametern)	DC h8	h8 - Industristandardtolerans (baserad på diametern)
DC h7	h7 - Industristandardtolerans (baserad på diametern)	DC m7	m7 - Industristandardtolerans (baserad på diametern)

IKONÖVERSIKT

Nåbar håltolerans (TCH)

H7	H7 – Håltolerans enligt Industristandard (baserad på diameter)	k11	k11 – Verktygstolerans enligt Industristandard (baserad på diameter)	$\begin{matrix} \phi 95-5,5 \\ +0.004 \\ \phi 5.51-12 \\ +0.005 \end{matrix}$	Hög håltolerans
-----------	--	------------	--	---	-----------------

Brottschform

A	DIN Form A – Rakspårig, högerskärande	B	DIN Form B – Vänsterspiral, högerskärande
----------	---------------------------------------	----------	---

Avsmalningsgradient (avsmalningens hastighet)

1:50	Konicitet 1:50	1:48	Konicitet 1:48
-------------	----------------	-------------	----------------

Drilling Operations

	Borring		Borring		Borring
	Borring		Borring		Borring
	Borring		Borring		Borring
	Borring		Borring		Borring
	Borring		Borring		Borring
	Borring		Borring		Borring

Insert Features

	För sega och långspånande material		Universalalternativ för de flesta jobb
	Tunga arbetsförhållanden		Rundad egg med fasett

General Features of Tools

1	1 egg i arbete/varv		Design i ett stycke		Möjlighet till excentrisk bearbetning
----------	---------------------	--	---------------------	--	---------------------------------------

Other Icons

		S	S - Skruvspänning		
--	--	----------	-------------------	--	--

VÄNDSKÄR – ISO KODER

ISO	1	2	3	4
	S	C	E	T
ANSI	1	2	3	4
	S	C	E	T

1				2				4														
Skärform				Släppningsvinkel				Skärtyper														
H	O	P	R	A	B	C	D	N	R	F	A	M	G	W	T	Q	U	B	H	C	J	X
S	T	C	D	E	F	G	N	40°-60°		70°-90°												
E	M	V	W	P	O		Special															
L	A	B	K																			

3				3			
Toleranser							
	(mm)			(")			
	M(±)	S(±)	IC(±)	M(±)	S(±)	IC(±)	
A	0.005	0.025	0.025	.0002"	.001"	.0010"	
F	0.005	0.025	0.013	.0002"	.001"	.0005"	
C	0.013	0.025	0.025	.0005"	.001"	.0010"	
H	0.013	0.025	0.013	.0005"	.001"	.0005"	
E	0.025	0.025	0.025	.0010"	.001"	.0010"	
G	0.025	0.130	0.025	.0010"	.005"	.0010"	
J	0.005	0.025	0.05 – 0.13	.0002"	.001"	.002 – 0.005"	
K	0.013	0.025	0.05 – 0.13	.0005"	.001"	.002 – 0.005"	
L	0.025	0.025	0.05 – 0.13	.0010"	.001"	.002 – 0.005"	
M	0.08 – 0.18	0.130	0.05 – 0.13	.003 – 0.007"	.005"	.002 – 0.005"	
N	0.08 – 0.18	0.025	0.05 – 0.13	.003 – 0.007"	.001"	.002 – 0.005"	
U	0.05 – 0.38	0.130	0.05 – 0.13	.005 – 0.015"	.005"	.003 – 0.010"	

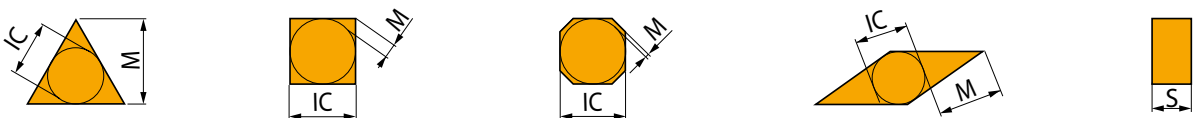

VÄNDSKÄR – ISO KODER

5	6	7	8	9	10
05	02	04			UD
5	6	7	8	9	10
1.8	1.5	1			UD

5												5												6			7		
Skärkantlängd (skärstorlek)																								Skärtjocklek			Nosradie		
d=l.C.		H	O	P	S	T	C	D	E	M	V	W	R	K	S		RE												
(mm)	(in)													(mm)	(in)	(mm)	(in)	(mm)	(in)										
3.97	5/32"				03	06		04				06	02					00	0	0"									
4.76	3/16"				04	08	04	05	04	04	08	L3						02	0.2	1/128"									
5.56	7/32"				05	09	05	06	05	05	09	03						04	0.4	1/64"									
6.35	1/4"	03	02	04	08	11	06	07	08	08	11	04	06					08	0.8	1/32"									
7.94	5/16"	04	03	05	07	13	08	09	06	07	13	05	07					12	1.2	3/64"									
9.525	3/8"	05	04	07	09	16	09	11	09	09	16	06	09	16				16	1.6	1/16"									
12.7	1/2"	07	05	09	12	22	12	15	13	12	22	08	12					24	2.4	3/32"									
15.875	5/8"	09	06	11	15	27	16	19	16	15	27	10	15					32	3.2	1/8"									
19.05	3/4"	11	07	13	19	33	19	23	19	19	33	13	19						Runda skär			d=l.C.							
25.40	1"	14	10	18	25	44	25	31	26	25	44	17	25									(in)	00						
31.75	1 1/4"	18	13	23	31	54	32	38	32	31	54	21	31						(mm)	M0									

ANSI											
5			6			7					
Inskreven cirkel			Skärtjocklek			Nosradie					
d=l.C.			S			RE					
Symbol	(mm)	(in)	Symbol	(mm)	(in)	Symbol	(mm)	(in)			
1	3.175	1/8"	1	1.588	1/16"	0	0	0"			
1.2	3.969	5/32"	1.2	1.984	5/64"	0.2	0.099	1/256"			
1.5	4.763	3/16"	1.5	2.381	3/32"	0.5	0.198	1/128"			
1.8	5.556	7/32"	2	3.175	1/8"	1	0.397	1/64"			
2	6.350	1/4"	2.5	3.969	5/32"	2	0.794	1/32"			
2.5	7.938	5/16"	3	4.763	3/16"	3	1.191	3/64"			
3	9.525	3/8"	3.5	5.556	7/32"	4	1.588	1/16"			
4	12.700	1/2"	4	6.350	1/4"	5	1.984	5/64"			
5	15.875	5/8"	5	7.938	5/16"	6	2.381	3/32"			
6	19.050	3/4"	6	9.525	3/8"	7	2.778	7/64"			
7	22.225	7/8"	7	11.113	7/16"	8	3.175	1/8"			
8	25.400	1"	8	12.700	1/2"	10	3.969	5/32"			
10	31.750	5/4"	9	14.288	9/16"	12	4.763	3/16"			
12	38.100	6/4"	10	15.875	5/8"	14	5.556	7/32"			
						16	6.350	1/4"			

8												8		
Skäreddsdesign														
F						E								
Vass egg						Rundad egg								
T						S								
Egg med förstärkningsfas						Rundad egg med förstärkningsfas								
K						P								
Egg med dubbel förstärkningsfas						Rundad egg med dubbel förstärkningsfas								
9												9		
Matningsriktning /														
R						N								
Matning ←						Matning →								
L														
Matning →						Matning ←								
10												10		
Spånbräntyp														

KODNYCKEL FÖR BORRAR

1	2	3		4		5		6	7
8	05	D	-	19	-	95	-	S	25



1		2		3		4	
Verktygstyp		Ungefärligt borrdjup		Variant		Borrdiameter	
8	Vändskärsborr	02	2 × DC	D	Drill	15.5	DC = 15.5 mm
		03	3 × DC				19
		04	4 × DC				
		05	5 × DC				

5		6		7	
Max. borrdjup		Skafttyp		Skaftdiameter	
35	35 mm	E	Whistle Notch	25	DCON MS = 25 mm
95	95 mm			32	DCON MS = 32 mm
140	140 mm	S	ISO 9766	40	DCON MS = 40 mm

SKÄRDATAPARAMETRAR ENL. ISO 13399

Alla skärande verktyg definieras av ett antal parametrar enligt ISO 13399. Den här listan innehåller alla parametrar som förekommer i katalogen

ISO 13399 är en internationell informationsstandard för skärande verktyg. Den omfattar dimensioner och parametrari ett neutralt format som är oberoende av något särskilt system eller något företags egna benämningar. När skärande verktyg definieras tydligt enligt en global standard, kan alla mjukvaruprogram behandla de elektroniska datan snabbare, vilket ger högre kvalitet på kommunikationen och gör infor-

mationsutbytet enklare. Genom att använda ett gemensamt språk för att beskriva våra verktyg underlättas kommunikationen mellan systemen. Det kommer att bespara er enormt mycket tid genom att samla högkvalitativa data om våra 40.000 solida och indexerbara verktyg. Genom att använda ett system som är kompatibelt med ISO 13399 kommer inga manuella inmatningar av data att behövas i ert system.

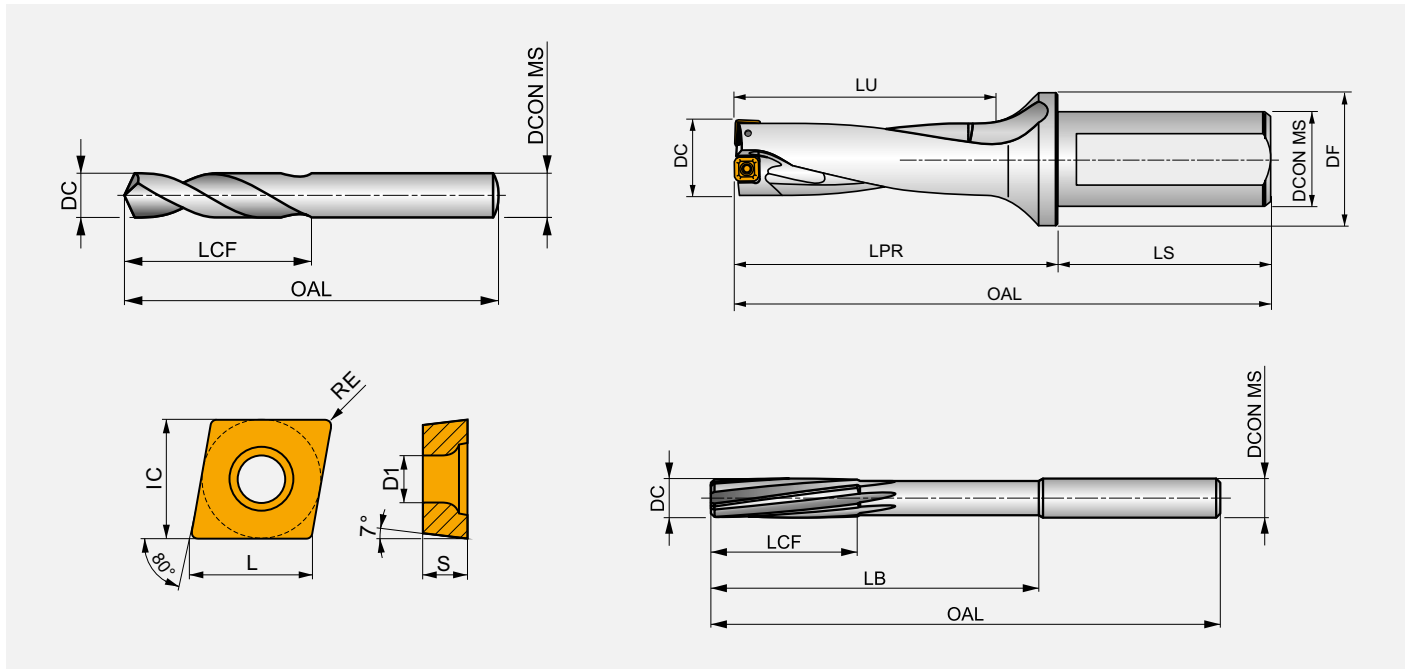





ISO 13399	description
BD	Body diameter
BDX	Body diameter maximum
CZC MS	Connection size code machine side
D1	Fixing hole diameter
DC	Cutting diameter
DCN	Cutting diameter minimum
DCON MS	Connection diameter machine side
DCON WS	Connection diameter workpiece side
DCX	Cutting diameter maximum
DHUB	Hub diameter
FLGT	Flange thickness
IC	Inscribed circle diameter
L	Cutting edge length
LB	Body length
LF	Functional length
LPR	Protruding length
LU	Usable length
OAL	Overall length
RE	Corner radius
S	Insert thickness
WF	Functional width
APMX	Depth of cut maximum
D1	Fixing hole diameter
DC_1	Cutting diameter first cutting step
DC_2	Cutting diameter second cutting step







ISO 13399	description
DF	Flange diameter
DH	Head diameter
GPD	Guide pilot diameter
GPL	Guide pilot length
H	Shank height
HSD	Size of drive part
IC	Inscribed circle diameter
LCF	Length chip flute
LCOL	Collet length
LDC	Distance reference point PK
LH	Head length
LS	Shank length
LSC	Clamping length
NOF	Number of flutes
PLGL	Plug length
RCSK	Radius countersunk
RE	Corner radius
SDI	Step diameter increments
SDL	Step diameter length
SDL_1	Step diameter length first cutting step
SDL_2	Step diameter length second cutting step
TDZ	Thread diameter size
THLGTH	Thread length
WSC	Clamping width

NAVIGATOR TOOL MATERIALS





Tool materials

High Speed Steel		A medium-alloyed high speed steel that has good machinability and good performance. HSS exhibits hardness, toughness and wear resistance characteristics that make it attractive in a wide range of applications, for example in drills and taps.
Cobalt High Speed Steel		This high speed steel contains cobalt for increased hot hardness. The composition of HSCo is a good combination of toughness and hardness. It has good machinability and good wear resistance, which makes it usable for drills, taps, milling cutters and reamers.
Carbide and High Speed Steel		Combined carbide and high speed steel materials typically joined together with high temperature braze alloy as the interface. This brazed combination of tool materials offers a solid carbide cutting portion which provides high compression strength, hardness and wear resistance attached to a high speed steel body which provides flexural strength and toughness in the tool body.
Carbide Materials (or Hard Materials)		A sintered powder metallurgy substrate , consisting of a metallic carbide composite with binder metal. The most central raw material is tungsten carbide (WC). Tungsten carbide contributes to the hardness of the material. Tantalum carbide (TaC), titanium carbide (TiC) and niobium carbide (NbC) complements WC and adjusts the properties to what is desired. These three materials are called cubic carbides. Cobalt (Co) acts as a binder and keeps the material together. Carbide materials are often characterised by high compression strength, high hardness and therefore high wear resistance, but also by limited flexural strength and toughness. Carbide is used in taps, reamers, milling cutters, drills and thread milling cutters.









Surface Treatments

Bright (uncoated)		Bright finish (uncoated surface) improves chip flow in soft or non-ferrous materials, plastics and composites while maintaining sharp cutting edges.
Bright Nickel Plating		Bright Nickel Plated surface protects hardened steel body from rust, corrosion and also improves chip evacuation.
Combination Bright and Steam Tempered		Combination of bright and steam tempering can be effective as the blue oxide more porous surface acts to retain and pull cutting fluid into the hole while the bright surface assists in chip evacuation. This combination is achieved by grinding the bright surface after tempering.
Steam Tempering		Steam tempering gives a strongly adhering blue oxide surface that acts to retain cutting fluid and prevent chip to tool welding, thereby counteracting the formation of a built-up edge. Steam tempering can be applied to any bright tool but is most effective on drills and taps.
Bronze Tempering		Bronze tempering creates a smooth thin bronze oxide layer on the tool surface. Similar to Steam Tempering it helps to prevent chip to tool welding and aids in chip evacuation. Bronze tempering can be applied to any bright tool and can also be applied in combination with Steam Tempering on some tools.
Combination Steam and Bronze Tempered Surface Treatment		Combination of steam and bronze tempering can be effective, as the blue oxide more porous surface acts to retain and pull cutting fluid into the hole while the bronze surface assists in chip evacuation. Both surface treatments add a degree of surface protection to the tool. These combinations are achieved by using two different tempering cycles.

Surface Coatings

Bright and TiN (Tip Coating) Titanium Nitride (TiN)		Titanium Nitride is a gold coloured ceramic coating applied by physical vapor deposition (PVD). High hardness combined with low friction properties ensures longer tool life and/or better cutting performance over tools which have not been coated.
Titanium Aluminium Nitride coatings (TiAlN, TiAlN-Top & X-CEED)		Titanium Aluminium Nitride is a multi layer ceramic coating applied by PVD coating technology, which exhibits high toughness and oxidation stability. These properties make it ideal for higher speeds and feeds, while at the same time improving tool life. TiAlN is used in drilling, tapping, and milling applications and can be suitable for use when machining without coolant. TiAlN-Top coating is the same as TiAlN but with a post-coating process designed to smooth out imperfections, enhance chip flow and reduce built up edge.
Ti-phon (TiAlCrSiN)		Ti-phon Coating is a coating similar to TiAlN but with the addition of Chromium (Cr) and Silicon (Si) which is specially formulated for Hydra Heads to prevent edge build-up and greatly improve chip flow. This coating exhibits high hot hardness, high oxidation resistance and superior lubricity when used on tools for machining applications involving heavy mechanical and thermal stresses, high speeds and high feed rates. These coating properties translate into superior wear resistance and edge strength.
Aluminium Titanium Carbon Nitride (AlTiCN)		Aluminium Titanium Carbon-Nitride (AlTiCN) is a PVD coating which was specifically engineered to meet the rigorous requirements of the medical device industry. It is however equally applicable to certain cutting tool operations due to a high quality thin-film technology, with excellent micro-hardness and adhesion characteristics.

DRILLING GRADES

Grade Identification	Area of Application	Application	Feed	Cutting speed	Resistance to adverse Working Conditions	Coating	Colour	Substrate	Coolant benefit	Grade description
D9335	P20 - P35	■				MT-CVD	FGM	FGM	+++	This grade is recommended for the peripheral insert in indexable drills, it is more suited to higher cutting speeds and feeds.
	M15 - M30	■								
	K15 - K35	■								
	S10 - S20	▣								
D8330	P20 - P35	■				PVD	submicron H	submicron H	+++	This is a universal grade for the peripheral insert in indexable drills, it can be used for most materials and stands out for its operational reliability.
	M15 - M30	■								
	K15 - K35	■								
	S10 - S20	▣								
D8345	P30 - P50	■				PVD	submicron H	submicron H	+++	This grade is a universal grade for the central insert in indexable drills, it is an extremely tough suited to most materials.
	M20 - M40	■								
	K30 - K40	■								
	S20 - S30	▣								

Substrat

submicron H	WC-Co baserat substrat, finkornigt (< 1 µm)
FGM	Functionally graded substrate

Coating

MT-CVD	Medium-temperature chemical method of coating
PVD	Low-temperature physical method of coating

Benefits of cutting fluid

+++	Use of coolant is essential
-----	-----------------------------

SOLID CARBIDE & HSS DRILLS – TECHNICAL INFO

Drill Nomenclature

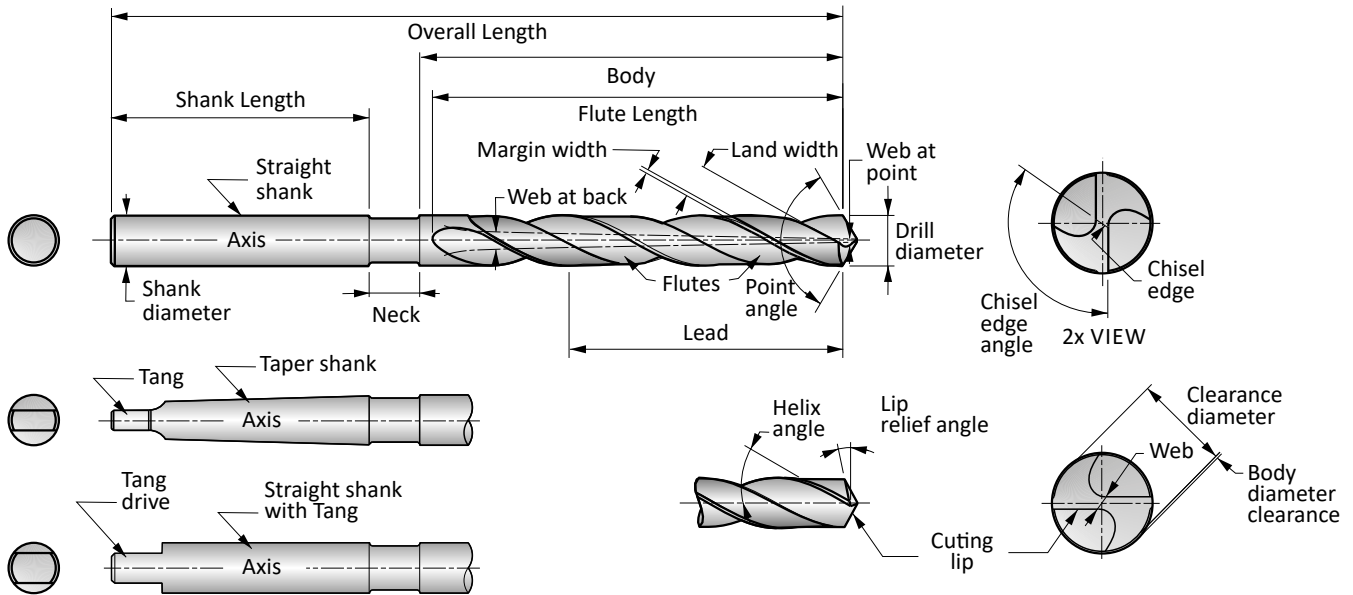

- **Axis** — The imaginary straight line which forms the longitudinal centre line of a drill.
- **Backtaper** — A slight decrease in diameter from front to back in the body of a drill.
- **Body** — The portion of a drill extending from the shank or neck to the outer corners of the cutting lips.
- **Body Clearance Diameter** — The portion of the land that has been cut away so it will not bind against the walls of the hole.
- **Chisel-Edge** — The edge at the end of the web that connects the cutting lips.
- **Chisel-Edge Angle** — The included angle between the chisel-edge and cutting lip, as viewed from the end of a drill.
- **Clearance Diameter** — The diameter over the cut away portion of the drill lands.
- **Drill** — A rotary end cutting tool having one or more cutting lips, and having one or more helical or straight flutes for the passage of chips and the admission of a cutting fluid.
- **Drill Diameter** — The diameter over the margins of a drill measured at the point.
- **Flute Length** — The length from the outer corners of the cutting lips to the extreme back of the flutes. Includes the sweep of the tool used to generate the flutes and therefore does not indicate the usable length of flutes.
- **Flutes** — Helical or straight grooves cut or formed in the body of a drill to provide cutting lips, permit removal of chips, and allow cutting fluid to reach the cutting lips.
- **Helix Angle** — The angle formed by the leading edge of the land with a plane containing the axis of a drill.
- **Land** — The peripheral portion of the body between adjacent flutes.
- **Land Width** — The distance between the leading edge and heel of the land; measured at a right angle to the leading edge.
- **Lead** — The axial advance of a leading edge of the land in one turn around the circumference.
- **Lip Relief Angle** — The axial relief angle at the outer corner of the lip; measured by projection to a plane tangent to the periphery at the outer corner of the lip.
- **Lips** — The cutting edges of a two flute drill extending from the chisel-edge to the periphery.
- **Margin** — The cylindrical portion of the land, which is not cut away, to provide clearance.
- **Neck** — The section of reduced diameter between the body and the shank of a drill.
- **Overall Length** — The length from the extreme end of the shank to the outer corners of the cutting lip. It does not include the conical shank end often used on straight shank drills, nor the conical cutting point used on both straight and taper shank drills.
- **Point** — The cutting end of a drill, made up of the ends of the lands and the web. In form, it resembles a cone, but departs from a true cone to furnish clearance behind the cutting lips.
- **Conventional** — Conventional Points with 118° included point angles are the most commonly used because they provide satisfactory results in a wide variety of materials. A possible limitation is that the straight chisel edge contributes to wandering at the drill point, often making it necessary to spot the hole for improved accuracy.

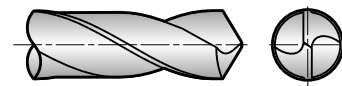

- **Split** — Split-Points (commonly called Crankshaft Points) were originally developed for use on drills designed for deep oil holes in automotive crankshafts. Since its inception, the split-point has gained widespread use and is applied to both 118° and 135° included point angles. Its main advantages are the ability to reduce thrust and eliminate wandering at the drill point. This is a distinct advantage when the drill is used in a portable drill or in drilling applications where bushings cannot be used. The split-point also has two positive rake cutting edges extending to the centre of the drill, which can assist as a chipbreaker to produce small chips which can readily be ejected.

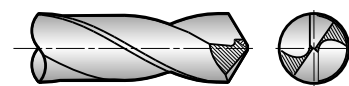

SOLID CARBIDE & HSS DRILLS – TECHNICAL INFO

- Notched** — Notched Points were developed for drilling tough alloys. Commonly incorporated on heavy web drills, which allow the point to withstand the higher thrust loads required in drilling these materials. As with the split-point, the Notched Point contains two additional positive rake cutting edges extending toward the centre of the drill. These secondary cutting lips, which extend no further than half the original cutting lip, can assist in chip control and reduce the torque required in drilling tough materials. Notched Points can be incorporated on both 118° and 135° included point angles, making them suitable for drilling a wide variety of materials.

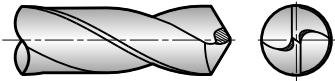

- Point Angle** — The included angle between the cutting lips projected upon a plane parallel to the drill axis and parallel to the two cutting lips.
- Relative Lip Height** — The difference in indicator reading between the cutting lips of a drill. Measured at a right angle to the cutting lip at a specific distance from the axis of the tool.
- Shank** — The part of a drill by which it is held and driven.
- Tang** — The flattened end of a taper shank, intended to fit into a driving slot in a socket.
- Tang Drive** — Two opposite parallel driving flats on the extreme end of a straight shank.
- Taper Shank** — Drills having conical shanks suitable for direct fitting in machine spindles, driving sleeves, or sockets. Tapered shanks generally have a tang.
- Web** — The central portion of the body that joins the lands. The extreme end of the web forms the chisel-edge on a two flute drill.
- Web Thickness** — The thickness of the web at the point, unless another specific location is indicated.

General hints on drilling

- Select the most appropriate drill for the application, bearing in mind the material to be machined, the capability of the machine tool and the coolant to be used.
- Flexibility within the component and machine tool spindle can cause damage to the drill as well as the component and machine - ensure maximum stability at all times. This can be improved by selecting the shortest possible drill for the application.
- Tool holding is an important aspect of the drilling operation and the drill cannot be allowed to slip or move in the tool holder.
- The correct use of Morse Taper Shank drills relies on an efficient fit between the taper surfaces of the tool and the tool holder. The use of a soft-faced hammer should be used to drive the drill into the holder.
- The use of suitable coolants and lubricants are recommended as required by the particular drilling operation. When using coolants and lubricants, ensure a copious supply, especially at the drill point.
- Swarf evacuation whilst drilling is essential in ensuring the correct drilling procedure. Never allow the swarf to become stationary in the flute.
- When regrinding a drill, always make sure that the correct point geometry is produced and that any wear has been removed.

DRILLING FEED RATE CHART

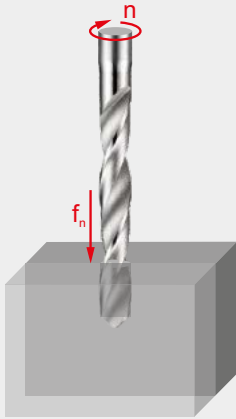

Feed per revolution (f_n in mm/rev)
Depending on the working conditions
it might be necessary to adjust these
values $\pm 25\%$.

How to use this table to find the feed per revolution (f_n):

1. Find your Alpha Code on the product page (example: 46J, "J" is the Alpha Code).
2. Find the closest diameter for your cutting application in the top row of the table.
3. Find your Alpha Code in the left column of the table.
4. The intersection (cell) of the Diameter and Alpha Code is the feed per revolution (f_n).

		\varnothing DC (mm)																		
		0.15	0.50	1.00	2.00	3.00	4.00	5.00	6.00	8.00	10.00	12.00	15.00	16.00	20.00	25.00	30.00	40.00	50.00	100.00
Feed rates (mm/rev)	A	0.003	0.006	0.012	0.023	0.029	0.032	0.036	0.042	0.054	0.062	0.069	0.082	0.086	0.110	0.125	0.135	0.155	0.175	0.263
	B	0.004	0.007	0.014	0.028	0.037	0.041	0.046	0.053	0.067	0.080	0.090	0.103	0.108	0.135	0.153	0.165	0.188	0.208	0.312
	C	0.004	0.008	0.015	0.032	0.044	0.050	0.056	0.064	0.080	0.098	0.110	0.125	0.130	0.160	0.180	0.195	0.220	0.240	0.360
	D	0.004	0.008	0.016	0.038	0.053	0.060	0.068	0.078	0.098	0.119	0.130	0.149	0.155	0.188	0.210	0.228	0.253	0.275	0.413
	E	0.004	0.009	0.017	0.043	0.062	0.071	0.080	0.092	0.115	0.140	0.150	0.173	0.180	0.215	0.240	0.260	0.285	0.310	0.465
	F	0.005	0.009	0.018	0.050	0.073	0.084	0.095	0.109	0.138	0.165	0.178	0.202	0.210	0.248	0.275	0.295	0.320	0.343	0.515
	G	0.005	0.010	0.019	0.056	0.084	0.096	0.109	0.126	0.160	0.190	0.205	0.231	0.240	0.280	0.310	0.330	0.355	0.375	0.563
	H	0.005	0.010	0.020	0.066	0.102	0.116	0.130	0.150	0.190	0.228	0.243	0.271	0.280	0.320	0.355	0.375	0.398	0.418	0.627
	I	0.005	0.011	0.021	0.076	0.119	0.134	0.150	0.173	0.220	0.265	0.280	0.310	0.320	0.360	0.400	0.420	0.440	0.460	0.690
	J	0.006	0.012	0.024	0.084	0.135	0.152	0.170	0.197	0.250	0.298	0.315	0.349	0.360	0.405	0.445	0.465	0.485	0.503	0.755
	K	0.007	0.013	0.026	0.092	0.150	0.170	0.190	0.220	0.280	0.330	0.350	0.388	0.400	0.450	0.490	0.510	0.530	0.545	0.818
	L	0.007	0.014	0.028	0.101	0.165	0.186	0.208	0.240	0.305	0.360	0.385	0.419	0.430	0.485	0.525	0.545	0.568	0.588	0.882
	M	0.008	0.015	0.030	0.110	0.180	0.202	0.225	0.260	0.330	0.390	0.420	0.450	0.460	0.520	0.560	0.580	0.605	0.630	0.945
	N	0.008	0.016	0.032	0.119	0.195	0.218	0.242	0.280	0.355	0.420	0.455	0.481	0.490	0.555	0.595	0.615	0.642	0.672	1.008
	S	0.002	0.004	0.008	0.014	0.020	0.025	0.030	0.037	0.050	0.080	0.100	0.123	0.130	0.150	0.170	0.190	0.220	0.240	–
	T	0.004	0.008	0.015	0.028	0.040	0.050	0.060	0.070	0.090	0.110	0.130	0.160	0.170	0.190	0.210	0.230	0.260	0.275	–
	U	0.007	0.013	0.026	0.048	0.070	0.080	0.090	0.107	0.140	0.170	0.200	0.223	0.230	0.240	0.270	0.300	0.360	0.375	–
	V	0.010	0.019	0.038	0.069	0.100	0.115	0.130	0.153	0.200	0.250	0.280	0.310	0.320	0.340	0.400	0.440	0.510	0.530	–
	W	0.012	0.025	0.049	0.089	0.130	0.150	0.170	0.200	0.260	0.330	0.380	0.418	0.430	0.450	0.470	0.490	0.520	0.540	–
	X	0.014	0.028	0.056	0.103	0.150	0.180	0.210	0.250	0.330	0.420	0.480	0.533	0.550	0.580	–	–	–	–	–
Y	0.017	0.034	0.068	0.124	0.180	0.220	0.260	0.317	0.430	0.550	0.700	0.700	0.700	0.740	–	–	–	–	–	
Z	0.024	0.047	0.094	0.172	0.250	0.325	0.400	0.533	0.800	1.000	1.100	1.175	1.200	1.200	–	–	–	–	–	

Formulas (Metric)		Terms		Formulas (Imperial)	
$v_c = \frac{n \times DC \times \pi}{1000}$	v_c (m/min)	Cutting speed	<i>SFM</i> (ft/min)	$SFM = \frac{RPM \times DC \times \pi}{12}$ $RPM = \frac{SFM \times 12}{DC \times \pi}$ $IPM = IPT \times T \times RPM$ $IPT = \frac{IPM}{T \times RPM}$ $MRR = IPM \times DOC \times WOC$	
$n = \frac{v_c \times 1000}{DC \times \pi}$	n (rev/min)	Spindle speed	<i>RPM</i> (rev/min)		
$V_f = f_z \times z \times n$	V_f (mm/min)	Feed rate	<i>IPM</i> (in/min)		
$f_z = \frac{V_f}{z \times n}$	f_z (mm/tooth)	Feed per tooth	<i>IPT</i> (in/tooth)		
$Q = \frac{V_f \times a_p \times a_e}{1000}$	DC (mm)	Cutting diameter	<i>DC</i> (in)		
	z (–)	Number of teeth	<i>T</i> (–)		
	a_p (mm)	Depth of cut	<i>DOC</i> (in)		
	a_e (mm)	Width of cut	<i>WOC</i> (in)		
	Q (cm ³ /min)	Metal removal rate	<i>MRR</i> (in ³ /min)		

GENERAL – TECHNICAL INFO

Table of Cutting Speeds

		Vc															
m/min.		5	8	10	15	20	25	30	40	50	60	70	80	90	100	110	150
SFM (feet/min.)		16	26	32	50	66	82	98	130	165	197	230	262	296	330	362	495
Ø		RPM															
mm	inch																
1.00	–	1592	2546	3183	4775	6366	7958	9549	12732	15916	19099	22282	25465	28648	31831	35014	47747
1.50	–	1061	1698	2122	3183	4244	5305	6366	8488	10610	12732	14854	16977	19099	21221	23343	31831
2.00	–	796	1273	1592	2387	3183	3979	4775	6366	7958	9549	11141	12732	14324	15916	17507	23873
2.50	–	637	1019	1273	1910	2546	3183	3820	5093	6366	7639	8913	10186	11459	12732	14006	19099
3.00	–	531	849	1061	1592	2122	2653	3183	4244	5305	6366	7427	8488	9549	10610	11671	15916
3.18	1/8	500	801	1001	1501	2002	2502	3003	4004	5005	6006	7007	8008	9009	10010	11011	15015
3.50	–	455	728	909	1364	1819	2274	2728	3638	4547	5457	6366	7276	8185	9095	10004	13642
4.00	–	398	637	796	1194	1592	1989	2387	3183	3979	4775	5570	6366	7162	7958	8754	11937
4.50	–	354	566	707	1061	1415	1768	2122	2829	3537	4244	4951	5659	6366	7074	7781	10610
4.76	3/16	334	535	669	1003	1337	1672	2006	2675	3344	4012	4681	5350	6018	6687	7356	10031
5.00	–	318	509	637	955	1273	1592	1910	2546	3183	3820	4456	5093	5730	6366	7003	9549
6.00	–	265	424	531	796	1061	1326	1592	2122	2653	3183	3714	4244	4775	5305	5836	7958
6.35	1/4	251	401	501	752	1003	1253	1504	2005	2506	3008	3509	4010	4511	5013	5514	7519
7.00	–	227	364	455	682	909	1137	1364	1819	2274	2728	3183	3638	4093	4547	5002	6821
7.94	5/16	200	321	401	601	802	1002	1203	1604	2004	2405	2806	3207	3608	4009	4410	6013
8.00	–	199	318	398	597	796	995	1194	1592	1989	2387	2785	3183	3581	3979	4377	5968
9.00	–	177	283	354	531	707	884	1061	1415	1768	2122	2476	2829	3183	3537	3890	5305
9.53	3/8	167	267	334	501	668	835	1002	1336	1670	2004	2338	2672	3006	3340	3674	5010
10.00		159	255	318	477	637	796	955	1273	1592	1910	2228	2546	2865	3183	3501	4775
11.11	7/16	143	229	287	430	573	716	860	1146	1433	1719	2006	2292	2579	2865	3152	4298
12.00		133	212	265	398	531	663	796	1061	1326	1592	1857	2122	2387	2653	2918	3979
12.70	1/2	125	201	251	376	501	627	752	1003	1253	1504	1754	2005	2256	2506	2757	3760
14.00		114	182	227	341	455	568	682	909	1137	1364	1592	1819	2046	2274	2501	3410
14.29	9/16	111	178	223	334	446	557	668	891	1114	1337	1559	1782	2005	2228	2450	3341
15.00	–	106	170	212	318	424	531	637	849	1061	1273	1485	1698	1910	2122	2334	3183
15.88	5/8	100	160	200	301	401	501	601	802	1002	1203	1403	1604	1804	2004	2205	3007
16.00	–	99	159	199	298	398	497	597	796	995	1194	1393	1592	1790	1989	2188	2984
17.46	11/16	91	146	182	273	365	456	547	729	912	1094	1276	1458	1641	1823	2005	2735
18.00	–	88	141	177	265	354	442	531	707	884	1061	1238	1415	1592	1768	1945	2653
19.05	3/4	84	134	167	251	334	418	501	668	835	1003	1170	1337	1504	1671	1838	2506
20.00	–	80	127	159	239	318	398	477	637	796	955	1114	1273	1432	1592	1751	2387
24.00	–	66	106	133	199	265	332	398	531	663	796	928	1061	1194	1326	1459	1989
25.00	–	64	102	127	191	255	318	382	509	637	764	891	1019	1146	1273	1401	1910
27.00	–	59	94	118	177	236	295	354	472	589	707	825	943	1061	1179	1297	1768
30.00	–	53	85	106	159	212	265	318	424	531	637	743	849	955	1061	1167	1592
32.00	–	50	80	99	149	199	249	298	398	497	597	696	796	895	995	1094	1492
36.00	–	44	71	88	133	177	221	265	354	442	531	619	707	796	884	973	1326
40.00	–	40	64	80	119	159	199	239	318	398	477	557	637	716	796	875	1194
50.00	–	32	51	64	95	127	159	191	255	318	382	446	509	573	637	700	955

REAMING – TECHNICAL INFO

Reamer Definitions / Nomenclature

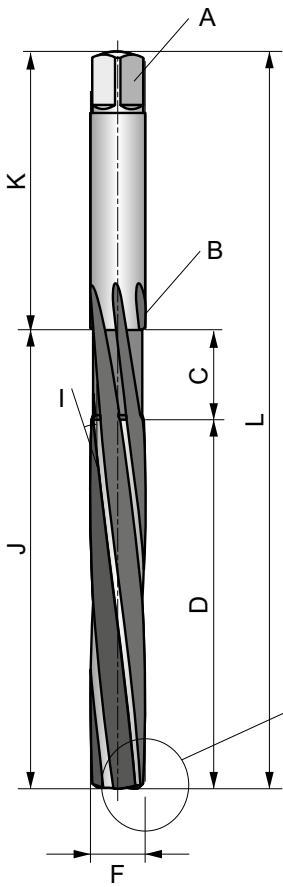

A	Tang or Square Drive	G	Bevel Lead
B	Recess Diameter	H	Bevel Lead Angle
C	Recess Length	I	Helix Angle
D	Cut Length	J	Body Length
E	Bevel Lead Length	K	Shank Length
F	Diameter	L	Overall Length

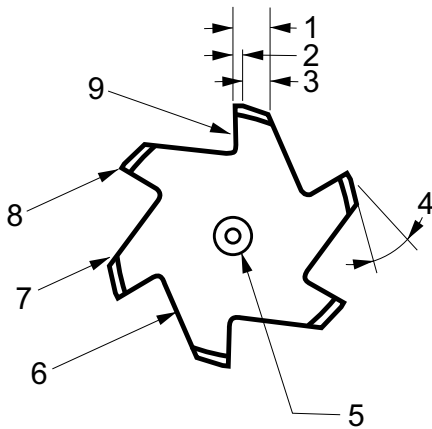
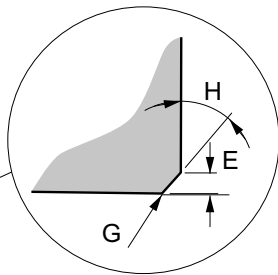

1	Width of Land
2	Circular Land
3	Clearance
4	Clearance Angle
5	Centre Hole
6	Flute
7	Heel
8	Cutting Edge
9	Face

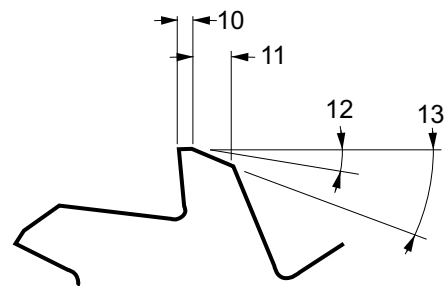

10	Width of Primary Clearance
11	Width of Secondary Clearance
12	Primary Clearance Angle
13	Secondary Clearance Angle

REAMING – TECHNICAL INFO

Brotschning

För att uppnå bästa resultat vid brotschning är det viktigt att brotschen kan skära. Ett vanligt fel är att för liten arbetsmån har lämnats till brotschningen. I dessa fall skär inte brotschen utan skaver bort materialet med högt slitage som följd. Det är lika viktigt att inte lämna för mycket material till brotschen. (Se tabell Arbetsmån).

1. Välj bästa brotschtyp för applikationen. Välj skärdata utifrån materialtyp. Säkerställ att de förborrade hålen har rätt diameter.
2. Kontrollera att arbetsstycket sitter fast ordentligt och att maskinspindeln är spelfri.
3. Använd en lämplig chuck av bra kvalitet. Om brotschen slirar i chucken kan det orsaka brott.
4. Håll verktyget så kort som möjligt.

5. Använd en skärvätska av lämplig typ, riktad mot brotschen för att få bästa livslängd. Eftersom brotschning är en ganska lätt operation räcker det oftast med en vattenlöslig skärvätska utspädd 40:1. Tryckluft är användbar vid gjutjärn om man vill köra torr.
6. Se till att inte spånstockning uppstår i spåren.
7. Kontrollera rundgången mellan dubbar före omslipning. Oftast räcker det att slipa om skärfasen.
8. Håll brotschen skarp. Regelbunden omslipning lönar sig, men det är viktigt att förstå att brotschen skär enbart med fasen eller ingångskonan och inte med resten av skärlängden. Således behöver endast den fasade eller koniska delen slipas. Noggrannhet vid omslipning är viktig för att bibehålla kvalitet och livslängd.

Arbetsmån

Arbetsmånen vid brotschning beror på material och ytfinhet i det förborrade hålet. Allmänna rekommendationer finns i tabellen nedan:

Diameter på brotschat hål (mm)	Förborrat hål	Förborrat + upprymt hål
Under 4	0.1	0.1
4 tom 11	0.2	0.15
11 tom 39	0.3	0.2
39 tom 50	0.4	0.3

Diameter på brotschat hål (tum)	Förborrat hål	Förborrat + upprymt hål
Under 3/16"	0.004"	0.004"
3/16" tom 1/2"	0.008"	0.006"
1/2" tom 1.1/2"	0.010"	0.008"
1.1/2" tom 2"	0.016"	0.010"

Hand/Machine reaming

Although both hand and machine reamers offer the same capability regarding finished hole size, the use of each must be considered according to the application. A hand reamer, for reasons of alignment, has a long taper lead, whereas a machine reamer has only a 45 degree bevel lead. A machine reamer cuts only on the bevel lead while a hand reamer cuts on the bevel lead as well as the taper lead.

The most common types of reamers have a left-hand spiral because the main applications involve through holes requiring chips to be pushed forward. For blind holes, reamers with straight flutes or right hand spirals are recommended.

The most efficient reaming conditions depend on the application, material, quality of hole required, stock removal, lubrication and other factors. A general guide to surface speeds and feeds for

machine reamers is shown in the reamer WMG and feed charts (see Product Selector) and stock removal tables.

Extremely unequal spacing on reamers means that the divide is not the same for each tooth. As there are no two teeth diametrically opposite each other, the reamer produces a hole with a roundness variance of between 1 and 2 µm. This compared with a variance of up to 10µm with conventional unequal spacing.

Carbide Reamers – Comparison spacing / EU spacing

Unequal spacing
Roundness error up to 10 µm

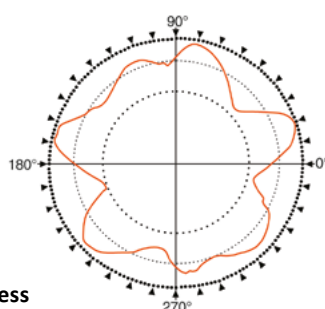

Results of roundness

Extremely unequal spacing
Roundness error up to 1 – 2 µm

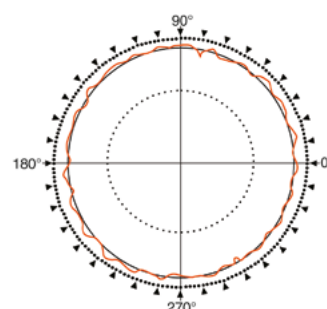

Results of roundness

REAMING – TOLERANCE LIMITS – TECHNICAL INFO

Toleransgränser

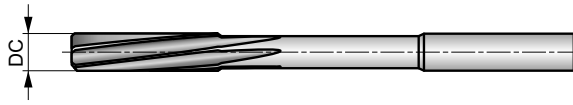

1. För skärdiametern på standardbrotschar

Diametern (DC) mäts över styrkanterna omedelbart bakom skärfasen eller ingångskonan. Brotschens tolerans överensstämmer med DIN1420 och är avsedd att ge ett hål med H7-tolerans.

Brotschtolerans			
Diameter (mm)		Toleransgräns (mm)	
Över	Till och med	Övre +	Undre +
-	3	0.008	0.004
3	6	0.010	0.005
6	10	0.012	0.006
10	18	0.015	0.008

Brotschtolerans			
Diameter (mm)		Toleransgräns (mm)	
Över	Till och med	Övre +	Undre +
18	30	0.017	0.009
30	50	0.021	0.012
50	80	0.025	0.014

2. För ett h7-hål

Den vanligaste håltoleransen är H7 (se tabell nedan). För andra toleranser kan figur och tabell under punkt 3 användas för att beräkna brotschens mått och tolerans.

Håltolerans			
Diameter (mm)		Toleransgräns (mm)	
Över	Till och med	Övre +	Undre +
-	3	0.010	0
3	6	0.012	0
6	10	0.015	0
10	18	0.018	0

Håltolerans			
Diameter (mm)		Toleransgräns (mm)	
Över	Till och med	Övre +	Undre +
18	30	0.021	0
30	50	0.025	0
50	80	0.030	0

3. När man behöver en specialbrotsch, avsedd för en specifik håltolerans, t ex D8, kan den här guiden användas.

Toleransvidd (μ)	Diametertoleransvidd (μm)							
	över 1 tom 3	över 3 tom 6	över 6 tom 10	över 10 tom 18	över 18 tom 30	över 30 tom 50	över 50 tom 80	över 80 tom 120
IT5	4	5	6	8	9	11	13	15
IT6	6	8	9	11	13	16	19	22
IT7	10	12	15	18	21	25	30	35
IT8	14	18	22	27	33	39	46	54
IT9	25	30	36	43	52	62	74	87
IT10	40	48	58	70	84	100	120	140
IT11	60	75	90	110	130	160	190	220
IT12	100	120	150	180	210	250	300	350

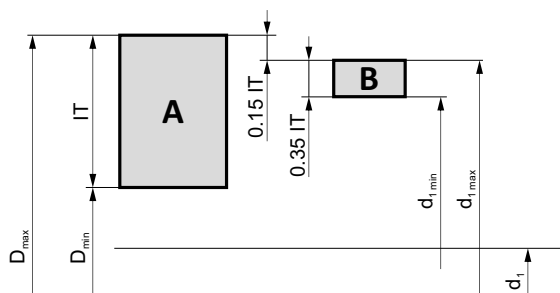

A = Håltolerans
B = Brotschtolerans
IT = Toleransvidd
 D_{max} = Max. håldiameter
 D_{min} = Min. håldiameter
 d_1 = Nominell diameter
 d_{1max} = Max. brotschdiameter
 d_{1min} = Min. brotschdiameter

t ex 10 mm hål med D8-tolerans, Max. diam. = 10,062, Min. diam. 10,040, Håltol. (IT8) = 0,022

Max.gräns: 0,15 x håltolerans (IT8) = 0,0033, avrundas uppåt till 0,004

Min.gräns: 0,35 x håltolerans (IT8) = 0,0077, avrundas uppåt till 0,008

Max. diameter för brotschen = 10,062 - 0,004 = 10,058

Min.diameter för brotschen = 10,058 - 0,008 = 10,050

REAMERS FEED RATE CHART

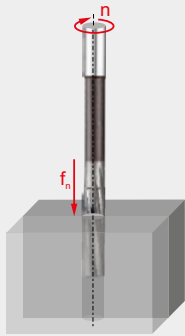

Feed per revolution (f_n in mm/rev)
Depending on the working conditions it might be necessary to adjust these values $\pm 15\%$.

How to use this table to find the feed per revolution (f_n):

1. Find your Alpha Code on the product page (example: 21C, "C" is the Alpha Code).
2. Find the closest diameter for your cutting application in the top row of the table.
3. Find your Alpha Code in the left column of the table.
4. The intersection (cell) of the Diameter and Alpha Code is the feed per revolution (f_n).

		\varnothing DC (mm)																		
		1.00	1.50	2.00	3.00	4.00	5.00	6.00	7.00	8.00	10.00	12.00	15.00	16.00	20.00	25.00	30.00	40.00	50.00	80.00
Feed rates (mm/rev)	A	0.030	0.045	0.055	0.078	0.090	0.100	0.125	0.137	0.150	0.170	0.185	0.210	0.220	0.250	0.280	0.320	0.390	0.440	0.500
	B	0.035	0.055	0.072	0.110	0.130	0.150	0.165	0.172	0.180	0.210	0.240	0.270	0.280	0.310	0.360	0.400	0.500	0.550	0.600
	C	0.040	0.065	0.085	0.135	0.160	0.185	0.200	0.210	0.220	0.260	0.285	0.325	0.335	0.390	0.440	0.480	0.600	0.680	0.750
	D	0.050	0.080	0.110	0.160	0.180	0.200	0.235	0.253	0.270	0.320	0.360	0.400	0.410	0.470	0.540	0.600	0.730	0.850	0.950
	E	0.065	0.100	0.140	0.180	0.215	0.250	0.300	0.325	0.350	0.390	0.430	0.485	0.500	0.530	0.640	0.750	0.910	1.100	1.200
	F	0.090	0.140	0.180	0.260	0.305	0.350	0.395	0.417	0.440	0.500	0.550	0.610	0.630	0.700	0.800	0.930	1.200	1.500	1.650

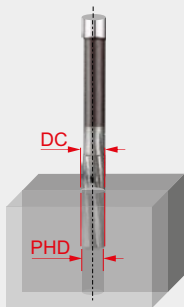

Machining allowance when using a **machine reamer** (MA in mm)
Premachined hole diameter
 $PHD = DC - MA$.

How to use this table to get to the right premachined hole diameter (PHD):

1. Find the diameter range for your cutting application in the top row of the table.
2. Find your ISO Group Code in the left column of the table (example: For Stainless Steel the ISO Group Code is "M")
3. The intersection (cell) of the Diameter Range and ISO Group Code is the Machining Allowance (MA)
4. Subtract the Machining Allowance from the reaming diameter to get to the premachined hole diameter (PHD).

(example: for a 6mm hole in steel (P) the PHD is 5.85mm)

		\varnothing DC (mm)											
		1.00	5.00	5.00	8.00	8.00	12.00	12.00	16.00	16.00	30.00	30.00	80.00
ISO group	P	0.10			0.15		0.20		0.20		0.30		0.30
	M	0.08			0.10		0.10		0.20		0.20		0.30
	K	0.10			0.15		0.20		0.20		0.30		0.30
	N	0.10			0.15		0.20		0.20		0.30		0.30
	S	0.05			0.10		0.10		0.15		0.20		0.20
	H	0.05			0.05		0.10		0.10		0.15		0.20

Be cautious with the machining tolerances of drills, the tool diameter is not the same as the hole diameter produced!

Note: The recommended allowance when using a hand reamer is 0.05 to 0.10 mm.

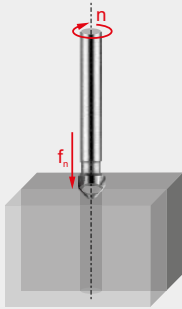
**COUNTERSINKS FEED RATE CHART**

Feed per revolution (f_n in mm/rev)
Depending on the working conditions
it might be necessary to adjust these
values $\pm 15\%$.





How to use this table to find the feed per revolution (f_n):

1. Find your Alpha Code on the product page (example: 23E, "E" is the Alpha Code).
2. Find the closest diameter for your cutting application in the top row of the table.
3. Find your Alpha Code in the left column of the table.
4. The intersection (cell) of the Diameter and Alpha Code is the feed per revolution (f_n).

		\varnothing DC (mm)									
		6.00	8.00	10.00	16.00	20.00	25.00	32.00	40.00	60.00	80.00
Feed rates (mm/rev)	A	0.030	0.040	0.050	0.060	0.080	0.090	0.100	0.120	0.140	0.160
	B	0.040	0.050	0.060	0.080	0.100	0.120	0.140	0.160	0.180	0.200
	C	0.050	0.060	0.080	0.100	0.120	0.140	0.160	0.180	0.200	0.220
	D	0.060	0.080	0.100	0.120	0.150	0.180	0.200	0.220	0.250	0.280
	E	0.080	0.100	0.120	0.150	0.180	0.200	0.250	0.270	0.300	0.320
	F	0.090	0.110	0.130	0.160	0.190	0.210	0.260	0.290	0.330	0.360
	G	0.100	0.120	0.150	0.180	0.200	0.220	0.280	0.320	0.360	0.400
	H	0.120	0.150	0.180	0.200	0.220	0.250	0.300	0.350	0.400	0.450

HYDRA – TECHNICAL INFO

Torque table

					Torque Values Nm (Metric System)	Torque Values in/lbs (Inch System)
H860	H861	Hydra Head ø Metric Range	Hydra Head ø Fractional Range	Hydra Head ø Decimal Size Range (min. / max.)		
H860N1	H861N1	12.0 mm – 15.5 mm	15/32" – 39/64"	0.4688" – 0.6102"	0.75 – 0.99	6.6 – 8.8
H860N2	H861N2	15.6 mm – 18.5 mm	5/8" – 23/32"	0.6142" – 0.7283v	0.93 – 1.24	8.2 – 11.0
H860N3	H861N3	18.6 mm – 21.5 mm	47/64" – 27/32"	0.7323" – 0.8465"	1.84 – 2.44	16.3 – 21.6
H860N4	H861N3	22.0 mm – 24.5 mm	55/64" – 31/32"	0.8594" – 0.9688"	2.73 – 3.72	24.2 – 32.9
H860N5	H861N4	25.0 mm – 27.5 mm	63/64" – 1-3/32"	0.9843" – 1.0938"	4.14 – 5.52	36.6 – 48.8
H860N6	H861N5	28.0 mm – 33.5 mm	1-7/64" – 1-19/64"	1.1024" – 1.3189"	4.97 – 6.63	44.0 – 58.7
H860N7	H861N6	34.0 mm – 42.0 mm	1-11/32" – 1-5/8"	1.3386" – 1.6535"	7.2	63.7

Screws and screw-driver data

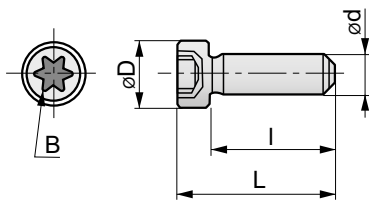

e-code	d	Pitch	L (mm)	I (mm)	D (mm)	B
H860N1	M2.2	0.45	7.5	5.7	3.5	8IP
H860N2	M2.5	0.45	9.0	7.0	4.1	10IP
H860N3	M3.0	0.50	10.5	8.0	4.9	15IP
H860N4	M3.5	0.60	11.5	8.8	5.5	15IP
H860N5	M4.0	0.70	12.5	9.5	6.0	20IP
H860N6	M4.5	0.75	14.3	10.8	6.8	25IP

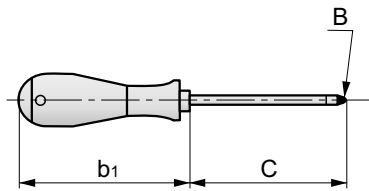

e-code	B	C	b ₁
H861N1	8IP	60	104
H861N2	10IP	80	111
H861N3	15IP	80	111
H861N4	20IP	100	118
H861N5	25IP	100	118

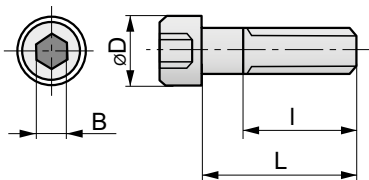

e-code	d	Pitch	L (mm)	I (mm)	D (mm)	B
H860N7	M5.0	0.8	15	full	8.5	4

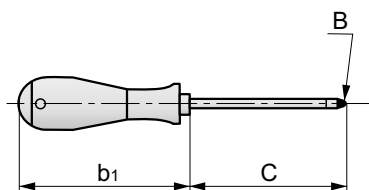

e-code	B	C	b ₁
H861N6	4	75	111

HYDRA – TECHNICAL INFO

Apply special programming for 8xD and 12xD drilling

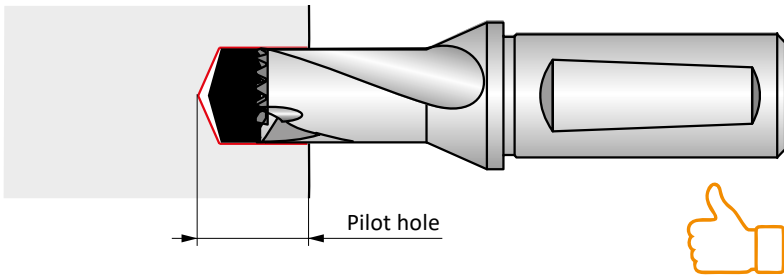

Drill a pilot hole (1.5xD to 3xD depth) with the same HYDRA head diameter (if needed check the runout of the drill max. +/- 0.05 mm).

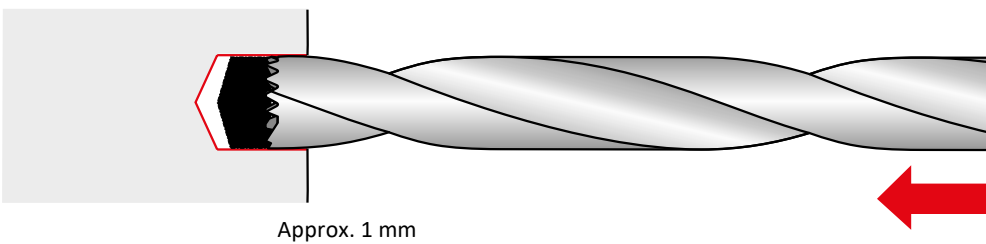

Enter the pilot hole with the 8xD or 12xD Body running a maximum of 500 rpm, to approximately 1mm above the pre-drilled pilot hole depth.

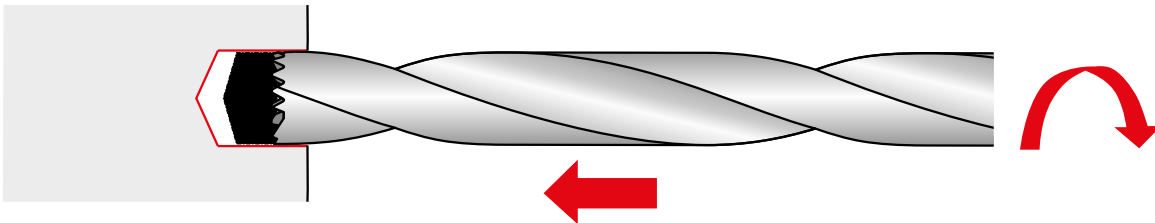

Start coolant flow and increase the rotational speed up to the recommended RPM.

Note: Apply a short dwell time don't start the feed before recommended RPM is reached.

Drill without pecking to the required depth.

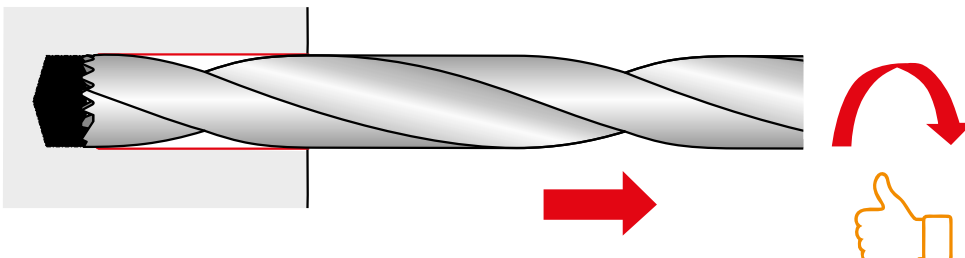

When the required depth is reached, retract the drill by approximately 0.1 mm to 0.5 mm and reduce to 500 rpm followed by a complete retraction with normal feed. **Note: retracting the drill with a higher spindle speed may cause a shoulder damage from run out or destroy the hole surface and tolerance.**

HYDRA – TECHNICAL INFO

Drilling hints & tips with the hydra drill

Coolants

For maximum chip evacuation and tool performance, coolant use is recommended. Emulsion coolant concentration of 6 – 8% is recommended for most applications, with a coolant pressure of 20 bar (290 PSI) or higher. For high strength steel, stainless steels and tougher drilling applications, use a higher concentration of 10 – 12%. In these applications, particularly in stainless steels, it is recommended to use the maximum coolant pressure on the machine. The Hydra-drill coolant holes provide improved web strength and reduce heat at the cutting edges for increased productivity and longer tool life.

Holders

Always use tool holders and collets that provide good concentricity

between the drill and the machine spindle. Use a positive stop to prevent the tool from backing up into the holder. Radial runout in the tool assembly must be accurately checked and maintained.

Workpiece

A secure and rigid workpiece will minimise deflection, and allow for better accuracy and true position of the hole.

Feeds

It is important not to underfeed the drill which will cause it to dwell and dull. This is particularly true in work hardening materials. Feed rates should be high enough for proper chip formation.

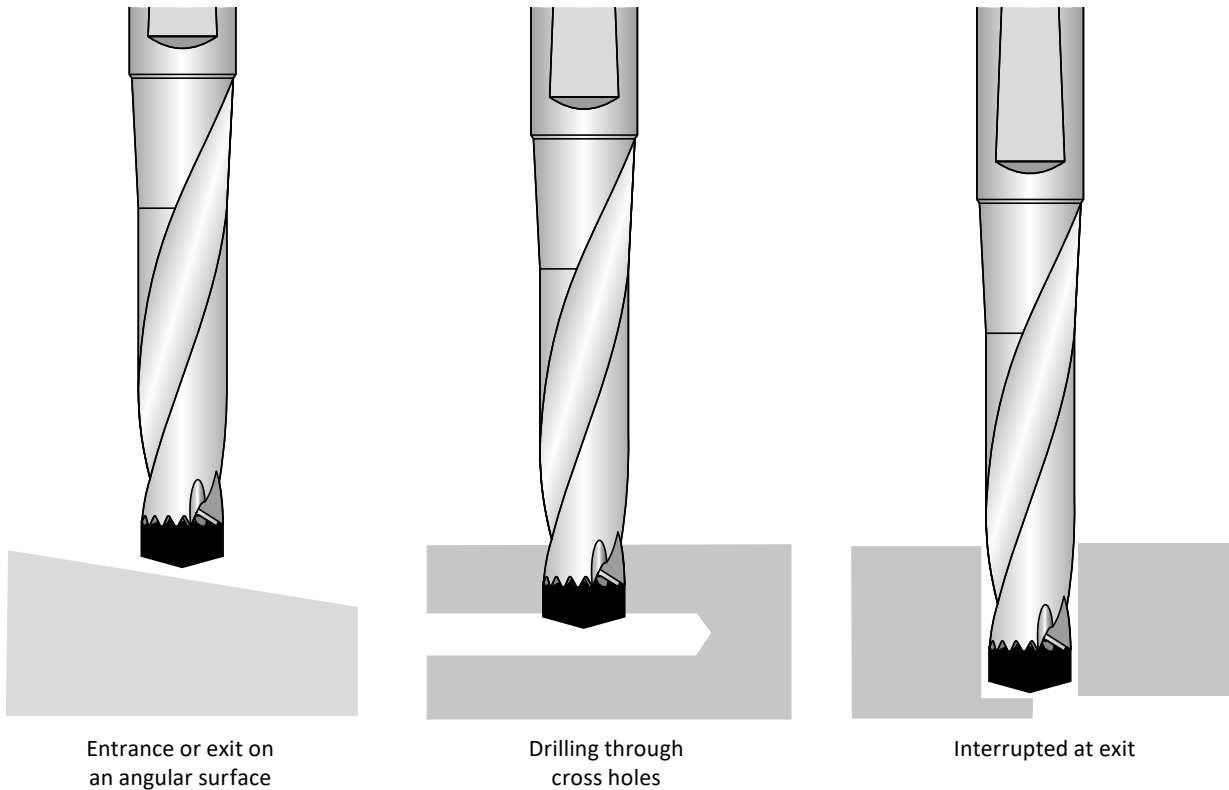

In these drilling scenarios, reducing feed rate to 1/3 (33%) is generally recommended. Drilling into an entry angle of more than 10° is NOT recommended – surface should be milled flat first.

BEARBETNINGSDATA FÖR VÄNSKÄRSBORRAR

Radiell justering

Justering av håldiametern och inställningsrekommendationer

Radiell justering kan göras med vänskärsborr för att göra hålet mindre än borrets diameter.

Värden för radiell justering finns i borrdatabellerna.

Roterande verktyg

För att borra hål med tolerans IT10 och högre bör man använda de justerbara hållarna tillsammans med 802D, 803D, 804D och 805D-borrarna.

Stillastående borr

Se till att borrets centrum ligger i linje med arbetsstyckets rotationscentrum.

För att öka håldiametern förflyttas borret så att dess yttre skär flyttas ut från arbetsstyckets rotationscentrum.

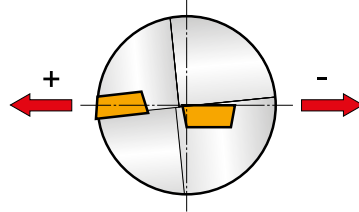

Verktyslängd

Vänskären bör bytas/vändas när fasförslitningen är 0,2 – 0,4mm på mest slitna stället.

Skärdatarekommendationerna i den här katalogen grundar sig på en uppskattad borrlängd på 7 meter för det yttre skäret (20-30 min ingrepp).

EP

JUSTERBAR HYLSA

Skaftdiam.	Borrdiam.	Område
25	15 – 24	+0.4 – -0.2
32	24.5 – 40	+0.4 – -0.2

För fräsmaskiner

Justerbart diameterområde

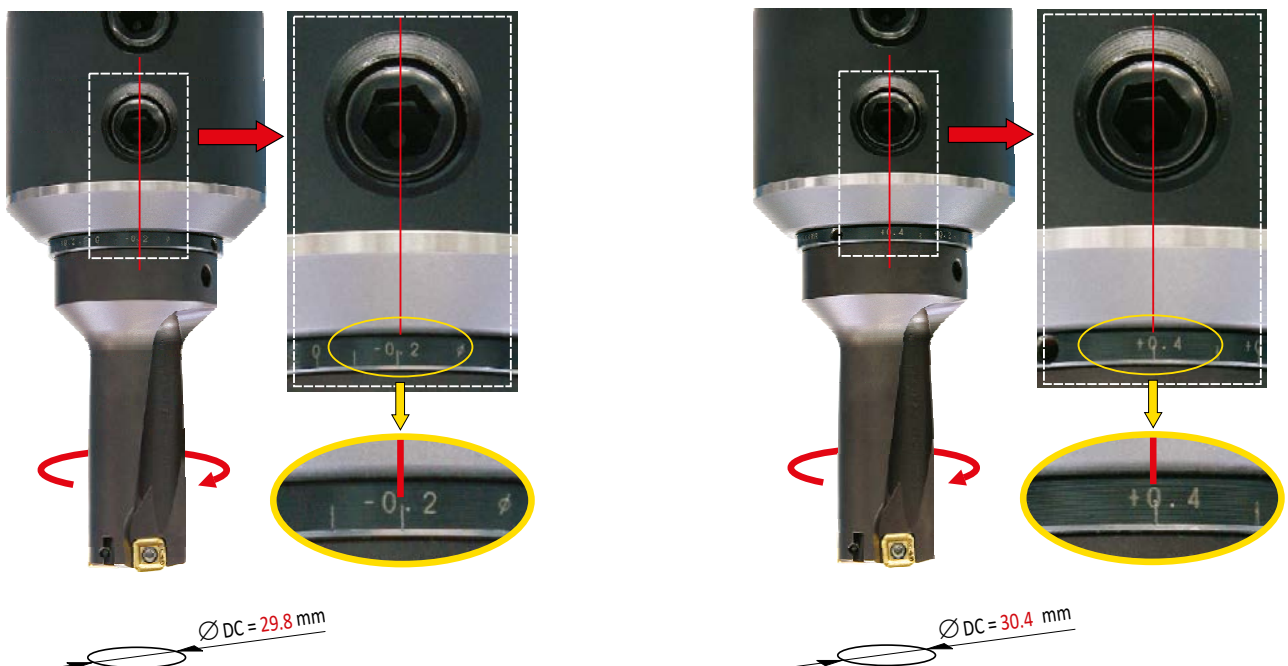

EP

JUSTERBAR HYLSA

Skaftdiam.	Borrdiam.	Område
25	15 – 24	+0.2 – -0.15
32	24.5 – 40	+0.2 – -0.15

Centerhöjjustering – svarvning

Justermån för centrumhöjd

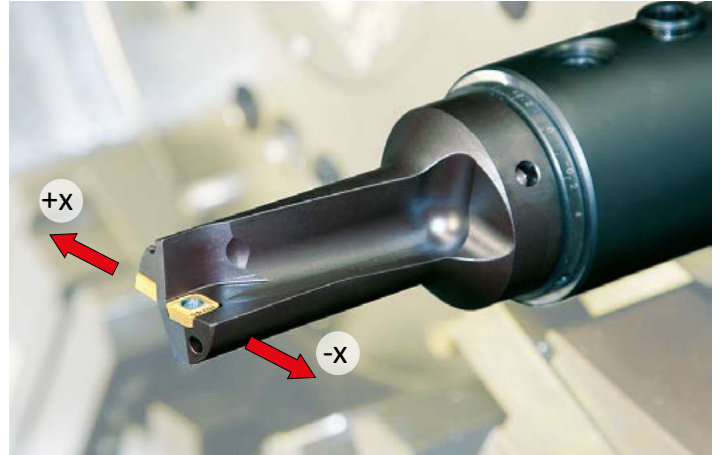

BEARBETNINGSDATA FÖR VÄNDSKÄRSBORRAR

Rekommenderat kylvätsketryck

Borrdiameter DC (mm)	Kylvätsketryck	
	Borrlängd	
	2.0 – 2.5 DC	3.0 – 5.0 DC
15 – 25	6 bar	12 bar
26 – 40	4.5 bar	9 bar
> 40	3 bar	6 bar

Volymbehov

BORRNING UTAN KYLVÄTSKA

Vid borrning i gjutjärn och stål bör tryckluft användas för kylning och spåntransport.

Effektförbrukning, netto

■ $f \Rightarrow = 0.18$
■ $f \Rightarrow = 0.12$
■ $f \Rightarrow = 0.08$

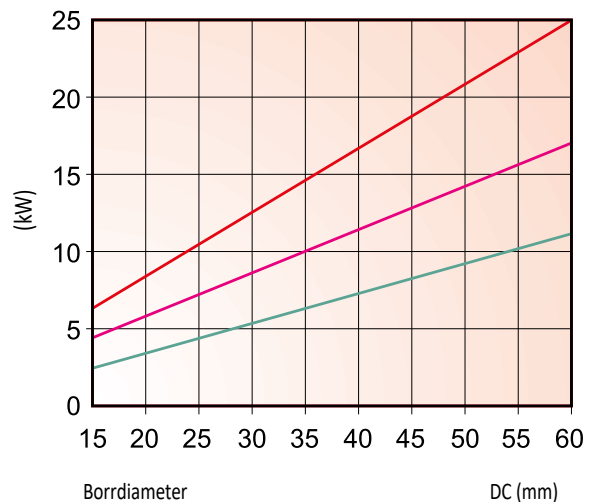
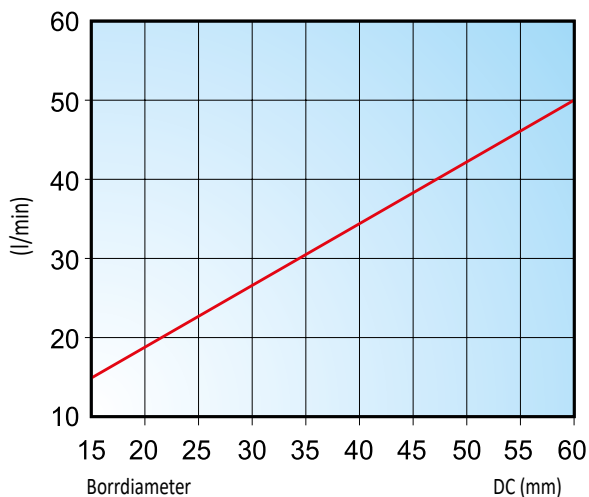

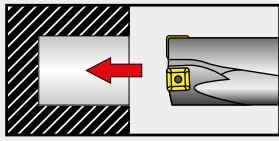
**BORRNING AV BOTTENHÅL**

För djupare hål än 1xD är kylning nödvändig.

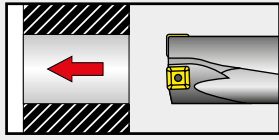
**BORRNING AV GENOMGÅENDE HÅL**

Det kan bildas en skiva som kan flyga iväg och göra skada när borret tränger ut. Se till att tillräckliga skydd finns i och runt maskinen.

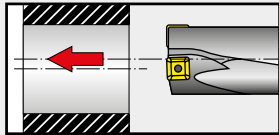
**BORRNING OFF-CENTER**

Minska matningen till det lägre rekommenderade värdet för skäret. Se skärdata för vändskärsborr. Överskrid inte värden för den radiella justeringen.

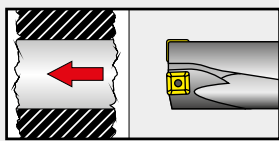
**BORRA I OJÄMNA YTOR**

Minska matningen med 50% vid ingången i materialet tills båda skären är i ingrepp.

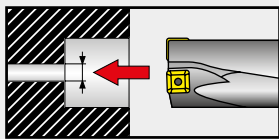
**UPPBORRNING OCH BORRNING I PILOTHÅL**

Om det förborrade hålet är större än 25% av borrhålets diameter, minska matningen.

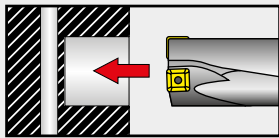
**BORRNING GENOM KORSANDE HÅL**

Minska matningen med 50% vid passering genom det korsande hålet. Det korsande hålet får inte vara större än 25% av borrhålets diameter.

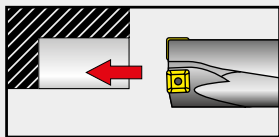
**OFULLSTÄNDIGT INGREPP OCH DYKNING**

Minska matningen till lägsta värdet för skäret. Se beskrivning för vändskärsborr.

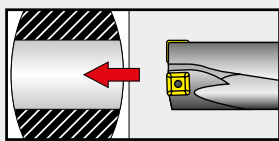
**BORRNING MOT VÄLVD YTA**

Borrning på centrumlinjen kan göras om matningen minskas med 50% under ingång och utgång ur materialet.

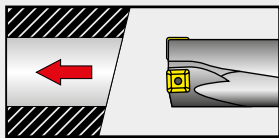
**BORRNING MOT VINKLAD YTA**

Minska matningen med 50% tills hela borret är i ingrepp om ytan är vinklad mer än 5°.

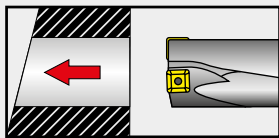
**UTGÅNG GENOM VINKLAD YTA**

Minska matningen med 50% vid utgången om ytan är vinklad mer än 5°.

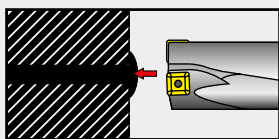
**BÖRJA BORRA GENOM SVETSSÖM**

Sömen bör planfråsas före borrning.
Minska matning med 50% vid borrning i svetszonen.

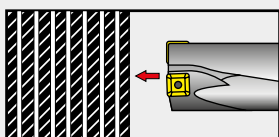
**DRILLING OF STACKED MATERIALS**

Avoid spaces larger than 0.2 mm between layers. The component must be securely fixed. If necessary reduce the feed.

INDEXABLE DRILLS – RECOMMENDED CUTTING CONDITIONS

802D, 803D (XPET..AP, SCET..-UD)



	D9335	D8330	D8345	∅ 15	∅ 20	∅ 25	∅ 30	∅ 40	∅ 58
P1	■	■	■	0.07	0.08	0.09	0.10	0.12	0.16
P2	■	■	■	0.11	0.13	0.15	0.17	0.21	0.28
P3	■	■	■	0.13	0.15	0.18	0.20	0.24	0.32
P4	■	■	■	0.12	0.14	0.16	0.18	0.22	0.30
K1	■	■	■	0.14	0.16	0.19	0.21	0.26	0.34
K2	■	■	■	0.14	0.16	0.19	0.21	0.26	0.34
K3	■	■	■	0.14	0.16	0.19	0.21	0.26	0.34
K4	■	■	■	0.14	0.16	0.19	0.21	0.26	0.34
K5	■	■	■	0.14	0.16	0.19	0.21	0.26	0.34

802D, 803D (XPET..AP-SD, SCET..-SD)



	D9335	D8330	D8345	∅ 15	∅ 20	∅ 25	∅ 30	∅ 40	∅ 58
P1	■	■	■	0.08	0.09	0.10	0.11	0.14	0.18
P2	■	■	■	0.11	0.13	0.15	0.17	0.21	0.28
P3	■	■	■	0.13	0.15	0.18	0.20	0.24	0.32
P4	■	■	■	–	–	–	–	–	–
K1	▣	▣	▣	0.08	0.09	0.10	0.11	0.14	0.18
K2	▣	▣	▣	0.11	0.13	0.15	0.17	0.21	0.28
K3	▣	▣	▣	0.12	0.14	0.16	0.18	0.22	0.24
K4	▣	▣	▣	0.13	0.15	0.18	0.20	0.24	0.32
K5	▣	▣	▣	0.14	0.16	0.19	0.21	0.25	0.33
M1	■	■	■	0.12	0.14	0.16	0.18	0.22	0.30
M2	■	■	■	0.11	0.13	0.15	0.17	0.21	0.28
M3	■	■	■	0.07	0.08	0.09	0.10	0.12	0.16
M4	■	■	■	0.07	0.08	0.09	0.10	0.12	0.16
S1	▣	▣	▣	0.08	0.09	0.10	0.11	0.14	0.18
S2	▣	▣	▣	0.08	0.09	0.10	0.11	0.14	0.18
S3	▣	▣	▣	0.07	0.08	0.09	0.10	0.12	0.16
S4	▣	▣	▣	0.07	0.08	0.09	0.10	0.12	0.16

804D (XPET..AP, SCET..-UD)



	D9335	D8330	D8345	∅ 15	∅ 20	∅ 25	∅ 30	∅ 40	∅ 58
P1	■	■	■	0.06	0.07	0.08	0.09	0.10	0.14
P2	■	■	■	0.10	0.12	0.14	0.16	0.19	0.25
P3	■	■	■	0.12	0.14	0.16	0.18	0.22	0.30
P4	■	■	■	0.11	0.13	0.15	0.17	0.21	0.28
K1	■	■	■	0.13	0.15	0.18	0.20	0.24	0.32
K2	■	■	■	0.13	0.15	0.18	0.20	0.24	0.32
K3	■	■	■	0.13	0.15	0.18	0.20	0.24	0.32
K4	■	■	■	0.13	0.15	0.18	0.20	0.24	0.32
K5	■	■	■	0.13	0.15	0.18	0.20	0.24	0.32



INDEXABLE DRILLS – RECOMMENDED CUTTING CONDITIONS

804D (XPET..AP-SD, SCET..-SD)



	D9335	D8330	D8345	∅ 15	∅ 20	∅ 25	∅ 30	∅ 40	∅ 58
P1	■	■	■	0.07	0.08	0.09	0.10	0.12	0.16
P2	■	■	■	0.10	0.12	0.14	0.16	0.19	0.25
P3	■	■	■	0.12	0.14	0.16	0.18	0.22	0.30
P4	■	■	■	–	–	–	–	–	–
K1	▣	▣	▣	0.07	0.08	0.09	0.10	0.12	0.16
K2	▣	▣	▣	0.10	0.12	0.14	0.16	0.19	0.25
K3	▣	▣	▣	0.11	0.13	0.15	0.17	0.20	0.27
K4	▣	▣	▣	0.12	0.14	0.16	0.18	0.22	0.30
K5	▣	▣	▣	0.14	0.16	0.19	0.21	0.25	0.33
M1	■	■	■	0.11	0.13	0.15	0.17	0.21	0.28
M2	■	■	■	0.10	0.12	0.14	0.16	0.19	0.25
M3	■	■	■	0.06	0.07	0.08	0.09	0.10	0.14
M4	■	■	■	0.06	0.07	0.08	0.09	0.10	0.14
S1	▣	▣	▣	0.07	0.08	0.09	0.10	0.12	0.16
S2	▣	▣	▣	0.07	0.08	0.09	0.10	0.12	0.16
S3	▣	▣	▣	0.06	0.07	0.08	0.09	0.10	0.14
S4	▣	▣	▣	0.06	0.07	0.08	0.09	0.10	0.14

805D (XPET..AP, SCET..-UD)



	D9335	D8330	D8345	∅ 15	∅ 20	∅ 25	∅ 30	∅ 40	∅ 58
P1	■	■	■	0.06	0.07	0.08	0.09	0.10	0.14
P2	■	■	■	0.10	0.12	0.14	0.16	0.19	0.25
P3	■	■	■	0.12	0.14	0.16	0.18	0.22	0.30
P4	■	■	■	0.11	0.13	0.15	0.17	0.21	0.28
K1	■	■	■	0.13	0.15	0.18	0.20	0.24	0.32
K2	■	■	■	0.13	0.15	0.18	0.20	0.24	0.32
K3	■	■	■	0.13	0.15	0.18	0.20	0.24	0.32
K4	■	■	■	0.13	0.15	0.18	0.20	0.24	0.32
K5	■	■	■	0.13	0.15	0.18	0.20	0.24	0.32

805D (XPET..AP-SD, SCET..-SD)



	D9335	D8330	D8345	∅ 15	∅ 20	∅ 25	∅ 30	∅ 40	∅ 58
P1	■	■	■	0.07	0.08	0.09	0.10	0.12	0.16
P2	■	■	■	0.10	0.12	0.14	0.16	0.19	0.25
P3	■	■	■	0.12	0.14	0.16	0.18	0.22	0.30
P4	■	■	■	–	–	–	–	–	–
K1	▣	▣	▣	0.07	0.08	0.09	0.10	0.12	0.16
K2	▣	▣	▣	0.10	0.12	0.14	0.16	0.19	0.25
K3	▣	▣	▣	0.11	0.13	0.15	0.17	0.20	0.27
K4	▣	▣	▣	0.12	0.14	0.16	0.18	0.22	0.30
K5	▣	▣	▣	0.12	0.14	0.16	0.18	0.22	0.30
M1	■	■	■	0.11	0.13	0.15	0.17	0.21	0.28
M2	■	■	■	0.10	0.12	0.14	0.16	0.19	0.25
M3	■	■	■	0.06	0.07	0.08	0.09	0.10	0.14
M4	■	■	■	0.06	0.07	0.08	0.09	0.10	0.14
S1	▣	▣	▣	0.07	0.08	0.09	0.10	0.12	0.16
S2	▣	▣	▣	0.07	0.08	0.09	0.10	0.12	0.16
S3	▣	▣	▣	0.06	0.07	0.08	0.09	0.10	0.14
S4	▣	▣	▣	0.06	0.07	0.08	0.09	0.10	0.14

FORMLER FÖR BERÄKNING AV SKÄRDATA

NOMENKLATUR OCH FORMLER

Parameter	Formel	Enhet
RPM	$n = \frac{v_c \cdot 1000}{DC \cdot \pi}$	(varv/min)
Skärhastighet	$v_c = \frac{\pi \cdot DC \cdot n}{1000}$	(m/min)
Bordmatning	$v_f = n \cdot f$	(mm/min)
Snittarea	$A = \frac{\pi \cdot DC^2}{4}$	(mm ²)
Avverkningsgrad	$Q = \frac{v_f \cdot A}{1000}$	(cm ³ /min)
Maskintid	$T_c = \frac{L + h}{v_f}$	(min/styck)

DC Borrdiameter

(mm)

h Avstånd mellan borrarpspets och arbetsstycke

(mm)

f Matning per varv

(mm/varv)

L Håldjup

(mm)

REKOMMENDERADE ÅTDRAGNINGSMOMENT FÖR SKRUVAR

	Nm					
US 2245-T07P	0.9	FLAG T07P	M 2.2	5.3	D-T7P	MR-0.8-2.0 vario
US 2205-T07P	0.9	FLAG T07P	M2.2	5.4	D-T7P	MR-0.8-2.0 vario
US 2506-T07P	1.2	FLAG T07P	M 2.5	6	D-T7P	MR-0.8-2.0 vario
US 2507-T08P	1.2	FLAG T08P	M 2.5	7	D-T8P	MR-0.8-2.0 vario
US 3007-T08P	2.0	FLAG T08P	M 3	7	D-T8P	MR-1.0-5.0 vario
US 3007-T09P	2.0	FLAG T09P	M 3	7.4	D-T9P	MR-1.0-5.0 vario
US 3009-T09P	2.0	FLAG T09P	M 3	8.7	D-T9P	MR-1.0-5.0 vario
US 3508-T15P	3.0	FLAG T15P	M 3.5	8.3	D-T15P	MR-1.0-5.0 vario
US 3510-T15P	3.0	FLAG T15P	M 3.5	10.6	D-T15P	MR-1.0-5.0 vario
US 4011-T15P	3.5	FLAG T15P	M 4	10.7	D-T15P	MR-1.0-5.0 vario
US 5012-T15P	5.0	FLAG T15P	M 5	12.2	D-T15P	MR-1.0-5.0 vario



WMG (WORK MATERIALGRUPP)

ISO group	WMG (Work Materialgrupp)	Hardness (HB or HRC)	Ultimate Tensile Strength (MPa)		
P	P1.1	Svavlat	< 240 HB	≤ 830	
	P1.2	Olegerat stål med hög skärbarhet, automatstål och lågkolhaltigt stål	Svavlat och fosforiserat	< 180 HB	≤ 620
	P1.3		Svavlat/fosforiserat och blyat	< 180 HB	≤ 620
	P2.1	Olegerat kolstål	Innehåller <0.25%C	< 180 HB	≤ 620
	P2.2	(stål innehållande främst järn och kol)	Innehåller <0.55%C	< 240 HB	≤ 830
	P2.3		Innehåller >0.55%C	< 300 HB	≤ 1030
	P3.1	Legerat stål	Anlöpt	< 180 HB	≤ 620
	P3.2	(kolstål med legeringsinnehåll ≤10%)	Härdat och anlöpt	180 – 260 HB	> 620 ≤ 900
	P3.3			260 – 360 HB	> 900 ≤ 1240
	P4.1	Verktogsstål	Anlöpt	< 26 HRC	≤ 900
P4.2	(Legeringar för verktyg, formverktyg, mm)	Härdat och anlöpt	26 – 39 HRC	> 900 ≤ 1240	
P4.3			39 – 45 HRC	> 1240 ≤ 1450	
M	M1.1	Ferritiskt rostfritt stål	< 160 HB	≤ 520	
	M1.2	kromlegerat, icke härdbart	160 – 220 HB	> 520 ≤ 700	
	M2.1	Martensitiskt rostfritt stål	Anlöpt	< 200 HB	≤ 670
	M2.2	(kromlegerat, härdbart)	Släckt och anlöpt	200 – 280 HB	> 670 ≤ 950
	M2.3		Utskiljningshärdat	280 – 380 HB	> 950 ≤ 1300
	M3.1	Austenitiskt rostfritt stål	< 200 HB	≤ 750	
	M3.2	(kromnickel och krom-nickel-manganlegeringar)	200 – 260 HB	> 750 ≤ 870	
	M3.3		260 – 300 HB	> 870 ≤ 1040	
	M4.1	Austenit-ferritiskt (DUPLEX) eller austenitiskt rostfritt stål	< 300 HB	≤ 990	
	M4.2	Utskiljningshärdat, austenitiskt rostfritt stål	300 – 380 HB	≤ 1320	
K	K1.1	Gråjärn (ASTM A48) eller Automotiv-gråjärn (ASTM A159)	Ferritiskt eller ferrit-perlitiskt	< 180 HB	≤ 190
	K1.2	(järn-kol gjöt med lamellära grafitmikrostruktur)	Ferrit-perlitiskt eller perlitiskt	180 – 240 HB	> 190 ≤ 310
	K1.3		Perlitiskt	240 – 280 HB	> 310 ≤ 390
	K2.1	Smidbart gjutjärn (ASTM A602)	Ferritiskt	< 160 HB	≤ 400
	K2.2	(järn-kol gjöt med grafitfri mikrostruktur)	Ferritiskt eller perlitiskt	160 – 200 HB	> 400 ≤ 550
	K2.3		Perlitiskt	200 – 240 HB	> 550 ≤ 660
	K3.1	Formbart järn (ASTM A536)	Ferritiskt	< 180 HB	≤ 560
	K3.2	(järn-kol gjöt med en nodulär grafitmikrostruktur)	Ferritiskt eller perlitiskt	180 – 220 HB	> 560 ≤ 680
	K3.3		Ferritiskt	220 – 260 HB	> 680 ≤ 800
	K4.1	Austenitiskt gråjärn (ASTM A436)		< 180 HB	≤ 190
K4.2	(järn-kol gjöt med en austenitisk, lamellära grafitmikrostruktur)		< 240 HB	≤ 740	
K4.3	Austenitiskt smidbart järn (ASTM A439 eller A571)		< 280 HB	> 840 ≤ 980	
K4.4	(järn-kol gjöt med en austenitisk nodulär grafitmikrostruktur)		280 – 320 HB	> 980 ≤ 1130	
K4.5	Värmebehandlat smide (ASTM A897)		320 – 360 HB	> 1130 ≤ 1280	
K5.1	Kompaktgrafitjärn CGI (ASTM A842)	Ferritiskt	< 180 HB	≤ 400	
K5.2	(järn-kol gjöt med en vermiculär grafitstruktur)	Ferritiskt eller perlitiskt	180 – 220 HB	> 400 ≤ 450	
K5.3		Ferritiskt	220 – 260 HB	> 450 ≤ 500	
N	N1.1	Smidd aluminium, handelskvalitet	< 60 HB	≤ 240	
	N1.2		Halvhärda	60 – 100 HB	> 240 ≤ 400
	N1.3	Smidda Al-legeringar	Härda	100 – 150 HB	> 400 ≤ 590
	N2.1			< 75 HB	≤ 240
	N2.2	Gjutna Al-legeringar		75 – 90 HB	> 240 ≤ 270
	N2.3			90 – 140 HB	> 270 ≤ 440
	N3.1	Renkoppar och kopparlegeringar, lättbearbetade		–	–
	N3.2	Kortspånande kopparlegeringar, mässing		–	–
	N3.3	Elektrolytkoppar och långspånande kopparlegeringar, svårbearbetade		–	–
	N4.1	Termoplast		–	–
N4.2	Hårdplast		–	–	
N4.3	Armerade plaster eller kompositer		–	–	
N5.1	Grafit		–	–	
S	S1.1	Titan och titanlegeringar	< 200 HB	≤ 660	
	S1.2		200 – 280 HB	> 660 ≤ 950	
	S1.3		280 – 360 HB	> 950 ≤ 1200	
	S2.1	Fe-baserade varmhållfasta legeringar	< 200 HB	≤ 690	
	S2.2		200 – 280 HB	> 690 ≤ 970	
	S3.1	Ni-baserade varmhållfasta legeringar	< 280 HB	≤ 940	
	S3.2		280 – 360 HB	> 940 ≤ 1200	
	S4.1	Co-baserade varmhållfasta legeringar	< 240 HB	≤ 800	
S4.2		240 – 320 HB	> 800 ≤ 1070		
H	H1.1	Segjärn	< 440 HB	–	
	H2.1	Härdat gjutjärn	< 55 HRC	–	
	H2.2		> 55 HRC	–	
	H3.1	Härdat stål <55HRC	< 51 HRC	–	
	H3.2		51 – 55 HRC	–	
	H4.1	Härdat stål >55HRC	55 – 59 HRC	–	
H4.2		> 59 HRC	–		



OMVANDLINGSTABELL FÖR HÅRDHET

Styrka (MPa)	Hårdhet			
	BRINELL	VICKERS	ROCKWELL	ROCKWELL
R _m	HB	HV	HRB	HRC
285	86	90	1190	–
320	95	100	56.2	–
350	105	110	62.3	–
385	114	120	66.7	–
415	124	130	71.2	–
450	133	140	75.0	–
480	143	150	78.7	–
510	152	160	81.7	–
545	162	170	85.8	–
575	171	180	87.1	–
610	181	190	89.5	–
640	190	200	91.5	–
675	199	210	93.5	–
705	209	220	95	–
740	219	230	96.7	–
770	228	240	98.1	–
800	238	250	99.5	–
820	242	255	–	23.1
850	252	265	–	24.8
880	261	275	–	26.4
900	266	280	–	27.1
930	276	290	–	28.5
950	280	295	–	29.2
995	295	310	–	31.0
1030	304	320	–	32.2
1060	314	330	–	33.3
1095	323	340	–	34.4
1125	333	350	–	35.5
1155	342	360	–	36.6

Styrka (MPa)	Hårdhet			
	BRINELL	VICKERS	ROCKWELL	ROCKWELL
R _m	HB	HV	HRB	HRC
1190	352	370	–	37.7
1220	361	380	–	38.8
1255	371	390	–	39.8
1290	380	400	–	40.8
1320	390	410	–	41.8
1350	399	420	–	42.7
1385	409	430	–	43.6
1420	418	440	–	44.5
1455	428	450	–	45.3
1485	437	460	–	46.1
1520	447	470	–	46.9
1555	456	480	–	47.7
1595	466	490	–	48.4
1630	475	500	–	49.1
1665	485	510	–	49.8
1700	494	520	–	50.5
1740	504	530	–	51.1
1775	513	540	–	51.7
1810	523	550	–	52.3
1845	532	560	–	53.0
1880	542	570	–	53.6
1920	551	580	–	54.1
1955	561	590	–	54.7
1995	570	600	–	55.2
2030	580	610	–	55.7
2070	589	620	–	56.3
2105	599	630	–	56.8
2145	608	640	–	57.3
2180	618	650	–	57.8

SIMPLY RELIABLE

Som yrkesman kan du bedöma kvaliteten på ett arbete enbart genom att studera spånan. Spånan har en ren och okomplicerad form som berättar en historia. Det är därför vi använder denna symbol för att illustrera vår pålitlighet, "Simply reliable".



DORMER PRAMET

www.dormerpramet.com



**KONTAKTA DIN LOKALA
KUNDSUPPORT.
ALLTID UPPDATERAD!**



DP-CAT-HOLEMAKING-2024-SE

FOLLOW US...



ONLINE



SEGMENTS



LIBRARY APP.



CALCULATOR APP.